

# Dell™ C1760nw/C1660w Color Printer

## User's Guide

Regulatory Model: Dell C1760nw/Dell C1660w





# Contents

Before Beginning . . . . .	11
A Notes, Cautions, and Warnings . . . . .	13
1 Dell™ C1760nw/C1660w Color Printer User's Guide . . . . .	15
Conventions. . . . .	15
2 Finding Information . . . . .	17
3 Product Features . . . . .	19
4 About the Printer . . . . .	21
Front View . . . . .	21
Rear View. . . . .	22
Space Requirements . . . . .	23
Operator Panel . . . . .	23
Securing the Printer . . . . .	24
Ordering Supplies . . . . .	25
Printer Setup . . . . .	27
5 Connecting Your Printer. . . . .	29
Connecting Printer to Computer or Network . . . . .	29
Direct Connection . . . . .	29
Wireless Connection . . . . .	30
Ethernet Connection (Dell C1760nw Color Printer only) . . . . .	34
Reconfiguring the Wireless Setting . . . . .	35

<b>Turning On the Printer</b> . . . . .	36
<b>6 Setting Up Your Printer</b> . . . . .	37
<b>Setting Initial Settings on the Operator Panel (Dell™ C1660w Color Printer Only)</b> . . . . .	37
<b>Printer Setup Using the Software and Documentation Disc</b> . . . . .	38
<b>7 Setting the IP Address</b> . . . . .	39
<b>Assigning an IP Address</b> . . . . .	39
The Operator Panel . . . . .	39
The Tool Box . . . . .	40
<b>Verifying the IP Settings</b> . . . . .	41
The Operator Panel . . . . .	41
The System Settings Report . . . . .	41
The Ping Command . . . . .	41
<b>8 Loading Paper</b> . . . . .	43
<b>Loading Print Media in the Multipurpose Feeder (MPF)</b> . . . . .	43
<b>Loading Print Media in the Priority Sheet Inserter (PSI) (Dell C1760nw Color Printer only)</b> . . . . .	48
<b>9 Installing Printer Drivers on Computers Running Windows®</b> . . . . .	51
<b>Identifying Printer Driver Pre-install Status</b> . . . . .	51
Changing the firewall settings before installing your printer . . . . .	51
<b>Direct Connection Setup</b> . . . . .	51
For installing host-based printer driver . . . . .	51
For installing XML Paper Specification (XPS) printer driver . . . . .	52
<b>Network Connection Setup</b> . . . . .	54
Network Printer Setup on a Local Network . . . . .	54
Network Printer Setup on a Remote Network . . . . .	58
<b>Setting Up for Web Services on Devices (WSD)</b> . . . . .	62
Adding Roles of Print Services . . . . .	62
WSD Printer Setup . . . . .	63
<b>Setting Up for Shared Printing</b> . . . . .	64

Point and Print . . . . .	66
Peer-to-Peer . . . . .	68
<b>10 Installing Printer Drivers on Computers Running Macintosh</b> .....	<b>71</b>
<b>Installing the Drivers and Software</b> . . . . .	<b>71</b>
Adding a Printer on Mac OS X 10.5 or Later Version(s) . . . . .	71
Adding a Printer on Mac OS X 10.4.11 . . . . .	72
 <b>Using Your Printer</b> . . . . .	 <b>75</b>
 <b>11 Operator Panel</b> . . . . .	 <b>77</b>
<b>Using the Operator Panel Buttons</b> . . . . .	<b>77</b>
Status of Wi-Fi   WPS Button Backlight . . . . .	78
<b>Using the Operator Panel to Change Printer Settings</b> . . . . .	<b>79</b>
<b>Printing a Device Settings Page</b> . . . . .	<b>79</b>
<b>Changing the Language</b> . . . . .	<b>80</b>
The Operator Panel . . . . .	80
The Tool Box . . . . .	80
<b>Setting the PowerSaver Time Option</b> . . . . .	<b>80</b>
 <b>12 Dell™ Printer Configuration Web Tool</b> . . . . .	 <b>81</b>
<b>Overview</b> . . . . .	<b>81</b>
<b>Setting Up the Dell Printer Configuration Web Tool</b> . . . . .	<b>81</b>
Setting Up From Web Browser . . . . .	81
Setting Up From Operator Panel . . . . .	83
<b>Starting the Dell Printer Configuration Web Tool</b> . . . . .	<b>83</b>
<b>Overview of the Menu Items</b> . . . . .	<b>83</b>
<b>Page Display Format</b> . . . . .	<b>85</b>
Top Frame . . . . .	85
Left Frame . . . . .	86
Right Frame . . . . .	87
<b>Changing the Settings of the Menu Items</b> . . . . .	<b>88</b>
Details of the Menu Items . . . . .	88

Printer Status . . . . .	89
Printer Jobs . . . . .	90
Printer Settings . . . . .	91
Print Server Settings. . . . .	98
Copy Printer Settings . . . . .	110
Print Volume . . . . .	110
<b>13 Understanding the Tool Box Menus . . . . .</b>	<b>111</b>
<b>Starting the Tool Box . . . . .</b>	<b>111</b>
<b>Using the Tool Box to Change the Printer Settings . . . . .</b>	<b>111</b>
<b>Printer Settings Report . . . . .</b>	<b>112</b>
Printer Information. . . . .	112
Menu Settings . . . . .	112
Reports. . . . .	114
TCP/IP Settings . . . . .	114
<b>Printer Maintenance . . . . .</b>	<b>114</b>
System Settings . . . . .	114
Paper Density . . . . .	116
Adjust BTR . . . . .	116
Adjust Fusing Unit . . . . .	117
Color Registration Adjustment. . . . .	117
Adjust Altitude . . . . .	118
Reset Defaults . . . . .	119
Non-Dell Toner. . . . .	119
BTR Refresh Mode. . . . .	119
TCP/IP Settings . . . . .	120
Network Settings . . . . .	120
<b>Diagnosis . . . . .</b>	<b>121</b>
Chart Print . . . . .	121
Machine Check . . . . .	121
Environment Sensor Info . . . . .	122
Developer Stir Mode. . . . .	122
Refresh Mode . . . . .	122
<b>Resetting Defaults . . . . .</b>	<b>123</b>
<b>14 Understanding the Printer Menus . . . . .</b>	<b>125</b>
<b>Report/List. . . . .</b>	<b>125</b>
Printer Setting . . . . .	125
Device Settings . . . . .	125

Job History . . . . .	125
Error History . . . . .	125
Color Test Page . . . . .	125
Printing a Report/List Using the Operator Panel . . . . .	125
Printing a Report/List Using the Tool Box . . . . .	126
<b>Admin Menu . . . . .</b>	<b>126</b>
Network . . . . .	126
USB Settings . . . . .	131
System Settings . . . . .	131
Maintenance . . . . .	133
Secure Settings . . . . .	138
<b>Panel Language. . . . .</b>	<b>140</b>
<b>Panel Lock Function . . . . .</b>	<b>140</b>
Enabling the Panel Lock. . . . .	140
Disabling the Panel Lock . . . . .	140
<b>Resetting Defaults . . . . .</b>	<b>141</b>
<b>15 Print Media Guidelines . . . . .</b>	<b>143</b>
<b>Paper . . . . .</b>	<b>143</b>
Paper Characteristics . . . . .	143
Recommended Paper . . . . .	144
Unacceptable Paper . . . . .	144
Selecting Paper . . . . .	144
Selecting Preprinted Media and Letterhead . . . . .	145
Printing on Letterhead. . . . .	145
Loading Letterhead . . . . .	145
Selecting Pre-Punched Paper . . . . .	146
<b>Envelopes. . . . .</b>	<b>146</b>
<b>Labels. . . . .</b>	<b>147</b>
<b>Storing Print Media. . . . .</b>	<b>147</b>
<b>Identifying Print Media and Specifications . . . . .</b>	<b>148</b>
Supported Paper Sizes . . . . .	148
Supported Paper Types . . . . .	149
Paper Type Specifications . . . . .	149
<b>16 Loading Print Media. . . . .</b>	<b>151</b>
<b>Capacity. . . . .</b>	<b>151</b>

<b>Print Media Dimensions</b> . . . . .	<b>151</b>
<b>Loading Print Media in the Multipurpose Feeder (MPF)</b> . . . . .	<b>151</b>
Loading Envelopes in the Multipurpose Feeder (MPF) . . . . .	156
Loading Letterhead . . . . .	158
<b>Loading Print Media in the Priority Sheet Inserter (PSI) (Dell C1760nw Color Printer only)</b> . . . . .	<b>159</b>
Loading an Envelope in the Priority Sheet Inserter (PSI) . . . . .	161
Loading Letterhead . . . . .	163
<b>Loading Print Media When Manual Duplex Printing</b> . . . . .	<b>164</b>
When Using the Multipurpose Feeder (MPF) . . . . .	164
When Using the Priority Sheet Inserter (PSI) (Dell C1760nw Color Printer only)	165
. . . . .	165
<b>Using the Output Tray Extension</b> . . . . .	<b>166</b>

**Printing . . . . . 167**

**17 Printing . . . . . 169**

<b>Tips for Successful Printing</b> . . . . .	<b>169</b>
Tips on Storing Print Media . . . . .	169
Avoiding Paper Jams . . . . .	169
<b>Sending a Job to Print</b> . . . . .	<b>169</b>
<b>Canceling a Print Job</b> . . . . .	<b>170</b>
Canceling From the Operator Panel . . . . .	170
Canceling a Job From the Computer Running Windows . . . . .	170
<b>Printing a Report Page</b> . . . . .	<b>170</b>

**Know Your Printer. . . . . 171**

**18 Understanding Your Printer Software . . . . . 173**

<b>Windows®</b> . . . . .	<b>173</b>
Printer Status Window. . . . .	173
Status Monitor Console . . . . .	173
Dell Supplies Management System . . . . .	173
Quick Launch Utility . . . . .	174
<b>Macintosh</b> . . . . .	<b>174</b>



Status Monitor Widget . . . . .	174
19 Understanding Printer Messages . . . . .	177
20 Specifications . . . . .	181
<b>Operating System Compatibility</b> . . . . .	181
<b>Power Supply</b> . . . . .	181
<b>Dimensions</b> . . . . .	181
<b>Memory</b> . . . . .	181
<b>Page Description Language (PDL)/Emulation, Operating System, and Interface</b> . . . . .	182
<b>MIB Compatibility</b> . . . . .	182
<b>Environment</b> . . . . .	182
<b>Cables</b> . . . . .	183
Maintaining Your Printer . . . . .	185
21 Maintaining Your Printer . . . . .	187
<b>Determining the Status of Supplies</b> . . . . .	187
<b>Conserving Supplies</b> . . . . .	187
<b>Storing Print Media</b> . . . . .	187
<b>Storing Consumables</b> . . . . .	188
<b>Replacing Toner Cartridges</b> . . . . .	188
Removing the Toner Cartridges . . . . .	188
Installing a Toner Cartridge . . . . .	190
<b>Cleaning Inside the Printer</b> . . . . .	192
<b>Cleaning the Color Toner Density (CTD) Sensor</b> . . . . .	195
<b>Adjusting Color Registration</b> . . . . .	196
Performing Auto Correct . . . . .	196
Printing the Color Registration Chart . . . . .	196
Determining Values . . . . .	197
Entering Values . . . . .	198

22 Clearing Jams . . . . .	201
<b>Avoiding Jams</b> . . . . .	201
<b>Identifying the Location of Paper Jams</b> . . . . .	202
<b>Clearing Paper Jams From the Front of the Printer</b> . . . . .	203
<b>Clearing Paper Jams From the Back of the Printer</b> . . . . .	204
<b>Clearing Paper Jams From the Output Tray</b> . . . . .	206
Troubleshooting . . . . .	209
23 Troubleshooting . . . . .	211
<b>Basic Printer Problems</b> . . . . .	211
<b>Display Problems</b> . . . . .	211
<b>Printing Problems</b> . . . . .	211
<b>Print Quality Problems</b> . . . . .	213
The output is too light . . . . .	213
Toner smears or print comes off/Stain on back side . . . . .	214
Random spots/Blurred images . . . . .	215
The entire output is blank . . . . .	215
Streaks appear on the output . . . . .	215
Pitched color dots . . . . .	216
Vertical blanks . . . . .	216
Mottle . . . . .	216
Ghosting . . . . .	217
Fog . . . . .	218
Bead-Carry-Out (BCO) . . . . .	218
Auger mark . . . . .	219
Wrinkled/Stained paper . . . . .	219
The top margins is incorrect . . . . .	220
Color registration is out of alignment . . . . .	220
Protrudent / Bumpy paper . . . . .	221
<b>Noise</b> . . . . .	222
<b>Jam</b> . . . . .	223
Misfeed jam . . . . .	223
Multi-feed jam . . . . .	224
<b>Wireless Problems</b> . . . . .	224

<b>Other Problems</b> . . . . .	<b>225</b>
<b>Contacting Service</b> . . . . .	<b>225</b>
<b>Appendix</b> . . . . .	<b>227</b>
<b>B Appendix</b> . . . . .	<b>229</b>
<b>Dell Technical Support Policy</b> . . . . .	<b>229</b>
Online Services . . . . .	229
<b>Warranty and Return Policy</b> . . . . .	<b>230</b>
Recycling Information . . . . .	230
<b>Contacting Dell</b> . . . . .	<b>230</b>
<b>Index</b> . . . . .	<b>231</b>



# Before Beginning

- Notes, Cautions, and Warnings ..... 13
- 1 Dell™ C1760nw/C1660w Color Printer User's Guide ..... 15
- 2 Finding Information ..... 17
- 3 Product Features ..... 19
- 4 About the Printer ..... 21



# Notes, Cautions, and Warnings



**NOTE:** A NOTE indicates important information that helps you make better use of your printer.



**CAUTION:** A CAUTION indicates either potential damage to hardware or loss of data and tells you how to avoid the problem.



**WARNING:** A WARNING indicates a potential for property damage, personal injury, or death.

Information in this document is subject to change without notice.

© 2012 Dell Inc. All rights reserved.

Reproduction of these materials in any manner whatsoever without the written permission of Dell Inc. is strictly forbidden.

Trademarks used in this text: *Dell* and the *DELL* logo are trademarks of Dell Inc.; *Microsoft*, *Windows*, *Windows Server*, *Windows Vista*, and *Internet Explorer* are either trademarks or registered trademarks of Microsoft Corporation in the United States and/or other countries. *Macintosh* and *Mac OS* are trademarks of Apple Inc., registered in the U.S. and other countries. *Wi-Fi* is a registered trademark of the Wi-Fi Alliance. *Wi-Fi Protected Setup*, *WPA*, and *WPA2* are trademarks of the Wi-Fi Alliance.

*XML Paper Specification (XPS)*: This product may incorporate intellectual property owned by Microsoft Corporation. The terms and conditions upon which Microsoft is licensing such intellectual property may be found at <http://go.microsoft.com/fwlink/?LinkId=52369>; *DES*: This product includes software developed by Eric Young ([eay@mincom.oz.au](mailto:eay@mincom.oz.au)); *AES*: Copyright © 2003, Dr Brian Gladman, Worcester, UK. All rights reserved. This product uses published AES software provided by Dr Brian Gladman under BSD licensing terms; *TIFF (libtiff)*: Copyright © 1988-1997 Sam Leffler and Copyright © 1991-1997 Silicon Graphics, Inc.; *ICC Profile (Little cms)*: Copyright © 1998-2004 Marti Maria.

Other trademarks and trade names may be used in this document to refer to either the entities claiming the marks and names or their products. Dell Inc. disclaims any proprietary interest in trademarks and trade names other than its own.

The printer software uses some of the codes defined by the Independent JPEG Group.

---

## UNITED STATES GOVERNMENT RESTRICTED RIGHTS

This software and documentation are provided with RESTRICTED RIGHTS. Use, duplication or disclosure by the Government is subject to restrictions as set forth in subparagraph (c)(1)(ii) of the Rights in Technical Data and Computer Software clause at DFARS 252.227-7013 and in applicable FAR provisions: Dell Inc., One Dell Way, Round Rock, Texas, 78682, USA.

November 2012 Rev. A00





# Dell™ C1760nw/C1660w Color Printer User's Guide

Click the links to the left for information on the features, options, and operation of your Dell C1760nw/C1660w Color Printer. For information on other documentation included with your Dell C1760nw/C1660w Color Printer, see "Finding Information" on page 17.

 **NOTE:** In this manual, Dell C1760nw/C1660w Color Printer is referred to as the "printer."

## Conventions



The following describe the meaning of the symbols and fonts used in this manual:

- |  |   |  |
|--|---|--|
| <b>Bold texts</b>                      | : | <ul style="list-style-type: none"> <li>• Names of hardware button on the operator panel.</li> <li>• Screen names on the LCD panel.</li> <li>• Menus, commands, windows, or dialog boxes displayed on the computer screen.</li> </ul> |
| Texts in <code>Courier New</code> font | : | <ul style="list-style-type: none"> <li>• Menus and messages displayed on the LCD panel.</li> <li>• Characters entered from the computer.</li> <li>• Directory paths.</li> </ul>  |
| < >                                    | : | <ul style="list-style-type: none"> <li>• Key on the keyboard of the computer.</li> </ul>   |
| →                                      | : | <ul style="list-style-type: none"> <li>• Indicates a path to a certain item within a procedure on a computer.</li> </ul>   |
| " "                                    | : | <ul style="list-style-type: none"> <li>• Cross references in this manual.</li> <li>• Characters entered from the operator panel.</li> <li>• Messages displayed on the computer screen.</li> </ul>                                    |

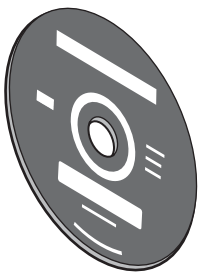
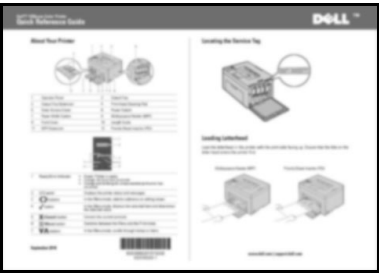

## Finding Information

 **NOTE:** The images used in this manual are those of the Dell™ C1760nw Color Printer unless otherwise mentioned.

What are you looking for?	Find it here
<ul style="list-style-type: none"> <li>• Drivers for my printer</li> <li>• My <i>User's Guide</i></li> </ul>	<p data-bbox="639 468 1435 499"><i>Software and Documentation</i> disc</p> <div data-bbox="639 520 836 793" data-label="Image">  </div> <p data-bbox="639 804 1435 898">The <i>Software and Documentation</i> disc contains setup video, documentation, and drivers for your printer. You can use the disc to install/re-install drivers or access your setup video and documentation.</p> <p data-bbox="639 919 1435 1014">Readme files may be included on your disc to provide last-minute updates about technical changes to your printer or advanced technical reference material for experienced users or technicians.</p>
<p data-bbox="175 1024 630 1056">How to use my printer</p>	<p data-bbox="639 1024 1435 1056"><i>Quick Reference Guide</i></p> <div data-bbox="639 1077 1015 1350" data-label="Image">  </div>
<ul style="list-style-type: none"> <li>• Safety information</li> <li>• Warranty information</li> </ul>	<p data-bbox="639 1360 1435 1392"><i>Important Information</i></p> <div data-bbox="639 1413 836 1686" data-label="Image">  </div> <p data-bbox="639 1696 1435 1751"><b>WARNING:</b> Read and follow all safety instructions in the <i>Important Information</i> prior to setting up and operating your printer.</p>

---

**What are you looking for?****Find it here**

How to set up my printer

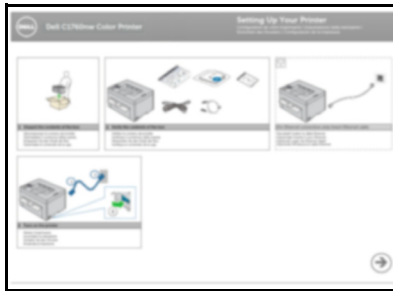
*Setup diagram*

Troubleshooting

"Troubleshooting" on page 211

Express Service Code and Service Tag

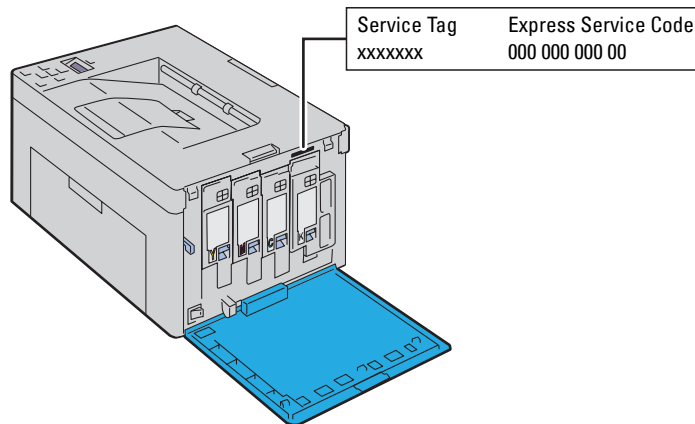

The Express Service Code and Service Tag are located inside the side door of your printer.

- 
- Latest drivers for my printer
  - Answers to technical service and support questions
  - Documentation for my printer

Go to [support.dell.com](http://support.dell.com)**support.dell.com** provides several online tools, including:

- Solutions — Troubleshooting hints and tips, articles from technicians, and online courses
- Upgrades — Upgrade information for components, such as printer driver
- Customer Care — Contact information, order status, warranty, and repair information
- Downloads — Drivers
- Manuals — Printer documentation and product specifications

Go to [support.dell.com](http://support.dell.com). Select your region, and fill in the requested details to access help tools and information.

---

## Product Features

This chapter describes the product features and indicates their links.

### 2-Sided Printing (Manual Duplex Print)

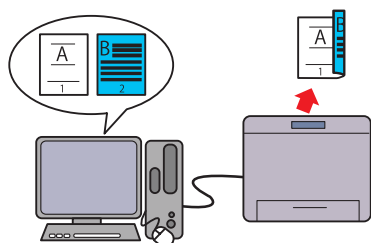

Manual Duplex Print is to print two or more pages on the front and back side of a single sheet of paper manually. This feature allows you to reduce the paper consumption. For more information, see "Loading Print Media When Manual Duplex Printing" on page 164.

### Priority Sheet Inserter (PSI) (Dell C1760nw Color Printer only)

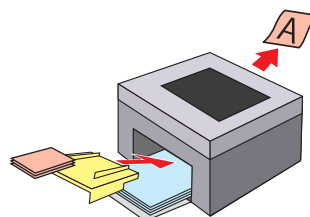

Print media loaded on the PSI are given precedence over those loaded on the Multipurpose Feeder (MPF). Using the PSI allows you to use other types or sizes of print media preferentially over the regular print media loaded on the MPF. For more information, see "Loading Print Media in the Priority Sheet Inserter (PSI) (Dell C1760nw Color Printer only)" on page 159.

### Printing through Wireless Connection (Wireless Print)

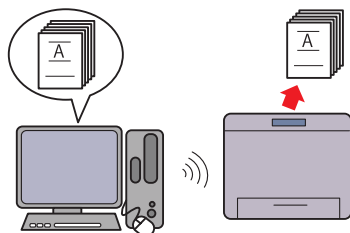

The Wireless LAN feature on your printer allows you to install the printer at any location, and enables printing without a wired connection to your computer. For more information, see "Wireless Connection" on page 30.

### Printing multiple pages on a single sheet of paper (Multiple Up)

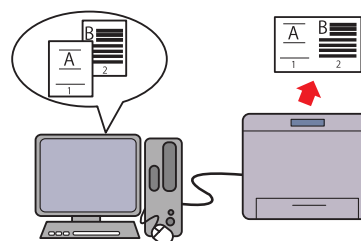

Multiple Up Print allows you to print multiple pages on a single sheet of paper. This feature allows you to reduce the paper consumption. For more information, see the printer driver's help.



## About the Printer

This chapter provides an overview of your Dell™ C1760nw/C1660w Color Printer.

 **NOTE:** The images used in this manual are those of the Dell C1760nw Color Printer unless otherwise mentioned.

### Front View

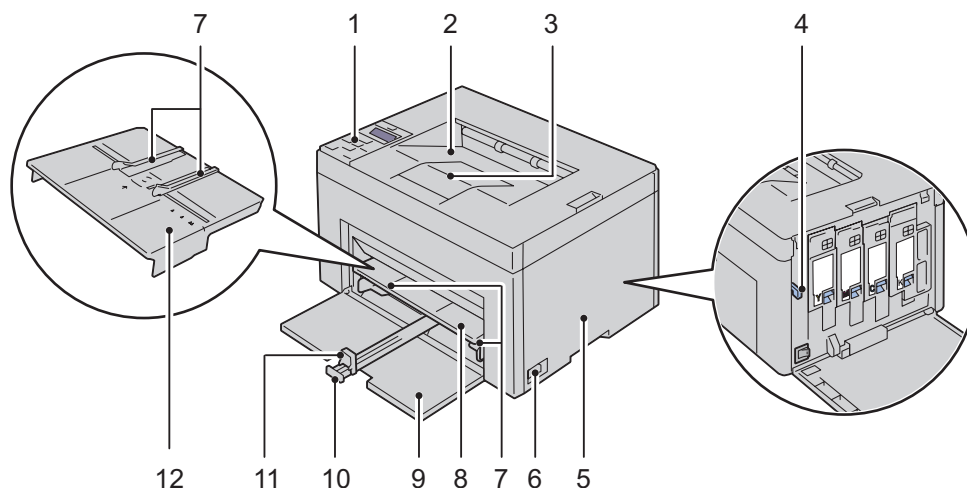

1	Operator Panel	2	Output Tray
3	Output Tray Extension	4	Print Head Cleaning Rod
5	Toner Access Cover	6	Power Switch
7	Paper Width Guides	8	Multipurpose Feeder (MPF)
9	Front Cover	10	MPF Extension
11	Length Guide	12	Priority Sheet Inserter (PSI) (Dell C1760nw Color Printer only)

## Rear View

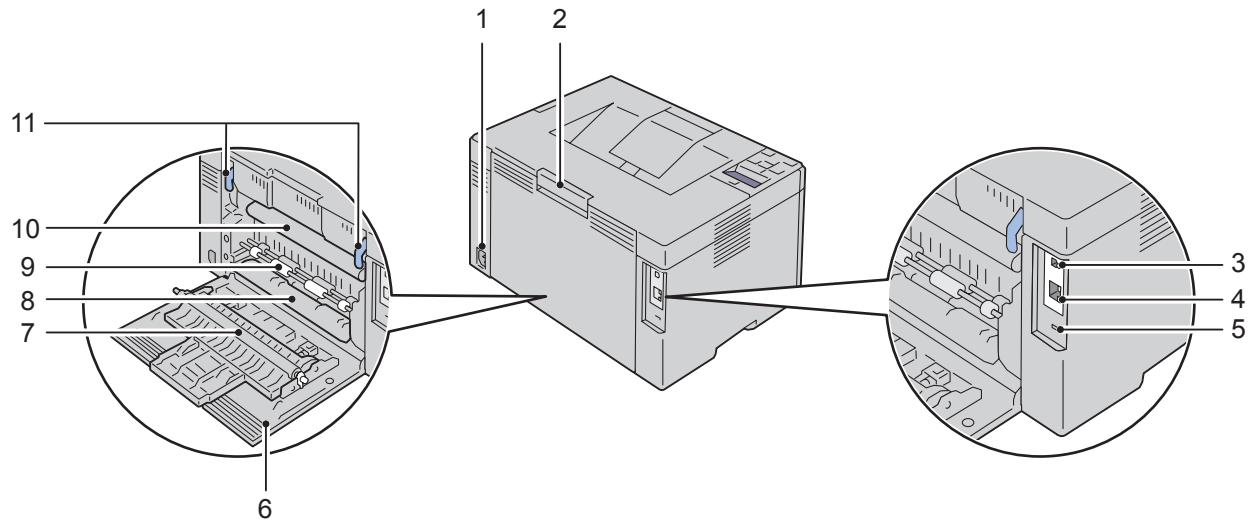

1	Power Connector	2	Rear Cover Release Handle
3	USB Port	4	Ethernet Port (Dell C1760nw Color Printer only)
5	Security Slot	6	Rear Cover
7	Transfer Roller	8	Paper Chute
9	Paper Feed Roller	10	Transfer Belt
11	Levers		



## Space Requirements

Place the printer at a location such that there is adequate space for using the printer feeder and covers.

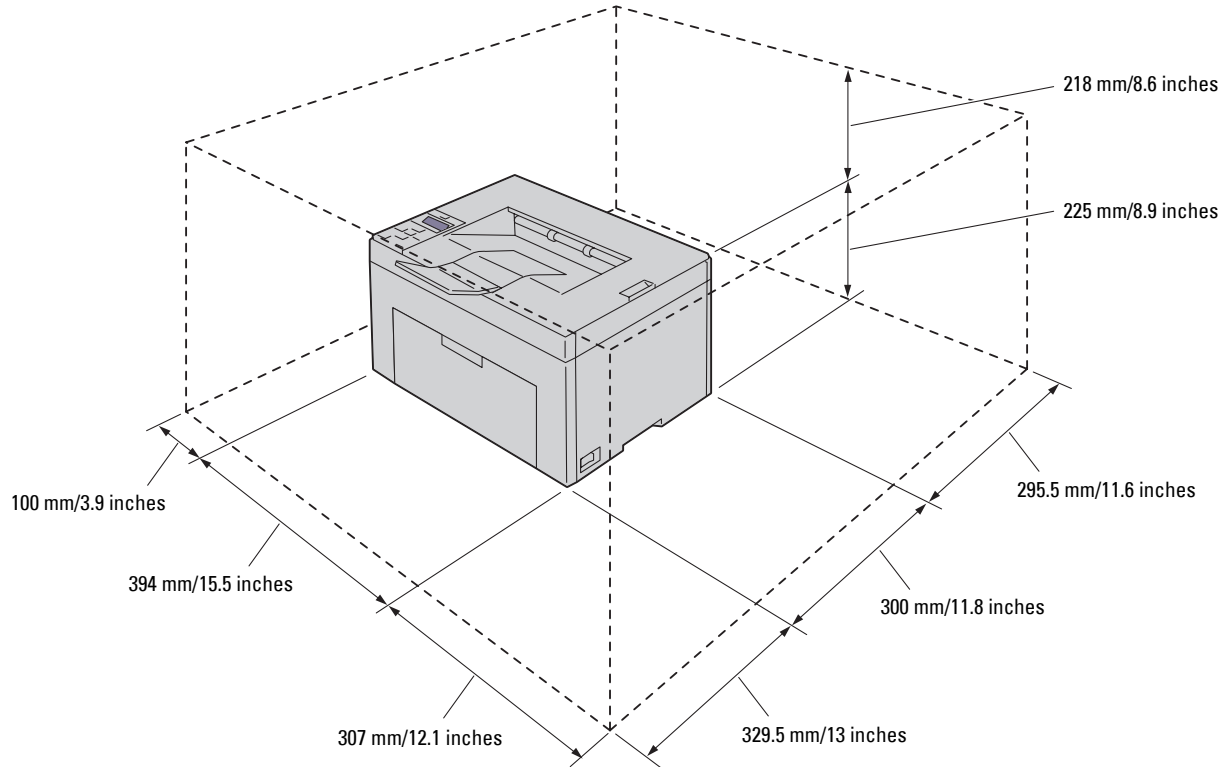

**CAUTION:** To avoid irregular screen image or malfunctioning of your printer, avoid placing the printer in direct sunlight with the front cover opened.

## Operator Panel



For more information on the operator panel, see "Operator Panel" on page 77.

## Securing the Printer

To protect your printer from theft, you can use the optional Kensington lock. Attach the Kensington lock to the security slot on your printer.

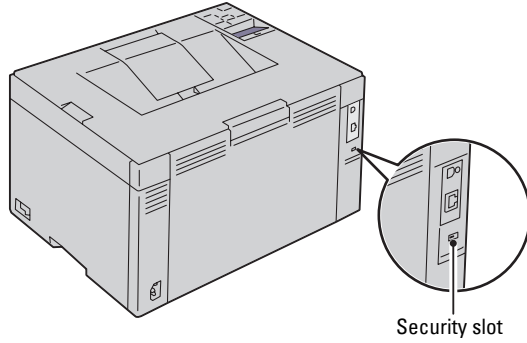

For details, see the operating instructions supplied with the Kensington lock.

## Ordering Supplies

You can order consumables from Dell on the Internet when using a networked printer. Enter the IP address of your printer in your web browser, launch the **Dell Printer Configuration Web Tool**, and click the **Order Supplies at:** to order toner for your printer.

You can also order toner cartridges by the following method:

- 1 Click **Start** → **All Programs** → **Dell Printers** → **Additional Color Laser Software** → **Dell Supplies Management System**.

The Dell Supplies Management System window appears.

- 2 Select your printer from the **Select Printer Model** list.

- 3 If ordering from the web:

- a Select a web address from the **Select Reorder URL** list.

- b Click the **Visit Dell Printer supplies ordering web site**.

The **Dell C1760nw Color Printer/Dell C1660w Color Printer - Dell Supplies Management System** screen appears.

- c Enter the Service Tag, and then click **OK**.

The Service Tag is located inside the toner access cover of your printer.

Dell supplies web site appears.

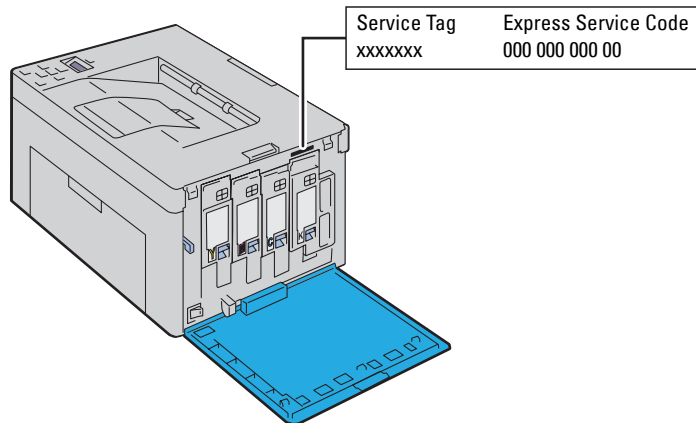

If you order by phone, call the number that appears in the **Order by Phone** section.



# Printer Setup

5	Connecting Your Printer .....	29
6	Setting Up Your Printer .....	37
7	Setting the IP Address .....	39
8	Loading Paper .....	43
9	Installing Printer Drivers on Computers Running Windows® .....	51
10	Installing Printer Drivers on Computers Running Macintosh .....	71



## Connecting Your Printer

Your Dell™ C1760nw/C1660w Color Printer interconnection cable must meet the following requirements:

Connection type	Connection specifications
USB	USB 2.0 compatible
Wireless	IEEE 802.11b/802.11g/802.11n
Ethernet	10 Base-T/100 Base-TX compatible (Dell C1760nw Color Printer only)

 **NOTE:** The images used in this manual are those of the Dell™ C1760nw Color Printer unless otherwise mentioned.

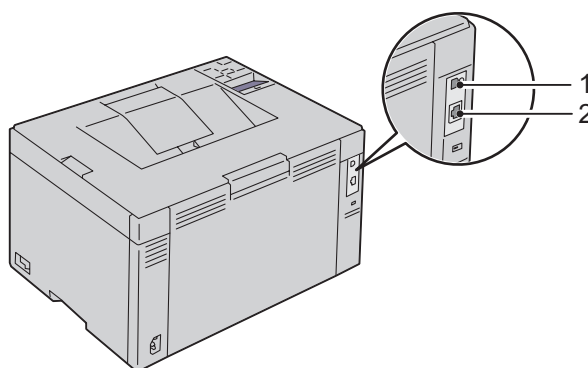

1 USB Port



2 Ethernet Port  
(Dell C1760nw Color Printer only)



## Connecting Printer to Computer or Network

### Direct Connection

A local printer is a printer attached to your computer using a USB cable. If your printer is attached to a network, go to "Ethernet Connection (Dell C1760nw Color Printer only)" on page 34.

To connect the printer to a computer:

- 1 Ensure that the printer, computer, and any other attached devices are turned off and unplugged from the power source/outlet.

- 2 Connect the smaller USB connector into the USB port at the back of the printer.

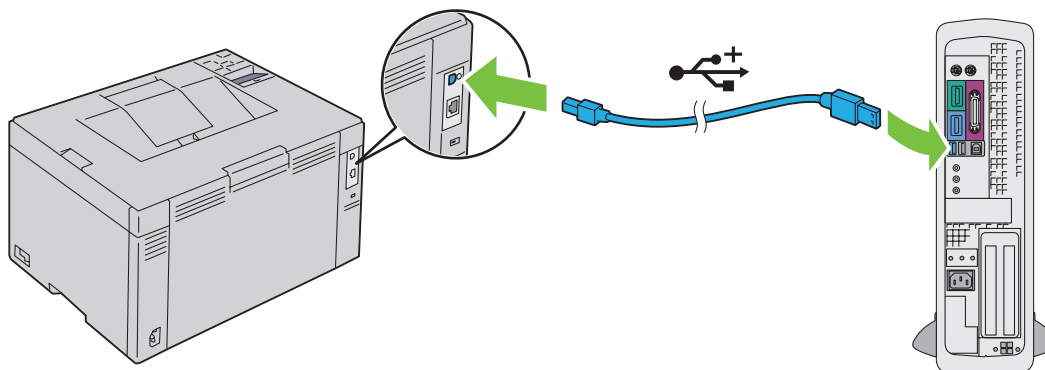

- 3 Connect the other end of the cable into a USB port of your computer.

**CAUTION:** Do not connect the printer USB cable to the USB port available on the keyboard.

## Wireless Connection

The specifications of wireless setting function are described below:

Item	Specification
Connectivity	Wireless
Connectivity Standard	IEEE 802.11b/802.11g/802.11n compliant
Bandwidth	2.4 GHz
Data Transfer Rate	IEEE 802.11b mode: 11, 5.5, 2, 1 Mbps IEEE 802.11g mode: 54, 48, 36, 24, 18, 12, 9, 6 Mbps IEEE 802.11n mode: 65 Mbps
Security	64 (40-bit key)/ 128 (104-bit key) WEP, WPA-PSK (TKIP, AES), WPA2-PSK (AES)(IEEE 802.1x attestation function of WPA 1x non-corresponds), Mixed Mode PSK
Wi-Fi Protected Setup® (WPS) <sup>*1</sup>	Push Button Configuration (PBC), Personal Identification Number (PIN)

<sup>\*1</sup> WPS 2.0 compliant. WPS 2.0 works on access points with the following encryption types: Mixed mode PSK, WPA-PSK AES, WPA2-PSK AES, WPA-PSK TKIP, Open (No Security)

You can select a method to configure a wireless setting from the following:

WPS-PBC (Wi-Fi | WPS Button)<sup>\*1</sup>

WPS-PBC (Operator Panel Menu)<sup>\*1</sup>

WPS-PIN<sup>\*2</sup>

Auto SSID Setup

Manual SSID Setup



<sup>\*1</sup> WPS-PBC (Wi-Fi Protected Setup-Push Button Configuration) is a method to authenticate and register devices required for wireless configuration, by starting WPS-PBC on the printer with the **Wi-Fi** (Wi-Fi | WPS) button or operator panel menu, and then pressing the button provided on the wireless LAN access point (Registrar) or router. This setting is available only when the access point supports WPS-PBC.

<sup>\*2</sup> WPS-PIN (Wi-Fi Protected Setup-Personal Identification Number) is a method to authenticate and register devices required for wireless configuration, by entering PIN assignments in the printer and computer. This setting, performed through access point, is available only when the access points of your wireless router supports WPS.



### WPS-PBC (Wi-Fi | WPS Button)

You can start WPS-PBC (Wi-Fi Protected Setup-Push Button Configuration) by pressing the **WiFi** (Wi-Fi | WPS) button.

-  **NOTE:** WPS-PBC is available only when the wireless LAN access point (Registrar) or router supports WPS-PBC.
-  **NOTE:** Before starting WPS-PBC with the **WiFi** (Wi-Fi | WPS) button, confirm the position of the WPS button (button name may vary) on the wireless LAN access point (Registrar) or router. For information about WPS operation on the wireless LAN access point (Registrar) or router, refer to the manual supplied with the product.
-  **NOTE:** For more information on the **WiFi** (Wi-Fi | WPS) button, see "Status of Wi-Fi | WPS Button Backlight" on page 78. If a problem occurs or error messages are displayed on the operator panel, see "Wireless Problems" on page 224.



- 1 Press and hold the **WiFi** (Wi-Fi | WPS) button on the printer for 2 seconds.  
Ensure that the **WiFi** (Wi-Fi | WPS) button starts to flash and `Press WPS Button on Router` appears on the operator panel.



- 2 Start the WPS operation on the wireless LAN access point (Registrar) or router within two minutes.
- 3 When the WPS operation is successful and the printer is rebooted, wireless LAN connection setting is completed.

### WPS-PBC (Operator Panel Menu)

You can start WPS-PBC (Wi-Fi Protected Setup-Push Button Configuration) from the operator panel.

-  **NOTE:** WPS-PBC is available only when the wireless LAN access point (Registrar) or router supports WPS-PBC.
-  **NOTE:** Before starting WPS-PBC, confirm the position of the WPS button (button name may vary) on the wireless LAN access point (Registrar) or router. For information about WPS operation on the wireless LAN access point (Registrar) or router, refer to the manual supplied with the product.
-  **NOTE:** A Password is required to enter Admin Menu when Panel Lock Set is set to Enable. In this case, enter the password you specified, and press the **✓ (Set)** button.





- 1 Press the **☰ (Menu)** button.
- 2 Press the **✓** button until Admin Menu appears, and then press the **✓ (Set)** button.
- 3 Press the **✓** button until Network appears, and then press the **✓ (Set)** button.
- 4 Press the **✓** button until WPS Setup appears, and then press the **✓ (Set)** button.
- 5 Ensure that Push Btn. Ctrl appears, and then press the **✓ (Set)** button.
- 6 Ensure that Are you sure? appears, and then press the **✓ (Set)** button.  
Ensure that `Press WPS Button on Router` is displayed, and start the WPS-PBC on the wireless LAN access point (Registrar) or router within two minutes.
- 7 When the WPS operation is successful and the printer is rebooted, wireless LAN connection setting is completed.

## WPS-PIN

The PIN code of WPS-PIN can only be configured from the operator panel.

 **NOTE:** WPS-PIN is available only when the wireless LAN access point (Registrar) or router supports WPS-PIN.

 **NOTE:** A Password is required to enter Admin Menu when Panel Lock Set is set to Enable. In this case, enter the password you specified, and press the ✓ (Set) button.





- 1 Press the  (Menu) button.
- 2 Press the  button until Admin Menu appears, and then press the ✓ (Set) button.
- 3 Press the  button until Network appears, and then press the ✓ (Set) button.
- 4 Press the  button until WPS Setup appears, and then press the ✓ (Set) button.
- 5 Ensure that PIN Code appears, and then press the ✓ (Set) button.
- 6 Write down the displayed 8-digit PIN code or select Print PIN Code. The PIN code is printed.
- 7 Ensure that Start Config. appears, and then press the ✓ (Set) button.
- 8 Ensure that Operate Wireless Router is displayed, and enter the PIN code displayed on step 6 into the wireless LAN access point (Registrar) or router.

 **NOTE:** For WPS operation on the wireless LAN access point (Registrar) or router, refer to the manual supplied with the product.

- 9 When the WPS operation is successful and the printer is rebooted, wireless LAN connection setting is completed.

## Auto SSID Setup

 **NOTE:** A Password is required to enter Admin Menu when Panel Lock Set is set to Enable. In this case, enter the password you specified, and press the ✓ (Set) button.

- 1 Press the  (Menu) button.
- 2 Press the  button until Admin Menu appears, and then press the ✓ (Set) button.
- 3 Press the  button until Network appears, and then press the ✓ (Set) button.
- 4 Press the  button until Wireless Setup appears, and then press the ✓ (Set) button.  
The printer automatically searches the access points on wireless network.
- 5 Press the  button until the desired access point appears, and then press the ✓ (Set) button.  
If the desired access point does not appear, go to "Manual SSID Setup" on page 33.

 **NOTE:** Some hidden SSID may not be displayed. If the SSID is not detected turn on SSID broadcast from the router.

- 6 Enter the passphrase or WEP key.

When the encryption type of the selected access point is WPA, WPA2 or Mixed in step 5:

- Enter the passphrase, and then press the ✓ (Set) button.

When the encryption type of the selected access point is WEP in step 5:

- Enter the WEP key, and then press the ✓ (Set) button.

 **NOTE:** A passphrase is an encryption key for WPA and WPA2 encryption which consists of 8 to 63 alphanumeric characters. It may be described as a key on some access points or routers. For details, refer to the manual supplied with the access point or router.

- 7 Ensure that Restart Printer to apply settings appears.
- 8 Turn off the printer, and turn it on again to apply the settings.  
Wireless LAN connection setting is complete.

## Manual SSID Setup

 **NOTE:** A Password is required to enter Admin Menu when Panel Lock Set is set to Enable. In this case, enter the password you specified, and press the ✓ (Set) button.

- 1 Press the  (Menu) button.
- 2 Press the ✓ (Set) button until Admin Menu appears, and then press the ✓ (Set) button.
- 3 Press the ✓ (Set) button until Network appears, and then press the ✓ (Set) button.
- 4 Press the ✓ (Set) button until Wireless Setup appears, and then press the ✓ (Set) button.
- 5 Press the ✓ (Set) button until Manual Setup appears, and then press the ✓ (Set) button.
- 6 Enter the SSID, and then press the ✓ (Set) button.
- 7 Select the network mode from Infrastructure and Ad-hoc depending on your environment, and then press the ✓ (Set) button.

If you select Infrastructure, proceed to step 8.

If you select Ad-hoc, proceed to step 9.

- 8 Select the encryption type from No Security, Mixed mode PSK, WEP, WPA-PSK-TKIP, or WPA2-PSK-AES.

If you do not set security for your wireless network:

- Press the ✓ (Set) button until No Security appears, and then press the ✓ (Set) button.

To use Mixed mode PSK, WPA-PSK-TKIP, or WPA2-PSK-AES encryption:

- a Press the ✓ (Set) button until Mixed mode PSK, WPA-PSK-TKIP, or WPA2-PSK-AES appears, and then press the ✓ (Set) button.
- b Enter the passphrase, and then press the ✓ (Set) button.

 **NOTE:** A passphrase is an encryption key for WPA and WPA2 encryption which consists of 8 to 63 alphanumeric characters. It may be described as a key on some access points or routers. For details, refer to the manual supplied with the access point or router.

To use WEP encryption:

- a Press the ✓ (Set) button until WEP appears, and then press the ✓ (Set) button.
- b Enter the WEP key, and then press the ✓ (Set) button.
- c Press the ✓ (Set) button to highlight the desired transmit key from Auto or WEP Key 1 to WEP Key 4, and then press the ✓ (Set) button.

Proceed to step 10.

- 9 Select the encryption type from No Security or WEP.

If you do not set security for your wireless network:

- Ensure that No Security appears, and then press the ✓ (Set) button.

To use WEP encryption:

- a Press the ✓ (Set) button until WEP appears, and then press the ✓ (Set) button.
- b Enter the WEP key, and then press the ✓ (Set) button.
- c Press the ✓ (Set) button to highlight the desired transmit key from WEP Key 1 to WEP Key 4, and then press the ✓ (Set) button.

- 10 Ensure that `Restart Printer to apply settings` appears.
- 11 Turn off the printer, and turn it on again to apply the settings.  
Wireless LAN connection setting is complete.

### **Ethernet Connection (Dell C1760nw Color Printer only)**

To connect the printer to a network:

- 1 Ensure that the printer, computer and any other connected devices have been turned off and all cables have been disconnected.
- 2 Connect the Ethernet cable.

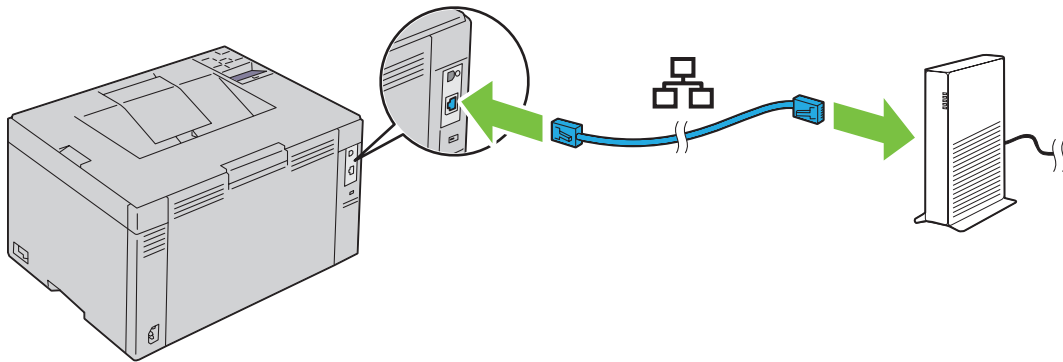

**NOTE:** Connect the Ethernet cable, only if you need to setup a wired connection.

To connect the printer to the network, connect one end of an Ethernet cable into the Ethernet port on the back of the printer, and the other end to a LAN port or LAN hub.

To setup a wireless connection, see "Wireless Connection" on page 30.

## Reconfiguring the Wireless Setting

To change the wireless setting through an Ethernet or wireless connection from your computer, perform the following.

 **NOTE:** To change the wireless setting through wireless connection, ensure that the wireless connection setting is completed in "Wireless Connection" on page 30.

 **NOTE:** The following settings are available when the network mode is set to infrastructure in "Wireless Connection" on page 30.

- 1 Check the IP address of the printer.  
For details about how to check the IP address of the printer, see "Verifying the IP Settings" on page 41.
- 2 Launch the Dell Printer Configuration Web Tool by entering the IP address of the printer in your web browser.

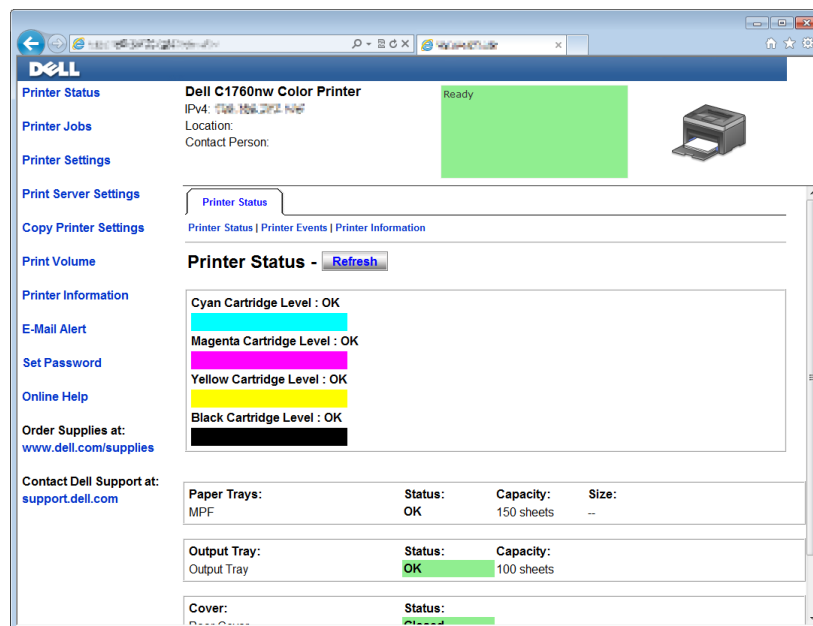

- 3 Click **Print Server Settings**.
- 4 Click **Print Server Settings** tab.
- 5 Click **Wireless LAN**.
- 6 Change the wireless setting of the printer.
- 7 Reboot the printer.
- 8 Change the wireless settings on your computer or access point accordingly.

 **NOTE:** To change the wireless settings on your computer, refer to the manuals provided with the wireless adapter or if your computer provides a wireless adapter tool, change the wireless settings using that tool.

## Turning On the Printer

**⚠ WARNING: Do not use extension cords or power strips.**

**⚠ WARNING: The printer should not be connected to an Uninterruptible Power Supply (UPS) system.**

- 1 Connect the power cable to the power connector on the back of your printer (see "Rear View" on page 22).

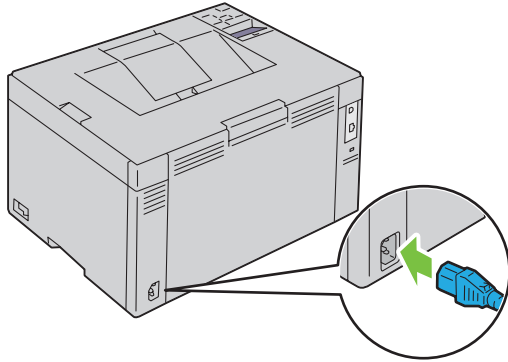

- 2 Connect the other end of the cable to the power source.

- 3 Turn on the printer.

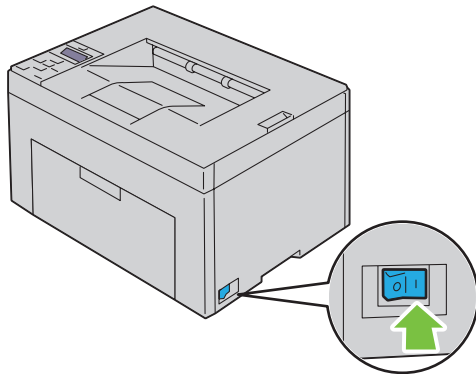

# Setting Up Your Printer

## Setting Initial Settings on the Operator Panel (Dell™ C1660w Color Printer Only)

You need to set the printer language and whether to enable wireless LAN when you turn on the printer for the first time.

When you turn the printer on, the wizard screen to perform the initial setup appears on the operator panel. Follow the steps below to set the initial settings.

 **NOTE:** If you do not start configuring the initial settings, the printer automatically restarts in three minutes. After that, you can set the following initial setup by enabling `Power On Wizard` on the operator panel or **Dell Printer Configuration Web Tool** if needed.

 **NOTE:** For more information on operator panel, see "Operator Panel" on page 77.

 **NOTE:** For more information on **Dell Printer Configuration Web Tool**, see "Dell™ Printer Configuration Web Tool" on page 81.

- 1 Ensure that `Language` appears. Press the **V** button until the desired language appears, and then press the **✓** (**Set**) button.

---

English

---

Français

---

Italiano

---

Deutsch

---

Español

---

Dansk

---

Nederlands

---

Norsk

---

Svenska

---

- 2 Ensure that `Wireless` appears. Press the **V** button until the desired selection appears, and then press the **✓** (**Set**) button.

The printer automatically restarts.

## Printer Setup Using the Software and Documentation Disc

- 1 Insert the *Software and Documentation* disc into your computer to start **Dell Printer Setup**.
- 2 Double-click the **Dell C1760/C1660 Installer** icon, and follow the on-screen instructions to connect the computer and the printer.

 **NOTE:** If the *Software and Documentation* disc does not automatically launch, try the following steps.

For Windows® XP, Windows Vista®, Windows 7, Windows Server® 2003, Windows Server 2008, and Windows Server 2008 R2:

- 1 Click **Start** → **All Programs** (for Windows Vista and Windows 7) → **Accessories** (for Windows Vista and Windows 7) → **Run**.
- 2 Type `D:\setup_assist.exe` (where D is the drive letter of the optical drive), and then click **OK**.

For Windows 8 and Windows Server 2012:

- 1 Point to the bottom right corner of the screen, and then click **Search** → Type **Run** in the search box, click **Apps**, and then click **Run**.
- 2 Type `D:\setup_assist.exe` (where D is the drive letter of the optical drive), and then click **OK**.



# Setting the IP Address

## Assigning an IP Address

An IP address is a unique number that consists of four sections that are delimited by a period and can include up to three digits in each section, for example, 111 . 222 . 33 . 44.

You can select the IP mode from Dual Stack, IPv4, and IPv6. If your network supports both IPv4 and IPv6, select Dual Stack.

 **CAUTION:** Assigning an IP address that is already in use can cause network performance issues.

 **NOTE:** Assigning an IP address is considered as an advanced function and is normally done by a system administrator.



 **NOTE:** When you assign an IP address manually in **IPv6 Mode**, use the **Dell™ Printer Configuration Web Tool**. To open the **Dell Printer Configuration Web Tool**, use the link local address. To check a link local address, see "Verifying the IP Settings" on page 41.

 **NOTE:** Depending on the address class, the range of the IP address assigned may be different. On Class A, for example, an IP address in the range from 0 . 0 . 0 . 0 to 127 . 255 . 255 . 255 will be assigned. For assignment of IP addresses, contact your system administrator.

You can assign the IP address by using the operator panel or using the **Tool Box**.

### The Operator Panel



For more information on using your operator panel, see "Operator Panel" on page 77.

 **NOTE:** A Password is required to enter Admin Menu when Panel Lock Set is set to Enable. In this case, enter the password you specified, and press the  (**Set**) button.

- 1 Turn on the printer.

The Ready to Print message appears on the operator panel.

- 2 Press the  (Menu) button.

- 3 Press the  button until Admin Menu appears, and then press the  (set) button.

- 4 Ensure that Network appears, and then press the  (set) button.



- 5 Press the  button until TCP/IP appears, and then press the  (set) button.



- 6 Press the  button until IPv4 appears, and then press the  (set) button.

- 7 Ensure that Get IP Address appears, and then press the  (set) button.

- 8 Press the  button until Panel appears, and then press the  (set) button.

- 9 Press the  button and ensure that Get IP Address appears.

- 10 Press the  button until IP Address appears, and then press the  (set) button.  
The cursor is located at the first digit of the IP address.



- 11 Press the  or  button to enter the numbers for the IP address.

- 12 Press the  button.

The next digit is selected.

- 13 Repeat step 11 and step 12 to enter all the digits in the IP address, and then press the  (set) button.

- 14 Press the  button and ensure that IP Address appears.

- 15 Press the  button until Subnet Mask appears, and then press the  (set) button.  
The cursor is located at the first digit of the subnet mask.

- 16 Press the **▲** or the **▼** button to enter the numbers for the subnet mask.
- 17 Press the **➤** button.  
The next digit is selected.
- 18 Repeat step 16 and step 17 and set subnet mask, and then press the **✓** (set) button.
- 19 Press the **◀** button and ensure that Subnet Mask appears.
- 20 Press the **▼** button until Gateway Address appears, and then press the **✓** (set) button.  
The cursor is located at the first digit of the gateway address.
- 21 Press the **▲** or **▼** button to enter the numbers for the gateway address.
- 22 Press the **➤** button.  
The next digit is selected.
- 23 Repeat step 21 and step 22 to set gateway address, and then press the **✓** (set) button.
- 24 Turn off and turn on the printer.

### The Tool Box

 **NOTE:** When you use IPv6 Mode for network printing, the **Tool Box** cannot be used to assign an IP address.

- 1 Click Start → All Programs → Dell Printers → Dell C1760nw Color Printer or Dell C1660w Color Printer → Tool Box.

 **NOTE:** The **Select Printer** dialog box opens in this step, when multiple printer drivers are installed on your computer. In this case, click the name of **Dell C1760nw Color Printer** or **Dell C1660w Color Printer** listed in **Printer Name**, and then click **OK**.

The **Tool Box** opens.



- 2 Click the **Printer Maintenance** tab.
- 3 Select **TCP/IP Settings** from the list at the left side of the page.  
The **TCP/IP Settings** page is displayed.
- 4 Select the mode from **IP Address Mode**, and then enter the values in **IP Address**, **Subnet Mask**, and **Gateway Address**.
- 5 Press the **Apply New Settings** button to take effect.

The IP address is assigned to your printer. To verify the setting, open the web browser on any computer connected to the network and enter the IP address into the address bar on the browser. If the IP address is set up correctly, the **Dell Printer Configuration Web Tool** displays in your browser.









You can also assign the IP address to the printer when installing the printer drivers with installer. When you use the **Network Installation** feature, and the **Get IP Address** is set to **AutoIP** on the operator panel menu, you can set the IP address from 0.0.0.0 to the desired IP address on the printer selection window.

## Verifying the IP Settings

You can confirm the settings by using the operator panel, printing the printer settings report, or using the ping command.

 **NOTE:** A Password is required to enter Admin Menu when Panel Lock Set is set to Enable. In this case, enter the password you specified, and press the  (Set) button.

### The Operator Panel

- 1 Press the  (Menu) button.
- 2 Press the  button until Admin Menu appears, and then press the  (set) button.
- 3 Ensure that Network appears, and then press the  (set) button.
- 4 Press the  button until TCP/IP appears, and then press the  (set) button.
- 5 Press the  button until IPv4 appears, and then press the  (set) button.  
Check the IP address displayed on the operator panel.

### The System Settings Report

- 1 Print the system settings report.  
For details about how to print a system settings report, see "Printing a Report/List Using the Operator Panel" on page 125.
- 2 Verify the correct IP address, subnet mask, and gateway address are listed in the system settings report under **Wired Network** or **Wireless Network**.  
If the IP address shows 0.0.0.0 (the factory default), an IP address has not been assigned. To assign one for your printer, see "Assigning an IP Address" on page 39.

### The Ping Command





Ping the printer and verify that it responds. For example, at a command prompt on a network computer, type ping followed by the new IP address (for example, 192.168.0.11):

```
ping 192.168.0.11
```

If the printer is active on the network, you will receive a reply.



## Loading Paper

-  **NOTE:** The priority sheet inserter (PSI) is available for Dell™ C1760nw Color Printer only.
-  **NOTE:** The images used in this manual are those of the Dell C1760nw Color Printer unless otherwise mentioned.
-  **NOTE:** To avoid paper jams, do not remove the priority sheet inserter while a printing is in progress.
-  **NOTE:** Use only laser print media. Do not use ink jet paper in your printer.
-  **NOTE:** For printing envelopes, see "Loading Print Media" on page 151.

### Loading Print Media in the Multipurpose Feeder (MPF)

-  **NOTE:** The PSI is available for Dell C1760nw Color Printer only.
- 1 Open the front cover by pulling out the instruction sheet.

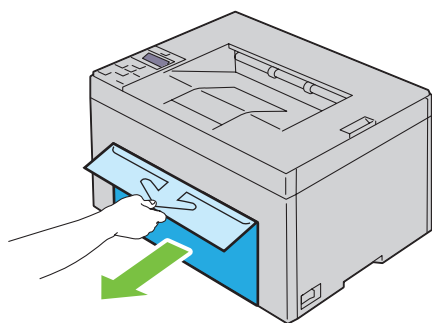

- 2 Pull the PSI out.

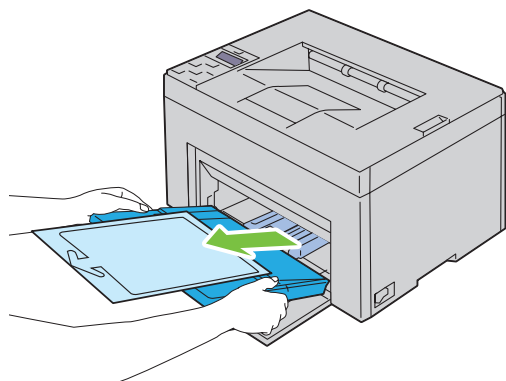

- 3 Remove the instruction sheet attached to the PSI with adhesive tape.

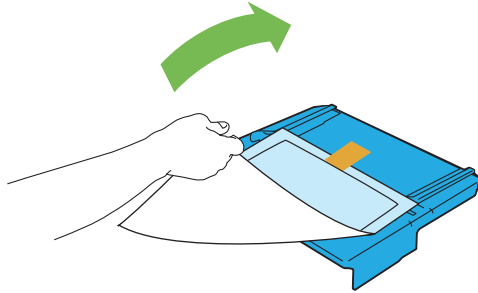

 **NOTE:** Read the instruction sheet before you use the PSI.

- 4 Pull the length guide forward until it stops.

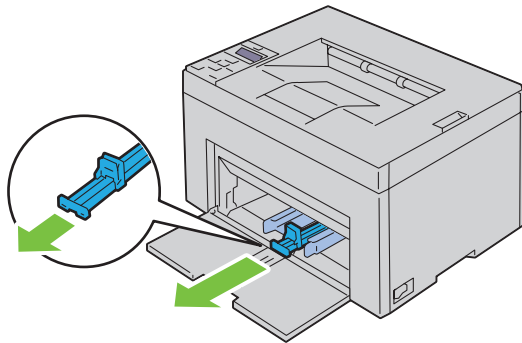

- 5 Pull the MPF extension forward until it stops.

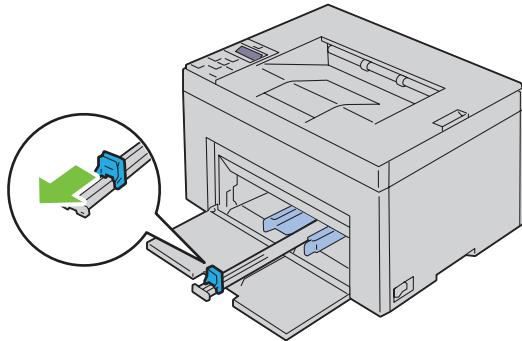

6 Adjust the paper width guides to their maximum.

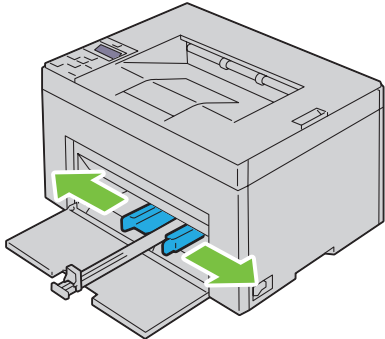

7 Before loading the print media, flex the sheets back and forth, and then fan them. Straighten the edges of the stack on a level surface.

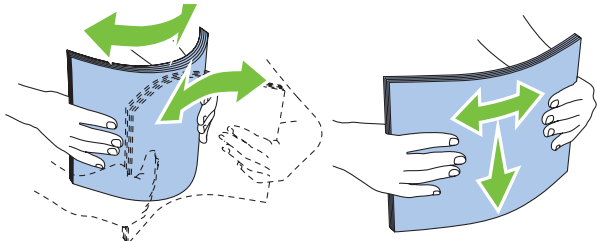

8 Load print media on the MPF with the top edge first and with the recommended print side facing up.

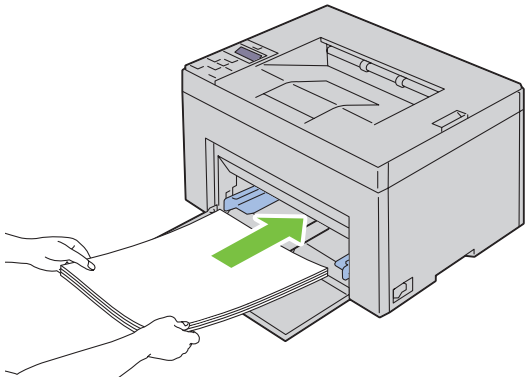

9 Adjust the width guides until they rest lightly against the edges of the stack of print media.

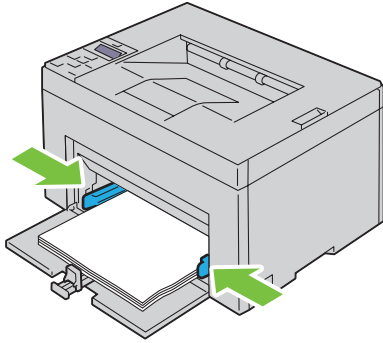

10 Slide the length guide towards the printer until it touches the print media.

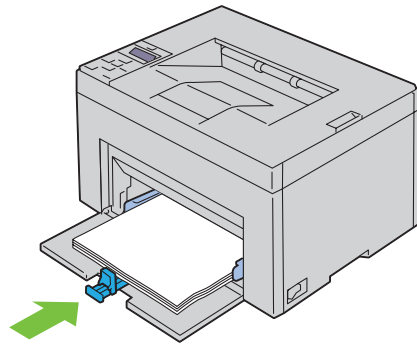

 **NOTE:** Depending on the size of print media, first slide the length guide backward until it stops, and then slide the MPF extension until it touches print media.

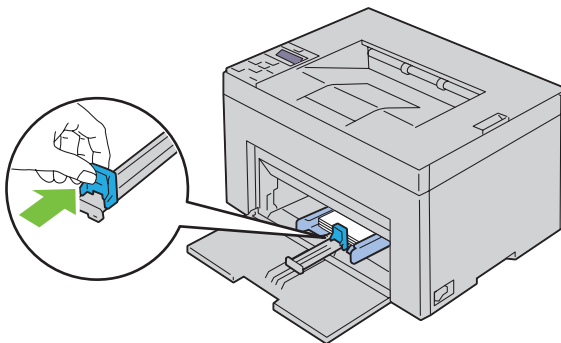
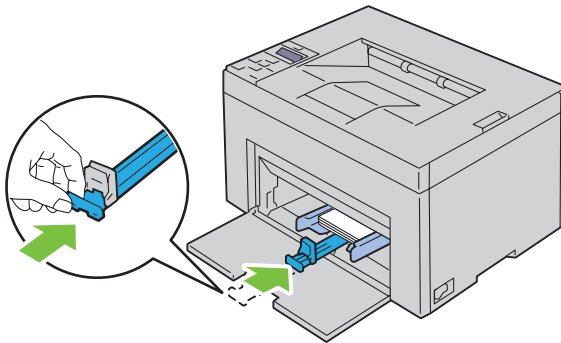



- 11** Insert the PSI into the printer and then align the PSI to the marking on the paper tray.

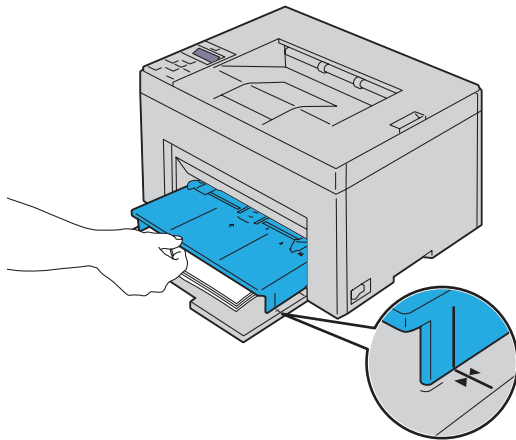
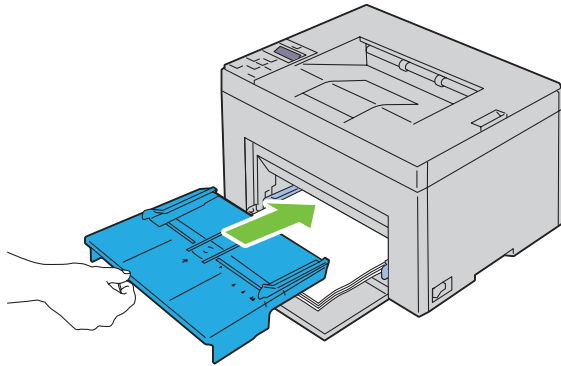

- 12** Select the paper type from the printer driver if the loaded print media is not standard plain paper.  
If a user-specified print media is loaded in the MPF, you must specify the paper size setting by using the printer driver.

## Loading Print Media in the Priority Sheet Inserter (PSI) (Dell C1760nw Color Printer only)

- 1 Open the front cover.

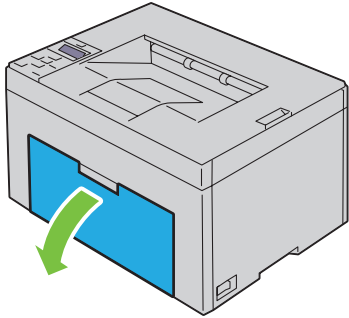

- 2 Slide the PSI forward, and then align the PSI to the marking on the paper tray.

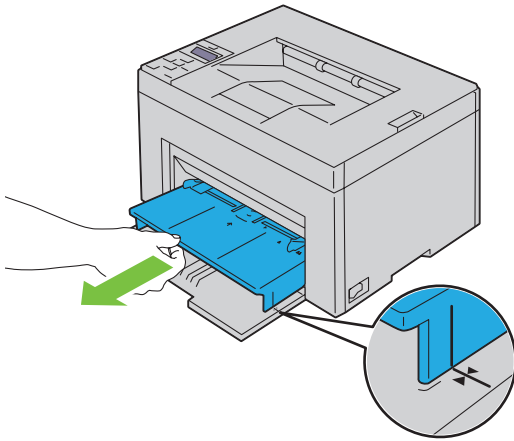

- 3 Before loading the print media, flex the sheets back and forth, and then fan them. Straighten the edges of the stack on a level surface.

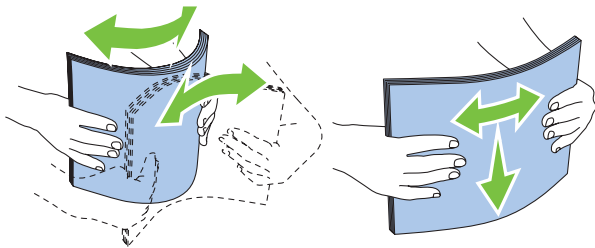

- 4 Load print media on the PSI with the top edge first and with the recommended print side facing up.

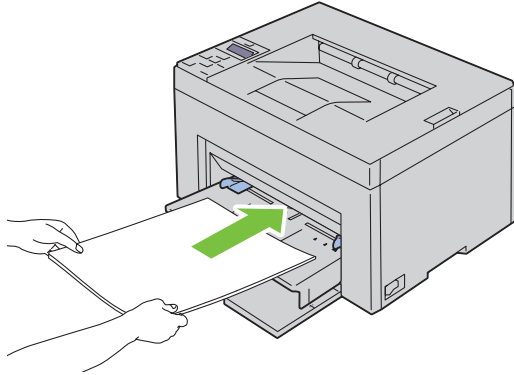

- 5 Adjust the width guides until they rest lightly against the edges of the stack of print media.

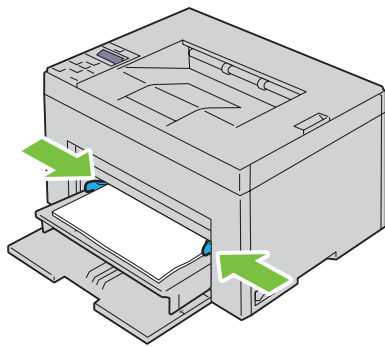

- 6 Select the paper type from the printer driver if the loaded print media is not standard plain paper.  
If a user-specified print media is loaded in the PSI, you must specify the paper size setting by using the printer driver.



# Installing Printer Drivers on Computers Running Windows®

 **NOTE:** The images used in this manual are those of the Dell™ C1760nw Color Printer unless otherwise mentioned.

## Identifying Printer Driver Pre-install Status

Before installing the printer driver on your computer, check the IP address of your printer by performing one of the procedures in "Verifying the IP Settings" on page 41.

### Changing the firewall settings before installing your printer

If you are running one of the following operating systems, you must change the firewall settings before installing the Dell printer software:

- Microsoft® Windows XP
- Windows Vista®
- Windows 7
- Windows 8
- Windows Server® 2008
- Windows Server 2008 R2
- Windows Server 2012

 **NOTE:** For Windows XP, Service Pack 2 or 3 must be installed.

The following procedure uses Windows 7 as an example.

- 1 Insert the *Software and Documentation* disc into your computer.
- 2 Click **Start** → **Control Panel**.
- 3 Select **System and Security**.
- 4 Click **Allow a program through Windows Firewall**.
- 5 Click **Change settings** → **Allow another program**.
- 6 Check **Browse**.
- 7 `D:\setup_assist.exe` (where D is the drive letter of the optical drive) in the **File name** text box, and then click **Open**.
- 8 Click **Add**, and then click **OK**.

## Direct Connection Setup

### For installing host-based printer driver

- 1 Insert the *Software and Documentation* disc into your computer to start **Dell Printer Setup**.
- 2 Click **Install Printer Driver and Software**.
- 3 Select **Personal Installation**, and then click **Next**.

- 4 Follow the on-screen instructions to connect the computer and the printer with a USB cable, and then turn on the printer.  
The Plug and Play installation starts and the installation software proceeds to the next page automatically.
- 5 Click **Finish** to exit the wizard when the **Ready to Print!** screen appears. If necessary, click **Print Test Page** to print a test page.

### **Personal Installation**

A personal printer is a printer attached to your computer or a print server using a USB. If your printer is attached to a network and not your computer, see "Network Connection Setup" on page 54.

### **For installing XML Paper Specification (XPS) printer driver**



**NOTE:** Download and install the XPS printer driver at [support.dell.com](http://support.dell.com).



**NOTE:** The XPS driver is supported on the following operating systems: Windows Vista, Windows Vista 64-bit Edition, Windows 7, Windows 7 64-bit Edition, Windows 8, Windows 8 64-bit Edition, Windows Server 2008, Windows Server 2008 64-bit Edition, Windows Server 2008 R2, and Windows Server 2012.

### **Windows Vista or Windows Vista 64-bit Edition**

- 1 Extract the zip file you downloaded to your desired location.
- 2 Click **Start** → **Control Panel** → **Hardware and Sound** → **Printers**.
- 3 Click **Add a printer**.
- 4 Click **Add a local printer**.
- 5 Select the port connected to this product, and then click **Next**.
- 6 Click **Have Disk** to display the **Install From Disk** dialog box.
- 7 Click **Browse**, and then select the extracted folder in step 1.
- 8 Click **OK**.
- 9 Select your printer name and click **Next**.
- 10 To change the printer name, enter the printer name in the **Printer name** box. To use this printer as the default printer, select the check box displayed under the **Printer name**. Click **Next**.

Installation starts.

If the **User Account Control** dialog box appears, click **Continue**.



**NOTE:** If you are an administrator on the computer, click **Continue**; otherwise, contact your administrator to continue the desired action.

- 11 As the driver installation is completed, click **Print a test page** to print a test page.
- 12 Click **Finish**.

### **Windows Server 2008 or Windows Server 2008 64-bit Edition**



**NOTE:** You must log in as an administrator.

- 1 Extract the zip file you downloaded to your desired location.
- 2 Click **Start** → **Control Panel** → **Hardware and Sound** → **Printers**.
- 3 Click **Add a printer**.
- 4 Click **Add a local printer**.
- 5 Select the port connected to this product, and then click **Next**.
- 6 Click **Have Disk** to display the **Install From Disk** dialog box.

- 7 Click **Browse**, and then select the extracted folder in step 1.
- 8 Click **OK**.
- 9 Select your printer name and click **Next**.
- 10 To change the printer name, enter the printer name in the **Printer name** box.  
To use this printer as the default printer, select the **Set as the default printer** check box. Click **Next**.  
Installation starts.
- 11 If you do not share your printer, select **Do not share this printer**. If you share your printer, select **Share this printer so that others on your network can find and use it**. Click **Next**.
- 12 As the driver installation is completed, click **Print a test page** to print a test page.
- 13 Click **Finish**.

#### **Windows 7, Windows 7 64-bit Edition, or Windows Server 2008 R2**

- 1 Extract the zip file you downloaded to your desired location.
  - 2 Click **Start** → **Devices and Printers**.
  - 3 Click **Add a printer**.
  - 4 When you use Windows Server 2008 R2, click **Add a local or network printer as an administrator**.  
If the **User Account Control** dialog box appears, click **Yes**.
-  **NOTE:** If you are an administrator on the computer, click **Yes**; otherwise, contact your administrator to continue the desired action.
- 5 Click **Add a local printer**.
  - 6 Select the port connected to this product, and then click **Next**.
  - 7 Click **Have Disk** to display the **Install From Disk** dialog box.
  - 8 Click **Browse**, and then select the extracted folder in step 1.
  - 9 Click **OK**.
  - 10 Select your printer name and click **Next**.
  - 11 To change the printer name, enter the printer name in the **Printer name** box, and then click **Next**.  
Installation starts.
  - 12 If you do not share your printer, select **Do not share this printer**. If you share your printer, select **Share this printer so that others on your network can find and use it**. Click **Next**.
  - 13 As the driver installation is completed, click **Print a test page** to print a test page. To use this printer as the default printer, select the **Set as the default printer** check box.
  - 14 Click **Finish**.

#### **Windows 8, Windows 8 64-bit Edition, or Windows Server 2012**

- 1 Extract the zip file you downloaded to your desired location.
- 2 Right-click the bottom left corner of the screen, and then click **Control Panel**.
- 3 Click **Hardware and Sound** (**Hardware** for Windows Server 2012) → **Devices and Printers** → **Add a printer**.
- 4 Click **Have Disk** to display the **Install From Disk** dialog box.
- 5 Click **Browse**, and then select the extracted folder in step 1.
- 6 Click **OK**.
- 7 Select your printer name and click **Next**.

- 8 To change the printer name, enter the printer name in the Printer name box, and then click **Next**.  
Installation starts.
- 9 If you do not share your printer, select **Do not share this printer**. If you share your printer, select **Share this printer so that others on your network can find and use it**. Click **Next**.
- 10 As the driver installation is completed, click **Print a test page** to print a test page. To use this printer as the default printer, select the **Set as the default printer** check box.
- 11 Click **Finish**.

## Network Connection Setup

### Network Printer Setup on a Local Network

#### For installing host-based printer driver

- 1 Insert the *Software and Documentation* disc into your computer to start **Dell Printer Setup**.
- 2 Click **Install Printer Driver and Software**.
- 3 Select **Network Installation**, and then click **Next**.
- 4 Select **Local Installation**, and then click **Next**.
- 5 Select the printer you want to install from the printer list, and then click **Next**. If the target printer is not displayed on the list, click **Refresh** to refresh the list or click **Add Printer** to add a printer to the list manually. You may specify the IP address and port name at this point.

If you have installed this printer on the server computer, select **I am setting up this printer on a server** check box.

 **NOTE:** When using AutoIP, 0.0.0.0 is displayed in the installer. Before you can continue, you must enter a valid IP address.

 **NOTE:** You can install the Web Services on Devices (WSD) printer, but the installation of using Windows Server 2008 is not supported.

 **NOTE:** If you are running any of the following operating systems, a Windows Security Alert is displayed:

- Windows Vista
- Windows Vista 64-bit Edition
- Windows 7
- Windows 7 64-bit Edition
- Windows 8
- Windows 8 64-bit Edition
- Windows Server 2008
- Windows Server 2008 64-bit Edition
- Windows Server 2008 R2 64-bit Edition
- Windows Server 2012

To continue installing the host-based printer driver, click **Unblock** or **Allow access** (for Windows Server 2008 R2 and Windows 7).

- 6 Specify the printer settings, and then click **Next**.
  - a Enter the printer name.
  - b If you want other users on the network to access this printer, select **Share this printer with other computers on the network**, and then enter a share name that users can identify.
  - c If you want to set a printer as the default, select the **Set this printer as default** check box.



- 7 Select the software and documentation you want to install, and then click **Install**. You can specify folders in which to install the Dell software and documentation. To change the folders, click **Browse**.
- 8 Click **Finish** to exit the wizard when the **Ready to Print!** screen appears. If necessary, click **Print Test Page** to print a test page.

#### **For installing XML Paper Specification (XPS) printer driver**

 **NOTE:** Download and install the XPS printer driver at [support.dell.com](http://support.dell.com).

 **NOTE:** The XPS driver is supported on the following operating systems: Windows Vista, Windows Vista 64-bit Edition, Windows 7, Windows 7 64-bit Edition, Windows 8, Windows 8 64-bit Edition, Windows Server 2008, Windows Server 2008 64-bit Edition., Windows Server 2008 R2, and Windows Server 2012.

#### ***Windows Vista or Windows Vista 64-bit Edition***

- 1 Extract the zip file you downloaded to your desired location.
- 2 Click **Start** → **Control Panel** → **Hardware and Sound** → **Printers**.
- 3 Click **Add a printer**.
- 4 Click **Add a network, wireless or Bluetooth printer**.
- 5 Select printer or click **The printer that I want isn't listed**.
- 6 Select **Add a printer using a TCP/IP address or hostname**, and then click **Next**.
- 7 Select **TCP/IP Device** for **Device type**, and enter the IP address for **Hostname or IP address**, and then click **Next**.  
If the **User Account Control Continue** dialog box appears, click **Continue**.

 **NOTE:** If you are an administrator on the computer, click **Continue**; otherwise, contact your administrator to continue the desired action.

- 8 Click **Have Disk** to display the **Install From Disk** dialog box.
- 9 Click **Browse**, then select the extracted folder in step 1, and then click **OK**.
- 10 Select your printer name and click **Next**.
- 11 To change the printer name, enter the printer name in the **Printer name** box, and then click **Next**.  
To use this printer as the default printer, select the **Set as the default printer** check box.

Installation starts.

If the **User Account Control** dialog box appears, click **Continue**.

 **NOTE:** If you are an administrator on the computer, click **Continue**; otherwise, contact your administrator to continue the desired action.

- 12 As the driver installation is completed, click **Print a test page** to print a test page.
- 13 Click **Finish**.



#### ***Windows Server 2008 or Windows Server 2008 64-bit Edition***

 **NOTE:** You must log in as an administrator.

- 1 Extract the zip file you downloaded to your desired location.
- 2 Click **Start** → **Control Panel** → **Hardware and Sound** → **Printers**.
- 3 Click **Add a printer**.
- 4 Click **Add a network, wireless or Bluetooth printer**.

- 5 Select your printer or click **The printer that I want isn't listed**.  
When you select your printer, go to step 8.  
When you click **The printer that I want isn't listed**, go to step 6.
- 6 Select **Add a printer using a TCP/IP address or hostname**, and then click **Next**.
- 7 Select **TCP/IP Device** from **Device type**, and enter the IP address for **Hostname or IP address**, and then click **Next**.  
If the **User Account Control Continue** dialog box appears, click **Continue**.
- 8 Click **Have Disk** to display the **Install From Disk** dialog box.
- 9 Click **Browse**, then select the extracted folder in step 1, and then click **OK**.
- 10 Select your printer name and click **Next**.
- 11 To change the printer name, enter the printer name in the **Printer name** box, and then click **Next**.  
To use this printer as the default printer, select the **Set as the default printer** check box.  
Installation starts.
- 12 If you do not share your printer, select **Do not share this printer**. If you share your printer, select **Share this printer so that others on your network can find and use it**. Click **Next**.
- 13 As the driver installation is completed, click **Print a test page** to print a test page.
- 14 Click **Finish**.

#### **Windows Server 2008 R2**

- 1 Extract the zip file you downloaded to your desired location.
- 2 Click **Start** → **Devices and Printers**.
- 3 Click **Add a printer**.
- 4 Click **Add a network, wireless or Bluetooth printer**.
- 5 Select your printer or click **The printer that I want isn't listed**.  
 **NOTE:** When you click **The printer that I want isn't listed**, **Find a printer by name or TCP/IP** screen appears where you can find your printer using your printer name or TCP/IP.  
If the **User Account Control** dialog box appears, click **Yes**.  
 **NOTE:** If you are an administrator on the computer, click **Yes**; otherwise, contact your administrator to continue the desired action.
- 6 Click **Have Disk** to display the **Install From Disk** dialog box.
- 7 Click **Browse**, then select the extracted folder in step 1, and then click **OK**.
- 8 Select your printer name and click **Next**.
- 9 To change the printer name, enter the printer name in the **Printer name** box, and then click **Next**.
- 10 If you do not share your printer, select **Do not share this printer**. If you share your printer, select **Share this printer so that others on your network can find and use it**.
- 11 Click **Next**.  
Installation starts.
- 12 As the driver installation is completed, click **Print a test page** to print a test page. To use this printer as the default printer, select the **Set as the default printer** check box.
- 13 Click **Finish**.

### ***Windows 7 or Windows 7 64-bit Edition***

- 1 Extract the zip file you downloaded to your desired location.
  - 2 Click **Start** → **Devices and Printers**.
  - 3 Click **Add a printer**.
  - 4 Click **Add a network, wireless or Bluetooth printer**.
  - 5 Select your printer or click **The printer that I want isn't listed**.  
When you select your printer, go to step 8.  
When you click **The printer that I want isn't listed**, go to step 6.
  - 6 Select **Add a printer using a TCP/IP address or host name**, and then click **Next**.
  - 7 Select **TCP/IP Device** from **Device type**, and enter the IP address for **Hostname or IP address**, and then click **Next**.  
If the **User Account Control** dialog box appears, click **Yes**.
-  **NOTE:** If you are an administrator on the computer, click **Yes**; otherwise, contact your administrator to continue the desired action.
- 8 Click **Have Disk** to display the **Install From Disk** dialog box.
  - 9 Click **Browse**, then select the extracted folder in step 1, and then click **OK**.
  - 10 Select your printer name and click **Next**.
  - 11 To change the printer name, enter the printer name in the **Printer name** box, and then click **Next**.  
Installation starts.
  - 12 As the driver installation is completed, click **Print a test page** to print a test page. To use this printer as the default printer, select the **Set as the default printer** check box.
  - 13 Click **Finish**.

### ***Windows 8, Windows 8 64-bit Edition, or Windows Server 2012***

- 1 Extract the zip file you downloaded to your desired location.
- 2 Right-click the bottom left corner of the screen, and then click **Control Panel**.
- 3 Click **Hardware and Sound** (**Hardware** for Windows Server 2012) → **Devices and Printers** → **Add a printer**.
- 4 Click **Have Disk** to display the **Install From Disk** dialog box.
- 5 Click **Browse**, and then select the extracted folder in step 1.
- 6 Click **OK**.
- 7 Select your printer name and click **Next**.
- 8 To change the printer name, enter the printer name in the **Printer name** box, and then click **Next**.  
Installation starts.
- 9 If you do not share your printer, select **Do not share this printer**. If you share your printer, select **Share this printer so that others on your network can find and use it**. Click **Next**.
- 10 As the driver installation is completed, click **Print a test page** to print a test page. To use this printer as the default printer, select the **Set as the default printer** check box.
- 11 Click **Finish**.

Use the **Dell Printer Configuration Web Tool** to monitor the status of your network printer without leaving your desk. You can view and/or change the printer settings, monitor toner level, and acknowledge the timing of ordering replacement consumables. You can click the Dell supplies link for ordering supplies.

 **NOTE:** The **Dell Printer Configuration Web Tool** is not available when the printer is directly connected to a computer or a print server.

To launch the **Dell Printer Configuration Web Tool**, type the printer's IP address in your web browser. The printer configuration appears on the screen.

You can set up the **Dell Printer Configuration Web Tool** to send you an e-mail when the printer needs supplies or intervention.

To set up e-mail alerts:

- 1 Launch the **Dell Printer Configuration Web Tool**.
- 2 Click **E-Mail Alert** link.
- 3 Under **E-Mail Server Settings**, enter the **Primary SMTP Gateway**, **Reply Address**, and your or key operator's e-mail address in the e-mail list box.
- 4 Click **Apply New Settings**.

 **NOTE:** **Connection pending until printer sends an alert** is displayed on the SMTP server until an error occurs.

## Network Printer Setup on a Remote Network

### Before Installation

Before you start remote installation, perform the following procedures.

#### *Allow Print Spooler to Accept Client Connections*

 **NOTE:** This step is required for Windows XP 64-bit Edition, Windows Vista, Windows Vista 64-bit Edition, Windows 7, Windows 7 64-bit Edition, Windows Server 2003, Windows Server 2003 x64 Edition, Windows Server 2008, Windows Server 2008 64-bit Edition, Windows Server 2008 R2.

For Windows XP 64-bit Edition, Windows Vista, Windows Server 2003, and Windows Server 2008:

- 1 Click **Start** → **All Programs** (for Windows Vista only) → **Accessories** (for Windows Vista only) → **Run**.
- 2 Type `gpedit.msc`, and then click **OK**.
- 3 Click **Computer Configuration** → **Administrative Templates** → **Printers**.
- 4 Right-click **Allow Print Spooler to accept client connections** and select **Properties**.
- 5 On the **Setting** tab, select **Enabled**, and then click **OK**.
- 6 Restart the computer.

For Windows Server 2008 R2 and Windows 7:

- 1 Click **Start** → **All Programs** (for Windows 7 only) → **Accessories** (for Windows 7 only) → **Run**.
- 2 Type `gpedit.msc`, and then click **OK**.
- 3 Click **Computer Configuration** → **Administrative Templates** → **Printers**.
- 4 Right-click **Allow Print Spooler to accept client connections** and select **Edit**.
- 5 Select **Enabled**, and then click **OK**.
- 6 Restart the computer.

### ***Share the Firewall File and Printer***



**NOTE:** This step is required for Windows XP, Windows XP 64-bit Edition, Windows Vista, Windows Vista 64-bit Edition, Windows 7, Windows 7 64-bit Edition, Windows 8, Windows 8 64-bit Edition, Windows Server 2008, Windows Server 2008 64-bit Edition, Windows Server 2008 R2, and Windows Server 2012.

For Windows XP:

- 1 Click start → Control Panel.
- 2 Select Security Center.
- 3 Click Windows Firewall.
- 4 On the Exceptions tab, check the File and Printer Sharing check box, and then click OK.

For Windows Vista:

- 1 Click Start → Control Panel.
- 2 Select Security.
- 3 Click Windows Firewall.
- 4 Click Change settings.
- 5 Click Continue.
- 6 On the Exceptions tab, check the File and Printer Sharing check box, and then click OK.

For Windows Server 2008:

- 1 Click Start → Control Panel.
- 2 Double-click Windows Firewall.
- 3 Click Change settings.
- 4 On the Exceptions tab, check the File and Printer Sharing check box, and then click OK.

For Windows Server 2008 R2 and Windows 7:

- 1 Click Start → Control Panel.
- 2 Select System and Security.
- 3 Click Windows Firewall.
- 4 Click Allow a program or feature through Windows Firewall.
- 5 If the check boxes under Allowed programs and features: are dimmed, click Change settings.
- 6 Check the File and Printer Sharing check box. Home/Work (Private) or Public check box is automatically selected according to your settings.  
If File and Printer Sharing Properties dialog box appears, click OK.
- 7 Click OK.

### ***Start Remote Registry***

 **NOTE:** This step is required for Windows Vista, Windows Vista 64-bit Edition, Windows 7, Windows 7 64-bit Edition, Windows 8, and Windows 8 64-bit Edition.

- 1 Click **Start** → **Control Panel**.
- 2 Select **System and Maintenance** (**System and Security** for Windows 7).
- 3 Click **Administrative Tools**.
- 4 Double-click **Services**.
- 5 Click **Continue** (for Windows Vista only).
- 6 Right-click **Remote Registry** and select **Start**.
- 7 Right-click **Remote Registry** and select **Properties**.
- 8 Change **Startup type**: to **Automatic**, and then click **OK**.

### ***Disable User Account Control***

 **NOTE:** Disabling the User Account Control might leave the system vulnerable to virus attacks.

 **NOTE:** This step is required for Windows Vista, Windows Vista 64-bit Edition, Windows 7, Windows 7 64-bit Edition, Windows Server 2008, Windows Server 2008 64-bit Edition, Windows Server 2008 R2.

For Windows Vista:

- 1 Click **Start** → **Control Panel**.
- 2 Select **User Accounts and Family Safety**.
- 3 Click **User Accounts**.
- 4 Click **Turn User Account Control on or off**.
- 5 Click **Continue**.
- 6 Clear the **Use User Account Control (UAC) to help protect your computer** check box.
- 7 Restart the computer.

For Windows Server 2008:

- 1 Click **Start** → **Control Panel**.
- 2 Double-click **User Accounts**.
- 3 Click **Turn User Account Control on or off**.
- 4 Click **Continue**.
- 5 Clear the **Use User Account Control (UAC) to help protect your computer** check box.
- 6 Click **OK**.
- 7 Restart the computer.

For Windows Server 2008 R2:

- 1 Click **Start** → **Control Panel**.
- 2 Select **User Accounts**.
- 3 Click **User Accounts**.
- 4 Click **Change User Account Control Settings**.
- 5 Move the slider to the bottom, and then click **OK**.
- 6 Click **Yes**.
- 7 Restart the computer.

For Windows 7:

- 1 Click Start → Control Panel.
- 2 Select User Accounts and Family Safety.
- 3 Click User Accounts.
- 4 Click Change User Account Control Settings.
- 5 Move the slider to the bottom, and then click OK.
- 6 Click Yes in User Account Control dialog box.
- 7 Restart the computer.

### **Enable Network Discovery and File Sharing for all Public Networks**



**NOTE:** This step is required when you use Windows Vista, Windows Vista 64-bit Edition, Windows 7, Windows 7 64-bit Edition, Windows 8, Windows 8 64-bit Edition, Windows Server 2008, Windows Server 2008 64-bit Edition, Windows Server 2008 R2, and Windows Server 2012 for the server computer.

For Windows 7, Windows 7 64-bit Edition, Windows Server 2008 R2:

- 1 Click Start → Control Panel → Network and Internet → Network and Sharing Center → Change advanced sharing settings.
- 2 To allow your computer to be found on the network, and to allow other computers on the network to share the files and folders on your computer, click Turn on network discovery.
- 3 Click Save changes.
- 4 If you see the User Account Control dialog box, click Yes.

For Windows Vista, Windows Vista 64-bit Edition, Windows Server 2008, Windows Server 2008 64-bit Edition:

- 1 Click Start → Network.
- 2 Right-click Network and select Properties.  
The Network and Sharing Center screen appears.
- 3 Click the down arrow button next to either Network discovery.
- 4 To allow your computer to be found on the network, and to allow other computers on the network to share the files and folders on your computer, click Turn on network discovery.
- 5 Click Apply.
- 6 If the User Account Control dialog box appears, click Continue.

### **Disable Simple File Sharing**



**NOTE:** This step is required for Windows XP, and Windows XP 64-bit Edition.

- 1 Click Start → Control Panel.
- 2 Select Appearance and Themes.
- 3 Select Folder Options.
- 4 On the View tab, clear the Use simple file sharing (Recommended) check box, and then click OK.
- 5 Click Start → Control Panel.
- 6 Select Performance and Maintenance.
- 7 Select Administrative Tools.
- 8 Double-click Local Security Policy.
- 9 Click Local Policies → Security Options.
- 10 Right-click Network access: Sharing and security model for local accounts and select Properties.

- 11 Ensure that **Classic - local users authenticate as themselves** is selected.
- 12 Click **OK**.

### Installing the Printer Driver

 **NOTE:** Installation on Windows XP Home Edition, Windows Vista Home Basic, Windows Vista Home Premium, Windows Vista x64 Home Basic, Windows Vista x64 Home Premium, Windows 7 Starter, Windows 7 Home Basic, Windows 7 Home Premium, Windows 7 x64 Home Basic, and Windows 7 x64 Home Premium, Windows 8, Windows 8 x64, Windows 8 Pro, Windows 8 x64 Pro, and Windows Server 2012 is not supported.

- 1 Insert the *Software and Documentation* disc provided with the printer in your computer. The **Dell Printer Setup** file launches automatically.
- 2 Click **Install Printer Driver and Software**.  
The **Choose an installation type** screen appears.
- 3 Select **Network Installation**, and then click **Next**.
- 4 Select **Remote Installation**, and then click **Next**.
- 5 Enter the Administrator user name and password of the client computer, then select the clients or servers, and then click **Next**.

 **NOTE:** If you are running any of the following operating systems, a Windows Security Alert is displayed:

- Windows Vista
- Windows Vista 64-bit Edition
- Windows 7
- Windows 7 64-bit Edition
- Windows Server 2008
- Windows Server 2008 64-bit Edition
- Windows Server 2008 R2 64-bit Edition

To continue installing the host-based printer driver, click **Unblock** or **Allow access** (for Windows Server 2008 R2 and Windows 7).

- 6 Check if the printer to be installed is listed in **Select Printer**, and then click **Next**.

 **NOTE:** If the printer to be installed is not listed in **Select Printer**, try the following steps:

- Click **Refresh** to update the information.
- Click **Add Printer**, and then enter a port name (any alphanumeric string of your choosing) and an existing IP address for the printer.

- 7 Select the required items on **Software and Documentation**, and then click **Install**.
- 8 Click **Finish** to exit this tool.

## Setting Up for Web Services on Devices (WSD)

This section provides information for network printing with WSD, the protocol of Microsoft for Windows Vista, Windows 7, Windows 8, Windows Server 2008, Windows Server 2008 R2, and Windows Server 2012.

### Adding Roles of Print Services

When you use Windows Server 2008 or Windows Server 2008 R2, you need to add the roles of print services to the Windows Server 2008 or Windows Server 2008 R2 client.



#### For Windows Server 2008 R2:

- 1 Click **Start** → **Administrative Tools** → **Server Manager**.
- 2 Select **Add Roles** from the **Action** menu.
- 3 Check the **Print and Document Services** check box on the **Server Roles** window in the **Add Roles Wizard**, and then click **Next**.
- 4 Click **Next**.
- 5 Check the **Print Server** check box, and then click **Next**.
- 6 Click **Install**.

#### For Windows Server 2008:

- 1 Click **Start** → **Administrative Tools** → **Server Manager**.
- 2 Select **Add Roles** from the **Action** menu.
- 3 Check the **Print Services** check box on the **Server Roles** window in the **Add Roles Wizard**, and then click **Next**.
- 4 Check the **Print Server** check box, and then click **Next**.
- 5 Click **Install**.

#### For Windows Server 2012:

- 1 Click **Server Manager** of the **Start** screen.
- 2 Select **Add Roles and Features** from the **Manage** menu.
- 3 Click **Next** on the **Before You Begin** window → Select installation type on the **Installation Type** window → Select destination server on the **Server Selection** window in the **Add Roles and Features Wizard**.
- 4 Check the **Print and Document Services** check box on the **Server Roles** window, and then click **Next**.
- 5 Select features on the **Features** window → Confirm installation selections on the **Confirmation** window.
- 6 Click **Install**.

### WSD Printer Setup

You can install your new printer on the network using Windows **Add Printer** wizard. When installing using the *Software and Documentation* disc that shipped with your printer, see "Network Connection Setup" on page 54 for details.

 **NOTE:** Installing WSD printer for Windows 8, Windows Server 2008, Windows Server 2008 R2, and Windows Server 2012 is available only with the **Add Printer** wizard.

#### Installing a Printer Driver Using the Add Printer Wizard

- 1 For Windows Vista, Windows 7, Windows Server 2008, and Windows Server 2008 R2:  
Click **Start** → **Devices and Printers** (**Start** → **Control Panel** → **Hardware and Sound** → **Printers** for Windows Server 2008 and Windows Vista).

For Windows 8, Windows Server 2012:

Right-click the bottom left corner of the screen, and then click **Control Panel** → **Hardware and Sound** (**Hardware** for Windows Server 2012) → **Devices and Printers**.

- 2 Click **Add a printer** to launch the **Add Printer** wizard.
- 3 Select **Add a network, wireless or Bluetooth printer**.
- 4 In the list of available printers, select the one you want to use, and then click **Next**.

 **NOTE:** In the list of available printers, the WSD printer is displayed in the form of **http://IP address/ws/**.

 **NOTE:** If no WSD printer is displayed in the list, enter the printer's IP address manually to create a WSD printer. To enter the printer's IP address manually, follow the instructions below. For Windows Server 2008 R2, to create a WSD printer, you must be a member of Administrators group.

1. Click **The printer that I want isn't listed**.
2. Select **Add a printer using a TCP/IP address or hostname** and click **Next**.
3. Select **Web Services Device** from **Device type**.
4. Enter the printer's IP address in the **Hostname or IP address** text box and click **Next**.

 **NOTE:** Before installing the driver using the **Add Printer** wizard on Windows Server 2008 R2 or Windows 7, perform one of the followings:

- Establish the Internet connection so that Windows Update can scan your computer.
  - Add the printer driver to your computer in advance.
- 5 Install the printer driver on your computer. If you are prompted for an administrator password or confirmation, type the password or provide confirmation.
  - 6 Complete the additional steps in the wizard, and then click **Finish**.
  - 7 Print a test page to verify print installation.
    - a For Windows Vista, Windows 7, Windows Server 2008, and Windows Server 2008 R2:  
Click **Start** → **Devices and Printers** (**Start** → **Control Panel** → **Hardware and Sound** → **Printers** for Windows Server 2008 and Windows Vista).  
For Windows 8, Windows Server 2012:  
Right-click the bottom left corner of the screen, and then click **Control Panel** → **Hardware and Sound** (**Hardware** for Windows Server 2012) → **Devices and Printers**.
    - b Right-click the printer you just created, and then click **Printer properties** (**Properties** for Windows Server 2008 and Windows Vista).
    - c On the **General** tab, click **Print Test Page**. When a test page is printed successfully, installation is complete.

## Setting Up for Shared Printing

You can share your new printer on the network using the *Software and Documentation* disc that shipped with your printer, or using Windows Point and Print or peer-to-peer method. However, if you use either of the Microsoft methods you will not get features such as the status monitor and other printer utilities, which will get installed with the *Software and Documentation* disc.

If you want to use the printer on a network, share the printer and install its drivers on all the computers on the network.

 **NOTE:** You need to purchase the Ethernet cable separately for shared printing.

### For Windows XP, Windows XP 64-bit Edition, Windows Server 2003, Windows Server 2003 x64 Edition

- 1 Click **Start** → **Printers and Faxes**.
- 2 Right-click this printer icon and select **Properties**.
- 3 From the **Sharing** tab, check the **Share this printer** check box, and then type a name in the **Share name** text box.
- 4 Click **Additional Drivers** and select the operating systems of all network clients using this printer.
- 5 Click **OK**.

If the files are not present in your computer, then you will be prompted to insert the server operating system CD.

### For Windows Vista, Windows Vista 64-bit Edition

- 1 Click **Start** → **Control Panel** → **Hardware and Sound** → **Printers**.
- 2 Right-click the printer icon and select **Sharing**.

- 3 Click **Change sharing options**.
- 4 The "Windows needs your permission to continue" appears.
- 5 Click **Continue**.
- 6 Select the **Share this printer** check box, and then type a name in the **Share name** text box.
- 7 Select **Additional Drivers** and select the operating systems of all network clients using this printer.
- 8 Click **OK**.

**For Windows Server 2008, Windows Server 2008 64-bit Edition**

- 1 Click **Start** → **Control Panel** → **Printers**.
- 2 Right-click the printer icon and select **Sharing**.
- 3 Click **Change Sharing Options** if exists.
- 4 Select the **Share this printer** check box, and then type a name in the **Share name** text box.
- 5 Click **Additional Drivers** and select the operating systems of all network clients using this printer.
- 6 Click **OK**.

**For Windows 7, Windows 7 64-bit Edition, Windows Server 2008 R2**

- 1 Click **Start** → **Devices and Printers**.
- 2 Right-click the printer icon and select **Printer properties**.
- 3 On the **Sharing** tab, click **Change Sharing Options** if exists.
- 4 Select the **Share this printer** check box, and then type a name in the **Share name** text box.
- 5 Click **Additional Drivers** and select the operating systems of all network clients using this printer.
- 6 Click **Apply**, and then click **OK**.

**For Windows 8, Windows 8 64-bit Edition, Windows Server 2012**

- 1 Right-click the bottom left corner of the screen, and then click **Control Panel** → **Hardware and Sound** (Hardware for Windows Server 2012) → **Devices and Printers**.
- 2 Right-click the printer icon and select **Printer properties**.
- 3 On the **Sharing** tab, click **Change Sharing Options** if exists.
- 4 Select the **Share this printer** check box, and then type a name in the **Share name** text box.
- 5 Click **Additional Drivers** and select the operating systems of all network clients using this printer.
- 6 Click **Apply**, and then click **OK**.

To check that the printer is shared:

- Ensure that the printer object in the **Printers, Printers and Faxes, or Devices and Printers** folder is shared. The share icon is shown under the printer icon.
- Browse **Network or My Network Places**. Find the host name of the server and look for the shared name you assigned to the printer.

Now that the printer is shared, you can install the printer on network clients using the Point and Print method or the peer-to-peer method.

## Point and Print

Point and Print is a Microsoft Windows technology that allows you to connect to a remote printer. This feature automatically downloads and installs the printer driver.

### For Windows XP, Windows XP 64-bit Edition, Windows Server 2003, Windows Server 2003 x64 Edition

- 1 On the Windows desktop of the client computer, double-click **My Network Places**.
- 2 Locate the host name of the server computer, and then double-click the host name.
- 3 Right-click the shared printer name, and then click **Connect**.

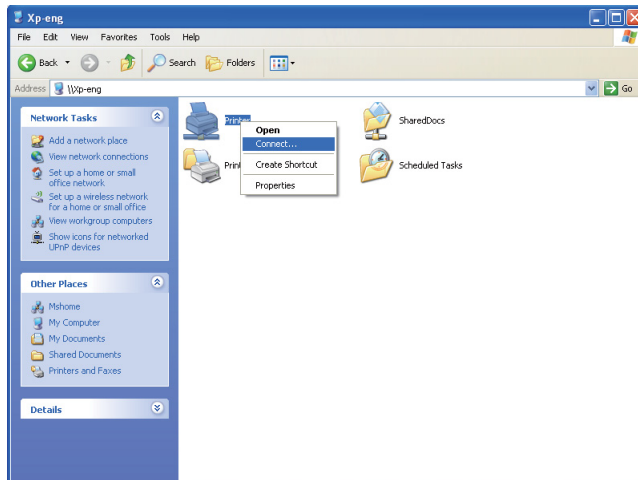

Wait for the driver information to be copied from the server computer to the client computer, and for a new printer object to be added to the **Printers and Faxes** folder. The time taken to copy varies based on the network traffic.

Close **My Network Places**.

- 4 Print a test page to verify installation.
  - a Click **start** (**Start** for Windows Server 2003 / Windows Server 2003 x64 Edition) → **Settings** (for Windows XP / Windows XP 64-bit Edition) → **Printers and Faxes**.
  - b Select the printer you have installed.
  - c Click **File** → **Properties**.
  - d On the **General** tab, click **Print Test Page**.

When a test page is printed successfully, installation is complete.

### For Windows Vista, Windows Vista 64-bit Edition

- 1 Click **Start** → **Network**.
- 2 Locate and double-click the host name of the server computer.
- 3 Right-click the shared printer name, and then click **Connect**.
- 4 Click **Install driver**.
- 5 Click **Continue** in **User Account Control** dialog box.

Wait until the driver is copied from the server to the client computer. A new printer object is added to the **Printers** folder. The duration of this procedure may vary based on the network traffic.

- 6 Print a test page to verify installation.
  - a Click **Start** → **Control Panel** → **Hardware and Sound**.
  - b Select **Printers**.
  - c Right-click the printer you just created and select **Properties**.
  - d On the **General** tab, click **Print Test Page**.When a test page is printed successfully, installation is complete.

**For Windows Server 2008, Windows Server 2008 64-bit Edition**

- 1 Click **Start** → **Network**.
- 2 Locate the host name of the server computer, and then double-click the host name.
- 3 Right-click the shared printer name, and then click **Connect**.
- 4 Click **Install driver**.
- 5 Wait until the driver is copied from the server to the client computer. A new printer object will be added to the **Printers** folder. The time taken for these activities varies based on network traffic.
- 6 Print a test page to verify installation.
  - a Click **Start** → **Control Panel**.
  - b Select **Printers**.
  - c Right-click the printer you just created and select **Properties**.
  - d On the **General** tab, click **Print Test Page**.When a test page is printed successfully, installation is complete.

**For Windows 7, Windows 7 64-bit Edition, Windows Server 2008 R2**

- 1 Click **Start** → your user name → **Network** (**Start** → **Network** for Windows Server 2008 R2)..
- 2 Locate the host name of the server computer, and then double-click the host name.
- 3 Right-click the shared printer name, and then click **Connect**.
- 4 Click **Install driver**.
- 5 Wait until the driver is copied from the server to the client computer. A new printer object will be added to the **Printers** folder. The time taken for these activities varies based on network traffic.
- 6 Print a test page to verify installation.
  - a Click **Start** → **Devices and Printers**.
  - b Right-click the printer you just created and select **Printer properties**.
  - c On the **General** tab, click **Print Test Page**.When a test page is printed successfully, installation is complete.

**For Windows 8, Windows 8 64-bit Edition, Windows Server 2012**

- 1 Point to the bottom right corner of the screen, and then click **Search** → Type **Network** in the search box, click **Apps**, and then click **Network**.
- 2 Locate the host name of the server computer, and then double-click the host name.
- 3 Right-click the shared printer name, and then click **Connect**.
- 4 Click **Install driver**.
- 5 Wait until the driver is copied from the server to the client computer. A new printer object will be added to the **Printers** folder. The time taken for these activities varies based on network traffic.

- 6 Print a test page to verify installation.
  - a Right-click the bottom left corner of the screen, and then click **Control Panel** → **Hardware and Sound** (**Hardware** for Windows Server 2012) → **Devices and Printers**.
  - b Right-click the printer you just created and select **Printer properties**.
  - c On the **General** tab, click **Print Test Page**.

When a test page is printed successfully, installation is complete.

## Peer-to-Peer

If you use the peer-to-peer method, the printer driver is installed on each client computer. The client computers can modify the drivers and handle the print jobs.

### For Windows XP, Windows XP 64-bit Edition, Windows Server 2003, Windows Server 2003 x64 Edition

- 1 Click **start** (**Start** for Windows Server 2003 / Windows Server 2003 x64 Edition) → **Settings** (for Windows XP / Windows XP 64-bit Edition) **Printers and Faxes**.
- 2 Click **Add a Printer** to launch the **Add Printer** wizard.
- 3 Click **Next**.
- 4 Select **A network printer, or a printer attached to another computer**, and then click **Next**. If the printer is not listed, type in the path of the printer in the text box.

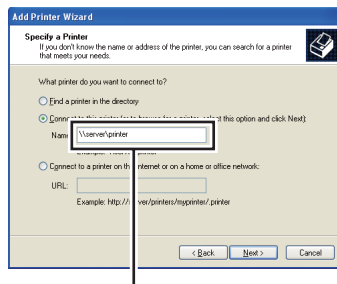

For example: \\<server host name>\<shared printer name>

The server host name is the name of the server computer that identifies it to the network. The shared printer name is the name assigned during the server installation process.

- 5 Click **Browse for a printer**, and then click **Next**.  
If this is a new printer, you may be prompted to install a printer driver. If no system driver is available, specify the location where the driver is available.
- 6 Select **Yes** if you want this printer to be set as the default printer, and then click **Next**.  
If you want to verify installation, click **Yes** to print a test page.
- 7 Click **Finish**.  
When a test page prints successfully, installation is complete.

### For Windows Vista, Windows Vista 64-bit Edition

- 1 Click **Start** → **Control Panel** → **Hardware and Sound** → **Printers**.
- 2 Click **Add a Printer** to launch the **Add Printer** wizard.

- 3 Select **Add a network, wireless or Bluetooth printer**, and then click **Next**. If the printer is listed, select the printer and click **Next**, or select **The printer that I want isn't listed** and type in the path of the printer in the **Select a shared printer by name** text box and click **Next**.

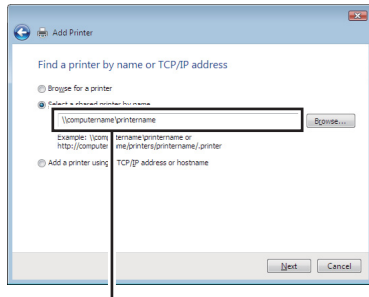

For example: \\<server host name>\<shared printer name>

The server host name is the name of the server computer that identifies it on the network. The shared printer name is the name assigned during the server installation process.

- 4 If this is a new printer, you may be prompted to install a printer driver. If no system driver is available, specify the location where the driver is available.
- 5 Select **Yes** if you want this printer to be set as the default printer, and then click **Next**.
- 6 If you want to verify installation, click **Print a test page**.
- 7 Click **Finish**.

When a test page is printed successfully, installation is complete.

#### **For Windows Server 2008, Windows Server 2008 64-bit Edition**

- 1 Click **Start** → **Control Panel** → **Printers**.
- 2 Click **Add a Printer** to launch the **Add Printer** wizard.
- 3 Select **Add a network, wireless or Bluetooth printer**, and then click **Next**. If the printer is listed, select the printer and click **Next**, or select **The printer that I want isn't listed** and type in the path of the printer in the **Select a shared printer by name** text box and click **Next**.

For example: \\<server host name>\<shared printer name>

The server host name is the name of the server computer that identifies it on the network. The shared printer name is the name assigned during the server installation process.

- 4 If this is a new printer, you may be prompted to install a printer driver. If no system driver is available, specify the location where the driver is available.
- 5 Select **Yes** if you want this printer to be set as the default printer, and then click **Next**.
- 6 If you want to verify installation, click **Print a test page**.
- 7 Click **Finish**.

When a test page is printed successfully, installation is complete.

#### **For Windows 7, Windows 7 64-bit Edition, Windows Server 2008 R2**

- 1 Click **Start** → **Devices and Printers**.
- 2 Click **Add a Printer** to launch the **Add Printer** wizard.

- 3 Select **Add a network, wireless or Bluetooth printer**. If the printer is listed, select the printer and click **Next**, or select **The printer that I want isn't listed**. Click **Select a shared printer by name** and type in the path of the printer in the text box, and then click **Next**.

For example: \\<server host name>\<shared printer name>

The server host name is the name of the server computer that identifies it to the network. The shared printer name is the name assigned during the server installation process.

- 4 If this is a new printer, you may be prompted to install a printer driver. If no system driver is available, you need to specify the path to the available drivers.
- 5 Confirm the printer name, and then click **Next**.
- 6 Select **Yes** if you want this printer to be set as the default printer, and then click **Next**.
- 7 If you want to verify installation, click **Print a test page**.
- 8 Click **Finish**.

When a test page is printed successfully, installation is complete.

#### **For Windows 8, Windows 8 64-bit Edition, Windows Server 2012**

- 1 Right-click the bottom left corner of the screen, and then click **Control Panel** → **Hardware and Sound** (**Hardware** for Windows Server 2012) → **Devices and Printers**.
- 2 Click **Add a Printer** to launch the **Add Printer** wizard.
- 3 Select **Add a network, wireless or Bluetooth printer**. If the printer is listed, select the printer and click **Next**, or select **The printer that I want isn't listed**. Click **Select a shared printer by name** and type in the path of the printer in the text box, and then click **Next**.

For example: \\<server host name>\<shared printer name>

The server host name is the name of the server computer that identifies it to the network. The shared printer name is the name assigned during the server installation process.

- 4 If this is a new printer, you may be prompted to install a printer driver. If no system driver is available, you need to specify the path to the available drivers.
- 5 Confirm the printer name, and then click **Next**.
- 6 Select **Yes** if you want this printer to be set as the default printer, and then click **Next**.
- 7 If you want to verify installation, click **Print a test page**.
- 8 Click **Finish**.

When a test page is printed successfully, installation is complete.



# Installing Printer Drivers on Computers Running Macintosh

## Installing the Drivers and Software

- 1 Run the *Software and Documentation* disc on the Macintosh computer.
- 2 Double-click the **Dell C1760/C1660 Installer** icon, and then click **Continue**.
- 3 Click **Continue** on the **Introduction** screen.
- 4 Click **Continue** on the **Important Information** screen.
- 5 Select a language for the Software License Agreement.
- 6 After reading the Software License Agreement, click **Continue**.
- 7 If you agree to the terms of the Software License Agreement, click **Agree** to continue the installation process.
- 8 Confirm the installation location, and then click **Continue**.
- 9 Click **Install** to perform the standard installation.
- 10 Type the administrator's name and password, and then click **Install Software**.
- 11 Click **Close** to complete installation.

## Adding a Printer on Mac OS X 10.5 or Later Version(s)

### When Using a USB connection

- 1 Turn on the printer.
- 2 Connect the USB cable between the printer and Macintosh computer.
- 3 Open the **System Preferences**, and click **Print & Fax** (**Print & Scan** for Mac OS X 10.7).
- 4 Click the Plus (+) sign, and click **Default**.
- 5 Select the printer connected via USB from the **Printer Name** list.  
Name and **Print Using** are automatically entered.
- 6 Click **Add**.

### When Using Bonjour

- 1 Turn on the printer.
- 2 Ensure that your Macintosh computer is connected to the network.  
If you use wired connection, connect the Ethernet cable between the printer and the network.  
If you use wireless connection, ensure that wireless connection is configured properly on your Macintosh computer and printer.
- 3 Open the **System Preferences**, and click **Print & Fax** (**Print & Scan** for Mac OS X 10.7).
- 4 Click the Plus (+) sign, and click **Default** (Click the Plus (+) sign, and select the printer from **Nearby Printers**. If there are no printers in **Nearby Printers**, select **Add Other Printer** or **Scanner** for Mac OS X 10.7).
- 5 Select the printer connected via Bonjour from the **Printer Name** list.  
Name and **Print Using** are automatically entered.
- 6 Click **Add**.

### When Using IP Printing

- 1 Turn on the printer.
- 2 Ensure that your Macintosh computer is connected to the network.  
If you use wired connection, connect the Ethernet cable between the printer and the network.  
If you use wireless connection, ensure that wireless connection is configured properly on your Macintosh computer and printer.
- 3 Open the **System Preferences**, and click **Print & Fax** (**Print & Scan** for Mac OS X 10.7).
- 4 Click the Plus (+) sign, and click **IP**.
- 5 Select **Line Printer Daemon - LPD** for **Protocol**.
- 6 Type the IP address for the printer in the **Address** area.
- 7 Select the model of your printer for **Print Using**.  
 **NOTE:** When the printing is set up using IP printing, the queue name is displayed as blank. You do not need to specify it.
- 8 Click **Add**.

### Adding a Printer on Mac OS X 10.4.11



#### When Using a USB Connection

- 1 Turn on the printer.
- 2 Connect the USB cable between the printer and Macintosh computer.
- 3 Start **Printer Setup Utility**.  
 **NOTE:** You can find **Printer Setup Utility** in the **Utilities** folder in **Applications**.
- 4 Click **Add**.
- 5 Click **Default Browser** in the **Printer Browser** dialog box.
- 6 Select the printer connected via USB from the **Printer Name** list.  
**Name** and **Print Using** are automatically entered.
- 7 Click **Add**.

#### When Using Bonjour

- 1 Turn on the printer.
- 2 Ensure that your Macintosh computer is connected to the network.  
If you use wired connection, connect the Ethernet cable between the printer and the network.  
If you use wireless connection, ensure that wireless connection is configured properly on your Macintosh computer and printer.
- 3 Start the **Printer Setup Utility**.  
 **NOTE:** You can find **Printer Setup Utility** in the **Utilities** folder in **Applications**.
- 4 Click **Add**.
- 5 Click **Default Browser** in the **Printer Browser** dialog box.
- 6 Select the printer connected via Bonjour from the **Printer Name** list.  
**Name** and **Print Using** are automatically entered.
- 7 Click **Add**.

### When Using IP Printing

- 1 Turn on the printer.
- 2 Ensure that your Macintosh computer is connected to the network.  
If you use wired connection, connect the Ethernet cable between the printer and the network.  
If you use wireless connection, ensure that wireless connection is configured properly on your Macintosh computer and printer.
- 3 Start **Printer Setup Utility**.  
 **NOTE:** You can find **Printer Setup Utility** in the **Utilities** folder in **Applications**.
- 4 Click **Add**.
- 5 Click **IP Printer** in the **Printer Browser** dialog box.
- 6 Select **Line Printer Daemon - LPD** for **Protocol**.
- 7 Type the IP address for the printer in the **Address** area.
- 8 Select the model of your printer for **Print Using**.  
 **NOTE:** When the printing is set up using IP printing, the queue name is displayed as blank. You do not need to specify it.
- 9 Click **Add**.



# Using Your Printer

11 Operator Panel .....	77
12 Dell™ Printer Configuration Web Tool.....	81
13 Understanding the Tool Box Menus.....	111
14 Understanding the Printer Menus.....	125
15 Print Media Guidelines.....	143
16 Loading Print Media .....	151



# Operator Panel

## Using the Operator Panel Buttons



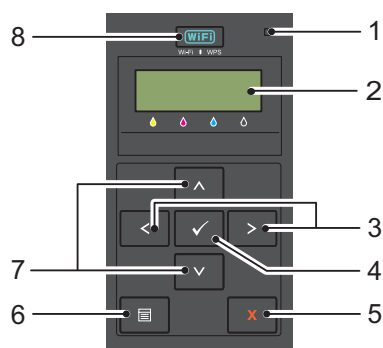

The operator panel has a liquid crystal display (LCD), seven buttons, and an indicator.



- 1 Ready/Error indicator
  - Lights up green when the printer is ready or sleeping and blinks when data is being received.
  - Lights up orange when an error occurs and blinks when an unrecoverable print error occurs.
- 2 LCD Panel
- 3 < > buttons
  - Selects submenus or setting values in the Menu mode.
- 4 ✓ (Set) button
  - Displays the selected menu or item and determines the selected value in the Menu mode.
- 5 ✕ (Cancel) button
  - Cancels the current print job.
  - Switches to the Print mode from the top menu of the Menu mode.
  - Switches to the upper hierarchy of the menu from the submenu of the Menu mode.
- 6 ☰ (Menu) button
  - Switches to the Menu mode from the Print mode.
  - Switches to the Print mode from the Menu mode.
- 7 ▲ ▼ buttons
  - Scrolls through menus or items in the Menu mode. To enter numbers or passwords, press these buttons.
- 8 WiFi (Wi-Fi | WPS) button
  - Starts Wi-Fi Protected Setup® (Push Button Configuration). Lights up when it is activated, and blinks in certain conditions.

## Status of Wi-Fi | WPS Button Backlight

This section describes when the backlight of the  (Wi-Fi | WPS) button lights up or blinks. For more information, see "Wireless Problems" on page 224.

Wi-Fi   WPS Button Backlight		Wireless LAN settings <sup>*1</sup>	Printer Status	Error Message
	Off	N/A	Connected to the network via Ethernet cable; Wi-Fi settings is not available when an Ethernet cable is connected to the printer.	-
		Disable	-	-
		Enable	The printer enters Sleep/Deep Sleep mode	-
	On	Enable	Wireless link established	-
	Blinking normal	Enable	Searching for wireless LAN access point or router	-
	Blinking slowly	Enable	Searching/Connecting with WPS access point or router during wireless operation	-
	Blinking fast	Enable	No wireless LAN access point or router found within the specified time	Wireless Timeout Error
			WPS Connection failure	WirelessDownload Error
			Wireless LAN access point or router found but connection error occurs (Passphrase error)	Wireless Password Error
			Detected WPS signals from multiple access points or routers during wireless operation (session overlap)	Wireless Session Overlap Error
			WPS Connection failure; Security setting of the wireless LAN access point or router is WEP, which is unsupported on WPS.	Wireless WEP AP Connected Error
			Wrong WEP key entered during the wireless setup	WEP Key Input Error

\*1 You can enable/disable the Wireless LAN settings. For more information, see "Wireless LAN" on page 127.



## Using the Operator Panel to Change Printer Settings

You can select menu items and corresponding values from the operator panel.







When you first enter the menus from the operator panel, you see an asterisk (\*) next to a value in the menus. This asterisk indicates the factory default menu setting. These settings are the original printer settings.

 **NOTE:** Factory defaults may vary for different countries.







When you select a new setting from the operator panel, an asterisk appears next to the setting to identify it as the current user default menu setting.

These settings are active until new ones are selected or the factory defaults are restored.



To select a new value as a setting:

- 1 Press the  (Menu) button.
- 2 Press the  or  button until the desired menu appears, and then press the  (Set) button.
- 3 Press the  or  button until the desired menu or menu item appears, and then press the  (Set) button.
  - If the selection is a menu, the menu is opened and the first system setting in the menu appears.
  - If the selection is a menu item, the default menu setting for the menu item appears.

Each menu item has a list of values for the menu item. A value can be:

- A phrase or word to describe a setting
  - A numerical value that can be changed
  - An On or Off setting
  - Press the  or  button at the same time. This will restore the factory default menu settings. Press the  (Set) button to return the settings to the factory default menu settings.
- 4 Press the  or  button to scroll until the desired value appears.
  - 5 Press the  (Set) button.

This enables the setting value, which is indicated by an asterisk (\*) next to the setting value.

- 6 Press the  (Cancel) or  button to return to the previous menu.

To continue setting other items, select the desired menu. To quit setting new values, press the  (Cancel) button.

Driver settings may have precedence over changes previously made. In such case, change the defaults of the operator panel.





## Printing a Device Settings Page

The device settings page shows current settings for the printer menus. For details about how to print a panel settings report, see "Understanding the Printer Menus" on page 125.

## Changing the Language

To display a different language on the operator panel:

### The Operator Panel

- 1 Press the  (Menu) button.
- 2 Press the  button until `Panel Language` appears, and then press the  (Set) button.
- 3 Press the  button until the desired language appears, and then press the  (Set) button.

### The Tool Box

- 1 Click `Start` → `All Programs` → `Dell Printers` → `Dell C1660w Color Printer` or `Dell C1760nw Color Printer` → `Tool Box`.









 **NOTE:** For details about starting the **Tool Box**, see "Starting the Tool Box" on page 111.

The **Tool Box** opens.

- 2 Click the **Printer Maintenance** tab.
- 3 Select **System Settings** from the list at the left side of the page.  
The **System Settings** page is displayed.
- 4 Select the desired language from **Panel Language**, and then click **Apply New Settings**.







## Setting the PowerSaver Time Option

You can set the powersaver time for the printer. The printer waits before it restores the default copy settings, if you do not start copying after changing them on the operator panel.

- 1 Press the  (Menu) button.
- 2 Press the  button until `Admin Menu` appears, and then press the  (Set) button.
- 3 Press the  button until `System Settings` appears, and then press the  (Set) button.
- 4 Ensure that `PowerSaver Time` appears, and then press the  (Set) button.
- 5 Press the  button to select `Sleep`, `Deep Sleep`, or `Auto-Off Timer`, and then press the  (Set) button.

When you select `Sleep` or `Deep Sleep`, go to step 7.

When you select `Auto-Off Timer`, go to step 6.

- 6 Press the  button to select `Off` or `On`, and then press the  (Set) button.  
If you select `Off`, go to step 8.
- 7 Press the  or  button or enter the desired value using the numeric keypad, and then press the  (Set) button.  
You can select from 5–30 minutes for `Sleep`, 1–6 minutes for `Deep Sleep`, or 60–1440 minutes for `Auto-Off Timer`.
- 8 Press the  (Cancel) or  button to return to the previous menu.

# Dell™ Printer Configuration Web Tool

 **NOTE:** The images used in this manual are those of the Dell C1760nw Color Printer unless otherwise mentioned.

## Overview

 **NOTE:** This web tool is available only when the printer is connected to a network.

One of the features of the Dell Printer Configuration Web Tool is the E-Mail Alert Setup, which sends an e-mail to you or the key operator when the printer needs supplies or intervention.

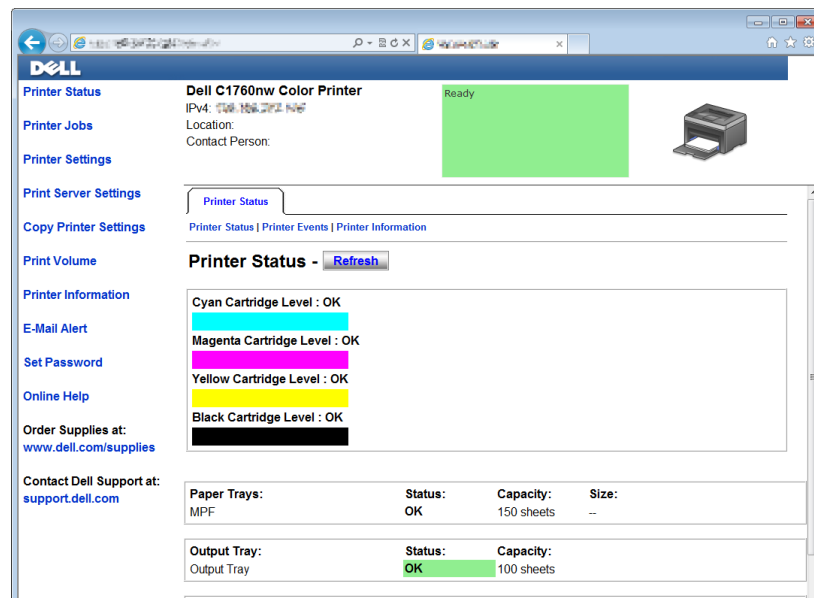

To fill out printer inventory reports requiring the asset tag number of all the printers in your area, use the **Printer Information** feature in the Dell Printer Configuration Web Tool. Enter the IP address of each printer on the network to display the asset tag number.

The Dell Printer Configuration Web Tool feature also allows you to change the printer settings and keep track of printing trends. If you are a network administrator, you can copy the printer settings to one or all printers on the network using your web browser.

## Setting Up the Dell Printer Configuration Web Tool

Ensure that you activate JavaScript in your browser before using the Dell Printer Configuration Web Tool.

It is recommended that you configure the environment settings of your web browser before using the Dell Printer Configuration Web Tool.

 **NOTE:** The Dell Printer Configuration Web Tool pages may be unreadable if the language differs from that of your web browser.

### Setting Up From Web Browser

It is recommended that you configure both the environment settings of your web browser and the operator panel before using the Dell Printer Configuration Web Tool.

## For Internet Explorer®

### *Setting Up the Display Language*

- 1 Select **Internet Options** from **Tools** on the menu bar.
- 2 Select **Languages** in the **General** tab.
- 3 Specify the display language in order of preference in the **Language** list.

For example:

- Italian (Italy) [it-IT]
- Spanish (Traditional Sort) [es-ES tradnl]
- German (Germany) [de-DE]
- French (France) [fr-FR]
- English (United States) [en-us]
- Danish [da-DK]
- Dutch (Netherlands) [nl-NL]
- Norwegian (Bokmal) [no]
- Swedish [sv-SE]

### *Setting the IP Address of the printer to Non-Proxy*

- 1 Select **Internet Options** from the **Tools** menu.
- 2 Click **LAN Settings** under **Local Area Network (LAN)** settings in the **Connections** tab.
- 3 You can configure the LAN settings in one of the following ways:
  - Clear the **Use a proxy server for your LAN** check box under **Proxy server**.
  - Click **Advanced**, and then specify the IP address of your printer in the **Do not use proxy server for addresses beginning with field** under **Exceptions**.

After setting the language and proxy, enter `<http://nnn.nnn.nnn.nnn/>` (the IP address of your printer) in the URL entry field of the browser to activate the **Dell Printer Configuration Web Tool**.

## For Firefox®

### *Setting Up the Display Language*

- 1 Select **Options** from the **Tools** menu.
- 2 Click **Choose** in the **Content** tab.
- 3 Specify the display language in order of preference in the **Languages in order of preference** list.

For example:

- English [en] or English/United States [en-us]
- Italian [it]
- Spanish [es]
- German [de]
- French [fr]
- Dutch [nl]
- Norwegian [no]
- Swedish [sv]
- Danish [da]

### **Setting the IP Address of the printer to Non-Proxy**

- 1 Select **Options** from the **Tools** menu.
- 2 Click **Advanced** tab.
- 3 Click **Network** on the **Options** dialog box.
- 4 Click **Connection** → **Settings**.
- 5 You can configure the LAN settings in one of the following ways:
  - Select the **No Proxy** check box, if you do not want to use a proxy.
  - Select the **Auto-detect proxy settings for this network** check box.
  - Select the **Manual proxy configuration:** check box, and then enter a hostname and a port number if you have a list of one or more proxy servers. If you have an IP address that does not use a proxy, enter the IP address of your printer in the **No Proxy for:** edit box.
  - Select the **Automatic proxy configuration URL:** check box.

After setting the language and proxy, enter <http://nnn.nnn.nnn.nnn/> (the IP address of your printer) in the URL entry field of the browser to activate the **Dell Printer Configuration Web Tool**.

### **Setting Up From Operator Panel**

You can launch the **Dell Printer Configuration Web Tool** only when EWS is set to **Enable** (the factory default) on the operator panel. Check the operator panel setting if you cannot launch the **Dell Printer Configuration Web Tool**. For more information, see "Understanding the Printer Menus" on page 125.

## **Starting the Dell Printer Configuration Web Tool**

To launch the **Dell Printer Configuration Web Tool**, enter the IP address of your printer in your web browser.



If you do not know the IP address of your printer, print the printer settings report or display the **TCP/IP Settings** page, which lists the IP address. For details about how to find your printer's IP address, see "Verifying the IP Settings" on page 41.

## **Overview of the Menu Items**

Use the **Dell Printer Configuration Web Tool** for:

### **Printer Status**

Use the **Printer Status** menu to get feedback on the printer status. When a toner cartridge is running low, click the **order supplies** link on the first screen to order an additional toner cartridge.

### **Printer Jobs**

Use the **Printer Jobs** menu to contain information on the **Job List** page and **Completed Jobs** page. These pages show the details of the status regarding each protocol or job.

### **Printer Settings**

Use the **Printer Settings** menu to change printer settings and view the settings in the operator panel remotely.

### **Print Server Settings**

Use the **Print Server Settings** menu to change the type of printer interface and necessary conditions for communications.

### **Copy Printer Settings**

Use the **Copy Printer Settings** menu to copy the printer settings to another printer or printers on the network by entering the IP address of each printer.

 **NOTE:** You must log in as an administrator to use this feature.

### **Print Volume**

Use the **Print Volume** option to check the number of pages printed for each paper size.

### **Printer Information**

Use the **Printer Information** menu to display the information of your printer.

### **E-Mail Alert**

Use the **E-Mail Alert** menu to receive an e-mail when the printer needs supplies or intervention. Enter your name or the key operator name in the e-mail list box to be notified.

### **Set Password**

Use the **Set Password** menu to lock the **Dell Printer Configuration Web Tool** with a password so that other users do not inadvertently change the printer settings you selected.

 **NOTE:** You must log in as an administrator to use this feature.

### **Online Help**

Click **Online Help** to visit the Dell Support web site.

### **Order Supplies at:**

[www.dell.com/supplies](http://www.dell.com/supplies)

### **Contact Dell Support at:**

[support.dell.com](http://support.dell.com)

# Page Display Format

The layout of the page is divided into three sections.

## Top Frame

The top frame is located on the top of all pages. When the **Dell Printer Configuration Web Tool** is activated, the current status and specifications of the printer are displayed in the top frame on every page.

The following items are displayed in the top frame.

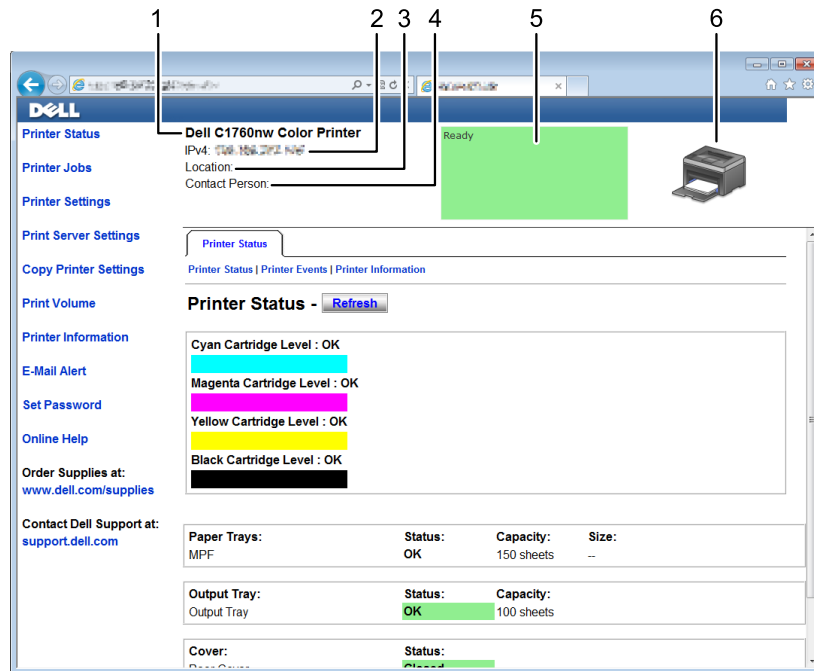

1	Dell C1760nw Color Printer	Displays the printer model name.
2	IP Address	Displays the IP address of your printer.
3	Location	Displays the location of the printer. The location can be changed in the <b>Basic Information</b> on the <b>Print Server Settings</b> page.
4	Contact Person	Displays the administrator name of the printer. The name can be changed in the <b>Basic Information</b> on the <b>Print Server Settings</b> page.
5	Event Panel	Displays the condition of the printer. If an error occurs, the error code and message are displayed. For example, 077-090:Paper jam. Open...
6	Printer Bitmap	Shows the bitmap image of the printer. The <b>Printer Status</b> menu appears in the right frame when you click the image.

## Left Frame

The left frame is located on the left side of all pages. The menu titles displayed in the left frame are linked to corresponding menus and pages. You can go to the corresponding page by clicking their characters.

The following menus are displayed in the left frame.

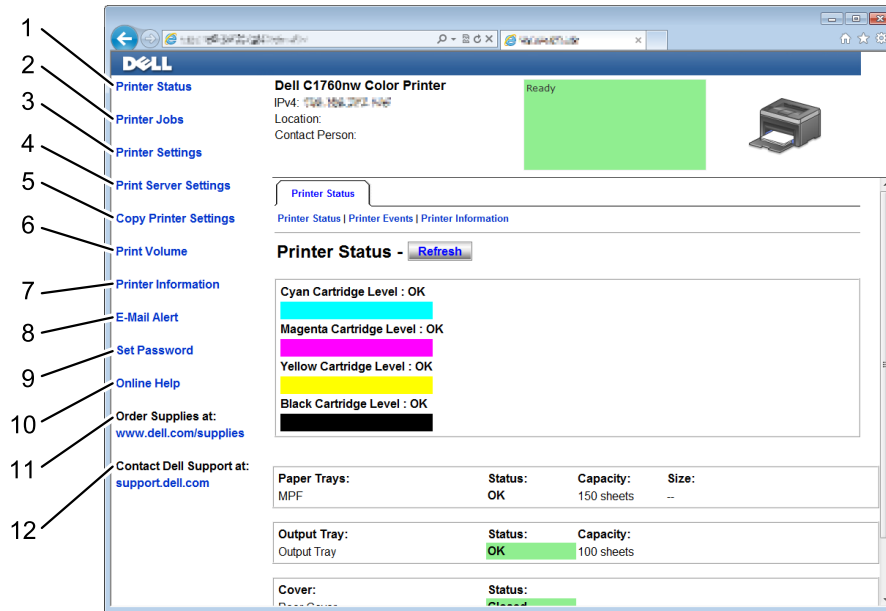

1	Printer Status	Links to the Printer Status menu.
2	Printer Jobs	Links to the Printer Jobs menu.
3	Printer Settings	Links to the Printer Settings Report menu.
4	Print Server Settings	Links to the Print Server Reports menu.
5	Copy Printer Settings	Links to the Copy Printer Settings menu.
6	Print Volume	Links to the Print Volume menu.
7	Printer Information	Links to the Printer Status menu.
8	E-Mail Alert	Links to the Print Server Settings menu.
9	Set Password	Links to the Security menu.
10	Online Help	Links to the Dell Support website.
11	Order Supplies at:	Links to the Dell web page.
12	Contact Dell Support at:	Links to the Dell support page web address: <a href="http://support.dell.com">support.dell.com</a>



## Right Frame

The right frame is located on the right side of all pages. The contents of the right frame correspond to the menu that you select in the left frame. For details on the items displayed in the right frame, see "Details of the Menu Items" on page 88.

## Buttons in the Right Frame

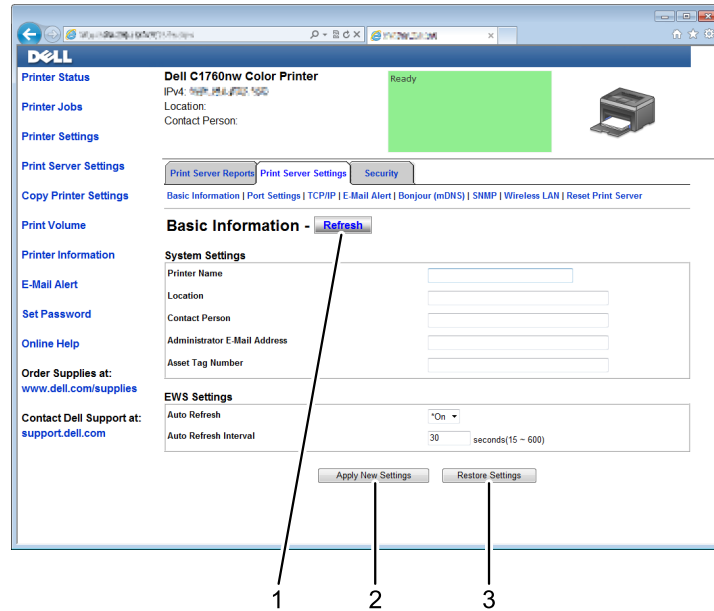

1	Refresh button	Receives the current printer configuration and updates the latest information in the right frame.
2	Apply New Settings button	Submits new settings made on the Dell Printer Configuration Web Tool to the printer. The new settings replace the old settings of the printer.
3	Restore Settings button	Restores the old settings. New settings will not be submitted to the printer.

## Changing the Settings of the Menu Items

Some menus allow you to change the printer settings access through the **Dell Printer Configuration Web Tool**. When you access these menus, the authentication window appears on the screen. Enter a user name and password of the administrator by following the prompts displayed in the dialog box.

The default user name is **admin**, and the default password is left blank (NULL). You can change only the password in the **Set Password** page in the **Security** menu. For more information, see "Set Password" on page 109.

### Details of the Menu Items

"Printer Status"	"Printer Status"
	"Printer Events"
	"Printer Information"
"Printer Jobs"	"Job List"
	"Completed Jobs"
"Printer Settings"	"Printer Settings Report"
	"Printer Settings"
"Printer Maintenance"	"Menu Settings"
	"Reports"
	"System Settings"
	"USB Settings"
	"Secure Settings"
	"Paper Density"
	"Adjust BTR"
	"Adjust Fusing Unit"
	"Auto Registration Adjustment"
	"Color Registration Adjustments"
	"Clean Developer"
	"BTR Refresh"
	"Maintenance Chart"
	"Reset Defaults"
"Non-Dell Toner"	
"Adjust Altitude"	
"Web Link Customization"	

"Print Server Settings"	"Print Server Reports"	"Print Server Setup Page"
		"E-Mail Alert Setup Page"
	"Print Server Settings"	"Basic Information"
		"Port Settings"
		"TCP/IP"
		"E-Mail Alert"
		"Bonjour (mDNS)"
		"SNMP"
		"Wireless LAN" <sup>*1</sup>
	"Security"	"Reset Print Server"
		"Set Password"
		"IP Filter (IPv4)"
"Copy Printer Settings"		"Copy Printer Settings"
		"Copy Printer Settings Report"
"Print Volume"		"Print Volume"

\*1 This item is available only when the printer is connected with a wireless network.

## Printer Status

Use the **Printer Status** menu to check the status of consumables, hardware, and specifications of the printer. The following pages are displayed in the **Printer Status** menu.

### Printer Status

#### Purpose:

To check the status of the consumables and trays.

#### Values:

Cyan Cartridge Level			Displays the percentage of toner remaining in each toner cartridge. When a cartridge is empty, a message appears. The text <i>Call or Order</i> is linked to the Dell Printer Supplies website.
Magenta Cartridge Level			
Yellow Cartridge Level			
Black Cartridge Level			
Paper Trays	Status	OK	Indicates that there is some paper in the tray but the quantity is unknown.
		Add Paper	Indicates that there is no paper in the tray.
	Capacity		Displays the maximum capacity of the output tray.
	Size		Displays the size of paper in the tray.
Output Tray	Status	OK	Indicates that the tray is available.
	Capacity		Displays the maximum capacity of the output tray.
Cover	Status	Closed	Indicates that the cover is closed.
		Open	Indicates that the cover is open.
Printer Type			Displays the type of the printer. <b>Color Laser</b> is displayed normally.
Printing Speed			Displays the printing speed.

## Printer Events

### Purpose:

When faults such as *Out of Paper* or *Rear Cover is Open* occur, the details of all alerts or indications of faults are displayed in the **Printer Events** page.

### Values:

Location	Displays the location where the error occurred.
Details	Displays the details of the error.

## Printer Information

### Purpose:

To display the system information of the printer. This page can also be displayed by clicking **Printer Information** in the left frame.

### Values:

Dell Service Tag Number	Displays Dell's service tag number.
Express Service Code	Displays the express service code of the printer.
Asset Tag Number	Displays the asset tag number of the printer.
Printer Serial Number	Displays the serial number of the printer.
Memory Capacity	Displays the memory capacity.
Processor Speed	Displays the processing speed.
Printer Revision Levels	<b>Firmware Version</b> Displays the version of the controller.
	<b>Network Firmware Version</b> Displays the NIC version.

## Printer Jobs

The **Printer Jobs** menu contains information on the **Job List** and **Completed Jobs** pages. These pages show the details of the status regarding each protocol or the print jobs.

### Job List

#### Purpose:

To confirm the print jobs that are being processed. Click **Refresh** to update the screen.

#### Values:

ID	Displays the job ID.
Job Name	Displays the file name of the job being printed.
Owner	Displays the name of the job owner.
Host Name	Displays the name of the host computer.
Job Status	Displays the status of the job being printed.
Host I/F	Displays the status of the host interface.
Job Submitted Time	Displays the date when the print job was submitted.

## Completed Jobs

### Purpose:

To check the completed jobs. Up to 10 latest print jobs are displayed. Click **Refresh** to update the screen.

### Values:

ID	Displays the job ID.
Job Name	Displays the file name of the job.
Owner	Displays the name of the job owner.
Host Name	Displays the name of the host computer.
Output Result	Displays the status of the job.
Impression Number	Displays the total number of pages used by the print job.
No. of Sheets	Displays the total number of sheets used by the print job.
Host I/F	Displays the status of the host interface.
Job Submitted Time	Displays the date when the job was submitted.

## Printer Settings

Use the **Printer Settings** menu to display the **Printer Settings Report** and to configure the printer settings.

The following tabbed pages are displayed at the top of the right frame.

### Printer Settings Report

The **Printer Settings Report** tab contains the **Menu Settings** and **Reports** pages.

#### *Menu Settings*

### Purpose:

To display the current settings of your printer.

### Values:

System Settings	Power Saver Time - Sleep	Displays the time taken by the printer before it enters Sleep mode after it finishes a job.
	Power Saver Time - Deep Sleep	Displays the time taken by the printer before it enters Deep Sleep mode after it goes into Sleep mode.
	Power Saver Time - Auto-Off Timer <sup>*1</sup>	Displays the time taken by the printer to be turned off after it has entered Deep Sleep mode.
	Fault Time-Out	Displays the time taken by the printer before it cancels jobs that stop abnormally.
	Job Time-Out	Displays the amount of time that the printer waits for data to arrive from the computer.
	mm/inch	Displays the measurement unit used after the numeric value on the operator panel.
	Default Paper Size	Displays the default paper size.
	Disable printing with larger paper size	Displays whether to disable printing if the paper size set in the printer driver and the paper size set in the tray of the printer does not match (the paper set in the tray is larger).

	Auto Log Print	Displays whether to automatically print a job history report after every 10 jobs.
	Low Toner Alert Msg	Displays whether to show the alert message when the toner is low.
	Panel Language	Displays the language used on the operator panel.
USB Settings	USB Port	Displays whether the USB interface is enabled.
Secure Settings	Panel Lock Set	Displays whether to limit access to the menus with a password.
	Login Error - Attempts	Displays the maximum number that the administrator fails to log in.
	Software Download	Displays whether to enable download of software updates.
Paper Density	Plain	Displays the paper density of plain paper.
	Label	Displays the paper density of labels.
Adjust BTR	Plain	Displays the voltage setting of the transfer roller for plain paper.
	Plain Thick	Displays the voltage setting of the transfer roller for thick plain paper.
	Covers	Displays the voltage setting of the transfer roller for cover paper.
	Label	Displays the voltage setting of the transfer roller for labels.
	Coated	Displays the voltage setting of the transfer roller for coated paper.
	Envelope	Displays the voltage setting of the transfer roller for envelopes.
	Recycled	Displays the voltage setting of the transfer roller for recycled paper.
Adjust Fusing Unit	Plain	Displays the temperature setting of the fusing unit for plain paper.
	Plain Thick	Displays the temperature setting of the fusing unit for thick plain paper.
	Covers	Displays the temperature setting of the fusing unit for cover paper.
	Label	Displays the temperature setting of the fusing unit for labels.
	Coated	Displays the temperature setting of the fusing unit for coated paper.
	Envelope	Displays the temperature setting of the fusing unit for envelopes.
	Recycled	Displays the temperature setting of the fusing unit for recycled paper.
Auto Registration Adjustment		Displays whether to automatically adjust color registration.
Adjust Altitude		Displays the altitude of the location where the printer is installed.
BTR Refresh		Displays whether to execute counter measures for curling/separating discharge of the paper.
Non-Dell Toner		Displays whether to use toner cartridge of another manufacturer.
Web Link Customization	Select Reorder URL	Displays a link used for ordering consumables, which can be accessed from <b>Order Supplies at:</b> in the left frame.
	Regular	Displays the regular web address ( <a href="http://accessories.us.dell.com/sna">http://accessories.us.dell.com/sna</a> ) that can be linked to <b>Order Supplies at:</b>
	Premier	Displays the premier web address ( <a href="http://premier.dell.com">http://premier.dell.com</a> ) that can be linked to <b>Order Supplies at:</b>

\*1 Auto-Off Timer feature is available only in certain regions.

## Reports

### Purpose:

To print the settings and history information of your printer.

### Values:

Printer Settings	Click <b>Start</b> to print the printer settings page.
Device Settings	Click <b>Start</b> to print the device settings page.
Job History	Click <b>Start</b> to print the Job History report.
Error History	Click <b>Start</b> to print the Error History report.
Color Test Page	Click <b>Start</b> to print the Color Test Page.

## Printer Settings

The Printer Settings tab contains the System Settings, USB Settings, and Secure Settings pages.

### System Settings

#### Purpose:

To configure the basic printer settings.

#### Values:

Power Saver Time - Sleep <sup>*1</sup>	Specifies the time taken by the printer before it enters Sleep mode after it finishes a job.
Power Saver Time - Deep Sleep	Specifies the time taken by the printer before it enters Deep Sleep mode after it goes into Sleep mode.
Power Saver Time - Auto-Off Timer <sup>*2</sup>	Specifies the time it takes to automatically turn off the printer after it has entered Deep Sleep mode.
Fault Time-Out	Specifies the time taken by the printer before it cancels jobs that stop abnormally. The print job is cancelled if it times out.
Job Time-Out	Specifies the amount of time that the printer waits for data to arrive from the computer. The print job is cancelled if it times out.
mm / inch <sup>*3</sup>	Specifies the measurement unit displayed after the numeric value on the operator panel.
Default Paper Size	Specifies the default paper size.
Disable printing with larger paper size <sup>*4</sup>	Specifies whether to print jobs if the paper set in the tray of the printer is larger than the paper size set in the printer driver (the paper size does not have to match).
Auto Log Print	Specifies if a job history needs to be printed after every 10 jobs.
Low Toner Alert Msg	Alerts you if the toner is low.
Panel Language	Used to set the language on the operator panel.

<sup>\*1</sup> Enter 5 in **Sleep** to put the printer in the Sleep mode five minutes after it finishes a job. This uses less energy, but requires more warm-up time for the printer. Enter 5 if your printer shares an electrical circuit with room lighting and you notice lights flickering. Select a high value if your printer is in constant use. In most circumstances, this keeps the printer ready to operate with minimum warm-up time. Select a value between 5 and 30 minutes for the Sleep mode if you want a balance between energy consumption and a shorter warm-up period.

The printer automatically returns to the standby mode from the Sleep mode when it receives data from the computer. You can also return the printer to the standby mode by pressing any button on the operator panel.

<sup>\*2</sup> Auto-Off Timer feature is available only in certain regions.

<sup>\*3</sup> The default for **mm/inch** and **Default Paper Size** vary depending on country-specific factory default.

<sup>\*4</sup> **Disable printing with larger paper size** is available only in the **Dell Printer Configuration Web Tool** and the **Tool Box**.

### ***USB Settings***

#### **Purpose:**

To change the USB settings on your printer.

#### **Values:**

---

USB Port	To enable the USB interface on your printer.
----------	--

---

### ***Secure Settings***

#### **Panel Lock**

#### **Purpose:**

To restrict access to Admin Menu and Report/List with a password, and to set or change the password.

 **NOTE:** This menu sets a password to lock the operator panel. When you change the password for the **Dell Printer Configuration Web Tool**, click **Set Password** on the left frame and set the password.

#### **Values:**

---

Panel Lock Set	Restricts access to Admin Menu and Report/List with a password.
New Password	Sets a password required to access Admin Menu and Report/List.
Re-enter Password	Enter the new password again to confirm.

---

### ***Login Error***

#### **Purpose:**

To set the maximum number of failed login attempts before an administrator is denied access to Admin Menu and Report/List.

 **NOTE:** This item is available only when **Panel Lock Set** is set to **Enable**.

### ***Software Download***

#### **Purpose:**

To set whether to enable download of software updates.

### **Printer Maintenance**

The Printer Maintenance tab contains the Paper Density, Adjust BTR, Adjust Fusing Unit, Auto Registration Adjustment, Color Registration Adjustments, Clean Developer, BTR Refresh, Maintenance Chart, Reset Defaults, Non-Dell Toner, Adjust Altitude, and Web Link Customization pages.

### ***Paper Density***

#### **Purpose:**

To specify the paper density.

#### **Values:**

---

Plain	Sets the paper density of plain paper.
Label	Sets the paper density of labels.

---



### ***Adjust BTR***

#### **Purpose:**

To specify the optimum voltage settings for printing for the transfer roller (BTR). To decrease the voltage, set negative values. To increase the voltage, set positive values.

The default settings may not give the best output on all paper types. If you see mottles on the print output, try to increase the voltage. If you see white spots on the print output, try to decrease the voltage.

 **NOTE:** The print quality changes depending on the values you select for this item.

#### **Values:**

Plain	Sets the reference voltage setting for the transfer roller for plain paper within the range of -3 to 3.
Plain Thick	Sets the reference voltage setting for the transfer roller for thick plain paper within the range of -3 to 3.
Covers	Sets the reference voltage setting for the transfer roller for cover paper within the range of -3 to 3.
Label	Sets the reference voltage setting for the transfer roller for labels within the range of -3 to 3.
Coated	Sets the reference voltage setting for the transfer roller for coated paper within the range of -3 to 3.
Envelope	Sets the reference voltage setting for the transfer roller for envelopes within the range of -3 to 3.
Recycled	Sets the reference voltage setting for the transfer roller for recycled paper within the range of -3 to 3.

### ***Adjust Fusing Unit***

#### **Purpose:**

To specify the optimum temperature settings for printing for the fusing unit. To decrease the temperature, set negative values. To increase the temperature, set positive values.

The default settings may not give the best output on all paper types. When the printed paper has curled, try to decrease the temperature. When the toner does not fuse on the paper properly, try to increase the temperature.

 **NOTE:** The print quality changes depending on the values you select for this item.

#### **Values:**

Plain	Sets the temperature settings for the fusing unit for plain paper within the range of -3 to 3.
Plain Thick	Sets the temperature settings for the fusing unit for thick plain paper within the range of -3 to 3.
Covers	Sets the temperature settings for the fusing unit for cover paper within the range of -3 to 3.
Label	Sets the temperature settings for the fusing unit for labels within the range of -3 to 3.
Coated	Sets the temperature settings for the fusing unit for coated paper within the range of -3 to 3.
Envelope	Sets the temperature settings for the fusing unit for envelopes within the range of -3 to 3.
Recycled	Sets the temperature settings for the fusing unit for recycled paper within the range of -3 to 3.

### ***Auto Registration Adjustment***

#### **Purpose:**

To specify whether to automatically adjust color registration.

### ***Color Registration Adjustments***

#### **Purpose:**

To specify whether to manually adjust color registration.

Color registration adjustments need to be made during the initial setup of the printer or when the printer is moved to a different location.

 **NOTE:** The **Color Registration Adjustments** feature can be configured when **Auto Registration Adjustment** is set to **Off**.

#### **Values:**

<b>Auto Correct</b>	Click <b>Start</b> to automatically correct color registration.	
<b>Color Regi Chart</b>	Click <b>Start</b> to print a color registration chart. The color registration chart prints a lattice pattern of yellow, magenta, and cyan lines. On the chart, find the values on the right side that are next to the line that is perfectly straight for each of the three colors. If the value for this line is 0, color registration is not needed. If the value for this line is any value other than 0, specify the adjustment values under <b>Color Registration Adjustments</b> .	
<b>Color Registration Adjustments</b>	<b>Enter Number</b>	Specifies lateral (perpendicular to paper feed direction) and process (paper feed direction) color adjustment values individually for Y (Yellow), M (Magenta), C (Cyan), LY (Left Yellow), LM (Left Magenta), LC (Left Cyan), RY (Right Yellow), RM (Right Magenta), and RC (Right Cyan) within the range of -5 to +5.

### ***Clean Developer***

#### **Purpose:**

To rotate the developer motor and stir the toner in the toner cartridge, to use up a toner cartridge when you need to replace it before the end of its life, or to stir the toner in a new toner cartridge.

#### **Values:**

<b>Clean Developer</b>	Click <b>Start</b> to stir the toner in the toner cartridge.
<b>Yellow Toner Refresh</b>	Click <b>Start</b> to clean the toner in the yellow toner cartridge.
<b>Magenta Toner Refresh</b>	Click <b>Start</b> to clean the toner in the magenta toner cartridge.
<b>Cyan Toner Refresh</b>	Click <b>Start</b> to clean the toner in the cyan toner cartridge.
<b>Black Toner Refresh</b>	Click <b>Start</b> to clean the toner in the black toner cartridge.

### ***BTR Refresh***

#### **Purpose:**

To specify whether to automatically execute counter measures for curling/separating discharge of the paper.

### ***Maintenance Chart***

#### **Purpose:**

To print various charts that can be used for diagnosing your printer.

#### **Values:**

---

Ghost	Click <b>Start</b> to print a chart to check for ghost printing.
4Colors	Click <b>Start</b> to print bands of yellow, magenta, cyan, and black with varying density.
Alignment	Click <b>Start</b> to print a chart, and then check for proper alignment of the print image on the paper.
Drum Refresh	Click <b>Start</b> to print a chart to check the light fatigue of the drum cartridge.

---

### ***Reset Defaults***

#### **Purpose:**

To initialize NVM (non-volatile memory) for system parameters. After executing this function and rebooting the printer, all the menu parameters, except the parameters for the network, are reset to their default values.

#### **Values:**

---

Reset Defaults and restart printer.	Click <b>Start</b> to initialize the system parameters.
-------------------------------------	---

---

### ***Non-Dell Toner***

#### **Purpose:**

To use toner cartridge of another manufacturer.



**NOTE:** Using non-Dell-brand toner cartridges may make some printer features unusable, reduce print quality and decrease the reliability of your printer. Dell recommends only new Dell-brand toner cartridges for your printer. Dell does not provide warranty coverage for problems caused by using accessories, parts, or components not supplied by Dell.



**NOTE:** Before you use toner cartridge of another manufacturer, be sure to restart the printer.

### ***Adjust Altitude***

#### **Purpose:**

To specify the altitude of the location where the printer is installed.

The discharge phenomenon for charging the photo conductor varies with barometric pressure. Adjustments are performed by specifying the altitude of the location where the printer is being used.



**NOTE:** An incorrect altitude adjustment setting leads to poor printing quality, incorrect indication of remaining toner.

### ***Web Link Customization***

#### **Purpose:**

To specify a link used for ordering consumables, which can be accessed from **Order Supplies at:** in the left frame.

#### **Values:**

Select Reorder URL	Select <b>Regular</b> or <b>Premier</b> web address to be linked to <b>Order Supplies at:</b>
Regular	Displays the regular web address ( <a href="http://accessories.us.dell.com/sna">http://accessories.us.dell.com/sna</a> ) that can be linked to <b>Order Supplies at:</b>
Premier	Displays the premier web address ( <a href="http://premier.dell.com">http://premier.dell.com</a> ) that can be linked to <b>Order Supplies at:</b>

### **Print Server Settings**

Use the **Print Server Settings** menu to set the type of printer interface and necessary conditions for communications.

The following tabbed pages are displayed in the top of the right frame.

#### **Print Server Reports**

The **Print Server Reports** tab contains the **Print Server Setup Page** and **E-Mail Alert Setup Page**.

#### ***Print Server Setup Page***

#### **Purpose:**

To verify the current settings of TCP/IP (Transmission Control Protocol/Internet Protocol) and printing ports. On this page, you can only verify the settings of items. If you want to change the settings, go to the pages in the **Print Server Settings** tab.

#### **Values:**

Ethernet <sup>*1</sup>	Ethernet Settings	Displays the current settings of Ethernet transmission rate and the duplex settings.
	Current Ethernet Settings	Displays the current Ethernet settings.
	MAC Address	Displays the Media Access Control (MAC) address of the printer.
Wireless Settings <sup>*2</sup>	Wireless LAN	Displays whether to enable wireless connection.
	SSID	Displays the name that identifies the network.
	Network Type	Displays the network type from either the Ad-Hoc or Infrastructure mode.
	MAC Address	Displays the MAC address of the wireless printer setting.
	Link Channel	Displays the channel number of the connection.
	Link Quality	Displays the quality of the connection.

TCP/IP Settings	IP Mode	Displays the IP mode.		
	Host Name	Displays the host name.		
	IPv4 <sup>*3</sup>	IP Address Mode	Displays the IP address mode.	
		IP Address	Displays the IP address.	
		Subnet Mask	Displays the subnet mask.	
		Gateway Address	Displays the gateway address.	
	IPv6 <sup>*4</sup>	Enable Stateless Address	Displays whether to enable the stateless address.	
		Use Manual Address	Displays whether to set the IP address manually.	
		Manual Address <sup>*5</sup>	Displays the IP address.	
		Stateless Address 1-3 <sup>*6</sup>	Displays the stateless addresses.	
		Link Local Address <sup>*6</sup>	Displays the link local address.	
		Manual Gateway Address <sup>*5</sup>	Displays the gateway address.	
		Auto Configure Gateway Address <sup>*6</sup>	Displays the gateway address.	
DNS	IPv4 <sup>*3</sup>	Get DNS Server Address from DHCP	Displays if the printer receives the DNS server address automatically from the DHCP server.	
		Current DNS Server Address	Displays the DNS server address.	
	IPv6 <sup>*4</sup>	Get DNS Server Address from DHCPv6-lite	Displays if the printer receives the DNS server address automatically from the DHCPv6-lite server.	
		Current DNS Server Address	Displays the DNS server address.	
		Priority to IPv6 DNS Name Resolution <sup>*7</sup>	Displays whether to use the DNS Name Resolution feature.	
LPD	Port Status	Displays the port status.		
	Connection Time-Out	Displays the connection time-out period.		
Port9100	Port Status	Displays the port status.		
	Port Number	Displays the port number.		
	Connection Time-Out	Displays the connection time-out period.		
WSD	Port Status	Displays the WSD (Web Services on Devices) port status.		
	Port Number	Displays the WSD port number.		
	Receive Time-Out	Displays the receive time-out period.		
	Notification Time-Out	Displays the notification time-out period.		
	Maximum Number of TTL	Displays the maximum number of TTLs.		
	Maximum Number of Notification	Displays the maximum number of notifications.		
HTTP	Port Status	Displays the port status.		
	Port Number	Displays the port number.		
	Simultaneous Connections	Displays the number of connections received simultaneously by the client.		
	Connection Time-Out	Displays the connection time-out period.		

Bonjour (mDNS)	Port Status	Displays the port status.
	Host Name	Displays the host name.
	Printer Name	Displays the printer name.
SNMP	Port Status	Displays the port status.
IP Filter (IPv4) *8	Address	Displays the list of IP addresses that are permitted or denied access to the printer.
	Address Mask	Displays the list of subnet mask that are permitted or denied access to the printer.
	Active Mode	Displays whether to be permitted or denied access to the printer.

\*1 This item is available only when the printer is connected with a wired network.

\*2 This item is available only when the printer is connected with a wireless network.

\*3 This item is displayed when IPv4 or Dual Stack Mode is selected.

\*4 This item is displayed when IPv6 or Dual Stack Mode is selected.

\*5 This item is displayed only when **Use Manual Address** is Enable.

\*6 This item is displayed only when an IP address has been assigned.

\*7 This item is available only when using IPv6 dual mode.

\*8 This item is only available for LPD or Port9100.

### ***E-Mail Alert Setup Page***

#### **Purpose:**

To verify the current settings of SMTP/POP (Simple Mail Transfer Protocol/Post Office Protocol) used for the e-mail feature and e-mail alert feature. In this page, you can only verify the settings of items. If you want to change the settings, go to the pages in the **Print Server Settings** tab.

#### **Values:**

E-Mail Server Settings	Port Status	Displays the port status.
	Primary SMTP Gateway	Displays the primary SMTP gateway.
	SMTP Port Number	Displays the SMTP port number.
	E-Mail Send Authentication	Displays the authentication method for outgoing e-mail.
	POP3 Server Address	Displays the POP3 server address.
	POP3 Port Number	Displays the POP3 port number.
	Reply Address	Displays the reply e-mail address sent with each e-mail alert.
	SMTP Server Connection	Displays the status of the SMTP server connection.

E-Mail Alert Settings	E-Mail List 1	Displays the acceptable e-mail addresses for the e-mail alert feature specified in <b>E-Mail List 1</b> .	
	Select Alerts for List 1	Supplies Alerts	Displays the e-mail alert receive status for consumables.
		Paper Handling Alerts	Displays the e-mail alert receive status for paper handling.
		Service Call	Displays the e-mail alert receive status for service calls.
	E-Mail List 2	Displays the acceptable e-mail addresses for the e-mail alert feature specified in <b>E-Mail List 2</b> .	
	Select Alerts for List 2	Supplies Alerts	Displays the e-mail alert receive status for consumables.
Paper Handling Alerts		Displays the e-mail alert receive status for paper handling.	
Service Call		Displays the e-mail alert receive status for service calls.	

### Print Server Settings

The Print Server Settings tab contains the **Basic Information**, **Port Settings**, **TCP/IP**, **E-Mail Alert**, **Bonjour (mDNS)**, **SNMP**, **Wireless LAN**, and **Reset Print Server** pages.

#### Basic Information

Purpose:

To configure the basic information of the printer.



**NOTE:** The **Auto Refresh** feature is effective for the contents of the top frame, **Printer Status** page, **Job List** page, and **Completed Jobs** page.

Values:

System Settings	Printer Name	Specifies the name of the printer using up to 31 alphanumeric characters.
	Location	Specifies the location of the printer using up to 63 alphanumeric characters.
	Contact Person	Specifies the contact name, number, and other information of the administrator and service center using up to 63 alphanumeric characters.
	Administrator E-Mail Address	Specifies the contact address of the administrator and service center using up to 63 alphanumeric characters.
	Asset Tag Number	Enter the asset tag number for the printer.
EWS Settings	Auto Refresh	Automatically refreshes the contents of the status display pages.
	Auto Refresh Interval	Sets the time interval for refreshing the contents of the status display pages automatically from 15 to 600 seconds.

## Port Settings

### Purpose:

To enable or disable printing connectors and management protocol features.



**NOTE:** The settings in the **Port Settings** page will be valid only when the printer is rebooted. When you change or configure the settings, click **Apply new settings** to apply new settings.

### Values:

Ethernet* <sup>1</sup>	Ethernet Settings	Auto	Detects Ethernet transmission rate and the duplex settings automatically.
		10Base-T Half-Duplex	Selects 10Base-T Half-Duplex as the default value.
		10Base-T Full-Duplex	Selects 10Base-T Full-Duplex as the default value.
		100Base-TX Half-Duplex	Selects 100Base-TX Half-Duplex as the default value.
		100Base-TX Full-Duplex	Selects 100Base-TX Full-Duplex as the default value.
	Current Ethernet Settings	Displays the current settings of Ethernet.	
MAC Address	Displays the MAC address of the printer.		
Port Status	LPD	Specifies whether to enable LPD.	
	Port9100	Specifies whether to enable Port9100.	
	WSD	Specifies whether to enable the WSD port.	
	Bonjour (mDNS)	Specifies whether to enable the Bonjour (mDNS) feature.	
	E-Mail Alert	Specifies whether to enable the E-Mail Alert feature.	
	SNMP	Specifies whether to enable the SNMP.	

\*<sup>1</sup> This item is available only when the printer is connected with a wired network.



## TCP/IP

### Purpose:

To configure the IP address, subnet mask, and gateway address of the printer.

### Values:

TCP/IP Settings	IP Mode	Specifies the IP mode.		
	Host Name	Specifies the host name.		
	IPv4	IP Address Mode	Selects the IP address mode.	
		Manual IP Address	Manually sets the IP address.	
		Manual Subnet Mask	Manually sets the subnet mask.	
		Manual Gateway Address	Manually sets the gateway address.	
	IPv6	Enable Stateless Address	To enable the stateless address.	
		Use Manual Address	To set the IP address manually.	
		Manual Address	Manually sets the IP address. To specify an IPv6 address, enter the address. Followed by a slash (/) and then "64". For details, consult your system administrator.	
		Manual Gateway Address	Manually sets the gateway address.	
DNS	DNS Domain Name	Specifies the domain name of the domain name server. Up to 255 alphanumeric characters, periods, and hyphens can be used. If you need to specify more than one domain name, separate them using a comma or semicolon.		
	IPv4	Get DNS Server Address from DHCP	Specifies if the printer receives the DNS server address automatically from the DHCP server.	
		Manual DNS Server Address	Sets the DNS server address.	
	IPv6	Get DNS Server Address from DHCPv6-lite	Specifies if the printer receives the DNS server address automatically from the DHCPv6-lite server.	
		Manual DNS Server Address	Sets the DNS server address.	
		Priority to IPv6 DNS Name Resolution	Specifies whether to enable the DNS Name Resolution feature.	
LPD	Connection Time-Out	Sets the connection time-out period from 1 to 1000 seconds.		
	IP Filter (IPv4)	Click <b>IP Filter (IPv4)</b> to set the IP filter settings on the <b>IP Filter (IPv4)</b> page.		
Port9100	Port Number	Sets the port number from 9000 to 9999.		
	Connection Time-Out	Sets the connection time-out period between 1 and 1000 seconds.		
	IP Filter (IPv4)	Click <b>IP Filter (IPv4)</b> to set the IP filter settings on the <b>IP Filter (IPv4)</b> page.		

WSD	Port Number	Sets the port number. This must be 80 or between 8000 and 9999.
	Receive Time-Out	Sets the receive time-out period from 1 to 65535 seconds.
	Notification Time-Out	Sets the notification time-out period from 1 to 60 seconds.
	Maximum Number of TTL	Sets the maximum number of TTL from 1 to 10.
	Maximum Number of Notification	Sets the maximum number of notifications from 10 to 20.
HTTP	Port Number	Sets the port number. This must be 80 or between 8000 and 9999.
	Simultaneous Connections	Displays the maximum number of connections received simultaneously by the client.
	Connection Time-Out	Sets the connection time-out period from 1 to 255 seconds.

### ***E-Mail Alert***

#### **Purpose:**

To configure settings for E-Mail Alert. This page can also be displayed by clicking **E-Mail Alert** in the left frame.

#### **Values:**

E-Mail Server Settings	Primary SMTP Gateway	Sets the primary SMTP gateway.
	SMTP Port Number	Specifies the SMTP port number. This must be 25, 587 or between 5000 and 65535.
	E-Mail Send Authentication	Specifies the authentication method for outgoing e-mail.
	SMTP Login User	Specifies the SMTP login user. Up to 63 alphanumeric characters, periods, hyphens, underscores, and at symbols (@) can be used. If specifying more than one address, separate them using commas.
	SMTP Login Password	Specifies the SMTP account password using up to 31 alphanumeric characters.
	Re-enter SMTP Login Password	Enter the SMTP account password again to confirm.
	POP3 Server Address* <sup>1</sup>	Specifies the POP3 server address in IP address format of "aaa.bbb.ccc.ddd" or as a DNS host name using up to 63 characters.
	POP3 Port Number* <sup>1</sup>	Specifies the POP3 server port number. This must be 110 or between 5000 and 65535.
	POP User Name* <sup>1</sup>	Specifies the POP3 account user name. Up to 63 alphanumeric characters, periods, hyphens, underscores, and at symbols (@) can be used. If specifying more than one address, separate them using commas.
	POP User Password* <sup>1</sup>	Specifies the POP3 account password using up to 31 alphanumeric characters.
	Re-enter POP User Password* <sup>1</sup>	Enter the POP3 account password again to confirm.
	Reply Address	Designates the reply e-mail address sent with each e-mail alert.
	SMTP Server Connection	Displays the status of the SMTP server connection.

E-Mail Alert Settings	E-Mail List 1	Sets acceptable e-mail addresses for the e-mail alert feature using up to 255 alphanumeric characters.	
	Select Alerts for List 1	Supplies Alerts	Specifies whether to receive an e-mail alert for consumables.
		Paper Handling Alerts	Specifies whether to receive an e-mail alert for paper handling.
		Service Call	Specifies whether to receive an e-mail alert for service calls.
	E-Mail List 2	Sets acceptable e-mail addresses for the e-mail alert feature using up to 255 alphanumeric characters.	
	Select Alerts for List 2	Supplies Alerts	Specifies whether to receive an e-mail alert for consumables.
		Paper Handling Alerts	Specifies whether to receive an e-mail alert for paper handling.
		Service Call	Specifies whether to receive an e-mail alert for service calls.

\*1 This item is available only when **POP before SMTP** for **E-Mail Send Authentication** is selected.

### ***Bonjour (mDNS)***

#### **Purpose:**

To configure the detailed settings for Bonjour.

#### **Values:**

Host Name	Specifies the host name up to 63 alphanumeric characters and "-" (dash). The original setting will remain valid if nothing is entered.
Printer Name	Specifies the printer name up to 63 alphanumeric characters and symbol sets.

### ***SNMP***

#### **Purpose:**

To configure the detailed settings of SNMP.

#### **Values:**

Community Name	Community Name (Read only) <sup>*1</sup>	Specifies the community name to access (read only) data using up to 31 alphanumeric characters.  The original setting will remain valid if nothing is entered. Characters entered for community name in the previous settings will not be displayed on the screen. The default Read Community is public.
	Re-enter Community Name (Read only) <sup>*1</sup>	Enter the community name to access (read only) data again to confirm.
	Community Name (Read/Write) <sup>*1</sup>	Specifies the community name to access (read and write) data using up to 31 alphanumeric characters.  The original setting will remain valid if nothing is entered. Characters entered for community name in the previous settings will not be displayed on the screen. The default Read/Write Community is private.

	<b>Re-enter Community Name (Read/Write)<sup>*1</sup></b>	Enter the community name to access (read and write) data again to confirm.
	<b>Community Name (Trap)<sup>*1</sup></b>	Specifies the community name used for trap up to 31 alphanumeric characters.  The original setting will remain valid if nothing is entered. Characters entered for community name in the previous settings will not be displayed on the screen. The default Trap Community is " " (NULL).
	<b>Re-enter Community Name (Trap)<sup>*1</sup></b>	Enter the community name used for trap again to confirm.
<b>Trap Notification 1-4</b>	<b>Trap Address Type</b>	Select the trap address type from the list. Selecting <b>Off</b> clears the settings in <b>Trap Address</b> , <b>Port Number</b> , and <b>Notify</b> , and does not notify trap occurrence. Selecting <b>IPv4</b> or <b>IPv6</b> allows you to enter <b>Trap Address</b> .
	<b>Trap Address</b>	Specifies the IP address and IP socket in the following format: <ul style="list-style-type: none"> <li>• IPv4 Specifies the IP address and IP socket in the nnn.nnn.nnn.nnn:mmmmm format. Each section of "nnn" is a variable value between 0 and 255. Note that values 127 and 224-254 are not valid for the first three-digits only. The IP socket mmmmm is a variable value between 0 and 65535.</li> <li>• IPv6 Specifies the IP address and IP socket in the xxxx:xxxx:xxxx:xxxx:xxxx:xxxx:xxxx:xxxx:mmmmm format. Each section of "xxxx" is a hexadecimal variable value between 0 and ffff. The IP socket mmmmm is a variable value between 0 and 65535.</li> </ul>
	<b>Port Number</b>	Enter the SNMP trap destination port number.
	<b>Notify</b>	Specifies whether to notify trap occurrence.
<b>Authenticate Error Trap</b>		Specifies whether to notify Authenticate Error Trap.

<sup>\*1</sup> The default value can be changed by using **Dell Printer Configuration Web Tool**.

## Wireless LAN

### Purpose:

To configure wireless network settings.

To connect the printer with a wireless network, be sure to disconnect the Ethernet cable.

 **NOTE:** Once wireless LAN is activated, wired LAN protocol will be disabled.

### Values:

Wireless Settings	Wireless LAN	Specifies whether to enable wireless connection.
	SSID	Specifies the name that identifies the wireless network using up to 32 alphanumeric characters.
	Network Type	Specifies the network type from either <b>Ad-Hoc</b> or <b>Infrastructure</b> .
	MAC Address	Displays the MAC address of the wireless network setting of the printer.
	Link Channel	Displays the channel number of the wireless connection of the printer.
	Link Quality	Displays the quality of the wireless network connection of the printer.
Security Settings	Encryption	Select the security method from the list.
	No Security	Specifies <b>No Security</b> to configure the wireless setting without specifying a security method from WEP, WPA-PSK TKIP, WPA-PSK AES/WPA2-PSK AES, and Mixed Mode PSK.
	WEP	Specifies the WEP to use through the wireless network.
	WPA-PSK TKIP* <sup>1</sup>	Specifies the WPA-PSK TKIP to use through the wireless network.
	WPA-PSK AES/WPA2-PSK AES* <sup>1</sup>	Specifies the WPA-PSK AES/WPA2-PSK AES to use through the wireless network.
	Mixed Mode PSK	Specifies the Mixed Mode PSK to use through the wireless network.

WEP	Encryption	Select the WEP key code from the list.
	WEP Key 1	Enter the WEP key when <b>WEP</b> is selected from <b>Encryption of Security Settings</b> .
	Re-enter WEP Key 1	Enter the WEP key 1 again to confirm.
	WEP Key 2	Enter the WEP key when <b>WEP</b> is selected from <b>Encryption of Security Settings</b> .
	Re-enter WEP Key 2	Enter the WEP key 2 again to confirm.
	WEP Key 3	Enter the WEP key when <b>WEP</b> is selected from <b>Encryption of Security Settings</b> .
	Re-enter WEP Key 3	Enter the WEP key 3 again to confirm.
	WEP Key 4	Enter the WEP key when <b>WEP</b> is selected from <b>Encryption of Security Settings</b> .
	Re-enter WEP Key 4	Enter the WEP key 4 again to confirm.
	Transmit Key	Specifies the transmit key type from the list.
WPA-PSK	Pass Phrase	Specifies the passphrase.
	Re-enter Pass Phrase	Enter the passphrase again to confirm.

\*1 This item is available only when the Infrastructure mode is selected for Network Type.

### ***Reset Print Server***

#### **Purpose:**

To initialize NVM (non-volatile memory) for the network feature and reboot the printer. You can also initialize NVM of the printer from **Reset Defaults** in the **Printer Settings** menu.

#### **Values:**

<b>Initialize NIC NVRAM Memory and restart printer.</b>	Click <b>Start</b> to initialize NVM. Network settings will revert to the factory default settings and reboot the network capability.
<b>Restart Printer</b>	Click <b>Start</b> to reboot the printer.

## Security

The Security tab contains the **Set Password** and **IP Filter (IPv4)** pages.

### ***Set Password***

#### **Purpose:**

To set or change the password that is required to access the setup parameters of the printer from the **Dell Printer Configuration Web Tool**.

This page can also be displayed by clicking **Set Password** in the left frame.



**NOTE:** If you forgot your password, initialize NVM (non-volatile memory) to restore the password to the default (NULL). See "Reset Print Server" on page 108.



**NOTE:** When you change the password to lock the operator panel, set the password from **Panel Lock Set** in the **Printer Settings**.

#### **Values:**

<b>Administrator Password</b>	Sets the password using up to 10 alphanumeric characters. The password will appear as asterisks (*) in the field when it is entered.
<b>Re-enter Administrator Password</b>	Enter the password again to confirm.
<b>Access denial by the authentication failure of the Administrator</b>	Sets the maximum number that the administrator fails to log in. If you set 0, this feature is disabled. The failed attempts counter is reset to 0 by a successful authentication. Every administrator authentication is rejected if the counter exceeds the maximum number of failed login attempts.

### ***IP Filter (IPv4)***

#### **Purpose:**

To specify the IP address and subnet mask to be permitted or denied access to the printer.



**NOTE:** This item is only available for LPD or Port9100.

#### **Values:**

<b>Address</b>	Specifies the IP addresses that are permitted or denied access to the printer. Enter a numeric value between 0 and 255 in each field.	
<b>Address Mask</b>	Specifies the subnet mask that are permitted or denied access to the printer. Enter a numeric value between 0 and 255 in each field.	
<b>Active Mode</b>	<b>Reject</b>	Rejects printing from specified network address.
	<b>Permit</b>	Permits printing from specified network address.
	<b>Disabled</b>	Disables the IP Filter feature for the specified IP address.

## Copy Printer Settings

The Copy Printer Settings menu contains the Copy Printer Settings and Copy Printer Settings Report pages.

### Copy Printer Settings

#### Purpose:

To copy the printer settings to one or more printers of the same model.

To copy the settings to another printer, specify the IP address and password of the printer to which the settings are copied in the **IP Address** text box and **Password** text box. Then, click **Copy the settings to the Host in the above list**. Copying the settings is complete. The connection time-out period is 60 seconds. After that, you can check whether the settings were copied to this page. And you need to click **Copy settings to the Host in the above list and reboot the machine** of the **Dell Printer Configuration Web Tool** in the destination printer to verify if the settings were actually copied or not.

If the settings can be copied but the printer configuration is different, the settings of only the common items are copied. Printer settings can be copied to 10 IP addresses of printers simultaneously.

### Copy Printer Settings Report

#### Purpose:

To verify the histories of copying.

 **NOTE:** The history is cleared by turning off the printer.

## Print Volume

#### Purpose:

Use the **Print Volume** menu to verify the number of printed pages.

#### Values:

Printer Page Count	Displays the total number of pages printed since the printer was shipped from the factory.
Paper Used	Displays the number of pages printed for each paper size.



## Understanding the Tool Box Menus

The **Tool Box** allows you to view or specify the printer settings. You can also diagnose the printer settings by using the **Tool Box**.

The **Tool Box** consists of the **Printer Settings Report**, **Printer Maintenance**, and **Diagnosis** tabs.

 **NOTE:** The **Password** dialog box appears the first time you try to change settings on **Tool Box** when **Panel Lock** is set on the printer. In this case, enter the password you specified, and click **OK** to apply the settings.

### Starting the Tool Box

Click **Start** → **All Programs** → **Dell Printers** → **Dell C1760nw Color Printer** or **Dell C1660w Color Printer** → **Tool Box**.

 **NOTE:** The **Select Printer** window appears in this step, when multiple printer drivers are installed on your computer. In this case, click **Dell C1760nw Color Printer** or **Dell C1660w Color Printer** listed in **Printer Name**, and then click **OK**.

The **Tool Box** opens.

### Using the Tool Box to Change the Printer Settings

You can select menu items and corresponding values from the **Tool Box**.

To select a new value as a setting:

- 1 Click **Start** → **All Programs** → **Dell Printers** → **Dell C1760nw Color Printer** or **Dell C1660w Color Printer** → **Tool Box**.

 **NOTE:** The **Select Printer** window appears in this step, when multiple printer drivers are installed on your computer. In this case, click **Dell C1760nw Color Printer** or **Dell C1660w Color Printer** listed in **Printer Name**, and then click **OK**.

The **Tool Box** opens.

- 2 Click the **Printer Maintenance** tab.
- 3 Select the desired menu item.

Each menu item has a list of values for the menu item. A value can be:

- A phrase or word to describe a setting
- A numerical value that can be changed
- An On or Off setting

- 4 Select the desired value, and then click the associated button with each menu item.

Driver settings may have precedence over changes previously made and may require you to change the **Tool Box** defaults.

## Printer Settings Report

The Printer Settings Report tab contains the **Printer Information**, **Menu Settings**, **Reports**, and **TCP/IP Settings** pages.

### Printer Information

**Purpose:**

To display the information of your printer.

**Values:**

Dell Service Tag Number	Displays the service tag number of your printer.
Express Service Code	Displays the express service code of the printer.
Printer Serial Number	Displays the serial number of the printer.
Printer Type	Displays the type of the printer.
Asset Tag Number	Displays the asset tag number of the printer.
Memory Capacity	Displays the memory capacity.
Processor Speed	Displays the processing speed.
Firmware Version	Displays the version of the controller.
Network Firmware Version	Displays the Network Interface Card (NIC) version.
MCU Firmware Version	Displays the version of the Machine Control Unit (MCU) firmware.
Printing Speed (Color)	Displays the speed for color printing.
Printing Speed (Monochrome)	Displays the speed for monochrome printing.

### Menu Settings

**Purpose:**

To display the current settings of your printer.

**Values:**

System Settings	Power Saver Timer - Sleep	Displays the time taken by the printer before it enters Sleep mode after it finishes a job.
	Power Saver Timer - Deep Sleep	Displays the time taken by the printer before it enters Deep Sleep mode after it goes into Sleep mode.
	Power Saver Timer - Auto-Off Timer <sup>*1</sup>	Displays the time it takes to automatically turn off the printer after the printer has entered the Deep Sleep mode.
	Fault Time-Out	Displays the time taken by the printer before it cancels jobs that stop abnormally.
	Job Time-Out	Displays the amount of time that the printer waits for data to arrive from the computer.
	Auto Log Print	Displays whether to automatically print a job history report after every 10 jobs.
	mm/inch	Displays the measurement unit used after the numeric value on the operator panel.
	Panel Language	Displays the language used on the operator panel.
	Default Print Paper Size	Displays the default paper size.

	Low Toner Alert Message	Displays whether to show the alert message when the toner is low.
	Disable printing with larger paper size	Displays whether to disable printing if the paper size set in the printer driver and the paper size set in the tray of the printer does not match (the paper set in the tray is larger).
Paper Density	Plain	Displays the paper density of plain paper.
	Label	Displays the paper density of labels.
Adjust BTR	Plain	Displays the voltage setting of the transfer roller for plain paper.
	Plain Thick	Displays the voltage setting of the transfer roller for thick plain paper.
	Recycled	Displays the voltage setting of the transfer roller for recycled paper.
	Covers	Displays the voltage setting of the transfer roller for cover paper.
	Coated	Displays the voltage setting of the transfer roller for coated paper.
	Envelope	Displays the voltage setting of the transfer roller for envelopes.
	Label	Displays the voltage setting of the transfer roller for labels.
	Adjust Fusing Unit	Plain
	Plain Thick	Displays the temperature setting of the fusing unit for thick plain paper.
	Recycled	Displays the temperature setting of the fusing unit for recycled paper.
	Covers	Displays the temperature setting of the fusing unit for cover paper.
	Coated	Displays the temperature setting of the fusing unit for coated paper.
	Envelope	Displays the temperature setting of the fusing unit for envelopes.
	Label	Displays the temperature setting of the fusing unit for labels.
Auto Registration Adjustment	Displays whether to automatically adjust color registration.	
Adjust Altitude	Displays the altitude of the location where the printer is installed.	
Non-Dell Toner	Displays whether to use toner cartridge of another manufacturer.	
BTR Refresh Mode	Displays whether to execute counter measures for curling/separating discharge of the paper.	

\*1 **Auto-Off Timer** feature is available only in certain regions.

## Reports

### Purpose:

To print the settings and history information of your printer.

The reports are printed in the paper size specified in printer settings.

### Values:

Printer Settings	Click to print a detailed list of the printer settings.
Device Settings	Click to print a detailed list of the device settings.
Job History	Click to print the completed jobs history.
Error History	Click to print the error history.
Color Test Page	Click to print a color test page.

## TCP/IP Settings

### Purpose:

To display the current settings of TCP/IP (Transmission Control Protocol/Internet Protocol) protocol.

### Values:

IP Address Mode	Displays the method for acquiring the IP address.
IP Address	Displays the IP address of your printer.
Subnet Mask	Displays the subnet mask.
Gateway Address	Displays the gateway address.

## Printer Maintenance

The Printer Maintenance tab contains the System Settings, Paper Density, Adjust BTR, Adjust Fusing Unit, Color Registration Adjustment, Adjust Altitude, Reset Defaults, Non-Dell Toner, BTR Refresh Mode, TCP/IP Settings, and Network Settings pages.

### System Settings

#### Purpose:

To configure the power saving mode, time-out time, job log auto print, mm/inch setting, operator panel language setting, default paper size setting, and low toner alert message setting.

#### Values:

Sleep <sup>*1</sup>	Available Range: 5–30 minutes	Specifies the time taken by the printer before it enters Sleep mode after it finishes a job.
Deep Sleep	Available Range: 1–6 minutes	Specifies the time taken by the printer before it enters Deep Sleep mode after it goes into Sleep mode.
Auto-Off Timer <sup>*2</sup>	0: Off 60–1440 minutes	Specifies the time taken by the printer before it automatically turns off after it has entered Deep Sleep mode.
Fault Time-Out	0: Off Available Range: 3–300 seconds	Disables the fault time-out. Specifies the time taken by the printer before it cancels jobs that stop abnormally. The print job is cancelled if it times out.

Job Time-Out	0: Off	Disables the job time-out.
	Available Range: 5–300 seconds	Specifies the amount of time that the printer waits for data to arrive from the computer. The print job is cancelled if it times out.
Auto Log Print	Off	Does not automatically print a job history report.
	On	Automatically prints a job history report after every 10 jobs.
mm/inch	millimeter (mm)	Specifies the measurement unit displayed after the numeric value on the operator panel.
	inch (")	
Panel Language	English	Specifies the language to be used on the operator panel.
	French	
	German	
	Italian	
	Spanish	
	Danish	
	Dutch	
	Norwegian	
Default Print Paper Size	A4	Specifies the default paper size.
	Letter	
Low Toner Alert Message	On	Shows the alert message when the toner is low.
	Off	Does not show the alert message.
Disable printing with larger paper size <sup>*3</sup>	Off	Prints even if the paper set in the tray of the printer is larger than the paper size set in the printer driver (the paper size does not have to match).
	On	Disables printing if the paper size set in the printer driver differs from the paper set in the tray of the printer (the paper set in the tray is larger).
Apply New Settings	After you complete the settings, click <b>Apply New Settings</b> to apply the changes.	
<p>*1 Enter 5 in <b>Sleep</b> to put the printer in the Sleep mode five minutes after it finishes a job. This uses less energy, but requires more warm-up time for the printer. Enter 5 if your printer shares an electrical circuit with room lighting and you notice lights flickering. Select a high value if your printer is in constant use. In most circumstances, this keeps the printer ready to operate with minimum warm-up time. Select a value between 5 and 30 minutes for the Sleep mode if you want a balance between energy consumption and a shorter warm-up period. The printer automatically returns to the standby mode from the Sleep mode when it receives data from the computer. You can also return the printer to the standby mode by pressing any button on the operator panel.</p> <p>*2 <b>Auto-Off Timer</b> feature is available only in certain regions.</p> <p>*3 <b>Disable printing with larger paper size</b> is available only in the <b>Dell Printer Configuration Web Tool</b> and the <b>Tool Box</b>.</p>		

## Paper Density

### Purpose:

To specify the paper density.

### Values:

Plain	Normal	Specifies the paper density of plain paper.
	Light	
Label	Normal	Specifies the paper density of labels.
	Light	
Apply New Settings		After you complete the settings, click <b>Apply New Settings</b> to apply the changes.
Restart printer to apply new settings		Click <b>Restart printer to apply new settings</b> to apply the changes.

## Adjust BTR

### Purpose:

To specify the optimum voltage settings for printing for the transfer roller (BTR). To decrease the voltage, set negative values. To increase, set positive values.

The default settings may not give the best output on all paper types. If you see mottles on the print output, try to increase the voltage. If you see white spots on the print output, try to decrease the voltage.



**NOTE:** The print quality changes depending on the values you select for this item.

### Values:

Plain	Available Range: -3 – +3
Plain Thick	Available Range: -3 – +3
Recycled	Available Range: -3 – +3
Covers	Available Range: -3 – +3
Coated	Available Range: -3 – +3
Envelope	Available Range: -3 – +3
Label	Available Range: -3 – +3
Apply New Settings	After you complete the settings, click <b>Apply New Settings</b> to apply the changes.
Restart printer to apply new settings	Click <b>Restart printer to apply new settings</b> to apply the changes.

## Adjust Fusing Unit

### Purpose:

To specify the optimum temperature settings for printing for the fusing unit. To decrease the temperature, set negative values. To increase, set positive values.

The default settings may not give the best output on all paper types. When the printed paper has curled, try to decrease the temperature. When the toner does not fuse on the paper properly, try to increase the temperature.

 **NOTE:** The print quality changes depending on the values you select for this item.

### Values:

Plain	Available Range: -3 – +3
Plain Thick	Available Range: -3 – +3
Recycled	Available Range: -3 – +3
Covers	Available Range: -3 – +3
Coated	Available Range: -3 – +3
Envelope	Available Range: -3 – +3
Label	Available Range: -3 – +3
Apply New Settings	After you complete the settings, click <b>Apply New Settings</b> to apply the changes.
Restart printer to apply new settings	Click <b>Restart printer to apply new settings</b> to apply the changes.

## Color Registration Adjustment

### Purpose:

To set **Color Registration Adjustment** (individual yellow, magenta, cyan correction) settings. When **Auto Registration Adjustment** is set to **On**, the printer prints the color registration chart and adjusts the color registration by using the chart. Color registration adjustments need to be made during the initial setup of the printer or when the printer is moved to a different location.

### Values:

Auto Registration Adjustment	On	Automatically adjusts color registration.
	Off	Does not automatically adjust color registration.
Auto Correct <sup>*1</sup>		Click <b>Start</b> to automatically correct color registration.
Print Color Regi Chart <sup>*1, *2</sup>		Click <b>Start</b> to open the <b>Print Color Regi Chart</b> window, and then select the paper size and click <b>OK</b> to print a color registration chart.

Registration Adjustments *1	Y(Yellow)	Available Range: -5-+5	Specifies lateral (perpendicular to paper feed direction) color adjustment values individually.
	M(Magenta)	Available Range: -5-+5	
	C(Cyan)	Available Range: -5-+5	
	LY(Left Yellow)	Available Range: -5-+5	
	LM(Left Magenta)	Available Range: -5-+5	
	LC(Left Cyan)	Available Range: -5-+5	
	RY(Right Yellow)	Available Range: -5-+5	
	RM(Right Magenta)	Available Range: -5-+5	
RC(Right Cyan)	Available Range: -5-+5		
Apply New Settings	After you complete the settings, click <b>Apply New Settings</b> to apply the changes.		
Restart printer to apply new settings	Click <b>Restart printer to apply new settings</b> to apply the changes.		
*1 This item is available only when <b>Auto Registration Adjustment</b> is set to Off.			
*2 The color registration chart prints a lattice pattern of yellow, magenta, and cyan lines. On the chart, find the values on the right side that are next to the line that is perfectly straight for each of the three colors. If the value for this line is 0, color registration is not needed. If the value for this line is any value other than 0, specify the adjustment values under <b>Registration Adjustments</b> .			

## Adjust Altitude

### Purpose:

To specify the altitude of the location where the printer is installed.

The discharge phenomenon for charging the photo conductor varies with barometric pressure. Adjustments are performed by specifying the altitude of the location where the printer is being used.



**NOTE:** An incorrect altitude adjustment setting leads to poor printing quality, incorrect indication of remaining toner.

### Values:

0 meter	Specifies the altitude of the location where the printer is installed.
1000 meters	
2000 meters	
3000 meters	
Apply New Settings	After you complete the settings, click <b>Apply New Settings</b> to apply the changes.
Restart printer to apply new settings	Click <b>Restart printer to apply new settings</b> to apply the changes.



## Reset Defaults

### Purpose:

To initialize NVM (non-volatile memory) for system parameters. After executing this function and rebooting the printer, all the menu parameters, except the parameters for the network, are reset to their default values.

For details, see "Resetting Defaults" on page 123.

### Values:

---

Start	Click to initialize the system parameters.
-------	--

---

## Non-Dell Toner

### Purpose:

To use toner cartridge of another manufacturer.

 **NOTE:** Using non-Dell™-brand toner cartridges may make some printer features unusable, reduce print quality and decrease the reliability of your printer. Dell recommends only new Dell-brand toner cartridges for your printer. Dell does not provide warranty coverage for problems caused by using accessories, parts, or components not supplied by Dell.

 **NOTE:** Before you use toner cartridge of another manufacturer, be sure to restart the printer.

### Values:

---

Non-Dell Toner	Off	Does not use toner cartridge of another manufacturer.
	On	Use toner cartridge of another manufacturer.
Apply New Settings		After you complete the settings, click <b>Apply New Settings</b> to apply the changes.
Restart printer to apply new settings		Click <b>Restart printer to apply new settings</b> to apply the changes.

---

## BTR Refresh Mode

### Purpose:

To execute counter measures for curling/separating discharge of the paper.

### Values:

---

BTR Refresh Mode	Off	Does not automatically execute counter measures for curling/separating discharge of the paper.
	On	Automatically executes counter measures for curling/separating discharge of the paper.
Apply New Settings		After you complete the settings, click <b>Apply New Settings</b> to apply the changes.
Restart printer to apply new settings		Click <b>Restart printer to apply new settings</b> to apply the changes.

---

## TCP/IP Settings

### Purpose:

To configure TCP/IP settings.

### Values:

IP Address Mode	AutoIP	Automatically sets the IP address.
	DHCP	Uses DHCP to set the IP address.
	BOOTP	Uses BOOTP to set the IP address.
	RARP	Uses RARP to set the IP address.
	Manually Set	Manually sets the IP address.
IP Address		Manually sets the IP address allocated to the printer.
Subnet Mask		Manually sets the subnet mask.
Gateway Address		Manually sets the gateway address.
Apply New Settings		After you complete the settings, click <b>Apply New Settings</b> to apply the changes.
Restart printer to apply new settings		Click <b>Restart printer to apply new settings</b> to apply the changes.

## Network Settings

### Purpose:

To display the server settings of the **Dell Printer Configuration Web Tool**.



**NOTE:** When the printer is connected to the USB port, this setting cannot be displayed.

### Values:

Print Server Settings	Display	Click to display the server settings for the <b>Dell Printer Configuration Web Tool</b> .
Display of Dell Configuration Web Tool	Off	Turns off the display of the server settings for the <b>Dell Printer Configuration Web Tool</b> .
	On	Turns on the display of the server settings for the <b>Dell Printer Configuration Web Tool</b> .
Apply New Settings		After you complete the settings, click <b>Apply New Settings</b> to apply the changes.
Restart printer to apply new settings		Click <b>Restart printer to apply new settings</b> to apply the changes.

## Diagnosis

The **Diagnosis** tab contains the **Chart Print**, **Machine Check**, **Environment Sensor Info**, **Developer Stir Mode**, and **Refresh Mode** pages.

### Chart Print

**Purpose:**

To print various charts that can be used for diagnosing your printer.

**Values:**

<b>Paper Size</b>	<b>A4</b> <b>Letter</b>	Selects the paper size to print charts.
<b>Ghost Configuration Chart</b>		Click to print a chart to check for ghost printing.
<b>4 Colors Configuration Chart</b>		Click to print bands of yellow, magenta, cyan, and black with varying density.
<b>Alignment Chart</b>		Click to print a chart, and then check for proper alignment of the print image on the paper.
<b>Drum Refresh Configuration Chart</b>		Prints a chart to check the light fatigue of the drum cartridge.

### Machine Check

**Purpose:**

To check the operation of the different components of the printer.

**Values:**

<b>Machine Check</b>	<b>Main Motor Operation Check</b>	Click <b>Start</b> to operate the main motor inside the printer. Confirm the motor sound.
	<b>Feed Roll Operation Check<sup>*1</sup></b>	Click <b>Start</b> to operate the feed roll. Confirm the motor sound.
	<b>REGI CLUTCH Operation Check</b>	Click <b>Start</b> to operate the REGI CLUTCH. Confirm that you can hear the clutch clicking.
	<b>Dispense Motor Check (Yellow)</b>	Click <b>Start</b> to operate the dispense motor for each toner cartridge. Confirm the motor sound.
	<b>Dispense Motor Check (Magenta)</b>	
	<b>Dispense Motor Check (Cyan)</b>	
<b>Dispense Motor Check (Black)</b>		
<b>Play of Sound</b>		Click to play back through speakers of your computer a recording of the normal sound for the currently selected <b>Machine Check</b> item.
<b>Start</b>		Click to check the operation of the item selected in <b>Machine Check</b> and display the results to <b>Result</b> .

<sup>\*1</sup> When you perform the feed roll operation check, remove the paper from the Multipurpose Feeder (MPF).

## Environment Sensor Info

### Purpose:

To display the internal environment sensor information of the printer to **Result**.

---

Get Environment Sensor Info	Click to confirm the internal environment sensor information of the printer such as temperature and humidity.
-----------------------------	---

---

## Developer Stir Mode

### Purpose:

To rotate the developer motor and stir the toner in the toner cartridge.

### Values:

---

Start	Click to stir the toner.
-------	--------------------------

---

## Refresh Mode

### Purpose:

To use up a toner cartridge when you need to replace it before the end of its life, or to stir the toner in a new toner cartridge.

 **NOTE:** Using the Refresh Mode consumes extra toner.

### Values:

---

Yellow	Click to clean the toner in the yellow toner cartridge.
Magenta	Click to clean the toner in the magenta toner cartridge.
Cyan	Click to clean the toner in the cyan toner cartridge.
Black	Click to clean the toner in the black toner cartridge.

---

## Resetting Defaults

After executing this function and rebooting the printer, all the menu parameters are reset to their default values.

The following menu parameters are exceptions and are not reset.

- Network settings
- Panel Lock settings and password
- Login Error settings
- USB Port settings

- 1** Click **Start** → **All Programs** → **Dell Printers** → **Dell C1760nw Color Printer** or **Dell C1660w Color Printer** → **Tool Box**.

 **NOTE:** For details about starting the Tool Box, see "Starting the Tool Box" on page 111.

The **Tool Box** opens.

- 2** Click the **Printer Maintenance** tab.
- 3** Select **Reset Defaults** from the list at the left side of the page.

The **Reset Defaults** page is displayed.

- 4** Click **Start**.

The printer restarts automatically to apply the settings.



## Understanding the Printer Menus

When your printer is configured as a network printer available to a number of users, the access to the Admin Menu menus can be limited. This prevents unauthorized users from using the operator panel to inadvertently change the default menu settings that has been set by the administrator. However, you can select settings for individual print jobs using the printer driver. Print settings selected from the printer driver have precedence over the default menu settings selected from the operator panel.

### Report/List

Use the Report/List menu to print the settings and history information of your printer.

 **NOTE:** A Password is required to enter the Report/List menu when Panel Lock Set is set to Enable. In this case, enter the password you specified, and press the  (Set) button.

#### Printer Setting

Purpose:

To print a list of the information such as the printer name, service tag, the status of the printer, consumables, and the network settings.

#### Device Settings

Purpose:

To print a detailed list of all the settings on the operator panel menus.

#### Job History

Purpose:

To print a detailed list of the print jobs that have been processed. This list contains the last 10 print jobs.

#### Error History

Purpose:





To print a detailed list of paper jams and fatal errors.

#### Color Test Page

Purpose:

To print a page for testing colors.

#### Printing a Report/List Using the Operator Panel

- 1 Press the  (Menu) button.
- 2 Press the  button until Report/List appears, and then press the  (Set) button.
- 3 Press the  button until the desired report or list appears, and then press the  (Set) button.  
The selected report or list is printed.

## Printing a Report/List Using the Tool Box

- 1 Click Start → All Programs → Dell Printers → Dell C1760nw Color Printer or Dell C1660w Color Printer → Tool Box.

 **NOTE:** The **Select Printer** window appears in this step, when multiple printer drivers are installed on your computer. In this case, click **Dell C1760nw Color Printer** or **Dell C1660w Color Printer** listed in **Printer Name**, and then click **OK**.

The Tool Box opens.

- 2 Click the **Printer Settings Report** tab.
- 3 Select **Reports** from the list at the left side of the page.

The **Reports** page is displayed.

- 4 Click the button for the desired report or list.

The report or list is printed.

## Admin Menu

Use the **Admin Menu** menu to configure a variety of printer features.

 **NOTE:** A Password is required to enter the **Admin Menu** menu when **Panel Lock Set** is set to **Enable**. In this case, enter the password you specified, and press the  (**Set**) button.

## Network

Use the **Network** menu to change the printer settings affecting jobs sent to the printer through the wired or wireless network.

 **NOTE:** Values marked by an asterisk (\*) are the factory default menu settings.

### Ethernet (Dell C1760nw Color Printer only)

#### Purpose:

To specify the communication speed and the duplex settings of Ethernet. The change takes effect after the printer is turned off and then on.

#### Values:

Auto*	Detects the Ethernet settings automatically.
10Base Half	Uses 10base-T half-duplex.
10Base Full	Uses 10base-T full-duplex.
100Base Half	Uses 100base-TX half-duplex.
100Base Full	Uses 100base-TX full-duplex.

 **NOTE:** This item is not displayed when the Ethernet cable is disconnected and **Wireless LAN** is set to **Enable**.



## Wireless LAN

### Purpose:

To enable the wireless connection.

### Values:

Enable	Enables the wireless connection.
Disable	Disables the wireless connection.

 **NOTE:** For Dell C1760nw Color Printer, the factory default is `Enable`. For Dell C1660w Color Printer, the factory default is `Disable`.

 **NOTE:** When you use the USB connection and do not use the wireless connection, you need to disable the wireless LAN.

## Wireless Status

### Purpose:

To display the information on the wireless signal strength. No changes can be made on the operator panel to improve the status of the wireless connection.

### Values:

Good	Indicates good signal strength.
Acceptable	Indicates marginal signal strength.
Low	Indicates insufficient signal strength.
No Reception	Indicates that no signal is received.

 **NOTE:** For Dell C1760nw Color Printer, this item is displayed when the Ethernet cable is disconnected and `Wireless LAN` is set to `Enable`.

 **NOTE:** For Dell C1660w Color Printer, this item is displayed only when `Wireless LAN` is set to `Enable`.

## Wireless Setup

### Purpose:

To configure the wireless network interface.

### Values:

Select Access	Select the access point from the list.
WEP Key	When you select an access point using WEP as the security method, enter the WEP key. For 64bit keys, up to 10 hexadecimal characters can be entered. For 128bit keys, up to 26 hexadecimal characters can be entered.
PassPhrase Entry	When you select an access point using WPA, WPA2, or Mixed as the encryption type, enter the passphrase of 8 to 63 alphanumeric characters.

Manual Setup	Enter (SSID)	Specify a name to identify the wireless network. Up to 32 alphanumeric characters can be entered.
	Infrastructure	Select when you configure the wireless setting through the access point such as a wireless router.
	No Security*	Specify <b>No Security</b> to configure the wireless setting without specifying a security method from <b>WEP</b> , <b>WPA-PSK-TKIP</b> , and <b>WPA2-PSK-AES</b> .
	Mixed mode PSK	Select to configure the wireless setting with the encryption type of Mixed mode PSK. Mixed mode PSK automatically selects the encryption type from either WPA-PSK-TKIP, WPA-PSK-AES, or WPA2-PSK-AES.
	PassPhrase Entry	Specifies the passphrase of alphanumeric characters from 8 to 63.
	WEP	Specifies the WEP key to use through the wireless network. For 64bit keys, up to 10 hexadecimal characters can be entered. For 128bit keys, up to 26 hexadecimal characters can be entered.
	Transmit Key	Specifies the transmit key from <b>Auto*</b> , <b>WEP Key 1</b> , <b>WEP Key 2</b> , <b>WEP Key 3</b> , and <b>WEP Key 4</b> .
	WPA-PSK-TKIP	Select to configure the wireless setting with the security method of WPA-PSK-TKIP.
	PassPhrase Entry	Specify the pass phrase of alphanumeric characters from 8 to 63.
	WPA2-PSK-AES	Select to configure the wireless setting with the security method of WPA2-PSK-AES or WPA-PSK-AES.
	PassPhrase Entry	Specify the pass phrase of alphanumeric characters from 8 to 63.
	Ad-hoc	Select to configure the wireless setting without the access point such as a wireless router.
	No Security*	Specify <b>No Security</b> to configure the wireless setting without specifying the security method from <b>WEP</b> .
WEP	Specifies the WEP key to use through the wireless network. For 64bit keys, up to 10 hexadecimal characters can be entered. For 128bit keys, up to 26 hexadecimal characters can be entered.	
Transmit Key	Specifies the transmit key from <b>WEP Key 1*</b> , <b>WEP Key 2</b> , <b>WEP Key 3</b> , and <b>WEP Key 4</b> .	

 **NOTE:** For Dell C1760nw Color Printer, this item is displayed when the Ethernet cable is disconnected and Wireless LAN is set to **Enable**.

## WPS Setup

### Purpose:

To configure the wireless network using WPS.

### Values:

Push Btn. Ctrl	PBC Start <sup>*1</sup>	Configures the wireless setting with the security method of WPS-PBC.
PIN Code	Start Config.	Configures the wireless setting using the PIN code assigned automatically by the printer.
	Print PIN Code	Prints the PIN code. Confirm it when you enter the PIN code to your computer.

<sup>\*1</sup> You can also start WPS-PBC by pressing and holding the  (Wi-Fi | WPS) button.



**NOTE:** WPS 2.0 compliant. WPS 2.0 works on access points with the following encryption types: Mixed mode PSK, WPA-PSK AES, WPA2-PSK AES, WPA-PSK TKIP, Open (No Security)



**NOTE:** For Dell C1760nw Color Printer, this item is displayed when the Ethernet cable is disconnected and Wireless LAN is set to Enable.



**NOTE:** For Dell C1660w Color Printer, this item is displayed only when Wireless LAN is set to Enable.

## Reset Wireless

### Purpose:

To initialize wireless network settings. After executing this function and rebooting the printer, all wireless network settings are reset to their default values.



**NOTE:** For Dell C1760nw Color Printer, this item is displayed when the Ethernet cable is disconnected and Wireless LAN is set to Enable.



**NOTE:** For Dell C1660w Color Printer, this item is displayed only when Wireless LAN is set to Enable.

## TCP/IP

### Purpose:

To configure TCP/IP settings. The change takes effect after the printer is turned off and then on.

### Values:

IP Mode	Dual Stack*	Uses both IPv4 and IPv6 to set the IP address.	
	IPv4 Mode	Uses IPv4 to set the IP address.	
	IPv6 Mode	Uses IPv6 to set the IP address.	
IPv4	Get IP Address	AutoIP*	Automatically sets the IP address.
		BOOTP	Uses BOOTP to set the IP address.
		RARP	Uses RARP to set the IP address.
		DHCP	Uses DHCP to set the IP address.
		Panel	Enables the IP address entered on the operator panel.
	IP Address	Manually sets the IP address allocated to the printer.	
Subnet Mask	Manually sets the subnet mask.		
Gateway Address	Manually sets the gateway address.		

## Protocol

### Purpose:

To enable or disable each protocol. The change takes effect after the printer is turned off and then on.

### Values:

LPD	Enable*	Enables the Line Printer Daemon (LPD) port.
	Disable	Disables the LPD port.
Port9100	Enable*	Enables the Port9100 port.
	Disable	Disables the Port9100 port.
WSD	Enable*	Enables the Web Services on Devices (WSD) port.
	Disable	Disables the WSD port.
SNMP UDP	Enable*	Enables the UDP port.
	Disable	Disables the UDP port.
E-Mail Alert	Enable*	Enables the E-mail Alert feature.
	Disable	Disables the E-mail Alert feature.
EWS	Enable*	Enables an access to Dell™ Printer Configuration Web Tool embedded in the printer.
	Disable	Disables an access to Dell Printer Configuration Web Tool embedded in the printer.
Bonjour (mDNS)	Enable*	Enables the Bonjour (mDNS).
	Disable	Disables the Bonjour (mDNS).

## IP Filter

### Purpose:

To block data received from certain IP addresses through the wired or wireless network. You can set up to five IP addresses. The change takes effect after the printer is turned off and then on.

### Values:

No. n/Address (n is 1-5.)		Sets the IP address for Filter <i>n</i> .
No. n/Mask (n is 1-5.)		Sets the address mask for Filter <i>n</i> .
No. n/Mode (n is 1-5.)	Off*	Disables the feature for Filter <i>n</i> .
	Accept	Accepts an access from the specified IP address.
	Reject	Rejects an access from the specified IP address.



**NOTE:** This item is only available for LPD or Port9100.

## Reset LAN

### Purpose:

To initialize network data stored in NVM (non-volatile memory). After executing this function and rebooting the printer, all network settings are reset to their default values.

## USB Settings

Use the **USB Settings** menu to change printer settings affecting a USB port.

 **NOTE:** Values marked by an asterisk (\*) are the factory default menu settings.

### USB Port

#### Purpose:

To change the USB settings on your printer. The change takes effect after the printer is turned off and then on.

#### Values:

Enable*	Enables the USB interface.
Disable	Disables the USB interface.

## System Settings

Use the **System Settings** menu to configure a variety of printer features.

 **NOTE:** Values marked by an asterisk (\*) are the factory default menu settings.

### PowerSaver Time

#### Purpose:

To specify the time for transition to power saver mode.

#### Values:

Sleep	5min.*	Specifies the time taken by the printer before it enters Sleep mode after it finishes a job.
	Available Range: 5-30min.	
Deep Sleep	6min.*	Specifies the time taken by the printer before it enters Deep Sleep mode after it goes into Sleep mode.
	Available Range: 1-6min.	
Auto-Off Timer* <sup>1</sup>	Off	Disables the Auto-Off Timer.
	On*	180min.* Available Range: 60-1440min.

\*<sup>1</sup> Auto-Off Timer feature is available only in certain regions.

Enter 5 in **Sleep** to put the printer in the Sleep mode five minutes after it finishes a job. This uses less energy, but requires more warm-up time for the printer. Enter 5 if your printer shares an electrical circuit with room lighting and you notice lights flickering.

Select a high value if your printer is in constant use. In most circumstances, this keeps the printer ready to operate with minimum warm-up time. Select a value between 5 and 30 minutes for the Sleep mode if you want a balance between energy consumption and a shorter warm-up period.

The printer automatically returns to the standby mode from the Sleep mode when it receives data from the computer. You can also return the printer to the standby mode by pressing any button on the operator panel.

If the Auto-Off Timer feature turns off the printer, the printer cannot be turned back on automatically. To turn the printer back on, physically turn the power switch of the printer to On.

### Fault Time-Out

#### Purpose:

To specify the time taken by the printer before it cancels jobs that stop abnormally. The print job is cancelled if it times out.

#### Values:

On*	60 sec.* Available Range: 3–300 sec.	Specifies the time taken by the printer before it cancels jobs that stop abnormally.
Off		Disables the fault time-out.

### Job Time-out

#### Purpose:

To specify the amount of time that the printer waits for data to arrive from the computer. The print job is cancelled if it times out.

#### Values:

On*	30 sec.* Available Range: 5–300 sec.	Specifies the amount of time that the printer waits for data to arrive from the computer.
Off		Disables the job time-out.

### mm/inch

#### Purpose:

To specify the measurement unit displayed after the numeric value on the operator panel.

#### Values:

millimeter(mm)	Specifies the default measurement unit.
inch(")	



**NOTE:** The default for mm/inch varies depending on country-specific factory default.

### Def. Paper Size

#### Purpose:

To specify the default paper size.

#### Values:

A4
Letter



**NOTE:** The default for Def. Paper Size varies depending on country-specific factory default.

### Auto Log Print

#### Purpose:

To automatically print a job history report after every 10 jobs.

#### Values:

Off*	Does not automatically print a job history report.
On	Automatically prints a job history report.



**NOTE:** The job history report can also be printed using the Report/List menu.

### Low Toner Msg

#### Purpose:

To specify whether to show the alert message when toner is low.

#### Values:

On*	Shows the alert message when the toner is low.
Off	Does not show the alert message when the toner is low.

### Power On Wizard (Dell C1660w Color Printer only)

#### Purpose:

To perform initial setup for the printer.

#### Values:

No*	Does not perform the initial setup for the printer.
Yes	Performs the initial setup for the printer.

### Maintenance

Use the Maintenance menu to initialize the NV (non-volatile) memory, configure the plain paper quality adjustment settings, and configure the security settings.



**NOTE:** Values marked by an asterisk (\*) are the factory default menu settings.

### F/W Version

#### Purpose:

To display the version of the controller.

### Service Tag

#### Purpose:

To display the service tag of the printer.

### Express Code

#### Purpose:

To display the express service code of the printer.

## Paper Density

### Purpose:

To specify the paper density.

### Values:

Plain	Normal*
	Light
Label	Normal*
	Light

## Adjust BTR

### Purpose:

To specify the optimum voltage settings for printing for the transfer roller (BTR). To decrease the voltage, set negative values. To increase the voltage, set positive values.

The default settings may not give the best output on all paper types. If you see mottles on the print output, try to increase the voltage. If you see white spots on the print output, try to decrease the voltage.



**NOTE:** The print quality changes depending on the values you select for this item.

### Values:

Plain	0*
	Available Range: -3 – +3
Plain Thick	0*
	Available Range: -3 – +3
Covers	0*
	Available Range: -3 – +3
Label	0*
	Available Range: -3 – +3
Coated	0*
	Available Range: -3 – +3
Envelope	0*
	Available Range: -3 – +3
Recycled	0*
	Available Range: -3 – +3



## Adj. FusingUnit

### Purpose:

To specify the optimum temperature settings for printing for the fusing unit. To decrease the temperature, set negative values. To increase the temperature, set positive values.

The default settings may not give the best output on all paper types. When the printed paper has curled, try to decrease the temperature. When the toner does not fuse on the paper properly, try to increase the temperature.

 **NOTE:** The print quality changes depending on the values you select for this item.

### Values:

Plain	0*
	Available Range: -3 – +3
Plain Thick	0*
	Available Range: -3 – +3
Covers	0*
	Available Range: -3 – +3
Label	0*
	Available Range: -3 – +3
Coated	0*
	Available Range: -3 – +3
Envelope	0*
	Available Range: -3 – +3
Recycled	0*
	Available Range: -3 – +3

## Auto Reg Adj

### Purpose:

To specify whether to automatically adjust color registration.

### Values:

On*	Automatically adjusts color registration.
Off	Does not automatically adjust color registration.

## Color Reg Adj

### Purpose:

To specify whether to manually adjust color registration.

Color registration adjustments need to be made during the initial setup of the printer or when the printer is moved to a different location.



**NOTE:** The Color Reg Adj feature can be configured when Auto Reg Adj is set to Off.

### Values:

Auto Correct	Automatically corrects color registration.	
ColorRegi Chart	Prints a color registration chart. The color registration chart prints a lattice pattern of yellow, magenta, and cyan lines. On the chart, find the values on the right side that are next to the line that is perfectly straight for each of the three colors. If the value for this line is 0, color registration is not needed. If the value for this line is any value other than 0, specify the adjustment values under Enter Number.	
Enter Number	Y	0 <sup>*</sup> Available Range: -5-+5
	M	0 <sup>*</sup> Available Range: -5-+5
	C	0 <sup>*</sup> Available Range: -5-+5
	LY	0 <sup>*</sup> Available Range: -5-+5
	LM	0 <sup>*</sup> Available Range: -5-+5
	LC	0 <sup>*</sup> Available Range: -5-+5
	RY	0 <sup>*</sup> Available Range: -5-+5
	RM	0 <sup>*</sup> Available Range: -5-+5
	RC	0 <sup>*</sup> Available Range: -5-+5

## Clean Developer

### Purpose:

To rotate the developer motor and stir the toner in the toner cartridge.

### **Toner Refresh**

**Purpose:**

To use up a toner cartridge when you need to replace it before the end of its life, or to stir the toner in a new toner cartridge.

**Values:**

Yellow	Cleans the toner in the yellow toner cartridge.
Magenta	Cleans the toner in the magenta toner cartridge.
Cyan	Cleans the toner in the cyan toner cartridge.
Black	Cleans the toner in the black toner cartridge.

### **BTR Refresh**

**Purpose:**

Specify whether to execute counter measures for curling/separating discharge of the paper.

**Values:**

Off*	Does not automatically execute counter measures for curling/separating discharge of the paper.
On	Automatically executes counter measures for curling/separating discharge of the paper.

### **Chart**

**Purpose:**

To print various charts that can be used for diagnosing your printer.

**Values:**

Ghost	Prints a chart to check for ghost printing.
4Colors	Prints bands of yellow, magenta, cyan, and black with varying density.
Alignment	Prints a chart, and then check for proper alignment of the print image on the paper.
Drum Refresh	Prints a chart to check the light fatigue of the drum cartridge.

### **Reset Defaults**

**Purpose:**

To initialize NVM (non-volatile memory) for system parameters. After executing this function and rebooting the printer, all the menu parameters, except the parameters for the network, are reset to their default values.

For details, see "Resetting Defaults" on page 141.

## Non-Dell Toner

### Purpose:

To use toner cartridge of another manufacturer.

 **NOTE:** Using non-Dell-brand toner cartridges may make some printer features unusable, reduce print quality and decrease the reliability of your printer. Dell recommends only new Dell-brand toner cartridges for your printer. Dell does not provide warranty coverage for problems caused by using accessories, parts, or components not supplied by Dell.

 **NOTE:** Before you use toner cartridge of another manufacturer, be sure to restart the printer.

### Values:

---

Off*	Does not use toner cartridge of another manufacturer.
On	Uses toner cartridge of another manufacturer.

---

## Adjust Altitude

### Purpose:

To specify the altitude of the location where the printer is installed.

The discharge phenomenon for charging the photo conductor varies with barometric pressure. Adjustments are performed by specifying the altitude of the location where the printer is being used.

 **NOTE:** An incorrect altitude adjustment setting leads to poor printing quality, incorrect indication of remaining toner.

### Values:

---

0m*	Specifies the altitude of the location where the printer is installed.
1000m	
2000m	
3000m	

---

## Secure Settings

Use the *Secure Settings* menu to set a password to limit access to the menus. This prevents items from being changed accidentally.

 **NOTE:** Values marked by an asterisk (\*) are the factory default menu settings.

## Panel Lock

### *Panel Lock Set*

### Purpose:

To restrict access to *Admin Menu* and *Report/List*.

For details see "Panel Lock Function" on page 140.

### Values:

---

Disable*	Does not restrict access to <i>Admin Menu</i> and <i>Report/List</i> .
Enable	Restricts access to <i>Admin Menu</i> and <i>Report/List</i> with a password.
New Password	Sets a password required to access <i>Admin Menu</i> and <i>Report/List</i> .

---

Re-enter	Enters the new password again to confirm.
Current Password <sup>*1</sup>	Enter the current password to disable Panel Lock Set.

<sup>\*1</sup> Current Password is displayed only when changing the setting from Enable to Disable.

### **Change Password**

**Purpose:**

To change a password to limit access to the menus.

**Values:**

Current Password	Enter the current password to change the password.
New Password	Enter the new password.
Re-enter	Enter the new password again to confirm.

 **NOTE:** This item is displayed only when Panel Lock set is set to Enable.

### **Login Error**

**Purpose:**

To set the maximum number of failed login attempts before an administrator is denied access to Admin Menu and Report/List.

**Values:**

Off <sup>*</sup>	Does not set the maximum number of failed login attempts.
On	5times <sup>*</sup> Sets the maximum number of failed login attempts. Available Range: 1 - 10times

 **NOTE:** This item is available only when Panel Lock Set is set to Enable.

### **S/W Download**

**Purpose:**

To enable or disable download of firmware updates.

**Values:**

Enable <sup>*</sup>	Enables firmware updates.
Disable	Disables firmware updates.

## Panel Language

Purpose:

To specify the language to be used on the operator panel.











Values:



English*
Français
Italiano
Deutsch
Español
Dansk
Nederlands
Norsk
Svenska





## Panel Lock Function

This feature prevents unauthorized users from changing settings made by the administrator. However, you can select settings for individual print jobs using the printer driver.







### Enabling the Panel Lock





- 1 Press the  (Menu) button.
- 2 Press the  button until Admin Menu appears, and then press the  (Set) button.
- 3 Press the  button until Secure Settings appears, and then press the  (Set) button.
- 4 Ensure that Panel Lock appears, and then press the  (Set) button.
- 5 Ensure that Panel Lock Set appears, and then press the  (Set) button.
- 6 Press the  button until Enable appears, and then press the  (Set) button.
- 7 Enter the new password, and then press the  (Set) button.
- 8 Re-enter the password to confirm the password that you entered, and then press the  (Set) button.

 **NOTE:** If you forget your password, turn off the printer. Then, while holding the  (Menu) button, turn on the printer. Continue to hold the  (Menu) button until New Password appears. Perform step 7 and 8. The display will briefly indicate the password has been changed.

 **NOTE:** If you change the password, perform steps 1 and 2. Enter the current password, and then press the  (Set) button. Perform steps 3 and 4. Press the  button until Change Password appears, and then press the  (Set) button. Enter the current password, and then press the  (Set) button. Perform step 7 and 8. This will change the password.

### Disabling the Panel Lock

- 1 Press the  (Menu) button.
- 2 Press the  button until Admin Menu appears, and then press the  (Set) button.
- 3 Enter the password, and then press the  (Set) button.
- 4 Press the  button until Secure Settings appears, and then press the  (Set) button.
- 5 Ensure that Panel Lock appears, and then press the  (Set) button.



- 6 Ensure that `Panel Lock Set` appears, and then press the  (Set) button.
- 7 Press the  button until `Disable` appears, and then press the  (Set) button.
- 8 Enter the current password, and then press the  (Set) button.









## Resetting Defaults

After executing this function and rebooting the printer, all the menu parameters are reset to their default values.

The following menu parameters are exceptions and are not reset.

- Network settings
- Panel Lock settings and password
- Login Error settings
- USB Port settings

 **NOTE:** A Password is required to enter the `Admin Menu` menu when `Panel Lock Set` is set to `Enable`. In this case, enter the password you specified, and press the  (Set) button.

- 1 Press the  (Menu) button.
- 2 Press the  button until `Admin Menu` appears, and then press the  (Set) button.
- 3 Press the  button until `Maintenance` appears, and then press the  (Set) button.
- 4 Press the  button until `Reset Defaults` appears, and then press the  (Set) button.
- 5 Ensure that `Are you sure?` appears, and then press the  (Set) button.
- 6 Turn off the printer, and turn it on again to apply the settings.





# Print Media Guidelines

Print media can be paper, labels, envelopes, and coated paper among others. Your printer provides high-quality printing on a variety of print media. Selecting the appropriate print media for your printer helps avoid printing troubles. This section describes selecting print media, caring for print media, and loading the print media in Multipurpose Feeder (MPF) or Priority Sheet Inserter (PSI).

 **NOTE:** The images used in this manual are those of the Dell™ C1760nw Color Printer unless otherwise mentioned.

 **NOTE:** PSI is available only for Dell C1760nw Color Printer.

## Paper

For the best print quality in color, use 75 g/m<sup>2</sup> (20 lb) xerographic, grain long paper. For the best print quality in black and white, use 90 g/m<sup>2</sup> (24 lb) xerographic, grain long paper. Before buying large quantities of any print media, it is recommended that you try a sample first.

When loading paper, identify the recommended print side on the paper package, and load the paper accordingly. See "Loading Print Media in the Multipurpose Feeder (MPF)" on page 151 and "Loading Print Media in the Priority Sheet Inserter (PSI) (Dell C1760nw Color Printer only)" on page 159 for detailed loading instructions.

### Paper Characteristics

The following paper characteristics affect print quality and reliability. It is recommended that you follow these guidelines when evaluating new paper stock.

#### Weight

Both MPF and PSI automatically feed paper whose weights range from 60 to 163 g/m<sup>2</sup> (16 to 44 lb bond) grain long. Paper lighter than 60 g/m<sup>2</sup> (16 lb) may not feed properly, and could cause paper jams. For best performance, use 75 g/m<sup>2</sup> (20 lb bond) grain long paper.

#### Curl

Curl is the tendency of print media to curve at its edges. Excessive curl can cause paper feeding problems. Curl usually occurs after the paper passes through the printer, where it is exposed to high temperatures. Storing paper unwrapped, even in the paper feeder, can contribute to paper curling prior to printing and cause feeding problems regardless of humidity. When printing on curled paper, straighten the paper and then insert it into the MPF or PSI.

#### Smoothness

The degree of paper smoothness directly affects print quality. If the paper is too rough, the toner does not fuse to the paper properly, resulting in poor print quality. If the paper is too smooth, it can cause paper feeding problems. Smoothness between 150 and 250 Sheffield points produces the best print quality.

#### Moisture Content

The amount of moisture in the paper affects both print quality and the ability of the printer to feed the paper properly. Leave the paper in its original packaging until you are ready to use it. This limits the exposure of the paper to moisture changes that can degrade its performance.

#### Grain Direction

Grain refers to the alignment of the paper fibers in a sheet of paper. Grain is either grain long, running the length of the paper, or grain short, running the width of the paper. For 60 to 135 g/m<sup>2</sup> (16 to 36 lb bond) paper, grain long fibers are recommended. For paper heavier than 135 g/m<sup>2</sup> (36 lb bond), grain short is preferred.

## Fiber Content

Most high-quality xerographic paper is made from 100% chemically pulped wood. Paper containing fibers such as cotton possess characteristics that can result in degraded paper handling.

## Recommended Paper

To ensure the best print quality and feed reliability, use dry 75 g/m<sup>2</sup> (20 lb) xerographic paper. Business paper designed for general business use also provide acceptable print quality. Only use paper able to withstand high temperatures without discoloring, bleeding, or releasing hazardous emissions. The laser printing process heats paper to high temperatures. Check with the manufacturer or vendor to determine whether the paper you have chosen is acceptable for laser printers.



**NOTE:** Always print several samples before buying large quantities of any type of print media. When choosing any print media, you should consider the weight, fiber content, and color.

## Unacceptable Paper

The following paper types are not recommended for use with the printer:

- Chemically treated paper used to make copies without carbon paper, also known as carbonless paper, carbonless copy paper (CCP), or no carbon required (NCR) paper
- Preprinted paper with chemicals that may contaminate the printer
- Preprinted paper that can be affected by the temperature in the fusing unit
- Preprinted paper that require a registration (the precise print location on the page) greater than  $\pm 0.09$  inches, such as optical character recognition (OCR) forms

In some cases, you can adjust registration with your software program to successfully print on these forms.

- Coated paper (erasable bond), synthetic paper, thermal paper
- Rough-edged, rough or heavily textured surface paper, or curled paper
- Recycled paper containing more than 25% post-consumer waste that do not meet DIN 19 309
- Multiple-part forms or documents
- Print quality may deteriorate (blank spaces or blotches may appear in the text) when printing on talc or acid paper.
- Moist paper that may cause wrinkle

## Selecting Paper

Proper paper selection helps prevent jams and ensures trouble-free printing.

To help avoid jams or poor print quality:

- Always use new, dry, and undamaged paper.
- Before loading the paper, identify the recommended print side of the paper. This information is usually indicated on the paper package.
- Do not use paper that you have cut or trimmed yourself.
- Do not mix print media sizes, weights, or types in the same source. This may result in a paper jam.
- Do not remove the PSI while a job is printing.
- Ensure that the paper is properly loaded in the MPF or PSI.
- Flex paper back and forth, and then fan them. Straighten the edges of the stack on a level surface.

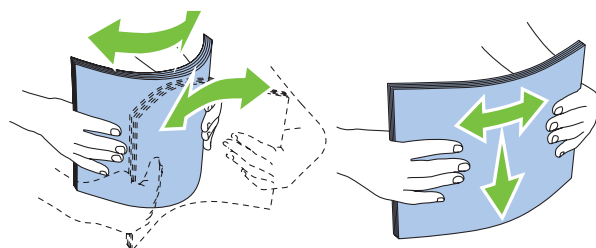

## Selecting Preprinted Media and Letterhead

When selecting preprinted media and letterhead paper for the printer:

- Use grain long paper for best results.
- Use only forms and letterhead printed using an offset lithographic or engraved printing process.
- Select paper that absorb ink, but do not bleed.
- Avoid paper with rough or heavily textured surfaces.
- Use paper printed with heat-resistant inks designed for use in xerographic copying machines. The ink must withstand temperatures of 225°C (437°F) without melting or releasing hazardous emissions.
- Use inks that are not affected by the resin in toner or the silicone in the fusing unit. Inks that are oxidation-set or oil-based should meet these requirements; latex inks might not. If you are in doubt, contact your paper supplier.

## Printing on Letterhead

Check with the manufacturer or vendor to determine whether the pre-printed letterhead you have selected is acceptable for laser printers.

Page orientation is important when printing on letterhead. Use the following illustration for help when loading letterhead in the print media sources.

## Loading Letterhead

Load the letterhead in the printer with the print side facing up. Ensure that the title on the letterhead enters the printer first.

Multipurpose Feeder (MPF)

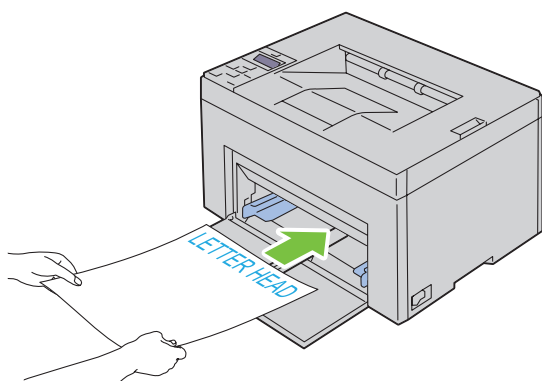

Priority Sheet Inserter (PSI)

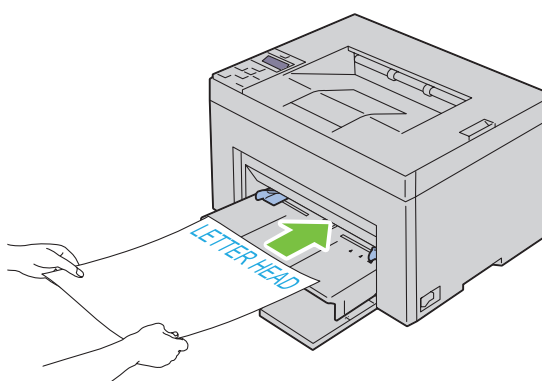

## Selecting Pre-Punched Paper

Pre-punched paper brands can differ in the number and placement of holes and in manufacturing techniques. However, it may not be possible to print on the paper depending on the placement of holes on the paper.

To select and use pre-punched paper:

- Test paper from several manufacturers before ordering and using large quantities of pre-punched paper.
- Paper should be punched at the paper manufacturer and not drilled into paper already packaged in a ream. Drilled paper can cause jams when multiple sheets feed through the printer. This may result in a paper jam.
- Pre-punched paper can include more paper dust than standard paper. Your printer may require more frequent cleaning and feed reliability may not be as good as standard paper.
- Weight guidelines for pre-punched paper are the same as non-punched paper.

## Envelopes

Depending on the choice of envelopes, it is possible to expect variable levels of light wrinkling. Before buying large quantities of any print media, it is recommended that you try a sample first. See "Loading Print Media in the Multipurpose Feeder (MPF)" on page 151 or "Loading Print Media in the Priority Sheet Inserter (PSI) (Dell C1760nw Color Printer only)" on page 159 for instructions on loading an envelope.

When printing on envelopes:

- Use only high-quality envelopes that are designed for use in laser printers.
- Set the print media source to MPF or PSI. Set the paper type to **Envelope**, and select the correct size of envelope from the printer driver.
- For best performance, use envelopes made from 75 g/m<sup>2</sup> (20 lb bond) paper. You can use up to 105 g/m<sup>2</sup> (28 lb bond) weight for the envelope feeder as long as the cotton content is 25% or less. Envelopes with 100% cotton content must not exceed 90 g/m<sup>2</sup> (24 lb bond) weight.
- Use only freshly unpackaged, undamaged envelopes.
- Use envelopes that can withstand temperatures of 205°C (401°F) without sealing, excessive curling, wrinkling, or releasing hazardous emissions. If you have any doubts about the envelopes you are considering, check with the envelope supplier.
- Adjust the guide to fit the width of the envelopes.
- To load envelope in MPF or PSI, the print side must be facing up.
- See "Loading Envelopes in the Multipurpose Feeder (MPF)" on page 156 or "Loading an Envelope in the Priority Sheet Inserter (PSI)" on page 161 for instructions on loading an envelope.
- Use one envelope size during a print job.
- Ensure that the humidity is low because high humidity (more than 60%) and the high printing temperatures may seal the envelopes.
- For best performance, do not use envelopes that:
  - Have excessive curl or twist
  - Are stuck together or damaged in any way
  - Contain windows, holes, perforations, cutouts, embossing
  - Use metal clasps, string ties, or metal folding bars
  - Have an interlocking design
  - Have postage stamps attached
  - Have nicked edges or bent corners

- Have rough, cockle, or laid finishes

## Labels

Your printer can print on many labels designed only for use with laser printers.

When selecting labels:

- Label adhesives, face sheet (printable stock), and topcoats must be able to withstand temperatures of 205°C (401°F) and pressure of 25 pounds per square inch (psi).
- Use labels that can be without sealing, excessive curling, wrinkling, or releasing hazardous emissions.
- Do not use label sheets with a slick backing material.

 **CAUTION: Before buying large quantities of any print media, it is recommended that you try a sample first.**

When printing on labels:

- Use labels that can withstand temperatures of 205°C (401°F) without sealing, excessive curling, wrinkling, or releasing hazardous emissions.
- Set the paper type to **Label** from the printer driver.
- Do not load labels together with paper in the same tray.
- Do not print within 1 mm (0.04 inches) of the die-cut.
- Do not print within 1 mm (0.04 inches) of the edge of the label, of the perforations, or between die-cuts of the label.
- Do not print a label through the printer more than once.
- Portrait orientation is preferred, especially when printing bar codes.
- Do not use labels that have exposed adhesive.
- Use full label sheets. Partial sheets may cause labels to peel off during printing, resulting in a jam.
- Do not use label sheets that have adhesive to the edge of the sheet. It is recommended that zone coating of the adhesive is done at least 1 mm (0.04 inches) away from edges. Adhesive material contaminates your printer and could void your warranty.

 **WARNING: Otherwise a jam occurs in the printer and contaminate your printer and your cartridges with adhesive. As a result, could void your printer and cartridge warranties.**

## Storing Print Media

For proper print media storage, the following guidelines help avoid media feeding problems and uneven print quality.

- For best results, store print media in an environment where the temperature is approximately 21°C (70°F) and the relative humidity is 40%.
- Store cartons of print media on a pallet or shelf, rather than directly on the floor.
- If you store individual packages of print media out of the original carton, ensure that they rest on a flat surface so that the edges do not buckle or curl.
- Do not place anything on top of the print media packages.

# Identifying Print Media and Specifications

This section provides information on supported paper sizes, types, and specification.

## Supported Paper Sizes

	Multipurpose Feeder (MPF)	Priority Sheet Inserter (PSI)
A4 (210x297 mm)	Y	Y
B5 (182x257 mm)	Y	Y
A5 (148x210 mm)	Y	Y
C5 (162x229 mm)	Y	Y
Monarch (3.875x7.5 in)	Y	Y
Monarch LEF (7.5x3.875 in) <sup>*1</sup>	Y	Y <sup>*4</sup>
Envelope #10 (4.125x9.5 in)	Y	Y
DL (110x220 mm)	Y	Y
DL LEF (220x110 mm) <sup>*1</sup>	Y	Y <sup>*4</sup>
Letter (8.5x11 in)	Y	Y
Legal (8.5x14 in)	Y	Y
Folio (8.5x13 in)	Y	Y
Executive (7.25 x 10.5 in)	Y	Y
Custom <sup>*2*3</sup>	Y	Y

<sup>\*1</sup> You can place the originals in a long-edge feed direction or in a short-edge feed direction. The following illustration shows SEF and LEF. The arrow mark in the illustration shows the orientation of the paper loading.

**NOTE:** Not available when the XML Paper Specification (XPS) Printer Driver is used.

<sup>\*2</sup> Custom width: 76.2 mm (3.00 inches) to 215.9 mm (8.50 inches)  
 The maximum width for envelope (DL LEF): 220 mm (8.66 inches)  
 Custom length: 127 mm (5.00 inches) to 355.6 mm (14.00 inches)  
 The maximum length for envelope (Monarch LEF): 98.4 mm (3.87 inches)

<sup>\*3</sup> Only the administrator user can set the custom size from the printer driver.

<sup>\*4</sup> Be sure to fully insert the envelope until it stops. Otherwise, print media that is loaded on the MPF will be fed.

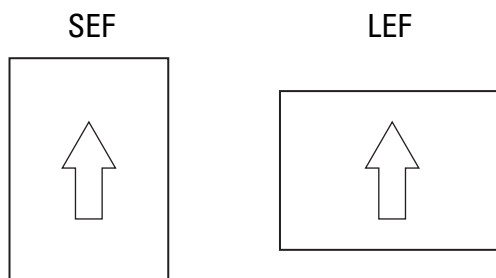

## Supported Paper Types

Media	Multipurpose Feeder (MPF)	Priority Sheet Inserter (PSI)
Plain	Y*	Y*
Plain Side 2	Y	Y
Plain Thick	Y	Y
Plain Thick Side 2	Y	Y
Recycled	Y	Y
Recycled Side 2	Y	Y
Label	Y	Y
Covers	Y	Y
Covers Side 2	Y	Y
Envelope	Y	Y
Coated	Y	Y
Coated Side 2	Y	Y

\* Values marked by an asterisk (\*) are the factory default menu settings.

## Paper Type Specifications

Paper type	Weight (gsm)	Remarks
Plain Paper	60–90	-
Plain Thick Paper	91–105	-
Covers	106–163	-
Coated	106–163	Inkjet printer paper cannot be used.
Label	-	Inkjet printer paper cannot be used.
Envelopes	-	-
Recycled	60–105	-







## Loading Print Media

Loading print media properly helps prevent jams and ensures trouble-free printing.

Before loading print media, identify the recommended print side of the print media. This information is usually on the print media package.

 **NOTE:** The images used in this manual are those of the Dell™ C1760nw Color Printer unless otherwise mentioned.

 **NOTE:** Priority Sheet Inserter (PSI) is available only for Dell C1760nw Color Printer.

### Capacity

Multipurpose Feeder (MPF) can hold:

- 150 sheets of standard paper
- 16.2 mm (0.64 inches) of thick paper
- One sheet of coated paper
- 16.2 mm (0.64 inches) of post cards
- Five envelopes
- 16.2 mm (0.64 inches) of labels

Priority Sheet Inserter (PSI) can hold:

- 10 sheets of standard paper or one sheet of other paper

### Print Media Dimensions

Both MPF and PSI accept print media within the following dimensions:

- Width — 76.2 mm (3.00 inches) to 215.9 mm (8.50 inches)
- Length — 127.0 mm (5.00 inches) to 355.6 mm (14.00 inches)

### Loading Print Media in the Multipurpose Feeder (MPF)

 **NOTE:** PSI is available only for Dell C1760nw Color Printer.

 **NOTE:** Use only laser print media. Do not use ink jet paper in this printer.

- 1 Open the front cover.

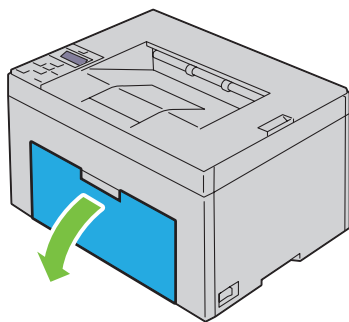

2 Pull the PSI out.

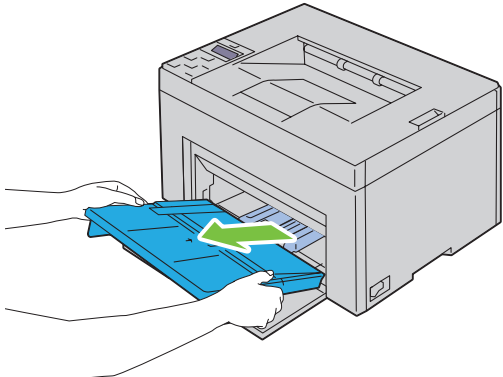

3 Pull the length guide forward until it stops.

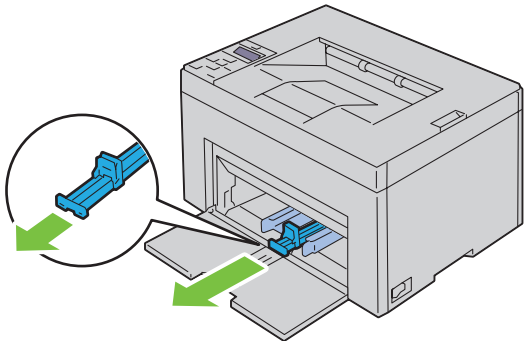

4 Pull the MPF extension forward until it stops.

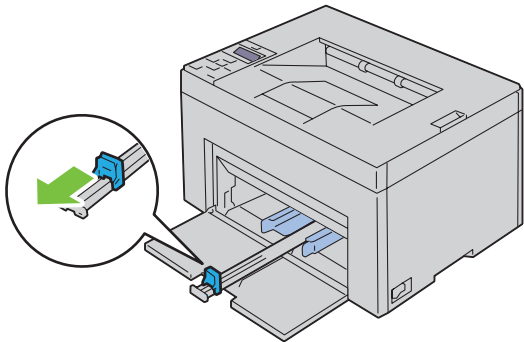

- 5 Adjust the paper width guides to their maximum.

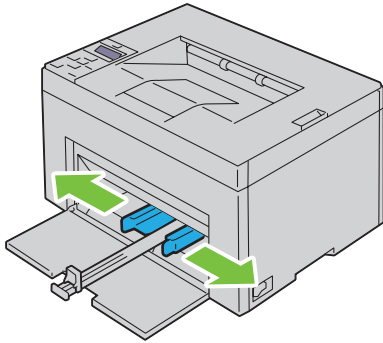

- 6 Before loading the print media, flex the sheets back and forth, and then fan them. Straighten the edges of the stack on a level surface.

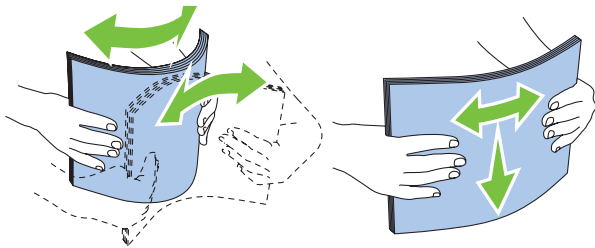

- 7 Load print media on the MPF with the top edge first and with the recommended print side facing up.

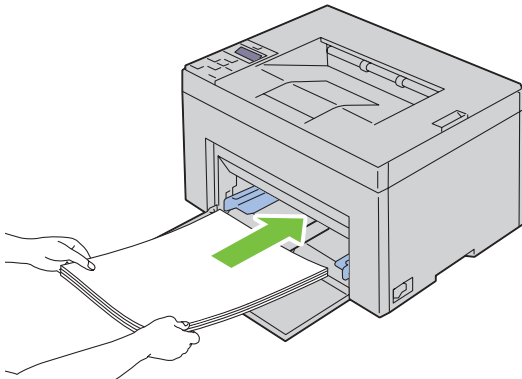

8 Adjust the width guides until they rest lightly against the edges of the stack of print media.

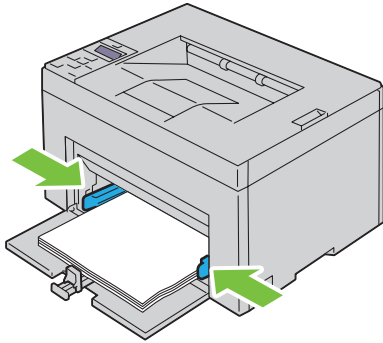

9 Slide the length guide towards the printer until it touches the print media.

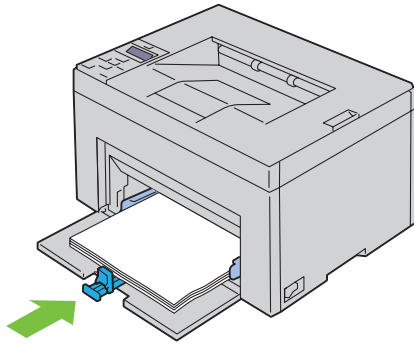

 **NOTE:** Depending on the size of print media, first slide the length guide backward until it stops, and then slide the MPF extension until it touches print media.

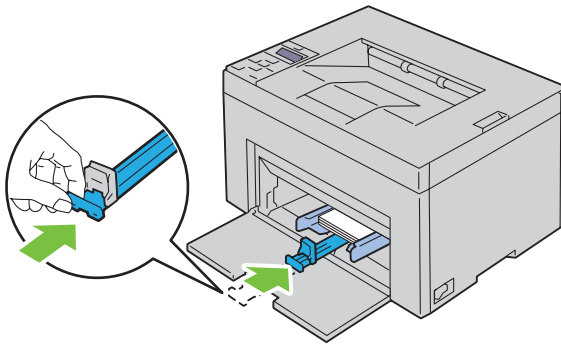

**10** Insert the PSI into the printer and then align the PSI to the marking on the paper tray.

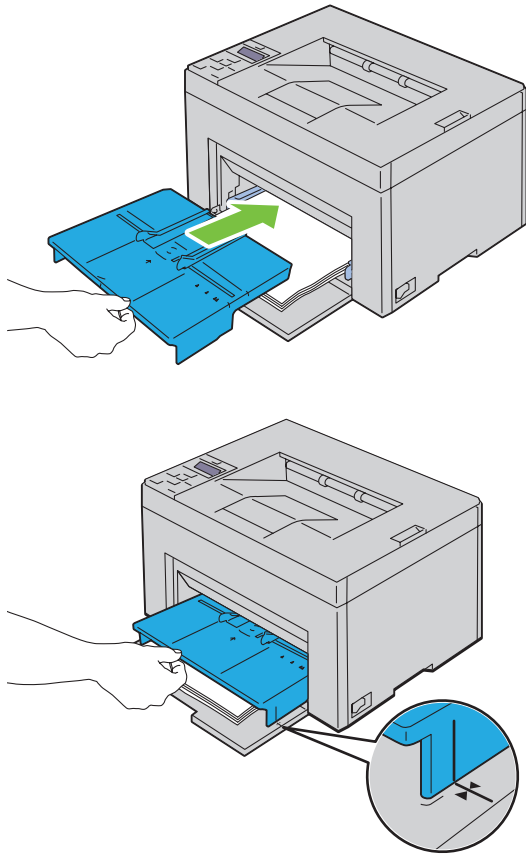

## Loading Envelopes in the Multipurpose Feeder (MPF)

 **NOTE:** When you print on envelopes, be sure to specify the envelope setting on the printer driver. If not specified, the print image will be rotated 180 degrees.

### When Loading Envelope #10, DL, or Monarch

Load envelopes with the side to be printed on facing up, the flap side facing down, and the flap turned to the right.

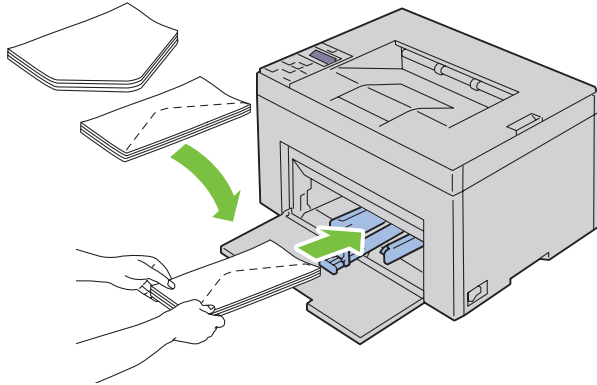

To prevent DL and Monarch from being wrinkled, they are recommended to be loaded with the print-side facing up, flap opened, and facing you.

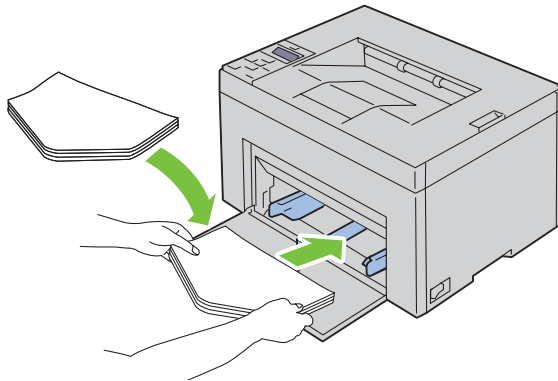

### When Loading C5

Load envelopes with the side to be printed on facing up, with the flap open.

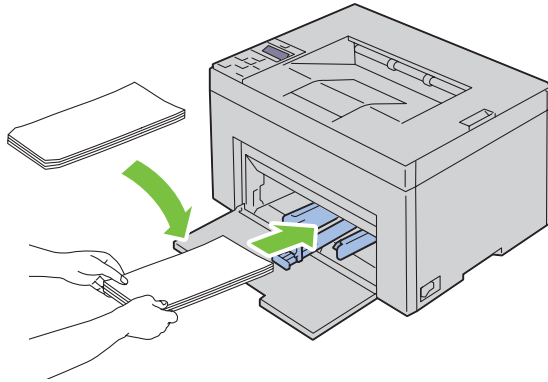

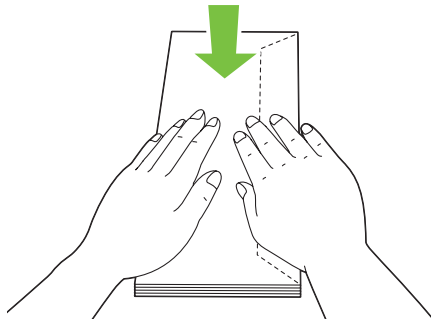

**CAUTION:** Never use envelopes with windows, or coated linings. These lead to paper jams and can cause damage to the printer.

**NOTE:** If you do not load envelopes in the MPF right after they have been removed from the packaging, they may bulge. To avoid jams, flatten them as shown below when loading them in the MPF.

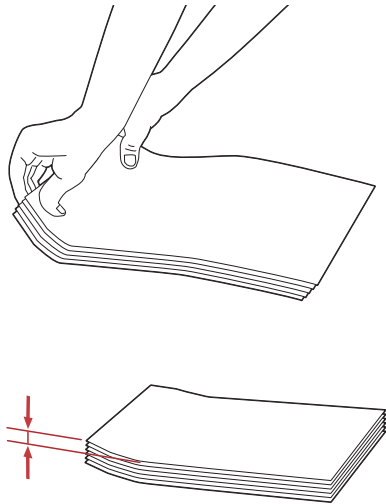

 **NOTE:** If envelopes are still not fed correctly, add some bending to the flap of the envelopes as shown in the following illustration.  
The amount of the bending shall be 5 mm (0.20 inches) or less.



 **NOTE:** To confirm the correct orientation of each print media such as envelopes, see the instruction on the Envelope/Paper Setup Navigator on the printer driver.

### Loading Letterhead

Load the letterhead in the printer with the print side facing up. Ensure that the title on the letterhead enters the printer first.

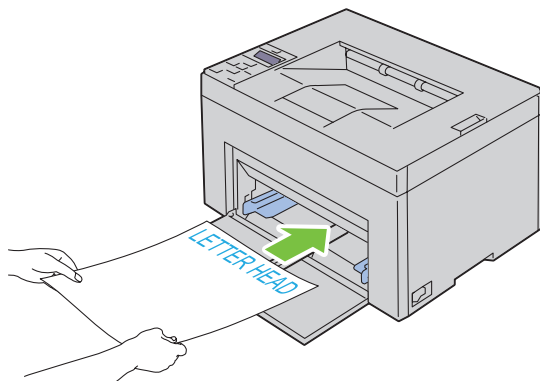



## Loading Print Media in the Priority Sheet Inserter (PSI) (Dell C1760nw Color Printer only)

 **NOTE:** To avoid paper jams, do not remove the PSI while printing is in progress.

 **NOTE:** Use only laser print media. Do not use ink jet paper in this printer.

- 1 Open the front cover.

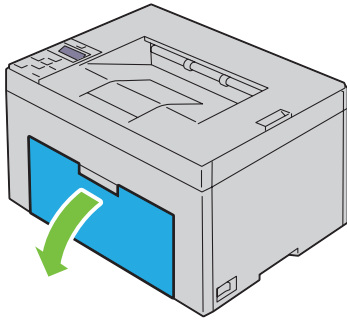

- 2 Slide the PSI forward, and then align the PSI to the marking on the paper tray.

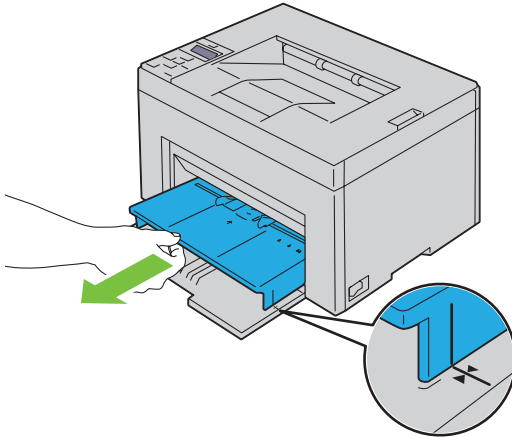

- 3 Adjust the paper width guides to their maximum.

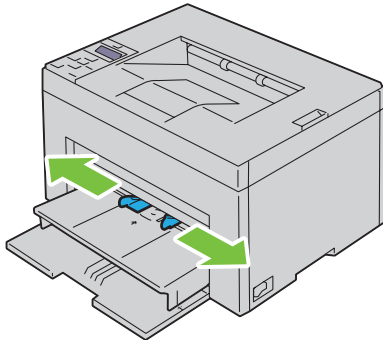

- 4 Before loading the print media, flex the sheets back and forth, and then fan them. Straighten the edges of the stack on a level surface.

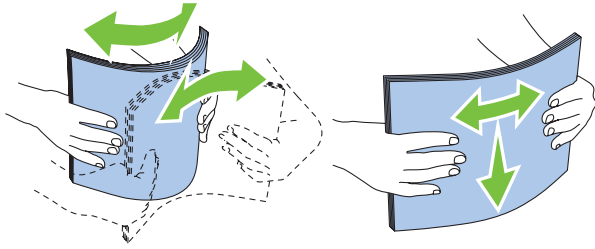

- 5 Load print media on the PSI with the top edge first and with the recommended print side facing up.

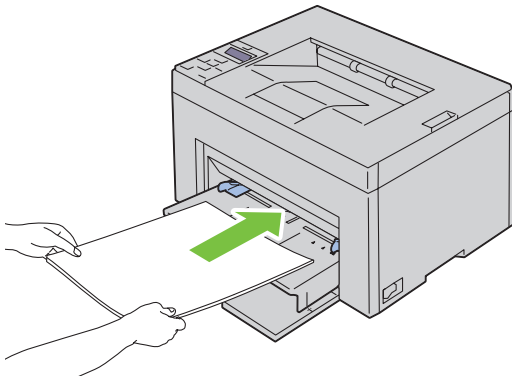

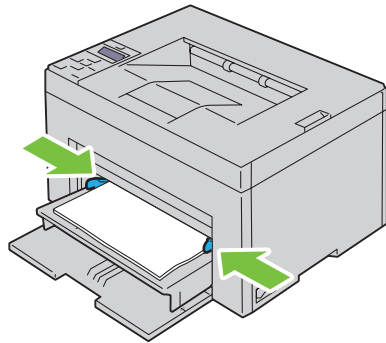

- 6 Adjust the width guides until they rest lightly against the edges of the stack of print media.



- 7 Select the paper type from the printer driver if the loaded print media is not standard plain paper. If a user-specified print media is loaded in the PSI, you must specify the paper size setting by using the printer driver.

## Loading an Envelope in the Priority Sheet Inserter (PSI)

 **NOTE:** Be sure to fully insert the envelope until it stops. Otherwise, print media that is loaded on the MPF will be fed.

 **NOTE:** When you print on envelopes, be sure to specify the envelope setting on the printer driver. If not specified, the print image will be rotated 180 degrees.

### When Loading Envelope #10, DL, or Monarch

Load an envelope with the side to be printed on facing up, the flap side facing down, and the flap turned to the right.

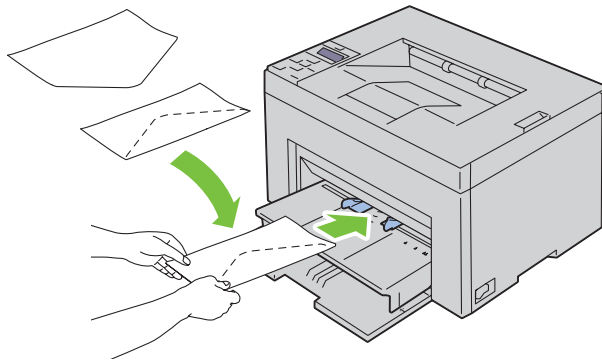

To prevent DL and Monarch from being wrinkled, they are recommended to be loaded with the print-side facing up, flap opened, and facing you.

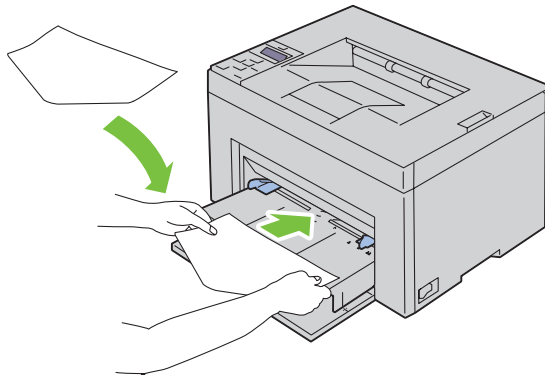

### When Loading C5

Load envelopes with the side to be printed on facing up, with the flap open.

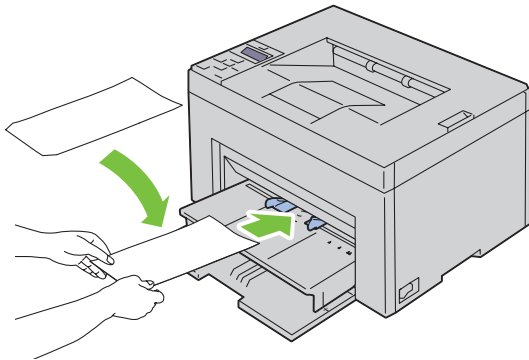

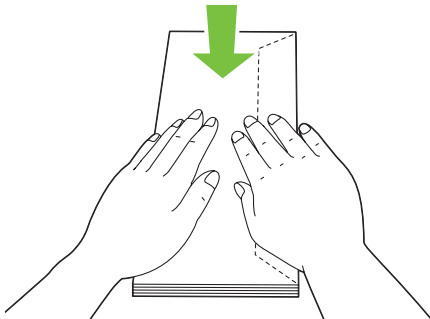

**⚠ CAUTION:** Never use envelopes with windows, or coated linings. These lead to paper jams and can cause damage to the printer.

**📝 NOTE:** If you do not load envelopes in the PSI right after they have been removed from the packaging, they may bulge. To avoid jams, flatten them as shown below when loading them in the PSI.

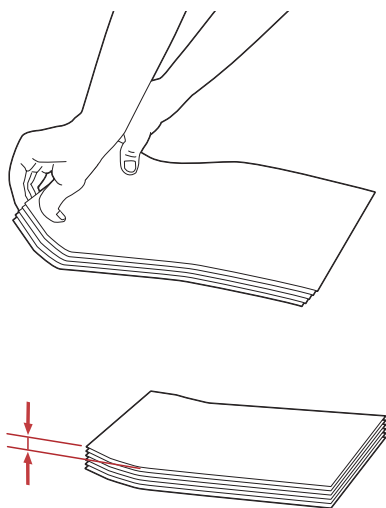

 **NOTE:** If envelopes are still not fed correctly, add some bending to the flap of the envelopes as shown in the following illustration.  
The amount of the bending shall be 5 mm (0.20 inches) or less.



 **NOTE:** To confirm the correct orientation of each print media such as envelopes, see the instruction on the Envelope/Paper Setup Navigator on the printer driver.

### Loading Letterhead

Load the letterhead in the printer with the print side facing up. Ensure that the title on the letterhead enters the printer first.

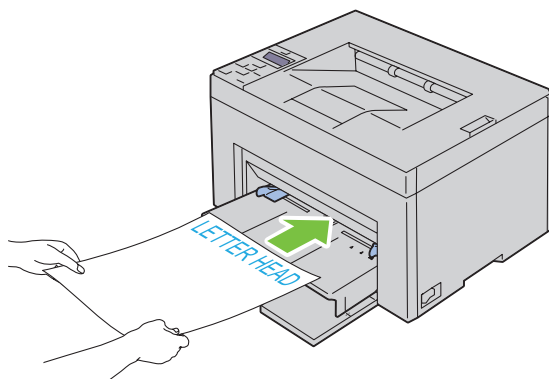

## Loading Print Media When Manual Duplex Printing

**NOTE:** When printing on curled paper, straighten the paper and then insert it into the feeder.

When you start manual duplex printing, the instruction window appears. Note that the window cannot be reopened once it is closed. Do not close the window until duplex printing is complete.

Manual duplex printing can be done using the MPF or PSI.

### When Using the Multipurpose Feeder (MPF)

- 1 First print the even pages (rear sides).  
For a six page document, rear sides are printed in the order of page 6, page 4, then page 2.  
The orange LED lights and the message appears on the operator panel when the even pages finish printing.

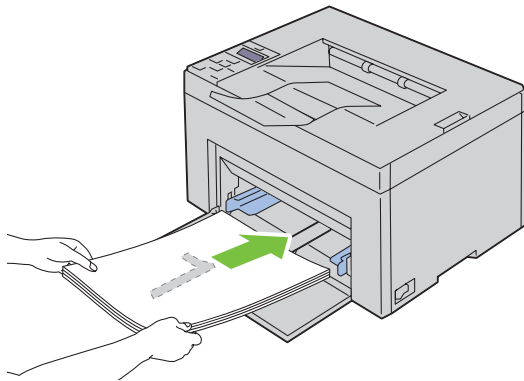

- 2 After the even pages are printed, remove the paper stack from the output tray and set them as they are (with the blank side facing up) into the MPF.

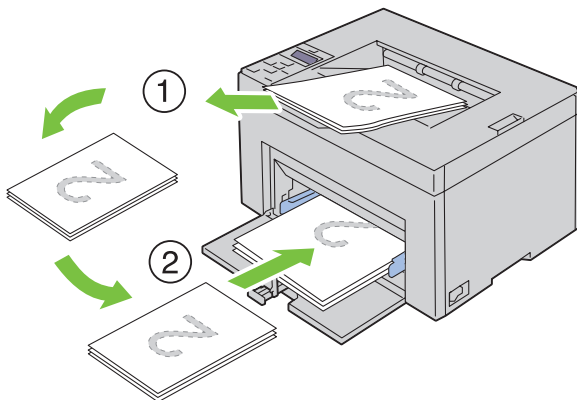

**NOTE:** Warped or curled prints can cause paper jams. Straighten them before setting them.

**NOTE:** Printing on both sides of the paper is not possible if the document consists of various sizes of papers.

- 3 Ensure that Insert Output into paper tray appears, and then press the ✓ (Set) button. Print pages in the order page 1 (rear of page 2), page 3 (rear of page 4), then page 5 (rear of page 6).

### When Using the Priority Sheet Inserter (PSI) (Dell C1760nw Color Printer only)

- 1 First print the even pages (rear sides).  
For a six page document, rear sides are printed in the order of page 6, page 4, then page 2.  
The orange LED lights and the message appears on the operator panel when the even pages finish printing.

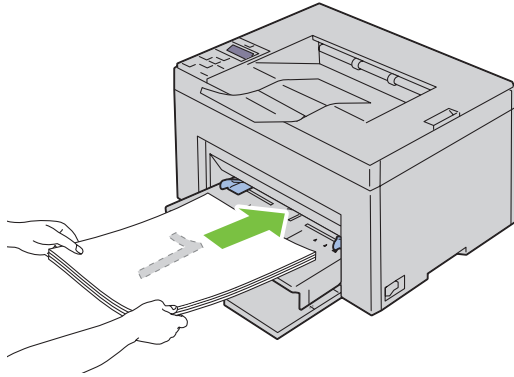

- 2 After the even pages are printed, remove the paper stack from the output tray and set them as they are (with the blank side facing up) into the PSI.

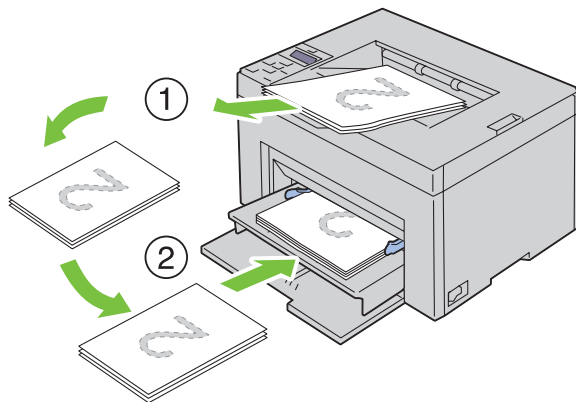

 **NOTE:** Warped or curled prints can cause paper jams. Straighten them before setting them.

 **NOTE:** Printing on both sides of the paper is not possible if the document consists of various sizes of papers.

- 3 Ensure that Insert Output into paper tray appears, and then press the ✓ (Set) button. Print pages in the order page 1 (rear of page 2), page 3 (rear of page 4), then page 5 (rear of page 6).

## Using the Output Tray Extension

The output tray extension is designed to prevent print media from falling from the printer after the print job is complete.

Before printing a document, ensure that the output tray extension is fully extended.

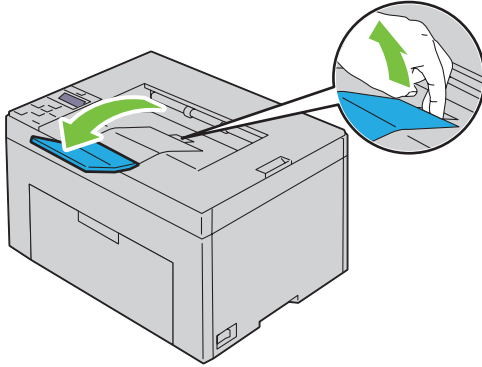



# Printing

17 Printing..... 169



# Printing

This chapter covers tips for printing, how to print certain lists of information from your printer, and how to cancel a job.

## Tips for Successful Printing

### Tips on Storing Print Media

Store your print media properly. For more information, see "Storing Print Media" on page 187.

### Avoiding Paper Jams

 **NOTE:** It is recommended that you try a limited sample of any print media you are considering using with the printer before purchasing large quantities.

By selecting appropriate print media and loading it properly, you can avoid paper jams. See the following instructions on loading print media:

- "Loading Print Media in the Multipurpose Feeder (MPF)" on page 151
- "Loading Print Media in the Priority Sheet Inserter (PSI) (Dell C1760nw Color Printer only)" on page 159
- "Avoiding Jams" on page 201

If you experience a jam, see "Jam" on page 223 for instructions.

## Sending a Job to Print

To support all of the printer features, use the printer driver. When you choose **Print** from an application, a window representing the printer driver opens. Select the appropriate settings for the specific job you are sending to print. Print settings selected from the driver have precedence over the default menu settings selected from the operator panel or **Tool Box**.

You may need to click **Preferences** from the initial **Print** box to see all of the available system settings you can change. If you are not familiar with a feature in the printer driver window, open the online Help for more information.

To print a job from a typical Microsoft® Windows® application:

- 1 Open the file you want to print.
- 2 From the **File** menu, select **Print**.
- 3 Verify that the correct printer is selected in the dialog box. Modify the system settings as needed (such as the pages you want to print or the number of copies).
- 4 Click **Preferences** to adjust system settings not available from the first screen, and then click **OK**.
- 5 Click **OK** or **Print** to send the job to the selected printer.

## Canceling a Print Job

There are several methods for canceling a print job.

### Canceling From the Operator Panel

To cancel a job after it has started printing:

- 1 Press the **X** (Cancel) button.

 **NOTE:** Printing is canceled only for the current job. All the following jobs will continue to print.

### Canceling a Job From the Computer Running Windows

#### Canceling a Job From the Taskbar

When you send a job to print, a small printer icon appears in the right corner of the taskbar.

- 1 Double-click the printer icon.  
A list of print jobs appears in the printer window.
- 2 Select the job you want to cancel.
- 3 Press <Delete> on the keyboard.

#### Canceling a Job From the Desktop

- 1 Minimize all programs to reveal the desktop.  
Click **Start** → **Devices and Printers** (for Windows 7 and Windows Server® 2008 R2).  
Click **Start** → **Printers and Faxes** (for Windows XP).  
Click **Start** → **Control Panel** → **Hardware and Sound** → **Printers** (for Windows Vista®).  
Click **Start** → **Control Panel** → **Printers** (for Windows Server 2008).  
Right-click the bottom left corner of the screen, and then click **Control Panel** → **Hardware and Sound** → **Devices and Printers** (for Windows 8).  
Right-click the bottom left corner of the screen, and then click **Control Panel** → **Hardware** → **Devices and Printers** (for Windows Server 2012).  
A list of available printers appears.
- 2 Right-click the printer that you selected when you sent the job for print, and then select **See what's printing**.
- 3 Select the printer driver.  
A list of print jobs appears in the printer window.
- 4 Select the job you want to cancel.
- 5 Press <Delete> on the keyboard.

## Printing a Report Page

By using the **Report/List** menu, you can print a various of settings for your printer including printer settings. For details about how to print reports or lists, see "Report/List" on page 125.

# Know Your Printer

18 Understanding Your Printer Software .....	173
19 Understanding Printer Messages .....	177
20 Specifications .....	181



# Understanding Your Printer Software

Use the *Software and Documentation* disc that shipped with your printer to install a combination of software programs, depending on your operating system.

 **NOTE:** The images used in this manual are those of the Dell™ C1760nw Color Printer unless otherwise mentioned.

## Windows®

### Printer Status Window

The **Printer Status** window alerts you when there is a warning or when an error occurs, for example, when a paper jam occurs or toner is running low.

By default, the **Printer Status** window launches only when an error occurs. When an error occurs, the error message appears on the **Printer Status** window. You can set the **Printer Status** window to always launch when printing in **Printing Status Window Properties**.

You can also check the toner level of your printer.

### Status Monitor Console

Use the **Status Monitor Console** to manage multiple instances of the **Status Window** for a particular printer.

Select a printer from the list view (or **Printer Selection**) by clicking its name to open a **Status Window** for a particular printer.

### Dell Supplies Management System

You can launch the **Dell Supplies Management System** dialog box from the **All Programs** menu or the desktop icon.

You can order consumables by phone or from the web.

- 1 Click **Start** → **All Programs** → **Dell Printers** → **Additional Color Laser Software** → **Dell Supplies Management System**.

The **Dell Supplies Management System** window appears.

- 2 Select your printer from the **Select Printer Model** list.

- 3 If you are ordering from the web:

- a Select a web address from the **Select Reorder URL** list.

- b Click **Visit Dell printer supplies ordering web site**.

**Dell C1760nw Color Printer/Dell C1660w Color Printer - Dell Supplies Management System** window appears.

- c Enter the **Service Tag**, and then click **OK**.

If you order by phone, call the number that appears in the **Order by Phone** section.

## Quick Launch Utility

Using the **Quick Launch Utility** window, you can open **Status Window**, **Tool Box**, and **Troubleshooting**.

To use the **Quick Launch Utility**, select to install the **Quick Launch Utility** when you install the Dell software.

To open the **Quick Launch Utility** window:

- 1 Click **Start** → **All Programs** → **Dell Printers** → **Additional Color Laser Software** → **Quick Launch Utility**.  
The **Quick Launch Utility** dialog box opens.

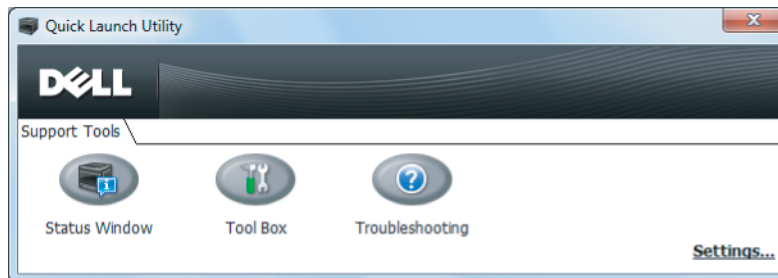

- 2 The **Quick Launch Utility** window provides three buttons; **Status Window**, **Tool Box**, and **Troubleshooting**.  
To exit, click **X** at the top-right of the window.  
For details, click **Help** of each application.

Status Window	Click to open the <b>Printing Status</b> window. See "Printer Status Window" on page 173.
Tool Box	Click to open the Tool Box. See "Understanding the Tool Box Menus" on page 111.
Troubleshooting <sup>*1</sup>	Click to open the Troubleshooting Guide, which allows you to resolve issues by yourself.

<sup>\*1</sup> Troubleshooting Guide is the Portable Document Format (PDF) file. This item needs software to view the document.

## Macintosh

### Status Monitor Widget

**Status Monitor Widget** is a printer utility that promotes efficient use of the printer through the exchange of information between the Macintosh and the printer.

To open the **Status Monitor Widget**:

- 1 Click the **Dashboard** icon in the **Dock** to launch **Dashboard**.



- 2 Click the **Plus (+)** sign to display the **Widget Bar**.
- 3 Click the icon of **Status Monitor** in the **Widget Bar**. The **Printer Status** window appears.

 **NOTE:** If **Select a printer.** is displayed, select your printer in **Preferences**.



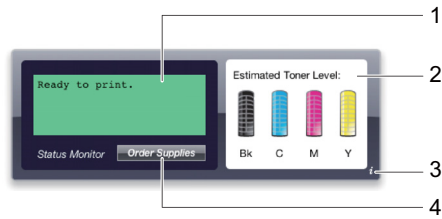

Status Monitor window appears.



### 1 Printer Status Message Area

Displays a message of the current printer status.

 **NOTE:** The **Status Monitor Widget** automatically obtains the printer information at the updated interval that can be specified in **Preferences**. Also, the printer status is refreshed when Dashboard is launched or **Preferences** is closed.

 **NOTE:** If the **Status Monitor Widget** receives no response from the printer, **Cannot get printer information** is displayed.

 **NOTE:** When the printer is connected via USB cable, you cannot check the status of the printer during a print job.

### 2 Printer Status Image Area

Displays the image of printer condition.

- Estimated Toner Level image

Displays the estimated toner level of each color if the printer is functioning properly.

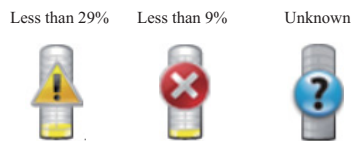

 **NOTE:** If the utility does not receive a response from the printer, the **Unknown** toner image is displayed.

- Printer error image

Displays an indication image when an error occurs.



An error has occurred and the printer cannot be used.

### 3 Info (i) button

Click this button to open **Preferences**.

 **NOTE:** The **Info (i)** button appears on the lower-right corner of the window when the cursor is over the **Status Monitor** window.

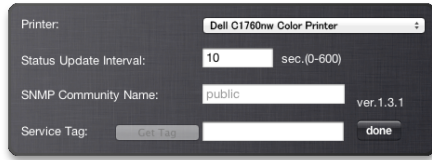

<b>Printer</b>	Displays a list of available printer names in the drop-down list. The first printer displayed in this list is set as default.
<b>Status Update Interval</b>	You can update the interval of the printer status. By default, it is set to obtain the printer information every 10 seconds. The range varies between 0 and 600.
<b>SNMP Community Name</b>	You can change the SNMP (Simple Network Management Protocol) community name if using default community name (public). Up to 31 characters can be entered.
<b>Service Tag button</b>	Click <b>Get Tag</b> to obtain the service tag.
<b>done button</b>	Click this button to return to the <b>Printer Status</b> window.

### 4 Order Supplies button

Click this button to display the **Order** window.

This window provides you with the information for ordering printer supplies by telephone or from the web site.

 **NOTE:** The **Order** window automatically appears when low toner is detected.





<b>Order Online</b>	Select a web address from the drop-down list and click <b>Visit Dell printer supplies ordering web site.</b> hyperlink to access the web site for ordering Dell printer supplies.
<b>Order By Phone</b>	Displays a list of available phone numbers that you can call to order Dell printer supplies.
<b>Dell and the Environment</b>	Click the hyperlink to access the web site about recycling.

## Understanding Printer Messages

The printer operator panel displays messages describing the current state of the printer and indicates possible printer problems you must resolve. This chapter describes messages, their meanings, and how to clear them.

 **CAUTION:** When an error code is displayed, the print data remaining on the printer and the information accumulated in the memory of the printer are not secured.

Error-Code	What you can do
001-360	Turn off the printer, and then on again. If this does not solve the problem, contact Dell™. See "Contacting Dell" on page 230.
003-340	
003-356	
006-370	
007-340	
007-371	
009-654	
010-354	
010-377	
016-302	
016-313	
016-315	
016-317	
016-324	
016-338	
016-340	
016-344	
016-345	
016-346	
016-347	
016-370	
016-383	Press the  (Set) button. Contact Dell if this message appears repeatedly. See "Contacting Dell" on page 230.
016-384	
016-385	
016-386	
016-387	
016-391	
016-392	Turn off the printer, and then on again. If this does not solve the problem, contact Dell. See "Contacting Dell" on page 230.
016-393	
016-394	
016-700	Press the  (Set) button to cancel the current print job. See "Canceling a Print Job" on page 170.
016-720	

<b>Error-Code</b>	<b>What you can do</b>
016-746	Press the ✓ (Set) button. Enable S/W Download and execute the operation again according to the operation procedure. See "Secure Settings" on page 138.
016-799	Press the ✓ (Set) button to cancel the current print job. See "Canceling a Print Job" on page 170.
016-920	Press the ✓ (Set) button. Execute the operation again according to the operation procedure.
016-921	
016-922	Press the ✓ (Set) button. Check that no other wireless LAN access point (Registrar) or router is setting up wireless connection with WPS-PBC (Wi-Fi Protected Setup®-Push Button Configuration), and execute the operation again according to the operation procedure.
016-923	Press the ✓ (Set) button. Check the passphrase for the wireless LAN access point (Registrar) or router and execute the operation again according to the operation procedure.
016-924	Press the ✓ (Set) button. Check the WEP key for the wireless LAN access point (Registrar) or router and execute the operation again according to the operation procedure.
024-360	Turn off the printer, and then on again. If this does not solve the problem, contact Dell. See "Contacting Dell" on page 230.
024-914	Load the specified paper. See "Loading Print Media in the Multipurpose Feeder (MPF)" on page 151 or "Loading Print Media in the Priority Sheet Inserter (PSI) (Dell C1760nw Color Printer only)" on page 159.
024-969	<ul style="list-style-type: none"> <li>• Load the appropriate paper. See "Loading Print Media in the Multipurpose Feeder (MPF)" on page 151 or "Loading Print Media in the Priority Sheet Inserter (PSI) (Dell C1760nw Color Printer only)" on page 159.</li> <li>• For Dell C1660w Color Printer: If there are paper loaded in the MPF and this error is displayed, paper may be jammed. Check and clear the paper path, load the specified paper, and then press the ✓ (Set) button. See "Clearing Paper Jams From the Front of the Printer" on page 203.</li> </ul>
027-452	Change IP address to avoid duplication. Turn off the printer, and then on again.
027-446	
075-100	Check and clear the paper path, load the specified paper, and then press the ✓ (Set) button. See "Clearing Paper Jams From the Front of the Printer" on page 203.
075-921	Load paper for the second side (odd) pages, and press the ✓ (Set) button. See "Loading Print Media When Manual Duplex Printing" on page 164.
077-100	Check and clear the paper path. See "Clearing Jams" on page 201.
077-101	
077-102	Check and clear the paper path. See "Clearing Paper Jams From the Back of the Printer" on page 204.
077-104	Check and clear the paper path. See "Clearing Jams" on page 201.
077-105	
077-300	Close the rear cover.
077-900	Check and clear the paper path. See "Clearing Paper Jams From the Output Tray" on page 206.
077-901	Check and clear the paper path. See "Clearing Jams" on page 201.
092-310	Clean the CTD sensor. See "Cleaning the Color Toner Density (CTD) Sensor" on page 195.
092-910	
093-423	Replace the specified toner cartridge soon. Order a new consumable from <a href="http://www.dell.com/supplies">www.dell.com/supplies</a>
093-424	See "Removing the Toner Cartridges" on page 188.
093-425	
093-426	

<b>Error-Code</b>	<b>What you can do</b>
093-919	Re-install or replace the specified toner cartridge. See "Replacing Toner Cartridges" on page 188.
093-920	
093-921	
093-922	
093-930	Remove the specified toner cartridge and install a new one. If you do not replace the toner cartridge, print quality problems may occur. Order a new consumable from <a href="http://www.dell.com/supplies">www.dell.com/supplies</a>
093-931	
093-932	
093-933	See "Replacing Toner Cartridges" on page 188.
093-940	Re-install the specified toner cartridge. See "Installing a Toner Cartridge" on page 190.
093-941	
093-942	
093-943	
093-960	Replace the specified toner cartridge with the supported one. Order a new consumable from <a href="http://www.dell.com/supplies">www.dell.com/supplies</a>
093-961	
093-962	See "Replacing Toner Cartridges" on page 188.
093-963	
093-970	Re-install the specified toner cartridge. See "Installing a Toner Cartridge" on page 190.
093-971	
093-972	
093-973	
093-974	
116-399	Turn off the printer, and then on again. If this does not solve the problem, contact Dell. See "Contacting Dell" on page 230.
124-333	
191-310	
193-700	This message indicates the printer is in the non-Dell toner mode.



## Specifications

 **NOTE:** The images used in this manual are those of the Dell™ C1760nw Color Printer unless otherwise mentioned.

### Operating System Compatibility

Your Dell C1760nw/C1660w Color Printer is compatible with Microsoft® Windows® XP, Windows XP 64-bit Edition, Windows Vista®, Windows Vista 64-bit Edition, Windows 7, Windows 7 64-bit Edition, Windows 8, Windows 8 64-bit Edition, Windows Server® 2003, Windows Server 2003 x64 Edition, Windows Server 2008, Windows Server 2008 64-bit Edition, Windows Server 2008 R2, Windows Server 2012, Mac OS X Version 10.4.11, 10.5, 10.6, and 10.7.

### Power Supply

<b>Rated Voltage</b>	220-240 VAC	110-127 VAC
<b>Frequency</b>	50/60 Hz	50/60 Hz
<b>Current</b>	5.0 A	11.0 A

### Dimensions

Height: 225 mm (8.9 inches) Width: 394 mm (15.5 inches) Depth: 300 mm (11.8 inches)

Weight (including toner cartridges):

- Dell C1760nw Color Printer: 10.6 kg (23.4 lb)
- Dell C1660w Color Printer: 10.5 kg (23.2 lb)

### Memory

Base memory	128 MB
-------------	--------

# Page Description Language (PDL)/Emulation, Operating System, and Interface

PDL/Emulations	Host-based printing system	
OSes	Windows XP, Windows XP 64-bit Edition, Windows Vista, Windows Vista 64-bit Edition, Windows 7, Windows 7 64-bit Edition, Windows 8, Windows 8 64-bit Edition, Windows Server 2003, Windows Server 2003 x64 Edition, Windows Server 2008, Windows Server 2008 64-bit Edition, Windows Server 2008 R2, Windows Server 2012, Mac OS X Version 10.4.11, 10.5, 10.6, and 10.7.	
Interfaces	Standard local:	USB 2.0
	Standard network:	10Base-T/100Base-TX Ethernet (Dell C1760nw Color Printer only) IEEE 802.11b/802.11g/ 802.11n(Wireless)

## MIB Compatibility

A Management Information Base (MIB) is a database containing information about network devices (such as adapters, bridges, routers, or computers). This information helps network administrators manage the network (analyze performance, traffic, errors, and so on). Dell C1760nw/C1660w Color Printer complies with standard industry MIB specifications, allowing the printer to be recognized and managed by various printer and network management software systems.

## Environment

### Operation

Temperature	10-32°C
Relative humidity	10-85% RH (no condensation)

### Print Quality Guarantee

Temperature	15-28°C
Relative humidity	20-70% RH (no condensation)

### Storage

Temperature range	-20-40°C
Storage humidity range	5-85% RH (no condensation)



### Altitude

Operating	Up to 3,100 m (10,000 feet)
Storage	70.9275 Kpa



# Cables

Your interconnection cable must meet the following requirements:

Connection type	Connection specifications and symbols
1 USB	USB 2.0 
2 Ethernet (Dell C1760nw Color Printer only)	10 Base-T/100 Base-TX 

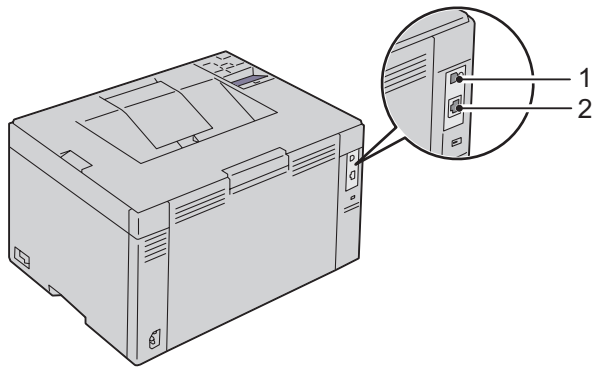



# Maintaining Your Printer

21 Maintaining Your Printer ..... 187

22 Clearing Jams ..... 201



## Maintaining Your Printer

Periodically, your printer requires you to complete certain tasks to maintain optimum print quality. If several people are using the printer, you may want to designate a key operator to maintain your printer. Refer printing problems and maintenance tasks to this key operator.

 **NOTE:** The images used in this manual are those of the Dell™ C1760nw Color Printer unless otherwise mentioned.

### Determining the Status of Supplies

If your printer is connected to the network, the **Dell Printer Configuration Web Tool** can provide instant feedback on remaining toner levels. Type the IP address of your printer in your web browser to view this information. To use the **E-Mail Alert** feature that notifies you when the printer requires new supplies, type your name or the name of the key operator in the e-mail list box.

On the operator panel, you can also confirm the following:

- Any supply or maintenance items that require attention replacing (However, the printer can only display information about one item at a time).
- Amount of toner remaining in each toner cartridge.

### Conserving Supplies

You can change several settings in your printer driver to conserve toner cartridge and paper.

Supply	Setting	Function
Toner cartridge	<b>Toner Saver</b> in the <b>Others</b> tab of the printer driver	This drop-down menu allows the users to select a print mode that uses less toner. When this feature is used, the image quality will be lower than when it is not used.
Print media	<b>Multiple Up</b> in the <b>Layout</b> tab of the printer driver	The printer prints two or more pages on one side of a sheet. The available numbers that each printer driver can print one sheet of paper are as follows: <ul style="list-style-type: none"> <li>• Printer driver for Microsoft® Windows®: 2, 4, 8, 16, or 32 pages</li> <li>• Printer driver for Macintosh: 2, 4, 6, 9, or 16 pages</li> </ul> Combined with the duplex setting, <b>Multiple Up</b> allows you to print up to 64 pages on one sheet of paper. (32 images on the front and 32 on the back)

### Storing Print Media

To avoid potential paper feeding problems and uneven print quality, you need to consider the following points:

- To achieve the best possible print quality, store print media in an environment where the temperature is approximately 21°C (70°F) and the relative humidity is 40%.
- Store cartons of print media on a pallet or shelf, rather than directly on the floor.
- If you store individual packages of print media out of the original carton, ensure that they rest on a flat surface so the edges do not buckle or curl.
- Do not place anything on top of the print media packages.

## Storing Consumables

Store consumables in their original packaging until you need to use them. Do not store consumables in:

- Temperatures greater than 40°C (104°F).
- An environment with extreme changes in humidity or temperature.
- Direct sunlight.
- Dusty places.
- A car for a long period of time.
- An environment where corrosive gases are present.
- An environment with salty air.

## Replacing Toner Cartridges

**⚠ WARNING:** Before replacing toner cartridges, read and follow the safety instructions in the *Important Information*.

Dell toner cartridges are available only through Dell. You can order more cartridges online at <http://www.dell.com/supplies> or by phone. To order by phone, see "Contacting Dell" on page 230.

It is recommended that you use Dell toner cartridges for your printer. Dell does not provide warranty coverage for problems caused by using accessories, parts, or components not supplied by Dell.

**⚠ WARNING:** Never throw used toner cartridges into fire. The residual toner could explode resulting in burns and injuries.

**⚠ WARNING:** Do not shake the used toner cartridge to avoid spilling of toner.

### Removing the Toner Cartridges

- 1 Open the toner access cover.

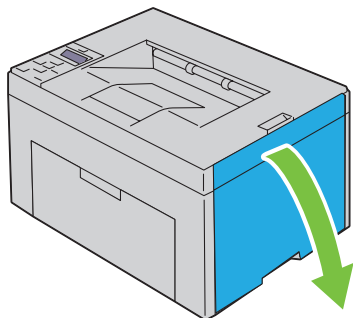

2 Pinch the cartridge firmly as shown in the illustration.

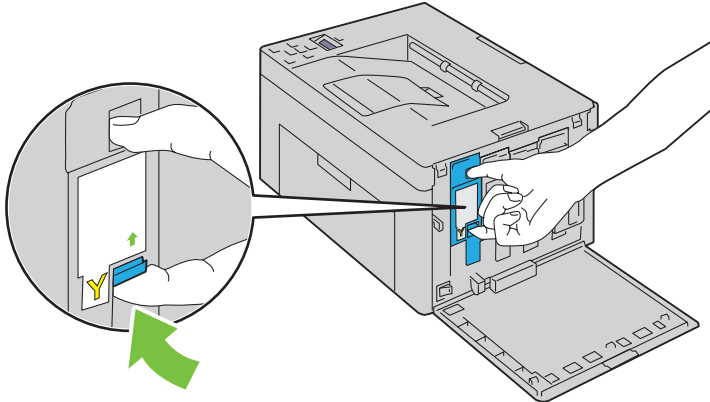

**⚠ WARNING:** Always pull the cartridge out slowly so that you do not spill any toner.

3 Pull the toner cartridge out.

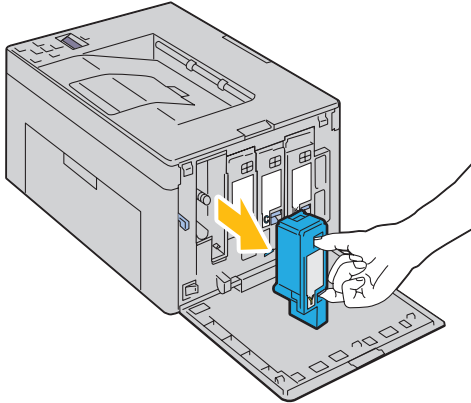

## Installing a Toner Cartridge

- 1 Unpack a new toner cartridge of the desired color and shake it five to six times to distribute the toner evenly.

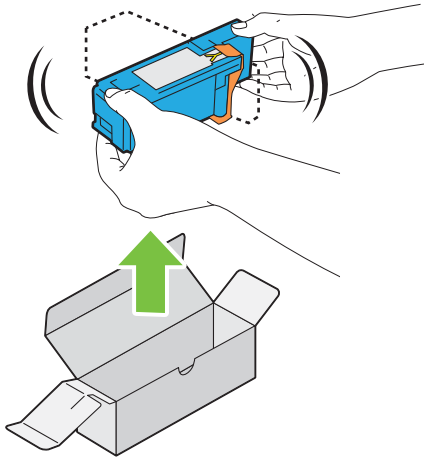

 **NOTE:** Ensure that the color of the new toner cartridge matches that on the handle before replacing it.

 **NOTE:** Handle the toner cartridge carefully to avoid spillage of the toner.

- 2 Remove the tape from the toner cartridge.

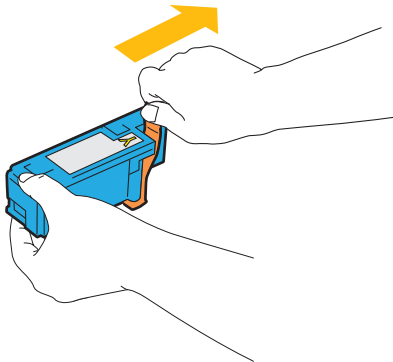



- 3** Adjust the toner cartridge to the associated cartridge holder, and then insert it firmly by pressing near the center of the label until the cartridge clicks.

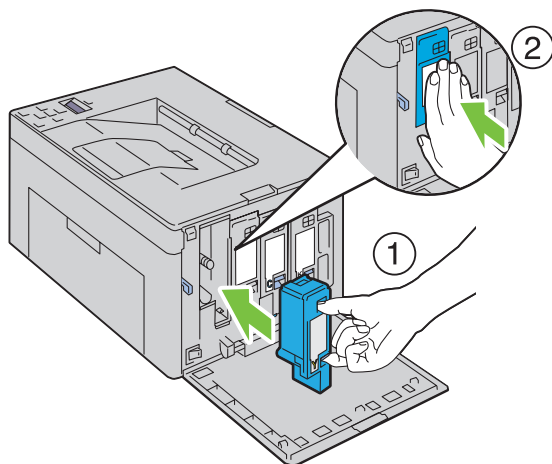

- 4** Close the toner access cover.

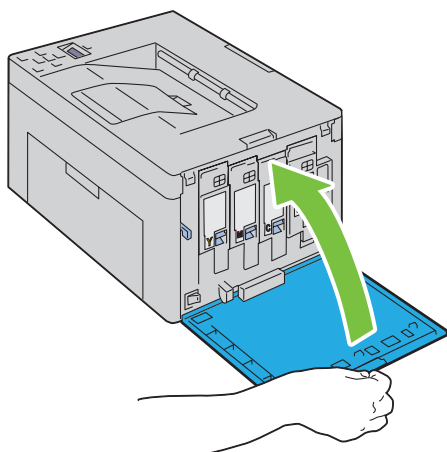

## Cleaning Inside the Printer

**⚠ WARNING:** To prevent electric shock, always turn off the printer and disconnect the power cable from the grounded outlet before performing maintenance.

- 1 Confirm that the printer is not in operation, and open the toner access cover.

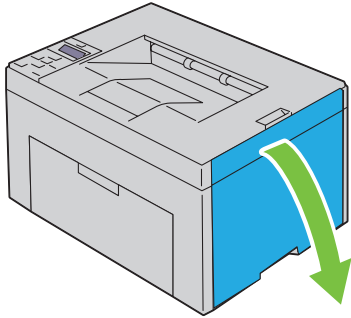

- 2 Pinch the cartridge firmly as shown in the illustration.

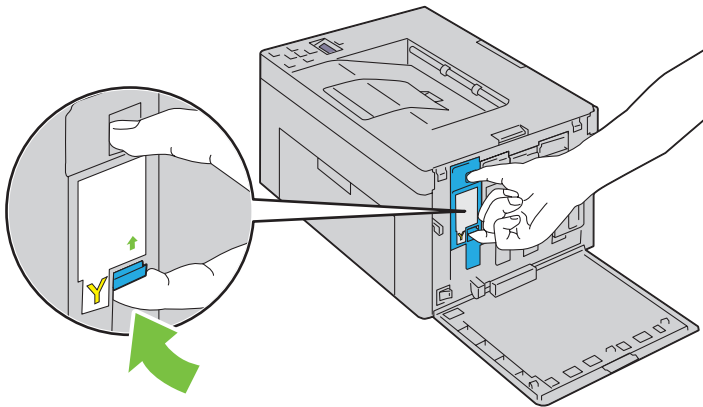

- 3 Pull the toner cartridge out.

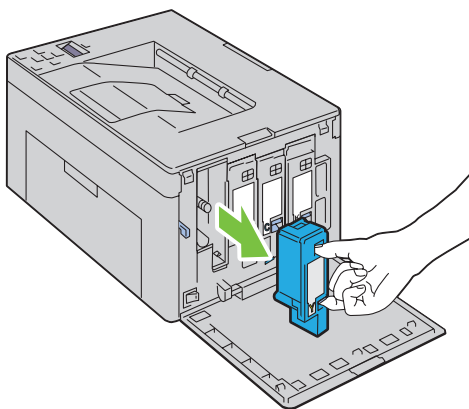

- 4 Pull the other three cartridges out as well.

- 5 Pull the cleaning rod out.

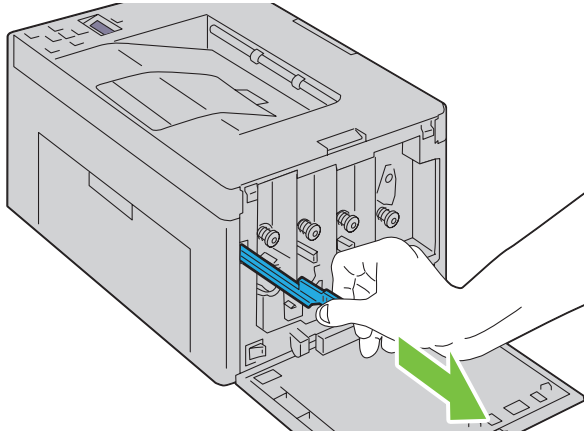

- 6 Insert the cleaning rod fully into the hole beside the arrow on the printer until its tip reaches the interior of the printer as illustrated below, and then pull it out.

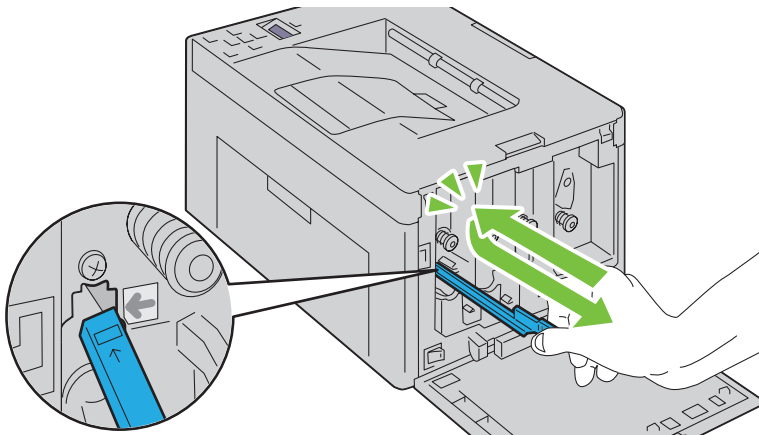

- 7 Repeat the same procedure for the other three holes.
- 8 Insert the cleaning rod back to its original location.

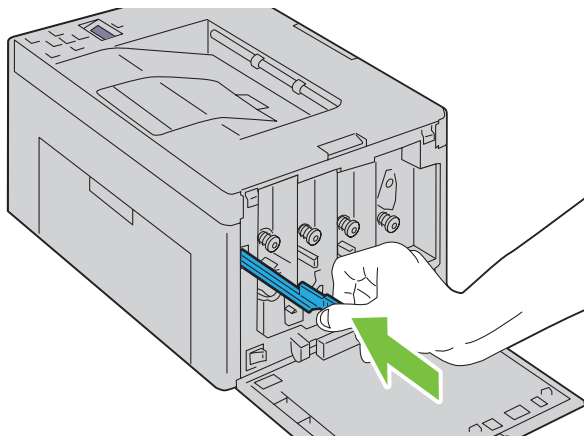

- 9** Replace the black cartridge by adjusting it to the associated cartridge holder, and then insert it firmly by pressing near the center of the label until the cartridge clicks.

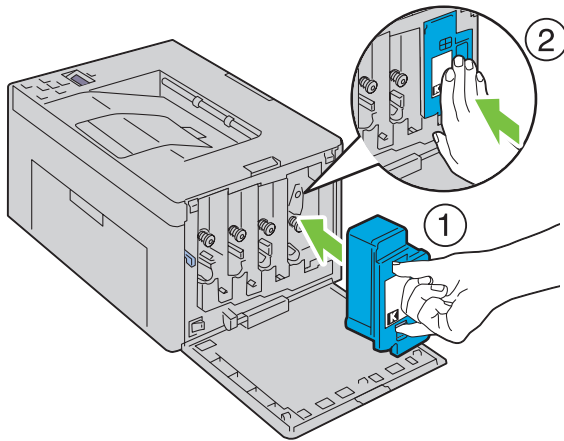

- 10** Replace the other three cartridges as well.  
**11** Close the toner access cover.

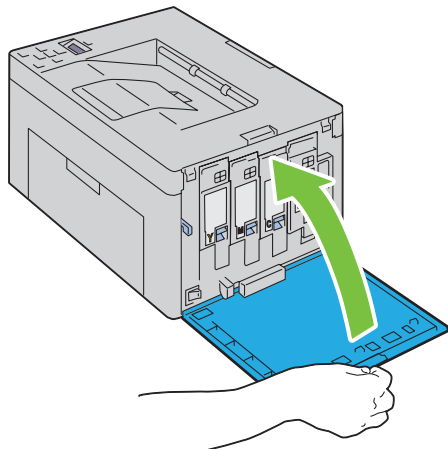

## Cleaning the Color Toner Density (CTD) Sensor

Clean the CTD sensor only when an alert for the CTD sensor is shown on the Status Monitor or operator panel.

- 1 Ensure that the printer is turned off.
- 2 Push the rear cover release handle and open the rear cover.

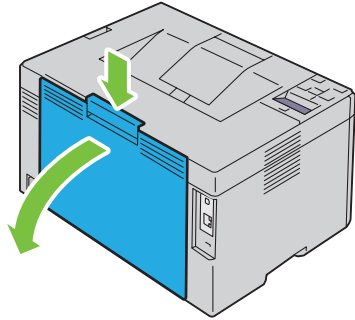

- 3 Clean the CTD sensor inside the printer with a clean dry cotton swab.

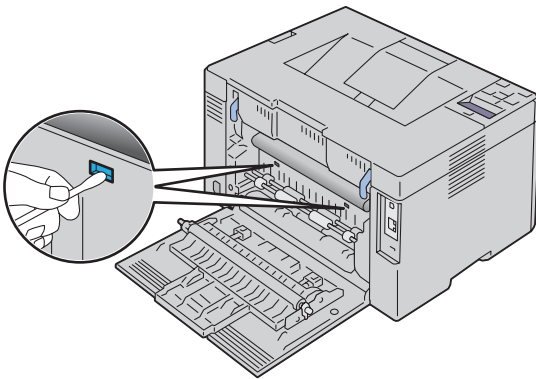

- 4 Close the rear cover.

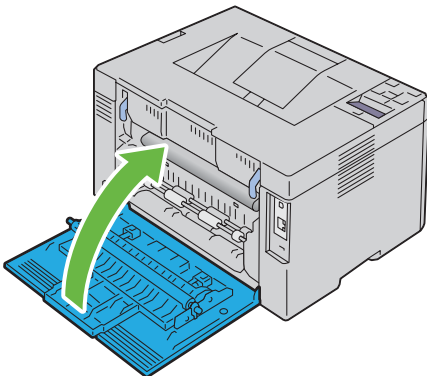

- 5 Turn on the printer.

## Adjusting Color Registration





This section describes how to adjust the color registration when you first install the printer or after moving it to a new location.

 **NOTE:** A Password is required to enter the Admin Menu menu when Panel Lock Set is set to Enable. In this case, enter the password you specified, and press the ✓ (Set) button.

### Performing Auto Correct

Auto Correct allows you to correct the color registration automatically.

#### The Operator Panel

- 1 Press the  (Menu) button.
- 2 Press the  button until Admin Menu appears, and then press the ✓ (Set) button.
- 3 Press the  button until Maintenance appears, and then press the ✓ (Set) button.
- 4 Press the  button until Color Reg Adj appears, and then press the ✓ (Set) button.
- 5 Ensure that Auto Correct appears, and then press the ✓ (Set) button.
- 6 Ensure that Are you sure? appears, and then press the ✓ (Set) button.

Auto correct is performed.

#### The Tool Box

- 1 Click Start → All Programs → Dell Printers → Dell C1760nw Color Printer or Dell C1660w Color Printer → Tool Box.

 **NOTE:** The Select Printer window appears in this step, when multiple printer drivers are installed on your computer. In this case, click **Dell C1760nw Color Printer** or **Dell C1660w Color Printer** listed in **Printer Name**, and then click **OK**.

The Tool Box opens.

- 2 Click the Printer Maintenance tab.
- 3 Select **Color Registration Adjustment** from the list at the left side of the page.





The Color Registration Adjustment page is displayed.

- 4 Clear the On check box for **Auto Registration Adjustment**.
- 5 Click Start next to **Auto Correct**.

The color registration is corrected automatically.

### Printing the Color Registration Chart

#### The Operator Panel

- 1 Load paper. For details about loading paper, see "Loading Print Media" on page 151.
- 2 Press the  (Menu) button.
- 3 Press the  button until Admin Menu appears, and then press the ✓ (Set) button.
- 4 Press the  button until Maintenance appears, and then press the ✓ (Set) button.
- 5 Press the  button until Color Reg Adj appears, and then press the ✓ (Set) button.
- 6 Press the  button until Color Regi Chart appears, and then press the ✓ (Set) button.

The color registration chart is printed.

## The Tool Box

- 1 Click Start → All Programs → Dell Printers → Dell C1760nw Color Printer or Dell C1660w Color Printer → Tool Box.

 **NOTE:** The **Select Printer** window appears in this step, when multiple printer drivers are installed on your computer. In this case, click **Dell C1760nw Color Printer** or **Dell C1660w Color Printer** listed in **Printer Name**, and then click **OK**.

The **Tool Box** opens.

- 2 Click the **Printer Maintenance** tab.
- 3 Select **Color Registration Adjustment** from the list at the left side of the page.

The **Color Registration Adjustment** page is displayed.

- 4 Clear the **On** check box for **Auto Registration Adjustment**.
- 5 Click **Start** next to **Print Color Regi Chart**.

The color registration chart is printed.

## Determining Values

On the color registration chart printed, find the straightest lines where the two black lines and the colored line are most closely aligned for each color (Y, M, and C).

If you find the straightest line, make a note of the value (-5–+5) indicated by the straightest line for each color.

When the value is 0 for each color, you do not need to adjust the color registration.



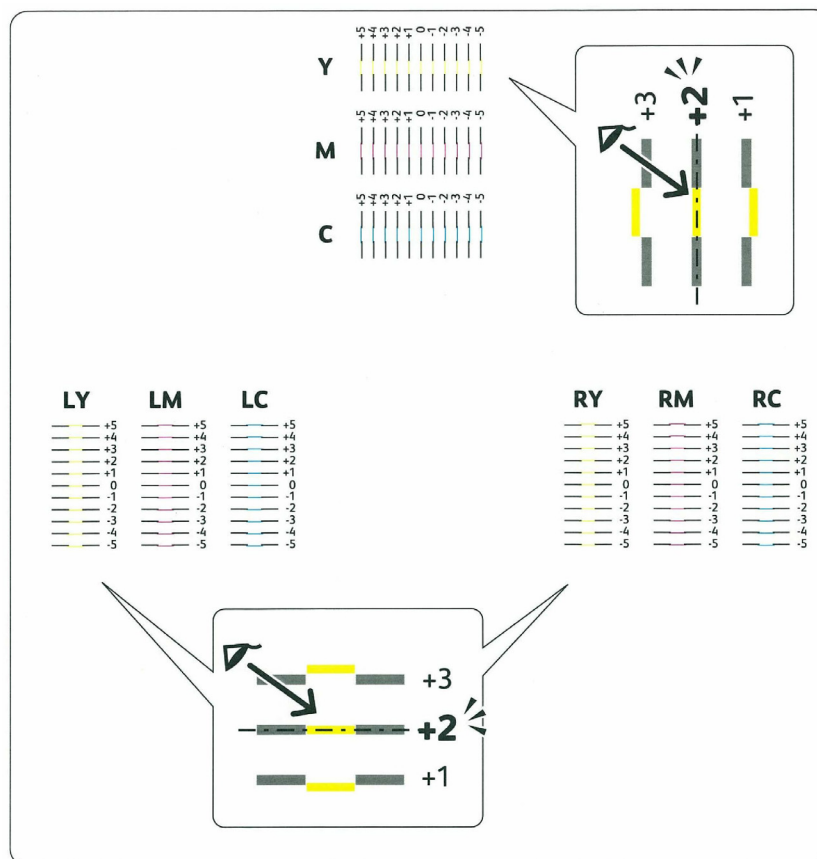



























When the value is not 0, enter the value according to the procedure in "Entering Values" on page 198.



## Entering Values

### The Operator Panel

Using the operator panel, enter the values that you found in the color registration chart to make adjustments.

- 1 Load paper. For details about loading paper, see "Loading Print Media" on page 151.
- 2 Press the  (Menu) button.
- 3 Press the  button until Admin Menu appears, and then press the  (Set) button.
- 4 Press the  button until Maintenance appears, and then press the  (Set) button.
- 5 Press the  button until Color Reg Adj appears, and then press the  (Set) button.
- 6 Press the  button until Enter Number appears, and then press the  (Set) button.
- 7 Ensure that Enter (Y, M, C) appears, and then press the  or  button until you reach the value (for example, +3) displayed on the chart.
- 8 Press the  button once and move the cursor to the next value.
- 9 Repeat steps 7 and 8 to enter all of the digits, and then press the  (Set) button.
- 10 Ensure that Enter (LY, LM, LC) appears.
- 11 Press the  or  button until you reach the value (for example, +3) displayed on the chart.
- 12 Press the  button once and move the cursor to the next value.
- 13 Repeat steps 11 and 12 to enter all of the digits, and then press the  (Set) button.
- 14 Ensure that Enter (RY, RM, RC) appears.
- 15 Press the  or  button until you reach the value (for example, +3) displayed on the chart.
- 16 Press the  button once and move the cursor to the next value.
- 17 Repeat steps 15 and 16 to enter all of the digits, and then press the  (Set) button.
- 18 Press the  (Menu) button.
- 19 Press the  button until Admin Menu appears, and then press the  (Set) button.
- 20 Press the  button until Maintenance appears, and then press the  (Set) button.
- 21 Press the  button until Color Reg Adj appears, and then press the  (Set) button.
- 22 Press the  button until Color Regi Chart appears, and then press the  (Set) button.  
The color registration chart is printed with the new values.
- 23 Adjust the values for every color until the lines at 0 are the straightest. If a line is not the straightest at 0, determine the value and adjust the printer again.

### The Tool Box

Using the Tool Box, enter the values that you found in the color registration chart to make adjustments.

- 1 Click Start → All Programs → Dell Printers → Dell C1760nw Color Printer or Dell C1660w Color Printer → Tool Box.  
 **NOTE:** The **Select Printer** window appears in this step, when multiple printer drivers are installed on your computer. In this case, click **Dell C1760nw Color Printer** or **Dell C1660w Color Printer** listed in **Printer Name**, and then click **OK**.  
The Tool Box opens.
- 2 Click the Printer Maintenance tab.
- 3 Select **Color Registration Adjustment** from the list at the left side of the page.  
The **Color Registration Adjustment** page is displayed.



- 4 Clear the **On** check box for **Auto Registration Adjustment**.
- 5 Select the value with the straight line, and then click **Apply New Settings**.
- 6 Click **Start** next to **Print Color Regi Chart**.

The color registration chart is printed with the new values.

- 7 Adjust the values for every color until the lines at 0 are the straightest. If a line is not the straightest at 0, determine the value and adjust the printer again.





**CAUTION: After printing the color registration chart, do not turn off the printer until the printer motor has stopped running.**



## Clearing Jams

Careful selection of appropriate print media and proper loading allow you to avoid paper jams. See "Print Media Guidelines" on page 143 for more information.

 **NOTE:** The images used in this manual are those of the Dell™ C1760nw Color Printer unless otherwise mentioned.

 **NOTE:** Priority Sheet Inserter (PSI) is available only for Dell C1760nw Color Printer.

 **NOTE:** Before buying large quantities of any print media, it is recommended that you try a sample first.

## Avoiding Jams

- Use only recommended print media. See "Print Media Guidelines" on page 143 for more information.
- See "Loading Print Media in the Multipurpose Feeder (MPF)" on page 151 and "Loading Print Media in the Priority Sheet Inserter (PSI) (Dell C1760nw Color Printer only)" on page 159 to load print media properly.
- Do not overload the print media sources. Ensure that the stack print media height does not exceed the maximum height indicated by the line with an arrow on each width guide.
- Do not load wrinkled, creased, damp, or curled print media.
- Flex, fan, and straighten print media before you load it. If a jam occurs with print media, try feeding one sheet at a time through the MPF or the PSI.
- Do not use print media that you have cut or trimmed yourself.
- Do not mix print media sizes, weights, or types in the same print media source.
- Ensure that the recommended print side is face up when you insert the print media.
- Keep print media stored in an acceptable environment. For more information, see "Storing Print Media" on page 147.
- Do not remove the PSI during a print job.
- Ensure that all cables that connect to the printer are correctly attached.
- Over tightening the guides may cause jams.

## Identifying the Location of Paper Jams

**⚠ WARNING:** Do not attempt to clear any jams using tools or instruments. This may permanently damage the printer.

The following illustration shows where paper jams may occur along the print media path.

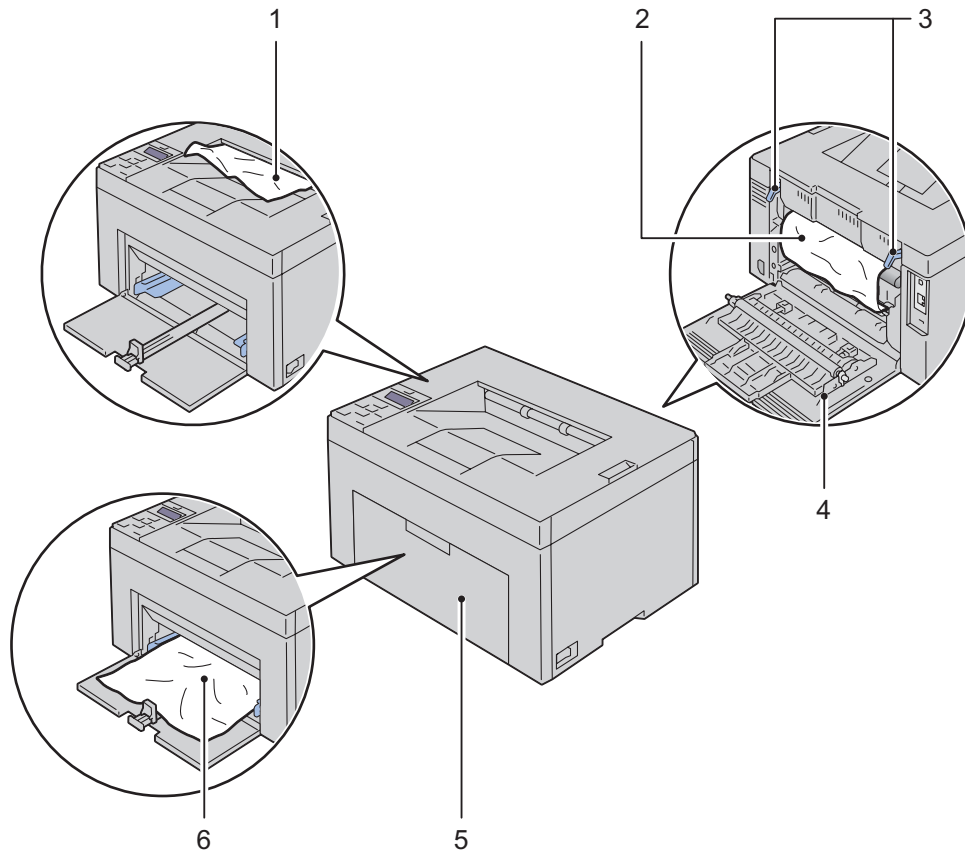

1	Output Tray
2	Fusing Unit
3	Lever
4	Rear Cover
5	Front Cover
6	Multipurpose Feeder (MPF)

## Clearing Paper Jams From the Front of the Printer

 **WARNING:** Before performing any of the following procedures, read and follow the safety instructions in the *Important Information*.

 **NOTE:** PSI is available only for Dell C1760nw Color Printer.

 **NOTE:** To resolve the error displayed on the operator panel, you must clear all print media from the print media path.

- 1 Pull the PSI out.

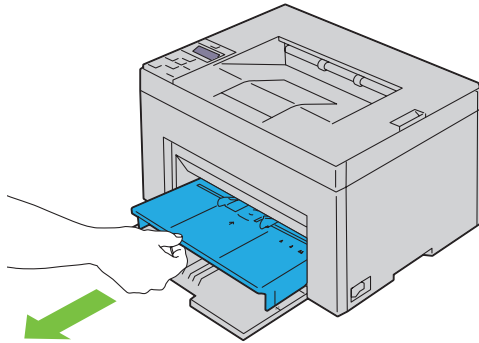

- 2 Remove any jammed paper from the front of the printer.

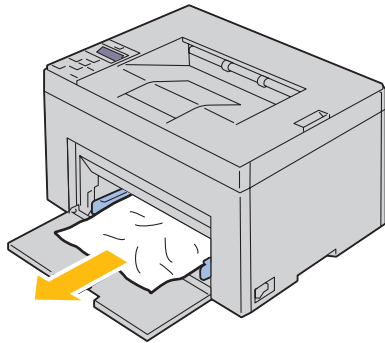

- 3 Replace the PSI in the printer.

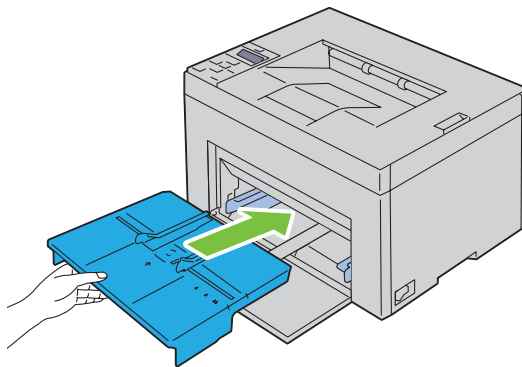

 **WARNING:** When putting the PSI back into the printer, do not use excessive force. Doing so could damage the PSI or the inside of the printer.

- 4 Press the ✓ (Set) button.

## Clearing Paper Jams From the Back of the Printer

- WARNING:** Before performing any of the following procedures, read and follow the safety instructions in the *Important Information*.
- WARNING:** To prevent electric shock, always turn off the printer and disconnect the power cable from the grounded outlet before performing maintenance.
- WARNING:** To avoid burns, do not clear paper jams immediately after printing. The fusing unit becomes extremely hot during use.
- NOTE:** To resolve the error displayed on the operator panel, you must clear all print media from the print media path.

- 1 Push the rear cover release handle and open the rear cover.

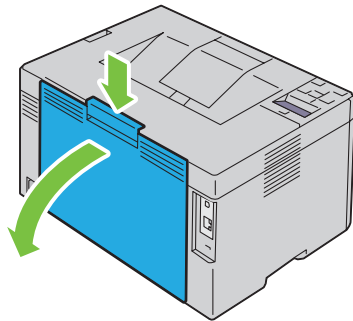

- 2 Lift up the levers.

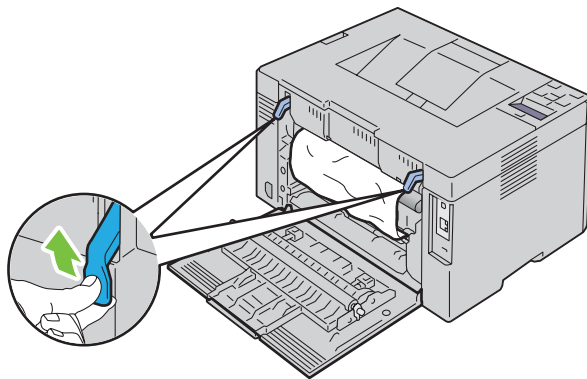

3 Remove any jammed paper from the back of the printer.

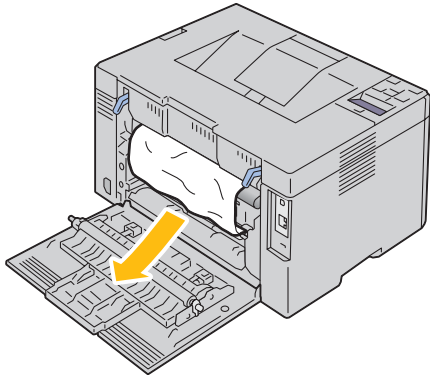

4 Lower the levers to their original position.

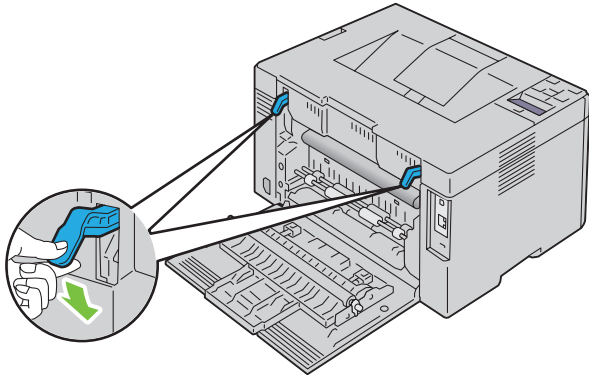

5 Close the rear cover.

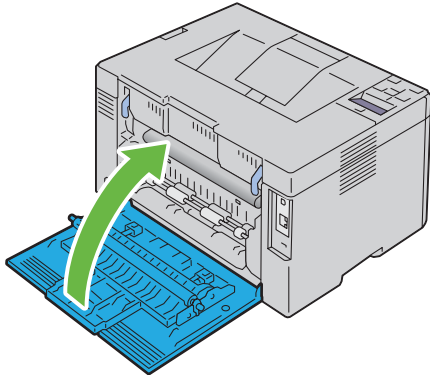

## Clearing Paper Jams From the Output Tray

 **WARNING:** Before performing any of the following procedures, read and follow the safety instructions in the *Important Information*.

 **WARNING:** To prevent electric shock, always turn off the printer and disconnect the power cable from the grounded outlet before performing maintenance.

 **WARNING:** To avoid burns, do not clear paper jams immediately after printing. The fusing unit becomes extremely hot during use.

 **NOTE:** To resolve the error displayed on the operator panel, you must clear all print media from the print media path.

- 1 Push the rear cover release handle and open the rear cover.

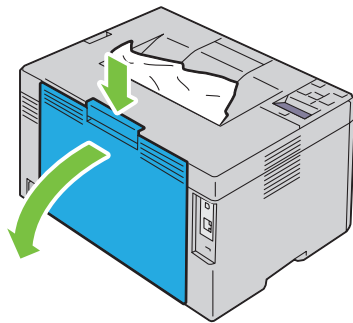

- 2 Lift up the levers.

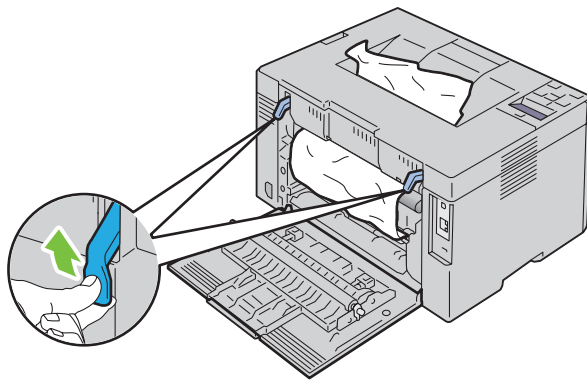



- 3 Remove any jammed paper from the back of the printer. If no paper is found in the paper path, then remove any jammed paper out of the output tray.

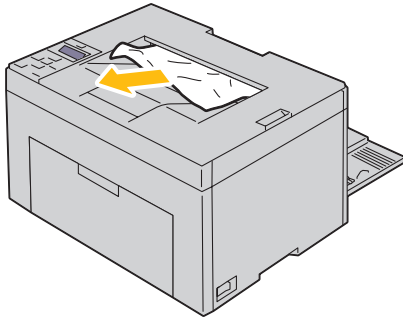

- 4 Lower the levers to their original position.

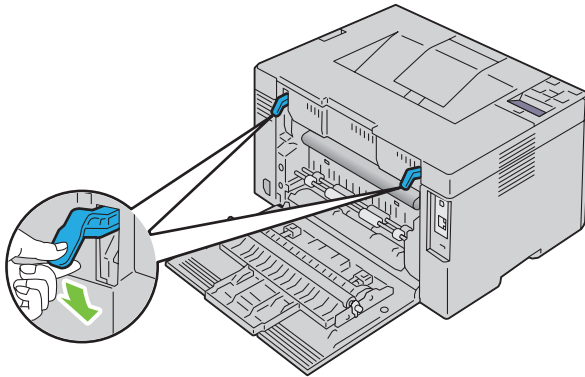

- 5 Close the rear cover.

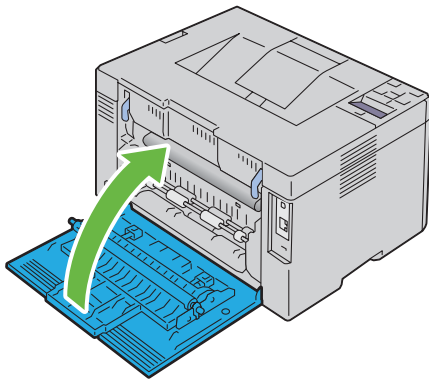

- 6 When you cannot remove the jammed paper even if performing the above steps, press and hold the **X** (Cancel) button for 2 seconds.

The message `Clearing jammed paper` is displayed and the jammed paper is ejected along with a paper fed from the MPF or PSI.

 **NOTE:** After using this feature, the print job in progress is canceled.

 **NOTE:** To use this feature, paper must be loaded in the MPF or PSI.



# Troubleshooting

23 Troubleshooting..... 211



## Troubleshooting

 **NOTE:** Priority Sheet Inserter (PSI) is available only for Dell™ C1760nw Color Printer.

### Basic Printer Problems

 **NOTE:** Ethernet connection is available only for Dell C1760nw Color Printer.

Some printer problems can be easy to resolve. If a problem occurs with your printer, check each of the following:

- The power cable is connected to the printer, and to a properly grounded electrical outlet.
- The printer is turned on.
- The electrical outlet is not turned off at any switch or breaker.
- Other electrical equipment plugged into the outlet is working.
- When your printer is connected to the network with the Ethernet cable, the USB cable is not connected between the printer and the computer.
- When your printer is connected to the computer with the USB cable, the Ethernet cable is not connected between the printer and the network.



If you have checked all of the above and still have a problem, turn off the printer, wait for 10 seconds, and then turn on the printer. This often fixes the problem.



 **NOTE:** If error messages are displayed on the operator panel or on your computer screen, follow the on-screen instructions to resolve the printer problems. For details about error messages and error codes, see "Understanding Printer Messages" on page 177.

### Display Problems

Problem	Action
Menu settings changed from the operator panel have no effect.	Settings in the software program, the printer driver, or the printer utilities have precedence over the settings made on the operator panel. Change the menu settings from the printer driver, the printer utilities, or the software program instead of the operator panel.

### Printing Problems

 **NOTE:** A Password is required to enter the Admin Menu menu when Panel Lock Set is set to Enable. In this case, enter the password you specified, and press the  (Set) button.

Problem	Action
Job did not print or incorrect characters printed.	Ensure that Ready to Print appears on the operator panel before you send a job to print. Press the  (Menu) button to return to Ready to Print. Ensure that print media is loaded in the printer. Press the  (Menu) button to return to Ready to Print. Verify that you are using the correct printer driver. Ensure that you are using the correct Ethernet cable (Dell C1760nw Color Printer only) or USB cable and that it is securely connected to the printer.

<b>Problem</b>	<b>Action</b>
	<p>Verify that the correct print media size is selected.</p> <p>If you are using a print spooler, verify that the spooler has not stalled.</p> <p>Check the interface of your printer from the Admin Menu.</p> <p>Determine the host interface you are using. Print a device settings report to verify that the current interface settings are correct. Refer to "Printing a Report/List Using the Operator Panel" on page 125 for details on how to print a device settings report.</p>
Print media misfeeds or multiple feeds occur.	<p>Ensure that the print media you are using meets the specifications for your printer. See "Supported Paper Sizes" on page 148 for more information.</p> <p>Fan the print media before loading it.</p> <p>Ensure that the print media is loaded correctly.</p> <p>Ensure that the width and length guides are adjusted correctly.</p> <p>Ensure that the PSI is securely inserted.</p> <p>Do not overfill the print media sources.</p> <p>Do not force print media into the PSI or the Multipurpose Feeder (MPF) when you load it. Otherwise, it may skew or buckle.</p> <p>Ensure that the print media is not curled.</p> <p>Load the recommended print side correctly for the type of print media you are using. See "Loading Print Media" on page 151 for more information.</p> <p>Turn the print media over or around and try printing again to see if feeding improves.</p> <p>Do not mix print media types.</p> <p>Do not mix reams of print media.</p> <p>Remove the top and bottom curled sheets of a ream before loading the print media.</p> <p>Load a print media source only when it is empty.</p>
The envelope is creased after printing.	<p>Ensure that the envelope is loaded as instructed in "Loading Envelopes in the Multipurpose Feeder (MPF)" on page 156 or "Loading an Envelope in the Priority Sheet Inserter (PSI)" on page 161.</p>
Page breaks in unexpected places.	<p>Increase the setting for <b>Time-Out</b> in the <b>Printer Settings</b> menu in the <b>Dell Printer Configuration Web Tool</b>.</p>
Print media does not stack neatly in the output tray.	<p>Turn the print media stack over in the PSI and MPF.</p>
Printer does not duplex pages.	<p>Select <b>Flip on Short Edge</b> or <b>Flip on Long Edge</b> from the <b>Duplex</b> menu on the <b>General</b> tab in the printer driver.</p>

## Print Quality Problems

 **NOTE:** In this section, some procedures that use the **Tool Box** can also be performed using the operator panel or **Dell Printer Configuration Web Tool**. For information on how to use the operator panel and **Dell Printer Configuration Web Tool**, see "Understanding the Printer Menus" on page 125 and "Dell™ Printer Configuration Web Tool" on page 81.

### The output is too light

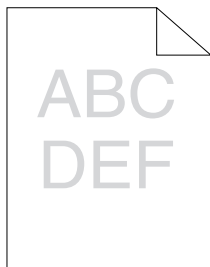

Action	Yes	No
<p>1 The toner cartridges may be low or need to be replaced. Confirm the amount of toner in each toner cartridge.</p> <ul style="list-style-type: none"> <li>a Check the toner level in the <b>Status</b> tab in the Status Monitor.</li> <li>b Replace the toner cartridges as necessary.</li> </ul> <p>Is the problem recovered?</p>	The task is complete.	Go to action 2.
<p>2 Verify that the print media is not damp and the correct print media is used. See "Supported Paper Types" on page 149. If not, use the print media recommended for the printer.</p> <p>Is the problem recovered?</p>	The task is complete.	Go to action 3.
<p>3 Verify that the <b>Paper Type</b> setting in the printer driver matches the print media you loaded.</p> <ul style="list-style-type: none"> <li>a On the <b>General</b> tab in <b>Printing Preferences</b> of the printer driver, check the <b>Paper Type</b> setting.</li> <li>b Load dry (not damp) and corrected print media, and then click <b>Print Test Page</b> in <b>Printer properties</b> of the printer driver.</li> </ul> <p>Is the problem recovered?</p>	The task is complete.	Go to action 4.
<p>4 Disable the <b>Toner Saver</b> in the printer driver.</p> <ul style="list-style-type: none"> <li>a On the <b>Others</b> tab in <b>Printing Preferences</b> of the printer driver, ensure that <b>Off</b> is selected in the <b>Toner Saver</b> drop-down menu.</li> </ul> <p>Is the problem recovered?</p>	The task is complete.	Contact Dell.

## Toner smears or print comes off/Stain on back side

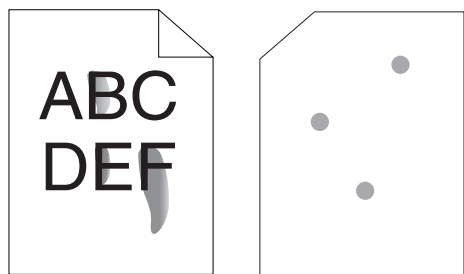

Action	Yes	No
<p>1 The print media surface may be uneven. Try changing the <b>Paper Type</b> setting in the printer driver. For example, change the plain paper to thick.</p> <p><b>a</b> On the <b>General</b> tab in <b>Printing Preferences</b> of the printer driver, change the <b>Paper Type</b> setting.</p> <p>Is the problem recovered?</p>	The task is complete.	Go to action 2.
<p>2 Verify that the correct print media is being used. See "Supported Paper Types" on page 149. If not, use the print media recommended for the printer.</p> <p>Is the problem recovered?</p>	The task is complete.	Go to action 3.
<p>3 Adjust the fusing unit temperature.</p> <p><b>a</b> Launch the <b>Tool Box</b>, click <b>Adjust Fusing Unit</b> on the <b>Printer Maintenance</b> tab.</p> <p><b>b</b> Adjust the fixing temperature by turning up the value for your printing media.</p> <p><b>c</b> Click <b>Apply New Settings</b>.</p> <p><b>d</b> Click close box to exit <b>Tool Box</b>.</p> <p>Is the problem recovered?</p>	The task is complete.	Contact Dell.



### Random spots/Blurred images

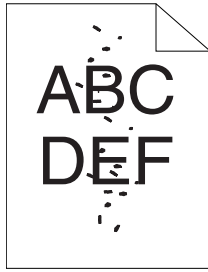

Action	Yes	No
1 Ensure that the toner cartridges are installed correctly. See "Installing a Toner Cartridge" on page 190. Is the problem recovered?	The task is complete.	Go to action 2.
2 If you use non-Dell brand toner cartridges, install Dell brand toner cartridges. Is the problem recovered?	The task is complete.	Go to action 3.
3 Clean up the fusing unit. <b>a</b> Load one sheet of paper on the MPF, and then print a solid image all over paper. <b>b</b> Load the printed sheet with the side to be printed on facing down, and then print a blank sheet of paper. Is the problem recovered?	The task is complete.	Contact Dell.

### The entire output is blank

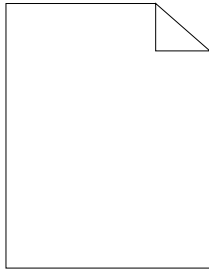

If this trouble comes out, contact Dell.

### Streaks appear on the output

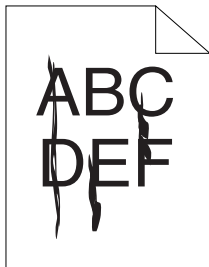

If this trouble comes out, contact Dell.

### Pitched color dots

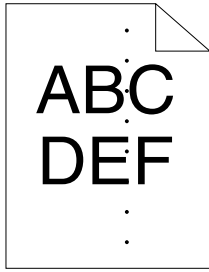

If this trouble comes out, contact Dell.

### Vertical blanks

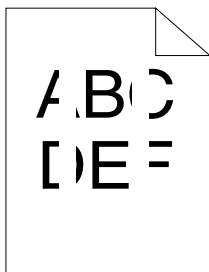

Action	Yes	No
1 Clean inside the printer and performing test print. <b>a</b> Clean inside the printer by using the cleaning rod. See "Cleaning Inside the Printer" on page 192. <b>b</b> Click <b>Print Test Page</b> in <b>Printer properties</b> of the printer driver. Is the problem recovered?	The task is complete.	Contact Dell.

### Mottle

Action	Yes	No
1 Adjust the transfer bias. <b>a</b> Launch the <b>Tool Box</b> , click <b>Adjust BTR</b> on the <b>Printer Maintenance</b> tab. <b>b</b> Adjust the setting for the type of print media being used. Is the problem recovered?	The task is complete.	Go to action 2.
2 If you use non-recommended print media, use the print media recommended for the printer. Is the problem recovered?	The task is complete.	Contact Dell.

## Ghosting

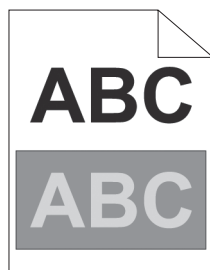

Action	Yes	No
<p>1 Adjust the transfer bias.</p> <ul style="list-style-type: none"> <li>a Launch the <b>Tool Box</b>, click <b>Chart Print</b> on the <b>Diagnosis</b> tab.</li> <li>b Click <b>Ghost Configuration Chart</b>.</li> </ul> <p>The Ghost Configuration Chart is printed.</p> <ul style="list-style-type: none"> <li>c Launch the <b>Tool Box</b>, click <b>BTR Refresh Mode</b> on the <b>Printer Maintenance</b> tab.</li> <li>d Check the check box next to <b>On</b>, and then click <b>Apply New Settings</b>.</li> <li>e Click <b>Chart Print</b> on the <b>Diagnosis</b> tab.</li> <li>f Click <b>Ghost Configuration Chart</b>.</li> </ul> <p>The Ghost Configuration Chart is printed.</p> <p>Is the problem recovered?</p>	The task is complete.	Go to action 2.
<p>2 The print media surface may be uneven. Try changing the <b>Paper Type</b> setting in the printer driver. For example, change the plain paper to thick.</p> <ul style="list-style-type: none"> <li>a On the <b>General</b> tab in <b>Printing Preferences</b> of the printer driver, change the <b>Paper Type</b> setting.</li> </ul> <p>Is the problem recovered?</p>	The task is complete.	Go to action 3.
<p>3 Adjust the fusing unit temperature.</p> <ul style="list-style-type: none"> <li>a Launch the <b>Tool Box</b>, and click <b>Adjust Fusing Unit</b> on the <b>Printer Maintenance</b> tab.</li> <li>b Adjust the fixing temperature by turning up the value for your printing media.</li> <li>c Click <b>Apply New Settings</b>.</li> <li>d Click close box to exit <b>Tool Box</b>.</li> </ul> <p>Is the problem recovered?</p>	The task is complete.	Go to action 4.
<p>4 If you use non-recommended print media, use the print media recommended for the printer.</p> <p>Is the problem recovered?</p>	The task is complete.	Contact Dell.

## Fog



Action	Yes	No
1 Is the whole page printed light?	Contact Dell.	Go to action 2.
2 Start <b>Developer Stir Mode</b> . <b>a</b> Launch the <b>Tool Box</b> , click <b>Developer Stir Mode</b> on the <b>Diagnosis</b> tab. <b>b</b> Click <b>Start</b> . Is the problem recovered?	The task is complete.	Contact Dell.

## Bead-Carry-Out (BCO)

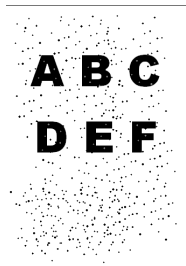

Action	Yes	No
1 If the printer is installed in a high altitude location, set the altitude of the location. <b>a</b> Launch the <b>Tool Box</b> , and click <b>Adjust Altitude</b> on the <b>Printer Maintenance</b> tab. <b>b</b> Select the value close to the altitude of the location where the printer is installed. Is them problem recovered?	The task is complete.	Contact Dell.

## Auger mark

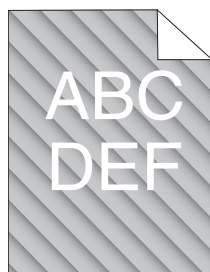

Action	Yes	No
1 The toner cartridges may be low or need to be replaced. Confirm the amount of toner in each toner cartridge. <ul style="list-style-type: none"> <li>a Check the toner level in the <b>Status</b> tab in the Status Monitor.</li> <li>b Replace the toner cartridges as necessary.</li> </ul> Is the problem recovered?	The task is complete.	Go to action 2.
2 Start <b>Developer Stir Mode</b> . <ul style="list-style-type: none"> <li>a Launch the <b>Tool Box</b>, click <b>Developer Stir Mode</b> on the <b>Diagnosis</b> tab.</li> <li>b Click <b>Start</b>.</li> </ul> Is the problem recovered?	The task is complete.	Contact Dell.

## Wrinkled/Stained paper

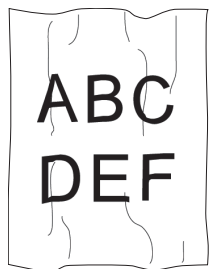

Action	Yes	No
1 Verify that the correct print media is being used. See "Supported Paper Sizes" on page 148 and "Print Media Guidelines" on page 143. If not, use the print media recommended for the printer. Is the problem recovered?	The task is complete.	If printing on an envelope, go to action 2. If printing on print media other than envelopes, contact Dell.
2 Check the crease. Is the crease within 30 mm of the four edges of the envelope?	This type of crease is considered normal. Your printer is not at fault.	If the envelope is 220 mm or longer (C5 or Envelope #10), go to action 3a. If the envelope is shorter than 220 mm (Monarch or DL), go to action 3b.

Action	Yes	No
3a Does the envelope have a flap on the long edge?	The envelope is Envelope #10. Go to action 4b.	The envelope is C5. Go to action 4a.
3b Load the envelope long edge feed in the MPF with the flap open and facing up. For details, see "When Loading Envelope #10, DL, or Monarch" on page 156. Is the problem recovered?	The task is complete.	Go to action 4b.
4a Load the envelope in the MPF with the flap open and facing up. For details, see "When Loading C5" on page 157. Is the problem recovered?	The task is complete.	Contact Dell.
4b Use a different size envelope. Is the problem recovered?	The task is complete.	Contact Dell.

### The top margins is incorrect

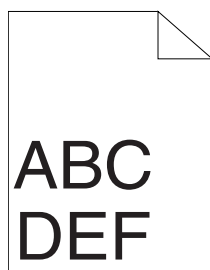

Action	Yes	No
1 Ensure that the margins are set correctly on the application being used. Is the problem recovered?	The task is complete.	Contact Dell.

### Color registration is out of alignment

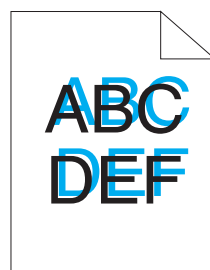

Action	Yes	No
1 Execute auto color registration adjustment. <ul style="list-style-type: none"> <li>a Launch the <b>Tool Box</b>, and click <b>Color Registration Adjustment</b> on the <b>Printer Maintenance</b> tab.</li> <li>b Clear the <b>On</b> check box for <b>Auto Registration Adjustment</b>.</li> <li>c Click <b>Start</b> next to <b>Auto Correct</b>.</li> </ul> Is the problem recovered?	The task is complete.	Go to action 2.

Action	Yes	No
<p>2 Clean the CTD sensor.</p> <ul style="list-style-type: none"> <li>a Clean the CTD sensor. See "Cleaning the Color Toner Density (CTD) Sensor" on page 195.</li> <li>b Launch the <b>Tool Box</b>, and click <b>Color Registration Adjustment</b> on the <b>Printer Maintenance</b> tab.</li> <li>c Clear the <b>On</b> check box for <b>Auto Registration Adjustment</b>.</li> <li>d Click <b>Start</b> next to <b>Auto Correct</b>.</li> </ul> <p>Is the problem recovered?</p>	The task is complete.	Go to action 3.
<p>3 Print the Color Registration Chart and manually correct the color registration.</p> <ul style="list-style-type: none"> <li>a Click <b>Color Registration Adjustment</b> on the <b>Printer Maintenance</b> tab.</li> <li>b Clear the <b>On</b> check box for <b>Auto Registration Adjustment</b>.</li> <li>c Click <b>Start</b> next to <b>Print Color Regi Chart</b>.</li> </ul> <p>The color registration chart is printed.</p> <ul style="list-style-type: none"> <li>d Select the value with the straight line. See "Adjusting Color Registration" on page 196 for details.</li> <li>e Click <b>Apply New Settings</b>.</li> <li>f Click <b>Start</b> next to <b>Print Color Regi Chart</b> to print the Color Registration Chart again.</li> <li>g Adjust the values for every color until the lines at 0 are the straightest.</li> </ul> <p>Is the problem recovered?</p>	The task is complete.	Contact Dell.

### Protrudent / Bumpy paper

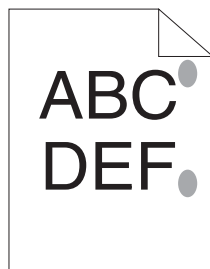

Action	Yes	No
<p>1 Clean up the fusing unit.</p> <ul style="list-style-type: none"> <li>a Load one sheet of paper on the MPF, and then print a solid image all over paper.</li> <li>b Load the printed sheet with the side to be printed on facing down, and then print a blank sheet of paper.</li> </ul> <p>Is the problem recovered?</p>	The task is complete.	Contact Dell.

## Noise



**NOTE:** In this section, some procedures that use the **Tool Box** can also be performed using the operator panel or **Dell Printer Configuration Web Tool**. For information on how to use the operator panel and **Dell Printer Configuration Web Tool**, see "Understanding the Printer Menus" on page 125 and "Dell™ Printer Configuration Web Tool" on page 81.

Action	Yes	No
<p>1 Locate the cause of the problem by removing the toner cartridges.</p> <ul style="list-style-type: none"> <li><b>a</b> Remove the toner cartridges. See "Replacing Toner Cartridges" on page 188.</li> <li><b>b</b> Launch the <b>Tool Box</b>, and click <b>Machine Check</b> on the <b>Diagnosis</b> tab.</li> <li><b>c</b> Select <b>Main Motor Operation Check</b> from the drop-down list box, and click <b>Start</b>.</li> <li><b>d</b> Click <b>Play of Sound</b> to check the motor sound.</li> </ul> <p>Does the sound generated from the printer match with the sound from the <b>Play of Sound</b> button?</p>	Go to action 2.	Contact Dell.
<p>2</p> <ul style="list-style-type: none"> <li><b>a</b> Click <b>Machine Check</b> on the <b>Diagnosis</b> tab.</li> <li><b>b</b> Select <b>Dispense Motor Check (Yellow)</b>, <b>Dispense Motor Check (Magenta)</b>, <b>Dispense Motor Check (Cyan)</b>, or <b>Dispense Motor Check (Black)</b> from the drop-down list box, and click <b>Start</b>.</li> <li><b>c</b> Click <b>Play of Sound</b> to check the motor sound.</li> <li><b>d</b> Repeat steps <b>a</b> and <b>b</b> to perform Dispense Motor Check for the rest of the toner cartridges.</li> </ul> <p><b>NOTE:</b> You can perform Dispense Motor Check for CMYK in any order you desire.</p> <p><b>NOTE:</b> Do not check the operation of the dispense motor repeatedly.</p> <p>Does the sound generated from the printer match with the sound from the <b>Play of Sound</b> button?</p>	Go to action 3.	Contact Dell.
<p>3</p> <ul style="list-style-type: none"> <li><b>a</b> Reinstall the toner cartridges.</li> <li><b>b</b> Perform action 2 again.</li> </ul> <p>Does the sound generated from the printer match with the sound from the <b>Play of Sound</b> button?</p>	The task is complete.	Contact Dell.



# Jam

 **NOTE:** In this section, some procedures that use the **Tool Box** can also be performed using the operator panel or **Dell Printer Configuration Web Tool**. For information on how to use the operator panel and **Dell Printer Configuration Web Tool**, see "Understanding the Printer Menus" on page 125 and "Dell™ Printer Configuration Web Tool" on page 81.

## Misfeed jam

Action	Yes	No
1 Remove the paper from the PSI, and then ensure that papers are properly inserted on the MPF. Is the problem recovered?	The task is complete.	Proceed to the action corresponding to the type of the print media being used: <ul style="list-style-type: none"><li>• Thick - 2a</li><li>• Thin - 2b</li><li>• Envelope - 2c</li></ul> If performing manual duplex printing, go to action 2d. If using paper other than the above or if not performing duplex printing, go to action 2e.
2a Use thick paper that is 216 gsm or less. Is the problem recovered?	The task is complete.	Go to action 3a.
2b Use thin paper that is 60 gsm or more. Is the problem recovered?	The task is complete.	Go to action 3a.
2c Ensure that the envelope is properly loaded in the MPF as instructed in "Loading Envelopes in the Multipurpose Feeder (MPF)" on page 156. Is the problem recovered?	The task is complete.	Go to action 3b.
2d Ensure that the print media is not curled. Is the problem recovered?	The task is complete.	Go to action 3a.
2e Is the print media damp?	Go to action 3c.	Go to action 3a.
3a Fan the print media. Is the problem recovered?	The task is complete.	Go to action 3c. If you are performing manual duplex printing or if using an envelope, contact Dell.
3b If the envelope is deformed, correct it or use another envelope. Is the problem recovered?	The task is complete.	Go to action 3a.
3c Turn over the print media. Is the problem recovered?	The task is complete.	Go to action 4.
4 Use print media that is not damp. Is the problem recovered?	The task is complete.	Contact Dell.

## Multi-feed jam

Action		Yes	No
1	Remove the paper from the PSI, and then ensure that papers are inserted properly in the MPF. Is the problem recovered?	The task is complete.	Go to action 2.
2	Is the print media damp?	Go to action 3a.	Go to action 3b.
3a	Use print media that is not damp. Is the problem recovered?	The task is complete.	Go to action 3b.
3b	Fan the print media. Is the problem recovered?	The task is complete.	Contact Dell.

## Wireless Problems

Problem	Action
Cannot setup wireless connection.	Ensure that the Ethernet cable (Dell C1760nw Color Printer only) and USB cable are disconnected from the printer. Ensure that <code>Wireless LAN</code> is set to <code>Enable</code> . See "Wireless LAN" on page 127. Try disabling the firewall on your computer. The firewall on your computer may be blocking communication with your printer.
Cannot setup wireless connection with WPS (Wi-Fi Protected Setup®).	Ensure that the security setting of the wireless LAN access point or router is WPA or WPA2. (WEP is not supported on WPS.) Turn off the printer, and then on again.
The message <code>Wireless Session Overlap Error</code> is displayed when setting up wireless connection.	Two or more wireless LAN access points or routers may be performing WPS setup at the same time. Wait for a while, and then try again.
Cannot setup wireless connection with WPS-PBC (Wi-Fi Protected Setup-Push Button Configuration).	Press the WPS button on the wireless LAN access point or router within 2 minutes after starting the WPS operation on the printer. For details about the wireless LAN access point or router, refer to the manual supplied with the wireless LAN access point or router.
Cannot setup wireless connection with WPS-PIN (Wi-Fi Protected Setup-Personal Identification Number).	Check if the PIN you have entered on the computer is correct.
Cannot connect to the wireless network after setting up wireless connection.	Check if the passphrase for WPA/WPA2 encryption or WEP key set on the wireless LAN access point or router has been changed. (Passphrase may be described as key on some access points or routers.) For details about the wireless LAN access point or router, refer to the manual supplied with the wireless LAN access point or router.

## Other Problems

<b>Problem</b>	<b>Action</b>
Condensation has occurred inside the printer.	This usually occurs within several hours after you heat the room in winter. This also occurs when the printer is operating in a location where relative humidity reaches 85% or more. Adjust the humidity or relocate the printer to an appropriate environment.

## Contacting Service

When you call for printer service, be prepared to describe the problem you are experiencing or the error message on the display.

You need to know the model of your printer type and serial number. See the label located inside the side door of your printer.



# Appendix

Appendix..... 229

Index..... 231



# Appendix

## Dell Technical Support Policy

Technician-assisted technical support requires the cooperation and participation of the customer in the troubleshooting process and provides for restoration of the operating system, software program and hardware drivers to the original default configuration as shipped from Dell, as well as the verification of appropriate functionality of the printer and all Dell-installed hardware. In addition to this technician assisted technical support, online technical support is available at Dell Support. Additional technical support options may be available for purchase.

Dell provides limited technical support for the printer and any Dell-installed software and peripherals. Support for third-party software and peripherals is provided by the original manufacturer, including those purchased and/or installed through Software & Peripherals (DellWare), ReadyWare, and Custom Factory Integration (CFI/DellPlus).

### Online Services

You can learn about Dell products and services on the following websites:

[www.dell.com](http://www.dell.com)

[www.dell.com/ap](http://www.dell.com/ap) (Asian/Pacific countries only)

[www.dell.com/jp](http://www.dell.com/jp) (Japan only)

[www.euro.dell.com](http://www.euro.dell.com) (Europe only)

[www.dell.com/la](http://www.dell.com/la) (Latin American and Caribbean countries)

[www.dell.ca](http://www.dell.ca) (Canada only)

You can access Dell Support through the following websites and e-mail addresses:

- Dell Support websites

[support.dell.com](http://support.dell.com)

[support.euro.dell.com](http://support.euro.dell.com) (Europe only)

- Dell Support e-mail addresses

[mobile\\_support@us.dell.com](mailto:mobile_support@us.dell.com)

[support@us.dell.com](mailto:support@us.dell.com)

[la-techsupport@dell.com](mailto:la-techsupport@dell.com) (Latin America and Caribbean countries only)

[apsupport@dell.com](mailto:apsupport@dell.com) (Asian/Pacific countries only)

- Dell Marketing and Sales e-mail addresses

[apmarketing@dell.com](mailto:apmarketing@dell.com) (Asian/Pacific countries only)

[sales\\_canada@dell.com](mailto:sales_canada@dell.com) (Canada only)

- Anonymous file transfer protocol (FTP)

[ftp.dell.com](http://ftp.dell.com)

Log in as user: `anonymous`, and use your e-mail address as your password.

## Warranty and Return Policy

Dell Computer Corporation ("Dell") manufactures its hardware products from parts and components that are new or equivalent to new in accordance with industry-standard practices. For information about the Dell warranty for your printer, see [support.dell.com](http://support.dell.com).

### Recycling Information

It is recommended that customers dispose of their used computer hardware, monitors, printers, and other peripherals in an environmentally sound manner. Potential methods include reuse of parts or whole products and recycling of products, components, and/or materials.

For specific information on Dell's worldwide recycling programs, see [www.dell.com/recyclingworldwide](http://www.dell.com/recyclingworldwide).

## Contacting Dell

You can access Dell Support at [support.dell.com](http://support.dell.com). Select your region on the WELCOME TO DELL SUPPORT page, and fill in the requested details to access help tools and information.

You can contact Dell electronically using the following addresses:

- World Wide Web

[www.dell.com](http://www.dell.com)

[www.dell.com/ap](http://www.dell.com/ap) (Asian/Pacific countries only)

[www.dell.com/jp](http://www.dell.com/jp) (Japan only)

[www.euro.dell.com](http://www.euro.dell.com) (Europe only)

[www.dell.com/la](http://www.dell.com/la) (Latin American and Caribbean countries)

[www.dell.ca](http://www.dell.ca) (Canada only)

- Anonymous file transfer protocol (FTP)

[ftp.dell.com](ftp://ftp.dell.com)

Log in as user: anonymous, and use your e-mail address as your password.

- Electronic Support Service

[mobile\\_support@us.dell.com](mailto:mobile_support@us.dell.com)

[support@us.dell.com](mailto:support@us.dell.com)

[la-techsupport@dell.com](mailto:la-techsupport@dell.com) (Latin America and Caribbean countries only)

[apsupport@dell.com](mailto:apsupport@dell.com) (Asian/Pacific countries only)

[support.jp.dell.com](mailto:support.jp.dell.com) (Japan only)

[support.euro.dell.com](mailto:support.euro.dell.com) (Europe only)

- Electronic Quote Service

[apmarketing@dell.com](mailto:apmarketing@dell.com) (Asian/Pacific countries only)

[sales\\_canada@dell.com](mailto:sales_canada@dell.com) (Canada only)



# Index

## Numerics

100Base-TX Full-Duplex, 102  
100Base-TX Half-Duplex, 102  
10Base-T Full-Duplex, 102  
10Base-T Half-Duplex, 102

## A

A4, 148  
A5, 148  
About printer, 21  
Ad-Hoc, 107  
Adjust Altitude, 92, 97, 118, 138  
Adjust BTR, 92, 95, 116, 134  
Adjust Fusing Unit, 92, 95, 117, 135  
Adjusting color registration, 196  
Admin Menu, 126  
Administrator Password, 109  
Altitude, 182  
Appendix, 229  
Apply New Settings Button, 87  
Asset Tag Number, 90  
Authenticate Error Trap, 106  
Auto Log Print, 92-93, 133  
Auto Reg Adj, 135  
Auto Registration Adjustment, 92, 95  
Auto SSID Setup, 32  
Avoiding jam, 169, 201

## B

B5, 148  
Base memory, 181  
Basic Information, 101  
Basic Printer Problems, 211

Bonjour (mDNS), 100, 102, 105, 130  
BTR Refresh, 92, 96, 137  
BTR Refresh Mode, 119

## C

C5, 148  
Cable, 183  
Cancel button, 77  
Canceling a print job, 170  
Carbonless copy paper, 144  
CCP, 144  
Change Password, 139  
Chart, 137  
Chart Print, 121  
Clean Developer, 96, 136  
Cleaning Inside the Printer, 192  
Cleaning the Color Toner Density (CTD) Sensor, 195  
Clearing jam, 201  
Clearing Paper Jams From the Back of the Printer, 204  
Clearing Paper Jams From the Front of the Printer, 203  
Clearing Paper Jams From the Output Tray, 206  
Coated, 92, 95, 116-117, 134-135  
Color Reg Adj, 136  
Color Regi Chart, 96  
Color Registration Adjustment, 117  
Color Registration Adjustments, 96  
Color registration chart, 196  
Color Test Page, 93, 125  
Community Name, 105  
Completed Jobs, 83, 91  
Connecting Printer to Computer or Network, 29

- Connecting your printer, 29
- Connection specification, 29, 183
- Connection type, 29, 183
- Conserving supplies, 187
- Contact Dell Support at, 84, 86
- Contact Person, 85
- Contacting Service, 225
- Copy Printer Settings, 84, 86, 110
- Copy Printer Settings Report, 110
- Cover, 89
- Covers, 92, 95, 116-117, 134-135
- Current, 181
- Current Ethernet Settings, 102

## D

- Def. Paper Size, 132
- Default Paper Size, 91, 93
- Dell Printer Configuration Web Tool, 81
- Dell Service Tag Number, 90
- Dell Supplies Management System, 173
- Dell technical support policy, 229
- Details, 90
- Determining Values, 197
- Developer Stir Mode, 122
- Device Settings, 93, 125
- Device Settings page, 79
- Dimensions, 181
- Direct Connection, 29
- Direct Connection Setup, 51
- Disable printing with larger paper size, 91, 93
- Disabling Panel Lock, 140
- Display Problems, 211
- DL, 148
- DL LEF, 148
- DNS, 99, 103
- Driver, 17

## E

- E-Mail Alert, 84, 86, 102, 104, 130
- E-Mail Alert Settings, 101, 105
- E-mail Alert Setup Page, 100
- E-Mail Server Settings, 100, 104
- Emulations, 182
- Encryption, 107-108
- Entering Values, 198
- Envelope, 92, 95, 116-117, 134-135, 146
- Envelope #10, 148
- Environment, 182
- Environment Sensor Info, 122
- Error History, 93, 125
- Ethernet, 98, 102, 183
- Ethernet Connection, 34
- Ethernet Port, 22, 29
- Ethernet Settings, 102
- Event Panel, 85
- EWS, 130
- EWS Settings, 101
- Executive, 148
- Express Code, 133
- Express Service Code, 90

## F

- F/W Version, 133
- Fault Time-Out, 91, 93, 132
- Finding Information, 17
- Firmware Version, 90
- Folio, 148
- Frequency, 181
- Front Cover, 21, 202
- Fusing Unit, 202

## H

- Host I/F, 90-91

Host Name, 90-91, 100  
host-based printer driver, 51, 54  
HTTP, 99, 104

## **I**

ID, 90-91  
Identifying Print Media and Specifications, 148  
Important Information, 17  
Impression Number, 91  
Infrastructure, 107  
Initial Settings, 37  
Initialize NIC NVRAM and restart printer, 108  
Installing a Toner Cartridge, 190  
Installing Printer Drivers, 51, 71  
Interfaces, 182  
IP Address, 39, 83, 85, 106  
IP Filter, 100, 130  
IP Filter (IPv4), 109  
IPv4, 99-100, 103, 106  
IPv6, 99, 103, 106

## **J**

Jam, 223  
Job History, 93, 125  
Job List, 83, 90  
Job Name, 90-91  
Job Status, 90  
Job Submitted Time, 90-91  
Job Time-Out, 91, 93, 132

## **K**

Kensington lock, 24

## **L**

Label, 92, 95, 116-117, 134-135, 147

LCD, 77  
LCD Panel, 77  
Left frame, 86  
Legal, 148  
Length Guide, 21  
Letter, 148  
Levers, 22, 202  
Link Channel, 107  
Link Quality, 107  
Liquid crystal display, 77  
Loading Envelopes, 156, 161  
Loading Letterhead, 145, 158, 163  
Loading paper, 43  
Loading Print Media, 151  
Loading Print Media in Multipurpose Feeder (MPF), 43, 151  
Loading Print Media in Priority Sheet Inserter (PSI), 48, 159  
Location, 85, 90  
Login Error, 94, 139  
Login Error - Attempts, 92  
Low Toner Alert Msg, 92-93  
Low Toner Msg, 133  
LPD, 99, 102-103, 130

## **M**

MAC Address, 102, 107  
Machine Check, 121  
Maintaining Your Printer, 187  
Maintenance, 133  
Maintenance Chart, 97  
Manual duplex printing, 164  
Manual SSID Setup, 33  
Memory, 181  
Memory Capacity, 90  
Menu button, 77  
Menu Items, 88

Menu Settings, 91, 112  
MIB compatibility, 182  
Mixed Mode PSK, 107  
mm/inch, 91, 93, 132  
Monarch, 148  
Monarch LEF, 148  
MPF Extension, 21  
Multiple Up, 187  
Multipurpose Feeder (MPF), 21, 202

## **N**

NCR, 144  
Network, 126  
    Ethernet, 126  
    Protocol, 130  
    Reset LAN, 130  
    Reset Wireless, 129  
    TCP/IP, 129  
Network Connection Setup, 54  
Network Firmware Version, 90  
Network Settings, 120  
Network Type, 107  
No carbon required, 144  
No. of Sheets, 91  
Non-Dell Toner, 92, 97, 119, 138

## **O**

OCR, 144  
Online Help, 84, 86  
Online Services, 229  
Operating System compatibility, 181  
Operation, 182  
Operator Panel, 21, 77  
    Button, 77  
Order Supplies at, 84, 86  
Ordering supplies, 25  
Output Result, 91

Output Tray, 21, 89, 202  
Output Tray Extension, 21, 166  
Owner, 90-91

## **P**

Panel Language, 80, 92-93, 140  
Panel Lock, 138  
Panel lock function, 140  
Panel Lock Set, 92, 138  
Paper, 143  
    Characteristics, 143  
    Curl, 143  
    Fiber content, 144  
    Grain direction, 143  
    Moisture content, 143  
    Smoothness, 143  
    Weight, 143  
Paper Chute, 22  
Paper Density, 92, 94, 116, 134  
Paper Feed Roller, 22  
Paper jam location, 202  
Paper Size, 148  
Paper Trays, 89  
Paper Type, 149  
Paper Used, 110  
Paper Width Guides, 21  
Parts name, 21  
PDL, 182  
Peer-to-Peer, 68  
Plain, 92, 95, 116-117, 134-135  
Plain Thick, 92, 95, 116-117, 134-135  
Point and Print, 66  
Port Settings, 102  
Port Status, 100, 102  
Port9100, 99, 102-103, 130  
Power Connector, 22  
Power On Wizard, 133  
Power Saver Time - Auto-Off Timer, 91, 93

Power Saver Time - Deep Sleep, 91, 93  
Power Saver Time - Sleep, 91, 93  
Power supply, 181  
Power Switch, 21  
PowerSaver Time, 80, 131  
Premier, 92  
Print Head Cleaning Rod, 21  
Print media, 187  
Print Media Dimensions, 151  
Print Media Guidelines, 143  
Print quality guarantee, 182  
Print Quality Problems, 213  
Print Server Reports, 98  
Print Server Settings, 84, 86, 98, 101  
Print Server Setup Page, 98  
Print Volume, 84, 86, 110  
Printer Bitmap, 85  
Printer Driver Pre-install Status, 51  
Printer Events, 90  
Printer Information, 84, 86, 90, 112  
Printer Jobs, 83, 86, 90  
Printer Maintenance, 94  
Printer message, 177  
Printer Name, 100  
Printer Page Count, 110  
Printer Revision Levels, 90  
Printer Serial Number, 90  
Printer Settings, 83, 86, 91, 93, 125  
Printer Settings Report, 91  
Printer software, 173  
Printer specification, 181  
Printer Status, 83, 86, 89  
Printer Type, 89  
Printing, 169  
Printing on letterhead, 145  
Printing Problems, 211  
Printing Speed, 89

Printing Status Window, 173  
Priority Sheet Inserter (PSI), 21  
Processor Speed, 90  
Product Features, 19

## **Q**

Quick Launch Utility, 174  
Quick Reference Guide, 17

## **R**

Rated Voltage, 181  
Ready/Error indicator, 77  
Rear Cover, 22, 202  
Rear Cover Release Handle, 22  
Recommended paper, 144  
Recycled, 92, 95, 116-117, 134-135  
Recycling Information, 230  
Refresh button, 87  
Refresh Mode, 122  
Regular, 92  
Relative humidity, 182  
Removing toner cartridge, 188  
Report Page, 170  
Reports, 93, 114  
Reset Defaults, 97, 119, 137  
Reset Print Server, 108  
Restart Printer, 108  
Restore Settings button, 87  
Return policy, 230  
Right frame, 87

## **S**

S/W Download, 139  
Safety information, 17  
Secure Settings, 92, 94, 138  
Security, 109

Security Settings, 107  
Security Slot, 22  
Select Reorder URL, 92  
Selecting paper, 144  
Selecting preprinted media and letterhead, 145  
Selecting pre-punched paper, 146  
Sending print job, 169  
Service code, 18  
Service Tag, 18, 133  
Set button, 77  
Set Password, 84, 86, 109  
Setting the IP Address, 39  
Setting Up Printer, 37  
Setup diagram, 18  
Shared Printing, 64  
SNMP, 100, 102, 105  
SNMP UDP, 130  
Software and Documentation Disc, 38  
Software and Documentation disc, 17  
Software Download, 92  
SSID, 107  
Status Monitor Console, 173  
Status Monitor Widget, 174  
Status of supplies, 187  
Storage, 182  
Storage humidity range, 182  
Storing consumables, 188  
Storing Print Media, 147, 169, 187  
Support  
    Contacting Dell, 230  
System Settings, 91, 93, 101, 114, 131

## **T**

TCP/IP, 103  
TCP/IP Settings, 99, 103, 114, 120  
Temperature, 182  
Toner Access Cover, 21

Toner Refresh, 137  
Tool Box, 111  
Top frame, 85  
Transfer Belt, 22  
Transfer Roller, 22  
Trap Notification 1-4, 106  
Troubleshooting, 211  
Turning On Printer, 36

## **U**

Unacceptable paper, 144  
UNITED STATES GOVERNMENT  
    RESTRICTED RIGHTS, 13  
USB, 183  
USB Port, 22, 29, 92, 94, 131  
USB Settings, 92, 94, 131

## **V**

Verifying IP settings, 41

## **W**

Warranty, 230  
Warranty information, 17  
Web Link Customization, 92, 98  
WEP, 107-108  
Wi-Fi | WPS button, 31, 77  
    Backlight, 78  
Wireless Connection, 30  
Wireless LAN, 107, 127  
Wireless Problems, 224  
Wireless Settings, 98, 107  
Wireless Setup, 127  
Wireless Status, 127  
WPA-PSK, 108  
WPA-PSK AES/WPA2-PSK AES, 107  
WPA-PSK TKIP, 107

WPS Setup, 129

WPS-PBC, 31

WPS-PIN, 32

WSD, 62, 99, 102, 104, 130

