

Dell™ Dimension™ 8400 Series

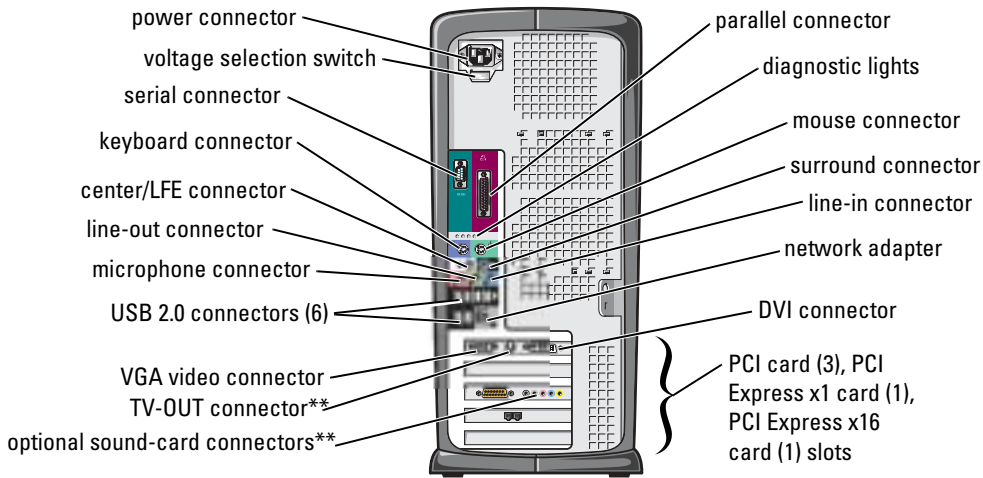

Notes, Notices, and Cautions

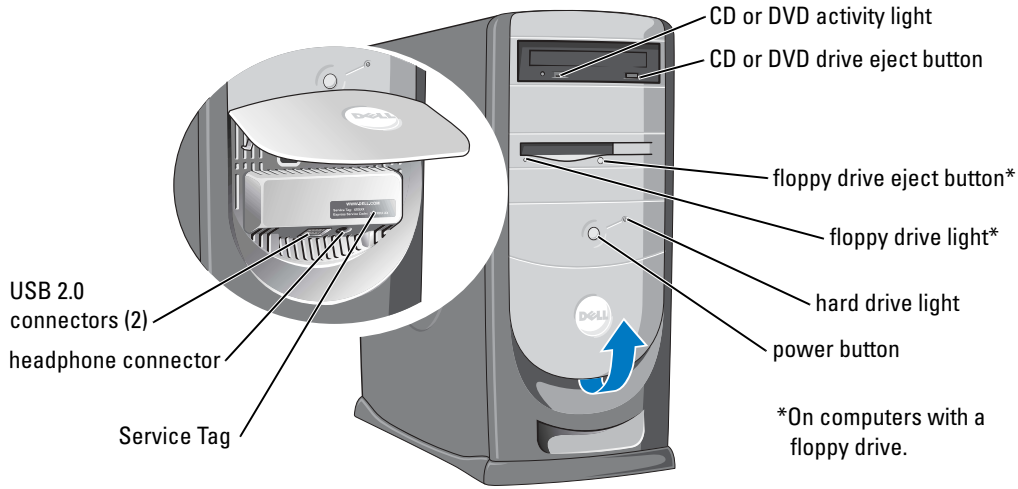

NOTE: A NOTE indicates important information that helps you make better use of your computer.



NOTICE: A NOTICE indicates either potential damage to hardware or loss of data and tells you how to avoid the problem.



CAUTION: A CAUTION indicates a potential for property damage, personal injury, or death.

If you purchased a Dell™ n Series computer, any references in this document to Microsoft® Windows® operating systems are not applicable.

Information in this document is subject to change without notice.

© 2004 Dell Inc. All rights reserved.

Reproduction in any manner whatsoever without the written permission of Dell Inc. is strictly forbidden.

Trademarks used in this text: *Dell*, the *DELL* logo, *Inspiron*, *Dell Precision*, *Dimension*, *OptiPlex*, *Latitude*, *PowerEdge*, *PowerVault*, *PowerApp*, *DellNet*, *PowerConnect*, and *Axim* are trademarks of Dell Inc.; *Intel* and *Pentium* are registered trademarks of Intel Corporation; *Microsoft*, *Windows*, and *Outlook* are registered trademarks of Microsoft Corporation.

Other trademarks and trade names may be used in this document to refer to either the entities claiming the marks and names or their products. Dell Inc. disclaims any proprietary interest in trademarks and trade names other than its own.

Model DHM

September 2004

P/N U7035

Rev. A00

Contents

Finding Information	9
1 Setting Up and Using Your Computer	
Setting Up a Printer	11
Printer Cable	11
Connecting a USB Printer	11
Connecting a Parallel Printer	12
Connecting to the Internet	13
Setting Up Your Internet Connection	14
Playing CDs or DVDs	15
Adjusting the Volume	16
Adjusting the Picture	17
Copying CDs and DVDs	17
How to Copy a CD or DVD	17
Using Blank CD-Rs and CD-RWs	18
Helpful Tips	18
Connecting Two Monitors	19
Connecting Two Monitors With VGA Connectors	19
Connecting One Monitor With a VGA connector and One Monitor With a DVI Connector	20
Connecting a TV	20
Changing the Display Settings	20
About Your RAID Configuration	20
RAID Level 0	21
RAID Level 1	21
Configuring Your Computer for RAID	22
Configuring for RAID Using the Intel(R) Option ROM Utility	23
Configuring for RAID Using the Intel(R) Application Accelerator	24
Setting Up a Home and Office Network	28
Connecting to a Network Adapter	28
Network Setup Wizard	29

Power Management	29
Overview	29
Standby Mode	29
Hibernate Mode.	30
Power Options Properties	30
Hyper-Threading	31

2 Solving Problems

Troubleshooting Tips	33
Battery Problems	33
Card Fan Problems	33
Drive Problems	34
CD and DVD drive problems	34
Hard drive problems.	35
E-Mail, Modem, and Internet Problems	35
Error Messages	36
IEEE 1394 Device Problems	37
Keyboard Problems	38
Lockups and Software Problems	38
The computer does not start up	38
The computer stops responding	39
A program stops responding.	39
A program crashes repeatedly.	39
A program is designed for an earlier Windows operating system.	39
A solid blue screen appears	39
Other software problems	40
Memory Problems	40
Mouse Problems	41
Network Problems	42
Power Problems	42
Printer Problems	43

Scanner Problems	44
Sound and Speaker Problems	45
No sound from speakers.	45
No sound from headphones	46
Video and Monitor Problems	46
If the screen is blank	46
If the screen is difficult to read.	47

3 Advanced Troubleshooting

Diagnostic Lights	49
Dell Diagnostics	52
Dell Diagnostics Main Menu.	53
Drivers	54
What Is a Driver?	54
Identifying Drivers.	54
Reinstalling Drivers	55
Restoring Your Operating System	56
Using Microsoft Windows XP System Restore	56
Using Dell PC Restore by Symantec	57
Resolving Software and Hardware Incompatibilities	58

4 Removing and Installing Parts

Before You Begin	59
Recommended Tools	59
Turning Off Your Computer	59
Before Working Inside Your Computer	60
Front View	61
Back View	63
Front-Panel Door and Hinge Arms	65
Reattaching the Hinge Arms	65
Reattaching the Front Door	68
Opening the Computer Cover	69

Inside Your Computer	70
System Board Components	71
Memory	72
DDR2 Memory Overview.	72
Addressing Memory With 4-GB Configurations	73
Installing Memory.	73
Removing Memory	75
Cards	75
PCI Cards.	76
PCI Express Cards.	81
Card Fan	86
Drives	89
General Installation Guidelines.	89
Connecting Drive Cables	89
Hard Drive	90
Removing a Hard Drive	91
Installing a Hard Drive.	92
Adding a Second Hard Drive.	93
Front-Panel Inserts	94
Floppy Drive	97
Removing a Floppy Drive	97
Installing a Floppy Drive	98
CD/DVD Drive	99
Removing a CD/DVD Drive	100
Installing a CD/DVD Drive	101
Battery	103
Replacing the Battery	103
Closing the Computer Cover	104

5 Appendix

Specifications	107
System Setup	111
Overview	111
Entering System Setup	112
System Setup Options	113
Boot Sequence	116
Clearing Forgotten Passwords	117
Clearing CMOS Settings	119
Cleaning Your Computer	119
Computer, Keyboard, and Monitor	119
Mouse	119
Floppy Drive	120
CDs and DVDs	120
Dell Technical Support Policy (U.S. Only)	120
Definition of "Dell-Installed" Software and Peripherals	121
Definition of "Third-Party" Software and Peripherals	121
FCC Notices (U.S. Only)	121
Class A	122
Class B	122
FCC Identification Information	122
Contacting Dell	123
Index	141

Finding Information

What Are You Looking For?	Find it Here
<ul style="list-style-type: none">• Warranty information• Safety instructions• Regulatory information• Ergonomics information• End User License Agreement	<p data-bbox="721 321 1042 347">Dell™ Product Information Guide</p>  <p>The image shows the cover of the Dell Product Information Guide. It features the Dell logo at the bottom and the title 'Product Information Guide' at the top. The cover is white with a vertical line and some text in the center.</p>

<ul style="list-style-type: none">• How to set up my computer	<p data-bbox="721 668 871 694">Setup Diagram</p>  <p>The image is a setup diagram titled 'Setting Up Your Computer' with the Dell logo. It shows six numbered steps (1-6) for connecting various peripherals to a computer tower. Step 1 shows connecting a mouse and keyboard. Step 2 shows connecting a monitor and a power cord. Step 3 shows connecting a printer and a scanner. Step 4 shows connecting a headset. Step 5 shows connecting a monitor and a power cord. Step 6 shows connecting a monitor and a power cord. The diagram includes small images of the components and arrows indicating where to connect them. At the bottom, there is a barcode, the website 'www.dell.com', and the phone number '1-800-358-3535'.</p>
---	--

What Are You Looking For?

- Service Tag and Express Service Code
- Microsoft Windows License Label

Find it Here
Service Tag and Microsoft Windows License

These labels are located on your computer.

- Use the Service Tag to identify your computer when you use **support.dell.com** or contact technical support.



- Enter the Express Service Code to direct your call when contacting technical support. The Express Service Code is not available in all countries.

-
- Latest drivers for my computer
 - Answers to technical service and support questions
 - Online discussions with other users and technical support
 - Documentation for my computer

Dell Support Website — support.dell.com

NOTE: Select your region to view the appropriate support site.

The Dell Support website provides several online tools, including:

- Solutions — Troubleshooting hints and tips, articles from technicians, and online courses
- Community — Online discussion with other Dell customers
- Upgrades — Upgrade information for components, such as memory, the hard drive, and the operating system
- Customer Care — Contact information, order status, warranty, and repair information
- Downloads — Drivers, patches, and software updates
- Reference — Computer documentation, product specifications, and white papers

-
- How to use Windows XP
 - Documentation for my computer
 - Documentation for devices (such as a modem)

Windows Help and Support Center

- 1 Click the **Start** button and click **Help and Support**.
 - 2 Type a word or phrase that describes your problem and click the arrow icon.
 - 3 Click the topic that describes your problem.
 - 4 Follow the instructions on the screen.
-

Setting Up and Using Your Computer

Setting Up a Printer

 **NOTICE:** Complete the operating system setup before you connect a printer to the computer.

See the documentation that came with the printer for setup information, including how to:

- Obtain and install updated drivers.
- Connect the printer to the computer.
- Load paper and install the toner or ink cartridge.
- Contact the printer manufacturer for technical assistance.

Printer Cable

Your printer connects to your computer with either a USB cable or a parallel cable. Your printer may not come with a printer cable, so if you purchase a cable separately, ensure that it is compatible with your printer. If you purchased a printer cable at the same time you purchased your computer, the cable may arrive in the computer box.

Connecting a USB Printer

 **NOTE:** You can connect USB devices while the computer is turned on.

- 1 Complete the operating system setup, if you have not already done so.
- 2 Install the printer driver if necessary. See the documentation that came with your printer.
- 3 Attach the USB printer cable to the USB connectors on the computer and the printer. The USB connectors fit only one way.

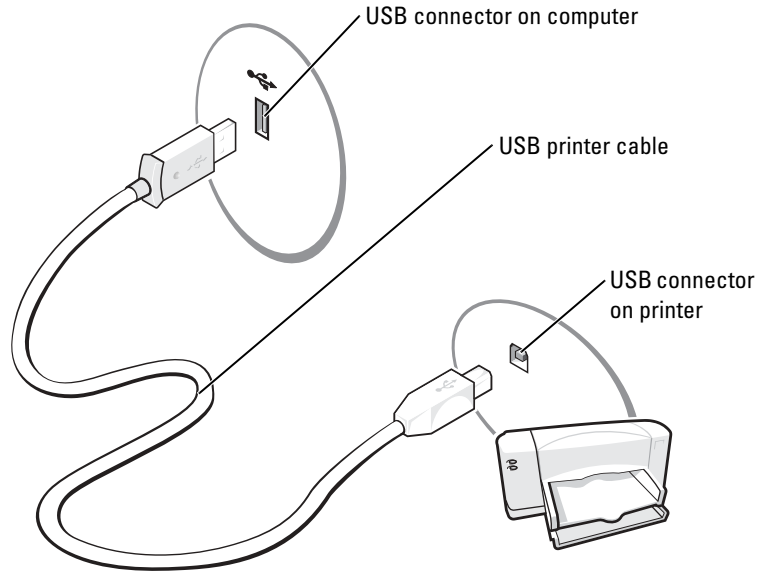

Connecting a Parallel Printer

- 1 Complete the operating system setup, if you have not already done so.
- 2 Turn off the computer (see page 59).

NOTICE: For best results, use a 3-m (10-ft) or shorter parallel cable.

- 3 Attach the parallel printer cable to the parallel connector on the computer and tighten the two screws. Attach the cable to the connector on the printer and snap the two clips into the two notches.

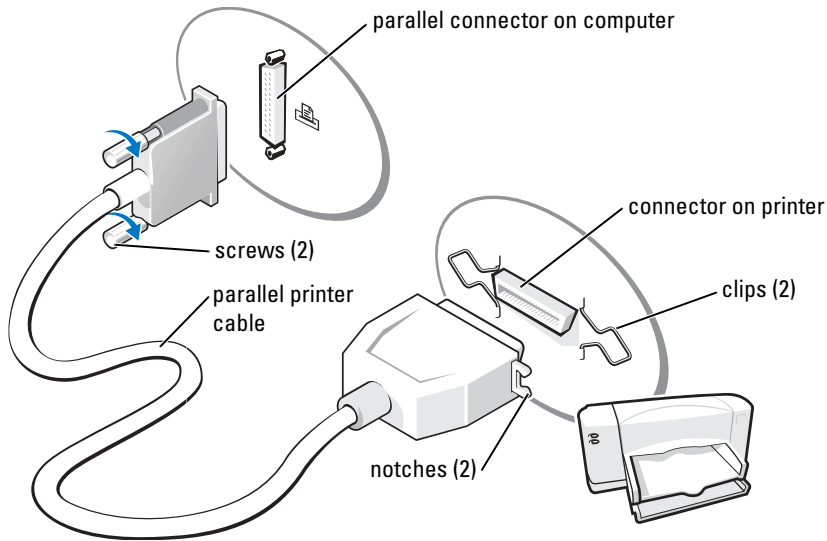

- 4 Turn on the printer and then turn on the computer. If the **Add New Hardware Wizard** window appears, click **Cancel**.
- 5 Install the printer driver if necessary. See the documentation that came with your printer.

Connecting to the Internet

 **NOTE:** ISPs and ISP offerings vary by country.

To connect to the Internet, you need a modem or network connection and an Internet service provider (ISP), such as AOL or MSN. Your ISP will offer one or more of the following Internet connection options:

- Dial-up connections that provide Internet access through a telephone line. Dial-up connections are considerably slower than DSL and cable modem connections.
- DSL connections that provide high-speed Internet access through your existing telephone line. With a DSL connection, you can access the Internet and use your telephone on the same line simultaneously.
- Cable modem connections that provide high-speed Internet access through your local cable TV line.

If you are using a dial-up connection, connect a telephone line to the modem connector on your computer and to the telephone wall jack before you set up your Internet connection. If you are using a DSL or cable modem connection, contact your ISP for setup instructions.

Setting Up Your Internet Connection

To set up an AOL or MSN connection:

- 1 Save and close any open files, and exit any open programs.
- 2 Double-click the **MSN Explorer** or **AOL** icon on the Microsoft® Windows® desktop.
- 3 Follow the instructions on the screen to complete the setup.

If you do not have an **MSN Explorer** or **AOL** icon on your desktop or if you want to set up an Internet connection with a different ISP:

- 1 Save and close any open files, and exit any open programs.
- 2 Click the **Start** button and click **Internet Explorer**.
The **New Connection Wizard** appears.
- 3 Click **Connect to the Internet**.
- 4 In the next window, click the appropriate option:
 - If you do not have an ISP and want to select one, click **Choose from a list of Internet service providers (ISPs)**.
 - If you have already obtained setup information from your ISP but you did not receive a setup CD, click **Set up my connection manually**.
 - If you have a CD, click **Use the CD I got from an ISP**.
- 5 Click **Next**.

If you selected **Set up my connection manually**, continue to step 6. Otherwise, follow the instructions on the screen to complete the setup.

 **NOTE:** If you do not know which type of connection to select, contact your ISP.

- 6 Click the appropriate option under **How do you want to connect to the Internet?**, and then click **Next**.
- 7 Use the setup information provided by your ISP to complete the setup.

If you are having problems connecting to the Internet, see "E-Mail, Modem, and Internet Problems" on page 35. If you cannot connect to the Internet but have successfully connected in the past, the ISP might have a service outage. Contact your ISP to check the service status, or try connecting again later.

Playing CDs or DVDs

 **NOTICE:** Do not press down on the CD or DVD tray when you open or close it. Keep the tray closed when you are not using the drive.

 **NOTICE:** Do not move the computer when you are playing CDs or DVDs.

- 1 Press the eject button on the front of the drive.
- 2 Place the disc, label side up, in the center of the tray.

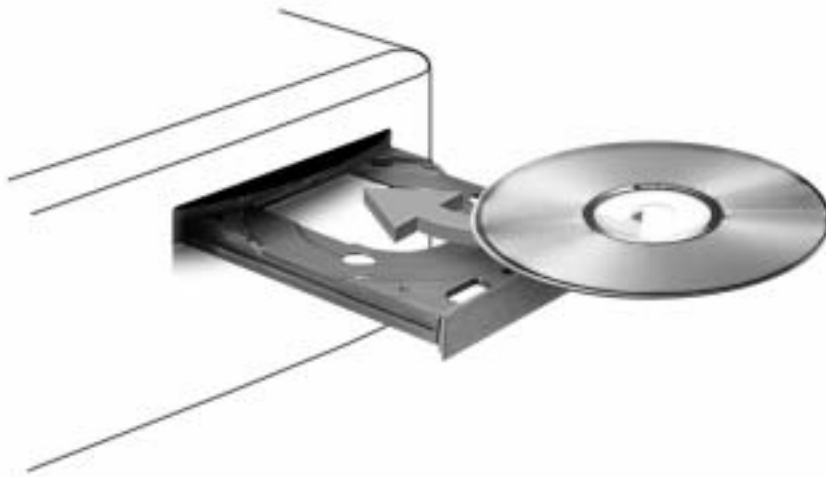









- 3 Press the eject button or gently push in the tray.

To format CDs for storing data, to create music CDs, or to copy CDs, see the CD software that came with your computer.











 **NOTE:** Ensure that you follow all copyright laws when you create CDs.

A CD player includes the following basic buttons:

	Play.
	Move backward within the current track.
	Pause.
	Move forward within the current track.

	Stop.
	Go to the previous track.
	Eject.
	Go to the next track.

A DVD player includes the following basic buttons:

	Stop.
	Restart the current chapter.
	Play.
	Fast forward.
	Pause.
	Fast reverse.
	Advance a single frame while in pause mode.
	Go to the next title or chapter.
	Continuously play the current title or chapter.
	Go to the previous title or chapter.
	Eject.

For more information on playing CDs or DVDs, click **Help** on the CD or DVD player (if available).

Adjusting the Volume

 **NOTE:** When the speakers are muted, you do not hear the CD or DVD playing.

- 1 Click the **Start** button, point to **All Programs**→**Accessories**→**Entertainment**, and then click **Volume Control**.
- 2 In the **Volume Control** window, click and drag the bar in the **Volume Control** column and slide it up or down to increase or decrease the volume.

For more information on volume control options, click **Help** in the **Volume Control** window.

Adjusting the Picture

If an error message notifies you that the current resolution and color depth are using too much memory and preventing DVD playback, adjust the display properties.

- 1 Click the **Start** button and click **Control Panel**.
- 2 Under **Pick a category**, click **Appearance and Themes**.
- 3 Under **Pick a task...**, click **Change the screen resolution**.
- 4 In the **Display Properties** window, click and drag the bar in **Screen resolution** to change the setting to **800 by 600 pixels**.
- 5 Click the drop-down menu under **Color quality**, and then click **Medium (16 bit)**.
- 6 Click **OK**.

Copying CDs and DVDs

 **NOTE:** Ensure that you follow all copyright laws when you create CDs or DVDs.

This section applies only to computers that have a CD-R, CD-RW, DVD+RW, DVD+R, or DVD/CD-RW combo drive.

 **NOTE:** The types of CD or DVD drives offered by Dell may vary by country.

The following instructions show how to make an exact copy of a CD or DVD. You can also use Sonic RecordNow for other purposes, including creating CDs from audio files on your computer and creating MP3 CDs. For instructions, see the Sonic RecordNow documentation that came with your computer. Open Sonic RecordNow, click the question mark icon in the upper-right corner of the window, and then click **RecordNow Help** or **RecordNow Tutorial**.

How to Copy a CD or DVD

 **NOTE:** If you have a DVD/CD-RW combo drive and you experience recording problems, check for available software patches at the Sonic support website at support.sonic.com.

Currently, five DVD-writable disc formats are available: DVD+R, DVD+RW, DVD-R, DVD-RW, and DVD-RAM. The DVD-writable drives installed in Dell™ computers can write to DVD+R and DVD+RW media, and can read DVD-R and DVD-RW media. However, DVD-writable drives do not write to and might not read DVD-RAM media. In addition, commercially available DVD players for home theater systems might not read all five formats.

 **NOTE:** Most commercial DVDs have copyright protection and cannot be copied using Sonic RecordNow.

- 1 Click the **Start** button, point to **All Programs**→ **Sonic**→ **RecordNow!**, and then click **RecordNow!**
- 2 Click either the audio tab or the data tab, depending on the kind of CD or DVD you want to copy.
- 3 Click **Exact Copy**.

4 To copy the CD or DVD:

- *If you have one CD or DVD drive*, ensure that the settings are correct and click **Copy**. The computer reads your source CD or DVD and copies it to a temporary folder on your computer hard drive.

When prompted, insert a blank CD or DVD into the CD or DVD drive and click **OK**.

- *If you have two CD or DVD drives*, select the drive into which you have inserted your source CD or DVD and click **Copy**. The computer copies the data on the CD or DVD to the blank CD or DVD.

Once you have finished copying the source CD or DVD, the CD or DVD that you have created automatically ejects.

Using Blank CD-Rs and CD-RWs

Your CD-RW drive can write to two different types of recording media—CD-Rs and CD-RWs (including high-speed CD-RWs). Use blank CD-Rs to record music or permanently store data files. After creating a CD-R, you cannot write to that CD-R again (see the Sonic documentation for more information). Use blank CD-RWs to write to CDs or to erase, rewrite, or update data on CDs.

Your DVD-writable drive can write to four different types of recording media—CD-Rs, CD-RWs (including high-speed CD-RWs), DVD+Rs, and DVD+RWs. Blank DVD+Rs can be used to permanently store large amounts of information. After you create a DVD+R disc, you may not be able to write to that disc again if the disc is "finalized" or "closed" during the final stage of the disc creation process. Use blank DVD+RWs if you plan to erase, rewrite, or update information on that disc later.

Helpful Tips

- Use Microsoft® Windows® Explorer to drag and drop files to a CD-R or CD-RW only after you start Sonic RecordNow and open a RecordNow project.
- You must use CD-Rs to burn music CDs that you want to play in regular stereos. CD-RWs do not play in most home or car stereos.
- You cannot create audio DVDs with Sonic RecordNow.
- Music MP3 files can be played only on MP3 players or on computers that have MP3 software installed.
- Do not burn a blank CD-R or CD-RW to its maximum capacity; for example, do not copy a 650-MB file to a 650-MB blank CD. The CD-RW drive needs 1 or 2 MB of the blank CD to finalize the recording.
- Use a blank CD-RW to practice CD recording until you are familiar with CD recording techniques. If you make a mistake, you can erase the data on the CD-RW and try again. You can also use blank CD-RWs to test music file projects before you record the project permanently to a blank CD-R.

See the Sonic support website at support.sonic.com for additional information.

Connecting Two Monitors

CAUTION: Before you begin any of the procedures in this section, follow the safety instructions located in the *Product Information Guide*.

NOTE: If you are connecting two monitors that have VGA connectors, you must have the optional DVI adapter. If you are connecting two flat-panel monitors, at least one of them must have a VGA connector. If you are connecting a TV, you may connect only one monitor (VGA or DVI) in addition to the TV.

If you purchased a graphics card that supports dual monitors, follow these instructions to connect and enable your monitors. The instructions tell you how to connect either two monitors (each with a VGA connector), one monitor with a VGA connector and one monitor with a DVI connector, or a TV.

Connecting Two Monitors With VGA Connectors

- 1 Follow the procedures in "Before You Begin" on page 59.

NOTE: If your computer has integrated video, do not connect either monitor to the integrated video connector. If the integrated video connector is covered by a cap, do not remove the cap to connect the monitor or the monitor will not function.

- 2 Connect one of the monitors to the VGA (blue) connector on the back of the computer.
- 3 Connect the other monitor to the optional DVI adapter and connect the DVI adapter to the DVI (white) connector on the back of the computer.

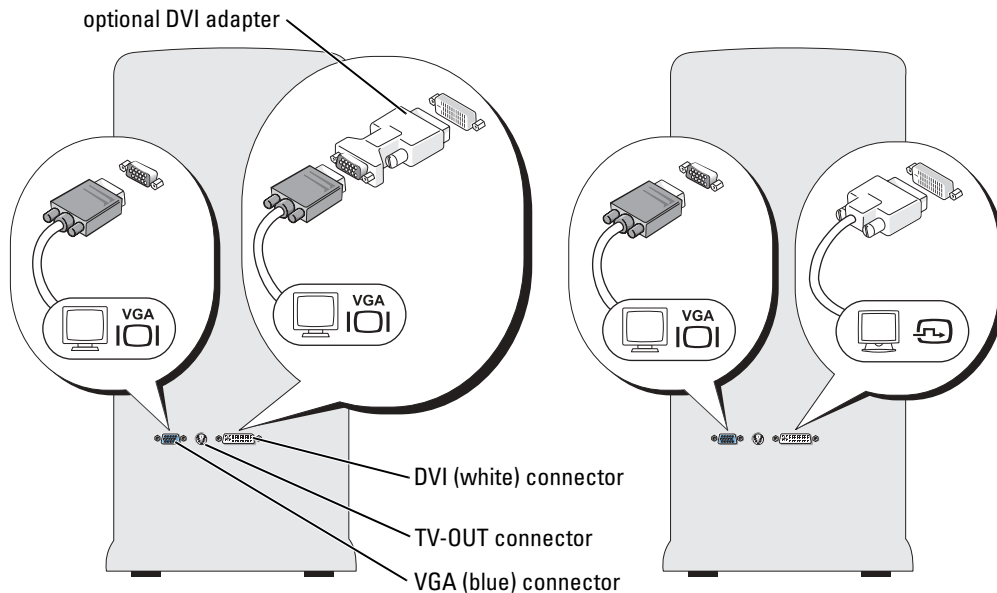

Connecting One Monitor With a VGA connector and One Monitor With a DVI Connector

- 1 Follow the procedures in "Before You Begin" on page 59.
- 2 Connect the VGA connector on the monitor to the VGA (blue) connector on the back of the computer.
- 3 Connect the DVI connector on the other monitor to the DVI (white) connector on the back of the computer.

Connecting a TV

 **NOTE:** To connect a TV to your computer, you must purchase an S-video cable, which is available at most consumer electronics stores. An S-video cable is not included with your computer.

- 1 Follow the procedures in "Before You Begin" on page 59.
- 2 Connect one end of the S-video cable to the TV-OUT connector on the back of the computer.
- 3 Connect the other end of the S-video cable to the S-video input connector on your TV.
- 4 Connect the VGA or DVI monitor.

Changing the Display Settings

- 1 After you connect the monitor(s) or TV, turn on the computer.
The Microsoft® Windows® desktop displays on the primary monitor.
- 2 Enable clone mode or extended desktop mode in the display settings.
 - In clone mode, both monitors display the same image.
 - In extended desktop mode, you can drag objects from one screen to the other, effectively doubling the amount of viewable work space.

For information on changing the display settings for your graphics card, see the user's guide in the Help and Support Center (click the **Start** button, click **Help and Support**, click **User and system guides**, click **Device guides**, and then click the guide for your graphics card).

About Your RAID Configuration

This section provides an overview of the RAID configuration that you might have selected when you purchased your computer. Although several RAID configurations are available, Dell offers either RAID level 0 or RAID level 1 for its Dimension computers. A RAID level 0 configuration is recommended for high-performance gaming, and a RAID level 1 configuration is recommended for the data integrity requirements of digital photography and audio.

The Intel RAID controller on your computer can only create a RAID volume using two physical drives. If a third drive is present, then that drive cannot be made part of a RAID volume using the Intel RAID configuration program, although it can be used as a spare drive in a RAID 1 configuration (see "Creating a Spare Hard Drive" on page 27). However, if four drives are present in

your computer, then each pair of drives can be made into RAID level 0 or RAID level 1 volumes. The drives should be the same size in order to ensure that the larger drive does not contain unallocated (and therefore unusable) space.

NOTE: RAID levels do not represent a hierarchy. A RAID level 1 configuration is not inherently better or worse than a RAID level 0 configuration.

RAID Level 0

RAID level 0 uses a storage technique known as "data striping" to provide a high data access rate. Data striping is a method of writing consecutive segments, or stripes, of data sequentially across the physical drives to create a large virtual drive. Data striping allows one of the drives to read data while the other drive is searching for and reading the next block.

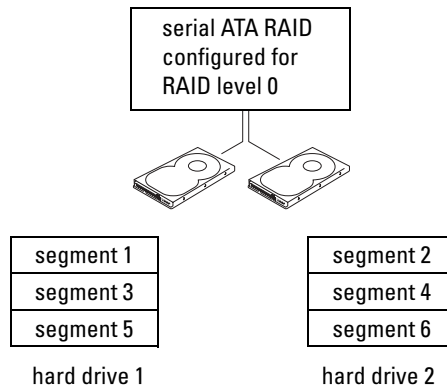

Another advantage of a RAID level 0 configuration is that it utilizes the full capacities of the drives. For example, if you have two 120-GB drives installed, you have 240 GB on which to store data.

NOTE: Because RAID level 0 provides no data redundancy, if one drive fails, then the data on the other drive is also inaccessible. Therefore, ensure that you perform regular backups when you use a RAID level 0 configuration.

RAID Level 1

RAID level 1 uses a data-redundancy storage technique known as "mirroring." When data is written to the primary drive, it is then duplicated, or mirrored, on the other drive. A RAID level 1 configuration sacrifices high data access rates for its data redundancy advantages.

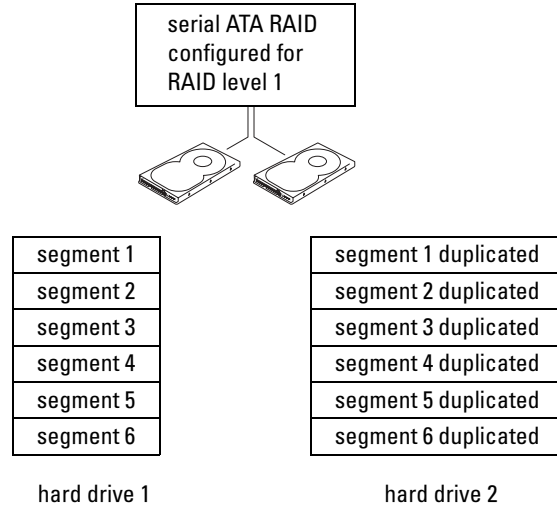

If a drive failure occurs, subsequent read and write operations are directed to the surviving drive. A replacement drive can then be rebuilt using the data from the surviving drive. Also, because data is duplicated on both drives, two 120-GB RAID level 1 drives collectively have a maximum of 120-GB on which to store data.

Configuring Your Computer for RAID

At some point you may want to configure your computer for RAID if you did not select a RAID configuration when you purchased your computer. You must have at least two hard drives installed in your computer to set up a RAID configuration. For instructions on how to install a hard drive, see page 92.

You can use one of two methods to configure RAID hard drive volumes. One method uses the Intel(R) Option ROM utility, and is performed *before* you install the operating system onto the hard drive. The second method uses the Intel Application Accelerator, or Intel Storage Utility, and this method is performed *after* you have installed the operating system and the Intel Storage Utility. Both methods require that you set your computer to RAID-enabled mode before starting any of the RAID configuration procedures in this document.

Setting Your Computer to RAID-Enabled Mode

- 1 Enter system setup (see page 112).
- 2 Use the up- and down-arrow keys to highlight **Drives**, and press <Enter>.
- 3 Use the up- and down-arrow keys to highlight **Drive Controller**, and press <Enter>.
- 4 Use the left- and right-arrow keys to highlight **RAID On**, press <Enter>, and then press <Esc>.

- 5 Use the left- and right-arrow keys to highlight **Save/Exit**, and press <Enter> to exit system setup and resume the boot process.

Configuring for RAID Using the Intel(R) Option ROM Utility

 **NOTE:** Although any size drives may be used to create a RAID configuration using the Intel Option ROM utility, ideally the drives should be of equal size. In a RAID level 0 configuration, the size of the array will be the size of the smallest disk multiplied by the number (two) of disks in the array. In a RAID level 1 configuration, the size of the array will be the smaller of the two disks used.

Creating a RAID Level 0 Configuration

 **NOTICE:** You will lose any data on your hard drives when you create a RAID configuration using the following procedure. Back up data you want to keep before continuing.

 **NOTE:** The following procedure should only be used if you are reinstalling your operating system. The following procedure should not be used to migrate an existing storage configuration to RAID 0.

- 1 Set your computer to RAID-enabled mode (see page 22).
- 2 Press <Ctrl> <i> when you are prompted to enter the Intel(R) RAID Option ROM utility.
- 3 Use the up- and down-arrow keys to highlight **Create RAID Volume**, and press <Enter>.
- 4 Enter a RAID volume name or accept the default, and press <Enter>.
- 5 Use the up- and down-arrow keys to select **RAID0(Stripe)**, and press <Enter>.
- 6 If there are more than two hard disks available, use the up- and down-arrow keys and space bar to select the two disks you want to use to make up your array, and then press <Enter>.

 **NOTE:** Select the strip size closest to the size of the average file you want to store on the RAID volume. If you do not know the average file size, choose 128 as your strip size.

- 7 Use the up- and down-arrow keys to change the strip size, and press <Enter>.
- 8 Select the desired capacity for the volume, and press <Enter>. The default value is the maximum available size.
- 9 Press <Enter> to create the volume.
- 10 Press <y> to confirm that you want to create the RAID volume.
- 11 Confirm that the correct volume configuration is displayed on the main Intel Option ROM screen.
- 12 Use the up- and down-arrow keys to select **Exit**, and press <Enter>.
- 13 Install the operating system.

Creating a RAID Level 1 Configuration

- 1 Set your computer to RAID-enabled mode (see page 22).
- 2 Press <Ctrl> <i> when you are prompted to enter Intel RAID Option ROM.
- 3 Use the up- and down-arrow keys to highlight **Create RAID Volume**, and press <Enter>.

- 4 Enter a RAID volume name or accept the default, and press <Enter>.
- 5 Use the up- and down-arrow keys to select **RAID1 (Mirror)**, and press <Enter>.
- 6 If there are more than two hard disks available, use the up- and down-arrow keys and space bar to select the two disks you want to use to make up your array, and then press <Enter>.
- 7 Select the desired capacity for the volume, and press <Enter>. The default value is the maximum available size.
- 8 Press <Enter> to create the volume.
- 9 Press <y> to confirm that you want to create the RAID volume.
- 10 Confirm that the correct volume configuration is displayed on the main Intel Option ROM screen.
- 11 Use the up- and down-arrow keys to select **Exit**, and press <Enter>.
- 12 Install the operating system.

Deleting a RAID Volume



NOTE: When you perform this operation, all data on the RAID drives will be lost.



NOTE: If your computer currently boots to RAID and you delete the RAID volume in the Intel RAID Option ROM, your computer will become unbootable.

- 1 Press <Ctrl><i> when you are prompted to enter the Intel RAID Option ROM utility.
- 2 Use the up- and down-arrow keys to highlight **Delete RAID Volume**, and press <Enter>.
- 3 Use the up- and down-arrow keys to highlight the RAID volume you want to delete, and press <Delete>.
- 4 Press <y> to confirm the deletion of the RAID volume.
- 5 Press <Esc> to exit the Intel Option ROM utility.

Configuring for RAID Using the Intel(R) Application Accelerator

If you already have one hard drive with the operating system installed on it, and you want to add a second hard drive and reconfigure both drives into a RAID volume without losing the existing operating system and any data, you need to use the migrating option (see "Migrating to a RAID 0 Volume" on page 26 or "Migrating to a RAID 1 Volume" on page 27). Create a RAID 0 Volume or RAID 1 Volume only when:

- You are adding two new drives to an existing single-drive computer (and the operating system is on the single drive), and you want to configure the two new drives into a RAID volume.
- You already have a two-hard drive computer configured into an array, but you still have some space left on the array that you want to designate as a second RAID volume.

Creating a RAID 0 Volume

 **NOTE:** When you perform this operation, all data on the RAID drives will be lost.

- 1 Set your computer to RAID-enabled mode (see page 22).
- 2 Click **Start** and point to **Programs**→ **Intel(R) Application Accelerator**→ **Intel Application Accelerator** to launch the Intel(R) Storage Utility.

 **NOTE:** If you do not see an **Actions** menu option, you have not yet set your computer to RAID-enabled mode (see page 22).

- 3 On the **Actions** menu, select **Create RAID Volume** to launch the Create RAID Volume Wizard, and then click **Next**.
- 4 On the **Select Volume Location** screen, click the first hard drive you want to include in your RAID 0 volume, and then click the right arrow. Click a second hard drive until two drives appear in the **Selected** window, and then click **Next**.
- 5 In the **Specify Volume Size** window, click the **Volume Size** desired, and then click **Next**.
- 6 Click **Finish** to create the volume, or click **Back** to make changes.

Creating a RAID 1 Volume

 **NOTE:** When you perform this operation, all data on the RAID drives will be lost.

- 1 Set your computer to RAID-enabled mode (see page 22).
- 2 Click the **Start** button and point to **Programs**→ **Intel(R) Application Accelerator**→ **Intel Application Accelerator** to launch the Intel(R) Storage Utility.

 **NOTE:** If you do not see an **Actions** menu option, you have not yet set your computer to RAID-enabled mode (see page 22).

- 3 On the **Actions** menu, select **Create RAID Volume** to launch the Create RAID Volume Wizard.
- 4 Click **Next** at the first screen.
- 5 Confirm the volume name, select **RAID 1** as the RAID level, and then click **Next** to continue.
- 6 On the **Select Volume Location** screen, click the first hard drive you want to use to create your RAID 0 volume, and then click the right arrow. Click a second hard drive until two drives appear in the **Selected** window, and then click **Next**.
- 7 In the **Specify Volume Size** window, select the **Volume Size** desired and click **Next**.
- 8 Click **Finish** to create the volume, or click **Back** to make changes.
- 9 Follow Microsoft Windows procedures for creating a partition on the new RAID volume.

Deleting a RAID Volume

 **NOTE:** While this procedure deletes the RAID 1 volume, it also splits the RAID 1 volume into two non-RAID hard drives with a partition, and leaves any existing data files intact. Deleting a RAID 0 volume, however, destroys all data on the volume.

- 1 Click the **Start** button and point to **Programs**→**Intel(R) Application Accelerator**→**Intel Application Accelerator** to launch the Intel(R) Storage Utility.
- 2 Right-click the **Volume** icon of the RAID volume you want to delete, and select **Delete Volume**.
- 3 On the **Delete RAID Volume Wizard** screen, click **Next**.
- 4 Highlight the RAID volume you want to delete in the **Available** box, click the right-arrow button to move the highlighted RAID volume into the **Selected** box, and then click **Next**.
- 5 Click **Finish** to delete the volume.

Migrating to a RAID 0 Volume

- 1 Set your computer to RAID-enabled mode (see page 22).
- 2 Click the **Start** button and point to **All Programs**→**Intel(R) Application Accelerator**→**Intel Application Accelerator** to launch the Intel(R) Storage Utility.

 **NOTE:** If you do not see an **Actions** menu option, you have not yet set your computer to RAID-enabled mode (see page 22).

- 3 On the **Actions** menu, select **Create RAID Volume From Existing Hard Drive** to launch the Migration Wizard.
- 4 Click **Next** on the Migration Wizard screen.
- 5 Enter a RAID volume name or accept the default.
- 6 From the drop-down box, select **RAID 0** as the RAID level.

 **NOTE:** Select the strip size closest to the size of the average file you want to store on the RAID volume. If you do not know the average file size, choose 128 as your strip size.

- 7 Select the appropriate strip size from the drop-down box, and then click **Next**.

 **NOTE:** Select the hard drive that you want to use as your source hard drive (it should be the hard drive containing the data or operating system files that you want to keep on the RAID volume).

- 8 On the **Select Source Hard Drive** screen, double-click the hard drive from which you want to migrate, and click **Next**.
- 9 On the **Select Member Hard Drive** screen, double-click the hard drive to select the member drive to span the stripe array, and click **Next**.
- 10 On the **Specify Volume Size** screen, select the **Volume Size** you want, and click **Next**.

 **NOTE:** In the following step, you will lose all data contained on the member drive.

- 11 Click **Finish** to start migrating, or click **Back** to make changes. You can use your computer normally during the migration process.

Migrating to a RAID 1 Volume

- 1 Set your computer to RAID-enabled mode (see page 22).
- 2 Click the **Start** button and point to **All Programs**→**Intel(R) Application Accelerator**→**Intel Application Accelerator** to launch the Intel(R) Storage Utility.

 **NOTE:** If you do not see an **Actions** menu option, you have not yet set your computer to RAID-enabled mode (see page 22).

- 3 On the **Actions** menu, click **Create RAID Volume From Existing Hard Drive** to launch the Migration Wizard.
- 4 Click **Next** on the first Migration Wizard screen.
- 5 Enter a RAID volume name or accept the default.
- 6 From the drop-down box, select **RAID 1** as the RAID level.

 **NOTE:** Select the hard drive that already has the data or operating system files that you want to maintain on the RAID volume as your source hard drive.

- 7 On the **Select Source Hard Drive** screen, double-click the hard drive from which you want to migrate, and click **Next**.
- 8 On the **Select Member Hard Drive** screen, double-click the hard drive to select the member drive that you want to act as the mirror in the array, and click **Next**.
- 9 On the **Specify Volume Size** screen, select the volume size you want, and click **Next**.

 **NOTE:** In the following step, you will lose all data contained on the member drive.

- 10 Click **Finish** to start migrating, or click **Back** to make changes. You can use your computer normally during migration process.

Creating a Spare Hard Drive

A spare hard drive may be created with a RAID 1 array. The spare hard drive will not be recognized by the operating system, but you will be able to see the spare drive from within Disk Manager or the Intel Option ROM Utility. When a member of the RAID 1 array is broken, the computer automatically rebuilds the mirror array using the spare hard drive as the broken member's replacement.

To Mark a Drive as a Spare Hard Drive:

- 1 Click the **Start** button and point to **Programs**→**Intel(R) Application Accelerator**→**Intel Application Accelerator** to launch the Intel(R) Storage Utility.
- 2 Right-click the hard drive you want to mark as a spare hard drive.
- 3 Click **Mark as Spare**.

To Remove Spare Marking From a Spare Hard Drive:

- 1 Right-click the spare hard drive icon.
- 2 Click **Reset Hard Drive to Non-RAID**

Rebuilding a Degraded RAID 1 Volume

If your computer does not have a spare hard drive, and the computer has reported a degraded RAID 1 volume, you can manually rebuild the computer's redundancy mirror to a new hard drive by performing the following steps:

- 1 Click the **Start** button and point to **Programs**→ **Intel(R) Application Accelerator**→ **Intel Application Accelerator** to launch the Intel(R) Storage Utility.
- 2 Right-click the available hard drive to which you want to rebuild the RAID 1 volume, and click **Rebuild to this Disk**.
- 3 You can use your computer while the computer is rebuilding the RAID 1 volume.

Setting Up a Home and Office Network

Connecting to a Network Adapter

 **NOTE:** Plug the network cable into the network adapter connector on the computer. Do not plug the network cable into the modem connector on the computer. Do not plug a network cable into a telephone wall jack.

- 1 Connect the network cable to the network adapter connector on the back of your computer. Insert the cable until it clicks into place, and then gently pull it to ensure that it is secure.
- 2 Connect the other end of the network cable to a network device.

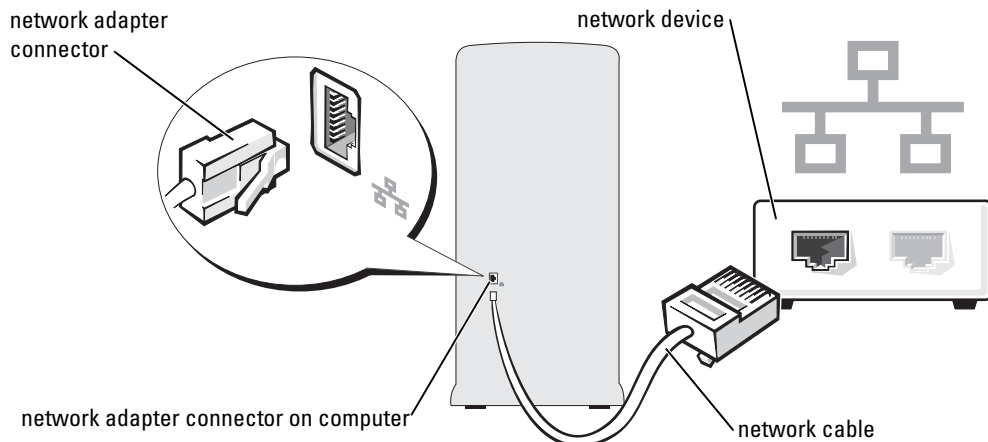

Network Setup Wizard

The Microsoft® Windows® XP operating system provides a Network Setup Wizard to guide you through the process of sharing files, printers, or an Internet connection between computers in a home or small office.

- 1 Click the **Start** button, point to **All Programs**→**Accessories**→**Communications**, and then click **Network Setup Wizard**.
- 2 On the welcome screen, click **Next**.
- 3 Click **Checklist for creating a network**.



NOTE: Selecting the connection method **This computer connects directly to the Internet** enables the integrated firewall provided with Windows XP Service Pack 1 (SP1).

- 4 Complete the checklist and required preparations.
- 5 Return to the Network Setup Wizard and follow the instructions on the screen.

Power Management

Overview

The Microsoft® Windows® XP power management features can reduce the amount of electricity your computer uses when it is on and you are not using it. You can reduce power to just the monitor or the hard drive, or you can use standby mode or hibernate mode to reduce power to the entire computer. When the computer exits from a power conservation mode, the Windows desktop is restored to the state it was in before it entered the mode.



NOTE: Windows XP Professional includes security and networking features not available in Windows XP Home Edition. When a Windows XP Professional computer is connected to a network, different options related to security and networking appear in certain windows.

Standby Mode

Standby mode conserves power by turning off the display and the hard drive after a time-out. When the computer exits from standby mode, it returns to the operating state it was in before it entered standby mode.

To set standby mode to automatically activate after a defined period of inactivity:

- 1 Click the **Start** button and click **Control Panel**.
- 2 Under **Pick a category**, click **Performance and Maintenance**.
- 3 Under or pick a **Control Panel icon**, click **Power Options**.

To immediately activate standby mode without a period of inactivity, click the **Start** button, click **Turn Off Computer**, and then click **Stand by**.

To exit from standby mode, press a key on the keyboard or move the mouse.



NOTICE: If your computer loses power while in standby mode, it may lose data.

Hibernate Mode

Hibernate mode conserves power by copying system data to a reserved area on the hard drive and then completely turning off the computer. When the computer exits from hibernate mode, the desktop is restored to the state it was in before it entered hibernate mode.

To activate hibernate mode:

- 1 Click the **Start** button and click **Control Panel**.
- 2 Under **Pick a category**, click **Performance and Maintenance**.
- 3 Under or pick a **Control Panel icon**, click **Power Options**.
- 4 Define your hibernate settings on the **Power Schemes** tab, **Advanced** tab, and **Hibernate** tab.

To exit from hibernate mode, press the power button. The computer may take a short time to exit from hibernate mode. Pressing a key on the keyboard or moving the mouse does not bring the computer out of hibernation, because the keyboard and the mouse do not function when the computer is in hibernate mode.

Because hibernate mode requires a special file on your hard drive with enough disk space to store the contents of the computer memory, Dell creates an appropriately sized hibernate mode file before shipping the computer to you. If the computer's hard drive becomes corrupted, Windows XP recreates the hibernate file automatically.

Power Options Properties

Define your standby mode settings, hibernate mode settings, and other power settings in the **Power Options Properties** window. To access the **Power Options Properties** window:

- 1 Click the **Start** button and click **Control Panel**.
- 2 Under **Pick a category**, click **Performance and Maintenance**.
- 3 Under or pick a **Control Panel icon**, click **Power Options**.
- 4 Define your power settings on the **Power Schemes** tab, **Advanced** tab, and **Hibernate** tab.

Power Schemes Tab

Each standard power setting is called a scheme. If you want to select one of the standard Windows schemes installed on your computer, choose a scheme from the **Power schemes** drop-down menu. The settings for each scheme appear in the fields below the scheme name. Each scheme has different settings for starting standby mode or hibernate mode, turning off the monitor, and turning off the hard drive.

The **Power schemes** drop-down menu displays the following schemes:

- **Always On** (default) — If you want to use your computer with no power conservation.
- **Home/Office Desk** — If you use your computer as a home or office computer and you require minimal power conservation.
- **Portable/Laptop** — If your computer is a portable computer that you use for traveling.

- **Presentation** — If you want your computer to run without interruption (using no power conservation).
- **Minimal Power Management** — If you want your computer to run with minimal power conservation.
- **Max Battery** — If your computer is a portable computer and you run your computer from batteries for extended periods of time.

If you want to change the default settings for a scheme, click the drop-down menu in the **Turn off monitor**, **Turn off hard disks**, **System stand by**, or **System hibernates** field, and then select a time-out from the displayed list. Changing the time-out for a scheme field permanently changes the default settings for that scheme, unless you click **Save As** and enter a new name for the changed scheme.



NOTICE: If you set the hard drive (hard disk) to time-out before the monitor does, your computer may appear to be locked up. To recover, press any key on the keyboard or click the mouse. To avoid this problem, always set the monitor to time-out before the hard drive.

Advanced Tab

The **Advanced** tab allows you to:

- Place the power options icon  in the Windows taskbar for quick access.
- Set the computer to prompt you for your Windows password before the computer exits from standby mode or hibernate mode.
- Program the power button to activate standby mode, activate hibernate mode, or turn off the computer.

To program these functions, click an option from the corresponding drop-down menu and click **OK**.

Hibernate Tab

The **Hibernate** tab allows you to enable hibernate mode. If you want to use the hibernate settings you defined on the **Power Schemes** tab, click the **Enable hibernate support** check box on the **Hibernate** tab.

For more information on power management options:

- 1 Click the **Start** button and click **Help and Support**.
- 2 In the **Help and Support** window, click **Performance and maintenance**.
- 3 In the **Performance and maintenance** window, click **Conserving power on your computer**.

Hyper-Threading

Hyper-Threading is an Intel[®] technology that can enhance overall computer performance by allowing one physical processor to function as two logical processors, capable of performing certain tasks simultaneously. It is recommended that you use the Microsoft[®] Windows[®] XP Service Pack 1

(SP1) or later operating system because Windows XP is optimized to take advantage of Hyper-Threading technology. While many programs can benefit from Hyper-Threading, some programs have not been optimized for Hyper-Threading and may require an update from the software manufacturer. Contact the software manufacturer for updates and information about using Hyper-Threading with your software.

To determine if your computer is using Hyper-Threading technology:

- 1 Click the **Start** button, right-click **My Computer**, and then click **Properties**.
- 2 Click **Hardware** and click **Device Manager**.
- 3 In the **Device Manager** window, click the plus (+) sign next to **Processors**. If Hyper-Threading is enabled, the processor is listed twice.

You can enable or disable Hyper-Threading through system setup. For more information on accessing system setup, see page 111. For more information on Hyper-Threading, search the Knowledge Base on the Dell Support website at support.dell.com.

Solving Problems

Troubleshooting Tips

Follow these tips when you troubleshoot your computer:

- If you added or removed a part before the problem started, review the installation procedures and ensure that the part is correctly installed.
- If a peripheral device does not work, ensure that the device is properly connected.
- If an error message appears on the screen, write down the exact message. This message may help technical support personnel diagnose and fix the problem(s).
- If an error message occurs in a program, see the program's documentation.

Battery Problems



CAUTION: There is a danger of a new battery exploding if it is incorrectly installed. Replace the battery only with the same or equivalent type recommended by the manufacturer. Discard used batteries according to the manufacturer's instructions.



CAUTION: Before you begin any of the procedures in this section, follow the safety instructions located in the *Product Information Guide*.

REPLACE THE BATTERY — If you have to repeatedly reset time and date information after turning on the computer, or if an incorrect time or date displays during start-up, replace the battery (see page 103). If the battery still does not work properly, contact Dell (see page 123).

Card Fan Problems



CAUTION: Before you begin any of the procedures in this section, follow the safety instructions located in the *Product Information Guide*.

CHECK THE CABLE CONNECTIONS — Ensure that the card fan cable is connected firmly to the card fan connector on the system board (see page 71).

Drive Problems



CAUTION: Before you begin any of the procedures in this section, follow the safety instructions located in the *Product Information Guide*.

ENSURE THAT MICROSOFT® WINDOWS® RECOGNIZES THE DRIVE — Click the **Start** button and click **My Computer**. If the floppy, CD, or DVD drive, is not listed, perform a full scan with your antivirus software to check for and remove viruses. Viruses can sometimes prevent Windows from recognizing the drive.

TEST THE DRIVE —

- Insert another floppy disk, CD, or DVD to eliminate the possibility that the original one is defective.
- Insert a bootable floppy disk and restart the computer.

CLEAN THE DRIVE OR DISK — See "Cleaning Your Computer" on page 119.

CHECK THE CABLE CONNECTIONS

RUN THE HARDWARE TROUBLESHOOTER — See page 58.

RUN THE DELL DIAGNOSTICS — See page 52.

CD and DVD drive problems



NOTE: High-speed CD or DVD drive vibration is normal and may cause noise, which does not indicate a defect in the drive or the CD or DVD.



NOTE: Because of different regions worldwide and different disc formats, not all DVD titles work in all DVD drives.

ADJUST THE WINDOWS VOLUME CONTROL —

- Click the speaker icon in the lower-right corner of your screen.
- Ensure that the volume is turned up by clicking the sidebar and dragging it up.
- Ensure that the sound is not muted by clicking any boxes that are checked.

CHECK THE SPEAKERS AND SUBWOOFER — See "Sound and Speaker Problems" on page 45.

Problems writing to a CD/DVD-RW drive

CLOSE OTHER PROGRAMS — The CD/DVD-RW drive must receive a steady stream of data when writing. If the stream is interrupted, an error occurs. Try closing all programs before you write to the CD/DVD-RW.

TURN OFF STANDBY MODE IN WINDOWS BEFORE WRITING TO A CD/DVD-RW DISC — See "Standby Mode" on page 29 or search for the keyword *standby* in Windows Help (see page 10) for information on power management modes.

Hard drive problems

RUN CHECK DISK —

- 1 Click the **Start** button and click **My Computer**.
- 2 Right-click **Local Disk C:**.
- 3 Click **Properties**.
- 4 Click the **Tools** tab.
- 5 Under **Error-checking**, click **Check Now**.
- 6 Click **Scan for and attempt recovery of bad sectors**.
- 7 Click **Start**.

E-Mail, Modem, and Internet Problems



CAUTION: Before you begin any of the procedures in this section, follow the safety instructions located in the *Product Information Guide*.



NOTE: Connect the modem to an analog telephone jack only. The modem does not operate while it is connected to a digital telephone network.

CHECK THE MICROSOFT OUTLOOK® EXPRESS SECURITY SETTINGS — If you cannot open your e-mail attachments:

- 1 In Outlook Express, click **Tools**, click **Options**, and then click **Security**.
- 2 Click **Do not allow attachments** to remove the checkmark.

CHECK THE TELEPHONE LINE CONNECTION —**CHECK THE TELEPHONE JACK —****CONNECT THE MODEM DIRECTLY TO THE TELEPHONE WALL JACK —****USE A DIFFERENT TELEPHONE LINE —**

- Verify that the telephone line is connected to the jack on the modem. (The jack has either a green label or a connector-shaped icon next to it.)
- Ensure that you hear a click when you insert the telephone line connector into the modem.
- Disconnect the telephone line from the modem and connect it to a telephone. Listen for a dial tone.
- If you have other telephone devices sharing the line, such as an answering machine, fax machine, surge protector, or line splitter, then bypass them and use the telephone to connect the modem directly to the telephone wall jack. If you are using a line that is 3 m (10 ft) or more in length, try a shorter one.

RUN THE MODEM HELPER DIAGNOSTICS — Click the **Start** button, point to **All Programs**, and then click **Modem Helper**. Follow the instructions on the screen to identify and resolve modem problems. (Modem Helper is not available on all computers.)

VERIFY THAT THE MODEM IS COMMUNICATING WITH WINDOWS —

- 1 Click the **Start** button and click **Control Panel**.
 - 2 Click **Printers and Other Hardware**.
 - 3 Click **Phone and Modem Options**.
 - 4 Click the **Modems** tab.
 - 5 Click the COM port for your modem.
 - 6 Click **Properties**, click the **Diagnostics** tab, and then click **Query Modem** to verify that the modem is communicating with Windows.
- If all commands receive responses, the modem is operating properly.

ENSURE THAT YOU ARE CONNECTED TO THE INTERNET — Ensure that you have subscribed to an Internet provider. With the Outlook Express e-mail program open, click **File**. If **Work Offline** has a checkmark next to it, click the checkmark to remove it and connect to the Internet. For help, contact your Internet service provider.

Error Messages



CAUTION: Before you begin any of the procedures in this section, follow the safety instructions located in the *Product Information Guide*.

If the message is not listed, see the documentation for the operating system or the program that was running when the message appeared.

A FILENAME CANNOT CONTAIN ANY OF THE FOLLOWING CHARACTERS: \ / : * ? " < > | — Do not use these characters in filenames.

A REQUIRED .DLL FILE WAS NOT FOUND — The program that you are trying to open is missing an essential file. To remove and then reinstall the program:

- 1 Click the **Start** button, click **Control Panel**, and then click **Add or Remove Programs**.
- 2 Select the program you want to remove.
- 3 Click the **Change or Remove Program** icon.
- 4 See the program documentation for installation instructions.

drive letter:\ IS NOT ACCESSIBLE. THE DEVICE IS NOT READY — The drive cannot read the disk. Insert a disk into the drive and try again.

INSERT BOOTABLE MEDIA — Insert a bootable floppy disk or CD.

NON-SYSTEM DISK ERROR — Remove the floppy disk from the drive and restart your computer.

NOT ENOUGH MEMORY OR RESOURCES. CLOSE SOME PROGRAMS AND TRY AGAIN — Close all windows and open the program that you want to use. In some cases, you might have to restart your computer to restore computer resources. If so, run the program that you want to use first.

OPERATING SYSTEM NOT FOUND — Contact Dell (see page 123).

IEEE 1394 Device Problems



CAUTION: Before you begin any of the procedures in this section, follow the safety instructions located in the *Product Information Guide*.

ENSURE THAT THE CABLE FOR THE IEEE 1394 DEVICE IS PROPERLY INSERTED INTO THE DEVICE AND INTO THE CONNECTOR ON THE COMPUTER

ENSURE THAT THE IEEE 1394 DEVICE IS RECOGNIZED BY WINDOWS —

- 1 Click the **Start** button and click **Control Panel**.
 - 2 Click **Printers and Other Hardware**.
- If your IEEE 1394 device is listed, Windows recognizes the device.

IF YOU HAVE PROBLEMS WITH A DELL IEEE 1394 DEVICE — Contact Dell (see page 123).

IF YOU HAVE PROBLEMS WITH A NON-DELL IEEE 1394 DEVICE — Contact the manufacturer of the IEEE 1394 device.

Keyboard Problems



CAUTION: Before you begin any of the procedures in this section, follow the safety instructions located in the *Product Information Guide*.

CHECK THE KEYBOARD CABLE —

- Ensure that the keyboard cable is firmly connected to the computer.
- Shut down the computer (see page 59), reconnect the keyboard cable as shown on the setup diagram for your computer, and then restart the computer.
- Check the cable connector for bent or broken pins and for damaged or frayed cables. Straighten bent pins.
- Remove keyboard extension cables and connect the keyboard directly to the computer.

TEST THE KEYBOARD — Connect a properly working keyboard to the computer, and try using the keyboard.

RUN THE HARDWARE TROUBLESHOOTER — See page 58.

Lockups and Software Problems



CAUTION: Before you begin any of the procedures in this section, follow the safety instructions located in the *Product Information Guide*.

The computer does not start up

CHECK THE DIAGNOSTIC LIGHTS — See page 49.

ENSURE THAT THE POWER CABLE IS FIRMLY CONNECTED TO THE COMPUTER AND TO THE ELECTRICAL OUTLET

The computer stops responding

 **NOTICE:** You might lose data if you are unable to perform an operating system shutdown.

TURN THE COMPUTER OFF — If you are unable to get a response by pressing a key on your keyboard or moving your mouse, press and hold the power button for at least 8 to 10 seconds until the computer turns off. Then restart your computer.

A program stops responding

END THE PROGRAM —

- 1 Press <Ctrl><Shift><Esc> simultaneously.
- 2 Click Applications.
- 3 Click the program that is no longer responding.
- 4 Click End Task.

A program crashes repeatedly

 **NOTE:** Software usually includes installation instructions in its documentation or on a floppy disk or CD.

CHECK THE SOFTWARE DOCUMENTATION — If necessary, uninstall and then reinstall the program.

A program is designed for an earlier Windows operating system

RUN THE PROGRAM COMPATIBILITY WIZARD —

The Program Compatibility Wizard configures a program so it runs in an environment similar to non-Windows XP operating system environments.

- 1 Click the Start button, point to All Programs→Accessories, and then click Program Compatibility Wizard.
- 2 In the welcome screen, click Next.
- 3 Follow the instructions on the screen.

A solid blue screen appears

TURN THE COMPUTER OFF — If you are unable to get a response by pressing a key on your keyboard or moving your mouse, press and hold the power button for at least 8 to 10 seconds until the computer turns off. Then restart your computer.

Other software problems

CHECK THE SOFTWARE DOCUMENTATION OR CONTACT THE SOFTWARE MANUFACTURER FOR TROUBLESHOOTING INFORMATION —

- Ensure that the program is compatible with the operating system installed on your computer.
- Ensure that your computer meets the minimum hardware requirements needed to run the software. See the software documentation for information.
- Ensure that the program is installed and configured properly.
- Verify that the device drivers do not conflict with the program.
- If necessary, uninstall and then reinstall the program.

BACK UP YOUR FILES IMMEDIATELY

USE A VIRUS-SCANNING PROGRAM TO CHECK THE HARD DRIVE, FLOPPY DISKS, OR CDS

SAVE AND CLOSE ANY OPEN FILES OR PROGRAMS AND SHUT DOWN YOUR COMPUTER THROUGH THE START MENU

Memory Problems



CAUTION: Before you begin any of the procedures in this section, follow the safety instructions located in the *Product Information Guide*.

IF YOU RECEIVE AN INSUFFICIENT MEMORY MESSAGE —

- Save and close any open files and exit any open programs you are not using to see if that resolves the problem.
- See the software documentation for minimum memory requirements. If necessary, install additional memory (see page 73).
- Reseat the memory modules (see page 72) to ensure that your computer is successfully communicating with the memory.
- Run the Dell Diagnostics (see page 52).

IF YOU EXPERIENCE OTHER MEMORY PROBLEMS —

- Reseat the memory modules (see page 73) to ensure that your computer is successfully communicating with the memory.
- Ensure that you are following the memory installation guidelines (see page 73).
- Your computer supports DDR2 memory. For more information about the type of memory supported by your computer, see "Memory" on page 107.
- Run the Dell Diagnostics (see page 52).

Mouse Problems



CAUTION: Before you begin any of the procedures in this section, follow the safety instructions located in the *Product Information Guide*.

CLEAN THE MOUSE — See page 119 for instructions on cleaning the mouse.

CHECK THE MOUSE CABLE —

- 1 Check the cable connector for bent or broken pins and for damaged or frayed cables. Straighten bent pins.
- 2 Remove mouse extension cables, if used, and connect the mouse directly to the computer.
- 3 Shut down the computer (see page 59), reconnect the mouse cable as shown on the setup diagram for your computer, and then restart the computer.

RESTART THE COMPUTER —

- 1 Simultaneously press <Ctrl><Esc> to display the **Start** menu.
- 2 Type **u**, press the keyboard arrow keys to highlight **Shut down** or **Turn Off**, and then press <Enter>.
- 3 After the computer turns off, reconnect the mouse cable as shown on the on the setup diagram for your computer.
- 4 Start the computer.

TEST THE MOUSE — Connect a properly working mouse to the computer, and try using the mouse.

CHECK THE MOUSE SETTINGS —

- 1 Click the **Start** button, click **Control Panel**, and then click **Printers and Other Hardware**.
- 2 Click **Mouse**.
- 3 Try adjusting the settings.

REINSTALL THE MOUSE DRIVER — See page 55.

RUN THE HARDWARE TROUBLESHOOTER — See page 58.

Network Problems



CAUTION: Before you begin any of the procedures in this section, follow the safety instructions located in the *Product Information Guide*.

CHECK THE NETWORK CABLE CONNECTOR — Ensure that the network cable is firmly inserted into both the network connector on the back of the computer and the network jack.

CHECK THE NETWORK LIGHTS ON THE BACK OF THE COMPUTER — If the link integrity light is off, that indicates no network communication exists. Replace the network cable. For a description of network lights, see "Controls and Lights" on page 110.

RESTART THE COMPUTER AND LOG ON TO THE NETWORK AGAIN

CHECK YOUR NETWORK SETTINGS — Contact your network administrator or the person who set up your network to verify that your network settings are correct and that the network is functioning.

RUN THE HARDWARE TROUBLESHOOTER — See page 58.

Power Problems



CAUTION: Before you begin any of the procedures in this section, follow the safety instructions located in the *Product Information Guide*.

IF THE POWER LIGHT IS GREEN AND THE COMPUTER IS NOT RESPONDING — See "Diagnostic Lights" on page 49.

IF THE POWER LIGHT IS BLINKING GREEN — The computer is in standby mode. Press a key on the keyboard, move the mouse, or press the power button to resume normal operation.

IF THE POWER LIGHT IS OFF — The computer is either turned off or is not receiving power.

- Reseat the power cable into both the power connector on the back of the computer and the electrical outlet.
- If the computer is plugged into a power strip, ensure that the power strip is plugged into an electrical outlet and that the power strip is turned on. Also bypass power protection devices, power strips, and power extension cables to verify that the computer turns on properly.
- Ensure that the electrical outlet is working by testing it with another device, such as a lamp.
- Ensure that the main power cable and front panel cable are securely connected to the system board (see page 71).

IF THE POWER LIGHT IS STEADY AMBER — A device might be malfunctioning or incorrectly installed.

- Remove and then reinstall the memory modules (see page 73).
- Remove and then reinstall any cards (see page 76).
- Remove and then reinstall the graphics card, if applicable (see page 81).

IF THE POWER LIGHT IS BLINKING AMBER — The computer is receiving electrical power, but an internal power problem might exist.

Ensure that the voltage selection switch is set to match the AC power at your location (if applicable).

Ensure that the processor power cable is securely connected to the system board (see page 71).

ELIMINATE INTERFERENCE — Some possible causes of interference are:

- Power, keyboard, and mouse extension cables
- Too many devices on a power strip
- Multiple power strips connected to the same electrical outlet

Printer Problems



CAUTION: Before you begin any of the procedures in this section, follow the safety instructions located in the *Product Information Guide*.



NOTE: If you need technical assistance for your printer, contact the printer's manufacturer.

CHECK THE PRINTER DOCUMENTATION — See the printer documentation for setup and troubleshooting information.

ENSURE THAT THE PRINTER IS TURNED ON

CHECK THE PRINTER CABLE CONNECTIONS —

- See the printer documentation for cable connection information.
- Ensure that the printer cables are securely connected to the printer and the computer (see page 11).

TEST THE ELECTRICAL OUTLET — Ensure that the electrical outlet is working by testing it with another device, such as a lamp.

VERIFY THAT THE PRINTER IS RECOGNIZED BY WINDOWS —

- 1 Click the **Start** button, click **Control Panel**, and then click **Printers and Other Hardware**.
- 2 Click **View installed printers or fax printers**.
If the printer is listed, right-click the printer icon.
- 3 Click **Properties** and click the **Ports** tab. For a parallel printer, ensure that the **Print to the following port(s)**: setting is **LPT1 (Printer Port)**. For a USB printer, ensure that the **Print to the following port(s)**: setting is **USB**.

REINSTALL THE PRINTER DRIVER — See the printer documentation for instructions.

Scanner Problems



CAUTION: Before you begin any of the procedures in this section, follow the safety instructions located in the *Product Information Guide*.



NOTE: If you need technical assistance for your scanner, contact the scanner's manufacturer.

CHECK THE SCANNER DOCUMENTATION — See the scanner documentation for setup and troubleshooting information.

UNLOCK THE SCANNER — Ensure that your scanner is unlocked if it has a locking tab or button.

RESTART THE COMPUTER AND TRY THE SCANNER AGAIN**CHECK THE CABLE CONNECTIONS —**

- See the scanner documentation for cable connection information.
- Ensure that the scanner cables are securely connected to the scanner and the computer.

VERIFY THAT THE SCANNER IS RECOGNIZED BY MICROSOFT WINDOWS —

1 Click the Start button, click Control Panel, and then click Printers and Other Hardware.

2 Click Scanners and Cameras.

If your scanner is listed, Windows recognizes the scanner.

REINSTALL THE SCANNER DRIVER — See the scanner documentation for instructions.

Sound and Speaker Problems



CAUTION: Before you begin any of the procedures in this section, follow the safety instructions located in the *Product Information Guide*.

No sound from speakers



NOTE: The volume control in some MP3 players overrides the Windows volume setting. If you have been listening to MP3 songs, ensure that you did not turn the player volume down or off.

CHECK THE SPEAKER CABLE CONNECTIONS — Ensure that the speakers are connected as shown on the setup diagram supplied with the speakers. If you purchased a sound card, ensure that the speakers are connected to the card.

ENSURE THAT THE SUBWOOFER AND THE SPEAKERS ARE TURNED ON — See the setup diagram supplied with the speakers. If your speakers have volume controls, adjust the volume, bass, or treble to eliminate distortion.

ADJUST THE WINDOWS VOLUME CONTROL — Click or double-click the speaker icon in the lower-right corner of your screen. Ensure that the volume is turned up and that the sound is not muted.

DISCONNECT HEADPHONES FROM THE HEADPHONE CONNECTOR — Sound from the speakers is automatically disabled when headphones are connected to the computer's front-panel headphone connector.

TEST THE ELECTRICAL OUTLET — Ensure that the electrical outlet is working by testing it with another device, such as a lamp.

ELIMINATE POSSIBLE INTERFERENCE — Turn off nearby fans, fluorescent lights, or halogen lamps to check for interference.

RUN THE SPEAKER DIAGNOSTICS**REINSTALL THE SOUND DRIVER** — See page 55.**RUN THE HARDWARE TROUBLESHOOTER** — See page 58.**No sound from headphones****CHECK THE HEADPHONE CABLE CONNECTION** — Ensure that the headphone cable is securely inserted into the headphone connector (see page 61).**ADJUST THE WINDOWS VOLUME CONTROL** — Click or double-click the speaker icon in the lower-right corner of your screen. Ensure that the volume is turned up and that the sound is not muted.**Video and Monitor Problems**

See the monitor documentation for troubleshooting procedures.

**CAUTION:** Before you begin any of the procedures in this section, follow the safety instructions located in the *Product Information Guide*.**If the screen is blank****CHECK THE MONITOR CABLE CONNECTION** —

- Ensure that the graphics cable is connected as shown on the setup diagram for your computer.
- If you are using a graphics extension cable and removing the cable solves the problem, the cable is defective.
- Swap the computer and monitor power cables to determine if the power cable is defective.
- Check the connector for bent or broken pins. (It is normal for monitor cable connectors to have missing pins.)

CHECK THE MONITOR POWER LIGHT — If the power light is off, firmly press the button to ensure that the monitor is turned on. If the power light is lit or blinking, the monitor has power. If the power light is blinking, press a key on the keyboard or move the mouse.

TEST THE ELECTRICAL OUTLET — Ensure that the electrical outlet is working by testing it with another device, such as a lamp.

CHECK THE DIAGNOSTIC LIGHTS — See page 49.

If the screen is difficult to read

CHECK THE MONITOR SETTINGS — See the monitor documentation for instructions on adjusting the contrast and brightness, demagnetizing (degaussing) the monitor, and running the monitor self-test.

MOVE THE SUBWOOFER AWAY FROM THE MONITOR — If your speaker system includes a subwoofer, ensure that the subwoofer is at least 60 cm (2 ft) away from the monitor.

MOVE THE MONITOR AWAY FROM EXTERNAL POWER SOURCES — Fans, fluorescent lights, halogen lamps, and other electrical devices can cause the screen image to appear "shaky." Turn off nearby devices to check for interference.

ROTATE THE MONITOR TO ELIMINATE SUNLIGHT GLARE AND POSSIBLE INTERFERENCE

ADJUST THE WINDOWS DISPLAY SETTINGS —



- 1** Click the **Start** button, click **Control Panel**, and then click **Appearance and Themes**.
- 2** Click **Display** and click the **Settings** tab.
- 3** Try different settings for **Screen resolution** and **Color quality**.



Advanced Troubleshooting





Diagnostic Lights

 **CAUTION:** Before you begin any of the procedures in this section, follow the safety instructions located in the *Product Information Guide*.

To help you troubleshoot a problem, your computer has four lights labeled "A," "B," "C," and "D" on the back panel (see page 63). The lights can be yellow or green. When the computer starts normally, the lights flash. After the computer starts, all four lights display solid green. If the computer malfunctions, the color and sequence of the lights identify the problem.

Light Pattern	Problem Description	Suggested Resolution
 A B C D	The computer is in a normal off condition or a possible pre-BIOS failure has occurred.	Plug the computer into a working electrical outlet and press the power button.
 A B C D	A possible processor failure has occurred.	Contact Dell (see page 123).



-  = yellow
-  = green
-  = off



Light Pattern	Problem Description	Suggested Resolution
 <p>A B C D</p>	Memory modules are detected, but a memory failure has occurred.	<ul style="list-style-type: none"> • If you have two or more memory modules installed, remove the modules, reinstall one module (see page 73), and then restart the computer. If the computer starts normally, reinstall an additional module. Continue until you have identified a faulty module or reinstalled all modules without error. • If available, install properly working memory of the same type into your computer (see page 73). • If the problem persists, contact Dell (see page 123).
 <p>A B C D</p>	A possible graphics card failure has occurred.	<ul style="list-style-type: none"> • If the computer has a graphics card, remove the card, reinstall it (see page 81), and then restart the computer. • If the problem still exists, install a graphics card that you know works and restart the computer. • If the problem persists or the computer has integrated graphics, contact Dell (see page 123).
 <p>A B C D</p>	A possible floppy or hard drive failure has occurred.	Reseat all power and data cables and restart the computer.
 <p>A B C D</p>	A possible USB failure has occurred.	Reinstall all USB devices, check cable connections, and then restart the computer.



 = yellow

 = green

 = off

Light Pattern	Problem Description	Suggested Resolution
 <p>A B C D</p>	No memory modules are detected.	<ul style="list-style-type: none"> • If you have two or more memory modules installed, remove the modules, reinstall one module (see page 73), and then restart the computer. If the computer starts normally, reinstall an additional module. Continue until you have identified a faulty module or reinstalled all modules without error. • If available, install properly working memory of the same type into your computer (see page 73). • If the problem persists, contact Dell (see page 123).
 <p>A B C D</p>	Memory modules are detected, but a memory configuration or compatibility error exists.	<ul style="list-style-type: none"> • Ensure that no special memory module/memory connector placement requirements exist (see page 73). • Verify that the memory modules that you are installing are compatible with your computer (see page 73). • If the problem persists, contact Dell (see page 123).
 <p>A B C D</p>	A possible expansion card failure has occurred.	<ol style="list-style-type: none"> 1 Determine if a conflict exists by removing a card (not a graphics card) (see page 81) and restarting the computer. 2 If the problem persists, reinstall the card that you removed, remove a different card, and then restart the computer. 3 Repeat this process for each card. If the computer starts normally, troubleshoot the last card removed from the computer for resource conflicts (see "Resolving Software and Hardware Incompatibilities" on page 58). 4 If the problem persists, contact Dell (see page 123).

-  = yellow
-  = green
-  = off

Light Pattern	Problem Description	Suggested Resolution
 A B C D	Another failure has occurred.	<ul style="list-style-type: none"> Ensure that the cables are properly connected to the system board from the hard drive, CD drive, and DVD drive (see page 99). If there is an error message on your screen identifying a problem with a device (such as the floppy drive or hard drive), check the device to make sure it is functioning properly. The operating system is attempting to boot from a device (such as the floppy drive or hard drive); check system setup (see page 111) to make sure the boot sequence is correct for the devices installed on your computer. If the problem persists, contact Dell (see page 123).
 A B C D	The computer is in a normal operating condition after POST.	None.

 = yellow

 = green

 = off

Dell Diagnostics



CAUTION: Before you begin any of the procedures in this section, follow the safety instructions located in the *Product Information Guide*.

If you experience a problem with your computer, perform the checks in "Solving Problems" on page 33 and run the Dell Diagnostics before you contact Dell for technical assistance.



NOTICE: The Dell Diagnostics works only on Dell™ computers.

- 1 Turn on (or restart) your computer.
- 2 When the DELL™ logo appears, press <F12> immediately.

If you wait too long and the operating system logo appears, continue to wait until you see the Microsoft® Windows® desktop. Then shut down your computer (see page 59) and try again.

- 3 When the boot device list appears, highlight **Boot to Utility Partition** and press <Enter>.

- 4 When the Dell Diagnostics **Main Menu** appears, select the test you want to run (see page 53).

Dell Diagnostics Main Menu

- 1 After the Dell Diagnostics loads and the **Main Menu** screen appears, click the button for the option you want.

Option	Function
Express Test	Performs a quick test of devices. This test typically takes 10 to 20 minutes and requires no interaction on your part. Run Express Test first to increase the possibility of tracing the problem quickly.
Extended Test	Performs a thorough check of devices. This test typically takes an hour or more and requires you to answer questions periodically.
Custom Test	Tests a specific device. You can customize the tests you want to run.
Symptom Tree	Lists the most common symptoms encountered and allows you to select a test based on the symptom of the problem you are having.

- 2 If a problem is encountered during a test, a message appears with an error code and a description of the problem. Write down the error code and problem description and follow the instructions on the screen.

If you cannot resolve the error condition, contact Dell (see page 123).



NOTE: The **Service Tag** for your computer is located at the top of each test screen. If you contact Dell, technical support will ask for your **Service Tag**.

- 3 If you run a test from the **Custom Test** or **Symptom Tree** option, click the applicable tab described in the following table for more information.

Tab	Function
Results	Displays the results of the test and any error conditions encountered.
Errors	Displays error conditions encountered, error codes, and the problem description.
Help	Describes the test and may indicate requirements for running the test.

Tab	Function
Configuration	Displays your hardware configuration for the selected device. The Dell Diagnostics obtains configuration information for all devices from system setup, memory, and various internal tests, and it displays the information in the device list in the left pane of the screen. The device list may not display the names of all the components installed on your computer or all devices attached to your computer.
Parameters	Allows you to customize the test by changing the test settings.

- 4 Close the test screen to return to the **Main Menu** screen. To exit the Dell Diagnostics and restart the computer, close the **Main Menu** screen.

Drivers

What Is a Driver?

A driver is a program that controls a device such as a printer, mouse, or keyboard. All devices require a driver program.

A driver acts like a translator between the device and any other programs that use the device. Each device has its own set of specialized commands that only its driver recognizes.

Dell ships your computer to you with required drivers already installed—no further installation or configuration is needed.

Many drivers, such as the keyboard driver, come with your Microsoft® Windows® operating system. You may need to install drivers if you:

- Upgrade your operating system.
- Reinstall your operating system.
- Connect or install a new device.

Identifying Drivers

If you experience a problem with any device, identify whether the driver is the source of your problem and, if necessary, update the driver.

Windows XP

- 1 Click the **Start** button and click **Control Panel**.
- 2 Under **Pick a Category**, click **Performance and Maintenance**.
- 3 Click **System**.
- 4 In the **System Properties** window, click the **Hardware** tab.

- 5 Click **Device Manager**.
- 6 Scroll down the list to see if any device has an exclamation point (a yellow circle with a [!]) on the device icon.

If an exclamation point is next to the device name, you may need to reinstall the driver or install a new driver (see page 55).

Reinstalling Drivers



NOTICE: The Dell Support website at support.dell.com provides approved drivers for Dell™ computers. If you install drivers obtained from other sources, your computer might not work correctly.

Using Windows XP Device Driver Rollback

If a problem occurs on your computer after you install or update a driver, use Windows XP Device Driver Rollback to replace the driver with the previously installed version.

- 1 Click the **Start** button and click **Control Panel**.
- 2 Under **Pick a Category**, click **Performance and Maintenance**.
- 3 Click **System**.
- 4 In the **System Properties** window, click the **Hardware** tab.
- 5 Click **Device Manager**.
- 6 Right-click the device for which the new driver was installed and click **Properties**.
- 7 Click the **Drivers** tab.
- 8 Click **Roll Back Driver**.

If Device Driver Rollback does not resolve the problem, then use System Restore to return your computer to the operating state that existed before you installed the new driver.

Manually Reinstalling Drivers

- 1 After copying the required driver files to your hard drive, click the **Start** button and right-click **My Computer**.
- 2 Click **Properties**.
- 3 Click the **Hardware** tab and click **Device Manager**.
- 4 Double-click the type of device for which you are installing the driver.
- 5 Double-click the name of the device for which you are installing the driver.
- 6 Click the **Driver** tab and click **Update Driver**.
- 7 Click **Install from a list or specific location (Advanced)** and click **Next**.
- 8 Click **Browse** and browse to the location to which you previously extracted the driver files.
- 9 When the name of the appropriate driver appears, click **Next**.
- 10 Click **Finish** and restart your computer.

Restoring Your Operating System

You can restore your operating system in the following ways:

- Microsoft Windows XP System Restore returns your computer to an earlier operating state without affecting data files.
- Dell PC Restore by Symantec restores your hard drive to the operating state it was in when you purchased the computer. Dell PC Restore permanently deletes all data on the hard drive and removes any applications installed after you received the computer.

Using Microsoft Windows XP System Restore

The Microsoft Windows XP operating system provides System Restore to allow you to return your computer to an earlier operating state (without affecting data files) if changes to the hardware, software, or other system settings have left the computer in an undesirable operating state. See the Windows Help and Support Center for information on using System Restore. To access help, see page 10.



NOTICE: Make regular backups of your data files. System Restore does not monitor your data files or recover them.



NOTE: The procedures in this document were written for the Windows default view, so they may not work if you set your Dell™ computer to the Windows Classic view.

Creating a Restore Point

- 1 Click the **Start** button and click **Help and Support**.
- 2 Click **System Restore**.
- 3 Follow the instructions on the screen.

Restoring the Computer to an Earlier Operating State

If problems occur after you install a device driver, use Device Driver Rollback (see page 55) to resolve the problem. If that is unsuccessful, then use System Restore.



NOTICE: Before you restore the computer to an earlier operating state, save and close any open files and exit any open programs. Do not alter, open, or delete any files or programs until the system restoration is complete.

- 1 Click the **Start** button, point to **All Programs**→**Accessories**→**System Tools**, and then click **System Restore**.
- 2 Ensure that **Restore my computer to an earlier time** is selected and click **Next**.
- 3 Click a calendar date to which you want to restore your computer.

The **Select a Restore Point** screen provides a calendar that allows you to see and select restore points. All calendar dates with available restore points appear in boldface type.

- 4 Select a restore point and click **Next**.

If a calendar date has only one restore point, then that restore point is automatically selected. If two or more restore points are available, click the restore point that you prefer.

- 5 Click **Next**.

The **Restoration Complete** screen appears after System Restore finishes collecting data and then the computer restarts.

- 6 After the computer restarts, click **OK**.

To change the restore point, you can either repeat the steps using a different restore point, or you can undo the restoration.

Undoing the Last System Restore



NOTICE: Before you undo the last system restore, save and close all open files and exit any open programs. Do not alter, open, or delete any files or programs until the system restoration is complete.

- 1 Click the **Start** button, point to **All Programs**→**Accessories**→**System Tools**, and then click **System Restore**.
- 2 Click **Undo my last restoration** and click **Next**.

Using Dell PC Restore by Symantec

Use Dell PC Restore by Symantec only as the last method to restore your operating system. PC Restore restores your hard drive to the operating state it was in when you purchased the computer. Any programs or files added since you received your computer—including data files—are permanently deleted from the hard drive. Data files include documents, spreadsheets, e-mail messages, digital photos, music files, and so on. If possible, back up all data before using PC Restore.



NOTICE: Using PC Restore permanently deletes all data on the hard drive and removes any applications or drivers installed after you received your computer. If possible, back up the data before using PC Restore.

To use PC Restore:

- 1 Turn on the computer.

During the boot process, a blue bar with www.dell.com appears at the top of the screen.

- 2 Immediately upon seeing the blue bar, press <Ctrl><F11>.

If you do not press <Ctrl><F11> in time, let the computer finish restarting, and then restart the computer again.



NOTICE: If you do not want to proceed with PC Restore, click **Reboot** in the following step.

- 3 On the next screen that appears, click **Restore**.

- 4 On the next screen, click **Confirm**.

The restore process takes approximately 6–10 minutes to complete.

- 5 When prompted, click **Finish** to reboot the computer.



NOTE: Do not manually shut down the computer. Click **Finish** and let the computer completely reboot.

- 6 When prompted, click **Yes**.

The computer restarts. Because the computer is restored to its original operating state, the screens that appear, such as the End User License Agreement, are the same ones that appeared the first time the computer was turned on.

- 7 Click **Next**.

The **System Restore** screen appears and the computer restarts.

- 8 After the computer restarts, click **OK**.

Enabling System Restore

If you reinstall Windows XP with less than 200 MB of free hard-disk space available, System Restore is automatically disabled. To see if System Restore is enabled:

- 1 Click the **Start** button and click **Control Panel**.
- 2 Click **Performance and Maintenance**.
- 3 Click **System**.
- 4 Click the **System Restore** tab.
- 5 Ensure that **Turn off System Restore** is unchecked.

Resolving Software and Hardware Incompatibilities

If a device is either not detected during the operating system setup or is detected but incorrectly configured, you can use the Hardware Troubleshooter to resolve the incompatibility.

To resolve incompatibilities using the Hardware Troubleshooter:

- 1 Click the **Start** button and click **Help and Support**.
- 2 Type `hardware troubleshooter` in the **Search** field and click the arrow to start the search.
- 3 Click **Hardware Troubleshooter** in the **Search Results** list.
- 4 In the **Hardware Troubleshooter** list, click **I need to resolve a hardware conflict on my computer**, and click **Next**.

Removing and Installing Parts

Before You Begin

This chapter provides procedures for removing and installing the components in your computer. Unless otherwise noted, each procedure assumes that the following conditions exist:

- You have performed the steps in "Turning Off Your Computer" (see page 59) and "Before Working Inside Your Computer" (see page 60).
- You have read the safety information in your Dell™ *Product Information Guide*.
- A component can be replaced or—if purchased separately—installed by performing the removal procedure in reverse order.

Recommended Tools

The procedures in this document may require the following tools:

- Small flat-blade screwdriver
- Phillips screwdriver
- Flash BIOS update program floppy disk or CD

Turning Off Your Computer



NOTICE: To avoid losing data, save and close any open files and exit any open programs before you turn off your computer.

- 1 Shut down the operating system:
 - a Save and close any open files, exit any open programs, click the **Start** button, and then click **Turn Off Computer**.
 - b In the **Turn off computer** window, click **Turn off**.
The computer turns off after the operating system shutdown process finishes.
- 2 Ensure that the computer and any attached devices are turned off. If your computer and attached devices did not automatically turn off when you shut down your operating system, press and hold the power button for 4 seconds.

Before Working Inside Your Computer

Use the following safety guidelines to help protect your computer from potential damage and to help ensure your own personal safety.



CAUTION: Before you begin any of the procedures in this section, follow the safety instructions located in the *Product Information Guide*.



CAUTION: Handle components and cards with care. Do not touch the components or contacts on a card. Hold a card by its edges or by its metal mounting bracket. Hold a component such as a processor by its edges, not by its pins.



NOTICE: Only a certified service technician should perform repairs on your computer. Damage due to servicing that is not authorized by Dell is not covered by your warranty.



NOTICE: When you disconnect a cable, pull on its connector or on its strain-relief loop, not on the cable itself. Some cables have a connector with locking tabs; if you are disconnecting this type of cable, press in on the locking tabs before you disconnect the cable. As you pull connectors apart, keep them evenly aligned to avoid bending any connector pins. Also, before you connect a cable, ensure that both connectors are correctly oriented and aligned.



NOTICE: To avoid damaging the computer, perform the following steps before you begin working inside the computer.

- 1 Turn off your computer (see page 59).



NOTICE: To disconnect a network cable, first unplug the cable from your computer and then unplug it from the network device.

- 2 Disconnect any telephone or telecommunication lines from the computer.

- 3 Disconnect your computer and all attached devices from their electrical outlets, and then press the power button to ground the system board.



CAUTION: To guard against electrical shock, always unplug your computer from the electrical outlet before opening the cover.

- 4 Open the computer cover (see page 69).



NOTICE: Before touching anything inside your computer, ground yourself by touching an unpainted metal surface, such as the metal at the back of the computer. While you work, periodically touch an unpainted metal surface to dissipate any static electricity that could harm internal components.

Front View

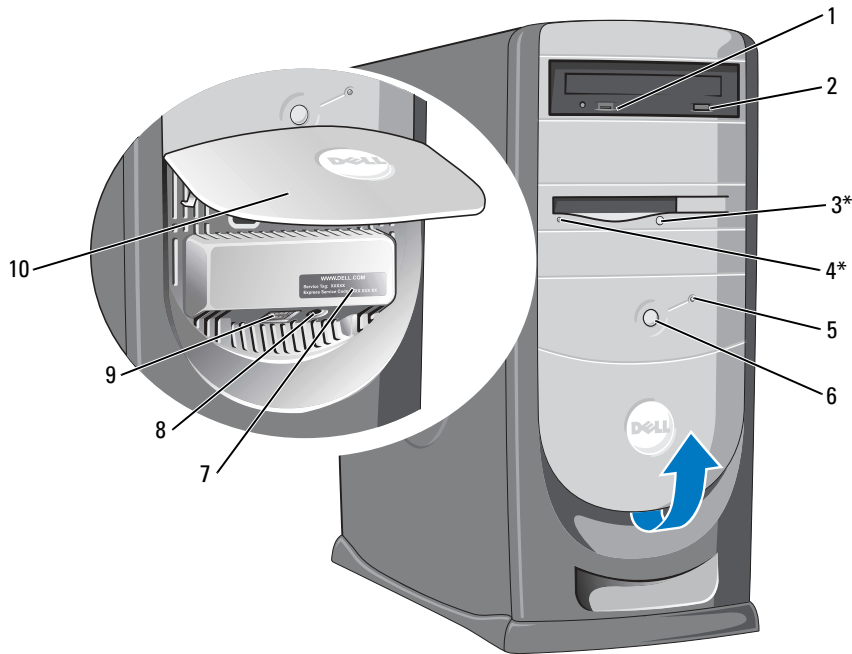

*On computers with a floppy drive.

1	CD or DVD drive-activity light	The drive light is on when the computer reads data from the CD or DVD drive.
2	CD or DVD drive eject button	Press to eject a disc from the CD or DVD drive.
3	floppy-drive eject button	Press to eject a floppy disk from the floppy drive. (On computers with an optional floppy drive.)
4	floppy-drive activity light	The floppy drive light is on when the computer reads data from or writes data to the floppy drive. Wait until this light turns off before you remove the floppy disk from the drive. (On computers with an optional floppy drive.)
5	hard-drive activity light	The hard drive light is on when the computer reads data from or writes data to the hard drive. The light might also be on when a device such as your CD player is operating.

6	power button	Press to turn on the computer.  NOTICE: To avoid losing data, do not use the power button to turn off the computer. Instead, perform an operating system shutdown.
7	Service Tag	Used to identify your computer when you access the Dell Support website or call technical support.
8	headphone connector	Use the headphone connector to attach headphones and most kinds of speakers.
9	USB 2.0 connectors (2)	Use the front USB connectors for devices that you connect occasionally, such as joysticks or cameras, or for bootable USB devices (see "System Setup" on page 111 for more information on booting to a USB device). It is recommended that you use the back USB connectors for devices that typically remain connected, such as printers and keyboards.
10	front-panel door	Open the door to use the front-panel connectors. NOTE: The front door is removable; if you remove it or accidentally knock it off its hinges, it snaps back in place. For instructions on how to reattach the door, see page 65.

Back View

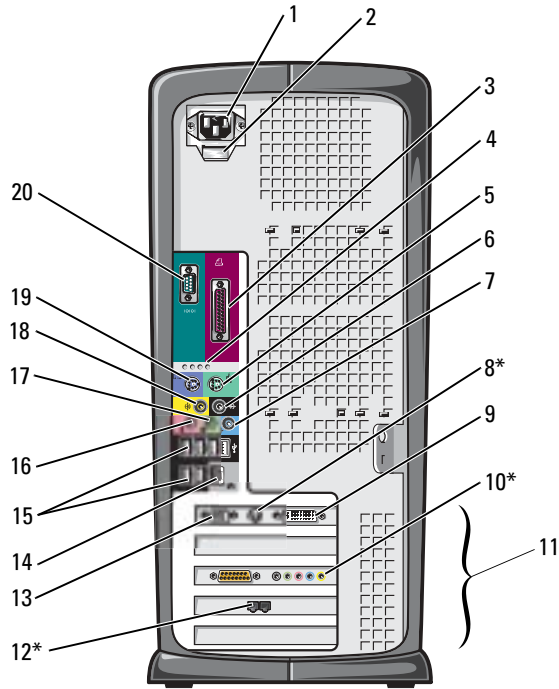

*Not present on all computers.

1	power connector	Insert the power cable.
2	voltage selection switch (may not be available on all computers)	See the safety instructions located in the <i>Product Information Guide</i> for more information.
3	parallel connector	Connect a parallel device, such as a printer, to the parallel connector. If you have a USB printer, plug it into a USB connector.
4	diagnostic lights (4)	Use the lights to help you troubleshoot a computer problem based on the diagnostic code. For more information, see "Diagnostic Lights" on page 49.
5	mouse connector	Plug a standard mouse into the green mouse connector. Turn off the computer and any attached devices before you connect a mouse to the computer. If you have a USB mouse, plug it into a USB connector.

6	surround connector	Use the black surround connector to attach multichannel-capable speakers. On computers with a sound card, use the connector on the card.
7	line-in connector	Use the blue line-in connector to attach a record/playback device such as a cassette player, CD player, or VCR. On computers with a sound card, use the connector on the card.
8	TV-OUT connector	Connects your computer to a TV. For more information, see "Connecting to the Internet" on page 13.
9	DVI video connector	If your monitor has a DVI connector, plug it into the DVI connector on the computer. If your monitor has a VGA connector, plug it into the VGA connector on the computer.
10	optional sound card connectors	<ul style="list-style-type: none"> • Line-in connector — Use the blue line-in connector to attach a record/playback device such as a cassette player, CD player, or VCR. • Microphone connector — Use the pink microphone connector to attach a personal computer microphone for voice or musical input into a sound or telephony program. • Line-out connector — Use the green line-out connector to attach headphones and most speakers with integrated amplifiers. • Surround connector — Use the black surround connector to attach multichannel-capable speakers. • Center/Low-Frequency Effects (LFE) connector — Use the yellow center/LFE connector to attach your subwoofer.
11	card slots (5)	Access connectors for any installed PCI cards (three slots) and PCI Express cards (one x16 slot and one x1 slot).
12	modem connector(s)	(Optional) If you have a modem, connect a telephone cable to either of the modem connectors. Do not connect the telephone cable to the network connector. NOTE: Not all modems have two connectors.
13	VGA video connector	If your monitor has a DVI connector, plug it into the DVI connector on the computer. If your monitor has a VGA connector, plug it into the VGA connector on the computer.

14	network adapter connector	<p>To attach your computer to a network or broadband device, connect one end of a network cable to either a network jack or your network or broadband device. Connect the other end of the network cable to the network adapter connector on your computer. A click indicates that the network cable has been securely attached.</p> <p>NOTE: Do not plug a telephone cable into the network connector.</p> <p>On computers with a network connector card, use the connector on the card.</p> <p>It is recommended that you use Category 5 wiring and connectors for your network. If you must use Category 3 wiring, force the network speed to 10 Mbps to ensure reliable operation.</p>
15	USB 2.0 connectors (6)	<p>Use the back USB connectors for devices that typically remain connected, such as printers and keyboards.</p> <p>It is recommended that you use the front USB connectors for devices that you connect occasionally, such as joysticks or cameras, or for bootable USB devices.</p>
16	microphone connector	<p>Use the pink microphone connector to attach a personal computer microphone for voice or musical input into a sound or telephony program.</p> <p>On computers with a sound card, the microphone connector is on the card.</p>
17	line-out connector	<p>Use the green line-out connector to attach headphones and most speakers with integrated amplifiers.</p> <p>On computers with a sound card, use the connector on the card.</p>
18	center/Low-Frequency Effects (LFE) connector	<p>Use the yellow center/LFE connector to attach your subwoofer.</p> <p>On computers with a sound card, use the connector on the card.</p>
19	keyboard connector	<p>If you have a standard keyboard, plug it into the purple keyboard connector. If you have a USB keyboard, plug it into a USB connector.</p>
20	serial connector	<p>Connect a serial device, such as a handheld device, to the serial port.</p>

Front-Panel Door and Hinge Arms

To prevent damage to your computer, the front-panel door is designed to "break away" if it is lifted up too far. If the front-panel door is open and it is pushed inward too hard, the hinge arms may also break away (the hinge arms are loose when they are detached).

Reattaching the Hinge Arms



CAUTION: Before you begin any of the procedures in this section, follow the safety instructions located in the *Product Information Guide*.

- 1 Follow the procedures in "Before You Begin" on page 59.
- 2 Disconnect the computer power cable from the electrical outlet.
- 3 Remove the front-panel door by gently snapping it off the two hinge arms.

- 4 Remove the front-panel insert above the door bay area by pulling the bottom of the insert with your fingers.

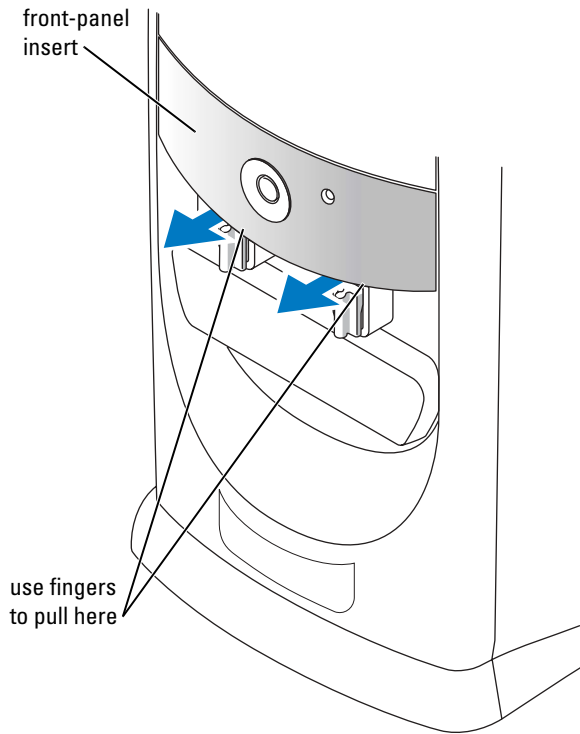

- 5 Lift both hinge arms to the horizontal position.
- 6 Use the two view slots to align the pivot bar with the two pivot-bar slots.

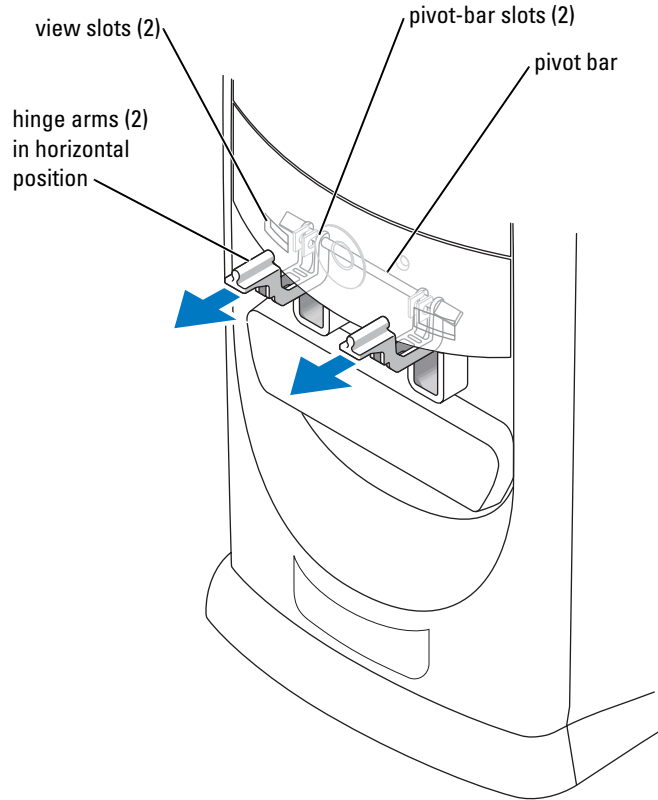

ⓘ NOTICE: Before touching anything inside your computer, ground yourself by touching an unpainted metal surface, such as the metal at the back of the computer. While you work, periodically touch an unpainted metal surface to dissipate any static electricity that could harm internal components.

7 Pull the arms toward you until they snap into position.

If the hinge arms do not snap back into position on the first attempt, slightly reposition the arms and try again.

8 After the hinge arms snap into position, lower and raise the arms two or three times to properly seat them.

9 Reattach the front-panel insert.

10 Reconnect the computer power cable to the electrical outlet.

11 Reattach the front door (see page 68).

Reattaching the Front Door

⚠ CAUTION: Before you begin any of the procedures in this section, follow the safety instructions located in the *Product Information Guide*.

- 1 Follow the procedures in "Before You Begin" on page 59.
- 2 Disconnect the computer power cable from the electrical outlet.
- 3 Lower the hinge arms to the vertical position.
- 4 Align the two clips on the inside of the front door with the two hinge arms.
- 5 Press inward on the front door until it clips to both hinge arms.

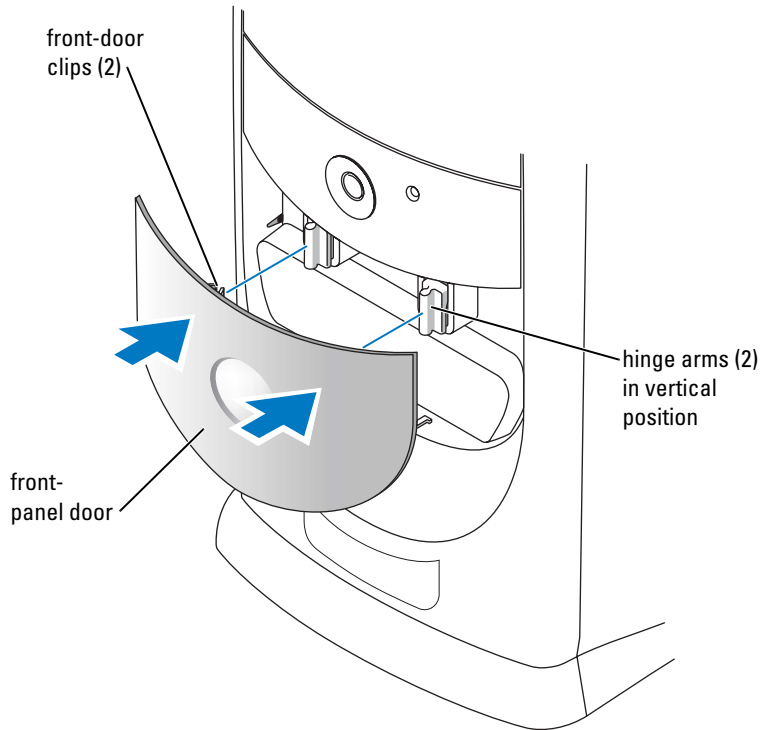

Opening the Computer Cover

 **CAUTION:** Before you begin any of the procedures in this section, follow the safety instructions located in the *Product Information Guide*.

 **CAUTION:** To guard against electrical shock, always unplug your computer from the electrical outlet before opening the cover.

1 Follow the procedures in "Before You Begin" on page 59.

 **NOTICE:** Ensure that sufficient space exists to support the open cover—at least 30 cm (1 ft) of desk top space.

2 Lay the computer on its side so that the arrow on the bottom of the computer points up.

3 Open the cover:

- a Facing the back of the computer, press the release button on the right side of the computer with one hand while pulling up on the top of the cover with the other hand.
- b Press the release button on the left side of the computer with one hand while pulling up on the top of the cover with the other hand.
- c Hold the bottom of the computer with one hand, and then pull open the cover with the other hand.

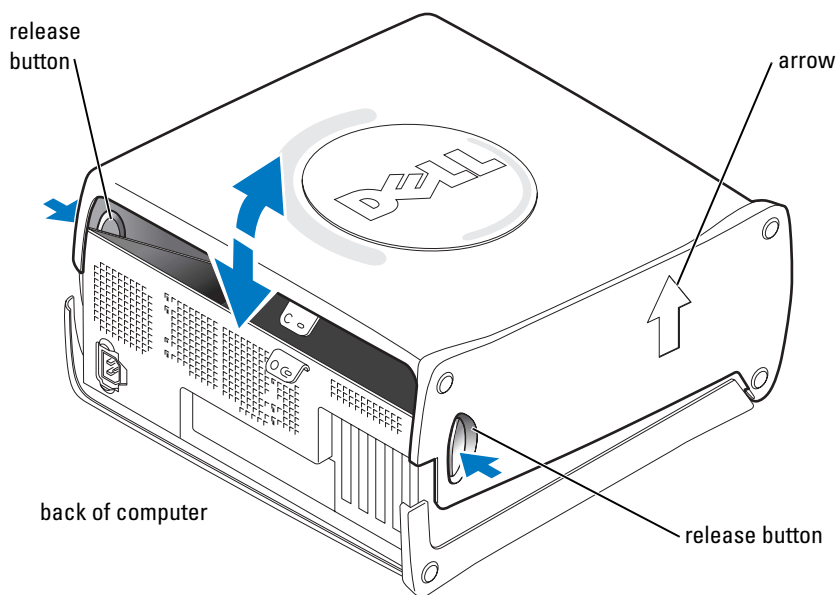

Inside Your Computer

⚠ CAUTION: Before you begin any of the procedures in this section, follow the safety instructions located in the *Product Information Guide*.

Follow the procedures in "Before You Begin" on page 59.

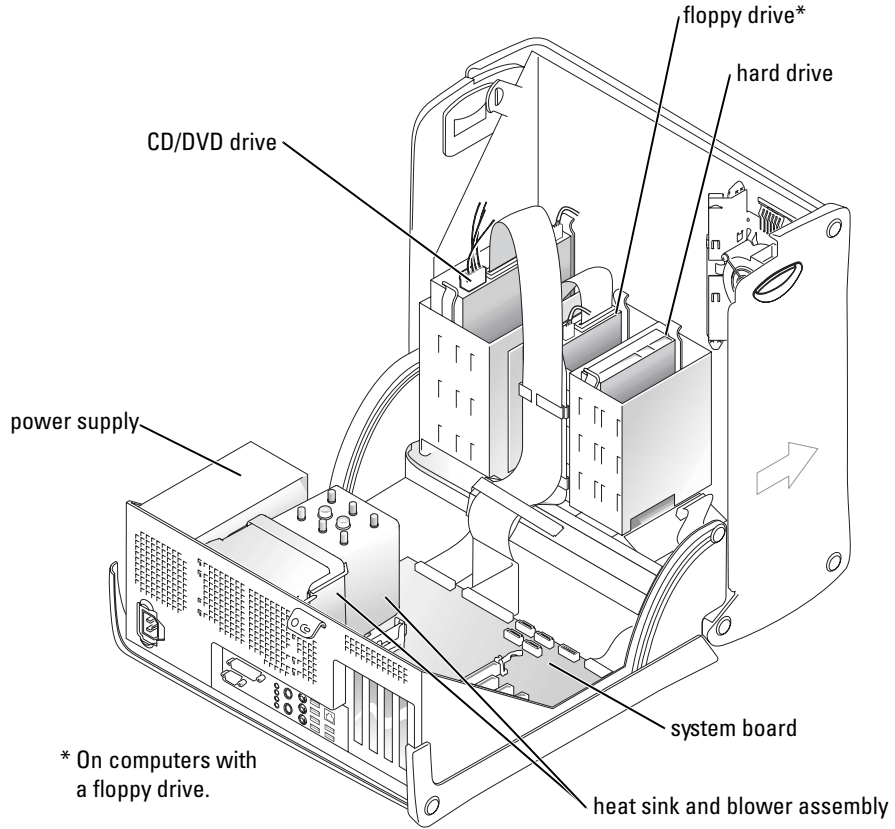

System Board Components

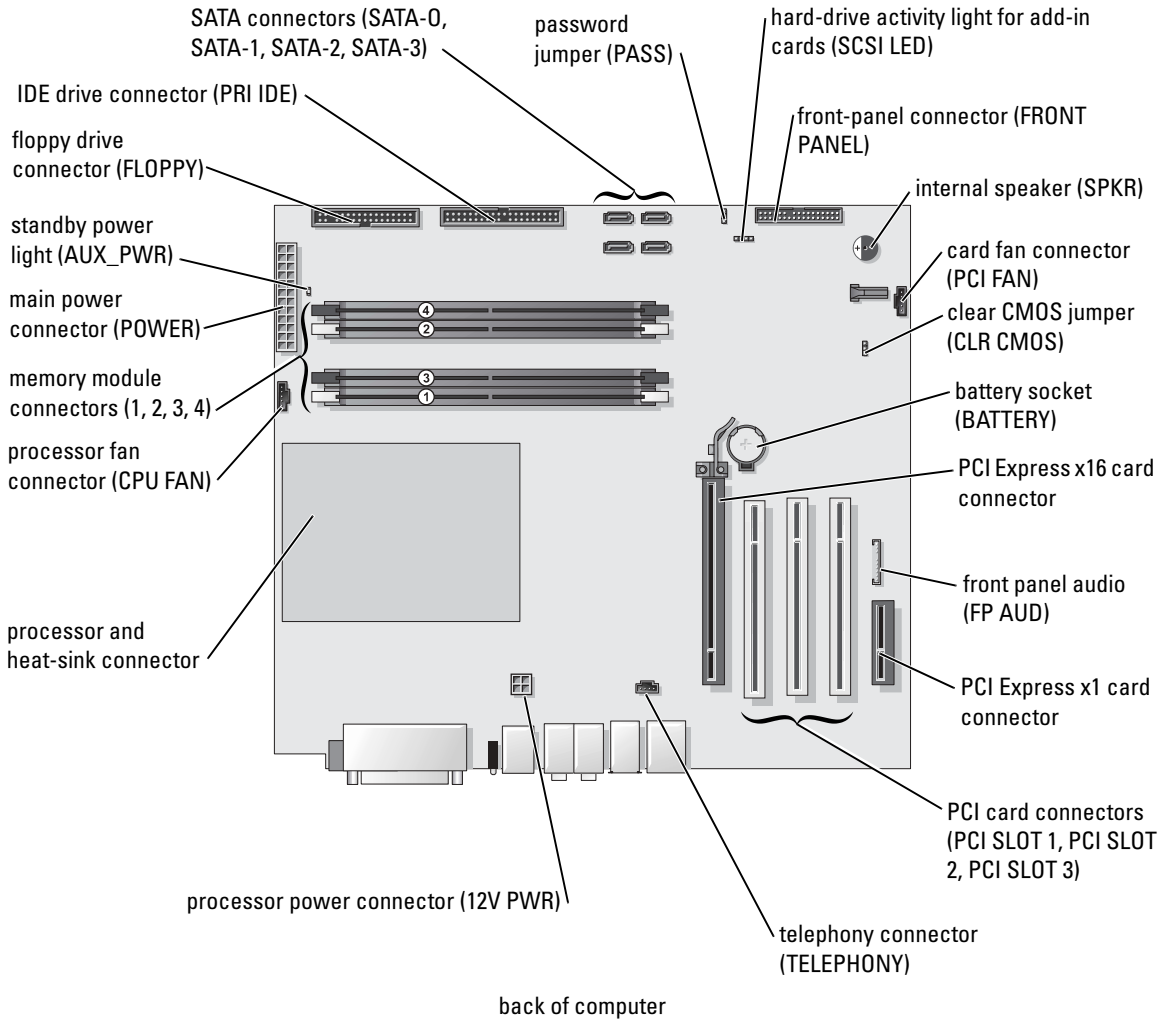

Memory

You can increase your computer memory by installing memory modules on the system board.

Your computer supports DDR2 memory. For additional information on the type of memory supported by your computer, see "Memory" on page 107.

DDR2 Memory Overview

DDR2 memory modules should be installed in *pairs of matched memory size, speed, and technology*. If the DDR2 memory modules are not installed in matched pairs, the computer will continue to operate, but with a slight reduction in performance. See the label on the upper-right corner of the module to determine the module's capacity.

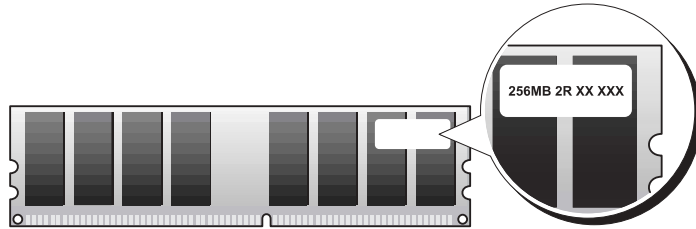

NOTE: Always install DDR2 memory modules in the order indicated on the system board.

The recommended memory configurations are:

- A pair of matched memory modules installed in DIMM connectors 1 and 2
or
- A pair of matched memory modules installed in DIMM connectors 1 and 2 and another matched pair installed in DIMM connectors 3 and 4

NOTICE: Do not install ECC memory modules.

- If you install mixed pairs of DDR2 400-MHz (PC2-3200) and DDR2 533-MHz (PC2-4200) memory, the modules function at the slowest speed installed.
- Be sure to install a single memory module in DIMM connector 1, the connector closest to the processor, before you install modules in the other connectors.

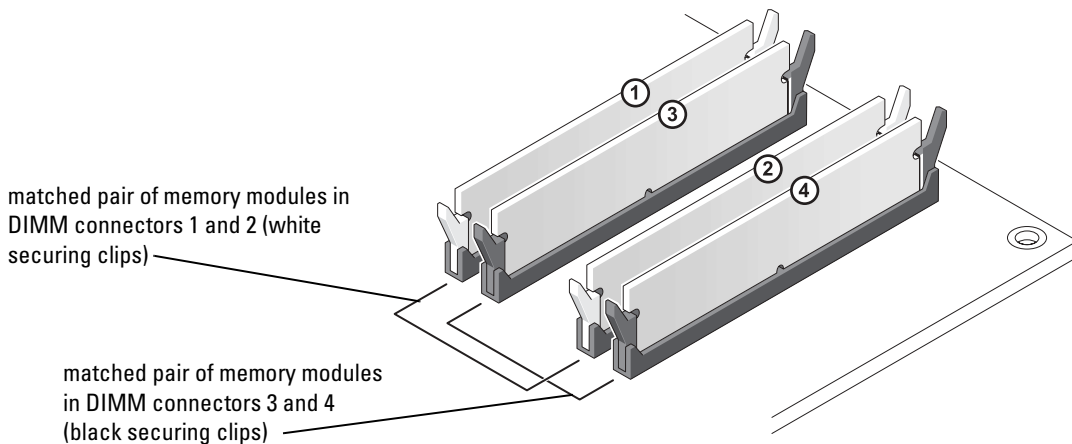

NOTE: Memory purchased from Dell is covered under your computer warranty.

NOTICE: If you remove your original memory modules from the computer during a memory upgrade, keep them separate from any new modules that you may have, even if you purchased the new modules from Dell. If possible, *do not* pair an original memory module with a new memory module. Otherwise, your computer may not start properly. You should install your original memory modules in pairs either in DIMM connectors 1 and 2 or DIMM connectors 3 and 4.

Addressing Memory With 4-GB Configurations

Your computer supports a maximum of 4 GB of memory when you use four 1-GB DIMMs. Current operating systems, such as Microsoft® Windows® XP, can only use a maximum of 4 GB of address space; however, the amount of memory available to the operating system is less than 4 GB. Certain components within the computer require address space in the 4-GB range. Any address space reserved for these components cannot be used by computer memory.

Installing Memory

CAUTION: Before you begin any of the procedures in this section, follow the safety instructions located in the *Product Information Guide*.

NOTICE: To prevent static damage to components inside your computer, discharge static electricity from your body before you touch any of your computer's electronic components. You can do so by touching an unpainted metal surface on the computer chassis.

- 1 Follow the procedures in "Before You Begin" on page 59.
- 2 Lay the computer on its side so that the system board is on the bottom of the inside of the computer.
- 3 Press out the securing clip at each end of the memory module connector.

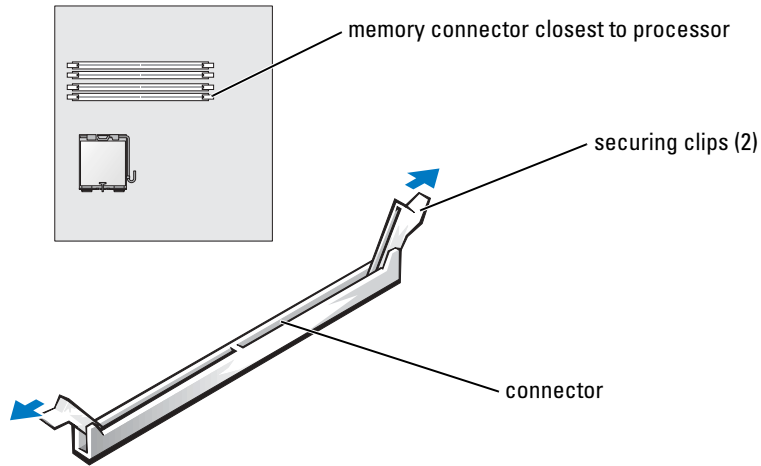

- 4 Align the notch on the bottom of the module with the crossbar in the connector.

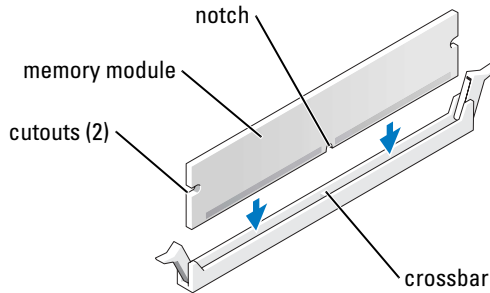

NOTICE: To avoid damage to the memory module, press the module straight down into the connector while you apply equal force to each end of the module.

- 5 Insert the module into the connector until the module snaps into position.
If you insert the module correctly, the securing clips snap into the cutouts at each end of the module.

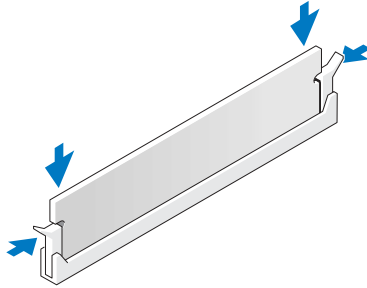

6 Close the computer cover.

NOTICE: To connect a network cable, first plug the cable into the network device and then plug it into the computer.

7 Connect your computer and devices to electrical outlets, and turn them on.

8 Right-click the **My Computer** icon and click **Properties**.

9 Click the **General** tab.

10 To verify that the memory is installed correctly, check the amount of memory (RAM) listed.

Removing Memory

CAUTION: Before you begin any of the procedures in this section, follow the safety instructions located in the *Product Information Guide*.

NOTICE: To prevent static damage to components inside your computer, discharge static electricity from your body before you touch any of your computer's electronic components. You can do so by touching an unpainted metal surface on the computer chassis.

1 Follow the procedures in "Before You Begin" on page 59.

2 Press out the securing clip at each end of the memory module connector.

3 Grasp the module and pull up.

If the module is difficult to remove, gently ease the module back and forth to remove it from the connector.

Cards

CAUTION: Before you begin any of the procedures in this section, follow the safety instructions located in the *Product Information Guide*.

NOTICE: To prevent static damage to components inside your computer, discharge static electricity from your body before you touch any of your computer's electronic components. You can do so by touching an unpainted metal surface on the computer chassis.

Your Dell™ computer provides the following slots for PCI and PCI Express cards:

- Three PCI card slots
- One PCI Express x16 card slot
- One PCI Express x1 card slot

PCI Cards

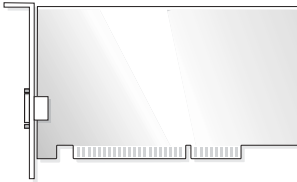

If you are installing or replacing a card, follow the procedures in the next section. If you are removing but not replacing a PCI card, see "Removing a PCI Card" on page 80.

If you are replacing a card, remove the current driver for the card from the operating system.

If you are installing or replacing a PCI Express card, see "Installing a PCI Express Card" on page 81.

Installing a PCI Card

- 1 Follow the procedures in "Before You Begin" on page 59.
- 2 Press the lever on the card retention arm and raise the retention arm.

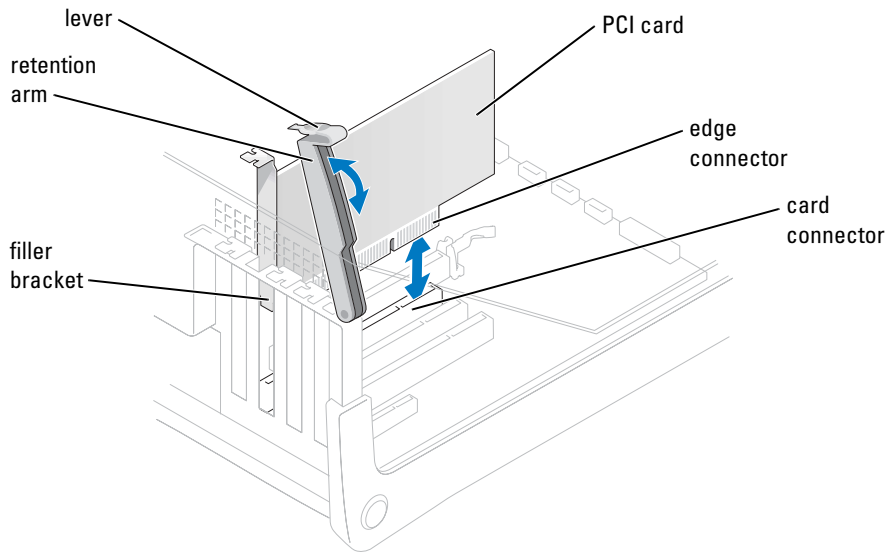

- 3 If you are installing a new card, remove the filler bracket to create a card-slot opening. Then continue with step 5.
- 4 If you are replacing a card that is already installed in the computer, remove the card. If necessary, disconnect any cables connected to the card. Grasp the card by its top corners, and ease it out of its connector.
- 5 Prepare the card for installation. See the documentation that came with the card for information on configuring the card, making internal connections, or otherwise customizing it for your computer.



CAUTION: Some network adapters automatically start the computer when they are connected to a network. To guard against electrical shock, be sure to unplug your computer from its electrical outlet before installing any cards.

- 6 Place the card in the connector and press down firmly. Ensure that the card is fully seated in the slot.

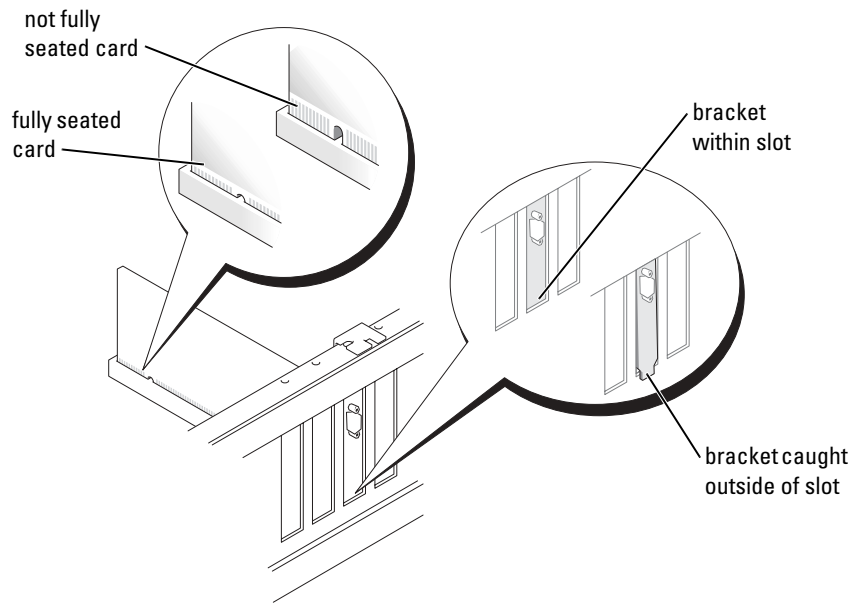

- 7** Before you lower the retention arm, ensure that:
 - The tops of all cards and filler brackets are flush with the alignment bar.
 - The notch in the top of the card or filler bracket fits around the alignment guide.
- 8** Press the retention arm into place, securing the card(s) in the computer.

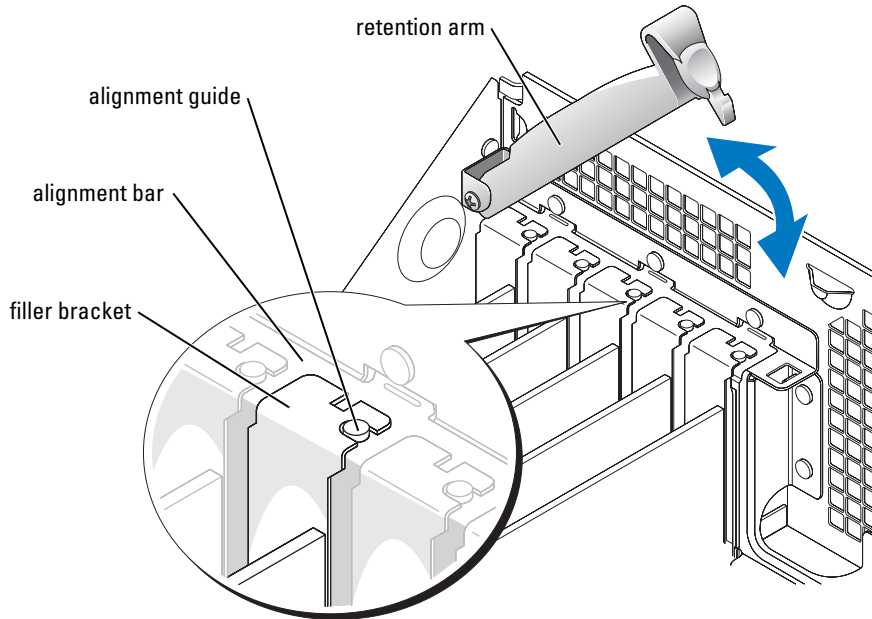

- NOTICE:** Do not route card cables over or behind the cards. Cables routed over the cards can prevent the computer cover from closing properly or cause damage to the equipment.
- 9 Connect any cables that should be attached to the card.
See the documentation for the card for information about the card's cable connections.
- NOTICE:** To connect a network cable, first plug the cable into the network device and then plug it into the computer.
- 10 Close the computer cover, reconnect the computer and devices to electrical outlets, and then turn them on.
- 11 If you installed a sound card:
- Enter system setup (see page 111), select **Audio Controller**, and then change the setting to **Off**.
 - Connect external audio devices to the sound card's connectors. Do not connect external audio devices to the microphone, speaker/headphone, or line-in connectors on the back panel.

- 12 If you installed an add-in network adapter and want to disable the integrated network adapter:
 - a Enter system setup (see page 111), select **Network Controller**, and then change the setting to **Off**.
 - b Connect the network cable to the add-in network adapter's connectors. Do not connect the network cable to the integrated connector on the back panel.
- 13 Install any drivers required for the card as described in the card documentation.

Removing a PCI Card

- 1 Follow the procedures in "Before You Begin" on page 59.
- 2 Press the lever on the card retention arm and raise the retention arm.
- 3 If necessary, disconnect any cables connected to the card.
- 4 Grasp the card by its top corners, and ease it out of its connector.
- 5 If you are removing the card permanently, install a filler bracket in the empty card-slot opening.

If you need a filler bracket, contact Dell (see page 123).



NOTE: Installing filler brackets over empty card-slot openings is necessary to maintain FCC certification of the computer. The brackets also keep dust and dirt out of your computer.

- 6 Lower the retention arm and press it into place, securing the card(s) in the computer.



NOTICE: To connect a network cable, first plug the cable into the network device and then plug it into the computer.

- 7 Close the computer cover, reconnect the computer and devices to electrical outlets, and then turn them on.
- 8 Remove the card's driver from the operating system.
- 9 If you removed a sound card:
 - a Enter system setup (see page 111), select **Audio Controller**, and then change the setting to **On**.
 - b Connect external audio devices to the audio connectors on the back panel of the computer.
- 10 If you removed an add-in network connector:
 - a Enter system setup (see page 111), select **Network Controller**, and then change the setting to **On**.
 - b Connect the network cable to the integrated connector on the back panel of the computer.

PCI Express Cards

Your computer supports one PCI Express x16 card and one PCI Express x1 card.

NOTICE: PCI Express graphics card that run higher than 75 W require an additional cooling fan. Otherwise, your card could overheat and damage your computer.

If a card fan is not present in your computer and you are installing a graphics card that runs at 75 W or higher, contact Dell (see page 123) to find out how to purchase a card fan.

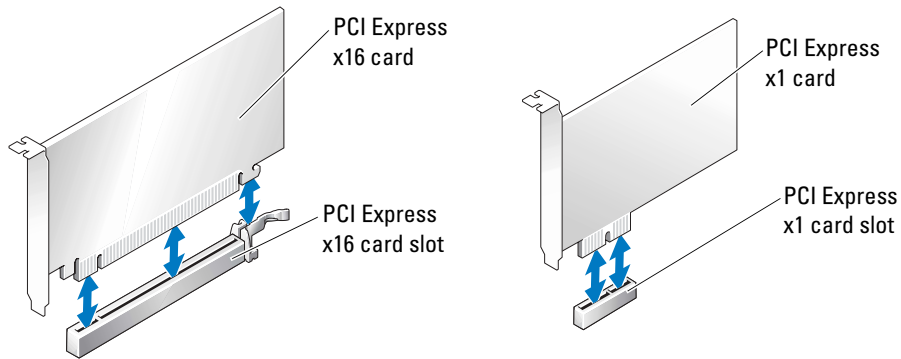

If you are installing or replacing a PCI Express card, follow the procedures in the next section. If you are removing but not replacing a card, see "Removing a PCI Express Card" on page 85.

If you are replacing a card, remove the current driver for the card from the operating system.

If you are installing or replacing a PCI card, see "Installing a PCI Card" on page 76.

Installing a PCI Express Card

- 1 Follow the procedures in "Before You Begin" on page 59.
- 2 Press the lever on the card retention arm and raise the retention arm.

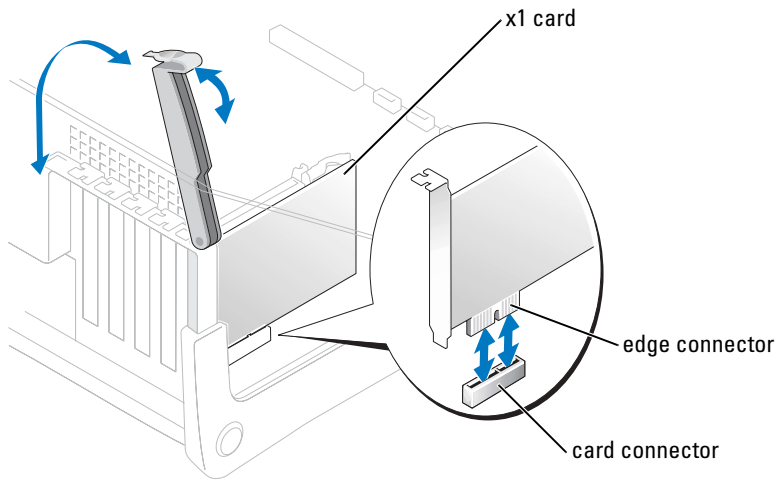
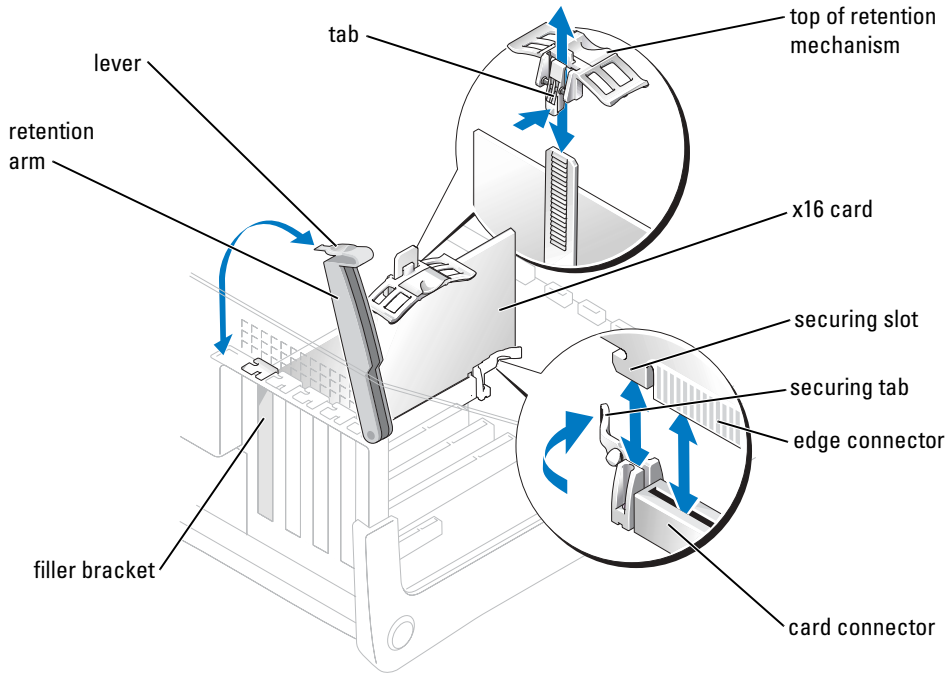

- 3 If you are installing a new card, remove the filler bracket to create a card-slot opening. Then continue with step 5.
- 4 If you are replacing a card that is already installed in the computer, remove the card.
If necessary, disconnect any cables connected to the card. If your card includes a retention mechanism, remove the top of the retention mechanism by pressing the tab and pulling up on the top. Gently pull the securing tab, grasp the card by its top corners, and then ease it out of its connector.
- 5 Prepare the card for installation.
See the documentation that came with the card for information on configuring the card, making internal connections, or otherwise customizing it for your computer.



CAUTION: Some network adapters automatically start the computer when they are connected to a network. To guard against electrical shock, be sure to unplug your computer from its electrical outlet before installing any cards.

- 6 If you are installing the card into the x16 card connector, position the card so the securing slot is aligned with the securing tab, and gently pull the securing tab.
- 7 Place the card in the connector and press down firmly. Ensure that the card is fully seated in the slot.

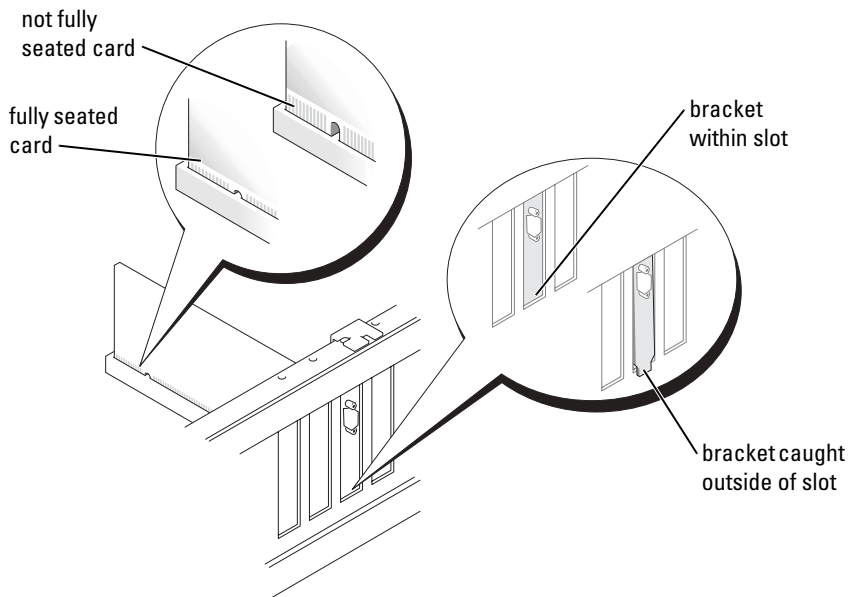

- 8 If you replaced a card that was already installed in the computer and you removed the top of the retention mechanism, you may reinstall the top.

- 9 Before you lower the retention arm, ensure that:
 - The tops of all cards and filler brackets are flush with the alignment bar.
 - The notch in the top of the card or filler bracket fits around the alignment guide.
- 10 Press the retention arm into place, securing the card(s) in the computer.

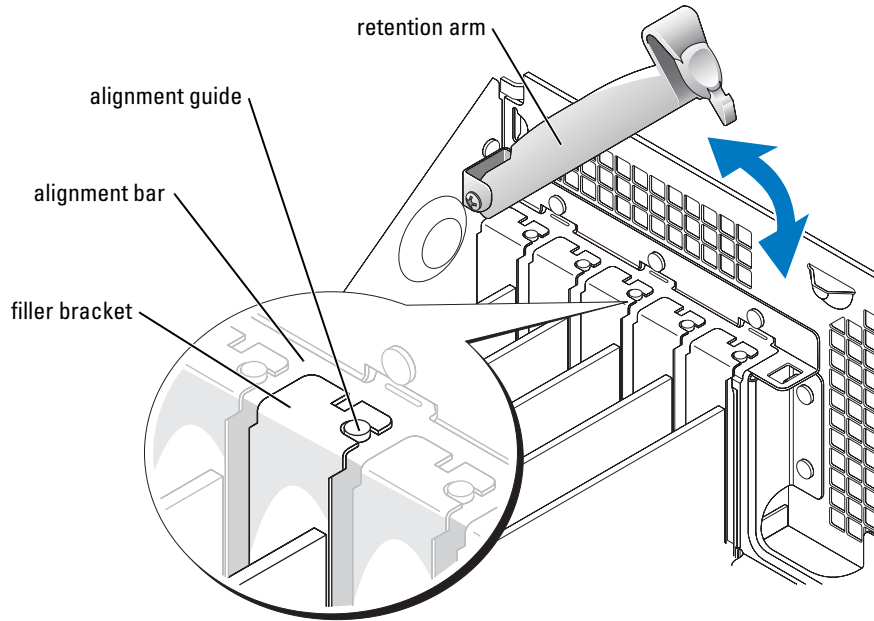

- NOTICE:** Do not route card cables over or behind the cards. Cables routed over the cards can prevent the computer cover from closing properly or cause damage to the equipment.

If a card fan is not present in your computer and you are installing a graphics card that runs higher than 75 W, contact Dell (see page 123) to find out how to purchase a card fan.

- 11 If you installed a PCI Express graphics card that runs at 75 W or higher, install the card fan (see page 86).

- 12 Connect any cables that should be attached to the card.



See the documentation that came with the card for information about the card's cable connections.

- NOTICE:** To connect a network cable, first plug the cable into the network device and then plug it into the computer.

- 13 Close the computer cover, reconnect the computer and devices to electrical outlets, and then turn them on.

- 14 If you installed a sound card:
 - a Enter system setup (see page 111), select **Audio Controller**, and then change the setting to **Off**.
 - b Connect external audio devices to the sound card's connectors. Do not connect external audio devices to the microphone, speaker/headphone, or line-in connectors on the back panel.
- 15 If you installed an add-in network adapter and want to disable the integrated network adapter:
 - a Enter system setup (see page 111), select **Network Controller**, and then change the setting to **Off**.
 - b Connect the network cable to the add-in network adapter's connectors. Do not connect the network cable to the integrated connector on the back panel.
- 16 Install any drivers required for the card as described in the card documentation.

Removing a PCI Express Card

- 1 Follow the procedures in "Before You Begin" on page 59.
 - 2 Press the lever on the card retention arm and raise the retention arm.
 - 3 If necessary, disconnect any cables connected to the card.
 - 4 If your card includes a retention mechanism, remove the top of the retention mechanism by pressing the tab and pulling up on the top.
 - 5 Gently pull back the securing tab, grasp the card by its top corners, and then ease it out of its connector.
 - 6 If you are removing the card permanently, install a filler bracket in the empty card-slot opening.
If you need a filler bracket, contact Dell (see page 123).
-  **NOTE:** Installing filler brackets over empty card-slot openings is necessary to maintain FCC certification of the computer. The brackets also keep dust and dirt out of your computer.
- 7 Lower the retention arm and press it into place, securing the card(s) in the computer.
-  **NOTICE:** To connect a network cable, first plug the cable into the network device and then plug it into the computer.
- 8 Close the computer cover, reconnect the computer and devices to electrical outlets, and then turn them on.
 - 9 Remove the card's driver from the operating system.

- 10 If you removed a sound card:
 - a Enter system setup (see page 111), select **Audio Controller**, and then change the setting to **On**.
 - b Connect external audio devices to the audio connectors on the back panel of the computer.
- 11 If you removed an add-in network connector:
 - a Enter system setup (see page 111), select **Network Controller**, and then change the setting to **On**.
 - b Connect the network cable to the integrated connector on the back panel of the computer.
- 12 Install any drivers required for the card as described in the card documentation.

Card Fan

 **NOTICE:** PCI Express graphics card that run higher than 75 W require an additional cooling fan. Otherwise, your card could overheat and damage your computer.

If a card fan is not present in your computer and you are installing a graphics card that runs at 75 W or higher, contact Dell (see page 123) to find out how to purchase a card fan.

 **CAUTION:** Before you begin any of the procedures in this section, follow the safety instructions located in the *Product Information Guide*.

 **CAUTION:** To guard against electrical shock, always unplug your computer from the electrical outlet before opening the cover.

- 1 Follow the procedures in "Before You Begin" on page 59.
- 2 If spare drive rails are installed on the inside of the computer cover, remove them by gently pulling the rails up and out.

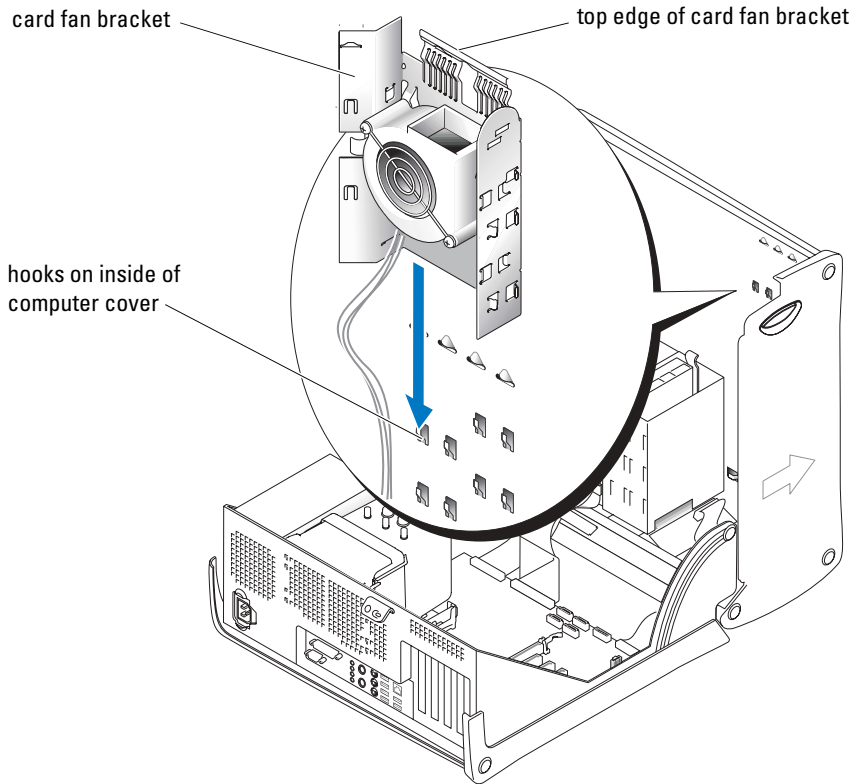

- 3** Slide the card fan bracket onto the hooks on the inside of the computer cover.

- 4 Press the top edge of the card fan bracket toward the computer cover until it clicks.

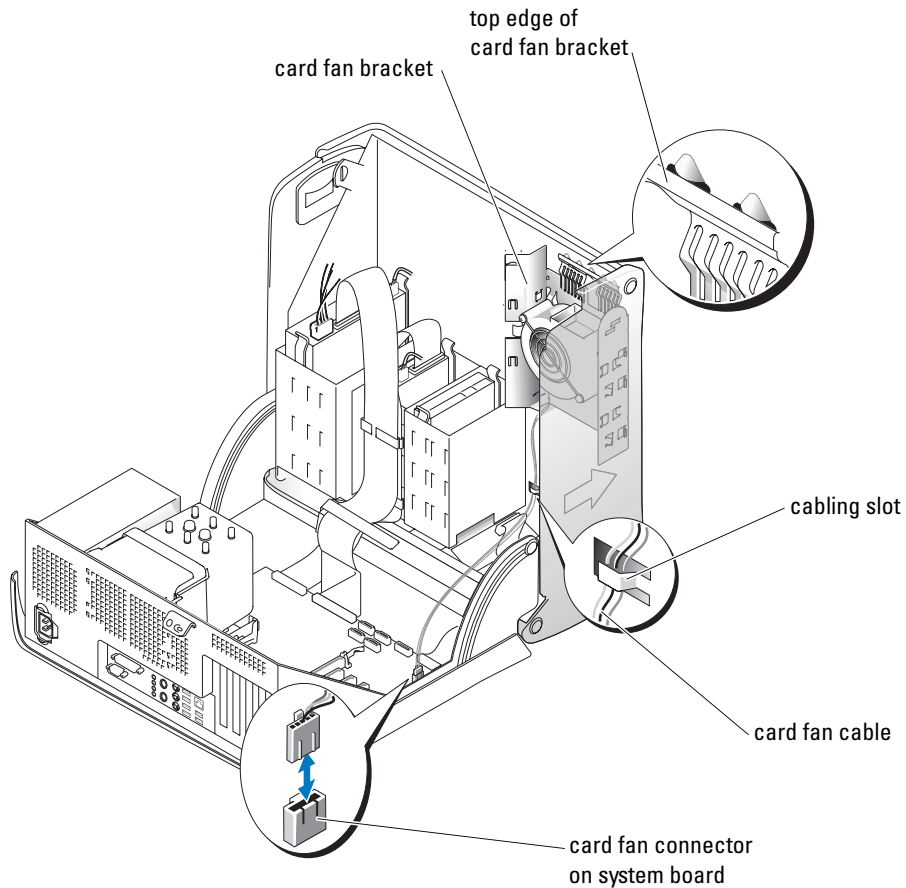

- 5 Route the card fan cable through the cabling slots.
- 6 Plug the card fan cable into the card fan connector (PCI FAN) on the system board (see page 71).
- 7 If you removed drive rails in step 2, you may attach them to the side of the card fan bracket for convenient storage.
- 8 Close the computer cover (see page 104).
- NOTICE:** To connect a network cable, first plug the cable into the network device and then plug it into the computer.
- 9 Connect your computer and devices to their electrical outlets, and then turn them on.

Drives

Your computer supports a combination of these devices:

- Up to two hard drives
- One optional floppy drive
- One optional Zip drive
- Up to two CD or DVD drives

General Installation Guidelines

Connect serial ATA hard drives to the system board connectors labeled SATA-0, SATA-1, SATA-2, or SATA-3. Connect CD/DVD drives to the connector labeled PRI IDE.

When you connect two IDE devices to a single IDE interface cable and configure them for the cable select setting, the device attached to the last connector on the interface cable is the primary or the boot device (drive 0), and the device attached to the middle connector on the interface cable is the secondary device (drive 1). See the drive documentation in your upgrade kit for information on configuring devices for the cable select setting.

Connecting Drive Cables

When you install a drive, you connect two cables—a DC power cable and a data cable—to the back of the drive and to the system board. Some drives may also have an audio connector; one end of the audio cable attaches to the drive connector and the other end attaches to the system board.

Drive Interface Connectors

Serial ATA Connector

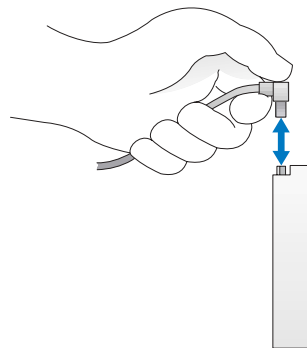
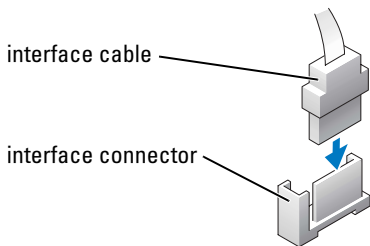

Most interface connectors are keyed for correct insertion; that is, a notch or a missing pin on one connector matches a tab or a filled-in hole on the other connector.

When you connect an IDE cable, ensure that you align the colored stripe with the pin 1 connector. When you disconnect an IDE cable, grasp the colored pull tab and pull until the connector detaches.

When you connect and disconnect a serial ATA cable, hold the cable by the connector at each end.

 **NOTE:** The system board serial ATA connector may have an attached cover or shroud.

Power Cable Connector

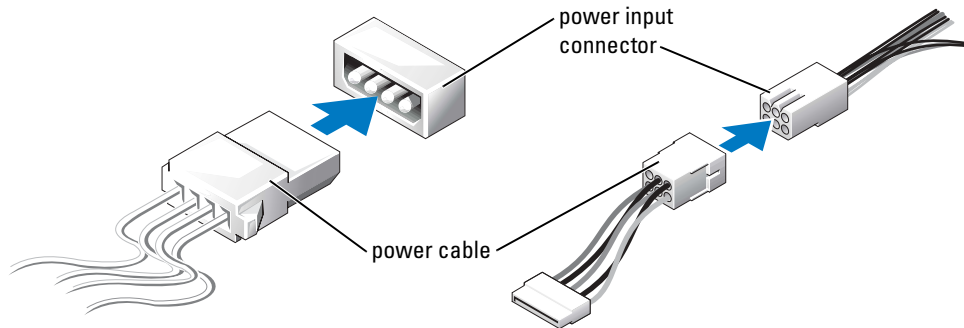

Hard Drive



CAUTION: Before you begin any of the procedures in this section, follow the safety instructions located in the *Product Information Guide*.



CAUTION: To guard against electrical shock, always unplug your computer from the electrical outlet before opening the cover.



NOTICE: To avoid damage to the drive, do not set it on a hard surface. Instead, set the drive on a surface, such as a foam pad, that will sufficiently cushion it.

- 1 If you are replacing a hard drive that contains data you want to keep, back up your files before you begin to remove the hard drive.
- 2 Follow the procedures in "Before You Begin" on page 59.

Removing a Hard Drive

- 1 Disconnect the power and data cable from the drive and from the system board.

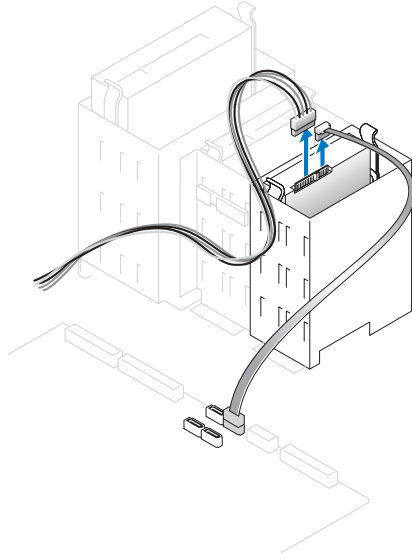

- 2 Press in on the tabs on each side of the drive and slide the drive up and out.

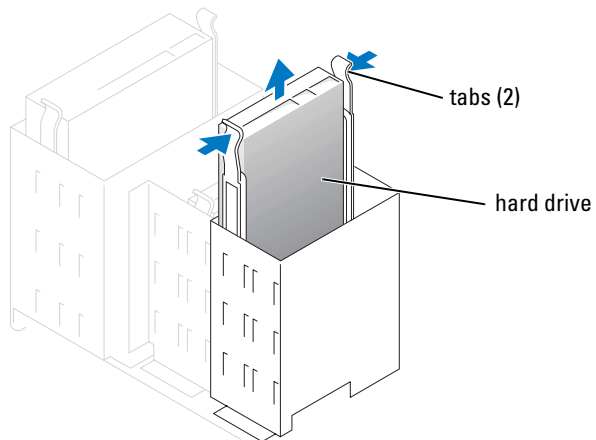

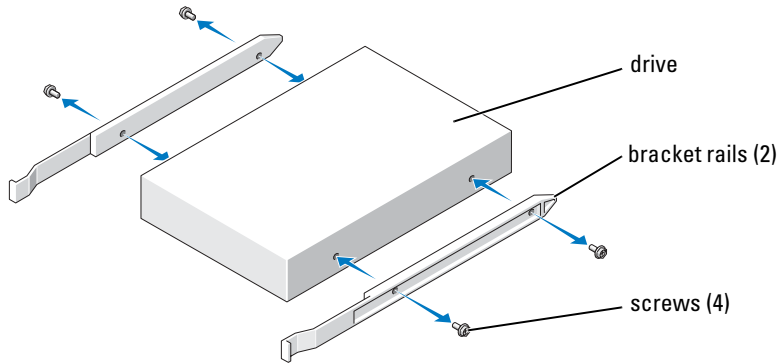

Installing a Hard Drive

- 1 Unpack the replacement hard drive, and prepare it for installation.
- 2 Check the documentation for the drive to verify that it is configured for your computer.
- 3 If your replacement hard drive does not have the bracket rails attached, remove the rails from the old drive by removing the two screws that secure each rail to the drive. Attach the bracket rails to the new drive by aligning the screw holes on the drive with the screw holes on the bracket rails and then inserting and tightening all four screws (two screws on each rail).

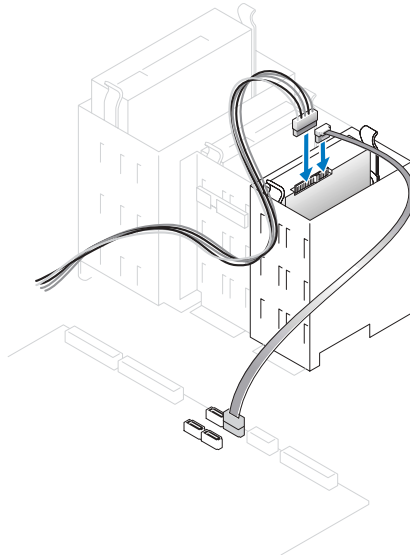

- 4 Install the hard drive into the computer by gently sliding the drive into place until you hear it securely click.
- 5 Connect the power and data cable to the drive and to the system board (see page 71).



- 6 Check all connectors to be certain that they are properly cabled and firmly seated.
- 7 Close the computer cover (see page 104).
-  **NOTICE:** To connect a network cable, first plug the cable into the network device and then plug it into the computer.
- 8 Connect your computer and devices to electrical outlets, and turn them on.
See the documentation that came with the drive for instructions on installing any software required for drive operation.
- 9 If the drive you just installed is the primary drive, insert a bootable floppy disk into drive A.
- 10 Turn on the computer.
- 11 Enter system setup (see page 111), and update the appropriate **Drive** option.
- 12 Exit system setup, and restart the computer.
- 13 Partition and logically format your drive before you proceed to the next step.
See the documentation for your operating system for instructions.
- 14 Test the hard drive by running the Dell Diagnostics (see page 52).
- 15 If the drive you just installed is the primary drive, install your operating system on the hard drive.

Adding a Second Hard Drive



CAUTION: Before you begin any of the procedures in this section, follow the safety instructions located in the *Product Information Guide*.



CAUTION: To guard against electrical shock, always unplug your computer from the electrical outlet before opening the cover.



NOTICE: To avoid damage to the drive, do not set it on a hard surface. Instead, set the drive on a surface, such as a foam pad, that will sufficiently cushion it.

- 1 Check the documentation for the drive to verify that it is configured for your computer.
- 2 Follow the procedures in "Before You Begin" on page 59.
- 3 Remove the two plastic rails from the inside of the hard-drive bay by gently pulling the rails up and out of the bay.
- 4 Attach the rails to the hard drive using the two screws attached to the rails.
Ensure that the rail tabs are positioned at the back of the hard drive.
-  **NOTICE:** Do not install any drive into the lower hard-drive bay until you have removed the green drive rails from the inside of the hard-drive bay.
- 5 Remove the first hard drive from the upper bay and install it in the lower bay:
 - a Disconnect the power and the data cable from the back of the first hard drive.
 - b Press in the two rail tabs and pull the first hard drive out of the upper bay.

- c Gently slide the first hard drive into the lower bay until you hear a click.
 - d Reconnect the power and data cable to the back of the first hard drive.
- 6 Gently slide the new hard drive into the upper bay until you hear a click.

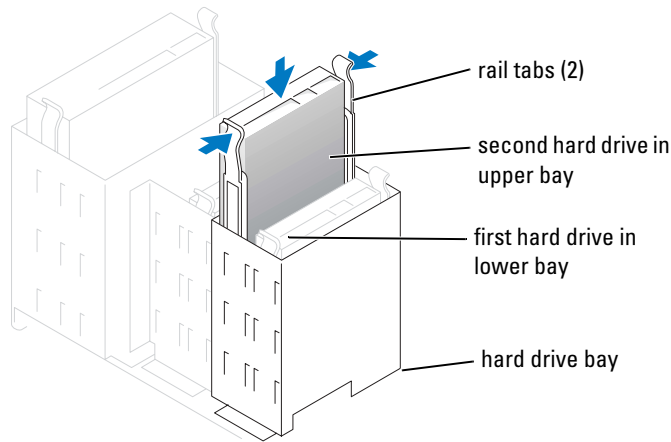

- 7 Connect a power cable to the drive.
 - 8 Connect the data cable to the drive and to the system board (see page 71).
 - 9 Close the computer cover (see page 104).
- NOTICE:** To connect a network cable, first plug the cable into the network device and then plug it into the computer.
- 10 Connect your computer and devices to their electrical outlets, and turn them on.
See the documentation that came with the drive for instructions on installing any software required for drive operation.

Front-Panel Inserts

If you are installing a new floppy or CD/DVD drive instead of replacing a drive, remove the front-panel inserts.

- 1 Open the cover to a 90-degree angle.
- 2 Locate the insert that is in front of the drive bay that you want to use.
- 3 From inside the computer, press in the release tab of the insert.

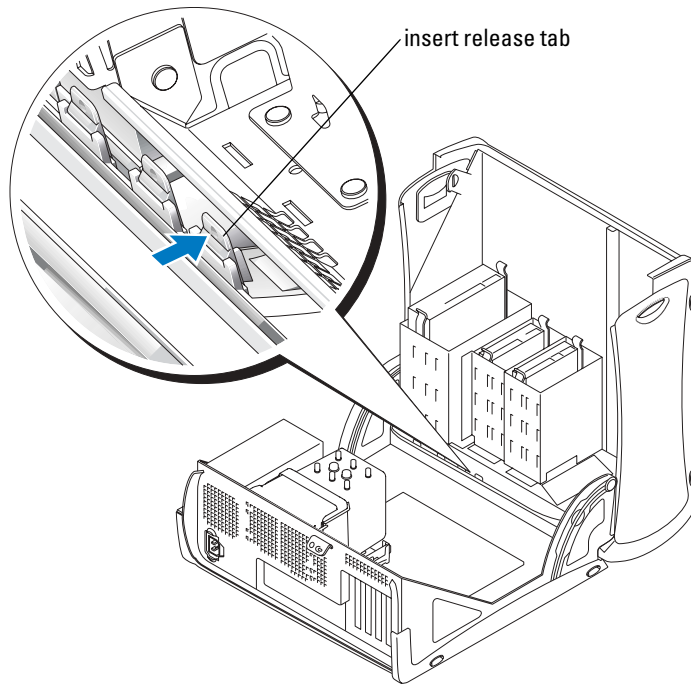

- 4 From the outside of the computer, pull the insert away from the computer's front panel.
- 5 Remove the insert from the insert frame by pressing on the four tabs.

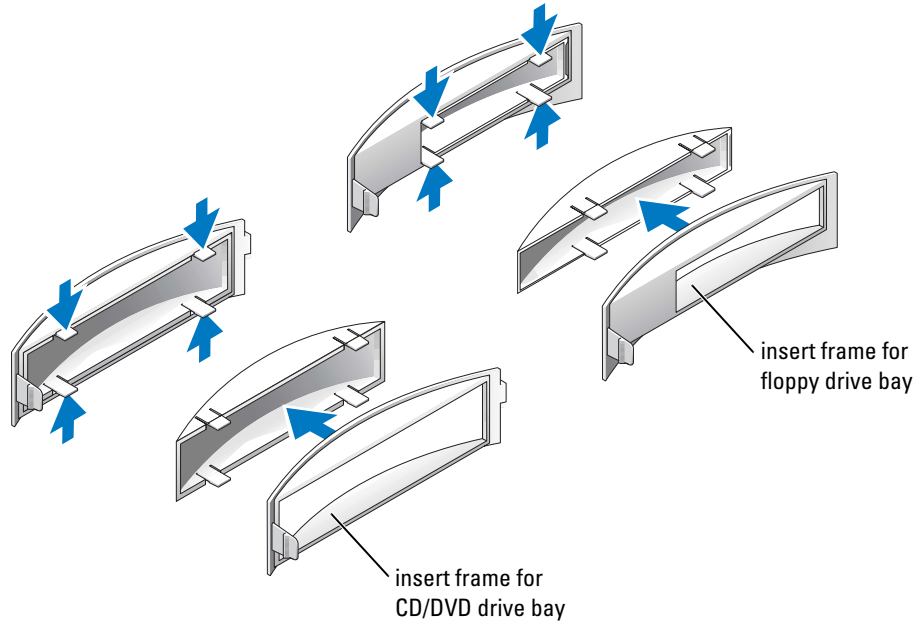

- 6** Reattach the empty insert frame over the front of the drive bay (the insert frame fits only one way):
 - a** Face the front of the computer and slip the left side of the insert in to the left side of the drive bay opening.
 - b** Slightly press the right-side insert release tab and gently push in the insert.

If you are adding a floppy drive and you purchased the drive from Dell, you received a front panel insert in your floppy drive kit. Attach this insert over the front of the drive bay.

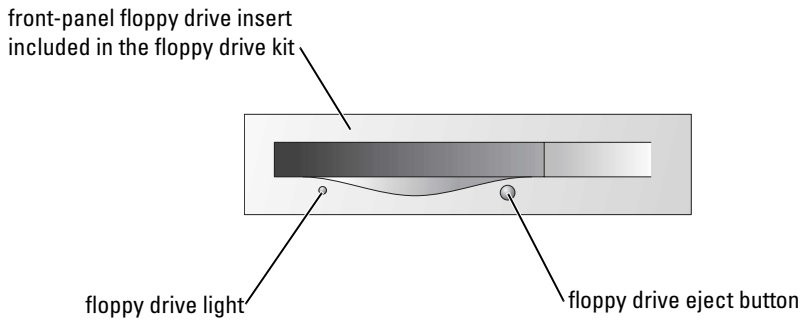

If you are adding a floppy drive that was not purchased from Dell, reattach the empty insert frame over the front of the drive bay.

Floppy Drive



CAUTION: Before you begin any of the procedures in this section, follow the safety instructions located in the *Product Information Guide*.



CAUTION: To guard against electrical shock, always unplug your computer from the electrical outlet before opening the cover.

Follow the procedures in "Before You Begin" on page 59.



NOTE: If you are adding a floppy drive, see "Installing a Floppy Drive" on page 98.

Removing a Floppy Drive

- 1 Disconnect the power and data cables from the back of the floppy drive.
- 2 Disconnect the other end of the data cable from the system board.

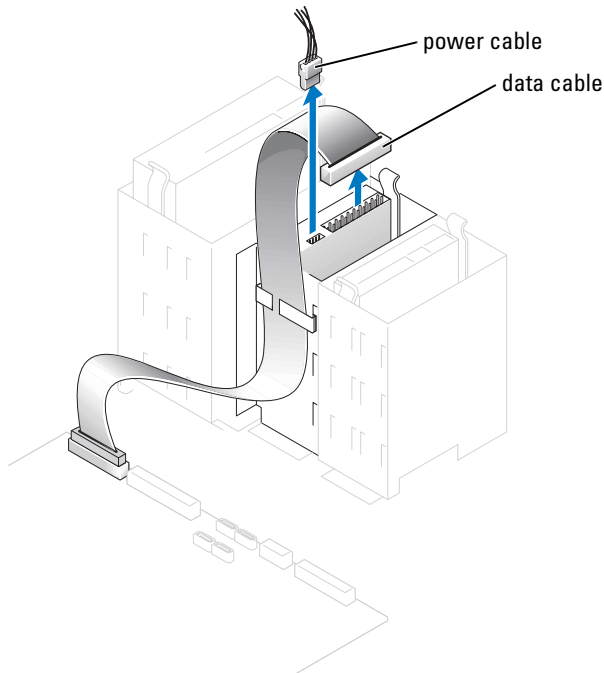

- 3 Press inward on the two tabs on the sides of the drive, slide the drive upward, and then remove it from the floppy-drive bay.

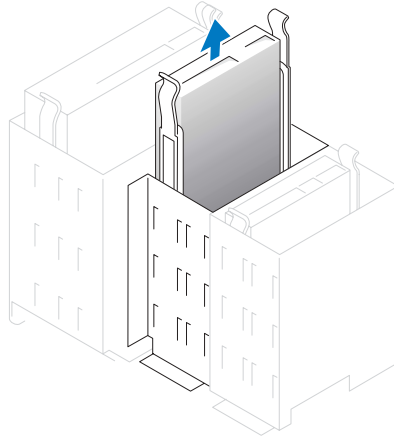

Installing a Floppy Drive

- 1 If you are replacing a drive and the new drive does not have the bracket rails attached, remove the rails from the old drive by removing the two screws that secure each rail to the drive. Attach the bracket to the new drive by aligning the screw holes on the drive with the screw holes on the bracket rails and then inserting and tightening all four screws (two screws on each rail).

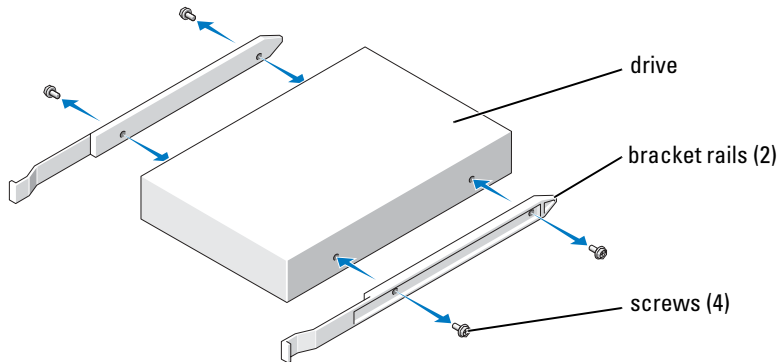

- 2 Gently slide the drive into place until the tabs securely click into position.
- 3 Attach the power and data cables to the floppy drive.
- 4 Connect the other end of the data cable to the connector labeled FLOPPY on the system board (see page 71).

- 5 If you are installing a new floppy drive rather than replacing a drive, remove the front-panel inserts (see page 94).
- 6 Check all cable connections, and fold cables out of the way to provide airflow for the fan and cooling vents.
- 7 Close the computer cover. (see page 104).
-  **NOTICE:** To connect a network cable, first plug the cable in to the network device and then plug it in to the computer.
- 8 Connect your computer and devices to their electrical outlets, and turn them on.
See the documentation that came with the drive for instructions on installing any software required for drive operation.
- 9 Enter system setup (see page 111) and select the appropriate **Diskette Drive** option.
- 10 Verify that your computer works correctly by running the Dell Diagnostics (see page 52).

CD/DVD Drive



CAUTION: Before you begin any of the procedures in this section, follow the safety instructions located in the *Product Information Guide*.



CAUTION: To guard against electrical shock, always unplug your computer from the electrical outlet before opening the cover.

Removing a CD/DVD Drive

- 1 Follow the procedures in "Before You Begin" on page 59.
- 2 Disconnect the power and data cables from the back of the drive.

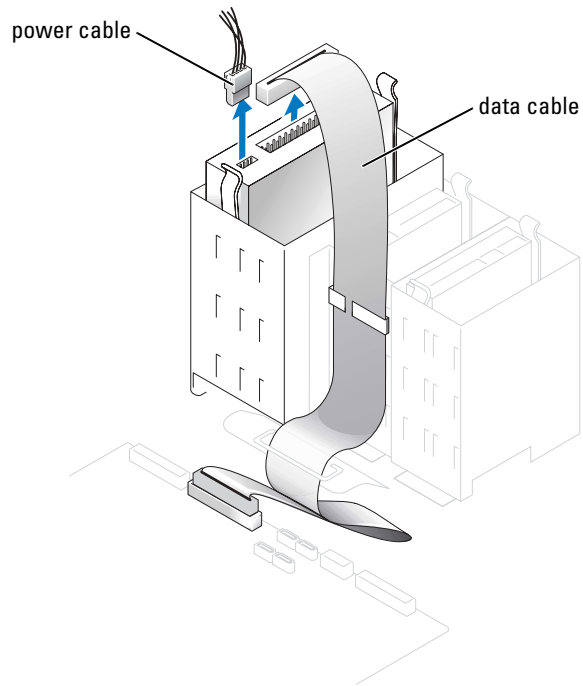

- 3 Press inward on the two tabs on the sides of the drive, and then slide the drive upward and remove it from the drive bay.

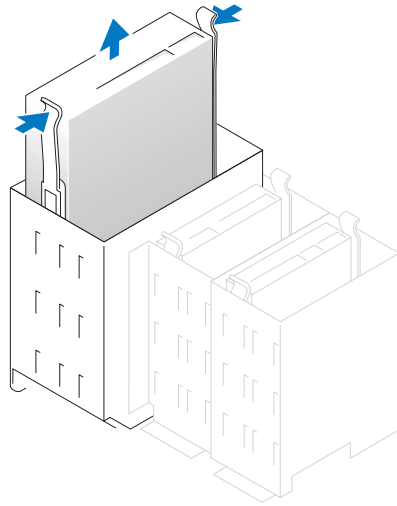

Installing a CD/DVD Drive

- 1** If you are installing a new drive, unpack the drive and prepare it for installation.
Check the documentation that accompanied the drive to verify that the drive is configured for your computer. If you are installing an IDE drive, configure the drive for the cable select setting.
- 2** Connect the new drive to the set of rails that are attached to the inside of the cover. If a set of rails is not attached inside the cover, contact Dell (see page 123).
- 3** If you are installing a replacement drive and the new drive does not have the bracket rails attached, remove the rails from the old drive by removing the two screws that secure each rail to the drive. Attach the bracket to the new drive by aligning the screw holes on the drive with the screw holes on the bracket rails and then inserting and tightening all four screws (two screws on each rail).

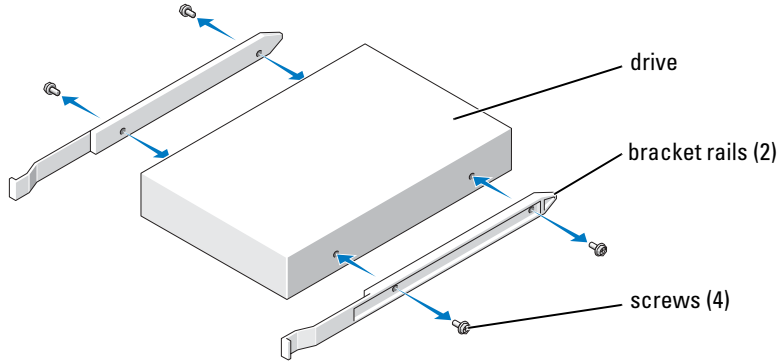

- 4 Gently slide the drive into place until the tabs securely click into position.
- 5 Connect the power and data cables to the drive.

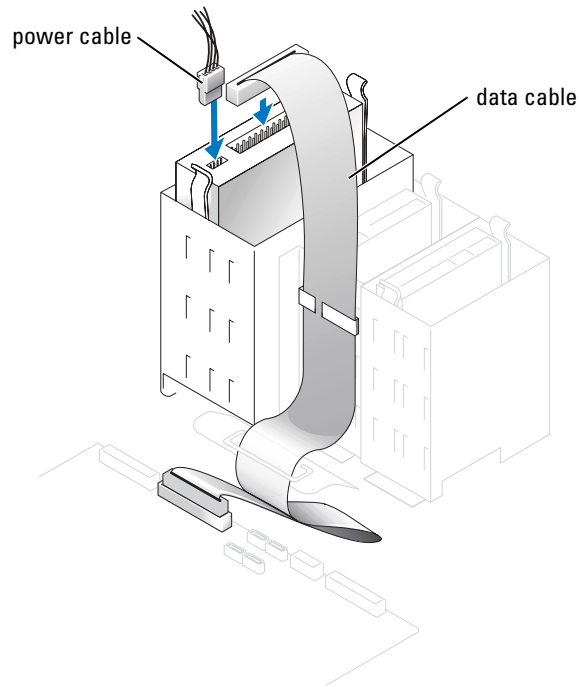

- 6 If you are installing a new CD/DVD drive rather than replacing a drive, remove the front-panel inserts (see page 94).
- 7 Check all cable connections, and fold cables out of the way to provide airflow for the fan and cooling vents.

- 8 Close the computer cover (see page 104).
-  **NOTICE:** To connect a network cable, first plug the cable in to the network device and then plug it in to the computer.
- 9 Connect your computer and devices to their electrical outlets, and turn them on.
See the documentation that came with the drive for instructions on installing any software required for drive operation.
- 10 Enter system setup (see page 111) and select the appropriate **Drive** option.
- 11 Verify that your computer works correctly by running the Dell Diagnostics (see page 52).

Battery

Replacing the Battery

 **CAUTION:** Before you begin any of the procedures in this section, follow the safety instructions located in the *Product Information Guide*.

 **NOTICE:** To prevent static damage to components inside your computer, discharge static electricity from your body before you touch any of your computer's electronic components. You can do so by touching an unpainted metal surface on the computer chassis.

A coin-cell battery maintains computer configuration, date, and time information. The battery can last several years.

If you have to repeatedly reset time and date information after turning on the computer, replace the battery.

 **CAUTION:** A new battery can explode if it is incorrectly installed. Replace the battery only with the same or equivalent type recommended by the manufacturer. Discard used batteries according to the manufacturer's instructions.

To replace the battery:

- 1 Record all the screens in system setup (see page 111) so that you can restore the correct settings in step 8.
- 2 Follow the procedures in "Before You Begin" on page 59.
- 3 Locate the battery socket (see page 71).
-  **NOTICE:** If you pry the battery out of its socket with a blunt object, be careful not to touch the system board with the object. Ensure that the object is inserted between the battery and the socket before you attempt to pry out the battery. Otherwise, you may damage the system board by prying off the socket or by breaking circuit traces on the system board.
- 4 Remove the battery by carefully prying it out of its socket with your fingers or with a blunt, nonconducting object such as a plastic screwdriver.

- 5 Insert the new battery into the socket with the side labeled "+" facing up, and snap the battery into place.

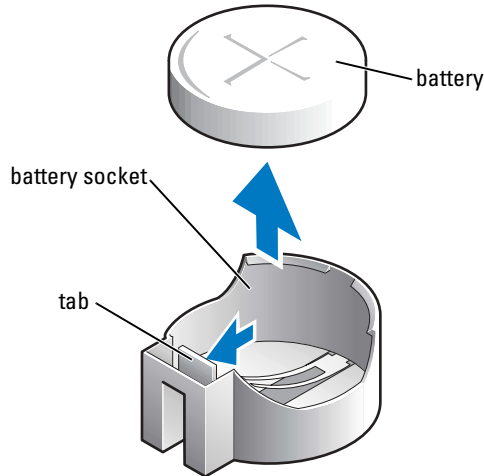

- 6 Close the computer cover (see page 104).
- ➡ **NOTICE:** To connect a network cable, first plug the cable into the network device and then plug it into the computer.
- 7 Connect your computer and devices to electrical outlets, and turn them on.
- 8 Enter system setup (see page 111) and restore the settings you recorded in step 1.
- 9 Properly dispose of the old battery. See the *Product Information Guide* for battery disposal information.

Closing the Computer Cover

⚠ CAUTION: Before you begin any of the procedures in this section, follow the safety instructions located in the *Product Information Guide*.

- 1 Ensure that all cables are connected, and fold cables out of the way.
Gently pull the power cables toward you so that they do not get caught underneath the drives.
- 2 Ensure that no tools or extra parts are left inside the computer.
- 3 Close the cover:
 - a Pivot the cover down.
 - b Press down on the right side of the cover until it closes.
 - c Press down on the left side of the cover until it closes.
 - d Ensure that both sides of the cover are locked. If not, repeat all of step 3.

 **NOTICE:** To connect a network cable, first plug the cable into the network device and then plug it into the computer.

- 4 Connect your computer and devices to electrical outlets, and turn them on.

Appendix

Specifications

Processor

Processor type	Intel® Pentium® 4 with HT Technology NOTE: Not all Pentium 4 processors support Hyper-Threading technology.
Cache	512 KB, 1 MB, or 2 MB

Memory

Type	400- and 533-MHz DDR2 unbuffered SDRAM
Memory connectors	four
Memory capacities	256 MB, 512 MB, or 1 GB, non-ECC
Minimum memory	256 MB
Maximum memory	4 GB NOTE: See "Addressing Memory With 4-GB Configurations" on page 73 to verify the amount of memory available to the operating system.
BIOS address	F0000h

Computer Information

Chipset	Intel 925X Express or Intel 925XE Express
DMA channels	eight
Interrupt levels	24
BIOS chip (NVRAM)	4-Mb
NIC	Integrated network interface capable of 10/100/1000 communication.
System clock	800- or 1066-MHz data rate (depending on your processor)

Video

Type	PCI Express
------	-------------

Audio

Type	ADI 1980 AC97 Codec NOTE: This audio type is present only on computers with integrated sound capabilities.
------	--

Expansion Bus

Bus type	PCI 2.3 PCI Express x1 and x16
Bus speed	PCI: 33 MHz PCI Express: x1 slot bidirectional speed - 500 MB/s x16 slot bidirectional speed - 8 GB/s

PCI

connectors	three
connector size	120 pins
connector data width (maximum)	32 bits

PCI Express

connector	one x1
connector size	36 pins
connector data width (maximum)	1 PCI Express lane

PCI Express

connector	one x16
connector size	164 pins
connector data width (maximum)	16 PCI Express lanes

Drives

Externally accessible:

two 3.5-inch drive bays
two 5.25-inch drive bays

Available devices

Serial ATA drive, floppy drive, Zip drive, USB memory devices, CD drive, CD-RW drive, DVD drive, DVD-RW drive, and DVD and CD-RW combo drive

Internally accessible:

two bays for 1-inch high hard drives

Connectors

External connectors:

Serial	9-pin connector; 16550C-compatible
Parallel	25-hole connector (bidirectional)
Video	15-hole connector
Network adapter	RJ45 connector
PS/2 (keyboard and mouse)	two 6-pin mini-DIN connectors
USB	two front-panel and six back-panel USB 2.0-compliant connectors
Audio	five connectors for line-in, line-out, microphone, surround, and center/Low Frequency Effects (LFE) channel; one front-panel connector for headphones

System board connectors:

Primary IDE drive	40-pin connector on PCI local bus
Serial ATA	four 7-pin connectors
Floppy drive	34-pin connector
Fan	two 5-pin connectors
PCI 2.3	120-pin connector
PCI Express x1	36-pin connector
PCI Express x16	164-pin connector
Telephony (TAPI)	4-pin connector

Controls and Lights

Power control	push button
Power light	green light — Blinking green in sleep state; solid green for power-on state. amber light — Blinking amber indicates a problem with an installed device; solid amber indicates an internal power problem (see "Power Problems" on page 42).
Hard-drive access light	green
Link integrity light (on integrated network adapter)	green light — A good connection exists between a 10-Mbps network and the computer. orange light — A good connection exists between a 100-Mbps network and the computer. yellow light — A good connection exists between a 1 Gb (or 1000-Mbps) connection. off (no light) — The computer is not detecting a physical connection to the network.
Activity light (on integrated network adapter)	yellow blinking light
Diagnostic lights	four lights on the back panel (See "Diagnostic Lights" on page 49.)
Standby power light	AUX_PWR on the system board

Power

DC power supply:	
Wattage	350 W
Heat dissipation	460.7 BTU/hr
Voltage (see the safety instructions located in the <i>Product Information Guide</i> for important voltage setting information)	fixed-voltage power supply — 110 V at 50/60 Hz manual selection and auto-sensing power supplies — 90 to 135 V at 50/60 Hz; 180 to 265 V at 50/60 Hz; 100 V at 50/60 Hz for Japanese computers
Backup battery	3-V CR2032 lithium coin cell

Physical

Height	42.5 cm (16.7 inches)
Width	18.1 cm (7.1 inches)
Depth	44.7 cm (17.6 inches)
Weight	12.7 kg (28 lbs)

Environmental

Temperature:

Operating 10° to 35°C (50° to 95°F)

NOTE: At 35°C (95°F), the maximum operating altitude is 914 m (3000 ft).

Storage -40° to 65°C (-40° to 149°F)

Relative humidity 20% to 80% (noncondensing)

Maximum vibration:

Operating 0.25 G at 3 to 200 Hz at 0.5 octave/min

Storage 0.5 G at 3 to 200 Hz at 1 octave/min

Maximum shock:

Operating bottom half-sine pulse with a change in velocity of 20 inches/sec (50.8 cm/sec)

Storage 27-G faired square wave with a velocity change of 200 inches/sec (508 cm/sec)

Altitude:

Operating -15.2 to 3048 m (-50 to 10,000 ft)

Storage -15.2 to 10,668 m (-50 to 35,000 ft)

System Setup

Overview

Use system setup as follows:

- To change the system configuration information after you add, change, or remove any hardware in your computer
- To set or change a user-selectable option such as the user password
- To read the current amount of memory or set the type of hard drive installed

Before you use system setup, it is recommended that you write down the system setup screen information for future reference.



NOTICE: Unless you are an expert computer user, do not change the settings for this program. Certain changes can make your computer work incorrectly.

Entering System Setup

- 1 Turn on (or restart) your computer.
- 2 When the blue DELL™ logo appears, press <F2> immediately.

If you wait too long and the operating system logo appears, continue to wait until you see the Microsoft® Windows® desktop. Then shut down your computer (see page 59) and try again.

System Setup Screens

The system setup screen displays current or changeable configuration information for your computer. Information on the screen is divided into three areas: the options list, active options field, and key functions.

<p>Options List — This field appears on the left side of the system setup window. The field is a scrollable list containing features that define the configuration of your computer, including installed hardware, power conservation, and security features.</p> <p>Scroll up and down the list with the up- and down-arrow keys. As an option is highlighted, the Option Field displays more information about that option and the option's current and available settings.</p>	<p>Option Field — This field contains information about each option. In this field you can view your current settings and make changes to your settings.</p> <p>Use the right and left arrow keys to highlight an option. Press <Enter> to make that selection active.</p>
	<p>Key Functions — This field appears below the Option Field and lists keys and their functions within the active system setup field.</p>

System Setup Options



NOTE: Depending on your computer and installed devices, the items listed in this section may not appear, or may not appear exactly as listed.

System	
System Info	Lists system information such as the computer name, the BIOS version number and date, system tags, and other system-specific information.
CPU Info	Identifies whether the computer's processor supports Hyper-Threading and lists the processor bus speed, processor ID, clock speed, and L2 cache.
Memory Info	Indicates amount of installed memory, memory speed, channel mode (dual or single), and type of memory installed.
Date/Time	Displays current date and time settings.
Boot Sequence	The computer attempts to boot from the sequence of devices specified in this list. NOTE: If you insert a boot device and restart the computer, this option appears in the system setup menu. To boot from a USB memory device, select the USB device and move it so it becomes the first device in the list.
Drives	
Diskette Drive	Identifies and defines the floppy drive attached to the FLOPPY connector on the system board as Off , USB , Internal , or Read Only .
Drives 0 through 5	Identifies the drives attached to the SATA or PRI IDE connectors on the system board, and lists the capacity for hard drives.
Drive Controller	Identifies and defines the SATA controller settings for RAID. You can set the SATA controller to RAID Autodetect/AHCI , RAID Autodetect/ATA , or RAID On .
Onboard Devices	
NIC Controller	You can set the NIC to On (default), Off , or On w/ PXE . When the On w/ PXE setting is active (available only for the future boot process), the computer prompts the user to press <Ctrl><Alt>. Pressing this key combination causes a menu to display that allows you to select a method for booting from a network server. If a boot routine is not available from the network server, the computer attempts to boot from the next device in the boot sequence list.
Audio Controller	Enables or disables the onboard audio controller.
USB	Set to On (default) so that USB devices will be detected and supported in the operating system.
Mouse Port	Enables or disables the onboard PS/2-compatible mouse controller.

LPT Port Mode	Identifies and defines the parallel port settings. You can set the parallel port to Off , AT , PS/2 , EPP , or ECP .
LPT Port Address	Identifies the address for the parallel port.
LPT Port DMA	Identifies and defines the parallel port DMA settings. You can set the parallel port DMA to Off , DMA1 , or DMA3 .
Serial Port #1	Identifies and defines the serial port settings. Auto , the default setting, automatically configures a connector to a particular designation (COM1 or COM3).
Video	
Primary Video	This setting specifies which video controller is primary when two video controllers are present on the computer.
Performance	
HyperThreading	If your computer's processor supports Hyper-Threading, this option appears in the Options List.
Performance	<ul style="list-style-type: none"> • Bypass — Your computer does not test or change the current acoustics mode setting. • Quiet (default) — The hard drive operates at its most quiet setting. • Suggested — The hard drive operates at the level suggested by the drive manufacturer. • Performance — The hard drive operates at its maximum speed. <p>NOTE: Switching to performance mode may cause the drive to be noisier, but its performance is not affected.</p> <p>NOTE: Changing the acoustics setting does not alter your hard drive image.</p>
Security	
Admin Password	This option provides restricted access to the computer's system setup program in the same way that access to the system can be restricted with the System Password option.
System Password	Displays the current status of the system's password security feature and allows a new system password to be assigned and verified.
Password Status	This option locks the system password field with the setup password. When the field is locked, you can no longer disable password security by pressing <Ctrl><Enter> when the computer starts.
Power Management	
AC Recovery	Determines what happens when AC power is restored to the computer.

Auto Power On	<p>Sets the computer to automatically turn on. Choices are every day or every Monday through Friday. The default setting is Off.</p> <p>This feature does not work if you turn off your computer using a power strip or surge protector.</p>
Auto Power Time	<p>Sets time to automatically turn on the computer.</p> <p>Time is kept in a 24-hour format (<i>hours:minutes</i>). Change the start-up time by pressing the right- or left-arrow key to increase or decrease the numbers, or type numbers in both the date and time fields.</p> <p>This feature does not work if you turn off your computer using a power strip or surge protector.</p>
Low Power Mode	<p>When Low Power Mode is selected, remote wakeup events no longer power up from Hibernate or Off.</p>
Remote Wake Up	<p>This option allows the computer to power up when a NIC or Remote Wakeup-capable modem receives a wake up signal.</p> <p>On is the default setting. On w/ Boot to NIC allows the computer to attempt to boot from a network prior to using the boot sequence.</p> <p>NOTE: Normally, the system can be powered up remotely from suspend mode, hibernate mode, or when powered off. When Low Power Mode (in the Power Management menu) is enabled, the computer can only be powered up remotely from Suspend.</p>
Suspend Mode	<p>The options are S1, a suspend state where the computer is running in a low-power mode, and S3, a standby state where the power is reduced or turned off for most components, however, system memory remains active.</p>
Maintenance	
CMOS Defaults	<p>This setting restores the computer's factory-installed default settings.</p>
Event Log	<p>Displays the system event log.</p>
BIOS Update	<p>After downloading a new version of the BIOS, use this option to identify and define the location of the BIOS update file. The options are Diskette or Disk.</p>
POST Behavior	
Fastboot	<p>When set to On (default), your computer starts more quickly because it skips certain configurations and tests.</p>
Numlock Key	<p>This option involves the rightmost bank of keys on your keyboard. When set to On (default), this option activates the numeric and mathematical features shown at the top of each key. When set to Off, this option activates the cursor-control functions labeled on the bottom of each key.</p>
OS Install	<p>This setting turns the OS Install Mode either On or Off (default).</p>

POST Hotkeys	This option allows you to specify the function keys to display on the screen when the computer starts.
Keyboard Errors	This option disables or enables keyboard error reporting when the computer starts.

Boot Sequence

This feature allows you to change the boot sequence for devices.

Option Settings

- **Diskette Drive** — The computer attempts to boot from the floppy drive. If the floppy disk in the drive is not bootable, if no floppy disk is in the drive, or if there is no floppy drive installed in the computer, the computer generates an error message.
- **Hard Drive** — The computer attempts to boot from the primary hard drive. If no operating system is on the drive, the computer generates an error message.
- **CD Drive** — The computer attempts to boot from the CD drive. If no CD is in the drive, or if the CD has no operating system, the computer generates an error message.
- **USB Flash Device** — Insert the memory device into a USB port and restart the computer. When **F12 = Boot Menu** appears in the upper-right corner of the screen, press <F12>. The BIOS detects the device and adds the USB flash option to the boot menu.

 **NOTE:** To boot to a USB device, the device must be bootable. To make sure that your device is bootable, check the device documentation.

Changing Boot Sequence for the Current Boot

You can use this feature, for example, to restart your computer to a USB device such as a floppy drive, memory key, or CD-RW drive.

 **NOTE:** If you are booting to a USB floppy drive, you must first set the floppy drive to OFF in system setup (see page 111).

- 1 If you are booting to a USB device, connect the USB device to a USB connector (see page 61).
- 2 Turn on (or restart) your computer.
- 3 When **F2 = Setup**, **F12 = Boot Menu** appears in the upper-right corner of the screen, press <F12>.

If you wait too long and the operating system logo appears, continue to wait until you see the Microsoft Windows desktop. Then shut down your computer (see page 59) and try again.

The **Boot Device Menu** appears, listing all available boot devices. Each device has a number next to it.

- 4 At the bottom of the menu, enter the number of the device that is to be used for the current boot only.

For example, if you are booting to a USB memory key, highlight **USB Flash Device** and press <Enter>.

 **NOTE:** To boot to a USB device, the device must be bootable. To make sure your device is bootable, check the device documentation.

Changing Boot Sequence for Future Boots

- 1 Enter system setup (see page 112).
- 2 Use the arrow keys to highlight the **Boot Sequence** menu option and press <Enter> to access the menu.

 **NOTE:** Write down your current boot sequence in case you want to restore it.



- 3 Press the up- and down-arrow keys to move through the list of devices.
- 4 Press the spacebar to enable or disable a device (enabled devices have a checkmark).
- 5 Press plus (+) or minus (-) to move a selected device up or down the list.

Clearing Forgotten Passwords

 **CAUTION:** Before you begin any of the procedures in this section, follow the safety instructions located in the *Product Information Guide*.

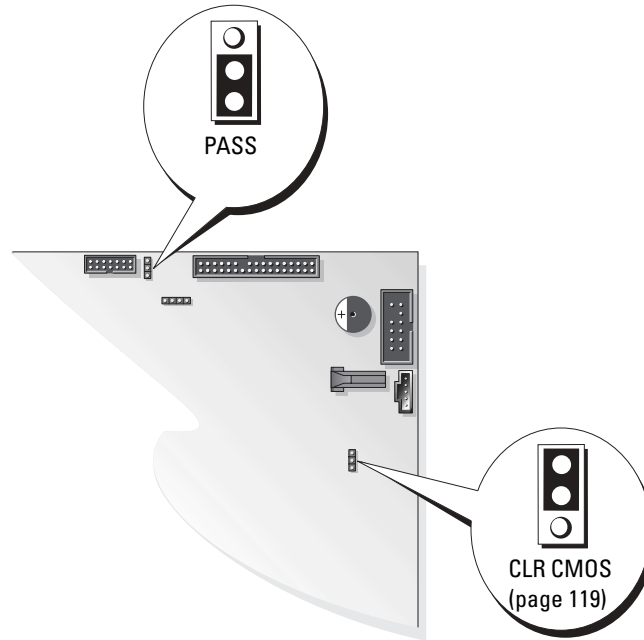
- 1 Follow the procedures in "Before You Begin" on page 59.



- 2 Locate the 3-pin password jumper (PASS) on the system board (see page 71), and attach the jumper plug to pins 2 and 3 to clear the password.
-  **NOTE:** When you receive your computer, the jumper plug is attached to pins 1 and 2.
- 3 Close the computer cover (see page 104).
- 4 Connect your computer and monitor to electrical outlets, and turn them on.
- 5 After the Microsoft® Windows® desktop appears on your computer, shut down the computer (see page 59).
- 6 Turn off the monitor and disconnect it from the electrical outlet.
- 7 Disconnect the computer power cable from the electrical outlet, and press the power button to ground the system board.
- 8 Open the computer cover (see page 69).
- 9 Locate the 3-pin password jumper (PASS) on the system board (see page 71) and attach the jumper to pins 1 and 2 to reenble the password feature.
- 10 Close the computer cover (see page 104).
-  **NOTICE:** To connect a network cable, first plug the cable into the network device and then plug it into the computer.
- 11 Connect your computer and devices to electrical outlets, and turn them on.

Clearing CMOS Settings

 **CAUTION:** Before you begin any of the procedures in this section, follow the safety instructions located in the *Product Information Guide*.

- 1 Follow the procedures in "Before You Begin" on page 59.
- 2 Reset the current CMOS settings:
 - a Locate the 3-pin CMOS jumper (CLR CMOS) on the system board (see page 71).
 - b Remove the jumper plug from pins 2 and 3.
 - c Place the jumper plug on pins 1 and 2 and wait approximately 5 seconds.
 - d Replace the jumper plug on pins 2 and 3.
- 3 Close the computer cover (see page 104).

 **NOTICE:** To connect a network cable, first plug the cable into the network wall jack and then plug it into the computer.

- 4 Connect your computer and devices to electrical outlets, and turn them on.

Cleaning Your Computer

 **CAUTION:** Before you begin any of the procedures in this section, follow the safety instructions located in the *Product Information Guide*.

Computer, Keyboard, and Monitor

 **CAUTION:** Before you clean your computer, disconnect the computer from the electrical outlet. Clean your computer with a soft cloth dampened with water. Do not use liquid or aerosol cleaners, which may contain flammable substances.

- Use a vacuum cleaner with a brush attachment to gently remove dust from the slots and holes on your computer and from between the keys on the keyboard.

 **NOTICE:** Do not wipe the display screen with any soap or alcohol solution. Doing so may damage the antiglare coating.

- To clean your monitor screen, lightly dampen a soft, clean cloth with water. If possible, use a special screen-cleaning tissue or solution suitable for the monitor's antistatic coating.
- Wipe the keyboard, computer, and plastic part of the monitor with a soft cleaning cloth moistened with a solution of three parts water and one part dishwashing detergent.

Do not soak the cloth or let water drip inside your computer or keyboard.

Mouse

If your screen cursor skips or moves abnormally, clean the mouse. To clean a non-optical mouse:

- 1 Turn the retainer ring on the underside of your mouse counterclockwise, and then remove the ball.

- 2 Wipe the ball with a clean, lint-free cloth.
- 3 Blow carefully into the ball cage to dislodge dust and lint.
- 4 If the rollers inside the ball cage are dirty, clean the rollers with a cotton swab moistened lightly with isopropyl alcohol.
- 5 Recenter the rollers in their channels if they are misaligned. Ensure that fluff from the swab is not left on the rollers.
- 6 Replace the ball and retainer ring, and turn the retainer ring clockwise until it clicks into place.

Floppy Drive

-  **NOTICE:** Do not attempt to clean drive heads with a swab. You might accidentally misalign the heads, which prevents the drive from operating.

Clean your floppy drive using a commercially available cleaning kit. These kits contain pretreated floppy disks to remove contaminants that accumulate during normal operation.

CDs and DVDs

-  **NOTICE:** Always use compressed air to clean the lens in the CD/DVD drive, and follow the instructions that come with the compressed air. Never touch the lens in the drive.

If you notice problems, such as skipping, with the playback quality of your CDs or DVDs, try cleaning the discs.

- 1 Hold the disc by its outer edge. You can also touch the inside edge of the center hole.

-  **NOTICE:** To prevent damaging the surface, do not wipe in a circular motion around the disc.

- 2 With a soft, lint-free cloth, gently wipe the bottom of the disc (the unlabeled side) in a straight line from the center to the outer edge of the disc.

For stubborn dirt, try using water or a diluted solution of water and mild soap. You can also purchase commercial products that clean discs and provide some protection from dust, fingerprints, and scratches. Cleaning products for CDs are safe to use on DVDs.

Dell Technical Support Policy (U.S. Only)

Technician-assisted technical support requires the cooperation and participation of the customer in the troubleshooting process and provides for restoration of the operating system, software programs, and hardware drivers to the original default configuration as shipped from Dell, as well as the verification of appropriate functionality of the computer and all Dell-installed hardware. In addition to this technician-assisted technical support, online technical support is available at support.dell.com. Additional technical support options may be available for purchase.

Dell provides limited technical support for the computer and any "Dell-installed" software and peripherals¹. Support for third-party software and peripherals is provided by the original manufacturer, including those purchased and/or installed through Dell Software and Peripherals, Readyware, and Custom Factory Integration².

¹ Repair services are provided pursuant to the terms and conditions of your limited warranty and any optional support service contract purchased with the computer.

² All Dell-standard components included in a Custom Factory Integration (CFI) project are covered by the standard Dell limited warranty for your computer. However, Dell also extends a parts replacement program to cover all nonstandard, third-party hardware components integrated through CFI for the duration of the computer's service contract.

Definition of "Dell-Installed" Software and Peripherals

Dell-installed software includes the operating system and some of the software programs that are installed on the computer during the manufacturing process (Microsoft[®] Office, Norton Antivirus, and so on).

Dell-installed peripherals include any internal expansion cards, or Dell-branded module bay or PC Card accessories. In addition, any Dell-branded monitors, keyboards, mice, speakers, microphones for telephonic modems, docking stations/port replicators, networking products, and all associated cabling are included.

Definition of "Third-Party" Software and Peripherals

Third-party software and peripherals include any peripheral, accessory, or software program sold by Dell not under the Dell brand (printers, scanners, cameras, games, and so on). Support for all third-party software and peripherals is provided by the original manufacturer of the product.

FCC Notices (U.S. Only)

Most Dell computer systems are classified by the Federal Communications Commission (FCC) as Class B digital devices. To determine which classification applies to your computer system, examine all FCC registration labels located on the bottom, side, or back panel of your computer, on card-mounting brackets, and on the cards themselves. If any one of the labels carries a Class A rating, your entire system is considered to be a Class A digital device. If *all* labels carry an FCC Class B rating as distinguished by either an FCC ID number or the FCC logo, (**FCC**), your system is considered to be a Class B digital device.

Once you have determined your system's FCC classification, read the appropriate FCC notice. Note that FCC regulations provide that changes or modifications not expressly approved by Dell could void your authority to operate this equipment.

This device complies with Part 15 of the FCC Rules. Operation is subject to the following two conditions:

This device may not cause harmful interference.

This device must accept any interference received, including interference that may cause undesired operation.

Class A

This equipment has been tested and found to comply with the limits for a Class A digital device pursuant to Part 15 of the FCC Rules. These limits are designed to provide reasonable protection against harmful interference when the equipment is operated in a commercial environment. This equipment generates, uses, and can radiate radio frequency energy and, if not installed and used in accordance with the manufacturer's instruction manual, may cause harmful interference with radio communications. Operation of this equipment in a residential area is likely to cause harmful interference, in which case you will be required to correct the interference at your own expense.

Class B

This equipment has been tested and found to comply with the limits for a Class B digital device pursuant to Part 15 of the FCC Rules. These limits are designed to provide reasonable protection against harmful interference in a residential installation. This equipment generates, uses, and can radiate radio frequency energy and, if not installed and used in accordance with the manufacturer's instruction manual, may cause interference with radio communications. However, there is no guarantee that interference will not occur in a particular installation. If this equipment does cause harmful interference to radio or television reception, which can be determined by turning the equipment off and on, you are encouraged to try to correct the interference by one or more of the following measures:

- Reorient or relocate the receiving antenna.
- Increase the separation between the equipment and the receiver.
- Connect the equipment into an outlet on a circuit different from that to which the receiver is connected.
- Consult the dealer or an experienced radio/television technician for help.

FCC Identification Information

The following information is provided on the device or devices covered in this document in compliance with FCC regulations:

- Model number: DHM

Company name:

Dell Inc.
One Dell Way
Round Rock, Texas 78682 USA
512-338-4400

Contacting Dell

To contact Dell™ electronically, you can access the following websites:

- www.dell.com
- support.dell.com (technical support)
- premiersupport.dell.com (technical support for educational, government, healthcare, and medium/large business customers, including Premier, Platinum, and Gold customers)

For specific web addresses for your country, find the appropriate country section in the table below.



NOTE: Toll-free numbers are for use within the country for which they are listed.

When you need to contact Dell, use the electronic addresses, telephone numbers, and codes provided in the following table. If you need assistance in determining which codes to use, contact a local or an international operator.

Country (City) International Access Code Country Code City Code	Department Name or Service Area, Website and E-Mail Address	Area Codes, Local Numbers, and Toll-Free Numbers
Anguilla	General Support	toll-free: 800-335-0031
Antigua and Barbuda	General Support	1-800-805-5924
Argentina (Buenos Aires) International Access Code: 00 Country Code: 54 City Code: 11	Website: www.dell.com.ar E-mail: us_latin_services@dell.com E-mail for desktop and portable computers: la-techsupport@dell.com E-mail for servers and EMC: la_enterprise@dell.com Customer Care Tech Support Tech Support Services Sales	toll-free: 0-800-444-0730 toll-free: 0-800-444-0733 toll-free: 0-800-444-0724 0-810-444-3355
Aruba	General Support	toll-free: 800-1578

Country (City) International Access Code Country Code City Code	Department Name or Service Area, Website and E-Mail Address	Area Codes, Local Numbers, and Toll-Free Numbers
Australia (Sydney)	E-mail (Australia): au_tech_support@dell.com	
International Access Code: 0011	E-mail (New Zealand): nz_tech_support@dell.com	
Country Code: 61	Home and Small Business	1-300-655-533
City Code: 2	Government and Business	toll-free: 1-800-633-559
	Preferred Accounts Division (PAD)	toll-free: 1-800-060-889
	Customer Care	toll-free: 1-800-819-339
	Technical Support (portables and desktops)	toll-free: 1-300-655-533
	Technical Support (servers and workstations)	toll-free: 1-800-733-314
	Corporate Sales	toll-free: 1-800-808-385
	Transaction Sales	toll-free: 1-800-808-312
	Fax	toll-free: 1-800-818-341
Austria (Vienna)	Website: support.euro.dell.com	
International Access Code: 900	E-mail: tech_support_central_europe@dell.com	
Country Code: 43	Home/Small Business Sales	0820 240 530 00
City Code: 1	Home/Small Business Fax	0820 240 530 49
	Home/Small Business Customer Care	0820 240 530 14
	Preferred Accounts/Corporate Customer Care	0820 240 530 16
	Home/Small Business Technical Support	0820 240 530 14
	Preferred Accounts/Corporate Technical Support	0660 8779
	Switchboard	0820 240 530 00
Bahamas	General Support	toll-free: 1-866-278-6818
Barbados	General Support	1-800-534-3066
Belgium (Brussels)	Website: support.euro.dell.com	
International Access Code: 00	E-mail for French Speaking Customers: support.euro.dell.com/be/fr/emaildell/	
Country Code: 32	Technical Support	02 481 92 88
City Code: 2	Technical Support Fax	02 481 92 95
	Customer Care	02 713 15 .65
	Corporate Sales	02 481 91 00
	Fax	02 481 92 99
	Switchboard	02 481 91 00

Country (City) International Access Code Country Code City Code	Department Name or Service Area, Website and E-Mail Address	Area Codes, Local Numbers, and Toll-Free Numbers
Bermuda	General Support	1-800-342-0671
Bolivia	General Support	toll-free: 800-10-0238
Brazil	Website: www.dell.com/br	
International Access Code: 00	Customer Support, Technical Support	0800 90 3355
Country Code: 55	Technical Support Fax	51 481 5470
City Code: 51	Customer Care Fax	51 481 5480
	Sales	0800 90 3390
British Virgin Islands	General Support	toll-free: 1-866-278-6820
Brunei	Customer Technical Support (Penang, Malaysia)	604 633 4966
Country Code: 673	Customer Service (Penang, Malaysia)	604 633 4949
	Transaction Sales (Penang, Malaysia)	604 633 4955
Canada (North York, Ontario)	Online Order Status: www.dell.ca/ostatus	
International Access Code: 011	AutoTech (automated technical support)	toll-free: 1-800-247-9362
	Customer Care (Home Sales/Small Business)	toll-free: 1-800-847-4096
	Customer Care (med./large business, government)	toll-free: 1-800-326-9463
	Technical Support (Home Sales/Small Business)	toll-free: 1-800-847-4096
	Technical Support (med./large bus., government)	toll-free: 1-800-387-5757
	Sales (Home Sales/Small Business)	toll-free: 1-800-387-5752
	Sales (med./large bus., government)	toll-free: 1-800-387-5755
	Spare Parts Sales & Extended Service Sales	1 866 440 3355
Cayman Islands	General Support	1-800-805-7541
Chile (Santiago)	Sales, Customer Support, and Technical Support	toll-free: 1230-020-4823
Country Code: 56		
City Code: 2		

Country (City) International Access Code Country Code City Code	Department Name or Service Area, Website and E-Mail Address	Area Codes, Local Numbers, and Toll-Free Numbers
China (Xiamen) Country Code: 86 City Code: 592	Technical Support website: support.dell.com.cn Technical Support E-mail: cn_support@dell.com Customer Care E-mail: customer_cn@dell.com Technical Support Fax Technical Support (Dimension™ and Inspiron™) Technical Support (OptiPlex™, Latitude™, and Dell Precision™) Technical Support (servers and storage) Technical Support (projectors, PDAs, printers, switches, routers, and so on) Customer Care Customer Care Fax Home and Small Business Preferred Accounts Division Large Corporate Accounts GCP Large Corporate Accounts Key Accounts Large Corporate Accounts North Large Corporate Accounts North Government and Education Large Corporate Accounts East Large Corporate Accounts East Government and Education Large Corporate Accounts Queue Team Large Corporate Accounts South Large Corporate Accounts West Large Corporate Accounts Spare Parts	818 1350 toll-free: 800 858 2969 toll-free: 800 858 0950 toll-free: 800 858 0960 toll-free: 800 858 2920 toll-free: 800 858 2060 592 818 1308 toll-free: 800 858 2222 toll-free: 800 858 2557 toll-free: 800 858 2055 toll-free: 800 858 2628 toll-free: 800 858 2999 toll-free: 800 858 2955 toll-free: 800 858 2020 toll-free: 800 858 2669 toll-free: 800 858 2572 toll-free: 800 858 2355 toll-free: 800 858 2811 toll-free: 800 858 2621
Colombia	General Support	980-9-15-3978
Costa Rica	General Support	0800-012-0435

Country (City) International Access Code Country Code City Code	Department Name or Service Area, Website and E-Mail Address	Area Codes, Local Numbers, and Toll-Free Numbers
Czech Republic (Prague) International Access Code: 00 Country Code: 420	Website: support.euro.dell.com E-mail: czech_dell@dell.com Technical Support Customer Care Fax Tech Fax Switchboard	 22537 2727 22537 2707 22537 2714 22537 2728 22537 2711
Denmark (Copenhagen) International Access Code: 00 Country Code: 45	Website: support.euro.dell.com E-mail: http://support.euro.dell.com/dk/da/emaildell/ Technical Support Customer Care (Relational) Home/Small Business Customer Care Switchboard (Relational) Switchboard Fax (Relational) Switchboard (Home/Small Business) Switchboard Fax (Home/Small Business)	 7023 0182 7023 0184 3287 5505 3287 1200 3287 1201 3287 5000 3287 5001
Dominica	General Support	toll-free: 1-866-278-6821
Dominican Republic	General Support	1-800-148-0530
Ecuador	General Support	toll-free: 999-119
El Salvador	General Support	01-899-753-0777
Finland (Helsinki) International Access Code: 990 Country Code: 358 City Code: 9	Website: support.euro.dell.com E-mail: http://support.euro.dell.com/fi/fi/emaildell/ Technical Support Customer Care Fax Switchboard	 09 253 313 60 09 253 313 38 09 253 313 99 09 253 313 00

Country (City) International Access Code Country Code City Code	Department Name or Service Area, Website and E-Mail Address	Area Codes, Local Numbers, and Toll-Free Numbers
France (Paris) (Montpellier)	Website: support.euro.dell.com	
International Access Code: 00	E-mail: support.euro.dell.com/fr/fr/emaildell/	
Country Code: 33	Home and Small Business	
City Codes: (1) (4)	Technical Support	0825 387 270
	Customer Care	0825 823 833
	Switchboard	0825 004 700
	Switchboard (calls from outside of France)	04 99 75 40 00
	Sales	0825 004 700
	Fax	0825 004 701
	Fax (calls from outside of France)	04 99 75 40 01
	Corporate	
	Technical Support	0825 004 719
	Customer Care	0825 338 339
	Switchboard	01 55 94 71 00
	Sales	01 55 94 71 00
	Fax	01 55 94 71 01
Germany (Langen)	Website: support.euro.dell.com	
International Access Code: 00	E-mail: tech_support_central_europe@dell.com	
Country Code: 49	Technical Support	06103 766-7200
City Code: 6103	Home/Small Business Customer Care	0180-5-224400
	Global Segment Customer Care	06103 766-9570
	Preferred Accounts Customer Care	06103 766-9420
	Large Accounts Customer Care	06103 766-9560
	Public Accounts Customer Care	06103 766-9555
	Switchboard	06103 766-7000

Country (City) International Access Code Country Code City Code	Department Name or Service Area, Website and E-Mail Address	Area Codes, Local Numbers, and Toll-Free Numbers
Greece	Website: support.euro.dell.com	
International Access Code: 00	E-mail: support.euro.dell.com/gr/en/emaildell/	
Country Code: 30	Technical Support	00800-44 14 95 18
	Gold Service Technical Support	00800-44 14 00 83
	Switchboard	2108129810
	Gold Service Switchboard	2108129811
	Sales	2108129800
	Fax	2108129812
Grenada	General Support	toll-free: 1-866-540-3355
Guatemala	General Support	1-800-999-0136
Guyana	General Support	toll-free: 1-877-270-4609
Hong Kong	Website: support.ap.dell.com	
International Access Code: 001	Technical Support E-mail: apsupport@dell.com	
Country Code: 852	Technical Support (Dimension and Inspiron)	2969 3188
	Technical Support (OptiPlex, Latitude, and Dell Precision)	2969 3191
	Technical Support (PowerApp™, PowerEdge™, PowerConnect™, and PowerVault™)	2969 3196
	Customer Care	3416 0910
	Large Corporate Accounts	3416 0907
	Global Customer Programs	3416 0908
	Medium Business Division	3416 0912
	Home and Small Business Division	2969 3105
India	Technical Support	1600 33 8045
	Sales (Large Corporate Accounts)	1600 33 8044
	Sales (Home and Small Business)	1600 33 8046

Country (City) International Access Code Country Code City Code	Department Name or Service Area, Website and E-Mail Address	Area Codes, Local Numbers, and Toll-Free Numbers
Ireland (Cherrywood)	Website: support.euro.dell.com	
International Access Code: 16	E-mail: dell_direct_support@dell.com	
Country Code: 353	Technical Support	1850 543 543
City Code: 1	U.K. Technical Support (dial within U.K. only)	0870 908 0800
	Home User Customer Care	01 204 4014
	Small Business Customer Care	01 204 4014
	U.K. Customer Care (dial within U.K. only)	0870 906 0010
	Corporate Customer Care	1850 200 982
	Corporate Customer Care (dial within U.K. only)	0870 907 4499
	Ireland Sales	01 204 4444
	U.K. Sales (dial within U.K. only)	0870 907 4000
	Fax/Sales Fax	01 204 0103
	Switchboard	01 204 4444
Italy (Milan)	Website: support.euro.dell.com	
International Access Code: 00	E-mail: support.euro.dell.com/it/it/emaildell/	
Country Code: 39	Home and Small Business	
City Code: 02	Technical Support	02 577 826 90
	Customer Care	02 696 821 14
	Fax	02 696 821 13
	Switchboard	02 696 821 12
	Corporate	
	Technical Support	02 577 826 90
	Customer Care	02 577 825 55
	Fax	02 575 035 30
	Switchboard	02 577 821
Jamaica	General Support (dial from within Jamaica only)	1-800-682-3639

Country (City) International Access Code Country Code City Code	Department Name or Service Area, Website and E-Mail Address	Area Codes, Local Numbers, and Toll-Free Numbers
Japan (Kawasaki)	Website: support.jp.dell.com	
International Access Code: 001	Technical Support (servers)	toll-free: 0120-198-498
Country Code: 81	Technical Support outside of Japan (servers)	81-44-556-4162
City Code: 44	Technical Support (Dimension and Inspiron)	toll-free: 0120-198-226
	Technical Support outside of Japan (Dimension and Inspiron)	81-44-520-1435
	Technical Support (Dell Precision, OptiPlex, and Latitude)	toll-free:0120-198-433
	Technical Support outside of Japan (Dell Precision, OptiPlex, and Latitude)	81-44-556-3894
	Technical Support (PDAs, projectors, printers, routers)	toll-free: 0120-981-690
	Technical Support outside of Japan (PDAs, projectors, printers, routers)	81-44-556-3468
	Faxbox Service	044-556-3490
	24-Hour Automated Order Service	044-556-3801
	Customer Care	044-556-4240
	Business Sales Division (up to 400 employees)	044-556-1465
	Preferred Accounts Division Sales (over 400 employees)	044-556-3433
	Large Corporate Accounts Sales (over 3500 employees)	044-556-3430
	Public Sales (government agencies, educational institutions, and medical institutions)	044-556-1469
	Global Segment Japan	044-556-3469
	Individual User	044-556-1760
	Switchboard	044-556-4300
Korea (Seoul)	Technical Support	toll-free: 080-200-3800
International Access Code: 001	Sales	toll-free: 080-200-3600
Country Code: 82	Customer Service (Penang, Malaysia)	604 633 4949
City Code: 2	Fax	2194-6202
	Switchboard	2194-6000
	Technical Support (Electronics and Accessories)	toll-free: 080-200-3801

Country (City) International Access Code Country Code City Code	Department Name or Service Area, Website and E-Mail Address	Area Codes, Local Numbers, and Toll-Free Numbers
Latin America	Customer Technical Support (Austin, Texas, U.S.A.)	512 728-4093
	Customer Service (Austin, Texas, U.S.A.)	512 728-3619
	Fax (Technical Support and Customer Service) (Austin, Texas, U.S.A.)	512 728-3883
	Sales (Austin, Texas, U.S.A.)	512 728-4397
	SalesFax (Austin, Texas, U.S.A.)	512 728-4600 or 512 728-3772
Luxembourg	Website: support.euro.dell.com	
International Access Code: 00	E-mail: tech_be@dell.com	
Country Code: 352	Technical Support (Brussels, Belgium)	3420808075
	Home/Small Business Sales (Brussels, Belgium)	toll-free: 080016884
	Corporate Sales (Brussels, Belgium)	02 481 91 00
	Customer Care (Brussels, Belgium)	02 481 91 19
	Fax (Brussels, Belgium)	02 481 92 99
	Switchboard (Brussels, Belgium)	02 481 91 00
Macao	Technical Support	toll-free: 0800 105
Country Code: 853	Customer Service (Xiamen, China)	34 160 910
	Transaction Sales (Xiamen, China)	29 693 115
Malaysia (Penang)	Website: support.ap.dell.com	toll-free: 1 800 88 0193
International Access Code: 00	Technical Support (Dell Precision, OptiPlex, and Latitude)	toll-free: 1 800 88 1306
Country Code: 60	Technical Support (Dimension, Inspiron, and Electronics and Accessories)	
City Code: 4	Technical Support (PowerApp, PowerEdge, PowerConnect, and PowerVault)	toll-free: 1800 88 1386
	Customer Service (Penang, Malaysia)	04 633 4949
	Transaction Sales	toll-free: 1 800 888 202
	Corporate Sales	toll-free: 1 800 888 213

Country (City) International Access Code Country Code City Code	Department Name or Service Area, Website and E-Mail Address	Area Codes, Local Numbers, and Toll-Free Numbers
Mexico	Customer Technical Support	001-877-384-8979
International Access Code: 00		or 001-877-269-3383
Country Code: 52	Sales	50-81-8800
		or 01-800-888-3355
	Customer Service	001-877-384-8979
		or 001-877-269-3383
	Main	50-81-8800
		or 01-800-888-3355
Montserrat	General Support	toll-free: 1-866-278-6822
Netherlands Antilles	General Support	001-800-882-1519
Netherlands (Amsterdam)	Website: support.euro.dell.com	
International Access Code: 00	Technical Support	020 674 45 00
Country Code: 31	Technical Support Fax	020 674 47 66
City Code: 20	Home/Small Business Customer Care	020 674 42 00
	Relational Customer Care	020 674 4325
	Home/Small Business Sales	020 674 55 00
	Relational Sales	020 674 50 00
	Home/Small Business Sales Fax	020 674 47 75
	Relational Sales Fax	020 674 47 50
	Switchboard	020 674 50 00
	Switchboard Fax	020 674 47 50
New Zealand	E-mail (New Zealand): nz_tech_support@dell.com	
International Access Code: 00	E-mail (Australia): au_tech_support@dell.com	
Country Code: 64	Technical Support (for desktop and portable computers)	toll-free: 0800 446 255
	Technical Support (for servers and workstations)	toll-free: 0800 443 563
	Home and Small Business	0800 446 255
	Government and Business	0800 444 617
	Sales	0800 441 567
	Fax	0800 441 566
Nicaragua	General Support	001-800-220-1006

Country (City) International Access Code Country Code City Code	Department Name or Service Area, Website and E-Mail Address	Area Codes, Local Numbers, and Toll-Free Numbers
Norway (Lysaker)	Website: support.euro.dell.com	
International Access Code: 00	E-mail:	
Country Code: 47	http://support.euro.dell.com/no/no/emaildell/	
	Technical Support	671 16882
	Relational Customer Care	671 17575
	Home/Small Business Customer Care	23162298
	Switchboard	671 16800
	Fax Switchboard	671 16865
Panama	General Support	001-800-507-0962
Peru	General Support	0800-50-669
Poland (Warsaw)	Website: support.euro.dell.com	
International Access Code: 011	E-mail: pl_support_tech@dell.com	
Country Code: 48	Customer Service Phone	57 95 700
City Code: 22	Customer Care	57 95 999
	Sales	57 95 999
	Customer Service Fax	57 95 806
	Reception Desk Fax	57 95 998
	Switchboard	57 95 999
Portugal	Website: support.euro.dell.com	
International Access Code: 00	E-mail: support.euro.dell.com/pt/en/emaildell/	
Country Code: 351	Technical Support	707200149
	Customer Care	800 300 413
	Sales	800 300 410 or 800 300 411 or 800 300 412 or 21 422 07 10
	Fax	21 424 01 12
Puerto Rico	General Support	1-800-805-7545
St. Kitts and Nevis	General Support	toll-free: 1-877-441-4731
St. Lucia	General Support	1-800-882-1521
St. Vincent and the Grenadines	General Support	toll-free: 1-877-270-4609

Country (City) International Access Code Country Code City Code	Department Name or Service Area, Website and E-Mail Address	Area Codes, Local Numbers, and Toll-Free Numbers
Singapore (Singapore)	Website: support.ap.dell.com	
International Access Code: 005 Country Code: 65	Technical Support (Dimension, Inspiron, and Electronics and Accessories)	toll-free: 1800 394 7430
	Technical Support (OptiPlex, Latitude, and Dell Precision)	toll-free: 1800 394 7488
	Technical Support (PowerApp, PowerEdge, PowerConnect, and PowerVault)	toll-free: 1800 394 7478
	Customer Service (Penang, Malaysia)	604 633 4949
	Transaction Sales	toll-free: 1 800 394 7412
	Corporate Sales	toll-free: 1 800 394 7419
Slovakia (Prague)	Website: support.euro.dell.com	
International Access Code: 00 Country Code: 421	E-mail: czech_dell@dell.com	
	Technical Support	02 5441 5727
	Customer Care	420 22537 2707
	Fax	02 5441 8328
	Tech Fax	02 5441 8328
	Switchboard (Sales)	02 5441 7585
South Africa (Johannesburg)	Website: support.euro.dell.com	
International Access Code: 09/091 Country Code: 27 City Code: 11	E-mail: dell_za_support@dell.com	
	Gold Queue	011 709 7713
	Technical Support	011 709 7710
	Customer Care	011 709 7707
	Sales	011 709 7700
	Fax	011 706 0495
	Switchboard	011 709 7700
Southeast Asian and Pacific Countries	Customer Technical Support, Customer Service, and Sales (Penang, Malaysia)	604 633 4810

Country (City) International Access Code Country Code City Code	Department Name or Service Area, Website and E-Mail Address	Area Codes, Local Numbers, and Toll-Free Numbers
Spain (Madrid)	Website: support.euro.dell.com	
International Access Code: 00	E-mail: support.euro.dell.com/es/es/emaildell/	
Country Code: 34	Home and Small Business	
City Code: 91	Technical Support	902 100 130
	Customer Care	902 118 540
	Sales	902 118 541
	Switchboard	902 118 541
	Fax	902 118 539
	Corporate	
	Technical Support	902 100 130
	Customer Care	902 115 236
	Switchboard	91 722 92 00
	Fax	91 722 95 83
Sweden (Upplands Vasby)	Website: support.euro.dell.com	
International Access Code: 00	E-mail: http://support.euro.dell.com/se/sv/emaildell/	
Country Code: 46	Technical Support	08 590 05 199
City Code: 8	Relational Customer Care	08 590 05 642
	Home/Small Business Customer Care	08 587 70 527
	Employee Purchase Program (EPP) Support	20 140 14 44
	Technical Support Fax	08 590 05 594
	Sales	08 590 05 185
Switzerland (Geneva)	Website: support.euro.dell.com	
International Access Code: 00	E-mail: Tech_support_central_Europe@dell.com	
Country Code: 41	E-mail for French-speaking HSB and Corporate Customers: support.euro.dell.com/ch/fr/emaildell/	
City Code: 22	Technical Support (Home and Small Business)	0844 811 411
	Technical Support (Corporate)	0844 822 844
	Customer Care (Home and Small Business)	0848 802 202
	Customer Care (Corporate)	0848 821 721
	Fax	022 799 01 90
	Switchboard	022 799 01 01

Country (City) International Access Code Country Code City Code	Department Name or Service Area, Website and E-Mail Address	Area Codes, Local Numbers, and Toll-Free Numbers
Taiwan	Website: support.ap.dell.com	
International Access Code: 002	E-mail: ap_support@dell.com	
Country Code: 886	Technical Support (OptiPlex, Latitude, Inspiron, Dimension, and Electronics and Accessories)	toll-free: 00801 86 1011
	Technical Support (PowerApp, PowerEdge, PowerConnect, and PowerVault)	toll-free: 00801 60 1256
	Transaction Sales	toll-free: 00801 65 1228
	Corporate Sales	toll-free: 00801 651 227
Thailand	Website: support.ap.dell.com	
International Access Code: 001	Technical Support (OptiPlex, Latitude, and Dell Precision)	toll-free: 1800 0060 07
Country Code: 66	Technical Support (PowerApp, PowerEdge, PowerConnect, and PowerVault)	toll-free: 1800 0600 09
	Customer Service (Penang, Malaysia)	604 633 4949
	Corporate Sales	toll-free: 1800 006 009
	Transaction Sales	toll-free: 1800 006 006
Trinidad/Tobago	General Support	1-800-805-8035
Turks and Caicos Islands	General Support	toll-free: 1-866-540-3355

Country (City) International Access Code Country Code City Code	Department Name or Service Area, Website and E-Mail Address	Area Codes, Local Numbers, and Toll-Free Numbers
U.K. (Bracknell)	Website: support.euro.dell.com	
International Access Code: 00	Customer Care website: support.euro.dell.com/uk/en/ECare/Form/Home.asp	
Country Code: 44		
City Code: 1344	E-mail: dell_direct_support@dell.com	
	Technical Support (Corporate/Preferred Accounts/PAD [1000+ employees])	0870 908 0500
	Technical Support (direct and general)	0870 908 0800
	Global Accounts Customer Care	01344 373 186
	Home and Small Business Customer Care	0870 906 0010
	Corporate Customer Care	01344 373 185
	Preferred Accounts (500–5000 employees) Customer Care	0870 906 0010
	Central Government Customer Care	01344 373 193
	Local Government & Education Customer Care	01344 373 199
	Health Customer Care	01344 373 194
	Home and Small Business Sales	0870 907 4000
	Corporate/Public Sector Sales	01344 860 456
	Home and Small Business Fax	0870 907 4006
Uruguay	General Support	toll-free: 000-413-598-2521

Country (City) International Access Code Country Code City Code	Department Name or Service Area, Website and E-Mail Address	Area Codes, Local Numbers, and Toll-Free Numbers
U.S.A. (Austin, Texas)	Automated Order-Status Service	toll-free: 1-800-433-9014
International Access Code: 011 Country Code: 1	AutoTech (portable and desktop computers) Consumer (Home and Home Office) Technical Support Customer Service DellNet™ Service and Support Employee Purchase Program (EPP) Customers Financial Services website: www.dellfinancialservices.com Financial Services (lease/loans) Financial Services (Dell Preferred Accounts [DPA]) Business Customer Service and Technical Support Employee Purchase Program (EPP) Customers Printers and Projectors Technical Support Public (government, education, and healthcare) Customer Service and Technical Support Employee Purchase Program (EPP) Customers Dell Sales Dell Outlet Store (Dell refurbished computers) Software and Peripherals Sales Spare Parts Sales Extended Service and Warranty Sales Fax Dell Services for the Deaf, Hard-of-Hearing, or Speech-Impaired	toll-free: 1-800-247-9362 toll-free: 1-800-624-9896 toll-free: 1-800-624-9897 toll-free: 1-877-Dellnet (1-877-335-5638) toll-free: 1-800-695-8133 toll-free: 1-877-577-3355 toll-free: 1-800-283-2210 toll-free: 1-800-822-8965 toll-free: 1-800-695-8133 toll-free: 1-877-459-7298 toll-free: 1-800-456-3355 toll-free: 1-800-234-1490 toll-free: 1-800-289-3355 or toll-free: 1-800-879-3355 toll-free: 1-888-798-7561 toll-free: 1-800-671-3355 toll-free: 1-800-357-3355 toll-free: 1-800-247-4618 toll-free: 1-800-727-8320 toll-free: 1-877-DELLTTY (1-877-335-5889)
U.S. Virgin Islands	General Support	1-877-673-3355
Venezuela	General Support	8001-3605

Index

A

audio. See *sound*

B

battery

- problems, 33
- replacing, 103

BIOS, 111

boot sequence

- about, 116
- changing, 116-117
- option settings, 116

booting

- to a USB device, 116

C

card fan

- installing, 86
- problems, 33

cards

- installing PCI, 76
- installing PCI Express, 81
- PCI, 76
- PCI Express, 81
- PCI Express card fan, 86
- PCI Express slots, 64
- PCI slots, 64
- removing PCI, 80
- removing PCI Express, 85

cards (*continued*)

- slots, 64, 75
- types supported, 75

CD/DVD drive

- activity light, 61
- eject button, 61
- front-panel inserts, 94
- installing, 101
- problems, 34
- removing, 100

CD-RW drive

- problems, 35

CDs

- copying, 17
- playing, 15

Check Disk, 35

CMOS settings

- clearing, 119

computer

- components inside, 70
- crashes, 38-39
- inside view, 70
- restore to previous operating state, 56
- stops responding, 38-39

connectors

- center/LFE, 64-65
- DVI, 64
- headphone, 62
- keyboard, 65
- line-in, 64
- line-out, 64-65

connectors (*continued*)

- microphone, 64-65
- modem, 64
- mouse, 63
- network adapter, 65
- parallel, 63
- power, 63
- serial, 65
- sound, 64-65
- surround, 64
- TV-OUT, 64
- USB, 62, 65
- VGA, 64
- video, 64

copying CDs and DVDs, 17

cover

- closing, 104
- opening, 69

D

Dell

- contacting, 123
- Dell Diagnostics, 52
- support policy, 119
- support site, 10

diagnostic lights, 49

diagnostics

- Dell, 52
- lights, 49, 63

display. See *monitor*

- documentation
 - End User License Agreement, 9
 - ergonomics, 9
 - Finding Information, 9
 - online, 10
 - Product Information Guide, 9
 - regulatory, 9
 - safety, 9
 - Setup Diagram, 9
 - warranty, 9
- door
 - front-panel, 62
 - hinge arms, 65
 - reattaching, 65
- drivers
 - about, 54
 - identifying, 54
- drives
 - front-panel inserts, 94
 - hard drive, 90
 - installing CD/DVD, 94, 101
 - installing floppy, 94, 98
 - installing hard drive, 92
 - problems, 34
 - RAID, 20
 - removing CD/DVD, 100
 - removing floppy, 97
 - removing hard drive, 91
 - second hard drive, 93
 - serial ATA, 90
- DVD drive
 - problems, 34

- DVDs
 - copying, 17
 - playing, 15
- DVI
 - connector, 64

E

- e-mail
 - problems, 35
- End User License Agreement, 9
- ergonomics information, 9
- error messages
 - diagnostic lights, 49
 - troubleshooting, 36

F

- Files and Settings Transfer Wizard, 28
- Finding Information, 9
- floppy drive
 - activity light, 61
 - eject button, 61
 - front-panel inserts, 94
 - installing, 98
 - removing, 97
- front door
 - hinge arms, 65
 - reattaching, 65
- front-panel inserts, 94

H

- hard drive
 - activity light, 61
 - installing, 92
 - installing second, 93
 - problems, 35
 - removing, 91
- hardware
 - Dell Diagnostics, 52
 - drives, RAID configuration, 20
- Hardware Troubleshooter, 58
- headphone
 - connector, 62
- Help and Support Center, 10
- help file
 - Windows Help and Support Center, 10
- hibernate mode, 30-31
- Hyper-Threading, 31

I

- IEEE 1394
 - problems, 37
- installing parts
 - before you begin, 59
 - recommended tools, 59
 - turning off your computer, 59
- Internet
 - connection, about, 13
 - connection, options, 13
 - connection, setting up, 14
 - problems, 35

K

- keyboard
 - connector, 65
 - problems, 38

L

- labels
 - Microsoft Windows, 10
 - Service Tag, 10, 62
- lights
 - back of computer, 49
 - CD/DVD drive activity, 61
 - diagnostic, 49, 63
 - floppy drive activity, 61
 - hard drive activity, 61

M

- memory
 - 4-GB configurations, 73
 - DDR2 overview, 72
 - installation guidelines, 72
 - installing, 73
 - problems, 40
 - removing, 75
 - type supported, 72
- messages
 - error, 36
- microphone
 - connector, 64-65
- Microsoft Windows label, 10
- modem
 - connector, 64
 - problems, 35

- monitor
 - blank, 46
 - clone mode, 20
 - connect DVI, 19-20
 - connect TV, 19-20
 - connect two, 19-20
 - connect VGA, 19-20
 - display settings, 20
 - extended desktop mode, 20
 - hard to read, 47
 - problems, 46

motherboard. See *system board*

- mouse
 - connector, 63
 - problems, 41

N

- network
 - connector, 65
 - Network Setup Wizard, 29
 - problems, 42
 - setting up, 28
- Network Setup Wizard, 29

O

- operating system
 - reinstalling Windows XP, 56

P

- password
 - clearing, 117
 - jumper, 117

PC Restore, 57

- PCI cards
 - installing, 76
 - removing, 80

- PCI Express cards
 - card fan, 86
 - installing, 81
 - removing, 85

- playing CDs, 15
- playing DVDs, 15

- power
 - button, 62
 - connector, 63
 - conserving, 29
 - hibernate mode, 30-31
 - managing, 29
 - options, 30
 - options, advanced, 31
 - options, hibernate, 31
 - options, schemes, 30
 - problems, 42
 - standby mode, 29

- power light
 - conditions, 42

Power Options Properties, 30

- printer
 - cable, 11
 - connecting, 11
 - parallel, 12
 - problems, 43
 - setting up, 11
 - USB, 11

- problems
 - battery, 33
 - blue screen, 39
 - card fan, 33

problems (*continued*)
CD drive, 34
CD-RW drive, 35
computer crashes, 38-39
computer stops
 responding, 38-39
Dell Diagnostics, 52
diagnostic lights, 49
drives, 34
DVD drive, 34
e-mail, 35
error messages, 36
general, 38
hard drive, 35
IEEE 1394, 37
Internet, 35
keyboard, 38
memory, 40
modem, 35
monitor is blank, 46
monitor is hard to read, 47
mouse, 41
network, 42
power, 42
power light conditions, 42
printer, 43
program crashes, 39
program stops responding, 39
programs and Windows
 compatibility, 39
restore to previous operating
 state, 56
scanner, 44
screen is blank, 46
screen is hard to read, 47
software, 39-40
sound and speakers, 45
technical support policy, 119

problems (*continued*)
troubleshooting tips, 33
video and monitor, 46
volume adjusting, 45
Product Information Guide, 9
Program Compatibility
 Wizard, 39

R

RAID
 configuring, 20
regulatory information, 9
reinstalling
 Windows XP, 56

S

safety instructions, 9
SATA. See *serial ATA*
scanner
 problems, 44
screen. See *monitor*
serial ATA, 90
Service Tag, 10, 62
settings
 system setup, 111
Setup Diagram, 9
software
 Hyper-Threading, 31
 problems, 39-40
sound
 problems, 45
 volume, 45

sound connectors
 about, 64
 center/LFE, 65
 line-in, 64
 line-out, 65
 surround, 64
speaker
 problems, 45
 volume, 45
specifications
 audio, 108
 computer information, 107
 connectors, 109
 controls and lights, 110
 drives, 109
 environmental, 111
 expansion bus, 108
 memory, 107
 physical, 110
 power, 110
 processor, 107
 technical, 107
 video, 107
standby mode, 29
support
 contacting Dell, 123
 policy, 119
support.dell.com, 10
system board, 71
System Restore, 56
system setup
 about, 111
 entering, 112
 options, 113
 screens, 112

T

- technical support
 - policy, 119
- transferring information to a new computer, 28
- troubleshooting
 - Dell Diagnostics, 52
 - diagnostic lights, 49
 - Hardware Troubleshooter, 58
 - Help and Support Center, 10
 - restore to previous operating state, 56
 - tips, 33
- TV
 - connect to computer, 19-20, 64

U

- USB
 - booting to devices, 116
 - connectors, 62, 65

V

- VGA
 - connector, 64
- video
 - connector, 64
 - problems, 46
- voltage selection switch, 63
- volume
 - adjusting, 45

W

- warranty information, 9
- Windows XP
 - Device Driver Rollback, 55
 - Files and Settings Transfer Wizard, 28
 - Hardware Troubleshooter, 58
 - Help and Support Center, 10
 - Hyper-Threading, 31
 - Network Setup Wizard, 29
 - Program Compatibility Wizard, 39
 - reinstalling, 56
 - scanner, 45
 - System Restore, 56

wizards

- Files and Settings Transfer Wizard, 28
- Network Setup Wizard, 29
- Program Compatibility Wizard, 39

