

Dell Remote Access
Controller 5
Firmware Version 1.60
User's Guide



Notes and Cautions



NOTE: A NOTE indicates important information that helps you make better use of your computer.



CAUTION: A CAUTION indicates potential damage to hardware or loss of data if instructions are not followed.

Information in this publication is subject to change without notice.

© 2011 Dell Inc. All rights reserved.

Reproduction of these materials in any manner whatsoever without the written permission of Dell Inc. is strictly forbidden.

Trademarks used in this text: Dell™, the DELL logo, PowerEdge™, and OpenManage™ are trademarks of Dell Inc. Intel® is a registered trademarks of Intel Corporation in the U.S. and other countries. Microsoft®, Active Directory®, Internet Explorer®, Windows®, Windows NT®, Windows Server®, and Windows Vista® are either trademarks or registered trademarks of Microsoft Corporation in the United States and/or other countries. Red Hat Enterprise Linux® and Enterprise Linux® are registered trademarks of Red Hat, Inc. in the United States and/or other countries. Novell® is a registered trademark and SUSE™ is a trademark of Novell Inc. in the United States and other countries. UNIX® is a registered trademark of The Open Group in the United States and other countries.

Copyright 1998-2008 The OpenLDAP Foundation. All rights reserved. Redistribution and use in source and binary forms, with or without modification, are permitted only as authorized by the OpenLDAP Public License. A copy of this license is available in the file LICENSE in the top-level directory of the distribution or, alternatively, at <http://www.OpenLDAP.org/license.html>. OpenLDAP is a registered trademark of the OpenLDAP Foundation. Individual files and/or contributed packages may be copyrighted by other parties and subject to additional restrictions. This work is derived from the University of Michigan LDAP v3.3 distribution. This work also contains materials derived from public sources. Information about OpenLDAP can be obtained at <http://www.openldap.org/>. Portions Copyright 1998-2004 Kurt D. Zeilenga. Portions Copyright 1998-2004 Net Boolean Incorporated. Portions Copyright 2001-2004 IBM Corporation. All rights reserved. Redistribution and use in source and binary forms, with or without modification, are permitted only as authorized by the OpenLDAP Public License. Portions Copyright 1999-2003 Howard Y.H. Chu. Portions Copyright 1999-2003 Symas Corporation. Portions Copyright 1998-2003 Hallvard B. Furuseth. All rights reserved. Redistribution and use in source and binary forms, with or without modification, are permitted provided that this notice is preserved. The names of the copyright holders may not be used to endorse or promote products derived from this software without their specific prior written permission. This software is provided "as is" without express or implied warranty. Portions Copyright (c) 1992-1996 Regents of the University of Michigan. All rights reserved. Redistribution and use in source and binary forms are permitted provided that this notice is preserved and that due credit is given to the University of Michigan at Ann Arbor. The name of the University may not be used to endorse or promote products derived from this software without specific prior written permission. This software is provided "as is" without express or implied warranty. Other trademarks and trade names may be used in this publication to refer to either the entities claiming the marks and names or their products. Dell Inc. disclaims any proprietary interest in trademarks and trade names other than its own.

Contents

1	DRAC 5 Overview.	25
	DRAC 5 Specifications and Features	26
	DRAC 5 Specifications	26
	DRAC 5 Standard Features	29
	Other Documents You May Need	30
2	Getting Started With the DRAC 5	33
3	Basic Installation of the DRAC 5.	35
	Before You Begin	35
	Installing the DRAC 5 Hardware.	35
	Configuring Your System to Use a DRAC 5	36
	Software Installation and Configuration Overview.	37
	Installing Your DRAC 5 Software	37
	Configuring Your DRAC 5	38
	Installing the Software on the Managed System	38
	Installing the Software on the Management Station.	39
	Configuring Your Red Hat Enterprise Linux (Version 4) Management Station.	39

Installing and Removing RACADM on a Linux Management Station	40
Installing RACADM	40
Updating the DRAC 5 Firmware	40
Before You Begin	41
Downloading the DRAC 5 Firmware	41
Updating the DRAC 5 Firmware Using the Web-Based Interface.	41
Updating the DRAC 5 Firmware Using racadm	42
Updating the DRAC 5 Firmware Using Dell Update Packages for Supported Windows and Linux Operating Systems	43
Clearing the Browser Cache	43
Configuring a Supported Web Browser	43
Configuring Your Web Browser to Connect to the Web-Based Interface	43
List of Trusted Domains	44
32-bit and 64-bit Web Browsers	44
Viewing Localized Versions of the Web-Based Interface.	44
4 Advanced Configuration of the DRAC 5	47
Before You Begin.	47
Configuring DRAC 5 Properties	47
Configuring the DRAC 5 Using the Web User Interface	48
Accessing the Web-Based Interface.	48
Enabling and Configuring the Managed System to Use a Serial or Telnet Console	50

Using the connect com2 Serial Command	50
Configuring the BIOS Setup Program for a Serial Connection on the Managed System	51
Using the Remote Access Serial Interface.	51
Configuring Linux for Serial Console Redirection During Boot	52
Enabling Login to the Console After Boot	54
Enabling the DRAC 5 Serial/Telnet/SSH Console	57
Using the RACADM Command to Configure the Settings for the Serial and Telnet Console	58
Using a Serial or Telnet Console	60
Logging in to the DRAC 5	60
Starting a Text Console	60
Configuring Serial and Terminal Modes	61
Configuring IPMI and RAC Serial.	61
Configuring Terminal Mode.	63
Connecting to the Managed System Through the Local Serial Port or Telnet Management Station (Client System).	64
Connecting the DB-9 or Null Modem Cable for the Serial Console	65
Configuring the Management Station Terminal Emulation Software	65
Configuring Linux Minicom for Serial Console Emulation	66
Configuring HyperTerminal for Serial Console Redirection	67
Configuring Linux XTerm for Telnet Console Redirection	68

Enabling Microsoft Telnet for Telnet Console Redirection	69
Using a Serial or Telnet Console	70
Using the Secure Shell (SSH)	71
Configuring the DRAC 5 Network Settings	72
Accessing the DRAC 5 Through a Network	73
Configuring the DRAC 5 NIC	75
Configuring the Network and IPMI LAN Settings	75
Using RACADM Remotely	78
RACADM Synopsis	79
RACADM Options	80
Enabling and Disabling the racadm Remote Capability	80
RACADM Subcommands	81
Frequently Asked Questions About RACADM Error Messages	83
Configuring Multiple DRAC 5 Cards	83
Creating a DRAC 5 Configuration File.	85
Parsing Rules	87
Modifying the DRAC 5 IP Address	89
Configuring DRAC 5 Network Properties.	90
Frequently Asked Questions.	92

5	Adding and Configuring DRAC 5 Users	95
	Using the RACADM Utility to Configure DRAC 5 Users	100
	Before You Begin	100
	Adding a DRAC 5 User	101
	Removing a DRAC 5 User	102
	Testing e-mail Alerting	103
	Testing the RAC SNMP Trap Alert Feature	103
	Enabling a DRAC 5 User With Permissions	103
6	Using the DRAC 5 With Microsoft Active Directory	105
	Prerequisites for Enabling Active Directory Authentication for the DRAC 5.	105
	Supported Active Directory Authentication Mechanisms	106
	Standard Schema Active Directory Overview	106
	Configuring Standard Schema Active Directory to Access Your DRAC 5	108
	Configuring the DRAC 5 With Standard Schema Active Directory and Web-Based Interface.	109
	Configuring the DRAC 5 With Standard Schema Active Directory and RACADM	111
	Extended Schema Active Directory Overview	112
	Active Directory Schema Extensions	112
	Overview of the RAC Schema Extensions	113
	Active Directory Object Overview	113

Configuring Extended Schema Active Directory to Access Your DRAC 5	117
Extending the Active Directory Schema	117
Installing the Dell Extension to the Active Directory Users and Computers Snap-In.	123
Adding DRAC 5 Users and Privileges to Active Directory.	124
Configuring the DRAC 5 With Extended Schema Active Directory and Web-Based Interface.	126
Configuring the DRAC 5 With Extended Schema Active Directory and RACADM	128
Accumulating Privileges Using Extended Schema.	129
Specify Server for Active Directory Configuration.	131
Configuring and Managing Active Directory Certificates	133
Configuring Active Directory (Standard Schema and Extended Schema)	133
Uploading an Active Directory CA Certificate	137
Downloading a DRAC Server Certificate	137
Viewing an Active Directory CA Certificate	137
Enabling SSL on a Domain Controller	138
Exporting the Domain Controller Root CA Certificate to the DRAC 5	138
Importing the DRAC 5 Firmware SSL Certificate	140
Setting the SSL Time on the DRAC 5	141
Supported Active Directory Configuration	141

	Using Active Directory to Log Into the DRAC 5	142
	Using Active Directory Single Sign-On	143
	Configuring the DRAC 5 to Use Single Sign-On	143
	Logging Into the DRAC 5 Using Single Sign-On	143
	Frequently Asked Questions.	144
7	Enabling Kerberos Authentication	147
	Prerequisites for Setting up Kerberos Authentication	147
	Configuring DRAC 5 for Kerberos Authentication	150
8	Enabling Single Sign-On	151
	Prerequisites for Setting up Single Sign-On	151
	Configuring DRAC 5 to Use Single Sign-On.	151
	Logging Into DRAC 5 Using Single Sign-On.	152
9	Configuring Smart Card Authentication	153
	Configuring Smart Card Login in DRAC 5	153
	Configuring Local DRAC 5 Users for Smart Card Logon	154
	Exporting the Smart Card Certificate.	154

Configuring Active Directory Users for Smart Card Logon	155
Configuring Smart Card	155
Logging Into the DRAC 5 Using the Smart Card	157
Logging Into the DRAC 5 Using Active Directory Smart Card Authentication	158
Troubleshooting the Smart Card Logon in DRAC 5	158
10 Using GUI Console Redirection	161
Overview	161
Using Console Redirection	161
Supported Screen Resolutions	
Refresh Rates on the Managed System	162
Configuring Your Management Station.	162
Configuring Console Redirection	163
Opening a Console Redirection Session	164
Disabling or Enabling Local Video	167
Using the Video Viewer	167
Accessing the Viewer Menu Bar	168
Adjusting the Video Quality	171
Synchronizing the Mouse Pointers	172
Using Power Control Option	173
Frequently Asked Questions	173

11 Using and Configuring Virtual Media	183
Overview	183
Installing Virtual Media Browser Plug-In	185
Windows-Based Management Station	185
Linux-Based Management Station	185
Running Virtual Media	186
Supported Virtual Media Configurations	186
Running Virtual Media Using the Web User Interface	186
Attaching and Detaching the Virtual Media Feature	190
Booting From Virtual Media	192
Installing Operating Systems Using Virtual Media	193
Using Virtual Media When the Server's Operating System Is Running	193
Using Virtual Flash	194
Enabling Virtual Flash	194
Disabling Virtual Flash	194
Storing Images in a Virtual Flash	195
Configuring a Bootable Virtual Flash	195
Using the Virtual Media Command Line Interface Utility	196
Utility Installation	197
Command Line Options	197
VM-CLI Parameters	198
VM-CLI Operating System Shell Options	201
Deploying Your Operating System Using VM-CLI	202

Before You Begin	202
Remote System Requirements	202
Network Requirements	202
Creating a Bootable Image File	203
Creating an Image File for Linux Systems	203
Creating an Image File for Windows Systems	203
Preparing for Deployment	203
Configuring the Remote Systems	203
Deploying the Operating System	204
Frequently Asked Questions	205
12 Configuring Security Features	211
Security Options for the DRAC Administrator	212
Disabling the DRAC 5 Local Configuration	212
Disabling DRAC 5 Remote Virtual KVM	214
Securing DRAC 5 Communications Using SSL and Digital Certificates	215
Secure Sockets Layer (SSL)	215
Certificate Signing Request (CSR)	216
Accessing the SSL Main Menu	216
Generating a New Certificate Signing Request	218
Uploading a Server Certificate	219
Viewing a Server Certificate	220
Using the Secure Shell (SSH)	220
Configuring Services	221
Enabling Additional DRAC 5 Security Options	225

Configuring the Network Security Settings Using the DRAC 5 GUI	230
---	-----

13 Using the DRAC 5 SM-CLP Command Line Interface 233

DRAC 5 SM-CLP Support. 233

SM-CLP Features 233

Using SM-CLP	234
SM-CLP Management Operations and Targets	235
Options	235
DRAC 5 SM-CLP Examples	237
Property Names for Fan, Temperature, Numeric Voltage, Power Consumption, and Amperage Sensors.	248
Supported Property Names for Fans, Temperature, Numeric Voltage, Power Consumption, and Amperage Sensors	248
Property Names for Power Supply Sensors	251
Property Names for Intrusion, Battery, Voltage, and Hardware Performance Sensors	252
Property Names for Fan and Power Supply Redundancy Set Sensors.	254
Property Names for Chassis Sensors	254
Property Names for Power Management Service.	255
Property Names for Power Capability	256

14	Monitoring and Alert Management	257
	Configuring the Managed System to Capture the Last Crash Screen	257
	Disabling the Windows Automatic Reboot Option	258
	Configuring Platform Events	258
	Configuring Platform Event Filters (PEF)	259
	Configuring PET	261
	Configuring E-Mail Alerts	263
	Testing e-mail Alerting	265
	Testing the RAC SNMP Trap Alert Feature	265
	Frequently Asked Questions	265
15	Configuring Intelligent Platform Management Interface (IPMI)	267
	Configuring IPMI	267
	Configuring IPMI Using the Web-Based Interface	267
	Configuring IPMI Using the RACADM CLI	270
	Using the IPMI Remote Access Serial Interface	274
	Configuring Serial Over LAN	275
16	Recovering and Troubleshooting the Managed System	277
	First Steps to Troubleshoot a Remote System	277
	Managing Power on a Remote System	277

Selecting Power Control Actions from the DRAC 5 GUI	278
Viewing System Information	279
Main System Chassis	279
Remote Access Controller	280
Using the System Event Log (SEL)	281
Using the Command Line to View System Log	282
Using the POST and Operating System Boot Capture Logs	283
Viewing the Last System Crash Screen	283
17 Recovering and Troubleshooting the DRAC 5	285
Using the RAC Log	285
Using the Command Line	287
Using the Diagnostic Console	287
Using the Trace Log	288
Using the racdump	289
Using the core dump	289
18 Sensors	291
Battery Probes	291
Fan Probes	291
Chassis Intrusion Probes	291

Power Supplies Probes	292
Hardware Performance Probes	292
Power Monitoring Probes	292
Graph Information.	293
Power Consumption Information	293
Power Statistics.	294
Temperature Probes	294
Voltage Probes	294
A RACADM Subcommand Overview	295
help	295
arp	296
clearasrscreen	296
config	297
getconfig	299
coredump	302
coredumpdelete	303
fwupdate	303
getssninfo	306
getsysinfo	308
gettractime	311
ifconfig	312
netstat	312

ping	313
setniccfg	314
getniccfg	315
getsvctag	316
racdump	317
racreset	318
racresetcfg	319
serveraction	320
getraclog	321
clrraclog	323
getsel	323
clrsel	324
gettracelog	325
sslcsrgen	326
sslcertupload	328
sslcertdownload	329
sslcertview	331
sslkeyupload	333
sslresetcfg	334
krbkeytabupload	334
testemail	336

testtrap	337
vmdisconnect	339
vmkey	340
usercertupload	340
usercertview	342
localConRedirDisable	343

B DRAC 5 Property Database Group and Object Definitions 345

Displayable Characters	345
idRacInfo	345
idRacProductInfo (Read Only)	345
idRacDescriptionInfo (Read Only)	346
idRacVersionInfo (Read Only).	346
idRacBuildInfo (Read Only)	346
idRacName (Read Only)	347
idRacType (Read Only)	347
cfgLanNetworking	347
cfgDNSDomainNameFromDHCP (Read/Write)	348
cfgDNSDomainName (Read/Write).	348
cfgDNSRacName (Read/Write).	348
cfgDNSRegisterRac (Read/Write)	349
cfgDNSServersFromDHCP (Read/Write).	349
cfgDNSServer1 (Read/Write).	350
cfgDNSServer2 (Read/Write).	350
cfgNicEnable (Read/Write)	350
cfgNicIpAddress (Read/Write)	351

cfgNicNetmask (Read/Write)	351
cfgNicGateway (Read/Write)	352
cfgNicUseDhcp (Read/Write)	352
cfgNicSelection (Read/Write)	353
cfgNicMacAddress (Read Only)	353
cfgNicVlanEnable (Read/Write)	354
cfgNicVlanId (Read/Write)	354
cfgNicVlanPriority (Read/Write)	354
cfgRemoteHosts	355
cfgRhostsSmtServerIpAddr (Read/Write)	355
cfgRhostsFwUpdateTftpEnable (Read/Write)	355
cfgRhostsFwUpdateIpAddr (Read/Write)	356
cfgRhostsFwUpdatePath (Read/Write)	356
cfgUserAdmin	357
cfgUserAdminIpmiLanPrivilege (Read/Write)	357
cfgUserAdminIpmiSerialPrivilege (Read/Write)	357
cfgUserAdminPrivilege (Read/Write)	358
cfgUserAdminUserName (Read/Write)	359
cfgUserAdminPassword (Write Only)	360
cfgUserAdminEnable	360
cfgUserAdminSolEnable	360
cfgEmailAlert	361
cfgEmailAlertIndex (Read Only)	361
cfgEmailAlertEnable (Read/Write)	361
cfgEmailAlertAddress (Read Only)	362
cfgEmailAlertCustomMsg (Read Only)	362
cfgSessionManagement	362
cfgSsnMgtConsRedirMaxSessions (Read/Write)	362
cfgSsnMgtRacadmTimeout (Read/Write)	363

cfgSsnMgtWebserverTimeout (Read/Write)	363
cfgSsnMgtSshIdleTimeout (Read/Write)	364
cfgSsnMgtTelnetTimeout (Read/Write).	365
cfgSerial	365
cfgSerialBaudRate (Read/Write)	366
cfgSerialConsoleEnable (Read/Write)	366
cfgSerialConsoleQuitKey (Read/Write).	366
cfgSerialConsoleIdleTimeout (Read/Write).	367
cfgSerialConsoleNoAuth (Read/Write).	368
cfgSerialConsoleCommand (Read/Write)	368
cfgSerialHistorySize (Read/Write)	368
cfgSerialSshEnable (Read/Write).	369
cfgSerialTelnetEnable (Read/Write)	369
cfgSerialCom2RedirEnable (Read/Write).	369
cfgNetTuning	370
cfgNetTuningNicAutoneg (Read/Write)	370
cfgNetTuningNic100MB (Read/Write)	371
cfgNetTuningNicFullDuplex (Read/Write)	371
cfgNetTuningNicMtu (Read/Write)	371
cfgNetTuningTcpSrttDflt (Read/Write)	372
cfgOobSnmpp	372
cfgOobSnmppAgentCommunity (Read/Write)	372
cfgOobSnmppAgentEnable (Read/Write)	373
cfgRacTuning	373
cfgRacTunePluginType	373
cfgRacTuneHttpPort (Read/Write)	374
cfgRacTuneHttpsPort (Read/Write).	374
cfgRacTuneIpRangeEnable	374
cfgRacTuneIpRangeAddr	375

cfgRacTunelpRangeMask	375
cfgRacTunelpBlkEnable	375
cfgRacTunelpBlkFailcount	376
cfgRacTunelpBlkFailWindow.	376
cfgRacTunelpBlkPenaltyTime	377
cfgRacTuneSshPort (Read/Write)	377
cfgRacTuneTelnetPort (Read/Write)	377
cfgRacTuneRemoteRacadmEnable (Read/Write)	378
cfgRacTuneConRedirEncryptEnable (Read/Write)	378
cfgRacTuneConRedirPort (Read/Write)	378
cfgRacTuneConRedirVideoPort (Read/Write)	379
cfgRacTuneAsrEnable (Read/Write)	379
cfgRacTuneDaylightOffset (Read/Write)	380
cfgRacTuneTimezoneOffset (Read/Write)	380
cfgRacTuneWebserverEnable (Read/Write)	380
cfgRacTuneLocalServerVideo (Read/Write)	381
cfgRacTuneLocalConfigDisable	381
cfgRacTuneCtrlEConfigDisable.	382
cfgRacTuneVirtualConsoleAuthorizeMultipleSessions (Read/Write)	382
ifcRacManagedNodeOs	383
ifcRacMnOsHostname (Read/Write).	383
ifcRacMnOsOsName (Read/Write).	383
cfgRacSecurity.	384
cfgRacSecCsrCommonName (Read/Write)	384
cfgRacSecCsrOrganizationName (Read/Write)	384
cfgRacSecCsrOrganizationUnit (Read/Write)	385

cfgRacSecCsrLocalityName (Read/Write)	385
cfgRacSecCsrStateName (Read/Write)	385
cfgRacSecCsrCountryCode (Read/Write)	386
cfgRacSecCsrEmailAddr (Read/Write)	386
cfgRacSecCsrKeySize (Read/Write)	386
cfgRacVirtual	387
cfgVirMediaAttached (Read/Write)	387
cfgVirAtapiSvrPort (Read/Write)	387
cfgVirAtapiSvrPortSsl (Read/Write)	388
cfgVirMediaKeyEnable (Read/Write)	389
cfgVirMediaPluginTypr (Read/Write)	389
cfgVirtualBootOnce (Read/Write)	389
cfgFloppyEmulation (Read/Write)	390
cfgActiveDirectory	391
cfgADRacDomain (Read/Write)	391
cfgADRacName (Read/Write)	391
cfgADEnable (Read/Write)	392
cfgADAuthTimeout (Read/Write)	395
cfgADRootDomain (Read/Write)	395
cfgADType (Read/Write)	395
cfgADSSOEnable (Read/Write)	396
cfgStandardSchema	396
cfgSSADRoleGroupIndex (Read Only)	396
cfgSSADRoleGroupName (Read/Write)	396
cfgSSADRoleGroupDomain (Read/Write)	397
cfgSSADRoleGroupPrivilege (Read/Write)	397
cfgIpmiSerial	398
cfgIpmiSerialConnectionMode (Read/Write)	398
cfgIpmiSerialBaudRate (Read/Write)	399
cfgIpmiSerialChanPrivLimit (Read/Write)	399

cfgIpmiSerialFlowControl (Read/Write)	399
cfgIpmiSerialHandshakeControl (Read/Write)	400
cfgIpmiSerialLineEdit (Read/Write)	400
cfgIpmiSerialEchoControl (Read/Write)	401
cfgIpmiSerialDeleteControl (Read/Write)	401
cfgIpmiSerialNewLineSequence (Read/Write)	401
cfgIpmiSerialInputNewLineSequence (Read/Write)	402
cfgIpmiSol	402
cfgIpmiSolEnable (Read/Write).	402
cfgIpmiSolBaudRate (Read/Write)	403
cfgIpmiSolMinPrivilege (Read/Write)	403
cfgIpmiSolAccumulateInterval (Read/Write)	404
cfgIpmiSolSendThreshold (Read/Write)	404
cfgIpmiLan	404
cfgIpmiLanEnable (Read/Write)	404
cfgIpmiLanPrivLimit (Read/Write)	405
cfgIpmiLanAlertEnable (Read/Write).	405
cfgIpmiEncryptionKey (Read/Write)	406
cfgIpmiPetCommunityName (Read/Write)	406
cfgIpmiPef	406
cfgIpmiPefName (Read Only).	407
cfgIpmiPefIndex (Read Only)	407
cfgIpmiPefAction (Read/Write).	407
cfgIpmiPefEnable (Read/Write)	408
cfgIpmiPet	408
cfgIpmiPetIndex (Read/Write)	408
cfgIpmiPetAlertDestIpAddr (Read/Write)	408
cfgIpmiPetAlertEnable (Read/Write).	409

cfgLogging	409
cfgLoggingSELOEMEventFilterEnable (Read/Write)	409
C Supported RACADM Interfaces	411
Index	413

DRAC 5 Overview

The Dell Remote Access Controller 5 (DRAC 5) is a systems management hardware and software solution designed to provide remote management capabilities, crashed system recovery, and power control functions for Dell systems.

By communicating with the system's baseboard management controller (BMC), the DRAC 5 (when installed) can be configured to send you e-mail alerts for warnings or errors related to voltages, temperatures, intrusion, and fan speeds. The DRAC 5 also logs event data and the most recent crash screen (for systems running the Microsoft Windows operating system only) to help you diagnose the probable cause of a system crash.

The DRAC 5 has its own microprocessor and memory, and is powered by the system in which it is installed. The DRAC 5 may be preinstalled on your system, or available separately in a kit.

To get started with the DRAC 5, see "Getting Started With the DRAC 5" on page 33.

DRAC 5 Specifications and Features

Figure 1-1 shows the DRAC 5 hardware.

Figure 1-1. DRAC 5 Hardware Features

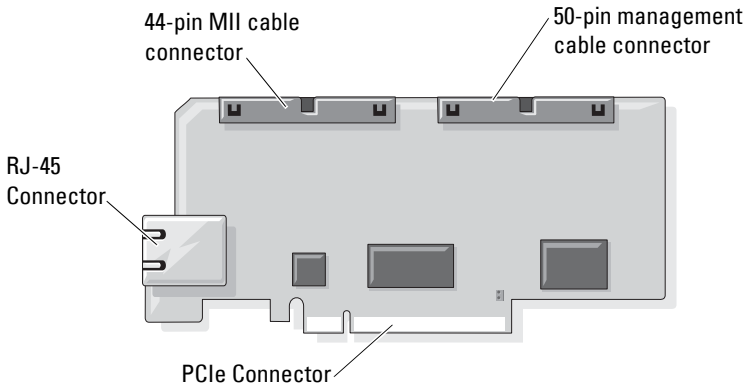

DRAC 5 Specifications

Power Specifications

Table 1-1 lists the power requirements for the DRAC 5.

Table 1-1. DRAC 5 Power Specifications

System Power
1.2 A on +3.3 V AUX (maximum)
550 mA on +3.3 V main (maximum)
0 mA on +5V main (maximum)

Connectors



NOTE: The DRAC 5 hardware installation instructions can be found in the *Installing a Remote Access Card* document or the *Installation and Troubleshooting Guide* included with your system.

The DRAC 5 includes one onboard 10/100 Mbps RJ-45 NIC, a 50-pin management cable, and a 44-pin MII cable. See Figure 1-1 for the DRAC 5 cable connectors.

The 50-pin management cable is the main interface to the DRAC that provides connectivity to USB, serial, video, and an inter-integrated circuit (I2C) bus. The 44-pin MII cable connects the DRAC NIC to the system's motherboard. The RJ-45 connector connects the DRAC NIC to an out-of-band connection when the DRAC 5 is configured in **Dedicated NIC** mode.

Depending on your requirements, you can use the management and MII cables to configure your DRAC in three separate modes. See "DRAC Modes" on page 91 for more information.

DRAC 5 Ports

Table 1-2 identifies the ports used by the DRAC 5 that listen for a server connection. Table 1-3 identifies the ports that the DRAC 5 uses as a client. This information is required when opening firewalls for remote access to a DRAC 5.

Table 1-2. DRAC 5 Server Listening Ports

Port Number	Function
22*	Secure Shell (SSH)
23*	Telnet
80*	HTTP
161	SNMP Agent
443*	HTTPS
623	RMCP/RMCP+
3668*	Virtual Media server
3669*	Virtual Media Secure Service
5900*	Console Redirection keyboard/mouse
5901*	Console Redirection video

* Configurable port

Table 1-3. DRAC 5 Client Ports

Port Number	Function
25	SMTP
53	DNS
68	DHCP-assigned IP address
69	TFTP
162	SNMP trap
636	LDAPS
3269	LDAPS for global catalog (GC)

Supported Remote Access Connections

Table 1-4 lists the connection features.

Table 1-4. Supported Remote Access Connections

Connection	Features
DRAC 5 NIC	<ul style="list-style-type: none">• 10/100 Mbps Ethernet• DHCP support• SNMP traps and e-mail event notification• Dedicated network interface for the DRAC 5 Web-based interface• Support for telnet/ssh console and RACADM CLI commands including system boot, reset, power-on, and shutdown commands
Serial port	<ul style="list-style-type: none">• Support for Serial console and RACADM CLI commands including system boot, reset, power-on, and shutdown commands• Support for text-only console redirection to a VT-100 terminal or terminal emulator

DRAC 5 Standard Features

The DRAC 5 provides the following features:

- Two-factor authentication, which is provided by the Smart Card logon. The two-factor authentication is based on what the users have (the Smart Card) and what they know (the PIN).
- User authentication through Microsoft Active Directory (optional) or hardware-stored user IDs and passwords.
- Role-based authority, which enables an administrator to configure specific privileges for each user.
- User ID and password configuration through the Web-based interface or RACADM CLI.
- Dynamic Domain Name System (DNS) registration.
- Remote system management and monitoring using a Web-based interface, serial connection, remote RACADM, or telnet connection.
- Support for Active Directory authentication — Centralizes all DRAC 5 user ID and passwords in Active Directory using Standard Schema and Extended Schema.
- Console Redirection — Provides remote system keyboard, video, and mouse functions.
- Virtual Media — Enables a managed system to access a media drive on the management station.
- Access to system event logs — Provides access to the system event log (SEL), DRAC 5 log, and last crash screen of the crashed or unresponsive system that is independent of the operating system state.
- Dell OpenManage software integration — Enables you to launch the DRAC5 Web-based interface from Dell OpenManage Server Administrator or IT Assistant.
- RAC alert — Alerts you to potential managed node issues through e-mail messages or an SNMP trap using the **Dedicated**, **Shared with Failover**, or **Shared NIC** settings.
- Local and remote configuration — Provides local and remote configuration using the RACADM command-line utility.
- Remote power management — Provides remote power management functions from a management console, such as shutdown and reset.

- IPMI support.
- Standards-based management with IPMI over LAN and SM-CLP.
- Sensors for monitoring power consumption. The DRAC 5 uses this data to depict system power consumption through charts and statistics.
- Secure Sockets Layer (SSL) encryption — Provides secure remote system management through the Web-based interface.
- Password-level security management — Prevents unauthorized access to a remote system.
- Role-based authority — Provides assignable permissions for different systems management tasks.

Other Documents You May Need

In addition to this *User's Guide*, the following documents provide additional information about the setup and operation of the DRAC 5 in your system:

- DRAC 5 online help provides information about using the Web-based interface.
- The *Dell OpenManage IT Assistant User's Guide* provide information about IT Assistant.
- The *Dell OpenManage Server Administrator's User's Guide* provides information about installing and using Server Administrator.
- The *Dell OpenManage Server Administrator SNMP Reference Guide* documents the Server Administrator SNMP management information base (MIB). The MIB defines variables that extend the standard MIB to cover the capabilities of systems management agents.
- The *Dell OpenManage Baseboard Management Controller Utilities User's Guide* provides information about configuring the Baseboard Management Controller (BMC), configuring your managed system using the BMC Management Utility, and additional BMC information.
- The *Dell Update Packages User's Guide* provides information about obtaining and using Dell Update Packages as part of your system update strategy.

- The *Dell Systems Software Support Matrix* provides information about the various Dell systems, the operating systems supported by these systems, and the Dell OpenManage components that can be installed on these systems.
- The *Glossary* on the Dell support website provides information on terms used in this document.

The following system documents are also available to provide more information about the system in which your DRAC 5 is installed:

- The safety instructions that came with your system provide important safety and regulatory information. For additional regulatory information, see the Regulatory Compliance home page at www.dell.com/regulatory_compliance. Warranty information may be included within this document or as a separate document.
- The *Rack Installation Guide* or *Rack Installation Instructions* included with your rack solution describes how to install your system into a rack.
- The *Getting Started Guide* provides an overview of system features, setting up your system, and technical specifications.
- The *Hardware Owner's Manual* provides information about system features and describes how to troubleshoot the system and install or replace system components.
- Systems management software documentation describes the features, requirements, installation, and basic operation of the software.
- Operating system documentation describes how to install (if necessary), configure, and use the operating system software.
- Documentation for any components you purchased separately provides information to configure and install these options.
- Updates are sometimes included with the system to describe changes to the system, software, and/or documentation.



NOTE: Always read the updates first because they often supersede information in other documents.

- Release notes or readme files may be included to provide last-minute updates to the system or documentation or advanced technical reference material intended for experienced users or technicians.

Getting Started With the DRAC 5

The DRAC 5 enables you to remotely monitor, troubleshoot, and repair a Dell system even when the system is down. The DRAC 5 offers a rich set of features like console redirection, virtual media, virtual KVM, Smart Card authentication, and so on.

Management station is the system from where an administrator remotely manages a Dell system that is installed with a DRAC card. The systems that are thus monitored are called managed systems.

To be able to use that DRAC card, follow these steps:

- 1 Install the DRAC 5 card in your Dell system — The DRAC 5 may be preinstalled on your system, or available separately in a kit.



NOTE: This procedure may differ for various systems. See your specific system's *Hardware Owner's Manual* on the Dell Support website at support.dell.com/manuals for precise instructions on how to perform this procedure.

You must install the DRAC 5 software on the management station as well as the managed system. Without the managed system software, you cannot use the RACADM locally, and the DRAC cannot capture the last crash screen.

- 2 Configure the DRAC 5 properties, network settings, and users — You can configure the DRAC 5 by using either the Remote Access Configuration Utility, the Web-based interface, or the RACADM.
- 3 Configure the Microsoft Active Directory to provide access to the DRAC 5, allowing you to add and control DRAC 5 user privileges to your existing users in your Active Directory software.
- 4 Configure Smart Card authentication — Smart Card provides an added level of security to your enterprise.
- 5 Configure remote access points, such as console redirection and virtual media.
- 6 Configure the security settings.

- 7** Use the standards-based management Server Management-Command Line Protocol (SM-CLP) to manage the systems on your network.
- 8** Configure alerts for efficient systems management capability.
- 9** Configure the DRAC 5 Intelligent Platform Management Interface (IPMI) settings to use the standards-based IPMI tools to manage the systems on your network.

Basic Installation of the DRAC 5

This section provides information about how to install and set up your DRAC 5 hardware and software.

Before You Begin

Gather the following items that were included with your system, prior to installing and configuring the DRAC 5 software:

- DRAC 5 hardware (currently installed or in the optional kit)
- DRAC 5 installation procedures (located in this chapter)
- *Dell Systems Management Tools and Documentation DVD*

Installing the DRAC 5 Hardware



NOTE: The DRAC 5 connection emulates a USB keyboard connection. As a result, when you restart the system, the system will not notify you if your keyboard is not attached.

The DRAC 5 may be preinstalled on your system, or available separately in a kit. To get started with the DRAC 5 that is installed on your system, see "Software Installation and Configuration Overview" on page 37.

If a DRAC 5 is not installed on your system, see the *Installing a Remote Access Card* document that is included with your DRAC 5 kit, or see your platform *Installation and Troubleshooting Guide* for hardware installation instructions.



NOTE: See the *Installation and Troubleshooting Guide* included with your system for information about removing the DRAC 5. Also, review all Microsoft Active Directory RAC properties associated with the removed DRAC 5 to ensure proper security if you are using extended schema.

Configuring Your System to Use a DRAC 5

To configure your system to use a DRAC 5, use the Dell Remote Access Configuration Utility (formerly known as the BMC Setup Module).

To run the Dell Remote Access Configuration Utility:

- 1 Turn on or restart your system.
- 2 Press <Ctrl><E> when prompted during POST.
If your operating system begins to load before you press <Ctrl><E>, allow the system to finish booting, and then restart your system and try again.
- 3 Configure the NIC.
 - a Using the down-arrow key, highlight **NIC Selection**.
 - b Using the left-arrow and right-arrow keys, select one of the following NIC selections:
 - **Dedicated** — Select this option to enable the remote access device to utilize the dedicated network interface available on the Remote Access Controller (RAC). This interface is not shared with the host operating system and routes the management traffic to a separate physical network, enabling it to be separated from the application traffic. This option is available only if a DRAC card is installed in the system.
 - **Shared** — Select this option to share the network interface with the host operating system. The remote access device network interface is fully functional when the host operating system is configured for NIC teaming. The remote access device receives data through NIC 1 and NIC 2, but transmits data only through NIC 1. If NIC 1 fails, the remote access device will not be accessible.
 - **Failover** — Select this option to share the network interface with the host operating system. The remote access device network interface is fully functional when the host operating system is configured for NIC teaming. The remote access device receives data through NIC 1 and NIC 2, but transmits data only through NIC 1. If NIC 1 fails, the remote access device fails over to NIC 2 for all data transmission. The remote access device continues to use NIC 2 for data transmission. If NIC 2 fails, the remote access device fails over all data transmission back to NIC 1.

- 4 Configure the network controller LAN parameters to use DHCP or a Static IP address source.
 - a Using the down-arrow key, select **LAN Parameters**, and press <Enter>.
 - b Using the up-arrow and down-arrow keys, select **IP Address Source**.
 - c Using the right-arrow and left-arrow keys, select **DHCP** or **Static**.
 - d If you selected **Static**, configure the **Ethernet IP Address**, **Subnet Mask**, and **Default Gateway** settings.
 - e Press <Esc>.
- 5 Press <Esc>.
- 6 Select **Save Changes and Exit**.

The system automatically reboots.



NOTE: When viewing the Web user interface on a Dell PowerEdge 1900 system that is configured with one NIC, the NIC Configuration page displays two NICs (NIC1 and NIC2). This behavior is normal. The PowerEdge 1900 system (and other Dell systems that are configured with a single LAN On Motherboard) can be configured with NIC teaming. Shared and Teamed modes work independently on these systems.

See the *Dell OpenManage Baseboard Management Controller Utilities User's Guide* for more information about the Dell Remote Access Configuration Utility.

Software Installation and Configuration Overview

This section provides a high-level overview of the DRAC 5 software installation and configuration process. Configure your DRAC 5 using the Web-based interface, RACADM CLI, or Serial/Telnet/SSH console.

For more information about the DRAC 5 software components, see "Installing the Software on the Managed System" on page 38.

Installing Your DRAC 5 Software

To install your DRAC 5 software:

- 1 Install the software on the managed system. See "Installing the Software on the Managed System" on page 38.
- 2 Install the software on the management station. See "Installing the Software on the Management Station" on page 39.

Configuring Your DRAC 5

To configure your DRAC 5:

- 1 Select one of the following configuration tools:
 - Web-based interface
 - RACADM CLI
 - Serial/Telnet/SSH console



CAUTION: Using more than one DRAC 5 configuration tool at the same time may generate unexpected results.

- 2 Configure the DRAC 5 network settings. See "Configuring DRAC 5 Properties" on page 47.
- 3 Add and configure DRAC 5 users. See "Adding and Configuring DRAC 5 Users" on page 95.
- 4 Configure the Web browser to access the Web-based interface. See "Configuring a Supported Web Browser" on page 43.
- 5 Disable the Windows Automatic Reboot Option. See "Disabling the Windows Automatic Reboot Option" on page 258.
- 6 Update the DRAC 5 Firmware. See "Connecting to the Managed System Through the Local Serial Port or Telnet Management Station (Client System)" on page 64.
- 7 Access the DRAC 5 through a network. See "Connecting to the Managed System Through the Local Serial Port or Telnet Management Station (Client System)" on page 64.

Installing the Software on the Managed System

Installing software on the managed system is optional. Without the managed system software, you cannot use the RACADM locally, and the DRAC cannot capture the last crash screen.

To install the managed system software, install the software on the managed system using the *Dell Systems Management Tools and Documentation* DVD. For instructions about how to install this software, see your *Quick Installation Guide*.

Managed system software installs your choices from the appropriate version of Dell OpenManage Server Administrator on the managed system.



NOTE: Do not install the DRAC 5 management station software and the DRAC 5 managed system software on the same system.



CAUTION: The latest DRAC firmware supports only the latest RACADM version. You may encounter errors if you use an older version of RACADM to query a DRAC with the latest firmware. Install the RACADM version shipped with your latest Dell OpenManage DVD media.

If Server Administrator is not installed on the managed system, you cannot view the system's last crash screen or use the **Auto Recovery** feature.

For more information about the last crash screen, see "Viewing the Last System Crash Screen" on page 283.

Installing the Software on the Management Station

Your system includes the Dell OpenManage Systems Management Software Kit. This kit includes, but is not limited to, the *Dell Systems Management Tools and Documentation DVD*. For information about installing Server Administrator software, see your *Server Administrator User's Guide*.

Configuring Your Red Hat Enterprise Linux (Version 4) Management Station

The Dell Digital KVM Viewer requires additional configuration to run on a Red Hat Enterprise Linux (version 4) management station. When you install the Red Hat Enterprise Linux (version 4) operating system on your management station, perform the following procedures:

- When prompted to add or remove packages, install the optional **Legacy Software Development** software. This software package includes the necessary software components to run the Dell Digital KVM viewer on your management station.
- To ensure that the Dell Digital KVM Viewer functions properly, open the following ports on your firewall:
 - Keyboard and mouse port (default is port 5900)
 - Video port (default is port 5901)

Installing and Removing RACADM on a Linux Management Station

To use the remote RACADM functions, install RACADM on a management station running Linux.



NOTE: When you run **Setup** on the *Dell Systems Management Tools and Documentation* DVD, the RACADM utility for all supported operating systems are installed on your management station.

Installing RACADM

- 1 Log on as root to the system where you want to install the management station components.
- 2 If necessary, mount the *Dell Systems Management Tools and Documentation* DVD using the following command or a similar command:

```
mount /media/cdrom
```
- 3 Navigate to the `/linux/rac` directory and execute the following command:

```
rpm -ivh *.rpm
```

For help with the RACADM command, type `racadm help` after issuing the previous commands.

Uninstalling RACADM

To uninstall RACADM, open a command prompt and type:

```
rpm -e <racadm_package_name>
```

where `<racadm_package_name>` is the rpm package that was used to install the RAC software.

For example, if the rpm package name is `srvadmin-racadm5`, then type:

```
rpm -e srvadmin-racadm5
```

Updating the DRAC 5 Firmware

Use one of the following methods to update your DRAC 5 firmware.

- Web-based Interface
- RACADM CLI
- Dell Update Packages

Before You Begin

Before you update your DRAC 5 firmware using local RACADM or the Dell Update Packages, perform the following procedures. Otherwise, the firmware update operation may fail.

- 1 Install and enable the appropriate IPMI and managed node drivers.
- 2 If your system is running a Windows operating system, enable and start the **Windows Management Instrumentation** (WMI) service.
- 3 If your system is running SUSE Linux Enterprise Server (version 10) for Intel EM64T, start the **Raw** service.
- 4 Ensure that the RAC virtual flash is unmounted or not in use by the operating system or another application or user.
- 5 Disconnect and unmount Virtual Media.
- 6 Ensure that the USB is enabled.

Downloading the DRAC 5 Firmware

To update your DRAC 5 firmware, download the latest firmware from the Dell Support website located at support.dell.com and save the file to your local system.

The following software components are included with your DRAC 5 firmware package:

- Compiled DRAC 5 firmware code and data
- Expansion ROM image
- Web-based interface, JPEG, and other user interface data files
- Default configuration files

Use the **Firmware Update** page to update the DRAC 5 firmware to the latest revision. When you run the firmware update, the update retains the current DRAC 5 settings.

Updating the DRAC 5 Firmware Using the Web-Based Interface

- 1 Open the Web-based interface and login to the remote system.
See "Accessing the Web-Based Interface" on page 48.
- 2 In the **System** tree, click **Remote Access** and click the **Update** tab.

- 3 In the **Firmware Update** page in the **Firmware Image** field, type the path to the firmware image that you downloaded from support.dell.com or click **Browse** to navigate to the image.



NOTE: If you are running Firefox, the text cursor does not appear in the **Firmware Image** field.

For example:

```
C:\Updates\V1.0\image_name.
```

The default firmware image name is **firring.d5**.

- 4 Click **Update**.

The update may take several minutes to complete. When completed, a dialog box appears.

- 5 Click **OK** to close the session and automatically log out.
- 6 After the DRAC 5 resets, click **Log In** to log in to the DRAC 5.

Updating the DRAC 5 Firmware Using racadm

You can update the DRAC 5 firmware using the CLI-based racadm tool. If you have installed Server Administrator on the managed system, use local racadm to update the firmware.

- 1 Download the DRAC 5 firmware image from the Dell Support website at support.dell.com to the managed system.

For example:

```
C:\downloads\firring.d5
```

- 2 Run the following racadm command:

```
racadm -pud c:\downloads\
```

You can also update the firmware using remote racadm.

For example:

```
racadm -r <DRAC5 IP address> U <username> -p  
<password> fwupdate -p -u -d <path>
```

where *path* is the location where you saved **firring.d5** on the managed system.

Updating the DRAC 5 Firmware Using Dell Update Packages for Supported Windows and Linux Operating Systems

Download and run the Dell Update Packages for supported Windows and Linux operating systems from Dell Support website at support.dell.com. See the *Dell Update Package User's Guide* for more information.

Clearing the Browser Cache

After the firmware upgrade, clear the Web browser cache. See your Web browser's online help for more information.

Configuring a Supported Web Browser

The following sections provide instructions for configuring the supported Web browsers. For a list of supported Web browsers, see the *Dell Systems Software Support Matrix* on the Dell Support website at support.dell.com/manuals.

Configuring Your Web Browser to Connect to the Web-Based Interface

If you are connecting to the DRAC 5 Web-based interface from a management station that connects to the Internet through a proxy server, you must configure the Web browser to access the Internet from this server.

To configure your Internet Explorer Web browser to access a proxy server:

- 1 Open a Web browser window.
- 2 Click **Tools**, and click **Internet Options**.
- 3 From the **Internet Options** window, click the **Connections** tab.
- 4 Under **Local Area Network (LAN)** settings, click **LAN Settings**.
- 5 If the **Use a proxy server** box is selected, select the **Bypass proxy server for local addresses** box.
- 6 Click **OK** twice.

List of Trusted Domains

When you access the DRAC 5 Web-based interface through the Web browser, you are prompted to add the DRAC 5 IP address to the list of trusted domains if the IP address is missing from the list. When completed, click Refresh or relaunch the Web browser to reestablish a connection to the DRAC 5 Web-based interface.

32-bit and 64-bit Web Browsers

The DRAC 5 Web-based interface is not supported on 64-bit Web browsers. If you open a 64-bit Browser, access the Console Redirection page, and attempt to install the plug-in, the installation procedure fails. If this error was not acknowledged and you repeat this procedure, the Console Redirect Page loads even though the plug-in installation fails during your first attempt. This issue occurs because the Web browser stores the plug-in information in the profile directory even though the plug-in installation procedure failed. To fix this issue, install and run a supported 32-bit Web browser and log in to the DRAC 5.

Viewing Localized Versions of the Web-Based Interface

Windows

The DRAC 5 Web-based interface is supported on the following Windows operating system languages:

- English
- French
- German
- Spanish
- Japanese
- Simplified Chinese

To view a localized version of the DRAC 5 Web-based interface in Internet Explorer:

- 1 Click the **Tools** menu and select **Internet Options**.
- 2 In the **Internet Options** window, click **Languages**.
- 3 In the **Language Preference** window, click **Add**.

- 4 In the **Add Language** window, select a supported language.
To select more than one language, press <Ctrl>.
- 5 Select your preferred language and click **Move Up** to move the language to the top of the list.
- 6 Click **OK**.
- 7 In the **Language Preference** window, click **OK**.

Linux

If you are running Console Redirection on a Red Hat Enterprise Linux (version 4) client with a Simplified Chinese GUI, the viewer menu and title may appear in random characters. This issue is caused by an incorrect encoding in the Red Hat Enterprise Linux (version 4) Simplified Chinese operating system. To fix this issue, access and modify the current encoding settings by performing the following steps:

- 1 Open a command terminal.
- 2 Type “locale” and press <Enter>. The following output appears.

```
LANG=zh_CN.UTF-8
LC_CTYPE="zh_CN.UTF-8"
LC_NUMERIC="zh_CN.UTF-8"
LC_TIME="zh_CN.UTF-8"
LC_COLLATE="zh_CN.UTF-8"
LC_MONETARY="zh_CN.UTF-8"
LC_MESSAGES="zh_CN.UTF-8"
LC_PAPER="zh_CN.UTF-8"
LC_NAME="zh_CN.UTF-8"
LC_ADDRESS="zh_CN.UTF-8"
LC_TELEPHONE="zh_CN.UTF-8"
LC_MEASUREMENT="zh_CN.UTF-8"
LC_IDENTIFICATION="zh_CN.UTF-8"
LC_ALL=
```

- 3 If the values include “zh_CN.UTF-8”, no changes are required. If the values do not include “zh_CN.UTF-8”, go to step 4.
- 4 Navigate to the /etc/sysconfig/i18n file.

- 5** In the file, apply the following changes:

Current entry:

```
LANG="zh_CN.GB18030"  
SUPPORTED="zh_CN.GB18030:zh_CN.GB2312:zh_CN:zh"
```

Updated entry:

```
LANG="zh_CN.UTF-8"  
SUPPORTED="zh_CN.UTF-8:zh_CN.GB18030:zh_CN.GB2312:zh_CN:zh"
```

- 6** Log out and then login to the operating system.
- 7** Relaunch the DRAC 5.

When you switch from any other language to the Simplified Chinese language, ensure that this fix is still valid. If not, repeat this procedure.

For advanced configurations of the DRAC 5, see "Advanced Configuration of the DRAC 5" on page 47.

Advanced Configuration of the DRAC 5

This section provides information about advanced DRAC 5 configuration and is recommended for users with advanced knowledge of systems management and who want to customize the DRAC environment to suit their specific needs.

Before You Begin

You should have completed the basic installation and setup of your DRAC 5 hardware and software. See "Basic Installation of the DRAC 5" on page 35 for more information.

Configuring DRAC 5 Properties

You can configure the DRAC 5 properties (network, users, and so on) by using either the Web-based interface or the RACADM.

The DRAC 5 provides a Web-based interface and RACADM (a command-line interface) that enables you to configure the DRAC 5 properties and users, perform remote management tasks, and troubleshoot a remote (managed) system for problems. For everyday systems management, use the DRAC 5 Web-based interface. This chapter provides information about how to perform common systems management tasks with the DRAC 5 Web-based interface and provides links to related information.

All Web-based interface configuration tasks can also be performed with RACADM.

Configuring the DRAC 5 Using the Web User Interface

See your DRAC 5 online help for context sensitive information about each Web-based interface page.

Accessing the Web-Based Interface

To access the DRAC 5 Web-based interface:

- 1 Open a supported Web browser window.

For a list of supported Web browsers, see the *Dell Systems Software Support Matrix* on the Dell Support website at support.dell.com/manuals.

- 2 In the Address field, type the following and press <Enter>:

`https://<IP address>`

If the default HTTPS port number (port 443) has been changed, type:

`https://<IP address>:<port number>`

where *IP address* is the IP address for the DRAC 5 and *port number* is the HTTPS port number.

The DRAC 5 Log in window appears.



NOTE: When you use Internet Explorer version 6 SP2 or version 7 to log into the DRAC 5 Web GUI and the client is on a private network, but without access to the Internet, you may experience a delay of up to 30 seconds. To resolve this issue:

1. Disable the phishing filter.

`https://phishingfilter.microsoft.com/faq.aspx`.

2. Disable CRL fetching:

- a. Click **Tools**→**Options**→**Advanced** tab→**Security**.
- b. Deselect **Check for publisher's certificate revocation**.

Logging In

You can log in either as a DRAC 5 user or as a Microsoft Active Directory user. The default user name and password are **root** and **calvin**, respectively.

Before you log in to the DRAC 5, verify that you have **Log In to DRAC 5** permission. Speak to your organization's DRAC or network administrator to confirm your access privileges.

To log in:

- 1 In the **User Name** field, type one of the following:

- Your DRAC 5 user name.

For example, *<username>*

The DRAC 5 user name for local users is case sensitive

- Your Active Directory user name.

For example, *<domain>\<username>*, *<domain>/<username>*, or *<user>@<domain>*.

Examples of an Active Directory user name are: **dell.com\john_doe** or **john_doe@dell.com**.

The Active Directory user name is not case sensitive.

- 2 In the **Password** field, type your DRAC 5 user password or Active Directory user password.

This field is case sensitive.

- 3 Click **OK** or press **<Enter>**.

Logging Out

- 1 In the upper-right corner of the DRAC 5 Web-based interface window, click **Log Out** to close the session.
- 2 Close the browser window.



NOTE: The **Log Out** button does not appear until you log in.



NOTE: Closing the browser without gracefully logging out causes the session to remain open until it times out. It is strongly recommended that you click the logout button to end the session; otherwise, the session remains active until the session timeout is reached.



NOTE: Closing the DRAC 5 Web-based interface within Microsoft Internet Explorer using the close button ("x") at the top right corner of the window may generate an application error. To fix this issue, download the latest Cumulative Security Update for Internet Explorer from the Microsoft Support website, at support.microsoft.com.

Enabling and Configuring the Managed System to Use a Serial or Telnet Console

The following subsections provide information about how to enable and configure a serial/telnet/ssh console on the managed system.

Using the `connect com2` Serial Command

When using the `connect com2` serial command, ensure that the following are configured properly:

- The **Serial Communication**→**Serial Port** setting in the **BIOS Setup** program.
- The DRAC configuration settings.

When a telnet session is established to the DRAC 5 and these settings are incorrect, `connect com2` may display a blank screen.

Configuring the BIOS Setup Program for a Serial Connection on the Managed System

Perform the following steps to configure your BIOS Setup program to redirect output to a serial port.



NOTE: You must configure the **System Setup** program in conjunction with the **connect com2** command.

- 1 Turn on or restart your system.
- 2 Press <F2> immediately after you see the following message:
<F2> = System Setup
- 3 Scroll down and select **Serial Communication** by pressing <Enter>.
- 4 Set the **Serial Communication** screen as follows:
External Serial Connector — Remote Access Device
Redirection After Boot — Disabled
- 5 Press <Esc> to exit the System Setup program to complete the System Setup program configuration.

Using the Remote Access Serial Interface

When establishing a serial connection to the RAC device, the following interfaces are available:

- IPMI serial interface. See "Using the IPMI Remote Access Serial Interface" on page 274.
- RAC serial interface

RAC Serial Interface

RAC also supports a serial console interface (or *RAC Serial Console*) that provides a RAC CLI, which is not defined by IPMI. If your system includes a RAC card with **Serial Console** enabled, the RAC card will override the IPMI serial settings and display the RAC CLI serial interface.

To enable the RAC serial terminal interface, set the `cfgSerialConsoleEnable` property to 1 (TRUE).

For example:

```
racadm config -g cfgSerial -o cfgSerialConsoleEnable 1
```

See "cfgSerialConsoleEnable (Read/Write)" on page 366 for more information.

Table 4-1 provides the serial interface settings.

Table 4-1. Serial Interface Settings

IPMI Mode	RAC Serial Console	Interface
Basic	Disabled	Basic Mode
Basic	Enabled	RAC CLI
Terminal	Disabled	IPMI Terminal Mode
Terminal	Enabled	RAC CLI

Configuring Linux for Serial Console Redirection During Boot

The following steps are specific to the Linux GRand Unified Bootloader (GRUB). Similar changes would be necessary if you use a different boot loader.



NOTE: When you configure the client VT100 emulation window, set the window or application that is displaying the redirected console to 25 rows x 80 columns to ensure proper text display; otherwise, some text screens may be garbled.

Edit the `/etc/grub.conf` file as follows:

- 1 Locate the General Setting sections in the file and add the following two new lines:

```
serial --unit=1 --speed=57600  
terminal --timeout=10 serial
```
- 2 Append two options to the kernel line:

```
kernel ..... console=ttyS1,57600
```
- 3 If the `/etc/grub.conf` contains a `splashimage` directive, comment it out.

Table 4-2 provides a sample `/etc/grub.conf` file that shows the changes described in this procedure.

Table 4-2. Sample File: /etc/grub.conf

```
# grub.conf generated by anaconda
#
# Note that you do not have to rerun grub after
making changes
# to this file
# NOTICE: You do not have a /boot partition. This
means that
#         all kernel and initrd paths are relative
to /, e.g.
#         root (hd0,0)
#         kernel /boot/vmlinuz-version ro root=
/dev/sdal
#         initrd /boot/initrd-version.img
#
#boot=/dev/sda
default=0
timeout=10
#splashimage=(hd0,2)/grub/splash.xpm.gz

serial --unit=1 --speed=57600
terminal --timeout=10 serial

title Red Hat Linux Advanced Server (2.4.9-e.3smp)
    root (hd0,0)
    kernel /boot/vmlinuz-2.4.9-e.3smp ro root=
/dev/sdal hda=ide-scsi console=ttyS0 console=
ttyS1,57600
    initrd /boot/initrd-2.4.9-e.3smp.img
title Red Hat Linux Advanced Server-up (2.4.9-e.3)
    root (hd0,00)
    kernel /boot/vmlinuz-2.4.9-e.3 ro root=/dev/sdal s
    initrd /boot/initrd-2.4.9-e.3.im
```

When you edit the `/etc/grub.conf` file, use the following guidelines:

- 1 Disable GRUB's graphical interface and use the text-based interface; otherwise, the GRUB screen will not be displayed in RAC console redirection. To disable the graphical interface, comment out the line starting with `splashimage`.
- 2 To enable multiple GRUB options to start console sessions through the RAC serial connection, add the following line to all options:

```
console=ttyS1,57600
```

Table 4-2 shows `console=ttyS1,57600` added to only the first option.

Enabling Login to the Console After Boot

Edit the file `/etc/inittab` as follows:

Add a new line to configure `agetty` on the COM2 serial port:

```
co:2345:respawn:/sbin/agetty -h -L 57600 ttyS1 ansi
```

Table 4-3 shows a sample file with the new line.

Table 4-3. Sample File: /etc/inittab

```
#
# inittab This file describes how the INIT process
should set up
#         the system in a certain run-level.
#
# Author:  Miquel van Smoorenburg
#         Modified for RHS Linux by Marc Ewing and
Donnie Barnes
#
# Default runlevel. The runlevels used by RHS are:
#  0 - halt (Do NOT set initdefault to this)
#  1 - Single user mode
#  2 - Multiuser, without NFS (The same as 3, if you
do not have
#     networking)
#  3 - Full multiuser mode
#  4 - unused
#  5 - X11
#  6 - reboot (Do NOT set initdefault to this)
#
id:3:initdefault:

# System initialization.
si::sysinit:/etc/rc.d/rc.sysinit

l0:0:wait:/etc/rc.d/rc 0
l1:1:wait:/etc/rc.d/rc 1
l2:2:wait:/etc/rc.d/rc 2
l3:3:wait:/etc/rc.d/rc 3
l4:4:wait:/etc/rc.d/rc 4
l5:5:wait:/etc/rc.d/rc 5
l6:6:wait:/etc/rc.d/rc 6
```

Table 4-3. Sample File: /etc/inittab (continued)

```
# Things to run in every runlevel.
ud::once:/sbin/update

# Trap CTRL-ALT-DELETE
ca::ctrlaltdel:/sbin/shutdown -t3 -r now

# When our UPS tells us power has failed, assume we
# have a few
# minutes of power left. Schedule a shutdown for 2
# minutes from now.
# This does, of course, assume you have power
# installed and your
# UPS is connected and working correctly.
pf::powerfail:/sbin/shutdown -f -h +2 "Power Failure;
System Shutting Down"
# If power was restored before the shutdown kicked
# in, cancel it.
pr:12345:powerokwait:/sbin/shutdown -c "Power
Restored; Shutdown Cancelled"

# Run gettys in standard runlevels
co:2345:respawn:/sbin/agetty -h -L 57600 ttyS1 ansi
1:2345:respawn:/sbin/mingetty tty1
2:2345:respawn:/sbin/mingetty tty2
3:2345:respawn:/sbin/mingetty tty3
4:2345:respawn:/sbin/mingetty tty4
5:2345:respawn:/sbin/mingetty tty5
6:2345:respawn:/sbin/mingetty tty6

# Run xdm in runlevel 5
# xdm is now a separate service
x:5:respawn:/etc/X11/prefdm -nodaemon
```

Edit the file `/etc/securetty` as follows:

Add a new line with the name of the serial tty for COM2:

```
ttyS1
```

Table 4-4 shows a sample file with the new line.

Table 4-4. Sample File: /etc/securetty

```
vc/1
vc/2
vc/3
vc/4
vc/5
vc/6
vc/7
vc/8
vc/9
vc/10
vc/11
tty1
tty2
tty3
tty4
tty5
tty6
tty7
tty8
tty9
tty10
tty11
ttys1
```

Enabling the DRAC 5 Serial/Telnet/SSH Console

The serial/telnet/ssh console can be enabled locally or remotely.

Enabling the Serial/Telnet/SSH Console Locally



NOTE: You (the current user) must have **Configure DRAC 5** permission in order to perform the steps in this section.

To enable the serial/telnet/ssh console from the managed system, type the following local RACADM commands from a command prompt:

```
racadm config -g cfgSerial -o cfgSerialConsoleEnable 1
racadm config -g cfgSerial -o cfgSerialTelnetEnable 1
racadm config -g cfgSerial -o cfgSerialSshEnable 1
```

Enabling the Serial/Telnet/SSH Console Remotely

To enable the serial/telnet/ssh console remotely, type the following remote RACADM commands from a command prompt:

```
racadm -u <username> -p <password> -r <DRAC 5 IP  
address> config -g cfgSerial -o cfgSerialConsoleEnable 1  
racadm -u <username> -p <password> -r <DRAC 5 IP  
address> config -g cfgSerial -o cfgSerialTelnetEnable 1  
racadm -u <username> -p <password> -r <DRAC 5 IP  
address> config -g cfgSerial -o cfgSerialSshEnable 1
```



NOTE: When you use Internet Explorer version 6 SP2 or version 7 to log into a managed system on a private network, but without access to the Internet, you may experience a delay of up to 30 seconds while using remote RACADM commands.

Using the RACADM Command to Configure the Settings for the Serial and Telnet Console

This subsection provides steps to configure the default configuration settings for serial/telnet/ssh console redirection.

To configure the settings, type the RACADM **config** command with the appropriate group, property, and property value(s) for the setting that you want to configure.

You can type RACADM commands locally or remotely. When using RACADM commands remotely, you must include the user name, password, and managed system DRAC 5 IP address.

Using RACADM Locally

To type RACADM commands locally, type the following command from a command prompt on the managed system:

```
racadm config -g <group> -o <property> <value>
```

To view a list of properties, type the following command from a command prompt on the managed system:

```
racadm getconfig -g <group>
```

Using RACADM Remotely

To use RACADM commands remotely, type the following command from a command prompt on a management station:

```
racadm -u <username> -p <password> -r <DRAC 5  
IP address> config -g <group> -o <property> <value>
```

Ensure that your web server is configured with a DRAC 5 card before you use RACADM remotely. Otherwise, RACADM times out and the following message appears:

```
Unable to connect to RAC at specified IP address.
```

To enable your web server using Secure Shell (SSH), telnet or local RACADM, type the following command from a command prompt on a management station:

```
racadm config -g cfgRacTuning -o  
cfgRacTuneWebServerEnable 1
```

Displaying Configuration Settings

Table 4-5 provides the actions and related commands to display your configuration settings. To run the commands, open a command prompt on the managed system, type the command, and press <Enter>.

Table 4-5. Displaying Configuration Settings

Action	Command
List the available groups.	<pre>racadm getconfig -h</pre>
Display the current settings for a particular group.	<pre>racadm getconfig -g <group></pre> <p>For example, to display a list of all cfgSerial group settings, type the following command:</p> <pre>racadm getconfig -g cfgSerial</pre>
Display the current settings for a particular group remotely.	<pre>racadm -u <user> -p <password> -r <DRAC 5 IP address> getconfig -g cfgSerial</pre> <p>For example, to display a list of all of the settings for the cfgSerial group remotely, type:</p> <pre>racadm -u root -p calvin -r 192.168.0.1 getconfig -g cfgSerial</pre>

Configuring the Telnet Port Number

Type the following command to change the telnet port number on the DRAC 5.

```
racadm config -g cfgRacTuning -o cfgRacTuneTelnetPort  
<new port number>
```

Using a Serial or Telnet Console

You can run the serial commands in Table 4-19 remotely using RACADM or from the serial/telnet/ssh console command prompt.

Logging in to the DRAC 5

After you have configured your management station terminal emulator software and managed node BIOS, perform the following steps to log into the DRAC 5:

- 1 Connect to the DRAC 5 using your management station terminal emulation software.
- 2 Type your DRAC 5 user name and press <Enter>. You are logged into the DRAC 5.

Starting a Text Console

After you have logged into the DRAC 5 through your management station terminal software with telnet or SSH, you can redirect the managed system text console by using **connect com2**, which is a telnet/SSH command. Only one **connect com2** client is supported at a time.

To connect to the managed system text console, open a DRAC 5 command prompt (displayed through a telnet or SSH session) and type:

```
connect com2
```

From a serial session, you can connect to the managed system's serial console by pressing <Esc><Shift><Q>, which connects the managed system's serial port directly to the servers' COM2 port and bypasses the DRAC 5.

To reconnect the DRAC 5 to the serial port, press <Esc><Shift><9>.

The managed node COM2 port and the DRAC 5 serial port baud rates must be identical.

The `connect -h com2` command displays the contents of the serial history buffer before waiting for input from the keyboard or new characters from the serial port.

 **NOTE:** When using the `-h` option, the client and server terminal emulation type (ANSI or VT100) must be identical; otherwise, the output may be garbled. Additionally, set the client terminal row to **25**.

The default (and maximum) size of the history buffer is 8192 characters. You can set this number to a smaller value using the command:

```
racadm config -g cfgSerial -o cfgSerialHistorySize <number>
```

Configuring Serial and Terminal Modes

Configuring IPMI and RAC Serial

- 1 Expand the System tree and click **Remote Access**.
- 2 Click the **Configuration** tab and then click **Serial**.
- 3 Configure the IPMI serial settings.
See Table 4-6 for description of the IPMI serial settings.
- 4 Configure the RAC serial settings.
See Table 4-7 for description of the RAC serial settings.
- 5 Click **Apply Changes**.
- 6 Click the appropriate **Serial Configuration** page button to continue.
See Table 4-8 for description of the serial configuration page settings.

Table 4-6. IPMI Serial Settings

Setting	Description
Connection Mode Setting	<ul style="list-style-type: none">• Direct Connect Basic Mode - IPMI Serial Basic Mode• Direct Connect Terminal Mode - IPMI Serial Terminal Mode
Baud Rate	Sets the data speed rate. Select 9600 bps, 19.2 kbps, 57.6 kbps, or 115.2 kbps.

Table 4-6. IPMI Serial Settings (continued)

Setting	Description
Flow Control	<ul style="list-style-type: none"> • None — Hardware Flow Control Off • RTS/CTS — Hardware Flow Control On
Channel Privilege Level Limit	<ul style="list-style-type: none"> • Administrator • Operator • User

Table 4-7. RAC Serial Settings

Setting	Description
Enabled	Enables or disables the RAC serial console. Checked= Enabled; Unchecked=Disabled
Maximum Sessions	The maximum number of simultaneous sessions allowed for this system.
Timeout	The maximum number of seconds of line idle time before the line is disconnected. The range is 60 to 1920 seconds. Default is 300 seconds. Use 0 seconds to disable the Timeout feature.
Redirect Enabled	Enables or disables Console Redirection. Checked= Enabled; Unchecked=Disabled
Baud Rate	The data speed on the external serial port. Values are 9600 bps, 28.8 kbps, 57.6 kbps, and 115.2 kbps. Default is 57.6 kbps.
Escape Key	Specifies the <Esc> key. The default are the ^\ characters.
History Buffer Size	The size of the serial history buffer, which holds the last characters written to the console. The maximum and default = 8192 characters.
Login Command	The DRAC command line to be executed upon valid login.

Table 4-8. Serial Configuration Page Settings

Button	Description
Print	Print the Serial Configuration page.
Refresh	Refresh the Serial Configuration page.
Apply Changes	Apply the IPMI and RAC serial changes.
Terminal Mode Settings	Opens the Terminal Mode Settings page.

Configuring Terminal Mode

- 1 Expand the System tree and click Remote Access.
- 2 Click the Configuration tab and then click Serial.
- 3 In the Serial Configuration page, click Terminal Mode Settings.
- 4 Configure the terminal mode settings.
See Table 4-9 for description of the terminal mode settings.
- 5 Click Apply Changes.
- 6 Click the appropriate Terminal Mode Settings page button to continue.
See Table 4-10 for description of the terminal mode settings page buttons.

Table 4-9. Terminal Mode Settings

Setting	Description
Line Editing	Enables or disables line editing.
Delete Control	Select one of the following: <ul style="list-style-type: none"> • BMC outputs a <bkspace><space><bkspace> character when <bkspace> or is received — • BMC outputs a character when <bkspace> or is received —
Echo Control	Enables or disables echo.
Handshaking Control	Enables or disables handshaking.
New Line Sequence	Select None, <CR-LF>, <NULL>, <CR>, <LF-CR>, or <LF>.
Input New Line Sequence	Select <CR> or <NULL>.

Table 4-10. Terminal Mode Settings Page Buttons

Button	Description
Print	Print the Terminal Mode Settings page.
Refresh	Refresh the Terminal Mode Settings page.
Go Back to Serial Port Configuration	Return to the Serial Port Configuration page.
Apply Changes	Apply the terminal mode settings changes.

Connecting to the Managed System Through the Local Serial Port or Telnet Management Station (Client System)

The managed system provides access between the DRAC 5 and the serial port on your system to enable you to power on, power off, or reset the managed system, and access logs.

The serial console is available on the DRAC 5 through the managed system external serial connector. Only one serial client system (management station) may be active at any given time. The telnet and SSH consoles are available on the DRAC 5 through the DRAC modes (see "DRAC Modes" on page 91). Up to four telnet client systems and four SSH clients may connect at any given time. The management station connection to the managed system serial or telnet console requires management station terminal emulation software. See "Configuring the Management Station Terminal Emulation Software" on page 65 for more information.

The following subsections explain how to connect your management station to the managed system using the following methods:

- A managed system external serial port using terminal software and a DB-9 or a null modem cable
- A telnet connection using terminal software through the managed system DRAC 5 NIC or the shared, teamed NIC

Connecting the DB-9 or Null Modem Cable for the Serial Console

To access the managed system using a serial text console, connect a DB-9 null modem cable to the COM port on the managed system. Not all DB-9 cables carry the pinout/signals necessary for this connection. The DB-9 cable for this connection must conform to the specification shown in Table 4-11.



NOTE: The DB-9 cable can also be used for BIOS text console redirection.

Table 4-11. Required Pinout for DB-9 Null Modem Cable

Signal Name	DB-9 Pin (server pin)	DB-9 Pin (workstation pin)
FG (Frame Ground)	–	–
TD (Transmit data)	3	2
RD (Receive Data)	2	3
RTS (Request To Send)	7	8
CTS (Clear To Send)	8	7
SG (Signal Ground)	5	5
DSR (Data Set Ready)	6	4
CD (Carrier Detect)	1	4
DTR (Data Terminal Ready)	4	1 and 6

Configuring the Management Station Terminal Emulation Software

Your DRAC 5 supports a serial or telnet text console from a management station running one of the following types of terminal emulation software:

- Linux Minicom in an Xterm
- Hilgraeve’s HyperTerminal Private Edition (version 6.3)
- Linux Telnet in an Xterm
- Microsoft Telnet

Perform the steps in the following subsections to configure your type of terminal software. If you are using Microsoft Telnet, configuration is not required.

Configuring Linux Minicom for Serial Console Emulation

Minicom is the serial port access utility for Linux. The following steps are valid for configuring Minicom version 2.0. Other Minicom versions may differ slightly but require the same basic settings. Use the information in "Required Minicom Settings for Serial Console Emulation" on page 67 to configure other versions of Minicom.

Configuring Minicom Version 2.0 for Serial Console Emulation



NOTE: To ensure that the text displays properly, Dell recommends that you use an Xterm window to display the telnet console instead of the default console provided by the Linux installation.

- 1 To start a new Xterm session, type `xterm &` at the command prompt.
- 2 In the Xterm window, move your mouse arrow to the lower right-hand corner of the window and resize the window to 80 x 25.
- 3 If you do not have a Minicom configuration file, go to the next step.
If you have a Minicom configuration file, type `minicom <Minicom config file name>` and skip to step 17.
- 4 At the Xterm command prompt, type `minicom -s`.
- 5 Select **Serial Port Setup** and press <Enter>.
- 6 Press <a> and select the appropriate serial device (for example, `/dev/ttyS0`).
- 7 Press <e> and set the **Bps/Par/Bits** option to **57600 8N1**.
- 8 Press <f> and set **Hardware Flow Control** to **Yes** and set **Software Flow Control** to **No**.
- 9 To exit the **Serial Port Setup** menu, press <Enter>.
- 10 Select **Modem and Dialing** and press <Enter>.
- 11 In the **Modem Dialing and Parameter Setup** menu, press <Backspace> to clear the **init**, **reset**, **connect**, and **hangup** settings so that they are blank.
- 12 Press <Enter> to save each blank value.
- 13 When all specified fields are clear, press <Enter> to exit the **Modem Dialing and Parameter Setup** menu.
- 14 Select **Save setup as config_name** and press <Enter>.
- 15 Select **Exit From Minicom** and press <Enter>.

- 16 At the command shell prompt, type `minicom <Minicom config file name>`.
- 17 To expand the Minicom window to 80 x 25, drag the corner of the window.
- 18 Press `<Ctrl+a>`, `<z>`, `<x>` to exit Minicom.



NOTE: If you are using Minicom for serial text console redirection to configure the managed system BIOS, it is recommended to turn on color in Minicom. To turn on color, type the following command: `minicom -c on`

Ensure that the Minicom window displays a command prompt such as `[DRAC 5\root]#`. When the command prompt appears, your connection is successful and you are ready to connect to the managed system console using the `connect` serial command.

Required Minicom Settings for Serial Console Emulation

Use Table 4-12 to configure any version of Minicom.

Table 4-12. Minicom Settings for Serial Console Emulation

Setting Description	Required Setting
Bps/Par/Bits	57600 8N1
Hardware flow control	Yes
Software flow control	No
Terminal emulation	ANSI
Modem dialing and parameter settings	Clear the <code>init</code> , <code>reset</code> , <code>connect</code> , and <code>hangup</code> settings so that they are blank
Window size	80 x 25 (to resize, drag the corner of the window)

Configuring HyperTerminal for Serial Console Redirection

HyperTerminal is the Microsoft Windows serial port access utility. To set the size of your console screen appropriately, use Hilgraeve’s HyperTerminal Private Edition version 6.3.

To configure HyperTerminal for serial console redirection:

- 1 Start the HyperTerminal program.
- 2 Type a name for the new connection and click **OK**.

- 3 Next to **Connect using:**, select the COM port on the management station (for example, COM2) to which you have connected the DB-9 null modem cable and click **OK**.
- 4 Configure the COM port settings as shown in Table 4-13.
- 5 Click **OK**.
- 6 Click **File** → **Properties**, and then click the **Settings** tab.
- 7 Set the **Telnet terminal ID:** to **ANSI**.
- 8 Click **Terminal Setup** and set **Screen Rows** to **26**.
- 9 Set **Columns** to **80** and click **OK**.

Table 4-13. Management Station COM Port Settings

Setting Description	Required Setting
Bits per second	57600
Data bits	8
Parity	None
Stop bits	1
Flow control	Hardware

The HyperTerminal window displays a command prompt such as [DRAC 5\root]#. When the command prompt appears, your connection is successful and you are ready to connect to the managed system console using the `connect com2` serial command.

Configuring Linux XTerm for Telnet Console Redirection

Use the following guidelines when performing the steps in this section:

- When you are using the `connect com2` command through a telnet console to display the System Setup screens, set the terminal type to **ANSI** in System Setup and for the telnet session.
- To ensure that the text is properly displayed, Dell recommends that you use an Xterm window to display the telnet console instead of the default console provided by the Linux installation.

To run telnet with Linux:

- 1 Start a new Xterm session.
At the command prompt, type `xterm &`
- 2 Click on the lower right-hand corner of the XTerm window and resize the window to 80 x 25.
- 3 Connect to the DRAC 5 in the managed system.
At the Xterm prompt, type `telnet <DRAC 5 IP address>`

Enabling Microsoft Telnet for Telnet Console Redirection



NOTE: Some telnet clients on Microsoft operating systems may not display the BIOS setup screen correctly when BIOS console redirection is set for VT100 emulation. If this issue occurs, update the display by changing BIOS console redirection to ANSI mode. To perform this procedure in the BIOS setup menu, select **Console Redirection** → **Remote Terminal Type** → **ANSI**.

- 1 Enable Telnet in Windows Component Services.
- 2 Connect to the DRAC 5 in the management station.
Open a command prompt, type the following, and press <Enter>:

```
telnet <IP address>:<port number>
```

where *IP address* is the IP address for the DRAC 5 and *port number* is the telnet port number (if you are using a new port).

Configuring the Backspace Key For Your Telnet Session

Depending on the telnet client, using the <Backspace> key may produce unexpected results. For example, the session may echo ^h. However, most Microsoft and Linux telnet clients can be configured to use the <Backspace> key.

To configure Microsoft telnet clients to use the <Backspace> key:

- 1 Open a command prompt window (if required).
- 2 If you are not running a telnet session, type:
`telnet`
If you are running a telnet session, press <Ctrl><]>.

- 3 At the prompt, type:

```
set bsasdel
```

The following message appears:

```
Backspace will be sent as delete.
```

To configure a Linux telnet session to use the <Backspace> key:

- 1 Open a command prompt and type:

```
stty erase ^h
```

- 2 At the prompt, type:

```
telnet
```

Using a Serial or Telnet Console

Serial and telnet commands, and RACADM CLI can be typed in a serial or telnet console and executed on the server locally or remotely. The local RACADM CLI is installed for use by a root user only.

Running Telnet Using Windows XP or Windows 2003

If your management station is running Windows XP or Windows 2003, you may experience an issue with the characters in a DRAC 5 telnet session. This issue may occur as a frozen login where the return key does not respond and the password prompt does not appear.

To fix this issue, download hotfix 824810 from the Microsoft Support website at support.microsoft.com. See Microsoft Knowledge Base article 824810 for more information.

Running Telnet Using Windows 2000

If your management station is running Windows 2000, you cannot access BIOS setup by pressing the <F2> key. To fix this issue, use the telnet client supplied with the Windows Services for UNIX 3.5—a recommended free download from Microsoft. Go to www.microsoft.com/downloads/ and search for *Windows Services for UNIX 3.5*.

Using the Secure Shell (SSH)

It is critical that your system's devices and device management are secure. Embedded connected devices are the core of many business processes. If these devices are compromised, your business may be at risk, which requires new security demands for command line interface (CLI) device management software.

Secure Shell (SSH) is a command line session that includes the same capabilities as a telnet session, but with improved security. The DRAC 5 supports SSH version 2 with password authentication. SSH is enabled on the DRAC 5 when you install or update your DRAC 5 firmware.

You can use either PuTTY or OpenSSH on the management station to connect to the managed system's DRAC 5. When an error occurs during the login procedure, the secure shell client issues an error message. The message text is dependent on the client and is not controlled by the DRAC 5.



NOTE: OpenSSH should be run from a VT100 or ANSI terminal emulator on Windows. Running OpenSSH at the Windows command prompt does not result in full functionality (that is, some keys do not respond and no graphics are displayed).

Only four SSH sessions are supported at any given time. The session time-out is controlled by the `cfgSsnMgtSshIdleTimeout` property as described in the "DRAC 5 Property Database Group and Object Definitions" on page 345.

To enable the SSH on the DRAC 5, type:

```
racadm config -g cfgSerial -o cfgSerialSshEnable 1
```

To change the SSH port, type:

```
racadm config -g cfgRacTuning -o cfgRacTuneSshPort  
<port number>
```

For more information on `cfgSerialSshEnable` and `cfgRacTuneSshPort` properties, see "DRAC 5 Property Database Group and Object Definitions" on page 345.

The DRAC 5 SSH implementation supports multiple cryptography schemes, as shown in Table 4-14.

Table 4-14. Cryptography Schemes

Scheme Type	Scheme
Asymmetric Cryptography	Diffie-Hellman DSA/DSS 512-1024 (random) bits per NIST specification
Symmetric Cryptography	<ul style="list-style-type: none">• AES256-CBC• RIJNDAEL256-CBC• AES192-CBC• RIJNDAEL192-CBC• AES128-CBC• RIJNDAEL128-CBC• BLOWFISH-128-CBC• 3DES-192-CBC• ARCFOUR-128
Message Integrity	<ul style="list-style-type: none">• HMAC-SHA1-160• HMAC-SHA1-96• HMAC-MD5-128• HMAC-MD5-96
Authentication	<ul style="list-style-type: none">• Password

 **NOTE:** SSHv1 is not supported.

Configuring the DRAC 5 Network Settings

 **CAUTION:** Changing your DRAC 5 Network settings may disconnect your current network connection.

Configure the DRAC 5 network settings using one of the following tools:

- Web-based Interface — See "Configuring the DRAC 5 NIC" on page 75
- RACADM CLI — See "cfgLanNetworking" on page 347
- Dell Remote Access Configuration Utility — See "Configuring Your System to Use a DRAC 5" on page 36

 **NOTE:** If you are deploying the DRAC 5 in a Linux environment, see "Installing RACADM" on page 40.

Accessing the DRAC 5 Through a Network

After you configure the DRAC 5, you can remotely access the managed system using one of the following interfaces:

- Web-based interface
- RACADM
- Telnet Console
- SSH
- IPMI

Table 4-15 describes each DRAC 5 interface.

Table 4-15. DRAC 5 Interfaces

Interface	Description
Web-based interface	<p>Provides remote access to the DRAC 5 using a graphical user interface. The Web-based interface is built into the DRAC 5 firmware and is accessed through the NIC interface from a supported Web browser on the management station.</p> <p>For a list of supported Web browsers, see the <i>Dell Systems Software Support Matrix</i> on the Dell Support website at support.dell.com/manuals.</p>
RACADM	<p>Provides remote access to the DRAC 5 using a command line interface. RACADM uses the managed system's IP address to execute RACADM commands (racadm remote capability option [-r]).</p> <p>NOTE: The racadm remote capability is supported only on management stations.</p> <p>NOTE: When using the racadm remote capability, you must have write permission on the folders where you are using the racadm subcommands involving file operations, for example:</p> <pre>racadm getconfig -f <file name></pre> <p>or:</p> <pre>racadm sslcertupload -t 1 -f c:\cert\cert.txt subcommands</pre>

Table 4-15. DRAC 5 Interfaces (continued)

Interface	Description
Telnet Console	Provides access through the DRAC 5 to the server RAC port and hardware management interfaces through the DRAC 5 NIC and provides support for serial and RACADM commands including powerdown , powerup , powercycle , and hardreset commands. NOTE: Telnet is an unsecure protocol that transmits all data—including passwords—in plain text. When transmitting sensitive information, use the SSH interface.
SSH Interface	Provides the same capabilities as the telnet console using an encrypted transport layer for higher security.
IPMI Interface	Provides access through the DRAC 5 to the remote system's basic management features. The interface includes IPMI over LAN, IPMI over Serial, and Serial over LAN. See the <i>Dell OpenManage Baseboard Management Controller User's Guide</i> for more information.



NOTE: The DRAC 5 default user name is `root` and the default password is `calvin`.

You can access the DRAC 5 Web-based interface through the DRAC 5 NIC by using a supported Web browser, or through Server Administrator or IT Assistant.

For a list of supported Web browsers, see the *Dell Systems Software Support Matrix* on the Dell Support website at support.dell.com/manuals.

To access the DRAC 5 remote access interface using Server Administrator, launch Server Administrator. From the system tree on the left pane of the Server Administrator home page, click **System** → **Main System Chassis** → **Remote Access Controller**. For more information, see your Server Administrator User's Guide.

Configuring the DRAC 5 NIC

Configuring the Network and IPMI LAN Settings

 **NOTE:** You must have **Configure DRAC 5** permission to perform the following steps.

 **NOTE:** Most DHCP servers require a server to store a client identifier token in its reservations table. The client (DRAC 5, for example) must provide this token during DHCP negotiation. For RACs, the DRAC 5 supplies the client identifier option using a one-byte interface number (0) followed by a six-byte MAC address.

 **NOTE:** If your managed system DRAC is configured in **Shared** or **Shared with Failover** mode and the DRAC is connected to a switch with Spanning Tree Protocol (STP) enabled, network clients will experience a 20-30 second delay in connectivity when the management station's LOM link state changes during the STP convergence.

- 1 In the System tree, click **Remote Access**.
- 2 Click the **Configuration** tab and then click **Network**.
- 3 In the **Network Configuration** page, configure the DRAC 5 NIC settings. Table 4-16 and Table 4-17 describes the **Network Settings** and **IPMI Settings** on the **Network Configuration** page.
- 4 When completed, click **Apply Changes**.
- 5 Click the appropriate **Network Configuration** page button to continue. See Table 4-18.

Table 4-16. Network Settings

Setting	Description
NIC Selection	Displays the selected NIC mode (Dedicated , Shared with Failover , or Shared). The default setting is Dedicated .
MAC Address	Displays the DRAC 5 MAC address.
Enable NIC	Enables the DRAC 5 NIC and activates the remaining controls in this group. The default setting is Enabled .

Table 4-16. Network Settings (continued)

Setting	Description
Use DHCP (For NIC IP Address)	Enables Dell OpenManage Server Administrator to obtain the DRAC 5 NIC IP address from the Dynamic Host Configuration Protocol (DHCP) server. Selecting the check box deactivates the Static IP Address , Static Gateway , and Static Subnet Mask controls. The default setting is Disabled .
Static IP Address	Specifies or edits the static IP address for the DRAC 5 NIC. To change this setting, deselect the Use DHCP (For NIC IP Address) check box.
Static Gateway	Specifies or edits the static gateway for the DRAC 5 NIC. To change this setting, deselect the Use DHCP (For NIC IP Address) check box.
Static Subnet Mask	Specifies or edits the static subnet mask for the DRAC 5 NIC. To change this setting, deselect the Use DHCP (For NIC IP Address) check box.
Use DHCP to obtain DNS server addresses	Obtains the primary and secondary DNS server addresses from the DHCP server instead of the static settings. The default setting is Disabled .
Static Preferred DNS Server	Uses the primary DNS server IP address only when Use DHCP to obtain DNS server addresses is not selected .
Static Alternate DNS Server	Uses the secondary DNS server IP address when Use DHCP to obtain DNS server addresses is not selected . You may enter an IP address of 0.0.0.0 if you do not have an alternate DNS server.
Register DRAC on DNS	Registers the DRAC 5 name on the DNS server. The default setting is Disabled .
DNS DRAC Name	Displays the DRAC 5 name only when Register DRAC 5 on DNS is selected. The default DRAC 5 name is <i>RAC-service tag</i> , where <i>service tag</i> is the service tag number of the Dell server (for example, RAC-EK00002).
Use DHCP for DNS Domain Name	Uses the default DNS domain name. When the box is not selected and the Register DRAC 5 on DNS option is selected, you can modify the DNS domain name in the DNS Domain Name field. The default setting is Disabled .

Table 4-16. Network Settings (continued)

Setting	Description
DNS Domain Name	The default DNS domain name is MYDOMAIN . When the Use DHCP for DNS Domain Name check box is selected, this option is grayed out and you cannot modify this field.
Auto Negotiation	Determines whether the DRAC 5 automatically sets the Duplex Mode and Network Speed by communicating with the nearest router or hub (On) or allows you to set the Duplex Mode and Network Speed manually (Off).
Network Speed	Sets the network speed to 100 Mb or 10 Mb to match your network environment. This option is not available if Auto Negotiation is set to On .
Duplex Mode	Sets the duplex mode to full or half to match your network environment. This option is not available if Auto Negotiation is set to On .

Table 4-17. IPMI LAN Settings

Setting	Description
Enable IPMI Over LAN	Enables the IPMI LAN channel.
Channel Privilege Level Limit	Configures the user's maximum privilege level that can be accepted on the LAN channel. Select one of the following options: Administrator, Operator, or User.
Encryption Key	Configures the encryption key character format: 0 to 20 hexadecimal characters (no blanks allowed). The default setting is 00000000000000000000.
Enable VLAN ID	Enables the VLAN ID. If enabled, only matched VLAN ID traffic is accepted.
VLAN ID	The VLAN ID field of 802.1g fields.
Priority	The Priority field of 802.1g fields.

Table 4-18. Network Configuration Page Buttons

Button	Description
Print	Prints the Network Configuration page
Refresh	Reloads the Network Configuration page
Advanced Settings	Displays the Network Security page.
Apply Changes	Saves the changes made to the network configuration. NOTE: Changes to the NIC IP address settings will close all user sessions and require users to reconnect to the DRAC 5 Web-based interface using the updated IP address settings. All other changes will require the NIC to be reset, which may cause a brief loss in connectivity.

See "Configuring the Network Security Settings Using the DRAC 5 GUI" on page 230 for more information.

Using RACADM Remotely



NOTE: Configure the IP address on your DRAC 5 before using the `racadm` remote capability. For more information about setting up your DRAC 5 and a list of related documents, see "Basic Installation of the DRAC 5" on page 35.

RACADM provides a remote capability option (`-r`) that allows you to connect to the managed system and execute `racadm` subcommands from a remote console or management station. To use the remote capability, you need a valid user name (`-u` option) and password (`-p` option), and the DRAC 5 IP address.



NOTE: If the system from where you are accessing the remote system does not have a DRAC certificate in its default certificate store, a message is displayed when you type a `racadm` command.

```
Security Alert: Certificate is invalid - Name on
Certificate is invalid or does not match site name

Continuing execution. Use -S option for racadm to
stop the execution on certificate-related errors.
```

racadm continues to execute the command. However, if you use the `-S` option, racadm stops executing the command and displays the following message:

```
Security Alert: Certificate is invalid - Name on
Certificate is invalid or does not match site name
```

```
Racadm not continuing execution of the command.
```

```
EORROR: Unable to connect to RAC at specified
IP address
```

 **NOTE:** The racadm remote capability is supported only on management stations. For more information, see the Dell Systems Software Support Matrix on the Dell Support website at support.dell.com/manuals for more information.

 **NOTE:** When using the racadm remote capability, you must have write permissions on the folders where you are using the racadm subcommands involving file operations, for example:

```
racadm getconfig -f <file name>
```

or

```
racadm sslcertupload -t 1 -f c:\cert\cert.txt
subcommands
```

RACADM Synopsis

```
racadm -r <RAC IP Address> -u <username> -p <password>
<subcommand> <subcommand options>
```

```
racadm -i -r <RAC IP Address> <subcommand> <subcommand
options>
```

For example:

```
racadm -r 192.168.0.120 -u root -p calvin getsysinfo
```

```
racadm -i -r 192.168.0.120 getsysinfo
```

If the HTTPS port number of the RAC has been changed to a custom port other than the default port (443), the following syntax must be used:

```
racadm -r <RAC IP Address>:<port> -u <username> -p
<password> <subcommand> <subcommand options>
```

```
racadm -i -r <RAC IP Address>:<port> <subcommand>
<subcommand options>
```

RACADM Options

Table 4-19 lists the options for the **racadm** command.

Table 4-19. racadm Command Options

Option	Description
-r <racIpAddr>	Specifies the controller's remote IP address.
-r <racIpAddr>:<port number>	Use :<port number> if the DRAC 5 port number is not the default port (443)
-i	Instructs racadm to interactively query the user for user name and password.
-u <usrName>	Specifies the user name that is used to authenticate the command transaction. If the -u option is used, the -p option must be used, and the -i option (interactive) is not allowed.
-p <password>	Specifies the password used to authenticate the command transaction. If the -p option is used, the -i option is not allowed.
-S	Specifies that racadm should check for invalid certificate errors. racadm stops the execution of the command with an error message if it detects an invalid certificate.

Enabling and Disabling the racadm Remote Capability



NOTE: It is recommended that you run these commands on your local system.

The **racadm** remote capability is enabled by default. If disabled, type the following **racadm** command to enable:

```
racadm config -g cfgRacTuning -o  
cfgRacTuneRemoteRacadmEnable 1
```

To disable the remote capability, type:

```
racadm config -g cfgRacTuning -o  
cfgRacTuneRemoteRacadmEnable 0
```

RACADM Subcommands

Table 4-20 provides a description of each **racadm** subcommand that you can run in RACADM. For a detailed listing of **racadm** subcommands including syntax and valid entries, see "RACADM Subcommand Overview" on page 295.

When entering a RACADM subcommand, prefix the command with **racadm**. For example:

```
racadm help
```

Table 4-20. RACADM Subcommands

Command	Description
help	Lists DRAC 5 subcommands.
help <i><subcommand></i>	Lists usage statement for the specified subcommand.
arp	Displays the contents of the ARP table. ARP table entries may not be added or deleted.
clearasrscreen	Clears the last ASR (crash) screen (last blue screen).
clrraclog	Clears the DRAC 5 log. A single entry is made to indicate the user and time that the log was cleared.
config	Configures the RAC.
getconfig	Displays the current RAC configuration properties.
coredump	Displays the last DRAC 5 coredump.
coredumpdelete	Deletes the coredump stored in the DRAC 5.
fwupdate	Executes or displays status on DRAC 5 firmware updates.
getssninfo	Displays information about active sessions.
getsysinfo	Displays general DRAC 5 and system information.
gettractime	Displays the DRAC 5 time.
ifconfig	Displays the current RAC IP configuration.
netstat	Displays the routing table and the current connections.
ping	Verifies that the destination IP address is reachable from the DRAC 5 with the current routing-table contents.
setniccfg	Sets the IP configuration for the controller.
getniccfg	Displays the current IP configuration for the controller.

Table 4-20. RACADM Subcommands (continued)

Command	Description
getsvctag	Displays service tags.
racdump	Dumps DRAC 5 status and state information for debug.
racreset	Resets the DRAC 5.
racresetcfg	Resets the DRAC 5 to the default configuration.
serveraction	Performs power management operations on the managed system.
getraclog	Displays the RAC log.
clrsl	Clears the System Event Log entries.
gettracelog	Displays the DRAC 5 trace log. If used with <code>-i</code> , the command displays the number of entries in the DRAC 5 trace log.
sslsrsgen	Generates and downloads the SSL CSR.
sslcertupload	Uploads a CA certificate or server certificate to the DRAC 5.
sslcertdownload	Downloads a CA certificate.
sslcertview	Views a CA certificate or server certificate in the DRAC 5.
sslresetcfg	Restores the web-server certificate to factory default and restarts the web-server.
testemail	Forces the DRAC 5 to send a test e-mail over the DRAC 5 NIC to check the e-mail configuration.
testtrap	Forces the DRAC 5 to send a test SNMP trap over the DRAC 5 NIC to check the trap configuration.
vmdisconnect	Forces a virtual media connection to close.
vmkey	Resets the virtual flash size to its default size (16 MB).

Frequently Asked Questions About RACADM Error Messages

After performing a DRAC 5 reset (using the `racadm racreset` command), I issue a command and the following message is displayed:

```
racadm <command name> Transport: ERROR: (RC=-1)
```

What does this message mean?

You must wait until the DRAC 5 completes the reset before issuing another command.

When I use the `racadm` commands and subcommands, I get errors that I don't understand.

You may encounter one or more of the following errors when using the `racadm` commands and subcommands:

- Local `racadm` error messages — Problems such as syntax, typographical errors, and incorrect names.
- Remote `racadm` error messages—Problems such as incorrect IP Address, incorrect username, or incorrect password.

When I ping the DRAC IP address from my system and then switch my DRAC 5 card between Dedicated and Shared modes during the ping response, I do not receive a response.

Clear the ARP table on your system.

Configuring Multiple DRAC 5 Cards

Using RACADM, you can configure one or more DRAC 5 cards with identical properties. When you query a specific DRAC 5 card using its group ID and object ID, RACADM creates the `racadm.cfg` configuration file from the retrieved information. By exporting the file to one or more DRAC 5 cards, you can configure your controllers with identical properties in a minimal amount of time.



NOTE: Some configuration files contain unique DRAC 5 information (such as the static IP address) that must be modified before you export the file to other DRAC 5 cards.

To configure multiple DRAC 5 cards, perform the following procedures:

- 1 Use RACADM to query the target DRAC 5 that contains the appropriate configuration.



NOTE: The generated **.cfg** file does not contain user passwords.

Open a command prompt and type:

```
racadm getconfig -f myfile.cfg
```



NOTE: Redirecting the RAC configuration to a file using **getconfig -f** is only supported with the local and remote RACADM interfaces.

- 2 Modify the configuration file using a simple text editor (optional).
- 3 Use the new configuration file to modify a target RAC.

In the command prompt, type:

```
racadm config -f myfile.cfg
```

- 4 Reset the target RAC that was configured.

In the command prompt, type:

```
racadm reset
```

The **getconfig -f racadm.cfg** subcommand requests the DRAC 5 configuration and generates the **racadm.cfg** file. If required, you can configure the file with another name.

You can use the **getconfig** command to enable you to perform the following actions:

- Display all configuration properties in a group (specified by group name and index)
- Display all configuration properties for a user by user name

The **config** subcommand loads the information into other DRAC 5s. Use **config** to synchronize the user and password database with Server Administrator

The initial configuration file, `racadm.cfg`, is named by the user. In the following example, the configuration file is named `myfile.cfg`. To create this file, type the following at the command prompt:

```
racadm getconfig -f myfile.cfg
```

 **CAUTION:** It is recommended that you edit this file with a simple text editor. The `racadm` utility uses an ASCII text parser, which does not recognize any kind of formatting and can corrupt the RACADM database.

Creating a DRAC 5 Configuration File

The DRAC 5 configuration file `<filename>.cfg` is used with the `racadm config -f <filename>.cfg` command. You can use the configuration file to build a configuration file (similar to an `.ini` file) and configure the DRAC 5 from this file. You may use any file name, and the file does not require a `.cfg` extension (although it is referred to by that extension name in this subsection).

The `.cfg` file can be:

- Created
- Obtained from a `racadm getconfig -f <filename>.cfg` command
- Obtained from a `racadm getconfig -f <filename>.cfg` command, and then edited

 **NOTE:** See "getconfig" on page 299 for information about the `getconfig` command.

The `.cfg` file is first parsed to verify that valid group and object names are present and that some simple syntax rules are being followed. Errors are flagged with the line number that detected the error, and a simple message explains the problem. The entire file is parsed for correctness, and all errors are displayed. Write commands are not transmitted to the DRAC 5 if an error is found in the `.cfg` file. The user must correct *all* errors before any configuration can take place. The `-c` option may be used in the `config` subcommand, which verifies syntax only and does *not* perform a write operation to the DRAC 5.

Use the following guidelines when you create a `.cfg` file:

- If the parser encounters an indexed group, it is the value of the anchored object that differentiates the various indexes.

The parser reads in all of the indexes from the DRAC 5 for that group. Any objects within that group are simple modifications when the DRAC 5 is configured. If a modified object represents a new index, the index is created on the DRAC 5 during configuration.

- You cannot specify an index of your choice in a `.cfg` file.

Indexes may be created and deleted, so over time the group may become fragmented with used and unused indexes. If an index is present, it is modified. If an index is not present, the first available index is used. This method allows flexibility when adding indexed entries where you do not need to make exact index matches between all the RACs being managed. New users are added to the first available index. A `.cfg` file that parses and runs correctly on one DRAC 5 may not run correctly on another if all indexes are full and you must add a new user.

- Use the `racresetcfg` subcommand to configure all DRAC 5 cards with identical properties.

Use the `racresetcfg` subcommand to reset the DRAC 5 to original defaults, and then run the `racadm config -f <filename>.cfg` command. Ensure that the `.cfg` file includes all required objects, users, indexes, and other parameters.



CAUTION: Use the `racresetcfg` subcommand to reset the database and the DRAC 5 NIC settings to the original default settings and remove all users and user configurations. While the root user is available, other users' settings are also reset to the default settings.

Parsing Rules

- All lines that start with '#' are treated as comments.

A comment line *must* start in column one. A '#' character in any other column is treated as a '#' character.

Some modem parameters may include # characters in its string. An escape character is not required. You may want to generate a .cfg from a racadm getconfig -f <filename>.cfg command, and then perform a racadm config -f <filename>.cfg command to a different DRAC 5, without adding escape characters.

Example:

```
#
# This is a comment
[cfgUserAdmin]
cfgUserAdminPageModemInitString=<Modem init # not
a comment>
```

- All group entries must be surrounded by "[" and "]" characters.

The starting "[" character denoting a group name *must* start in column one. This group name *must* be specified before any of the objects in that group. Objects that do not include an associated group name generate an error. The configuration data is organized into groups as defined in "DRAC 5 Property Database Group and Object Definitions" on page 345.

The following example displays a group name, object, and the object's property value.

Example:

```
[cfgLanNetworking] -{group name}
cfgNicIpAddress=143.154.133.121 {object name}
```

- All parameters are specified as "object=value" pairs with no white space between the object, =, or value.

White spaces that are included after the value are ignored. A white space inside a value string remains unmodified. Any character to the right of the '=' is taken as is (for example, a second '=', or a '#', '[',]', and so forth). These characters are valid modem chat script characters.

See the example in the previous bullet.

- The .cfg parser ignores an index object entry.

You *cannot* specify which index is used. If the index already exists, it is either used or the new entry is created in the first available index for that group.

The `racadm getconfig -f <filename>.cfg` command places a comment in front of index objects, allowing the user to see the included comments.



NOTE: You may create an indexed group manually using the following command:
`racadm config -g <groupName> -o <anchored object> -i <index 1-16> <unique anchor name>`

- The line for an indexed group *cannot* be deleted from a .cfg file.

You must remove an indexed object manually using the following command:

```
racadm config -g <groupName> -o <objectName> -i <index 1-16> ""
```



NOTE: A NULL string (identified by two "" characters) directs the DRAC 5 to delete the index for the specified group.

To view the contents of an indexed group, use the following command:

```
racadm getconfig -g <groupName> -i <index 1-16>
```

- For indexed groups the object anchor *must* be the first object after the "[]" pair. The following are examples of the current indexed groups:

```
[cfgUserAdmin]
```

```
cfgUserAdminUserName=<USER_NAME>
```

If you type `racadm getconfig -f <myexample>.cfg`, the command builds a `.cfg` file for the current DRAC 5 configuration. This configuration file can be used as an example and as a starting point for your unique `.cfg` file.

Modifying the DRAC 5 IP Address

When you modify the DRAC 5 IP address in the configuration file, remove all unnecessary `<variable>=value` entries. Only the actual variable group's label with "[" and "]" remains, including the two `<variable>=value` entries pertaining to the IP address change.

For example:

```
#
#   Object Group "cfgLanNetworking"
#
[cfgLanNetworking]
cfgNicIpAddress=10.35.10.110
cfgNicGateway=10.35.10.1
```

This file will be updated as follows:

```
#
#   Object Group "cfgLanNetworking"
#
[cfgLanNetworking]
cfgNicIpAddress=10.35.9.143
# comment, the rest of this line is ignored
cfgNicGateway=10.35.9.1
```

The command `racadm config -f myfile.cfg` parses the file and identifies any errors by line number. A correct file will update the proper entries. Additionally, you can use the same `getconfig` command from the previous example to confirm the update.

Use this file to download company-wide changes or to configure new systems over the network.



NOTE: "Anchor" is an internal term and should not be used in the file.

Configuring DRAC 5 Network Properties

To generate a list of available network properties, type the following:

```
racadm getconfig -g cfgLanNetworking
```

To use DHCP to obtain an IP address, use the following command to write the object `cfgNicUseDhcp` and enable this feature:

```
racadm config -g cfgLanNetworking -o cfgNicUseDHCP 1
```

The commands provide the same configuration functionality as the option ROM at boot-up when you are prompted to type `<Ctrl><e>`. For more information about configuring network properties with the option ROM, see "Configuring DRAC 5 Network Properties" on page 90.

The following is an example of how the command may be used to configure desired LAN network properties.

```
racadm config -g cfgLanNetworking -o cfgNicEnable 1
racadm config -g cfgLanNetworking -o cfgNicIpAddress
192.168.0.120
racadm config -g cfgLanNetworking -o cfgNicNetmask
255.255.255.0
racadm config -g cfgLanNetworking -o cfgNicGateway
192.168.0.120
racadm config -g cfgLanNetworking -o cfgNicUseDHCP 0
racadm config -g cfgLanNetworking -o
cfgDNSServersFromDHCP 0
racadm config -g cfgLanNetworking -o cfgDNSServer1
192.168.0.5
racadm config -g cfgLanNetworking -o cfgDNSServer2
192.168.0.6
racadm config -g cfgLanNetworking -o
cfgDNSRegisterRac 1
```

```
racadm config -g cfgLanNetworking -o cfgDNSRacName  
RAC-EK00002
```

```
racadm config -g cfgLanNetworking -o  
cfgDNSDomainNameFromDHCP 0
```

```
racadm config -g cfgLanNetworking -o cfgDNSDomainName  
MYDOMAIN
```

 **NOTE:** If `cfgNicEnable` is set to **0**, the DRAC 5 LAN is disabled even if DHCP is enabled.

DRAC Modes

The DRAC 5 can be configured in one of three modes:

- Dedicated
- Shared
- Shared with failover

Table 4-21 provides a description of each mode.

Table 4-21. DRAC 5 NIC Configurations

Mode	Description
Dedicated	The DRAC uses its own NIC (RJ-45 connector) and the BMC MAC address for network traffic.
Shared	The DRAC uses Broadcom LOM1 on the planar.
Shared with failover	The DRAC uses Broadcom LOM1 and LOM2 as a team for failover. The team uses the BMC MAC address.

Frequently Asked Questions

When accessing the DRAC 5 Web-based interface, I get a security warning stating the hostname of the SSL certificate does not match the hostname of the DRAC 5.

The DRAC 5 includes a default DRAC 5 server certificate to ensure network security for the Web-based interface and remote racadm features. When this certificate is used, the Web browser displays a security warning because the default certificate is issued to **DRAC 5 default certificate** which does not match the host name of the DRAC 5 (for example, the IP address).

To address this security concern, upload a DRAC 5 server certificate issued to the IP address of the DRAC 5. When generating the certificate signing request (CSR) to be used for issuing the certificate, ensure that the common name (CN) of the CSR matches the IP address of the DRAC 5 (for example, 192.168.0.120) or the registered DNS DRAC name.

To ensure that the CSR matches the registered DNS DRAC name:

- 1** In the **System** tree, click **Remote Access**.
- 2** Click the **Configuration** tab and then click **Network**.
- 3** In the **Network Settings** page:
 - a** Select the **Register DRAC on DNS** check box.
 - b** In the **DNS DRAC Name** field, enter the DRAC name.
- 4** Click **Apply Changes**.

See "Securing DRAC 5 Communications Using SSL and Digital Certificates" on page 215 for more information about generating CSRs and issuing certificates.

Why are the remote racadm and Web-based services unavailable after a property change?

It may take a while for the remote RACADM services and the Web-based interface to become available after the DRAC 5 Web server resets.

The DRAC 5 Web server is reset after the following occurrences:

- When the network configuration or network security properties are changed using the DRAC 5 Web user interface
- When the **cfgRacTuneHttpsPort** property is changed (including when a config -f <config file> changes it)

- When `racresetcfg` is used
- When the DRAC 5 is reset
- When a new SSL server certificate is uploaded

Why doesn't my DNS server register my DRAC 5?

Some DNS servers only register names of 31 characters or fewer.

When accessing the DRAC 5 Web-based interface, I get a security warning stating the SSL certificate was issued by a certificate authority (CA) that is not trusted.

DRAC 5 includes a default DRAC 5 server certificate to ensure network security for the Web-based interface and remote `racadm` features. This certificate was not issued by a trusted CA. To address this security concern, upload a DRAC 5 server certificate issued by a trusted CA (for example, Thawte or Verisign). See "Securing DRAC 5 Communications Using SSL and Digital Certificates" on page 215 for more information about issuing certificates.

Adding and Configuring DRAC 5 Users

To manage your system with the DRAC 5 and maintain system security, create unique users with specific administrative permissions (or *role-based authority*). For additional security, you can also configure alerts that are e-mailed to specific users when a specific system event occurs.

To add and configure DRAC 5 users:



NOTE: You must have Configure DRAC 5 permission to perform the following steps.

- 1 Expand the **System** tree and click **Remote Access**.
- 2 Click the **Configuration** tab and then click **Users**.

The **Users** page appears, which includes each user's **State**, **User Name**, **RAC Privilege**, **IPMI LAN Privilege**, **IPMI Serial Privilege** and **Serial Over LAN**.

- 3 In the **User ID** column, click a user ID number.
- 4 On the **User Main Menu** page, you can configure users, upload a user certificate, view an existing user certificate, upload a trusted certification authority (CA) certificate, or view a trusted CA certificate.

If you select **Configure User** and click **Next**, the **User Configuration** page is displayed. See step 5 for more information.

See Table 5-1 if you select the options under the **Smart Card Configuration** section.

- 5 In the **User Configuration** page, configure the user's properties and privileges.

Table 5-2 describes the **General** settings for configuring a new or existing DRAC user name and password.

Table 5-3 describes the **IPMI User Privileges** for configuring the user's LAN privileges.

Table 5-4 describes the **User Group Permissions** for the **IPMI User Privileges** and the **DRAC User Privileges** settings.

Table 5-5 describes the **DRAC Group** permissions. If you add a **DRAC User Privilege** to the **Administrator**, **Power User**, or **Guest User**, the **DRAC Group** will change to the **Custom** group.

- 6 When completed, click **Apply Changes**.
- 7 Click the appropriate **User Configuration** page button to continue. See Table 5-6.

Table 5-1. Options in the Smart Card Configuration section

Option	Description
Upload User Certificate	Enables you to upload the user certificate to DRAC and import it to the user profile.
View User Certificate	Displays the user certificate page that has been uploaded to the DRAC.
Upload Trusted CA Certificate	Enables you to upload the trusted CA certificate to DRAC and import it to the user profile.
View Trusted CA Certificate	Displays the trusted CA certificate that has been uploaded to the DRAC. The trusted CA certificate is issued by the CA who is authorized to issue certificates to users.

Table 5-2. General Properties

Property	Description
User ID	Specifies one of 16 preset User ID numbers. If you are editing information for user root, this field is static. You cannot edit the username for root.
Enable User	Enables the user to access the DRAC 5. When unchecked, the User Name cannot be changed.

Table 5-2. General Properties (continued)

Property	Description
User Name	Specifies a DRAC 5 user name with up to 16 characters. Each user must have a unique user name. NOTE: User names on the local DRAC 5 cannot include the @ (at the rate), \ (back slash), " (double quotes), / (forward slash), or . (period) characters. NOTE: If the user name is changed, the new name will not appear in the user interface until the next user login.
Change Password	Enables the New Password and Confirm New Password fields. When unchecked, the user's Password cannot be changed.
New Password	Specifies or edits the DRAC 5 user's password.
Confirm New Password	Requires you to retype the DRAC 5 user's password to confirm.

Table 5-3. IPMI User Privileges

Property	Description
Maximum LAN User Privilege Granted	Specifies the user's maximum privilege on the IPMI LAN channel to one of the following user groups: Administrator , Operator , User , or None .
Maximum Serial Port User Privilege Granted	Specifies the user's maximum privilege on the IPMI Serial channel to one of the following: Administrator , Operator , User , or None .
Enable Serial Over LAN	Allows user to use IPMI Serial Over LAN. When checked, this privilege is enabled.

Table 5-4. DRAC User Privileges

Property	Description
DRAC Group	Specifies the user's maximum DRAC user privilege to one of the following: Administrator , Power User , Guest User , None , or Custom . See Table 5-5 for DRAC Group permissions.
Login to DRAC	Enables the user to log in to the DRAC.
Configure DRAC	Enables the user to configure the DRAC.
Configure Users	Enables the user to allow specific users to access the system.
Clear Logs	Enables the user to clear the DRAC logs.
Execute Server Control Commands	Enables the user to execute racadm commands.
Access Console Redirection	Enables the user to run Console Redirection.
Access Virtual Media	Enables the user to run and use Virtual Media.
Test Alerts	Enables the user to send test alerts (e-mail and PET) to a specific user.
Execute Diagnostic Commands	Enables the user to run diagnostic commands.

Table 5-5. DRAC Group Permissions

User Group	Permissions Granted
Administrator	Login to DRAC, Configure DRAC, Configure Users, Clear Logs, Execute Server Control Commands, Access Console Redirection, Access Virtual Media, Test Alerts, Execute Diagnostic Commands.
Power User	Login to DRAC, Clear Logs, Execute Server Control Commands, Access Console Redirection, Access Virtual Media, Test Alerts.
Guest User	Login to DRAC.

Table 5-5. DRAC Group Permissions

User Group	Permissions Granted
Custom	Selects any combination of the following permissions: Login to DRAC, Configure DRAC, Configure Users, Clear Logs, Execute Server Action Commands, Access Console Redirection, Access Virtual Media, Test Alerts, Execute Diagnostic Commands.
None	No assigned permissions.

Table 5-6. User Configuration Page Buttons

Button	Action
Print	Prints the User Configuration page
Refresh	Reloads the User Configuration page
Go Back To Users Page	Returns to the Users Page .
Apply Changes	Saves the changes made to the network configuration.

Using the RACADM Utility to Configure DRAC 5 Users

 **NOTE:** You must be logged in as user **root** to execute RACADM commands on a remote Linux system.

The DRAC 5 Web-based interface is the quickest way to configure a DRAC 5. If you prefer command-line or script configuration or need to configure multiple DRAC 5s, use RACADM, which is installed with the DRAC 5 agents on the managed system.

To configure multiple DRAC 5s with identical configuration settings, perform one of the following procedures:

- Use the RACADM examples in this section as a guide to create a batch file of **racadm** commands and then execute the batch file on each managed system.
- Create the DRAC 5 configuration file as described in "RACADM Subcommand Overview" on page 295 and execute the **racadm config** subcommand on each managed system using the same configuration file.

Before You Begin

You can configure up to 16 users in the DRAC 5 property database. Before you manually enable a DRAC 5 user, verify if any current users exist. If you are configuring a new DRAC 5 or you ran the **racadm racresetcfg** command, the only current user is **root** with the password **calvin**. The **racresetcfg** subcommand resets the DRAC 5 to the original default values.

 **CAUTION:** Use caution when using the **racresetcfg** command, as *all* configuration parameters are reset to their default values. Any previous changes are lost.

 **NOTE:** Users can be enabled and disabled over time. As a result, a user may have a different index number on each DRAC 5.

To verify if a user exists, type the following command at the command prompt:

```
racadm getconfig -u <username>
```

OR

type the following command once for each index of 1–16:

```
racadm getconfig -g cfgUserAdmin -i <index>
```

 **NOTE:** You can also type `racadm getconfig -f <myfile.cfg>` and view or edit the **myfile.cfg** file, which includes all DRAC 5 configuration parameters.

Several parameters and object IDs are displayed with their current values. Two objects of interest are:

```
# cfgUserAdminIndex=XX
```

```
cfgUserAdminUserName=
```

If the `cfgUserAdminUserName` object has no value, that index number, which is indicated by the `cfgUserAdminIndex` object, is available for use. If a name appears after the "=", that index is taken by that user name.

 **NOTE:** When you manually enable or disable a user with the `racadm config` subcommand, you *must* specify the index with the `-i` option. Observe that the `cfgUserAdminIndex` object displayed in the previous example contains a '#' character. Also, if you use the `racadm config -f racadm.cfg` command to specify any number of groups/objects to write, the index cannot be specified. A new user is added to the first available index. This behavior allows more flexibility in configuring multiple DRAC 5s with the same settings.

Adding a DRAC 5 User

To add a new user to the RAC configuration, a few basic commands can be used. In general, perform the following procedures:

- 1 Set the user name.
- 2 Set the password.
- 3 Set the user privileges.
- 4 Enable the user.

Example

The following example describes how to add a new user named "John" with a "123456" password and LOGIN privileges to the RAC.

```
racadm config -g cfgUserAdmin -o cfgUserAdminUserName  
-i 2 john
```

```
racadm config -g cfgUserAdmin -o cfgUserAdminPassword  
-i 2 123456
```

```
racadm config -g cfgUserAdmin -i 2 -o cfgUserPrivilege  
0x00000001
```

```
racadm config -g cfgUserAdmin -i 2 -o  
cfgUserAdminEnable 1
```

To verify, use one of the following commands:

```
racadm getconfig -u john
```

```
racadm getconfig -g cfgUserAdmin -i 2
```

Removing a DRAC 5 User

When using RACADM, users must be disabled manually and on an individual basis. Users cannot be deleted by using a configuration file.

The following example illustrates the command syntax that can be used to delete a RAC user:

```
racadm config -g cfgUserAdmin -o cfgUserAdminUserName  
-i <index> ""
```

A null string of double quote characters ("") instructs the DRAC 5 to remove the user configuration at the specified index and reset the user configuration to the original factory defaults.

Testing e-mail Alerting

The RAC e-mail alerting feature allows users to receive e-mail alerts when a critical event occurs on the managed system. The following example shows how to test the e-mail alerting feature to ensure that the RAC can properly send out e-mail alerts across the network.

```
racadm testemail -i 2
```



NOTE: Ensure that the **SMTP** and **Email Alert** settings are configured before testing the e-mail alerting feature. See "Configuring E-Mail Alerts" on page 263 for more information.

Testing the RAC SNMP Trap Alert Feature

The RAC SNMP trap alerting feature allows SNMP trap listener configurations to receive traps for system events that occur on the managed system.

The following example shows how a user can test the SNMP trap alert feature of the RAC.

```
racadm testtrap -i 2
```

Before you test the RAC SNMP trap alerting feature, ensure that the SNMP and trap settings are configured correctly. See "**testtrap**" on page 337 and "**testemail**" on page 336 subcommand descriptions to configure these settings.

Enabling a DRAC 5 User With Permissions

To enable a user with specific administrative permissions (role-based authority), first locate an available user index by performing the steps in "Before You Begin" on page 100. Next, type the following command lines with the new user name and password.



NOTE: See Table B-2 for a list of valid bit mask values for specific user privileges. The default privilege value is 0, which indicates the user has no privileges enabled.

```
racadm config -g cfgUserAdmin -o  
cfgUserAdminPrivilege -i <index> <user privilege  
bitmask value>
```

Using the DRAC 5 With Microsoft Active Directory

A directory service maintains a common database of all information needed for controlling users, computers, printers, etc. on a network. If your company already uses the Microsoft Active Directory service software, you can configure the software to provide access to the DRAC 5, allowing you to add and control DRAC 5 user privileges to your existing users in your Active Directory software.



NOTE: Using Active Directory to recognize DRAC 5 users is supported on the Microsoft Windows 2000, Windows Server 2003, and Windows Server 2008 operating systems.

Prerequisites for Enabling Active Directory Authentication for the DRAC 5

To use the Active Directory authentication feature of the DRAC 5, you must have already deployed an Active Directory infrastructure. The DRAC 5 Active Directory authentication supports authentication across multiple trees in a single forest. See "Supported Active Directory Configuration" on page 141 for information on supported Active Directory configuration with respect to the Domain Function level, Groups, Objects, and so on.

See the Microsoft website for information on how to set up an Active Directory infrastructure, if you don't already have one.

DRAC 5 uses the standard Public Key Infrastructure (PKI) mechanism to authenticate securely into the Active Directory hence, you would also require an integrated PKI into the Active Directory infrastructure.

See the Microsoft website for more information on the PKI setup.

To correctly authenticate to all the domain controllers you will also need to enable the Secure Socket Layer (SSL) on all domain controllers. See "Enabling SSL on a Domain Controller" on page 138 for more specific information.

Supported Active Directory Authentication Mechanisms

You can use Active Directory to define user access on the DRAC 5 through two methods: you can use a *standard schema* solution, which uses Active Directory group objects only or you can use the *extended schema* solution, which Dell has customized to add Dell-defined Active Directory objects. For more information about these solutions, see the sections below.

When using Active Directory to configure access to the DRAC 5, you must choose either the extended schema or the standard schema solution.

The advantages of using the standard schema solution are:

- No schema extension is required because standard schema uses Active Directory objects only.
- Configuration on Active Directory side is simple.

The advantages of using the extended schema solution are:

- All of the access control objects are maintained in Active Directory.
- Maximum flexibility in configuring user access on different DRAC 5 cards with different privilege levels.

Standard Schema Active Directory Overview

As shown in Figure 6-1, using standard schema for Active Directory integration requires configuration on both Active Directory and the DRAC 5. On the Active Directory side, a standard group object is used as a role group. A user who has DRAC 5 access will be a member of the role group. In order to give this user access to a specific DRAC 5 card, the role group name and its domain name need to be configured on the specific DRAC 5 card. Unlike the extended schema solution, the role and the privilege level is defined on each DRAC 5 card, not in the Active Directory. Up to five role groups can be configured and defined in each DRAC 5. Table 6-12 shows the privileges level of the role groups and Table 6-1 shows the default role group settings.

Figure 6-1. Configuration of DRAC 5 with Microsoft Active Directory and Standard Schema

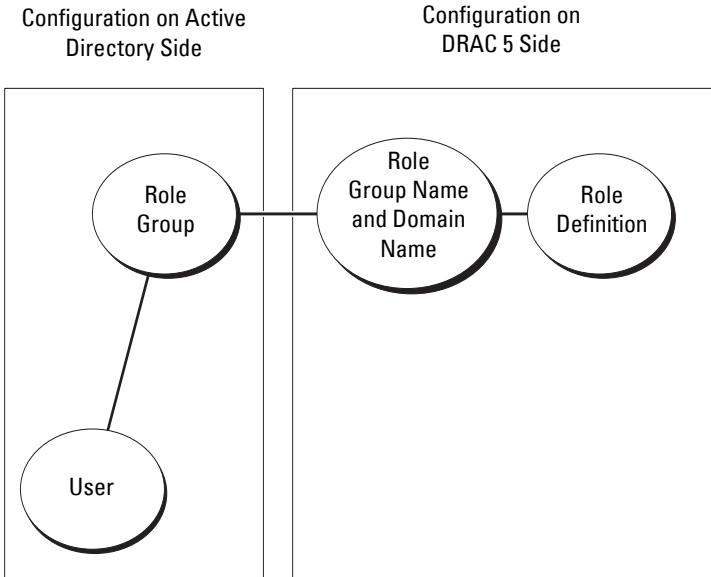



Table 6-1. Default Role Group Privileges

Role Groups	Default Privilege Level	Permissions Granted	Bit Mask
Role Group 1	Administrator	Login to DRAC, Configure DRAC, Configure Users, Clear Logs, Execute Server Control Commands, Access Console Redirection, Access Virtual Media, Test Alerts, Execute Diagnostic Commands	0x000001ff
Role Group 2	Power User	Login to DRAC, Clear Logs, Execute Server Control Commands, Access Console Redirection, Access Virtual Media, Test Alerts	0x000000f9

Table 6-1. Default Role Group Privileges (continued)

Role Groups	Default Privilege Level	Permissions Granted	Bit Mask
Role Group 3	Guest User	Login to DRAC	0x00000001
Role Group 4	None	No assigned permissions	0x00000000
Role Group 5	None	No assigned permissions	0x00000000

 **NOTE:** The Bit Mask values are used only when setting Standard Schema with the RACADM.

There are two ways to enable Standard Schema Active Directory:

- With the DRAC 5 web-based user interface. See "Configuring the DRAC 5 With Standard Schema Active Directory and Web-Based Interface" on page 109.
- With the RACADM CLI tool. See "Configuring the DRAC 5 With Standard Schema Active Directory and RACADM" on page 111.

Configuring Standard Schema Active Directory to Access Your DRAC 5

You need to perform the following steps to configure the Active Directory before an Active Directory user can access the DRAC 5:

- 1** On an Active Directory server (domain controller), open the Active Directory Users and Computers Snap-in.
- 2** Create a group or select an existing group. The name of the group and the name of this domain will need to be configured on the DRAC 5 either with the web-based interface or RACADM (see "Configuring the DRAC 5 With Standard Schema Active Directory and Web-Based Interface" on page 109 or "Configuring the DRAC 5 With Standard Schema Active Directory and RACADM" on page 111).
- 3** Add the Active Directory user as a member of the Active Directory group to access the DRAC 5.

Configuring the DRAC 5 With Standard Schema Active Directory and Web-Based Interface

- 1 Open a supported Web browser window.
- 2 Log in to the DRAC 5 Web-based interface.
- 3 Expand the **System** tree and click **Remote Access**.
- 4 Click the **Configuration** tab and select **Active Directory**.
- 5 On the **Active Directory Main Menu** page, select **Configure Active Directory** and click **Next**.
- 6 In the **Common Settings** section:
 - a Select the **Enable Active Directory** check box.
 - b Type the **Root Domain Name**. The **Root Domain Name** is the fully qualified root domain name for the forest.
 - c Type the **Timeout** time in seconds.
- 7 Click **Use Standard Schema** in the **Active Directory Schema Selection** section.
- 8 Click **Apply** to save the **Active Directory** settings.
- 9 In the **Role Groups** column of the **Standard Schema** settings section, click a **Role Group**.

The **Configure Role Group** page appears, which includes a role group's **Group Name**, **Group Domain**, and **Role Group Privileges**.

- 10 Type the **Group Name**. The group name identifies the role group in the **Active Directory** associated with the **DRAC 5** card.
- 11 Type the **Group Domain**. The **Group Domain** is the fully qualified root domain name for the forest.
- 12 In the **Role Group Privileges** page, set the group privileges.

Table 6-12 describes the **Role Group Privileges**.

Table 6-13 describes the **Role Group Permissions**. If you modify any of the permissions, the existing **Role Group Privilege** (**Administrator**, **Power User**, or **Guest User**) will change to either the **Custom** group or the appropriate **Role Group Privilege** based on the permissions modified.

- 13 Click **Apply** to save the **Role Group** settings.

- 14** Click **Go Back To Active Directory Configuration and Management**.
- 15** Click **Go Back To Active Directory Main Menu**.
- 16** Upload your domain forest Root CA certificate into the DRAC 5.
 - a** Select the **Upload Active Directory CA Certificate** check-box and then click **Next**.
 - b** In the **Certificate Upload** page, type the file path of the certificate or browse to the certificate file.
 **NOTE:** The **File Path** value displays the relative file path of the certificate you are uploading. You must type the absolute file path, which includes the full path and the complete file name and file extension.
The domain controllers' SSL certificates should have been signed by the root CA. Ensure that the root CA certificate is available on your management station that is accessing the DRAC 5 (see "Exporting the Domain Controller Root CA Certificate to the DRAC 5" on page 138).
 - c** Click **Apply**.
The DRAC 5 Web server automatically restarts after you click **Apply**.
- 17** Log out and then log in to the DRAC 5 to complete the DRAC 5 Active Directory feature configuration.
- 18** In the **System** tree, click **Remote Access**.
- 19** Click the **Configuration** tab and then click **Network**.
The **Network Configuration** page appears.
- 20** If **Use DHCP (for NIC IP Address)** is selected under **Network Settings**, select **Use DHCP to obtain DNS server address**.
To manually input a DNS server IP address, deselect **Use DHCP to obtain DNS server addresses** and type your primary and alternate DNS server IP addresses.
- 21** Click **Apply Changes**.
The DRAC 5 Standard Schema Active Directory feature configuration is complete.

Configuring the DRAC 5 With Standard Schema Active Directory and RACADM

Using the following commands to configure the DRAC 5 Active Directory Feature with Standard Schema using the RACADM CLI instead of the Web-based interface.

- 1 Open a command prompt and type the following racadm commands:

```
racadm config -g cfgActiveDirectory -o cfgADEnable 1
racadm config -g cfgActiveDirectory -o cfgADType 2
racadm config -g cfgActiveDirectory -o
cfgADRootDomain <fully qualified root domain name>
racadm config -g cfgStandardSchema -i <index> -o
cfgSSADRoleGroupName <common name of the role group>
racadm config -g cfgStandardSchema -i <index> -o
cfgSSADRoleGroupDomain <fully qualified domain name>
racadm config -g cfgStandardSchema -i <index> -o
cfgSSADRoleGroupPrivilege <Bit Mask Number for
specific user permissions>
racadm sslcertupload -t 0x2 -f <ADS root CA
certificate>
racadm sslcertdownload -t 0x1 -f <RAC SSL
certificate>
```

 **NOTE:** For Bit Mask number values, see Table B-4.

- 2 If DHCP is enabled on the DRAC 5 and you want to use the DNS provided by the DHCP server, type the following racadm commands:

```
racadm config -g cfgLanNetworking -o
cfgDNSServersFromDHCP 1
```

- 3 If DHCP is disabled on the DRAC 5 or you want manually to input your DNS IP address, type the following racadm commands:

```
racadm config -g cfgLanNetworking -o
cfgDNSServersFromDHCP 0
racadm config -g cfgLanNetworking -o cfgDNSServer1
<primary DNS IP address>
racadm config -g cfgLanNetworking -o cfgDNSServer2
<secondary DNS IP address>
```

Instead of DRAC 5 searching for Active Directory servers, you can specify the servers DRAC 5 needs to connect to, to authenticate the user. See "Specify Server for Active Directory Configuration" on page 131 for information on RACADM commands to specify servers.

Extended Schema Active Directory Overview

There are two ways to enable Extended Schema Active Directory:

- With the DRAC 5 web-based user interface. See "Configuring the DRAC 5 With Extended Schema Active Directory and Web-Based Interface" on page 126.
- With the RACADM CLI tool. See "Configuring the DRAC 5 With Extended Schema Active Directory and RACADM" on page 128.

Active Directory Schema Extensions

The Active Directory data is a distributed database of Attributes and Classes. The Active Directory schema includes the rules that determine the type of data that can be added or included in the database. The user class is one example of a Class that is stored in the database. Some example user class attributes can include the user's first name, last name, phone number, and so on. Companies can extend the Active Directory database by adding their own unique Attributes and Classes to solve environment-specific needs. Dell has extended the schema to include the necessary changes to support remote management Authentication and Authorization.

Each Attribute or Class that is added to an existing Active Directory Schema must be defined with a unique ID. To maintain unique IDs across the industry, Microsoft maintains a database of Active Directory Object Identifiers (OIDs) so that when companies add extensions to the schema, they can be guaranteed to be unique and not to conflict with each other. To extend the schema in Microsoft's Active Directory, Dell received unique OIDs, unique name extensions, and uniquely linked attribute IDs for our attributes and classes that are added into the directory service.

Dell extension is: dell

Dell base OID is: 1.2.840.113556.1.8000.1280

RAC LinkID range is:12070 to 12079

The Active Directory OID database maintained by Microsoft can be viewed at <http://msdn.microsoft.com/certification/ADAcctInfo.asp> by entering our extension Dell.

Overview of the RAC Schema Extensions

To provide the greatest flexibility in the multitude of customer environments, Dell provides a group of properties that can be configured by the user depending on the desired results. Dell has extended the schema to include an Association, Device, and Privilege property. The Association property is used to link together the users or groups with a specific set of privileges to one or more RAC devices. This model provides an Administrator maximum flexibility over the different combinations of users, RAC privileges, and RAC devices on the network without adding too much complexity.

Active Directory Object Overview

For each of the physical RACs on the network that you want to integrate with Active Directory for Authentication and Authorization, create at least one Association Object and one RAC Device Object. You can create multiple Association Objects, and each Association Object can be linked to as many users, groups of users, or RAC Device Objects as required. The users and RAC Device Objects can be members of any domain in the enterprise.

However, each Association Object can be linked (or, may link users, groups of users, or RAC Device Objects) to only one Privilege Object. This example allows an Administrator to control each user's privileges on specific RACs.

The RAC Device object is the link to the RAC firmware for querying Active Directory for authentication and authorization. When a RAC is added to the network, the Administrator must configure the RAC and its device object with its Active Directory name so users can perform authentication and authorization with Active Directory. Additionally, the Administrator must add the RAC to at least one Association Object in order for users to authenticate.

Figure 6-2 illustrates that the Association Object provides the connection that is needed for all of the Authentication and Authorization.

Figure 6-2. Typical Setup for Active Directory Objects

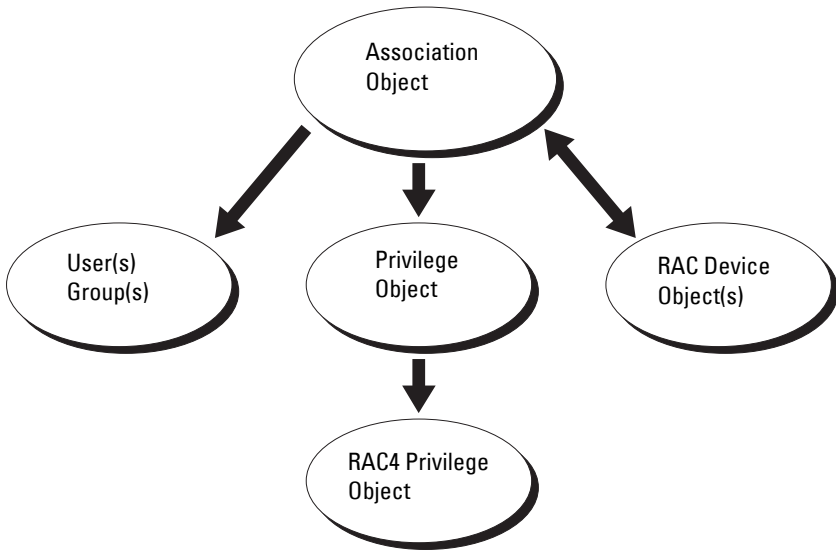

NOTE: The RAC privilege object applies to both DRAC 4 and DRAC 5.

You can create as many or as few association objects as required. However, you must create at least one Association Object, and you must have one RAC Device Object for each RAC (DRAC 5) on the network that you want to integrate with Active Directory for Authentication and Authorization with the RAC (DRAC 5).

The Association Object allows for as many or as few users and/or groups as well as RAC Device Objects. However, the Association Object only includes one Privilege Object per Association Object. The Association Object connects the "Users" who have "Privileges" on the RACs (DRAC 5s).

Additionally, you can configure Active Directory objects in a single domain or in multiple domains. For example, you have two DRAC 5 cards (RAC1 and RAC2) and three existing Active Directory users (user1, user2, and user3). You want to give user1 and user2 an administrator privilege to both DRAC 5 cards and give user3 a login privilege to the RAC2 card. Figure 6-3 shows how you set up the Active Directory objects in this scenario.

When adding Universal Groups from separate domains, create an Association Object with Universal Scope. The Default Association objects created by the Dell Schema Extender Utility are Domain Local Groups and will not work with Universal Groups from other domains.

Figure 6-3. Setting Up Active Directory Objects in a Single Domain

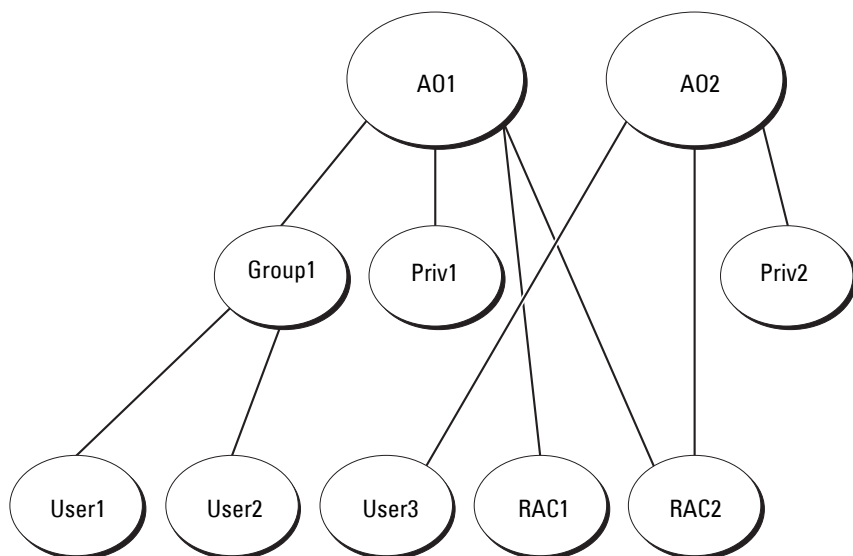

To configure the objects for the single domain scenario, perform the following tasks:

- 1 Create two Association Objects.
- 2 Create two RAC Device Objects, RAC1 and RAC2, to represent the two DRAC 5 cards.
- 3 Create two Privilege Objects, Priv1 and Priv2, in which Priv1 has all privileges (administrator) and Priv2 has login privileges.
- 4 Group user1 and user2 into Group1.
- 5 Add Group1 as Members in Association Object 1 (AO1), Priv1 as Privilege Objects in AO1, and RAC1, RAC2 as RAC Devices in AO1.
- 6 Add User3 as Members in Association Object 2 (AO2), Priv2 as Privilege Objects in AO2, and RAC2 as RAC Devices in AO2.

See "Adding DRAC 5 Users and Privileges to Active Directory" on page 124 for detailed instructions.

Figure 6-4 provides an example of Active Directory objects in multiple domains. In this scenario, you have two DRAC 5 cards (RAC1 and RAC2) and three existing Active Directory users (user1, user2, and user3). User1 is in Domain1, and user2 and user 3 are in Domain2. In this scenario, configure user1 and user 2 with administrator privileges to both DRAC 5 cards and configure user3 with login privileges to the RAC2 card.

Figure 6-4. Setting Up Active Directory Objects in Multiple Domains

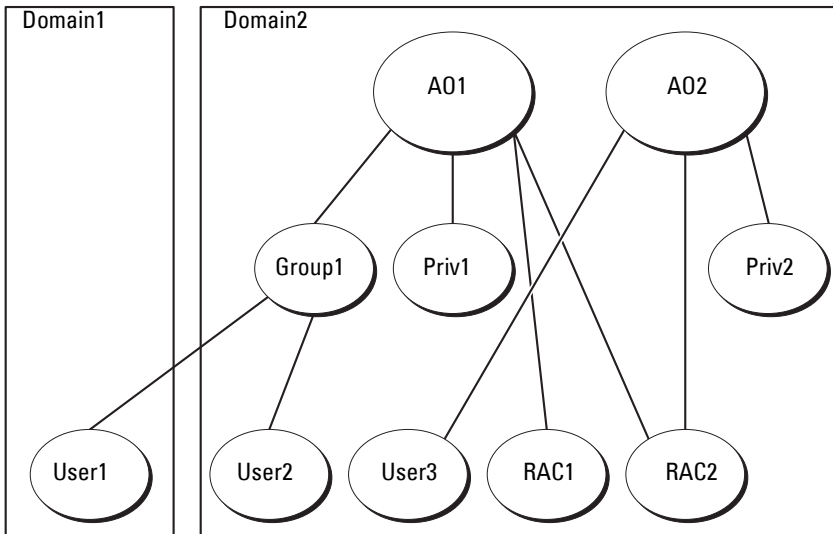

To configure the objects for the multiple domain scenario, perform the following tasks:

- 1 Ensure that the domain forest function is in Native or Windows 2003 mode.
- 2 Create two Association Objects, A01 (of Universal scope) and A02, in any domain.
Figure 6-4 shows the objects in Domain2.
- 3 Create two RAC Device Objects, RAC1 and RAC2, to represent the two DRAC 5 cards.

- 4 Create two Privilege Objects, Priv1 and Priv2, in which Priv1 has all privileges (administrator) and Priv2 has login privileges.
- 5 Group user1 and user2 into Group1. The group scope of Group1 must be Universal.
- 6 Add Group1 as Members in Association Object 1 (AO1), Priv1 as Privilege Objects in AO1, and RAC1, RAC2 as RAC Devices in AO1.
- 7 Add User3 as Members in Association Object 2 (AO2), Priv2 as Privilege Objects in AO2, and RAC2 as RAC Devices in AO2.

Configuring Extended Schema Active Directory to Access Your DRAC 5

Before using Active Directory to access your DRAC 5, configure the Active Directory software and the DRAC 5 by performing the following steps in order:

- 1 Extend the Active Directory schema (see "Extending the Active Directory Schema" on page 117).
- 2 Extend the Active Directory Users and Computers Snap-in (see "Installing the Dell Extension to the Active Directory Users and Computers Snap-In" on page 123).
- 3 Add DRAC 5 users and their privileges to Active Directory (see "Adding DRAC 5 Users and Privileges to Active Directory" on page 124).
- 4 Enable SSL on each of your domain controllers (see "Enabling SSL on a Domain Controller" on page 138).
- 5 Configure the DRAC 5 Active Directory properties using either the DRAC 5 Web-based interface or the RACADM (see "Configuring the DRAC 5 With Extended Schema Active Directory and Web-Based Interface" on page 126 or "Configuring the DRAC 5 With Extended Schema Active Directory and RACADM" on page 128).

Extending the Active Directory Schema

Extending your Active Directory schema adds a Dell organizational unit, schema classes and attributes, and example privileges and association objects to the Active Directory schema. Before you extend the schema, ensure that you have Schema Admin privileges on the Schema Master Flexible Single Master Operation (FSMO) Role Owner of the domain forest.

You can extend your schema using one of the following methods:

- Dell Schema Extender utility
- LDIF script file

If you use the LDIF script file, the Dell organizational unit will not be added to the schema.

The LDIF files and Dell Schema Extender are located on your *Dell Systems Management Tools and Documentation* DVD in the following respective directories:

- *DVD drive:\support\OMActiveDirectory Tools\RAC4-5\LDIF_Files*
- *DVD drive:\support\OMActiveDirectory Tools\RAC4-5\Schema_Extender*

To use the LDIF files, see the instructions in the readme included in the **LDIF_Files** directory. To use the Dell Schema Extender to extend the Active Directory Schema, see "Using the Dell Schema Extender" on page 118.

You can copy and run the Schema Extender or LDIF files from any location.

Using the Dell Schema Extender



CAUTION: The Dell Schema Extender uses the `SchemaExtenderOem.ini` file. To ensure that the Dell Schema Extender utility functions properly, do not modify the name of this file.

- 1 In the **Welcome** screen, click **Next**.
- 2 Read and understand the warning and click **Next**.
- 3 Select **Use Current Log In Credentials** or enter a user name and password with schema administrator rights.
- 4 Click **Next** to run the Dell Schema Extender.
- 5 Click **Finish**.

The schema is extended. To verify the schema extension, use the Microsoft Management Console (MMC) and the Active Directory Schema snap-in to verify that the following exist:

- Classes (see Table 6-2 through Table 6-7)
- Attributes (Table 6-8)

See your Microsoft documentation for more information on how to enable and use the Active Directory Schema snap-in the MMC.

Table 6-2. Class Definitions for Classes Added to the Active Directory Schema

Class Name	Assigned Object Identification Number (OID)
dellRacDevice	1.2.840.113556.1.8000.1280.1.1.1.1
dellAssociationObject	1.2.840.113556.1.8000.1280.1.1.1.2
dellRACPrivileges	1.2.840.113556.1.8000.1280.1.1.1.3
dellPrivileges	1.2.840.113556.1.8000.1280.1.1.1.4
dellProduct	1.2.840.113556.1.8000.1280.1.1.1.5

Table 6-3. dellRacDevice Class

OID	1.2.840.113556.1.8000.1280.1.1.1.1
Description	Represents the Dell RAC device. The RAC device must be configured as dellRacDevice in Active Directory. This configuration enables the DRAC 5 to send Lightweight Directory Access Protocol (LDAP) queries to Active Directory.
Class Type	Structural Class
SuperClasses	dellProduct
Attributes	dellSchemaVersion dellRacType

Table 6-4. dellAssociationObject Class

OID	1.2.840.113556.1.8000.1280.1.1.1.2
Description	Represents the Dell Association Object. The Association Object provides the connection between the users and the devices.
Class Type	Structural Class
SuperClasses	Group
Attributes	dellProductMembers dellPrivilegeMember

Table 6-5. dellRAC4Privileges Class

OID	1.2.840.113556.1.8000.1280.1.1.1.3
Description	Used to define the privileges (Authorization Rights) for the DRAC 5 device.
Class Type	Auxiliary Class
SuperClasses	None
Attributes	dellIsLoginUser dellIsCardConfigAdmin dellIsUserConfigAdmin dellIsLogClearAdmin dellIsServerResetUser dellIsConsoleRedirectUser dellIsVirtualMediaUser dellIsTestAlertUser dellIsDebugCommandAdmin

Table 6-6. dellPrivileges Class

OID	1.2.840.113556.1.8000.1280.1.1.1.4
Description	Used as a container Class for the Dell Privileges (Authorization Rights).
Class Type	Structural Class
SuperClasses	User
Attributes	dellRAC4Privileges

Table 6-7. dellProduct Class

OID	1.2.840.113556.1.8000.1280.1.1.1.5
Description	The main class from which all Dell products are derived.
Class Type	Structural Class
SuperClasses	Computer
Attributes	dellAssociationMembers

Table 6-8. List of Attributes Added to the Active Directory Schema

Attribute Name/Description	Assigned OID/Syntax Object Identifier	Single Valued
dellPrivilegeMember List of dellPrivilege Objects that belong to this Attribute.	1.2.840.113556.1.8000.1280.1.1.2.1 Distinguished Name (LDAPTYPE_DN 1.3.6.1.4.1.1466.115.121.1.12)	FALSE
dellProductMembers List of dellRacDevices Objects that belong to this role. This attribute is the forward link to the dellAssociationMembers backward link. Link ID: 12070	1.2.840.113556.1.8000.1280.1.1.2.2 Distinguished Name (LDAPTYPE_DN 1.3.6.1.4.1.1466.115.121.1.12)	FALSE
dellIsLoginUser TRUE if the user has Login rights on the device.	1.2.840.113556.1.8000.1280.1.1.2.3 Boolean (LDAPTYPE_BOOLEAN 1.3.6.1.4.1.1466.115.121.1.7)	TRUE
dellIsCardConfigAdmin TRUE if the user has Card Configuration rights on the device.	1.2.840.113556.1.8000.1280.1.1.2.4 Boolean (LDAPTYPE_BOOLEAN 1.3.6.1.4.1.1466.115.121.1.7)	TRUE
dellIsUserConfigAdmin TRUE if the user has User Configuration rights on the device.	1.2.840.113556.1.8000.1280.1.1.2.5 Boolean (LDAPTYPE_BOOLEAN 1.3.6.1.4.1.1466.115.121.1.7)	TRUE
dellIsLogClearAdmin TRUE if the user has Log Clearing rights on the device.	1.2.840.113556.1.8000.1280.1.1.2.6 Boolean (LDAPTYPE_BOOLEAN 1.3.6.1.4.1.1466.115.121.1.7)	TRUE
dellIsServerResetUser TRUE if the user has Server Reset rights on the device.	1.2.840.113556.1.8000.1280.1.1.2.7 Boolean (LDAPTYPE_BOOLEAN 1.3.6.1.4.1.1466.115.121.1.7)	TRUE
dellIsConsoleRedirectUser TRUE if the user has Console Redirection rights on the device.	1.2.840.113556.1.8000.1280.1.1.2.8 Boolean (LDAPTYPE_BOOLEAN 1.3.6.1.4.1.1466.115.121.1.7)	TRUE

Table 6-8. List of Attributes Added to the Active Directory Schema (continued)

Attribute Name/Description	Assigned OID/Syntax Object Identifier	Single Valued
dellIsVirtualMediaUser TRUE if the user has Virtual Media rights on the device.	1.2.840.113556.1.8000.1280.1.1.2.9 Boolean (LDAPTYPE_BOOLEAN 1.3.6.1.4.1.1466.115.121.1.7)	TRUE
dellIsTestAlertUser TRUE if the user has Test Alert User rights on the device.	1.2.840.113556.1.8000.1280.1.1.2.10 Boolean (LDAPTYPE_BOOLEAN 1.3.6.1.4.1.1466.115.121.1.7)	TRUE
dellIsDebugCommandAdmin TRUE if the user has Debug Command Admin rights on the device.	1.2.840.113556.1.8000.1280.1.1.2.11 Boolean (LDAPTYPE_BOOLEAN 1.3.6.1.4.1.1466.115.121.1.7)	TRUE
dellSchemaVersion The Current Schema Version is used to update the schema.	1.2.840.113556.1.8000.1280.1.1.2.12 Case Ignore String (LDAPTYPE_CASEIGNORESTRING 1.2.840.113556.1.4.905)	TRUE
dellRacType This attribute is the Current Rac Type for the dellRacDevice object and the backward link to the dellAssociationObjectMembers forward link.	1.2.840.113556.1.8000.1280.1.1.2.13 Case Ignore String (LDAPTYPE_CASEIGNORESTRING 1.2.840.113556.1.4.905)	TRUE
dellAssociationMembers List of dellAssociationObjectMembers that belong to this Product. This attribute is the backward link to the dellProductMembers Linked attribute. Link ID: 12071	1.2.840.113556.1.8000.1280.1.1.2.14 Distinguished Name (LDAPTYPE_DN 1.3.6.1.4.1.1466.115.121.1.12)	FALSE

Installing the Dell Extension to the Active Directory Users and Computers Snap-In

When you extend the schema in Active Directory, you must also extend the Active Directory Users and Computers snap-in so the administrator can manage RAC (DRAC 5) devices, Users and User Groups, RAC Associations, and RAC Privileges.

When you install your systems management software using the *Dell Systems Management Tools and Documentation* DVD, you can extend the snap-in by selecting the **Dell Extension to the Active Directory User's and Computers Snap-In** option during the installation procedure. See the *Dell OpenManage Software Quick Installation Guide* for additional instructions about installing systems management software.

For more information about the Active Directory User's and Computers snap-in, see your Microsoft documentation.

Installing the Administrator Pack

You must install the Administrator Pack on each system that is managing the Active Directory DRAC 5 Objects. If you do not install the Administrator Pack, you cannot view the Dell RAC Object in the container.

See "Opening the Active Directory Users and Computers Snap-In" on page 123 for more information.

Opening the Active Directory Users and Computers Snap-In

To open the Active Directory Users and Computers snap-in:

- 1 If you are logged into the domain controller, click **Start Admin Tools**→ **Active Directory Users and Computers**.

If you are not logged into the domain controller, you must have the appropriate Microsoft Administrator Pack installed on your local system. To install this Administrator Pack, click **Start**→ **Run**, type MMC, and press **Enter**.

The Microsoft Management Console (MMC) appears.

- 2 In the **Console 1** window, click **File** (or **Console** on systems running Windows 2000).
- 3 Click **Add/Remove Snap-in**.

- 4 Select the **Active Directory Users and Computers** snap-in and click **Add**.
- 5 Click **Close** and click **OK**.

Adding DRAC 5 Users and Privileges to Active Directory

Using the Dell-extended Active Directory Users and Computers snap-in, you can add DRAC 5 users and privileges by creating RAC, Association, and Privilege objects. To add each object type, perform the following procedures:

- Create a RAC device Object
- Create a Privilege Object
- Create an Association Object
- Add objects to an Association Object

Creating a RAC Device Object

- 1 In the MMC **Console Root** window, right-click a container.
- 2 Select **New→ Dell RAC Object**.
The **New Object** window appears.
- 3 Type a name for the new object. The name must be identical to the DRAC 5 Name that you will type in step a of "Configuring the DRAC 5 With Extended Schema Active Directory and Web-Based Interface" on page 126.
- 4 Select **RAC Device Object**.
- 5 Click **OK**.

Creating a Privilege Object



NOTE: A Privilege Object must be created in the same domain as the related Association Object.

- 1 In the **Console Root (MMC)** window, right-click a container.
- 2 Select **New→ Dell RAC Object**.
The **New Object** window appears.
- 3 Type a name for the new object.
- 4 Select **Privilege Object**.
- 5 Click **OK**.

- 6 Right-click the privilege object that you created, and select **Properties**.
- 7 Click the **RAC Privileges** tab and select the privileges that you want the user to have (for more information, see Table 5-4).

Creating an Association Object

The Association Object is derived from a Group and must contain a Group Type. The Association Scope specifies the Security Group Type for the Association Object. When you create an Association Object, choose the Association Scope that applies to the type of objects you intend to add.

For example, if you select **Universal**, the association objects are only available when the Active Directory Domain is functioning in Native Mode or above.

- 1 In the **Console Root** (MMC) window, right-click a container.
- 2 Select **New**→ **Dell RAC Object**.
This opens the **New Object** window.
- 3 Type a name for the new object.
- 4 Select **Association Object**.
- 5 Select the scope for the **Association Object**.
- 6 Click **OK**.

Adding Objects to an Association Object

Using the **Association Object Properties** window, you can associate users or user groups, privilege objects, and RAC devices or RAC device groups. If your system is running Windows 2000 mode or higher, use **Universal Groups** to span domains with your user or RAC objects.

You can add groups of Users and RAC devices. The procedure for creating Dell-related groups and non-Dell-related groups is identical.

Adding Users or User Groups

- 1 Right-click the **Association Object** and select **Properties**.
- 2 Select the **Users** tab and click **Add**.
- 3 Type the user or User Group name and click **OK**.

Click the **Privilege Object** tab to add the privilege object to the association that defines the user's or user group's privileges when authenticating to a RAC device. Only one privilege object can be added to an Association Object.

Adding Privileges

- 1 Select the **Privileges Object** tab and click **Add**.
- 2 Type the Privilege Object name and click **OK**.

Click the **Products** tab to add one or more RAC devices to the association. The associated devices specify the RAC devices connected to the network that are available for the defined users or user groups. Multiple RAC devices can be added to an Association Object.

Adding RAC Devices or RAC Device Groups

To add RAC devices or RAC device groups:

- 1 Select the **Products** tab and click **Add**.
- 2 Type the RAC device or RAC device group name and click **OK**.
- 3 In the **Properties** window, click **Apply** and click **OK**.

Configuring the DRAC 5 With Extended Schema Active Directory and Web-Based Interface

- 1 Open a supported Web browser window.
- 2 Log in to the DRAC 5 Web-based interface.
- 3 Expand the **System** tree and click **Remote Access**.
- 4 Click the **Configuration** tab and select **Active Directory**.
- 5 On the **Active Directory Main Menu** page, select **Configure Active Directory** and click **Next**.
- 6 In the **Common Settings** section:
 - a Select the **Enable Active Directory** check box.
 - b Type the **Root Domain Name**. The **Root Domain Name** is the fully qualified root domain name for the forest.
 - c Type the **Timeout** time in seconds.
- 7 Click **Use Extended Schema** in the **Active Directory Schema Selection** section.

- 8** In the Extended Schema Settings section:
 - a** Type the **DRAC Name**. This name must be the same as the common name of the new RAC object you created in your Domain Controller (see step 3 of "Creating a RAC Device Object" on page 124).
 - b** Type the **DRAC Domain Name** (for example, `drac5.com`). Do not use the NetBIOS name. The **DRAC Domain Name** is the fully qualified domain name of the sub-domain where the RAC Device Object is located.
- 9** Click **Apply** to save the Active Directory settings.
- 10** Click **Go Back To Active Directory Main Menu**.
- 11** Upload your domain forest Root CA certificate into the DRAC 5.
 - a** Select the **Upload Active Directory CA Certificate** check-box and then click **Next**.
 - b** In the **Certificate Upload** page, type the file path of the certificate or browse to the certificate file.
 **NOTE:** The **File Path** value displays the relative file path of the certificate you are uploading. You must type the absolute file path, which includes the full path and the complete file name and file extension.
The domain controllers' SSL certificates should have been signed by the root CA. Have the root CA certificate available on your management station accessing the DRAC 5 (see "Exporting the Domain Controller Root CA Certificate to the DRAC 5" on page 138).
 - c** Click **Apply**.
The DRAC 5 Web server automatically restarts after you click **Apply**.
- 12** Log out and then log in to the DRAC 5 to complete the DRAC 5 Active Directory feature configuration.
- 13** In the **System** tree, click **Remote Access**.
- 14** Click the **Configuration** tab and then click **Network**.
The **Network Configuration** page appears.

- 15 If Use DHCP (for NIC IP Address) is selected under Network Settings, then select Use DHCP to obtain DNS server address.

To manually input a DNS server IP address, deselect Use DHCP to obtain DNS server addresses and type your primary and alternate DNS server IP addresses.

- 16 Click Apply Changes.

The DRAC 5 Extended Schema Active Directory feature configuration is complete.

Configuring the DRAC 5 With Extended Schema Active Directory and RACADM

Using the following commands to configure the DRAC 5 Active Directory Feature with Extended Schema using the RACADM CLI tool instead of the Web-based interface.

- 1 Open a command prompt and type the following racadm commands:

```
racadm config -g cfgActiveDirectory -o cfgADEnable 1
```

```
racadm config -g cfgActiveDirectory -o cfgADType 1
```

```
racadm config -g cfgActiveDirectory -o  
cfgADRacDomain <fully qualified rac domain name>
```

```
racadm config -g cfgActiveDirectory -o  
cfgADRootDomain <fully qualified root domain name>
```

```
racadm config -g cfgActiveDirectory -o  
cfgADRacName <RAC common name>
```

```
racadm sslcertupload -t 0x2 -f <ADS root CA  
certificate>
```

```
racadm sslcertdownload -t 0x1 -f <RAC SSL  
certificate>
```

- 2 If DHCP is enabled on the DRAC 5 and you want to use the DNS provided by the DHCP server, type the following racadm command:

```
racadm config -g cfgLanNetworking -o  
cfgDNSServersFromDHCP 1
```

- 3 If DHCP is disabled on the DRAC 5 or you want to input your DNS IP address, type following racadm commands:

```
racadm config -g cfgLanNetworking -o  
cfgDNSServersFromDHCP 0
```

```
racadm config -g cfgLanNetworking -o cfgDNSServer1  
<primary DNS IP address>
```

```
racadm config -g cfgLanNetworking -o cfgDNSServer2  
<secondary DNS IP address>
```

Press **Enter** to complete the DRAC 5 Active Directory feature configuration.

Instead of DRAC 5 searching for Active Directory servers, you can specify the servers DRAC 5 needs to connect to, to authenticate the user. See "Specify Server for Active Directory Configuration" on page 131 for information on RACADM commands to specify servers.

Accumulating Privileges Using Extended Schema

The Extended Schema Authentication mechanism supports Privilege Accumulation from different privilege objects associated with the same user through different Association Objects. In other words, Extended Schema Authentication accumulates privileges to allow the user the super set of all assigned privileges corresponding to the different privilege objects associated with the same user.

Figure 6-5 provides an example of accumulating privileges using Extended Schema.

Figure 6-5. Privilege Accumulation for a User

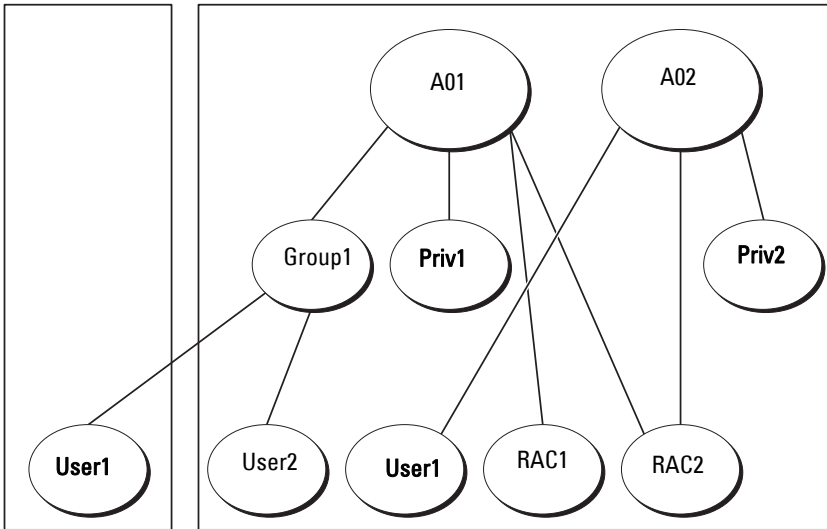

The figure shows two Association Objects—A01 and A02. These Association Objects may be part of the same or different domains. User1 is associated to RAC1 and RAC2 through both association objects. Therefore, User1 has accumulated privileges that results when combining the Privileges set for objects Priv1 and Priv2.

For example, Priv1 had the privileges: Login, Virtual Media, and Clear Logs and Priv2 had the privileges: Login, Configure DRAC, and Test Alerts. User1 will now have the privilege set: Login, Virtual Media, Clear Logs, Configure DRAC, and Test Alerts, which is the combined privilege set of Priv1 and Priv2

Extended Schema Authentication, thus, accumulates privileges to allow the user the maximum set of privileges possible considering the assigned privileges of the different privilege objects associated to the same user.

Specify Server for Active Directory Configuration

If you want to specify an LDAP, Global Catalog server, or Association Object (applicable only for Extended Schema) domain instead of using the servers returned by the DNS server to search for a user name, type the following command to enable the **Specify Server** option:

```
racadm config -g cfgActive Directory -o
cfgADSpecifyServer Enable 1
```



NOTE: If you use this option, the hostname in the CA certificate is not matched against the name of the specified server. This is particularly useful if you are a DRAC administrator because it enables you to enter a hostname as well as an IP address.

After the **Specify Server** option is enabled, you can specify an LDAP server or a Global Catalog server with an IP address or a fully qualified domain name of the server (FQDN). The FQDN consists of the hostname and the domain name of the server.



NOTE: If you are using Active Directory authentication based on Kerberos, specify only the FQDN of the server; specifying the IP address is not supported. For more information, see "Enabling Kerberos Authentication" on page 147.

To specify an LDAP server using the command line interface (CLI), type:

```
racadm config -g cfgActive Directory -o
cfgADDomainController <fully qualified domain name or
IP address>
```

To specify a Global Catalog server using the command line interface (CLI), type:

```
racadm config -g cfgActive Directory -o
cfgGlobalCatalog <fully qualified domain name or
IP address>
```

To specify an Association Object (applicable only for Extended Schema) domain using the CLI, type:

```
racadm config -g cfgActive Directory -o cfgAODomain
<domain>:<fully qualified domain name or IP address>
```

where <domain> is the domain where the Association Object resides and IP/FQDN is the IP address or the FQDN of the specific host (Domain Controller of domain) to which the DRAC 5 connects.

To specify the Association Object, ensure that you also provide the IP or FQDN of the Global Catalog.



NOTE: If you specify the IP address as 0.0.0.0, DRAC 5 will not search for any server.

You can specify a list of LDAP, Global Catalog servers, or Association Objects separated by commas. DRAC 5 allows you to specify up to four IP addresses or hostnames.

If LDAPS is not correctly configured for all domains and applications, enabling it may produce unexpected results during the functioning of the existing applications/domains.

For Extended Schema, you can specify either Domain Controller or Global Catalog with Association Object. Specifying only the Global Catalog or only the Association Object is not applicable for Extended Schema. If you specify only the Domain Controller, all objects including User, Group, RAC, Privilege and Association should be on the same domain. If any of these objects are on different domains, use the Global Catalog with the Association Object option. You can specify up to four Domain Controllers and all these entries should point to the same domain. You can specify up to four Global Catalog servers. You can specify up to four Association Object servers. All these entries should point to the same domain. In case you are using the Association Object option, you should also configure the Global Catalog option to be able to log in. Specify the Domain Controller name where you created the user. Both IP or FQDN can be specified here.

For Standard Schema, specify only the Domain Controller and the Global Catalog. Specify Association Object is not applicable with Standard Schema. You can specify the Domain Controller where the user role groups are created. Specify either the IP or the FQDN. You can specify up to four Domain Controllers. All entries should point to the same domain. If you specify only the Domain Controller, the User and Group should be on the same domain. If the Role Groups are on different domains, you have to also specify the Global Catalog server. You can specify up to four Global Catalog servers. Both the IP or the FQDN can be specified here. You can also only specify the Global Catalog servers.

Configuring and Managing Active Directory Certificates

To access the Active Directory Main Menu:

- 1 Expand the **System** tree and click **Remote Access**.
- 2 Click the **Configuration** tab and click **Active Directory**.

Table 6-9 lists the **Active Directory Main Menu** page options.

Table 6-9. Active Directory Main Menu Page Options

Field	Description
Configure Active Directory	Configures the Active Directory's DRAC Name, ROOT Domain Name, DRAC Domain Name, Active Directory Authentication Timeout, Active Directory Schema Selection, and Role Group settings.
Upload Active Directory CA Certificate	Uploads an Active Directory certificate to the DRAC.
Download DRAC Server Certificate	The Windows Download Manager enables you to download a DRAC server certificate to your system.
View Active Directory CA Certificate	Displays the Active Directory Certificate that has been uploaded to the DRAC.

Configuring Active Directory (Standard Schema and Extended Schema)

- 1 In the **Active Directory Main Menu** page, select **Configure Active Directory** and click **Next**.
- 2 In the **Active Directory Configuration and Management** page, enter the Active Directory settings.

Table 6-10 describes the **Active Directory Configuration and Management** page settings.

- 3 Click **Apply** to save the settings.

- 4 Click the appropriate **Active Directory Configuration** page button to continue. See Table 6-11.
- 5 To configure the Role Groups for Active Directory Standard Schema, click on the individual Role Group (1-5). See Table 6-12 and Table 6-13.



NOTE: To save the settings on the **Active Directory Configuration and Management** page, you have to click **Apply** before proceeding to the **Custom Role Group** page.

Table 6-10. Active Directory Configuration and Management Page Settings

Setting	Description
Enable Active Directory	Enables Active Directory. Checked=Enabled; Unchecked=Disabled.
ROOT Domain Name	The Active Directory ROOT domain name. This value is NULL by default. The name must be a valid domain name consisting of <i>x.y</i> , where <i>x</i> is a 1-254 character ASCII string with no blank spaces between characters, and <i>y</i> is a valid domain type such as com, edu, gov, int, mil, net, org.
Timeout	The time in seconds to wait for Active Directory queries to complete. Minimum value is equal to or greater than 15 seconds. The default value is 120 seconds.
Use Standard Schema	Uses Standard Schema with Active Directory
Use Extended Schema	Uses Extended Schema with Active Directory
DRAC Name	The name that uniquely identifies the DRAC 5 card in Active Directory. This value is NULL by default. The name must be a 1-254 character ASCII string with no blank spaces between characters.
DRAC Domain Name	The DNS name (string) of the domain, where the Active Directory DRAC 5 object resides. This value is NULL by default. The name must be a valid domain name consisting of <i>x.y</i> , where <i>x</i> is a 1-254 character ASCII string with no blank spaces between characters, and <i>y</i> is a valid domain type such as com, edu, gov, int, mil, net, org.

Table 6-10. Active Directory Configuration and Management Page Settings (continued)

Setting	Description
Role Groups	The list of role groups associated with the DRAC 5 card. To change the settings for a role group, click their role group number, in the role groups list. The Configure Role Group window displays. NOTE: If you click on the role group link prior to applying the settings for the Active Directory Configuration and Management page, you will lose these settings.
Group Name	The name that identifies the role group in the Active Directory associated with the DRAC 5 card.
Group Domain	The domain that the group is in.
Group Privilege	The privilege level for the group.

Table 6-11. Active Directory Configuration and Management Page Buttons

Button	Description
Print	Prints the Active Directory Configuration and Management page.
Apply	Saves the changes made to the Active Directory Configuration and Management page.
Go Back to Active Directory Main Menu	Returns to the Active Directory Main Menu page.

Table 6-12. Role Group Privileges

Setting	Description
Role Group Privilege Level	Specifies the user's maximum DRAC user privilege to one of the following: Administrator, Power User, Guest user, None, or Custom. See Table 6-13 for Role Group permissions
Login to DRAC	Enables the user to log in to the DRAC.
Configure DRAC	Enables the user to configure the DRAC.

Table 6-12. Role Group Privileges (continued)

Setting	Description
Configure Users	Enables the user to allow specific users to access the system.
Clear Logs	Enables the user to clear the DRAC logs.
Execute Server Control Commands	Enables the user to execute racadm commands.
Access Console Redirection	Enables the user to run Console Redirection.
Access Virtual Media	Enables the user to run and use Virtual Media.
Test Alerts	Enables the user to send test alerts (e-mail and PET) to a specific user.
Execute Diagnostic Commands	Enables the user to run diagnostic commands.

Table 6-13. Role Group Permissions

Property	Description
Administrator	Login to DRAC, Configure DRAC, Configure Users, Clear Logs, Execute Server Control Commands, Access Console Redirection, Access Virtual Media, Test Alerts, Execute Diagnostic Commands
Power User	Login to DRAC, Clear Logs, Execute Server Control Commands, Access Console Redirection, Access Virtual Media, Test Alerts
Guest User	Login to DRAC
Custom	Selects any combination of the following permissions: Login to DRAC, Configure DRAC, Configure Users, Clear Logs, Execute Server Action Commands, Access Console Redirection, Access Virtual Media, Test Alerts, Execute Diagnostic Commands
None	No assigned permissions

Uploading an Active Directory CA Certificate

- 1 In the **Active Directory Main Menu** page, select **Upload Active Directory CA Certificate** and click **Next**.
- 2 In the **Certificate Upload** page, in the **File Path** field, type the file path of the certificate or click **Browse** to navigate to the certificate file.
 **NOTE:** The **File Path** value displays the relative file path of the certificate you are uploading. You must type the absolute file path, which includes the full path and the complete file name and file extension.
- 3 Click **Apply**.
- 4 Click the appropriate **Certificate Upload** page button to continue. See Table 6-11.

Downloading a DRAC Server Certificate

- 1 In the **Active Directory Main Menu** page, select **Download DRAC Server Certificate** and click **Next**.
- 2 In the **File Download** window, click **Save** and save the file to a directory on your system.
- 3 In the **Download Complete** window, click **Close**.

Viewing an Active Directory CA Certificate

Use the **Active Directory Main Menu** page to view a CA server certificate for your DRAC 5.

- 1 In the **Active Directory Main Menu** page, select **View Active Directory CA Certificate** and click **Next**.
Table 6-14 describes the fields and associated descriptions listed in the **Certificate** window.
- 2 Click the appropriate **View Active Directory CA Certificate** page button to continue. See Table 6-11.

Table 6-14. Active Directory CA Certificate Information

Field	Description
Serial Number	Certificate serial number.
Subject Information	Certificate attributes entered by the subject.
Issuer Information	Certificate attributes returned by the issuer.

Table 6-14. Active Directory CA Certificate Information (continued)

Field	Description
Valid From	Certificate issue date.
Valid To	Certificate expiration date.

Enabling SSL on a Domain Controller

When the DRAC 5 authenticates users against an Active Directory domain controller, it starts an SSL session with the domain controller. At this time, the domain controller should publish a certificate signed by the Certificate Authority (CA)—the root certificate of which is also uploaded into the DRAC 5. In other words, for DRAC 5 to be able to authenticate to *any* domain controller—whether it is the root or the child domain controller—that domain controller should have an SSL-enabled certificate signed by the domain’s CA.

If you are using Microsoft Enterprise Root CA to *automatically* assign all your domain controllers to an SSL certificate, perform the following steps to enable SSL on each domain controller:

- 1** Enable SSL on each of your domain controllers by installing the SSL certificate for each controller.
 - a** Click **Start**→**Administrative Tools**→**Domain Security Policy**.
 - b** Expand the **Public Key Policies** folder, right-click **Automatic Certificate Request Settings** and click **Automatic Certificate Request**.
 - c** In the **Automatic Certificate Request Setup Wizard**, click **Next** and select **Domain Controller**.
 - d** Click **Next** and click **Finish**.

Exporting the Domain Controller Root CA Certificate to the DRAC 5



NOTE: If your system is running Windows 2000, the following steps may vary.

- 1** Locate the domain controller that is running the Microsoft Enterprise CA service.
- 2** Click **Start**→**Run**.
- 3** In the **Run** field, type **mmc** and click **OK**.

- 4** In the **Console 1** (MMC) window, click **File** (or **Console** on Windows 2000 machines) and select **Add/Remove Snap-in**.
- 5** In the **Add/Remove Snap-In** window, click **Add**.
- 6** In the **Standalone Snap-In** window, select **Certificates** and click **Add**.
- 7** Select **Computer** account and click **Next**.
- 8** Select **Local Computer** and click **Finish**.
- 9** Click **OK**.
- 10** In the **Console 1** window, expand the **Certificates** folder, expand the **Personal** folder, and click the **Certificates** folder.
- 11** Locate and right-click the root CA certificate, select **All Tasks**, and click **Export...**
- 12** In the **Certificate Export Wizard**, click **Next**, and select **No do not export the private key**.
- 13** Click **Next** and select **Base-64 encoded X.509 (.cer)** as the format.
- 14** Click **Next** and save the certificate to a directory on your system.
- 15** Upload the certificate you saved in step 14 to the DRAC 5.

To upload the certificate using RACADM, see "Configuring the DRAC 5 With Extended Schema Active Directory and Web-Based Interface" on page 126.

To upload the certificate using the Web-based interface, perform the following procedure:

- a** Open a supported Web browser window.
- b** Log in to the DRAC 5 Web-based interface.
- c** Expand the **System** tree and click **Remote Access**.
- d** Click the **Configuration** tab, and then click **Security**.
- e** In the **Security Certificate Main Menu** page, select **Upload Server Certificate** and click **Apply**.

- f In the **Certificate Upload** screen, perform one of the following procedures:
 - Click **Browse** and select the certificate
 - In the **Value** field, type the path to the certificate.
- g Click **Apply**.

Importing the DRAC 5 Firmware SSL Certificate



NOTE: If the Active Directory Server is set to authenticate the client during an SSL session initialization phase, you need to upload the DRAC 5 Server certificate to the Active Directory Domain controller as well. This additional step is not required if the Active Directory does not perform a client authentication during an SSL session's initialization phase.

Use the following procedure to import the DRAC 5 firmware SSL certificate to all domain controller trusted certificate lists.



NOTE: If your system is running Windows 2000, the following steps may vary.



NOTE: If the DRAC 5 firmware SSL certificate is signed by a well-known CA, you are not required to perform the steps in this section.

The DRAC 5 SSL certificate is the identical certificate used for the DRAC 5 Web server. All DRAC 5 controllers are shipped with a default self-signed certificate.

To access the certificate using the DRAC 5 Web-based interface, select **Configuration**→ **Active Directory**→ **Download DRAC 5 Server Certificate**.

- 1 On the domain controller, open an MMC Console window and select **Certificates**→ **Trusted Root Certification Authorities**.
- 2 Right-click **Certificates**, select **All Tasks** and click **Import**.
- 3 Click **Next** and browse to the SSL certificate file.
- 4 Install the RAC SSL Certificate in each domain controller's **Trusted Root Certification Authority**.

If you have installed your own certificate, ensure that the CA signing your certificate is in the **Trusted Root Certification Authority** list. If the Authority is not in the list, you must install it on all your Domain Controllers.

- 5 Click **Next** and select whether you would like Windows to automatically select the certificate store based on the type of certificate, or browse to a store of your choice.
- 6 Click **Finish** and click **OK**.

Setting the SSL Time on the DRAC 5

When the DRAC 5 authenticates an Active Directory user, the DRAC 5 also verifies the certificate published by the Active Directory server to ensure that the DRAC is communicating with an authorized Active Directory server.

This check also ensures that the validity of the certificate is within the time range specified by the DRAC 5. However, there could be a mismatch between the time zones specified on the certificate and the DRAC 5. This could happen when the DRAC 5 time reflects the local system time and the certificate reflects time in GMT.

To ensure that the DRAC 5 uses the GMT time to compare with the certificate times, you must set the time zone offset object.

```
racadm config -g cfgRacTuning -o  
cfgRacTuneTimeZoneOffset <offset value>
```

See "cfgRacTuneTimezoneOffset (Read/Write)" on page 380 for more details.

Supported Active Directory Configuration

The Active Directory querying algorithm of the DRAC 5 supports multiple trees in a single forest.

DRAC 5 Active Directory Authentication supports mixed mode (that is, the domain controllers in the forest run different operating systems, such as Microsoft Windows NT 4.0, Windows 2000, or Windows Server 2003). However, all objects used by the DRAC 5 querying process (among user, RAC Device Object, and Association Object) should be in the same domain. The Dell-extended Active Directory Users and Computers snap-in checks the mode and limits users in order to create objects across domains if in mixed mode.

DRAC 5 Active Directory supports multiple domain environments provided the domain forest function level is Native mode or Windows 2003 mode. In addition, the groups among Association Object, RAC user objects, and RAC Device Objects (including Association Object) must be universal groups.

 **NOTE:** The Association Object and the Privilege Object must be in the same domain. The Dell-extended Active Directory Users and Computers snap-in forces you to create these two objects in the same domain. Other objects can be in different domains.

Using Active Directory to Log Into the DRAC 5

You can use Active Directory to log in to the DRAC 5 using one of the following methods:

- Web-based interface
- Remote RACADM
- Serial or telnet console.

The login syntax is the same for all three methods:

`<username@domain>`

or

`<domain>\<username>` or `<domain>/<username>`

where *username* is an ASCII string of 1–256 bytes.

White space and special characters (such as \, /, or @) cannot be used in the user name or the domain name.

 **NOTE:** You cannot specify NetBIOS domain names, such as Americas, because these names cannot be resolved.

You can also log into the DRAC 5 using the Smart Card. For more information, see "Logging Into the DRAC 5 Using the Smart Card" on page 157.

Using Active Directory Single Sign-On

You can enable the DRAC 5 to use Kerberos—a network authentication protocol—to enable single sign-on and log into the DRAC 5. For more information on setting up the DRAC 5 to use the Active Directory Single Sign-On feature, see "Enabling Kerberos Authentication" on page 147.

Configuring the DRAC 5 to Use Single Sign-On

- 1 Navigate to **Remote Access**→ **Configuration** tab→ **Active Directory** subtab→ select **Configure Active Directory**.
- 2 On the **Active Directory Configuration and Management** page, select **Single Sign-On**.

This option enables you to log into the DRAC 5 directly after logging into your workstation.

Logging Into the DRAC 5 Using Single Sign-On

- 1 Log into your work station using your network account.
- 2 Access DRAC Web page using https.

`https://<IP address>`

If the default HTTPS port number (port 443) has been changed, type:

`https://<IP address>:<port number>`

where *IP address* is the IP address for the DRAC 5 and *port number* is the HTTPS port number.

The DRAC 5 Single Sign-On page appears.

- 3 Click **Login**.

The DRAC 5 logs you in, using your credentials that were cached in the operating system when you logged in using your valid Active Directory account.

Frequently Asked Questions

Are there any restrictions on Domain Controller SSL configuration?

Yes. All Active Directory servers' SSL certificates in the forest must be signed by the same root CA since DRAC 5 only allows uploading one trusted CA SSL certificate.

I created and uploaded a new RAC certificate and now the Web-based interface does not launch.

If you use Microsoft Certificate Services to generate the RAC certificate, one possible cause of this is you inadvertently chose **User Certificate** instead of **Web Certificate** when creating the certificate.

To recover, generate a CSR and then create a new web certificate from Microsoft Certificate Services and load it using the RACADM CLI from the managed system by using the following racadm commands:

```
racadm sslcsrgen [-g] [-u] [-f {filename}]  
racadm sslcertupload -t 1 -f {web_sslcert}
```

What can I do if I cannot log into the DRAC 5 using Active Directory authentication? How do I troubleshoot the issue?

- 1 Ensure that you use the correct user domain name during a login and not the NetBIOS name.
- 2 If you have a local DRAC user account, log into the DRAC 5 using your local credentials.

After you are logged in:

- a Ensure that you have checked the **Enable Active Directory** box on the DRAC 5 Active Directory configuration page.
- b Ensure that the DNS setting is correct on the DRAC 5 Networking configuration page.
- c Ensure that you have uploaded the Active Directory certificate from your Active Directory root CA to the DRAC 5.
- d Check the Domain Controller SSL certificates to ensure that they have not expired.

- e Ensure that your **DRAC Name**, **Root Domain Name**, and **DRAC Domain Name** match your Active Directory environment configuration.
- f Ensure that the DRAC 5 password has a maximum of 127 characters. While the DRAC 5 can support passwords of up to 256 characters, Active Directory only supports passwords that have a maximum length of 127 characters.

SSO login fails with Active Directory users on Windows 7 operating systems. What should I do to resolve this?

You must enable the encryption types for Windows 7. To enable the encryption types (for standard and extended schema):

- 1 Log in as administrator or as a user with administrative privilege.
- 2 Go to **Start** and run `gpedit.msc`.

The **Local Group Policy Editor** window is displayed.

- 3 Navigate to **Local Computer Settings**→**Windows Settings**→**Security Settings**→**Local Policies**→**Security Options**.
- 4 Right-click **Network Security: Configure encryption types allowed for kerberos** and select **Properties**.
- 5 Enable all the options and click **OK**.

You can now log in to iDRAC using SSO.

- 6 In the **Local Group Policy Editor** window, navigate to **Local Computer Settings**→**Windows Settings**→**Security Settings**→**Local Policies**→**Security Options**.

- 7 Right-click **Network Security: Restrict NTLM: Outgoing NTLM traffic to remote server** and select **Properties**.

- 8 Select **Allow all**, click **OK**, and then close the **Local Group Policy Editor** window.

- 9 Go to **Start** and run `cmd`.

The **command prompt** window is displayed.

- 10 Run the command `gpupdate /force`.

The group policies are updated.

- 11 Close the **command prompt** window.

Perform the following additional settings for extended schema:

- 1** Go to **Start** and run **regedit**.
The **Registry Editor** window is displayed.
- 2** Navigate to **HKEY_LOCAL_MACHINE**→ **System**→
CurrentControlSet→ **Control**→ **LSA**.
- 3** In the right-pane, right-click and select **New**→ **DWORD (32-bit) Value**.
- 4** Name the new key as **SuppressExtendedProtection**.
- 5** Right-click **SuppressExtendedProtection** and click **Modify**.
- 6** In the **Value data** field, type **1** and click **OK**.
- 7** Close the **Registry Editor** window.
You can now log in to iDRAC using SSO.

Enabling Kerberos Authentication

Kerberos is a network authentication protocol that allows systems to communicate securely over a non-secure network. It achieves this by allowing the systems to prove their authenticity.

Microsoft Windows 2000, Windows XP, Windows Server 2003, Windows Vista, and Windows Server 2008 use Kerberos as their default authentication method.

Starting with DRAC 5 version 1.40, the DRAC 5 uses Kerberos to support two types of authentication mechanisms—single sign-on and Active Directory Smart Card login. For the single-sign on, the DRAC 5 uses the user credentials cached in the operating system after the user has logged in using a valid Active Directory account.

Starting with DRAC 5 version 1.40, Active Directory authentication will use the Smart Card-based two factor authentication (TFA) in addition to the username-password combination, as valid credentials.

Prerequisites for Setting up Kerberos Authentication

- Configure the DRAC 5 for Active Directory login. For more information, see "Using Active Directory to Log Into the DRAC 5" on page 142.
- For the Active Directory users for whom you want to provide Kerberos authentication, set the following properties:
 - Use DES encryption types for this account
 - Do not require Kerberos pre-authentication
- Register the DRAC 5 as a computer in the Active Directory root domain.
 - a Navigate to **Remote Access**→ **Configuration** tab→ **Network** subtab→ **Network Settings**.
 - b Provide a valid **Preferred/Static DNS Server IP** address. This value is the IP address of the DNS that is part of the root domain, which authenticates the Active Directory accounts of the users.

- c** Select **Register DRAC on DNS**.
- d** Provide a valid **DNS Domain Name**.



NOTE: Ensure that the DNS name is resolved by the DNS server.

See the *DRAC 5 Online Help* for more information.

- Synchronize the DRAC 5 time settings with that of the Active Directory Domain Controller. Kerberos authentication on DRAC 5 fails if the DRAC time differs from the Domain Controller time. A maximum offset of 5 minutes is allowed. To enable successful authentication, synchronize the server time with the Domain Controller time and then **reset** the DRAC time.

You can also use the following RACADM time zone offset command to synchronize the time:

```
racadm config -g cfgRacTuning -o  
cfgRacTuneTimeZoneOffset offset-value
```

Offset value is the offset time in minutes.

- Install Microsoft Visual C++ 2005 Redistributable Package on the client system.
- Run the **ktpass** utility on Active Directory Server.

DRAC 5 is a device with a non-Windows operating system, so you need to run the **ktpass** utility— part of Microsoft Windows — on the Domain Controller (Active Directory server) where you want to map the DRAC 5 to a user account in Active Directory. To do this,

- a** Start the Active Directory Management tool.
- b** Right-click the **Users** folder, select **New**, and then click **User**.
- c** Type the name of the DRAC5 host for which you want to add Kerberos support.
- d** Save the user.

- e Start a command prompt, and then type the following command:

```
C:\>ktpass -princ HOST/dracname.domain-  
name.com@DOMAIN-NAME.COM -mapuser account -  
crypto DES-CBC-MD5 -ptype KRB5_NT_PRINCIPAL -  
pass password -out c:\krbkeytab
```

where:

- `dracname` is the DRAC 5's DNS name.
 - `domain-name` is the Active Directory domain name with which you want to authenticate. It should be replaced by the actual domain name in capital letters.
 - `account` is the user name, a valid user account that you created in Active Directory in step b and step c. It should be provided in the *domain-name.com/user-name* format.
 - `password` is the password for the user account.
 - `DES-CBC-MD5` is the encryption type that DRAC 5 uses for Kerberos authentication.
 - `KRB5_NT_PRINCIPAL` is the principal type.
- f Upload the resulting keytab file to the DRAC 5 host.

 **NOTE:** It is recommended that you use the latest **ktpass** utility to create the keytab file.

This procedure will produce a keytab file that you should upload to the DRAC 5.

 **NOTE:** The keytab contains an encryption key and should be kept secure.

For more information on the **ktpass** utility, see the Microsoft website at: <http://technet2.microsoft.com/windowsserver/en/library/64042138-9a5a-4981-84e9-d576a8db0d051033.mspx?mfr=true>

Configuring DRAC 5 for Kerberos Authentication

Upload the keytab obtained from the Active Directory root domain, to the DRAC 5:

- 1 Navigate to **Remote Access** → **Configuration** tab → **Active Directory** subtab.
- 2 Select **Upload Kerberos Keytab** and click **Next**.
- 3 On the **Kerberos Keytab Upload** page, select the keytab file to upload and click **Apply**.

Enabling Single Sign-On

Single Sign-On allows you to log into the DRAC without providing your credentials, after you have logged into the operating system using a valid Active Directory account. In this case, DRAC uses the credentials cached in the operating system. DRAC uses Kerberos, a network authentication protocol, for single sign-on.

Prerequisites for Setting up Single Sign-On

- Configure DRAC 5 for Active Directory login. For more information, see "Using Active Directory to Log Into the DRAC 5" on page 142.
- Set up Kerberos authentication for DRAC 5. For more information, see "Enabling Kerberos Authentication" on page 147.

Configuring DRAC 5 to Use Single Sign-On

- 1 Navigate to **Remote Access**→ **Configuration** tab→ **Active Directory** subtab and select **Configure Active Directory**.
- 2 On the **Active Directory Configuration and Management** page, select **Single Sign-On**.

This option enables you to log into DRAC 5 directly after logging into your workstation.

Logging Into DRAC 5 Using Single Sign-On

 **NOTE:** To log into the DRAC 5, ensure that you have the latest runtime components of Microsoft Visual C++ 2005 Libraries. For more information, see the Microsoft website.

- 1 Log into your system using a valid Active Directory account.
- 2 Type the web address of the DRAC 5 in the address bar of your browser.

 **NOTE:** Depending on your browser settings, you may be prompted to download and install the Single Sign-On ActiveX plug-in when using this feature for the first time.

You are logged into the DRAC 5.

Configuring Smart Card Authentication

The Dell Remote Access Controller 5 (DRAC 5) version 1.30 and later support the *two-factor-authentication* for logging into the DRAC 5 Web interface. This support is provided by the **Smart Card Logon** feature on the DRAC 5.

The traditional authentication schemes use user name and password to authenticate users. This provides minimal security.

Two-factor-authentication, on the other hand, provides a higher-level of security by requiring users to have a password or PIN and a private key for a digital certificate.

The two-factor authentication requires users to verify their identities by providing *both* factors.

Configuring Smart Card Login in DRAC 5

Enable the DRAC 5 Smart Card logon feature from **Remote Access**→**Configuration**→**Smart Card**.

If you:

- **Disable** Smart Card configuration, you are prompted for a Microsoft Active Directory or local logon username and password.
- **Enable** or **Enable with Remote Racadm**, you are prompted for a Smart Card logon during any subsequent logon attempts using the GUI.

When you select **Enable**, all command line interface (CLI) out-of-band interfaces, such as telnet, ssh, serial, remote racadm, and IPMI over LAN, are disabled. This is because these services support only single-factor authentication.

When you select **Enable with Remote Racadm**, all CLI out-of-band interfaces, except remote racadm, are disabled.

 **NOTE:** Dell recommends that the DRAC 5 administrator use the **Enable with Remote Racadm** setting only to access the DRAC 5 user interface to run scripts using the remote racadm commands. If the administrator does not need to use the remote racadm, Dell recommends the **Enabled** setting for Smart Card logon. Also, ensure that the DRAC 5 local user configuration and/or Active Directory configuration is complete before enabling **Smart Card Logon**.

- **Enable CRL check for Smart Card Logon**, the user's DRAC certificate, which is downloaded from the Certificate Revocation List (CRL) distribution server is checked for revocation in the CRL.

 **NOTE:** The CRL distribution servers are listed in the Smart Card certificates of the users.

Configuring Local DRAC 5 Users for Smart Card Logon

You can configure the local DRAC 5 users to log into the DRAC 5 using the Smart Card. Navigate to **Remote Access**→**Configuration**→**Users**.

However, before the user can log into the DRAC 5 using the Smart Card, you must upload the user's Smart Card certificate and the trusted Certificate Authority (CA) certificate to the DRAC 5.

Exporting the Smart Card Certificate

You can obtain the user's certificate by exporting the Smart Card certificate using the card management software (CMS) from the Smart Card to a file in the Base64 encoded form. You can usually obtain the CMS from the vendor of the Smart Card. This encoded file should be uploaded as the user's certificate to the DRAC 5. The trusted Certificate Authority that issues the Smart Card user certificates should also export the CA certificate to a file in the Base64 encoded form. You should upload this file as the trusted CA certificate for the user. Configure the user with the username that forms the user's User Principle Name (UPN) in the Smart Card certificate.

 **NOTE:** To log into the DRAC 5, the user name that you configure in the DRAC 5 should have the same case as the User Principle Name (UPN) in the Smart Card certificate.

For example, in case the Smart Card certificate has been issued to the user, "sampleuser@domain.com," the username should be configured as "sampleuser."

Configuring Active Directory Users for Smart Card Logon

To configure the Active Directory users to log into the DRAC 5 using the Smart Card, the DRAC 5 administrator should configure the DNS server, upload the Active Directory CA certificate to the DRAC 5, and enable the Active Directory logon. See "Using the DRAC 5 With Microsoft Active Directory" on page 105 for more information on how to set up Active Directory users.

You must configure Active Directory and Kerberos for Smart Card Active Directory login. See "Using the DRAC 5 With Microsoft Active Directory" on page 105 and "Enabling Kerberos Authentication" on page 147 for information on how to configure them.

You are logged into the DRAC with appropriate privileges if you are a local DRAC user.

You are logged into the DRAC with appropriate Microsoft Active Directory privileges if:

- you are a Microsoft Active Directory user
- you are configured in the DRAC for Active Directory login
- the DRAC is enabled for Kerberos Active Directory authentication

Configuring Smart Card



NOTE: To modify these settings, you must have **Configure DRAC 5** permission.

- 1 Expand the **System** tree and click **Remote Access**.
- 2 Click the **Configuration** tab and then click **Smart Card**.
- 3 Configure the Smart Card logon settings.
Table 9-1 provides information about the **Smart Card** page settings.
- 4 Click **Apply Changes**.

Table 9-1. Smart Card Settings

Setting	Description
Configure Smart Card Logon	<ul style="list-style-type: none">• Disabled — Disables Smart Card logon. Subsequent logins from the graphical user interface (GUI) display the regular login page. All command line out-of-band interfaces including secure shell (SSH), Telnet, Serial, and remote RACADM are set to their default state.• Enabled — Enables Smart Card logon. After applying the changes, logout, insert your Smart Card, enter your Smart Card PIN, and then click Login to log on to the DRAC. Enabling Smart Card logon disables all CLI out-of-band interfaces including SSH, Telnet, Serial, remote RACADM, and IPMI over LAN.• Enabled with Remote Racadm — Enables Smart Card logon along with remote RACADM. All other CLI out-of-band interfaces are disabled. <p>NOTE: The Smart Card logon requires you to configure the local DRAC 5 users with the appropriate certificates. If the Smart Card logon is used to log in a Microsoft Active Directory user, then you must ensure that you configure the Active Directory user certificate for that user. You can configure the user certificate in the Users→User Main Menu page.</p>
Enable CRL check for Smart Card Logon	<p>This check is available only for Smart Card local users. Select this option if you want the DRAC to check the Certificate Revocation List (CRL) for revocation of the user's Smart Card certificate. For the CRL feature to work, the DRAC must have a valid DNS IP address configured as part of its network configuration. You can configure the DNS IP address in DRAC under Remote Access→Configuration→Network.</p> <p>The user will not be able to login if:</p> <ul style="list-style-type: none">• The user certificate is listed as revoked in the CRL file.• DRAC is not able to communicate with the CRL distribution server.• DRAC is not able to download the CRL. <p>NOTE: You must correctly configure the IP address of the DNS server in the Configuration→Network page for this check to succeed.</p>

Logging Into the DRAC 5 Using the Smart Card

The DRAC 5 Web interface displays the Smart Card login page if you have enabled the Smart Card Logon feature.

 **NOTE:** Ensure that the DRAC 5 local user and/or Active Directory configuration is complete before enabling the Smart Card Logon for the user.

 **NOTE:** Depending on your browser settings, you may be prompted to download and install the Smart Card reader ActiveX plug-in when using this feature for the first time.

- 1 Access the DRAC 5 Web page using https.

`https://<IP address>`

If the default HTTPS port number (port 443) has been changed, type:

`https://<IP address>:<port number>`

where *IP address* is the IP address for the DRAC 5 and *port number* is the HTTPS port number.

The DRAC 5 **Login** page appears prompting you to insert the Smart Card.

- 2 Insert the Smart Card into the reader and enter your Smart Card PIN.
- 3 Click **Login**.

 **NOTE:** If you are an Active Directory user for whom the **Enable CRL check for Smart Card Logon** is selected, DRAC 5 attempts to download the CRL and checks the CRL for the user's certificate. The login through Active Directory fails if the certificate is listed as revoked in the CRL or if the CRL cannot be downloaded for any reason. Smart Card logon is supported only in Microsoft Internet Explorer.

Logging Into the DRAC 5 Using Active Directory Smart Card Authentication

- 1 Log into the DRAC 5 using https.

`https://<IP address>`

If the default HTTPS port number (port 443) has been changed, type:

`https://<IP address>:<port number>`

where *IP address* is the IP address for the DRAC 5 and *port number* is the HTTPS port number.

The DRAC 5 Login page is displayed prompting you to insert the Smart Card.

- 2 Insert the Smart Card into the reader and enter your Smart Card PIN.
- 3 Click Login.

You are logged into the DRAC 5 with your credentials as set in Active Directory. For more information, see "Enabling Kerberos Authentication" on page 147.

Troubleshooting the Smart Card Logon in DRAC 5

Use the following tips to help you debug an inaccessible Smart Card:

ActiveX plug-in unable to detect the Smart Card reader

Ensure that the Smart Card is supported on the Microsoft Windows operating system. Windows supports a limited number of Smart Card cryptographic service providers (CSPs).

Tip: As a general check to see if the Smart Card CSPs are present on a particular client, insert the Smart Card in the reader at the Windows logon (Ctrl-Alt-Del) screen and check to see if Windows detects the Smart Card and displays the PIN dialog-box.

Incorrect Smart Card PIN

Check to see if the Smart Card has been locked out due to too many attempts with an incorrect PIN. In such cases, the issuer of the Smart Card in the organization will be able to help you get a new Smart Card.

Unable to Log into Local DRAC 5

If a local DRAC 5 user cannot log in, check if the username and the user certificates uploaded to the DRAC 5 have expired. The DRAC 5 trace logs may provide important log messages regarding the errors; although the error messages are sometimes intentionally ambiguous due to security concerns.

Unable to Log into DRAC 5 as an Active Directory User

If you cannot log into the DRAC 5 as an Active Directory user, try to log into the DRAC 5 without enabling the Smart Card logon. If you have enabled the CRL check, try the Active Directory logon without enabling the CRL check. The DRAC 5 trace log should provide important messages in case of CRL failure.

You also have the option of disabling the Smart Card Logon through the local racadm using the following command:

```
racadm config -g cfgActiveDirectory -o  
cfgADSmartCardLogonEnable 0
```

Using GUI Console Redirection

This section provides information about using the DRAC 5 console redirection feature.

Overview

The DRAC 5 console redirection feature enables you to access the local console remotely in either graphic or text mode. Using console redirection, you can control one or more DRAC 5-enabled systems from one location.

Today with the power of networking and the Internet, you do not have to sit in front of each server to perform all the routine maintenance. You can manage the servers from another city or even from the other side of the world from your desktop or laptop computer. You can also share the information with others—remotely and instantly.

Using Console Redirection



NOTE: When you open a console redirection session, the managed system does not indicate that the console has been redirected.

The **Console Redirection** page enables you to manage the remote system by using the keyboard, video, and mouse on your local management station to control the corresponding devices on a remote managed system. This feature can be used in conjunction with the Virtual Media feature to perform remote software installations.

The following rules apply to a console redirection session:

- Only four simultaneous console redirection sessions are supported.
- Console redirection sessions can only be connected to one remote target system.
- You cannot configure a console redirection session on the local system.
- A minimum available network bandwidth of 1 MB/sec is required.

Supported Screen Resolutions Refresh Rates on the Managed System

Table 10-1 lists the supported screen resolutions and corresponding refresh rates for a console redirection session that is running on the managed system.

Table 10-1. Supported Screen Resolutions and Refresh Rates

Screen Resolution	Refresh Rate (Hz)
720x400	70
640x480	60, 72, 75, 85
800x600	60, 70, 72, 75, 85
1024x768	60, 70, 72, 75, 85
1280x1024	60

Configuring Your Management Station

To use Console Redirection on your management station, perform the following procedures:

- 1 Install and configure a supported Web browser. For a list of supported Web browsers, see the *Dell Systems Software Support Matrix* on the Dell Support website at support.dell.com/manuals.

 **CAUTION: Console Redirection and Virtual Media only support 32-bit Web browsers. Using 64-bit Web browsers may generate unexpected results or failure of operations.**

- "Configuring a Supported Web Browser" on page 43
- 2 Configure your monitor display resolution to at least 1280 x 1024 pixels at 60 Hz with 128 colors. Otherwise, you may not view the console in **Full Screen Mode**.
 - 3 If you are using the Java plug-in to connect, ensure that your system has Java Virtual Machine (JVM) version 1.6 update 21 or later installed.

Configuring Console Redirection

- 1 On your management station, open a supported Web browser and log into the DRAC 5. See "Accessing the Web-Based Interface" on page 48 for more information.
- 2 In the **System** tree, click **System**.
- 3 Click the **Console** tab and then click **Configuration**.
- 4 In the **Console Redirect Configuration** page, use the information in Table 10-2 to configure your console redirection session.
- 5 In DRAC 5 versions 1.40 and later, you can select the **Native** or **Java** plug-in type you want to install.
- 6 Click **Apply Changes** to save the settings.



NOTE: Any change in the Virtual Console configuration settings impacts or disconnects any existing user Virtual Console sessions.

Table 10-2. Console Redirection Configuration Page Information

Information	Description
Enabled	Checked = Enabled; Unchecked=Disabled
Max Sessions	Displays the number of console redirection sessions that are available.
Active Sessions	Displays the number of active console redirection sessions.
Keyboard and Mouse Port Number	Default = 5900
Video Port Number	Default = 5901
Video Encryption Enabled	Checked = Enabled; Unchecked=Disabled
Local Server Video Enabled	Checked = Enabled; Unchecked=Disabled
Plug-in Type	Enables you to select the Native (ActiveX for Windows and XPI plug-in for Linux) or Java plug-in. NOTE: If you select the Java plug-in, ensure that you already have the Java Virtual Machine (JVM) version 1.6 Update 21 or later installed on your system.

Table 10-2. Console Redirection Configuration Page Information (continued)

Information	Description
Default Access for Console Sharing	Select the default type of console sharing access to be provided to the console sharing request from the second user for console access when the first user is connected to the console. The access permissions are: <ul style="list-style-type: none">• No Access — Does not allow any access to the second user.• Read-only Access — Allows read-only access to the second user.• Full Access — Allows complete access to the second user.

The buttons in Table 10-3 are available on the **Console Redirect Configuration** page.

Table 10-3. Console Redirection Configuration Page Buttons

Property	Description
Print	Prints the Console Redirect Configuration page.
Refresh	Reloads the Console Redirect Configuration page.
Apply Changes	Saves your configuration settings.



NOTE: With DRAC 5 version 1.30 and later, you can disable console redirection for a remote user. For more information, see "Disabling DRAC 5 Remote Virtual KVM" on page 214.

Opening a Console Redirection Session

When you open a console redirection session, the Dell Virtual KVM Viewer Application starts and the remote system's desktop appears in the viewer. Using the Virtual KVM Viewer Application, you can control the system's mouse and keyboard functions from a local or remote management station.

To open a console redirection session:

- 1 On your management station, open a supported Web browser and log into the DRAC 5. See "Accessing the Web-Based Interface" on page 48 for more information.
- 2 In the **System** tree, click **System** and then in the **Console** tab, click **Console Redirect**.



NOTE: If you receive a security warning prompting you to install and run the Console Redirection plug-in, verify the plug-in's authenticity and then click **Yes** to install and run the plug-in. If you are running Firefox, restart the browser and then go to step 1.

- 3 In the **Console Redirection** page, use the information in Table 10-4 to ensure that a console redirection session is available.

Table 10-4. Console Redirection Page Information

Property	Description
Console Redirection Enabled	Yes/No
Video Encryption Enabled	Yes/No
Local Server Video Enabled	Yes/No
Status	Connected or Disconnected
Max Sessions	The maximum number of supported console redirection sessions.
Active Sessions	The current number of active console redirection sessions.
Plug-in Type	The plug-in type you selected in the Console Redirect Configuration page.
Default Access for Console Sharing	The default type of console sharing access to be provided to the request from the second user when the first user is connected to the console. The access permissions are: <ul style="list-style-type: none">• No Access — Indicates access is denied to the second user.• Read-only Access — Indicates read-only access to the second user.• Full Access — Indicates complete access to the second user.

The buttons in Table 10-5 are available on the **Console Redirection** page.

Table 10-5. Console Redirection Page Buttons

Button	Definition
Refresh	Reloads the Console Redirection Configuration page
Connect	Opens a console redirection session on the targeted remote system.
Print	Prints the Console Redirection Configuration page.

- 4 To open a new console, click **Connect**.



NOTE: DRAC 5 supports four simultaneous console redirections. If you have opened a session and another user tries to open a different session in the same managed system, you receive a request for granting permission to the user. You can permit or deny access. If you do not provide permission within 30 seconds, the request is deactivated.

If you are using a Firefox browser, it will prompt you to Open or Save a JNLP file. You can open it with the *Java Web Start Launcher*. If you choose to save the JNLP file, manually open it before you disconnect the session. Once you disconnect the session, the JNLP file saved cannot be validated. If you are using Internet Explorer, it caches the JNLP file in the *Temporary Internet Files* folder and runs automatically using the *Java Web Start Launcher*.



NOTE: If one or more **Security Alert** windows appear in the following steps, read the information in the window and click **Yes** to continue.

When you have finished using the Console and have logged out (using the remote system's logout procedure), click **Disconnect** on the Console Redirection page or close the Viewer.

The management station connects to the DRAC 5 and the remote system's desktop appears in the Dell Digital KVM Viewer Application.

- 5 If two mouse pointers appear on the remote system's desktop, synchronize the mouse pointers on the management station and the remote system. See "Synchronizing the Mouse Pointers" on page 172.

Disabling or Enabling Local Video

To disable or enable local video, perform the following procedure:

- 1 On your management station, open a supported Web browser and log into the DRAC 5. See "Accessing the Web-Based Interface" on page 48 for more information.
- 2 In the **System** tree, click **System**.
- 3 Click the **Console** tab and then click **Configuration**.
- 4 If you want to enable (turn ON) local video on the server, in the **Console Redirect Configuration** page, select the **Local Server Video Enabled** check-box and then click **Apply Changes**. The default value is ON.
- 5 If you want to disable (turn OFF) local video on the server, in the **Console Redirect Configuration** page, deselect the **Local Server Video Enabled** check box and then click **Apply Changes**.

The **Console Redirection** page displays the status of the Local Server Video.



NOTE: The local server video enabled feature is supported on all x9xx PowerEdge systems except PowerEdge SC1435 and 6950.



NOTE: By disabling (turning OFF) the local video on the server, only the monitor connected to the local server will be disabled.



NOTE: With DRAC 5 version 1.30 and later, you can disable console redirection for a remote user. For more information, see "Disabling DRAC 5 Remote Virtual KVM" on page 214.

Using the Video Viewer

The Video Viewer provides a user interface between the management station and the remote system, allowing you to see the remote system's desktop and control its mouse and keyboard functions from your management station. When you connect to the remote system, the Video Viewer starts in a separate window.

The Video Viewer provides various control adjustments such as video calibration, mouse acceleration, and snapshots. Click **Help** for more information on these functions.

When you start a console redirection session and the Video Viewer appears, you may be required to adjust the following controls in order to view and control the remote system properly. These adjustments include:

- Accessing the Viewer Menu Bar
- Adjusting the video quality
- Synchronizing the mouse pointers

Accessing the Viewer Menu Bar

The viewer menu bar is a hidden menu bar. To access the menu bar, move your cursor near the top-center edge of the Viewer's desktop window.

Also, the menu bar can be activated by pressing the default function key <F9>. To reassign this function key to a new function:

- 1 Press <F9> or move your mouse cursor to the top of the Video Viewer.
- 2 Press the "push pin" to lock the viewer menu bar.
- 3 In the viewer menu bar, click **Tools** and select **Session Options**.
- 4 In the **Session Options** window, click the **General** tab.
- 5 In the **General** tab window in the **Menu Activation Keystroke** box, click the drop-down menu and select another function key.
- 6 Click **Apply**, and then click **OK**.

Table 10-6 provides the main features that are available for use in the viewer menu bar.

Table 10-6. Viewer Menu Bar Selections

Menu Item	Item	Description
File	Capture to File	Captures the current remote system screen to a .bmp (Windows) or .png (Linux) file on the local system. A dialog box is displayed that allows you to save the file to a specified location.
	Exit	Exits the Console Redirection page.

Table 10-6. Viewer Menu Bar Selections (continued)

Menu Item	Item	Description
View	Refresh	Updates the entire remote system-screen viewport.
	Full Screen	Expands the session screen from a window to full screen.
Macros	Various keyboard shortcuts	<p>Executes a keystroke combination on the remote system.</p> <p>To connect your management station's keyboard to the remote system and run a macro:</p> <ol style="list-style-type: none">1 Click Tools.2 In the Session Options window, click the General tab.3 Select Pass all keystrokes to target.4 Click OK.5 Click Macros.6 In the Macros menu, click a keystroke combination to execute on the target system.

Table 10-6. Viewer Menu Bar Selections (continued)

Menu Item	Item	Description
Tools	Automatic Video Adjust	Recalibrates the session viewer video output.
	Manual Video Adjust	Provides individual controls to manually adjust the session viewer video output. NOTE: Adjusting the horizontal position off-center desynchronizes the mouse pointers.
	Session Options	Provides additional session viewer control adjustments. The Mouse tab enables you to optimize mouse performance depending upon your operating system. Select a terminating keystroke from the drop down menu to exit single cursor mode. The Terminating Keystroke option is available if the plug-in type is Java . The General tab provides the following options: <ul style="list-style-type: none">• Keyboard pass through mode — Select Pass all keystrokes to target to pass your management station's keystrokes to the remote system.• Menu Activation Keystroke — Selects the function key that activates the viewer menu bar. The Toolbar Hide Delay list box lets you adjust the interval between the removal of the mouse cursor and the disappearance of the menu bar when the thumbtack button on the menu bar is not clicked. This option is available if the plug-in type is Native .
Help	N/A	Activates the Help menu.

Adjusting the Video Quality

The Video Viewer provides video adjustments that allow you to optimize the video for the best possible view. Click **Help** for more information.

To automatically adjust the video quality:

- 1 Access the Viewer Menu Bar. See "Accessing the Viewer Menu Bar" on page 168.
- 2 Click **Tools** and select **Automatic Video Adjust** (for **Native** plug-in) or **Video Settings** (for **Java** plug-in) to automatically adjust the video quality of the Viewer window.

To manually adjust the video quality:

- 1 Access the Viewer Menu Bar. See "Accessing the Viewer Menu Bar" on page 168.
- 2 Click **Tools** and select **Manual Video Adjust** (for **Native** plug-in) or **Video Settings** (for **Java** plug-in).
- 3 In the **Manual Video Adjust** window, click each video adjustment button and adjust the controls as needed.
- 4 When finished, click **Close** to exit the **Manual Video Adjust** dialog box.

When you manually adjust the video quality, observe the following guidelines:

- To prevent the mouse pointers from desynchronizing, adjust the horizontal setting so the remote system's desktop is centered in the session window.
- Reducing the Pixel Noise Ratio setting to zero causes multiple video refresh commands that generates excessive network traffic and flickering video in the Video Viewer window. Dell recommends that you adjust the Pixel Noise Ratio setting at a level that provides optimal system performance and pixel enhancement while minimizing network traffic.

Synchronizing the Mouse Pointers

When you connect to a remote Dell system using Console Redirection, the mouse acceleration speed on the remote system may not synchronize with the mouse pointer on your management station, causing two mouse pointers to appear in the Video Viewer window.

To synchronize the mouse pointers:

- 1 Access the Viewer Menu Bar. See "Accessing the Viewer Menu Bar" on page 168.
- 2 Click **Tools** and select **Session Options**.
- 3 Click the **Mouse** tab, select your management station's operating system, and click **OK**.
- 4 Click **Tools** and select **Manual Video Adjust**.
- 5 Adjust the horizontal controls so the remote system's desktop appears in the center of the session window.
- 6 Click **OK**.

When using Linux (Red Hat or Novell), the operating system's default mouse settings are used to control the mouse arrow in the DRAC 5 Console Redirection screen.



NOTE: On Linux (Red Hat or Novell) systems, there are known mouse arrow synchronization issues. To minimize mouse synchronization problems, ensure that all users use the default mouse settings.

For information on disabling the console redirection, see "Disabling DRAC 5 Remote Virtual KVM" on page 214.

Using Power Control Option

The Power Control option allows you to do the following on the managed system:

- Power on the system
- Power off the system
- Reset the system
- Power cycle the system

To control power on the managed system:

- 1** Access the Viewer Menu Bar. See "Accessing the Viewer Menu Bar" on page 168.
- 2** Click **Tools** and then click **Power Control**.
- 3** Click any of the options provided:
 - Power on the system.
 - Power off the system.
 - Reset the system. Restart the system without powering it off.
 - Power cycle the system. Restart the system after powering it off.A pop-up window is displayed.
- 4** Click **Yes** and click **OK**.

Frequently Asked Questions

Can a new remote console video session be started when the local video on the server is turned OFF?

Yes.

Why does it take 15 seconds to turn OFF the local video on the server after requesting to turn OFF the local video?

It gives a local user an opportunity to take any action before the video is switched OFF.

Is there a time delay when turning ON the local video?

No, once a local video turn ON request is received by DRAC 5 the video is turned ON instantly.

Can the local user also turn OFF the video?

Yes, a local user can use racadm CLI (local) to turn OFF the video.

Can the local user also turn ON the video?

Yes, the user should have racadm CLI installed on the server and only if the user is able to access the server over an RDP connection, such as terminal services, telnet, or SSH. The user can then log on to the server and can run racadm (local) to turn ON the video.

My local video is turned OFF and for some reason my DRAC 5 is not accessible remotely and the server is not accessible with RDP, telnet, or SSH. How do I recover the local video?

The only way to recover the local video in this case is by removing the AC power cord from the server, draining the server free power and reconnecting the AC power cord; this will bring back the local video on the server monitor. Also, the DRAC 5 configuration is changed to local video ON (default). The DRAC 5 needs to be reconfigured if the local video needs to be turned OFF again.

Does switching OFF the local video also switch OFF the local keyboard and mouse?

No, switching OFF the local video only switches OFF the video going from the server's monitor output connector; it will *not* switch off the keyboard and mouse connected locally to the server.

Does turning off the local server video turn off the video on the remote vKVM session?

No, turning the local video ON or OFF is independent of the remote console session.

What privileges are needed for a DRAC 5 user to turn ON or OFF the local server video?

Any user with DRAC 5 configuration privileges can turn the local server video ON or OFF.

How can I get the current status of the local server video?

The status is displayed on the **Console Redirection Configuration** page of the DRAC 5 web-based interface. The `racadm` CLI command `racadm getconfig -g cfgRacTuning` displays the status in the object `cfgRacTuneLocalServerVideo`. The status is also seen by the local user on the server LCD screen as “Video OFF” or as “Video OFF in 15”.

Why is it that sometimes I do not see the “Video OFF” or “Video OFF in 15” status on the server LCD screen?

The local video status is a low-priority message and will get masked if a high priority server event has occurred. The LCD messages are based on priority; you must resolve any high-priority LCD messages and once that event is cleared or resolved, the next low priority message is displayed. The server video message on the LCD screen is informational in nature.

Where can I get more information on the Local Server Video feature?

See the Dell Support website at support.dell.com/manuals for a white paper discussing this feature.

I see video corruption on my screen. How do I fix this issue?

In the **Console Redirection** window, click **Refresh** to refresh the screen.



NOTE: You may need to click **Refresh** several times to correct the video corruption.

During Console Redirection, the keyboard and mouse are locked after hibernation on a Windows 2000 system. What caused this to happen?

To resolve this issue, reset the DRAC 5 by running the `racadm racreset` command.

I cannot see the bottom of the system screen from the Console Redirection window.

Ensure that the management station’s monitor resolution is set to 1280x1024.

During Console Redirection, the mouse is locked after hibernation on a Windows Server 2003 system. Why did this happen?

To resolve this issue, select an operating system other than Windows for mouse acceleration from the virtual KVM (vKVM) window pull-down menu, wait 5 to 10 seconds, and then select Windows again. If the problem is not resolved, you must reset the DRAC 5 by running the `racadm racreset` command.

If the problem is still not resolved, you must reset the DRAC 5 by running the `racadm racreset hard` command.

Why aren't the vKVM keyboard and mouse working?

You must set the USB controller to **On with BIOS support** in the BIOS settings of the managed system. Restart the managed system and press <F2> to enter setup. Select **Integrated Devices**, and then select **USB Controller**. Save your changes and restart the system.

Why does the managed system console screen go blank when Windows has a blue screen?

The managed system does not have the correct ATI video driver. You must update the video driver with the *Dell Systems Management Tools and Documentation DVD*.

Why do I get a blank screen on the remote console after completing a Windows 2000 installation?

The managed system does not have the correct ATI video driver. The DRAC 5 Console Redirection will not run correctly on the SVGA video driver on the Windows 2000 distribution CD. You must install Windows 2000 using the *Dell Systems Management Tools and Documentation DVD* to ensure that you have the latest, supported drivers for the managed system.

Why do I get a blank screen on the managed system when loading the Windows 2000 operating system?

The managed system does not have the correct ATI video driver. You must update the video driver by using the *Dell Systems Management Tools and Documentation DVD*.

Why do I get a blank screen on the managed system in the Windows full screen DOS window?

The managed system does not have the correct ATI video driver. You must update the video driver by using the *Dell Systems Management Tools and Documentation DVD*.

Why can't I enter BIOS setup by pressing the <F2> key?

This behavior is typical in a Windows environment. Use your mouse to click on an area of the Console Redirection window to adjust the focus. To move the focus to the bottom menu bar of Console Redirection window, use the mouse and click one of the objects on the bottom menu bar.

Why doesn't the vKVM mouse sync when I use the *Dell Systems Management Tools and Documentation DVD* to remotely install the operating system?

Configure Console Redirection for the operating system that is running on the target system.

- 1** In the vKVM toolbar menu, click **Tools** and select **Session Options**.
- 2** In the **Session Options** window, click the **Mouse** tab.
- 3** In the **Mouse Acceleration** box, select the operating system that is running on the target system and click **OK**.

Why doesn't the vKVM mouse sync after coming back from hibernation on a Windows system?

Select a different operating system for mouse acceleration on the vKVM window pull-down menu. Next, return to the original operating system to initialize the USB mouse device.

- 1** In the vKVM toolbar, click **Tools** and select **Session Options**.
- 2** In the **Session Options** window, click the **Mouse** tab.
- 3** In the **Mouse Acceleration** box, select another operating system and click **OK**.
- 4** Initialize the USB mouse device.

Why doesn't the mouse sync in DOS when performing Console Redirection?

The Dell BIOS is emulating the mouse driver as a PS/2 mouse. By design, the PS/2 mouse uses relative position for the mouse pointer, which causes the sync lag. DRAC 5 has a USB mouse driver, which allows absolute position and closer tracking of the mouse pointer. Even if DRAC 5 passes the USB absolute mouse position to the Dell BIOS, the BIOS emulation would convert it back to relative position and retain the behavior.

Why doesn't the mouse sync under the Linux text console?

Virtual KVM requires the USB mouse driver, but the USB mouse driver is available only under the X-Window operating system.

I am still having issues with mouse synchronization.

Ensure that the target system's desktop is centered in the console redirection window.

- 1** In the vKVM toolbar, click **Tools** and select **Manual Video Adjustment**.
- 2** Adjust the horizontal and vertical controls as needed to align the desktop in the console redirection window.
- 3** Click **Close**.
- 4** Move the target system's mouse cursor to the top left corner of the console redirection window, and then move the cursor back to the center of the window.
- 5** Repeat step 2 through step 4 until both cursors are synchronized.

Why doesn't the vKVM mouse and keyboard work when changing mouse acceleration for different operating systems?

The USB vKVM keyboard and mouse are inactive from 5 to 10 seconds after changing the mouse acceleration. The network load can sometimes cause this operation to take longer than normal (more than 10 seconds).

Why can't I see the bottom of the server screen from the vKVM window?

Ensure that the server screen resolution is 1280 x 1024 pixels at 60 Hz with 128 colors.

Why can't I use a keyboard or mouse while installing a Microsoft operating system remotely by using DRAC5 Console Redirection?

When you remotely install a supported Microsoft operating system on a system with Console Redirection enabled in the BIOS, you receive an EMS Connection Message that requires you to select **OK** before you can continue. You cannot use the mouse to select **OK** remotely. You must either select **OK** on the local system or restart the remotely managed system, reinstall, and then turn Console Redirection Off in the BIOS.

This message is generated by Microsoft to alert the user that Console Redirection is enabled. To ensure that this message does not appear, always turn off Console Redirection in the BIOS before installing an operating system remotely.

Why does console redirection fail to show the operating system boot menu in the Chinese, Japanese, and Korean versions of Microsoft Windows 2000?

On systems running Windows 2000 that can boot to multiple operating systems, change the default boot operating system by performing the following steps:

- 1** Right-click the **My Computer** icon and select **Properties**.
- 2** Click the **Advanced** tab.
- 3** Click **Startup and Recovery**.
- 4** Select the new default operating system from the **Startup** list.
- 5** In the **Show list for** box, type the number of seconds that the list of choices should be displayed before the default operating system automatically boots.

Why doesn't the Num Lock indicator on my management station reflect the status of the Num Lock on the remote server?

When accessed through the DRAC 5, the Num Lock indicator on the management station does not necessarily coincide with the state of the Num Lock on the remote server. The state of the Num Lock is dependent on the setting on the remote server when the remote session is connected, regardless of the state of the Num Lock on the management station.

Why do multiple Session Viewer windows appear when I establish a console redirection session?

You are configuring a console redirection session to the local system. Reconfigure the session to a remote system.

If I am running a console redirection session and a local user accesses the remote system, do I receive a warning message?

No. If a local user accesses the system, he/she can override your actions without sending a warning.

How much bandwidth do I need to run a console redirection session?

Dell recommends a 5 MB/sec connection for good performance. A 1 MB/sec connection is required for minimal performance.

What are the minimum system requirements for my management station to run console redirection?

The management station requires an Intel Pentium III 500 MHz processor with at least 256 MB of RAM.

What are the maximum number of console redirection sessions that I can run on a remote system?

The DRAC 5 supports up to two simultaneous console redirection sessions.

Why do I have mouse synchronization problems?

On Linux (Red Hat or Novell) systems, there are known mouse arrow synchronization issues. To minimize mouse synchronization problems, ensure that all users use the default mouse settings.

How can I install a Web browser on my management station that has a read-only file system?

If you are running Linux and your management station has a read-only file system, a browser can be installed on a client system without requiring a connection to a DRAC 5. By using the native plug-in installation package, the browser can be manually installed during the client setup phase.

⚠ CAUTION: In a read-only client environment, if the DRAC 5 firmware is updated to a newer version of the plug-in, the installed virtual media plug-in becomes inoperative. This is because earlier plug-in features are not allowed to function when the firmware contains a newer plug-in version. In this case, you are prompted for plug-in installation. Since the file system is read-only, the installation fails and the plug-in features are not available.

To obtain the plug-in installation package:

- 1 Log into an existing DRAC 5.
- 2 Change the URL in the browser's address bar, from:
`https://<RAC_IP>/cgi-bin/webcgi/main`

to:

`https://<RAC_IP>/plugins/` # Be sure to include the trailing slash.

- 3 Notice the two subdirectories `vm` and `vkvm`. Navigate to the appropriate subdirectory, right click the `rac5XXX.xpi` file, and select **Save Link Target As...**
- 4 Choose a location to save the plug-in installation package file.

To install the plug-in installation package:

- 1 Copy the installation package to the client's native file system share that is accessible by the client.
- 2 Open an instance of the browser on the client system.
- 3 Enter the file-path to the plug-in installation package in the browser's address bar. For example:

```
file:///tmp/rac5vm.xpi
```

- 4 The browser guides the user through plug-in installation.

Once installed, the browser will not prompt for that plug-in installation again, as long as the target DRAC5 firmware does not contain a newer version of the plug-in.

Why does the console redirection session end when I reboot my terminal?

When the DRAC 5 NIC settings are in "shared" or "shared with failover" mode, a system reset causes the LAN On Motherboard (LOM) to reset. On networks that have switches with the Spanning Tree Protocol (STP) enabled, this causes the connection between the management station and the client to be re-established after approximately ten to fifteen seconds. As a result, connectivity with the remote system is lost and a connection lost error message is displayed on the console redirection and virtual media clients. If you access the DRAC GUI at this time, you will receive "Page Not Found" error message.

To work around this issue:

- Use the DRAC 5 dedicated NIC for connection over the network.
- Disable STP on the network switches.

Using and Configuring Virtual Media

Overview

The Virtual Media feature provides the managed system with a virtual CD drive, which can use standard media from anywhere on the network. Figure 11-1 shows the overall architecture of virtual media.

Figure 11-1. Overall Architecture of Virtual Media

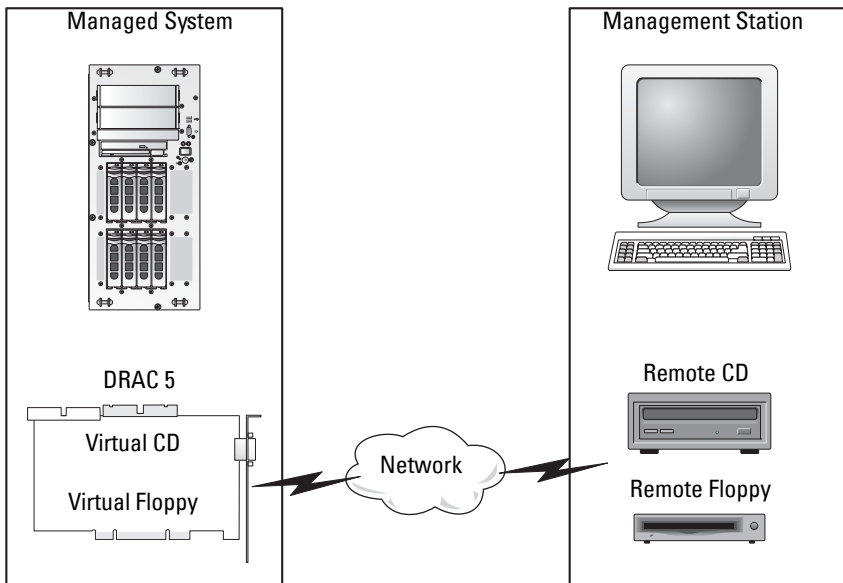

Using Virtual Media, administrators can remotely boot their managed systems, install applications, update drivers, or even install new operating systems remotely from the virtual CD/DVD and diskette drives.



NOTE: Virtual media requires a minimum available network bandwidth of 128 Kbps.

The managed system is configured with a DRAC 5 card. The virtual CD and floppy drives are two electronic devices embedded in the DRAC 5 that are controlled by the DRAC 5 firmware. These two devices are present on the managed system's operating system and BIOS at all times, whether virtual media is connected or disconnected.

The management station provides the physical media or image file across the network. When you launch the RAC browser for the first time and you access the virtual media page, the virtual media plug-in is downloaded from the DRAC 5 Web server and is automatically installed on the management station. The virtual media plug-in must be installed on the management station for the virtual media feature to function properly.

When virtual media is connected, all virtual CD/floppy drive access requests from the managed system are directed to the management station across the network. Connecting virtual media is identical to inserting media into virtual devices. When virtual media is not connected, virtual devices on the managed system appear as two drives without media installed in the drives.

 **NOTE:** You can connect to a virtual media using browser plug-in or Java plug-in.

Table 11-1 lists the supported drive connections for virtual floppy and virtual optical drives.

 **NOTE:** Changing virtual media while connected could stop the system boot sequence.

Table 11-1. Supported Drive Connections

Supported Virtual Floppy Drive Connections	Supported Virtual Optical Drive Connections
Legacy 1.44 floppy drive with a 1.44 floppy diskette	CD-ROM, DVD, CDRW, combination drive with CD-ROM media
USB floppy drive with a 1.44 floppy diskette	CD-ROM image file in the ISO9660 format
1.44 floppy image	USB CD-ROM drive with CD-ROM media.

Installing Virtual Media Browser Plug-In

The virtual media browser plug-in must be installed on your management station to use the virtual media feature. After you open the DRAC 5 user interface and launch the Virtual Media page, the browser automatically downloads the plug-in, if required. If the plug-in is successfully installed, the Virtual Media page displays a list of floppy diskettes and optical disks that connect to the virtual drive.

Windows-Based Management Station

To run the virtual media feature on a management station running the Microsoft Windows operating system, install a supported version of Internet Explorer with the ActiveX Control plug-in. Set the browser security to **Medium** or a lower setting to enable Internet Explorer to download and install signed ActiveX controls.

Additionally, you must have administrator rights to install and use the virtual media feature. Before installing the ActiveX control, Internet Explorer may display a security warning. To complete the ActiveX control installation procedure, accept the ActiveX control when Internet Explorer prompts you with a security warning.

Linux-Based Management Station

To run the virtual media feature on a management station running the Linux operating system, install a supported version of Mozilla or Firefox. If the virtual media plug-in is not installed or if a newer version is available, a dialog box appears during the installation procedure to confirm the plug-in installation on the management station. Ensure that the user ID running the browser has write permissions in the browser's directory tree. If the user ID does not have write permissions, you cannot install the virtual media plug-in. See the *Dell Systems Software Support Matrix* on the Dell Support website at support.dell.com/manuals for more information.

Running Virtual Media

 **CAUTION: Do not issue a racreset command when running a Virtual Media session. Otherwise, undesired results may occur, including loss of data.**

Using Virtual Media, you can "virtualize" a diskette image or drive, enabling a floppy image, floppy drive, or optical drive on your management console to become an available drive on the remote system. You can connect to a virtual media using the browser plug-in or Java plug-in. If you are using Java plug-in, ensure that Java Runtime Environment (JRE) 1.6 or later is installed on the management system.

Supported Virtual Media Configurations

You can enable Virtual Media for one floppy drive and one optical drive. Only one drive for each media type can be virtualized at a time.

Supported floppy drives include a floppy image or one available floppy drive. Supported optical drives include a maximum of one available optical drive or one ISO image file.

Running Virtual Media Using the Web User Interface

Connecting Virtual Media Using the Native Plug-in

- 1 Open a supported Web browser on your management station. For a list of supported Web browsers, see the *Dell Systems Software Support Matrix* on the Dell Support website at support.dell.com/manuals.

 **CAUTION: Console Redirection and Virtual Media only support 32-bit Web browsers. Using 64-bit Web browsers may generate unexpected results or failure of operations.**

- 2 Connect and log into the DRAC 5. See "Accessing the Web-Based Interface" on page 48 for more information.
- 3 Click the **Media** tab and then click **Virtual Media**.

The **Virtual Media** page appears with the client drives that can be virtualized.

 **NOTE:** The **Floppy Image File** under **Floppy Drive** (if applicable) may appear, as this device can be virtualized as a virtual floppy. You can select one optical drive and one floppy at the same time, or a single drive.

 **NOTE:** The virtual device drive letters on the managed system do not coincide with the physical drive letters on the management station.

- 4 If prompted, follow the on-screen instructions to install the virtual media plug-in.
- 5 In the **Attribute** box, perform the following steps:
 - a In the **Value** column, ensure that the **Attach/Detach** status value is **Attached**.

If the value is **Detached**, perform the following steps:

- In the **Media** tab, click **Configuration**.
- In the **Value** column, ensure that the **Attach Virtual Media** check box is selected.
- Click **Apply Changes**.
- In the **Virtual Media** tab, click **Virtual Media**.
- In the **Value** column, ensure that the **Attach/Detach** status value is **Attached**.

 **NOTE:** After the Virtual Media is attached, you can change the Boot Order only through RACADM, the **Configuration** page does not allow you to change any configuration of the Boot Order device.

- b Ensure that the **Current Status** value is **Not connected**. If the **Value** field displays connected, you must disconnect from the image or drive before reconnecting. This status denotes the current status of the Virtual Media connection on the current Web-based interface only.
- c Ensure that the **Active Session** value is **Available**. If the **Value** field display **In Use**, you must wait for the existing Virtual Media session to be released or terminate it by going to the Session Management tab under Remote Access and terminating the active Virtual Media session.

Only one active Virtual Media session is allowed at one time. This session could have been created by any Web-based interface or VM-CLI utility.

- d Select the **Encryption Enabled** check box to establish an encrypted connection between the remote system and your management station (if desired).
- 6 If you are virtualizing a floppy image or ISO image, select **Floppy Image File** or **ISO Image File** and enter or browse to the image file you want to virtualize.
If you are virtualizing a floppy drive or an optical drive, select the button next to the drives that you want to virtualize.
- 7 Click **Connect**.

If the connection is authenticated, the connection status becomes **Connected** and a list of all connected drives is displayed. All available diskette images and drives you selected become available on the managed system's console as though they are real drives.



NOTE: The assigned virtual drive letter (for Microsoft Windows systems) or device special file (for Linux systems) may not be identical to the drive letter on your management console.



NOTE: Virtual Media may not function properly on Windows operating system clients that are configured with Internet Explorer Enhanced Security. To resolve this issue, see your Microsoft operating system documentation or contact your administrator.

Disconnecting Virtual Media

Click **Disconnect** to disconnect all virtualized images and drives from the management station. All virtualized images or drives disconnect and are no longer available on the managed system.

Connecting Virtual Media Using Java Plug-in

- 1 Open a supported Web browser on your management station. For a list of supported Web browsers, see the *Dell Systems Software Support Matrix* on the Dell Support website at support.dell.com/manuals.
- 2 Connect and log into the DRAC 5. For more information, see "Accessing the Web-Based Interface" on page 48.

- 3 Click the **Media** tab and then click **Virtual Media**.

The **Virtual Media** page is displayed with the client drives that can be virtualized.



NOTE: The plug-in with which you can connect to a virtual media depends on the plug-in type you selected in the **Configuration** tab.

- 4 In the **Attribute** box, perform the following steps:
 - a In the **Value** column, ensure that the **Attach/Detach** status value is **Attached**.

If the value is **Detached**, perform the following steps:

- In the **Media** tab, click **Configuration**.
- In the **Value** column, ensure that the **Attach Virtual Media** is selected as **Attach**.
- In the **Value** column, select the **Plug-in Type** as **Java Plug-in**.
- Click **Apply Changes**.
- In the **Virtual Media** tab, click **Virtual Media**.



NOTE: Ensure that JRE 1.6 or later is installed in the management system.

- b Ensure that the **Active Session** value is **0**. If the **Value** field displays **1**, wait for the existing **Virtual Media** session to be released or terminate it by accessing the **Session Management** tab under **Remote Access**. Only one active **Virtual Media** session is allowed at one time. This session may have been created by any **Web-based** interface or **VM-CLI** utility.

- 5 Click **Launch VM**.

The **Virtual Media** Session pop-up window is displayed. The pop-up window displays the drivers you can virtualize.

- 6 If a device is already virtualized, disconnect it by deselecting the **Mapped** check-box associated with the driver.

- 7 To virtualize a floppy image or ISO image, click **Add Image** and select an image.
- 8 Click the **Mapped** check-box associated with the driver or image that you want to connect.

The device in the managed system to which the driver or image attached is displayed in the **Details** table.

Disconnecting Virtual Media

Deselect the **Mapped** check box associated with a driver or image.

Attaching and Detaching the Virtual Media Feature

The DRAC 5 Virtual Media feature is based on USB technology and can take advantage of the USB plug and play features. DRAC 5 adds the option to attach and detach the virtual devices from the USB bus. When the devices are detached, the operating system or BIOS cannot see any attached drives. When the virtual devices are attached, the drives are visible. Unlike DRAC 4, where the drives could only be enabled or disabled at the next system boot, DRAC 5 virtual devices can be attached or detached at any time.

The virtual devices can be attached or detached using a Web browser, local racadm, remote racadm, telnet, and serial port. To configure virtual media using a Web browser, you can navigate to the **Media** page and then to the **Configuration** page where you can change settings and apply them. You may also specify the **Virtual Media Port Number** and the **Virtual Media SSL Port Number**. In addition, you can enable or disable the Virtual Flash and the Boot Once feature. See "cfgVirtualBootOnce (Read/Write)" on page 389 for information on the Boot Once feature. If this property is set to a supported device and when the host server is rebooted, the feature will attempt to boot from the selected device—if the appropriate media is installed in the device.

Auto-Attaching Virtual Media

DRAC 5 firmware version 1.30 and later support the auto-attach virtual media feature. When you enable this feature, DRAC 5 will automatically attach a virtual device to the system only when a device is virtualized (connected) on a supported client.

The DRAC 5 will detach the virtual media devices when the virtual media session is disconnected.

Attaching, Auto-Attaching, and Detaching Virtual Media using the Web browser

You can set the status of a virtual media to Attach, Auto-Attach, or Detach. Based on this status, the devices in the remote system are displayed in the DRAC 5 GUI.

- **Attach**—If the status is Attach, DRAC 5 automatically attaches all devices of the remote system to the server. When you connect to the server, the devices available in the remote system are displayed in the DRAC 5 GUI.
- **Auto Attach**—If the status is Auto Attach, DRAC 5 attaches a device to the server only if the device is virtualized. For example, when you connect to the server from a remote machine that has a CD drive, the CD drive is displayed only if it is virtualized using a CD. Otherwise, the CD drive is not displayed in the DRAC 5 GUI.
- **Detach**—If the status is Detach, virtual device is not displayed in the server.

To Attach the virtual media feature, do the following:

- 1 Click **System**→**Media**→**Configuration**.
- 2 Change the value for **Attach Virtual Media** to **Attach**.
- 3 Click **Apply Changes**.

To Detach the virtual media feature, do the following:

- 1 Click **System**→**Media**→**Configuration**.
- 2 Change the value for **Attach Virtual Media** to **Detach**.
- 3 Click **Apply Changes**.

Attaching, Auto-Attaching, and Detaching Virtual Media using RACADM

To Attach the virtual media feature, open a command prompt, type the following command, and press <Enter>:

```
racadm config -g cfgRacVirtual -o cfgVirMediaAttached 1
```

To Detach the virtual media, open a command prompt, type the following command, and press <Enter>:

```
racadm config -g cfgRacVirtual -o cfgVirMediaAttached 0
```

To Auto-Attach the virtual media, open a command prompt, type the following command, and press <Enter>:

```
racadm config -g cfgRacVirtual -o cfgVirMediaAttached 2
```

Booting From Virtual Media

On supported systems, the system BIOS enables you to boot from virtual optical drives or virtual floppy drives. During POST, enter the BIOS setup window and verify that the virtual drives are enabled and listed in the correct order.

To change the BIOS setting:

- 1 Boot the managed system.
- 2 Press <F2> to enter the BIOS setup window.
- 3 Scroll to the boot sequence and press <Enter>.

In the pop-up window, the virtual optical drives and virtual floppy drives are listed with the standard boot devices.

- 4 Ensure that the virtual drive is enabled and listed as the first device with bootable media. If required, follow the on-screen instructions to modify the boot order.
- 5 Save the changes and exit.

The managed system reboots.

The managed system attempts to boot from a bootable device based on the boot order. If a virtual device is connected and a bootable media is present, the system boots to the virtual device. Otherwise, the system overlooks the device—similar to a physical device—without bootable media.

Installing Operating Systems Using Virtual Media

This section describes a manual, interactive method to install the operating system on your management station that may take several hours to complete. A scripted operating system installation procedure using Virtual Media may take less than 15 minutes to complete. See "Deploying Your Operating System Using VM-CLI" on page 202 for more information.

- 1 Verify the following:
 - The operating system installation CD is inserted in the management station's CD drive.
 - The local CD drive is selected.
 - You are connected to the virtual drives.
- 2 Follow the steps for booting from the virtual media in the "Bootting From Virtual Media" on page 192 section to ensure that the BIOS is set to boot from the CD drive that you are installing from.
- 3 Follow the on-screen instructions to complete the installation.

Using Virtual Media When the Server's Operating System Is Running

Windows-Based Systems

On Windows systems, the virtual media drives are automounted and configured with a drive letter.

Using the virtual drives from within Windows is similar to using your physical drives. When you connect to the media at a management station, the media is available at the system by clicking the drive and browsing its content.

Linux-Based Systems

On Linux systems, the virtual media drives are not configured with a drive letter. Depending on the software installed on your system, the virtual media drives may not be automounted. If your drives are not automounted, manually mount the drives.

Using Virtual Flash

The DRAC 5 provides persistent Virtual Flash—16 MB of flash memory that resides in the DRAC 5 file system that can be used for persistent storage and accessed by the system. When enabled, Virtual Flash is configured as a third virtual drive and appears in the BIOS boot order, allowing a user to boot from the Virtual Flash.



NOTE: To boot from the Virtual Flash, the Virtual Flash image must be a bootable image.

Unlike a CD or floppy drive that requires an external client connection or functional device in the host system, implementing Virtual Flash only requires the DRAC 5 persistent Virtual Flash feature. The 16 MB of flash memory appears as an unformatted, removable USB drive in the host environment.

Use the following guidelines when implementing Virtual Flash:

- Attaching or detaching the Virtual Flash performs a USB reenumeration, which attaches and detaches all Virtual Media devices, respectively (for example, CD drive and floppy drive).
- When you enable or disable Virtual Flash, the Virtual Media CD/floppy drive connection status does not change.



CAUTION: The **Detach** and **Attach** procedures disrupt active Virtual Media read and write operations.

Enabling Virtual Flash

To enable Virtual Flash, open a command prompt, type the following command, and press <Enter>:

```
racadm config -g cfgRacVirtual -o  
cfgVirMediaKeyEnable 1
```

Disabling Virtual Flash

To disable Virtual Flash, open a command prompt, type the following command, and press <Enter>:

```
racadm config -gcfgRacVirtual -o cfgVirMediaKeyEnable 0
```

Storing Images in a Virtual Flash

The Virtual Flash can be formatted from the managed host. If you are running the Windows operating system, right-click the drive icon and select **Format**. If you are running Linux, system tools such as **format** and **fdisk** allow you to partition and format the USB.

Before you upload an image from the RAC Web browser to the Virtual Flash, ensure that the image file is between 1.44 MB and 16 MB in size (inclusive) and Virtual Flash is disabled. After you download the image and re-enable the Virtual Flash drive, the system and BIOS recognize the Virtual Flash.

Configuring a Bootable Virtual Flash

- 1 Insert a bootable diskette into the diskette drive or insert a bootable CD into the optical drive.
- 2 Restart your system and boot to the selected media drive.
- 3 Add a partition to Virtual Flash and enable the partition.

Use **fdisk** if Virtual Flash is emulating the hard drive. If Virtual Flash is configured as Drive B:, the Virtual Flash is floppy emulated and does not require a partition to configure Virtual Flash as a bootable drive.

- 4 Using the **format** command, format the drive with the /s switch to transfer the system files to the Virtual Flash.

For example:

```
format /s x
```

where *x* is the drive letter assigned to Virtual Flash.

- 5 Shut down the system and remove the bootable floppy or CD from the appropriate drive.
- 6 Turn on the system and verify that the system boots from Virtual Flash to the C:\ or A:\ prompt.

Using the Virtual Media Command Line Interface Utility

The Virtual Media Command Line Interface (VM-CLI) utility is a scriptable command-line interface that provides virtual media features from the management station to the DRAC 5 in the remote system.

The VM-CLI utility provides the following features:

- Supports multiple, simultaneously-active sessions.
 -  **NOTE:** When virtualizing read-only image files, multiple sessions may share the same image media. When virtualizing physical drives, only one session can access a given physical drive at a time.
- Removable media devices or image files that are consistent with the Virtual Media plug-ins
- Automatic termination when the DRAC firmware boot once option is enabled.
- Secure communications to the DRAC 5 using Secure Sockets Layer (SSL)

Before you run the utility, ensure that you have Virtual Media user privilege to the DRAC 5 in the remote system.

If your operating system supports administrator privileges or an operating system-specific privilege or group membership, administrator privileges are also required to run the VM-CLI command.

The client system's administrator controls user groups and privileges, thereby controlling the users who can run the utility.

For Windows systems, you must have Power User privileges to run the VM-CLI utility.

For Linux systems, you can access the VM-CLI utility without administrator privileges by using the **sudo** command. This command provides a centralized means of providing non-administrator access and logs all user commands. To add or edit users in the VM-CLI group, the administrator uses the **visudo** command. Users without administrator privileges can add the **sudo** command as a prefix to the VM-CLI command line (or to the VM-CLI script) to obtain access to the DRAC 5 in the remote system and run the utility.

Utility Installation

The VM-CLI utility is located on the *Dell Systems Management Tools and Documentation* DVD, which is included with your Dell OpenManage System Management Software Kit. To install the utility, insert the *Dell Systems Management Tools and Documentation* DVD into your system's DVD drive and follow the on-screen instructions.

The *Dell Systems Management Tools and Documentation* DVD contains the latest systems management software products, including diagnostics, storage management, remote access service, and the RACADM utility. This DVD also contains readme files, which provide the latest systems management software product information.

Additionally, the *Dell Systems Management Tools and Documentation* DVD includes **vmdeploy**—a sample script that illustrates how to use the VM-CLI and RACADM utilities to deploy software to multiple remote systems. For more information, see "Deploying Your Operating System Using VM-CLI" on page 202.

Command Line Options

The VM-CLI interface is identical on both Windows and Linux systems. The utility uses options that are consistent with the RACADM utility options. For example, an option to specify the DRAC 5 IP address requires the same syntax for both RACADM and VM-CLI utilities.

The VM-CLI command format is as follows:

```
racvmcli [parameter] [operating_system_shell_options]
```



NOTE: You need **Administrator** privileges to run the `racvmcli` command.

All command-line syntax are case sensitive. See "VM-CLI Parameters" on page 198 for more information.

If the remote system accepts the commands and the DRAC 5 authorizes the connection, the command continues to run until either of the following occurs:

- The VM-CLI connection terminates for any reason.
- The process is manually terminated using an operating system control. For example, in Windows, you can use the Task Manager to terminate the process.

VM-CLI Parameters

DRAC 5 IP Address

`-r <RAC-IP-address>[:<RAC-SSL-port>]`

where `<RAC-IP-address>` is a valid, unique IP address or the DRAC 5 Dynamic Domain Naming System (DDNS) name (if supported).

This parameter provides the DRAC 5 IP address and SSL port. The VM-CLI utility needs this information to establish a Virtual Media connection with the target DRAC 5. If you enter an invalid IP address or DDNS name, an error message appears and the command is terminated.

If `<RAC-SSL-port>` is omitted, port 443 (the default port) is used. The optional SSL port is not required unless you change the DRAC 5 default SSL port.

DRAC 5 User Name

`-u <DRAC-user-name>`

This parameter provides the DRAC 5 user name that will run Virtual Media. The `<DRAC-user-name>` must have the following attributes:

- Valid user name
- DRAC Virtual Media User permission

If DRAC 5 authentication fails, an error message appears and the command is terminated.

DRAC User Password

`-p <DRAC-user-password>`

This parameter provides the password for the specified DRAC 5 user.

If DRAC 5 authentication fails, an error message displays and the command terminates.

Floppy/Disk Device or Image File

`-f {<device-name> | <image-file>}`

where *<device-name>* is a valid drive letter (for Windows systems) or a valid device file name, including the mountable file system partition number, if applicable (for Linux systems); and *<image-file>* is the filename and path of a valid image file.

This parameter specifies the device or file to supply the virtual floppy/disk media.

For example, an image file is specified as:

`-f c:\temp\myfloppy.img` (Windows system)

`-f /tmp/myfloppy.img` (Linux system)

If the file is not write-protected, Virtual Media may write to the image file. Configure the operating system to write-protect a floppy image file that should not be overwritten.

For example, a device is specified as:

`-f a:\` (Windows system)

`-f /dev/sdb4 # 4th partition on device /dev/sdb`
(Linux system)

If the device provides a write-protection capability, use this capability to ensure that Virtual Media will not write to the media.

Additionally, omit this parameter from the command line if you are not virtualizing floppy media. If an invalid value is detected, an error message displays and the command terminates.

CD/DVD Device or Image File

`-c {<device-name> | <image-file>}`

where *<device-name>* is a valid CD/DVD drive letter (Windows systems) or a valid CD/DVD device file name (Linux systems) and *<image-file>* is the file name and path of a valid ISO-9660 image file.

This parameter specifies the device or file that will supply the virtual CD/DVD-ROM media:

For example, an image file is specified as:

`-c c:\temp\mydvd.img` (Windows systems)

`-c /tmp/mydvd.img` (Linux systems)

For example, a device is specified as:

`-c d:\` (Windows systems)

`-c /dev/cdrom` (Linux systems)

Additionally, omit this parameter from the command line if you are not virtualizing CD/DVD media. If an invalid value is detected, an error message is listed and the command terminates.

Specify at least one media type (floppy or CD/DVD drive) with the command, unless only switch options are provided. Otherwise, an error message displays and the command terminates and generates an error.

Version Display

`-v`

This parameter is used to display the VM-CLI utility version. If no other non-switch options are provided, the command terminates without an error message.

Help Display

`-h`

This parameter displays a summary of the VM-CLI utility parameters. If no other non-switch options are provided, the command terminates without error.

Encrypted Data

`-e`

When this parameter is included in the command line, the VM-CLI utility will use an SSL-encrypted channel to transfer data between the management station and the DRAC 5 in the remote system. If this parameter is not included in the command line, the data transfer is not encrypted.

VM-CLI Operating System Shell Options

The following operating system features can be used in the VM-CLI command line:

- `stderr/stdout` redirection — Redirects any printed utility output to a file. For example, using the greater-than character (`>`) followed by a filename overwrites the specified file with the printed output of the VM-CLI utility.
 **NOTE:** The VM-CLI utility does not read from standard input (**stdin**). As a result, **stdin** redirection is not required.
- Background execution — By default, the VM-CLI utility runs in the foreground. Use the operating system's command shell features to cause the utility to run in the background. For example, under a Linux operating system, the ampersand character (`&`) following the command causes the program to be spawned as a new background process.

The latter technique is useful in script programs, as it allows the script to proceed after a new process is started for the VM-CLI command (otherwise, the script would block until the VM-CLI program is terminated). When multiple VM-CLI instances are started in this way, and one or more of the command instances must be manually terminated, use the operating system-specific facilities for listing and terminating processes.

VM-CLI Return Codes

0 = No error

1 = Unable to connect

2 = VM-CLI command line error

3 = RAC firmware connection dropped

English-only text messages are also issued to standard error output whenever errors are encountered.

Deploying Your Operating System Using VM-CLI

The Virtual Media Command Line Interface (VM-CLI) utility is a command-line interface that provides Virtual Media features from the management station to the DRAC 5 in the remote system. Using VM-CLI and scripted methods, you can deploy your operating system on multiple remote systems in your network.

This section provides information on integrating the VM-CLI utility into your corporate network.

Before You Begin

Before using the VM-CLI utility, ensure that your targeted remote systems and corporate network meet the requirements listed in the following sections.

Remote System Requirements

- DRAC 5 card is installed in each remote system
- The virtual device in each remote system is the first device in the BIOS boot order.

Dell Custom Factory Integration

When you order your Dell system using the Dell Custom Factory Integration (CFI) options, Dell can preconfigure your system with a DRAC 5 card that includes a DDNS name and a preconfigured system BIOS that is enabled for Virtual Media. Using this configuration, your system is ready to boot from its Virtual Media devices when installed into your corporate network.

For more information, see the Dell website at www.dell.com.

Network Requirements

You must have a network share containing:

- Operating system files
- Required drivers
- Operating system boot image file(s)

The image file must be a floppy image or CD/DVD ISO image with an industry-standard, bootable format.

Creating a Bootable Image File

Before you deploy your image file to the remote systems, ensure that a supported system can boot from the file. To test the image file, transfer the image file to a test system using the DRAC 5 Web user interface and then reboot the system.

The following sections provide specific information for creating image files for Linux and Windows systems.

Creating an Image File for Linux Systems

Use the Data Duplicator utility to create a bootable image file for your Linux system.

To run the utility, open a command prompt and type the following:

```
dd if=<input-device> of=<output-file>
```

For example:

```
dd if=/dev/fd0 of=myfloppy.img
```

Creating an Image File for Windows Systems

When choosing a data replicator utility for Windows image files, select a utility that copies the image file and the CD/DVD boot sectors.

Preparing for Deployment

Configuring the Remote Systems

- 1 Create a network share that can be accessed by the management station.
- 2 Copy the operating system files to the network share.
- 3 If you have a bootable, preconfigured deployment image file to deploy the operating system to the remote systems, skip this step.

If you do not have a bootable, preconfigured deployment image file, create the file. Include any programs and/or scripts used for the operating system deployment procedures

For example, to deploy Microsoft Windows operating system, the image file may include programs that are similar to deployment methods used by Microsoft Systems Management Server (SMS).

When you create the image file, ensure that you:

- Follow standard network-based installation procedures
 - Mark the deployment image as "read only" to ensure that each target system boots and executes the same deployment procedure
- 4** Perform one of the following procedures:
- Integrate RACADM and the Virtual Media command line interface (VM-CLI) into your existing operating system deployment application. Use the sample deployment script as a guide when integrating the DRAC 5 utilities into your existing operating system deployment application.
 - Use the existing `vmdeploy` script to deploy your operating system.

Deploying the Operating System

Use the VM-CLI utility and the `vmdeploy` script included with the utility to deploy the operating system to your remote systems.

Before you begin, review the sample `vmdeploy` script included with the VM-CLI utility. The script offers detailed requirements to deploy the operating system to remote systems in your network.

The following procedure is a high-level overview for deploying the operating system on targeted remote systems.

- 1** Identify the remote systems that will be deployed.
- 2** Record the DRAC 5 names and IP addresses of the targeted remote systems.
- 3** Perform the following procedure for each targeted remote system:
 - a** Configure a VM-CLI process that includes the following parameters for the targeted system:
 - DRAC 5 IP address or DDNS name
 - Bootable deployment image file name
 - DRAC 5 user name
 - DRAC 5 user password
 - b** Using RACADM, set the target DRAC 5 **boot once** option.
 - c** Using RACADM, reboot the DRAC 5 system.

Frequently Asked Questions

Sometimes, I notice my Virtual Media client connection drops. Why?

When a network time-out occurs, the DRAC 5 firmware drops the connection, disconnecting the link between the server and the Virtual Drive. To reconnect to the Virtual Drive, use the Virtual Media feature.

Which operating systems support the DRAC 5?

See the *Dell Systems Software Support Matrix* on the Dell Support website at support.dell.com/manuals for a list of supported operating systems.

Which Web browsers support the DRAC 5?

See the *Dell Systems Software Support Matrix* on the Dell Support website at support.dell.com/manuals for a list of supported Web browsers.

Why do I sometimes lose my client connection?

- You can sometimes lose your client connection if the network is slow or if you change the CD in the client system CD drive. For example, if you change the CD in the client system's CD drive, the new CD might have an autostart feature. If this is the case, the firmware can time out and the connection can be lost if the client system takes too long before it is ready to read the CD. If a connection is lost, reconnect from the GUI and continue the previous operation.
- When a network time-out occurs, the DRAC 5 firmware drops the connection, disconnecting the link between the server and the Virtual Drive. To reconnect to the Virtual Drive, use the Virtual Media feature.

What should I do if Windows 2000 with Service Pack 4 fails to install properly?

If you use Virtual Media and the Windows 2000 operating system CD to install Windows 2000 with Service Pack 4, your system may momentarily lose its connection to the CD drive during the installation procedure, and the operating system may fail to install properly. To fix this issue, download the file `usbstor.sys` from the Microsoft Support website at support.microsoft.com and run the program only on systems that experience this issue. For more information, see Microsoft Knowledge Base article 823086.

Why can't I install Windows 2000 locally or remotely?

This issue usually happens if Virtual Flash is enabled and does not contain a valid image, for example, the virtual flash contains a corrupted or random image, you may not be able to install Windows 2000 locally or remotely. To fix this issue, install a valid image on Virtual Flash or disable Virtual Flash if it will not be used during the installation procedure.

Why does the Virtual Media connection drop when configured in the Shared-NIC mode?

Installing network and chipset drivers on the server causes the Virtual Media connection to drop when configured in the Shared-NIC mode. Installing the network or chipset drivers causes the LOM to reset, which in turn causes network packets to timeout and the Virtual Media connection to timeout and drop. To work around this issue, copy the drivers from your virtual drive to the server's local hard drive. To prevent a dropped Virtual Media connection from interfering with your driver installation procedure, start the driver installation directly from the server.

An installation of the Windows operating system seems to take too long. Why?

If you are installing the Windows operating system using the *Dell Systems Management Tools and Documentation* DVD and experience a slow network connection, the installation procedure may require an extended amount of time to access the DRAC 5 Web-based interface due to network latency. While the installation window does not indicate the installation progress, the installation procedure is in progress.

I am viewing the contents of a floppy drive or USB memory key. If I try to establish a Virtual Media connection using the same drive, I receive a connection failure message and am asked to retry. Why?

Simultaneous access to Virtual Floppy drives is not allowed. Close the application used to view the drive contents before you attempt to virtualize the drive.

How do I configure my virtual device as a bootable device?

On the managed system, access the BIOS Setup and navigate to the boot menu. Locate the virtual CD, Virtual Floppy, or Virtual Flash and change the device boot order as needed. For example, to boot from a CD drive, configure the CD drive as the first drive in the boot order.

What types of media can I boot from?

The DRAC 5 allows you to boot from the following bootable media:

- CDROM/DVD Data media
- ISO 9660 image
- 1.44 Floppy disk or floppy image
- DRAC 5 embedded virtual flash
- A USB key that is recognized by the operating system as a removable disk
- A USB key image

How can I make my USB key bootable?

Only USB keys with Windows 98 DOS can boot from the Virtual Floppy. To configure your own bootable USB key, boot to a Windows 98 startup disk and copy system files from the startup disk to your USB key. For example, from the DOS prompt, type the following command:

```
sys a: x: /s
```

where "x:" is the USB key you want to make bootable.

You can also use the Dell boot utility to create a bootable USB key. This utility is only compatible with Dell-branded USB keys. To download the utility, open a supported Web browser, navigate to the Dell Support website located at support.dell.com, and search for "R122672.exe."

Do I need Administrator privileges to install the ActiveX plug-in?

You must have Administrator or Power User privileges on Windows systems to install the Virtual Media plug-in.

What privileges do I need to install and use the Virtual Media plug-in on a Red Hat Linux Management station?

You must have `write` privileges on the browser's directory tree to successfully install the Virtual Media plug-in.

I cannot locate my Virtual Floppy device on a system running Red Hat Enterprise Linux or the SUSE Linux operating System. My Virtual Media is attached and I am connected to my remote floppy. What should I do?

Some Linux versions do not automount the Virtual Floppy Drive and the Virtual CD drive in a similar manner. In order to mount the Virtual Floppy Drive, locate the device node that Linux assigns to the Virtual Floppy Drive. Perform the following steps to correctly find and mount the Virtual Floppy Drive:

- 1** Open a Linux command prompt and run the following command:

```
grep "Virtual Floppy" /var/log/messages
```

- 2** Locate the last entry to that message and note the time.

- 3** At the Linux prompt, run the following command:

```
grep "hh:mm:ss" /var/log/messages  
where:
```

hh:mm:ss is the time stamp of the message returned by grep in step 1.

- 4** In step 3, read the result of the grep command and locate the device name that is given to the "Dell Virtual Floppy"

- 5** Ensure that you are attached and connected to the Virtual Floppy Drive.

- 6** At the Linux prompt, run the following command:

```
mount /dev/sdx /mnt/floppy
```

where:

/dev/sdx is the device name found in step 4

/mnt/floppy is the mount point.

What file system types are supported on my Virtual Floppy Drive or Virtual Flash?

Your Virtual Floppy Drive or Virtual Flash supports FAT16 or FAT32 file systems.

When I performed a firmware update remotely using the DRAC 5 Web-based interface, my virtual drives at the server were removed. Why?

Firmware updates cause the DRAC 5 to reset, drop the remote connection, and unmount the virtual drives. The drives will reappear when the DRAC reset is complete.

When enabling or disabling the Virtual Flash, I noticed that all my virtual drives disappeared and then reappeared. Why?

Disabling or enabling the Virtual Flash causes a USB reset and causes all virtual drives to detach from and then reattach to the USB bus.

How can I install a Web browser on my management station that has a read-only file system?

If you are running Linux and your management station has a read-only file system, a browser can be installed on a client system without requiring a connection to a DRAC 5. By using the native plug-in installation package, the browser can be manually installed during the client setup phase.

⚠ CAUTION: In a read-only client environment, if the DRAC 5 firmware is updated to a newer version of the plug-in, the installed virtual media plug-in becomes inoperative. This is because earlier plug-in features are not allowed to function when the firmware contains a newer plug-in version. In this case, you are prompted for plug-in installation. Since the file system is read-only, the installation fails and the plug-in features are not available.

To obtain the plug-in installation package:

- 1 Login to an existing DRAC 5.
- 2 Change the URL in the browser's address bar, from:
`https://<RAC_IP>/cgi-bin/webcgi/main`
to:
`https://<RAC_IP>/plugins/` # Be sure to include the trailing slash.
- 3 Locate the two subdirectories `vm` and `vkvm`. Navigate to the appropriate subdirectory, right click the `rac5XXX.xpi` file, and select **Save Link Target As...**
- 4 Choose a location to save the plug-in installation package file.

To install the plug-in installation package:

- 1** Copy the installation package to the client's native file system share that is accessible by the client.
- 2** Open an instance of the browser on the client system.
- 3** Enter the file-path to the plug-in installation package in the browser's address bar. For example:
`file:///tmp/rac5vm.xpi`
- 4** The browser guides the user through plug-in installation.

Once installed, the browser will not prompt for that plug-in installation again, as long as the target DRAC 5 firmware does not contain a newer version of the plug-in.

Configuring Security Features

The DRAC 5 provides the following security features:

- Advanced Security options for the DRAC administrator:
 - The Console Redirection disable option allows the *local* system user to disable console redirection using the DRAC 5 Console Redirection feature.
 - The local configuration disable features allows the *remote* DRAC administrator to selectively disable the ability to configure the DRAC 5 from:
 - BIOS POST option-ROM
 - operating system using the local racadm and Dell OpenManage Server Administrator utilities
- RACADM CLI and Web-based interface operation, which supports 128-bit SSL encryption and 40-bit SSL encryption (for countries where 128-bit is not acceptable)
 - ✍ **NOTE:** Telnet does not support SSL encryption.
- Session time-out configuration (in seconds) through the Web-based interface or RACADM CLI
- Configurable IP ports (where applicable)
- Secure Shell (SSH), which uses an encrypted transport layer for higher security.
- Login failure limits per IP address, with login blocking from the IP address when the limit is exceeded.
- Limited IP address range for clients connecting to the DRAC 5

Security Options for the DRAC Administrator

Disabling the DRAC 5 Local Configuration

Administrators can disable local configuration through the DRAC 5 graphical user interface (GUI) by selecting **Remote Access**→**Configuration**→**Services**. When the **Disable the DRAC local Configuration using option ROM** check box is selected, the Remote Access Configuration Utility—accessed by pressing Ctrl+E during system boot—operates in read-only mode, preventing local users from configuring the device. When the administrator selects the **Disable the DRAC local Configuration using RACADM** check box, local users cannot configure the DRAC 5 through the racadm utility, or the Dell OpenManage Server Administrator, although they can still read the configuration settings.

Administrators can enable one or both of these options at the same time. In addition to enabling them through the GUI, administrators can do so using local racadm commands.

Disabling Local Configuration During System Reboot

This feature disables the ability of the managed system's user to configure the DRAC 5 during system reboot.

```
racadm config -g cfgRacTune -o  
cfgRacTuneCtrlEConfigDisable 1
```



NOTE: This option is supported only on the Remote Access Configuration Utility version 1.13 and later. To upgrade to this version, upgrade your BIOS using the BIOS update package from the *Dell Server Updates DVD* or the Dell Support website at support.dell.com.

Disabling Local Configuration From Local racadm

This feature disables the ability of the managed system's user to configure the DRAC 5 using the local racadm or the Dell OpenManage Server Administrator utilities.

```
racadm config -g cfgRacTune -o  
cfgRacTuneLocalConfigDisable 1
```

 **CAUTION:** These features severely limit the ability of the local user to configure the DRAC 5 from the local system, including performing a reset to default of the configuration. Dell recommends that you use these features with discretion and should disable only one interface at a time to help avoid losing login privileges altogether.



NOTE: See the white paper on *Disabling Local Configuration and Remote Virtual KVM in the DRAC* on the Dell Support site at support.dell.com/manuals for more information.

Although administrators can set the local configuration options using local racadm commands, for security reasons they can reset them only from an out-of-band DRAC 5 GUI or command-line interface. The `cfgRacTuneLocalConfigDisable` option applies once the system power-on self-test is complete and the system has booted into an operating system environment. The operating system could be one such as Microsoft Windows Server or Enterprise Linux operating systems that can run local racadm commands, or a limited-use operating system such as Microsoft Windows Preinstallation Environment or vmlinux used to run Dell OpenManage Deployment Toolkit local racadm commands.

Several situations might call for administrators to disable local configuration. For example, in a data center with multiple administrators for servers and remote access devices, those responsible for maintaining server software stacks may not require administrative access to remote access devices. Similarly, technicians may have physical access to servers during routine systems maintenance—during which they can reboot the systems and access password-protected BIOS—but should not be able to configure remote access devices. In such situations, remote access device administrators may want to disable local configuration.

Administrators should keep in mind that because disabling local configuration severely limits local configuration privileges—including the ability to reset the DRAC 5 to its default configuration—they should only use these options when necessary, and typically should disable only one interface

at a time to help avoid losing login privileges altogether. For example, if administrators have disabled all local DRAC 5 users and allow only Microsoft Active Directory directory service users to log in to the DRAC 5, and the Active Directory authentication infrastructure subsequently fails, the administrators may be unable to log in. Similarly, if administrators have disabled all local configuration and place a DRAC 5 with a static IP address on a network that already includes a Dynamic Host Configuration Protocol (DHCP) server, and the DHCP server subsequently assigns the DRAC 5 IP address to another device on the network, the resulting conflict may disable the out-of-band connectivity of the DRAC, requiring administrators to reset the firmware to its default settings through a serial connection.

Disabling DRAC 5 Remote Virtual KVM

Administrators can selectively disable the DRAC 5 remote KVM, providing a flexible, secure mechanism for a local user to work on the system without someone else viewing the user's actions through console redirection. Using this feature requires installing the DRAC managed node software on the server. Administrators can disable remote vKVM using the following command:

```
racadm LocalConRedirDisable 1
```

The command `LocalConRedirDisable` disables existing remote vKVM session windows when executed with the argument `1`

To help prevent a remote user from overriding the local user's settings, this command is available only to local `racadm`. Administrators can use this command in operating systems that support local `racadm`, including Microsoft Windows Server 2003 and SUSE Linux Enterprise Server 10. Because this command persists across system reboots, administrators must specifically reverse it to re-enable remote vKVM. They can do so by using the argument `0`:

```
racadm LocalConRedirDisable 0
```

Several situations might call for disabling DRAC 5 remote vKVM. For example, administrators may not want a remote DRAC 5 user to view the BIOS settings that they configure on a system, in which case they can disable remote vKVM during the system POST by using the `LocalConRedirDisable` command. They may also want to increase security by automatically disabling remote vKVM every time an administrator logs in to the system, which they can do by executing the `LocalConRedirDisable` command from the user logon scripts.



NOTE: See the white paper on *Disabling Local Configuration and Remote Virtual KVM in the DRAC* on the Dell Support site at support.dell.com/manuals for more information.

For more information on logon scripts, see technet2.microsoft.com/windowsserver/en/library/31340f46-b3e5-4371-bbb9-6a73e4c63b621033.mspx.

Securing DRAC 5 Communications Using SSL and Digital Certificates

This subsection provides information about the following data security features that are incorporated in your DRAC 5:

- "Secure Sockets Layer (SSL)" on page 215
- "Certificate Signing Request (CSR)" on page 216
- "Accessing the SSL Main Menu" on page 216
- "Generating a New Certificate Signing Request" on page 218
- "Uploading a Server Certificate" on page 219
- "Uploading a Server Certificate" on page 219

Secure Sockets Layer (SSL)

The DRAC includes a Web server that is configured to use the industry-standard SSL security protocol to transfer encrypted data over the Internet. Built upon public-key and private-key encryption technology, SSL is a widely accepted technique for providing authenticated and encrypted communication between clients and servers to prevent eavesdropping across a network.

An SSL-enabled system:

- Authenticates itself to an SSL-enabled client
- Allows the client to authenticate itself to the server
- Allows both systems to establish an encrypted connection

This encryption process provides a high level of data protection. The DRAC employs the 128-bit SSL encryption standard, the most secure form of encryption generally available for Internet browsers in North America.

The DRAC Web server includes a Dell self-signed SSL digital certificate (Server ID). To ensure high security over the Internet, replace the Web server SSL certificate by submitting a request to the DRAC to generate a new Certificate Signing Request (CSR).

Certificate Signing Request (CSR)

A CSR is a digital request to a Certificate Authority (CA) for a secure server certificate. Secure server certificates protect the identity of a remote system and ensure that information exchanged with the remote system cannot be viewed or changed by others. To ensure security for your DRAC, it is strongly recommended that you generate a CSR, submit the CSR to a CA, and upload the certificate returned from the CA.

A CA is a business entity that is recognized in the IT industry for meeting high standards of reliable screening, identification, and other important security criteria. Examples of CAs include Thawte and VeriSign. After the CA receives your CSR, they review and verify the information the CSR contains. If the applicant meets the CA's security standards, the CA issues a certificate to the applicant that uniquely identifies that applicant for transactions over networks and on the Internet.

After the CA approves the CSR and sends you a certificate, you must upload the certificate to the DRAC firmware. The CSR information stored on the DRAC firmware must match the information contained in the certificate.

Accessing the SSL Main Menu

- 1 Expand the **System** tree and click **Remote Access**.
- 2 Click the **Configuration** tab and then click **SSL**.

Use the **SSL Main Menu** page options (see Table 12-1) to generate a CSR to send to a CA. The CSR information is stored on the DRAC 5 firmware. Table 12-2 describes the buttons available on the **SSL Main Menu** page.

Table 12-1. SSL Main Menu Options



Field	Description
Generate a New Certificate Signing Request (CSR)	<p>Click Next to open the Certificate Signing Request Generation page that enables you to generate a CSR to send to a CA to request a secure Web certificate.</p> <p> CAUTION: Each new CSR overwrites any pervious CSR on the firmware. For a CA to accept your CSR, the CSR in the firmware must match the certificate returned from the CA.</p>
Upload Server Certificate	<p>Click Next to upload an existing certificate that your company has title to, and uses to control access to the DRAC 5.</p> <p> CAUTION: Only X509, Base 64 encoded certificates are accepted by the DRAC 5. DER encoded certificates are not accepted. Upload a new certificate to replace the default certificate you received with your DRAC 5.</p>
View Server Certificate	Click Next to view an existing server certificate.

Table 12-2. SSL Main Menu Buttons

Button	Description
Print	Prints the SSL Main Menu page.
Next	Navigates to the next page.

Generating a New Certificate Signing Request



NOTE: Each new CSR overwrites any previous CSR on the firmware. Before a certificate authority (CA) can accept your CSR, the CSR in the firmware must match the certificate returned from the CA. Otherwise, the DRAC 5 will not upload the certificate.

- 1 In the **SSL Main Menu** page, select **Generate a New Certificate Signing Request (CSR)** and click **Next**.
- 2 In the **Generate Certificate Signing Request (CSR)** page, type a value for each CSR attribute value.
Table 12-3 describes the **Generate Certificate Signing Request (CSR)** page options.
- 3 Click **Generate** to save or view the CSR.
- 4 Click the appropriate **Generate Certificate Signing Request (CSR)** page button to continue. Table 12-4 describes the buttons available on the **Generate Certificate Signing Request (CSR)**.

Table 12-3. Generate Certificate Signing Request (CSR) Page Options

Field	Description
Common Name	The exact name being certified (usually the Web server's domain name, for example, <code>www.xyzcompany.com</code>). Only alphanumeric characters, hyphens, underscores, and periods are valid. Spaces are not valid.
Organization Name	The name associated with this organization (for example, XYZ Corporation). Only alphanumeric characters, hyphens, underscores, periods and spaces are valid.
Organization Unit	The name associated with an organizational unit, such as a department (for example, Enterprise Group). Only alphanumeric characters, hyphens, underscores, periods, and spaces are valid.
Locality	The city or other location of the entity being certified (for example, Round Rock). Only alphanumeric characters and spaces are valid. Do not separate words using an underscore or some other character.

Table 12-3. Generate Certificate Signing Request (CSR) Page Options (continued)

Field	Description
State Name	The state or province where the entity who is applying for a certification is located (for example, Texas). Only alphanumeric characters and spaces are valid. Do not use abbreviations.
Country Code	The name of the country where the entity applying for certification is located. Use the drop-down menu to select the country.
Email	The e-mail address associated with the CSR. You can type your company's e-mail address, or any e-mail address you desire to have associated with the CSR. This field is optional.

Table 12-4. Generate Certificate Signing Request (CSR) Page Buttons

Button	Description
Print	Print the Generate Certificate Signing Request (CSR) page.
Go Back to Security Main Menu	Return to the SSL Main Menu page.
Generate	Generate a CSR.

Uploading a Server Certificate

- 1 In the SSL Main Menu page, select **Upload Server Certificate** and click **Next**. The **Certificate Upload** page appears.

- 2 In the **File Path** field, type the path of the certificate in the **Value** field or click **Browse** to navigate to the certificate file.



NOTE: The **File Path** value displays the relative file path of the certificate you are uploading. You must type the absolute file path, which includes the full path and the complete file name and file extension.



NOTE: A Server Certificate can be uploaded only once. If you try to upload a Server Certificate that is already uploaded once, DRAC displays the error message, "Unable to find a valid certificate."

- 3 Click **Apply**.

- 4 Click the appropriate page button to continue.

Viewing a Server Certificate

- 1 In the SSL Main Menu page, select **View Server Certificate** and click **Next**.
Table 12-5 describes the fields and associated descriptions listed in the **Certificate** window.
- 2 Click the appropriate **View Server Certificate** page button to continue.

Table 12-5. Certificate Information

Field	Description
Serial Number	Certificate serial number
Subject Information	Certificate attributes entered by the subject
Issuer Information	Certificate attributes returned by the issuer
Valid From	Issue date of the certificate
Valid To	Expiration date of the certificate

Using the Secure Shell (SSH)

Only four SSH sessions are supported at any given time. The session time-out is controlled by the `cfgSsnMgtSshIdleTimeout` property as described in the "DRAC 5 Property Database Group and Object Definitions" on page 345. You can enable the SSH on the DRAC 5 with the command:

```
racadm config -g cfgSerial -o cfgSerialSshEnable 1
```

You can change the SSH port with the command:

```
racadm config -g cfgRacTuning -o cfgRacTuneSshPort  
<port number>
```

For more information on `cfgSerialSshEnable` and `cfgRacTuneSshPort` properties, see "DRAC 5 Property Database Group and Object Definitions" on page 345.

The DRAC 5 SSH implementation supports multiple cryptography schemes, as shown in Table 12-6.

Table 12-6. Cryptography Schemes

Scheme Type	Scheme
Asymmetric Cryptography	Diffie-Hellman DSA/DSS 512-1024 (random) bits per NIST specification
Symmetric Cryptography	<ul style="list-style-type: none">• AES256-CBC• RIJNDAEL256-CBC• AES192-CBC• RIJNDAEL192-CBC• AES128-CBC• RIJNDAEL128-CBC• BLOWFISH-128-CBC• 3DES-192-CBC• ARCFOUR-128
Message Integrity	<ul style="list-style-type: none">• HMAC-SHA1-160• HMAC-SHA1-96• HMAC-MD5-128• HMAC-MD5-96
Authentication	<ul style="list-style-type: none">• Password

 **NOTE:** SSHv1 is not supported.

Configuring Services

 **NOTE:** To modify these settings, you must have **Configure DRAC 5** permission. Additionally, the remote RACADM command-line utility can only be enabled if the user is logged in as **root**.

- 1 Expand the **System** tree and click **Remote Access**.
- 2 Click the **Configuration** tab and then click **Services**.
- 3 Configure the following services as required:
 - Local Configuration (Table 12-7)
 - Web server (Table 12-8)
 - SSH (Table 12-9)

- Telnet (Table 12-10)
- Remote RACADM (Table 12-11)
- SNMP agent (Table 12-12)
- Automated System Recovery Agent (Table 12-13)

Use the **Automated Systems Recovery Agent** to enable the **Last Crash Screen** functionality of the DRAC 5.

 **NOTE: Server Administrator** must be installed with its **Auto Recovery** feature activated by setting the **Action** to either: **Reboot System**, **Power Off System**, or **Power Cycle System**, for the **Last Crash Screen** to function in the DRAC 5.

- 4 Click **Apply Changes**.
- 5 Click the appropriate **Services** page button to continue. See Table 12-14.

Table 12-7. Local Configuration Settings

Setting	Description
Disable the DRAC local configuration using option ROM	Disables local configuration of the DRAC 5 using option ROM. The option ROM prompts you to enter the setup module by pressing <Ctrl+E> during system reboot.
Disable the DRAC local configuration using RACADM	Disables local configuration of the DRAC 5 using local RACADM.

Table 12-8. Web Server Settings

Setting	Description
Enabled	Enables or disables the Web server. Checked=Enabled; Unchecked=Disabled.
Max Sessions	The maximum number of simultaneous sessions allowed for this system.
Active Sessions	The number of current sessions on the system, less than or equal to the Max Sessions .

Table 12-8. Web Server Settings (continued)

Setting	Description
Timeout	The time in seconds that a connection is allowed to remain idle. The session is cancelled when the timeout is reached. Changes to the timeout setting do not affect the current session. When you change the timeout setting, you must log out and log in again to make the new setting effective. Timeout range is 60 to 1920 seconds.
HTTP Port Number	The port used by the DRAC that listens for a server connection. The default setting is 80.
HTTPS Port Number	The port used by the DRAC that listens for a server connection. The default setting is 443.

Table 12-9. SSH Settings

Setting	Description
Enabled	Enables or disables SSH. Checked=Enabled; Unchecked=Disabled.
Max Sessions	The maximum number of simultaneous sessions allowed for this system. Up to four sessions are supported.
Active Sessions	The number of current sessions on the system, less than or equal to the Max Sessions .
Timeout	The Secure Shell idle timeout, in seconds. Range = 60 to 1920 seconds. Enter 0 seconds to disable the Timeout feature. The default setting is 300.
Port Number	The port used by the DRAC that listens for a server connection. The default setting is 22.

Table 12-10. Telnet Settings

Setting	Description
Enabled	Enables or disables Telnet. Checked=Enabled; Unchecked=Disabled.
Max Sessions	The maximum number of simultaneous sessions allowed for this system. Up to four sessions are supported.

Table 12-10. Telnet Settings

Setting	Description
Active Sessions	The number of current sessions on the system, less than or equal to the Max Sessions .
Timeout	The Secure Shell idle timeout, in seconds. Range = 60 to 1920 seconds. Enter 0 seconds to disable the Timeout feature. The default setting is 0.
Port Number	The port used by the DRAC that listens for a server connection. The default setting is 23.

Table 12-11. Remote RACADM Settings

Setting	Description
Enabled	Enables or disables remote RACADM. Checked=Enabled; Unchecked=Disabled.
Max Sessions	The maximum number of simultaneous sessions allowed for this system. Up to four sessions are supported.
Active Sessions	The number of current sessions on the system, less than or equal to the Max Sessions .

Table 12-12. SNMP Agent Settings

Setting	Description
Enabled	Enables or disables the SNMP agent. Checked=Enabled; Unchecked=Disabled.
Community Name	The name of the community that contains the IP address for the SNMP Alert destination. The Community Name can be up to 31 non-blank characters in length. The default setting is public .

Table 12-13. Automated System Recovery Agent Setting

Setting	Description
Enabled	Enables the Automated System Recovery Agent.

Table 12-14. Services Page Buttons

Button	Description
Print	Prints the Services page.
Refresh	Refreshes the Services page.
Apply Changes	Applies the Services page settings.

Enabling Additional DRAC 5 Security Options

To prevent unauthorized access to your remote system, the DRAC 5 provides the following features:

- IP address filtering (IPRange) — Defines a specific range of IP addresses that can access the DRAC 5.
- IP address blocking — Limits the number of failed login attempts from a specific IP address

These features are disabled in the DRAC 5 default configuration. Use the following subcommand or the Web-based interface to enable these features:

```
racadm config -g cfgRacTuning -o <object_name> <value>
```

Additionally, use these features in conjunction with the appropriate session idle time-out values and a defined security plan for your network.

The following subsections provide additional information about these features.

IP Filtering (IpRange)

IP address filtering (or *IP Range Checking*) allows DRAC 5 access only from clients or management workstations whose IP addresses are within a user-specific range. All other logins are denied.

IP filtering compares the IP address of an incoming login to the IP address range that is specified in the following **cfgRacTuning** properties:

- **cfgRacTuneIpRangeAddr**
- **cfgRacTuneIpRangeMask**

The **cfgRacTuneIpRangeMask** property is applied to both the incoming IP address and to the **cfgRacTuneIpRangeAddr** properties. If the results of both properties are identical, the incoming login request is allowed to access the DRAC 5. Logins from IP addresses outside this range receive an error.

The login proceeds if the following expression equals zero:

```
cfgRacTuneIpRangeMask & (<incoming_IP_address> ^  
cfgRacTuneIpRangeAddr)
```

where & is the bitwise AND of the quantities and ^ is the bitwise exclusive-OR.

See "DRAC 5 Property Database Group and Object Definitions" on page 345 for a complete list of **cfgRacTune** properties.

Table 12-15. IP Address Filtering (IpRange) Properties

Property	Description
<code>cfgRacTuneIpRangeEnable</code>	Enables the IP range checking feature.
<code>cfgRacTuneIpRangeAddr</code>	Determines the acceptable IP address bit pattern, depending on the 1's in the subnet mask. This property is bitwise AND'd with <code>cfgRacTuneIpRangeMask</code> to determine the upper portion of the allowed IP address. Any IP address that contains this bit pattern in its upper bits is allowed to establish a DRAC 5 session. Logins from IP addresses that are outside this range will fail. The default values in each property allow an address range from 192.168.1.0 to 192.168.1.255 to establish a DRAC 5 session.
<code>cfgRacTuneIpRangeMask</code>	Defines the significant bit positions in the IP address. The subnet mask should be in the form of a netmask, where the more significant bits are all 1's with a single transition to all zeros in the lower-order bits.

Enabling IP Filtering

Below is an example command for IP filtering setup.

See "Using RACADM Remotely" on page 78 for more information about RACADM and RACADM commands.



NOTE: The following RACADM commands block all IP addresses except 192.168.0.57)

To restrict the login to a single IP address (for example, 192.168.0.57), use the full mask, as shown below.

```
racadm config -g cfgRacTuning -o
cfgRacTuneIpRangeEnable 1
racadm config -g cfgRacTuning -o
cfgRacTuneIpRangeAddr 192.168.0.57
racadm config -g cfgRacTuning -o
cfgRacTuneIpRangeMask 255.255.255.255
```

To restrict logins to a small set of four adjacent IP addresses (for example, 192.168.0.212 through 192.168.0.215), select all but the lowest two bits in the mask, as shown below:

```
racadm config -g cfgRacTuning -o
cfgRacTuneIpRangeEnable 1
racadm config -g cfgRacTuning -o
cfgRacTuneIpRangeAddr 192.168.0.212
racadm config -g cfgRacTuning -o
cfgRacTuneIpRangeMask 255.255.255.252
```

IP Filtering Guidelines

Use the following guidelines when enabling IP filtering:

- Ensure that **cfgRacTuneIpRangeMask** is configured in the form of a netmask, where all most significant bits are 1's (which defines the subnet in the mask) with a transition of all 0's in the lower-order bits.
- Use the range base address you prefer as the value for **cfgRacTuneIpRangeAddr**. The 32-bit binary value of this address should have zeros in all the low-order bits where there are zeros in the mask.

IP Blocking

IP blocking dynamically determines when excessive login failures occur from a particular IP address and blocks (or prevents) the address from logging into the DRAC 5 for a preselected time span.

The IP blocking parameter uses **cfgRacTuning** group features that include:

- The number of allowable login failures
- The timeframe in seconds when these failures must occur
- The amount of time in seconds when the "guilty" IP address is prevented from establishing a session after the total allowable number of failures is exceeded

As login failures accumulate from a specific IP address, they are "aged" by an internal counter. When the user logs in successfully, the failure history is cleared and the internal counter is reset.



NOTE: When login attempts are refused from the client IP address, some SSH clients may display the following message: `ssh exchange identification: Connection closed by remote host.`

See "DRAC 5 Property Database Group and Object Definitions" on page 345 for a complete list of **cfgRacTune** properties.

Table 12-16 lists the user-defined parameters.

Table 12-16. Login Retry Restriction Properties

Property	Definition
cfgRacTuneIpBlkEnable	Enables the IP blocking feature. When consecutive failures (cfgRacTuneIpBlkFailCount) from a single IP address are encountered within a specific amount of time (cfgRacTuneIpBlkFailWindow), all further attempts to establish a session from that address are rejected for a certain timespan (cfgRacTuneIpBlkPenaltyTime).
cfgRacTuneIpBlkFailCount	Sets the number of login failures from an IP address before the login attempts are rejected.
cfgRacTuneIpBlkFailWindow	The timeframe in seconds when the failure attempts are counted. When the failures exceed this limit, they are dropped from the counter.

Table 12-16. Login Retry Restriction Properties (continued)

Property	Definition
<code>cfgRacTuneIpBlkPenaltyTime</code>	Defines the timespan in seconds when all login attempts from an IP address with excessive failures are rejected.

Enabling IP Blocking

The following example prevents a client IP address from establishing a session for five minutes if that client has failed its five login attempts in a one-minute period of time.

```
racadm config -g cfgRacTuning -o
cfgRacTuneIpRangeEnable 1
racadm config -g cfgRacTuning -o
cfgRacTuneIpBlkFailCount 5
racadm config -g cfgRacTuning -o
cfgRacTuneIpBlkFailWindows 60
racadm config -g cfgRacTuning -o
cfgRacTuneIpBlkPenaltyTime 300
```

The following example prevents more than three failed attempts within one minute, and prevents additional login attempts for an hour.

```
racadm config -g cfgRacTuning -o
cfgRacTuneIpBlkEnable 1
racadm config -g cfgRacTuning -o
cfgRacTuneIpBlkFailCount 3
racadm config -g cfgRacTuning -o
cfgRacTuneIpBlkFailWindows 60
racadm config -g cfgRacTuning -o
cfgRacTuneIpBlkPenaltyTime 3600
```

Configuring the Network Security Settings Using the DRAC 5 GUI

 **NOTE:** You must have **Configure DRAC 5** permission to perform the following steps.

- 1 In the System tree, click **Remote Access**.
- 2 Click the **Configuration** tab and then click **Network**.
- 3 In the **Network Configuration** page, click **Advanced Settings**.
- 4 In the **Network Security** page, configure the attribute values and then click **Apply Changes**.

Table 12-17 describes the **Network Security** page settings.

- 5 Click the appropriate **Network Security** page button to continue. See Table 12-18 for description of the **Network Security** page buttons.

Table 12-17. Network Security Page Settings

Settings	Description
IP Range Enabled	Enables the IP Range checking feature, which defines a specific range of IP addresses that can access the DRAC 5.
IP Range Address	Determines the acceptable IP subnet address.
IP Range Subnet Mask	Defines the significant bit positions in the IP address. The subnet mask should be in the form of a netmask, where the more significant bits are all 1's with a single transition to all zeros in the lower-order bits. For example: 255.255.255.0
IP Blocking Enabled	Enables the IP address blocking feature, which limits the number of failed login attempts from a specific IP address for a preselected time span.
IP Blocking Fail Count	Sets the number of login failures attempted from an IP address before the login attempts are rejected from that address.
IP Blocking Fail Window	Determines the time span in seconds within which IP Block Fail Count failures must occur to trigger the IP Block Penalty Time.
IP Blocking Penalty Time	The time span in seconds within which login attempts from an IP address with excessive failures are rejected.

Table 12-18. Network Security Page Buttons

Button	Description
Print	Prints the Network Security page
Refresh	Reloads the Network Security page
Apply Changes	Saves the changes made to the Network Security page.
Go Back to Network Configuration Page	Returns to the Network Configuration page.

Using the DRAC 5 SM-CLP Command Line Interface

This section provides information about the Server Management Workgroup (SMWG) Server Management-Command Line Protocol (SM-CLP) that is incorporated in the DRAC 5.



NOTE: This section assumes that you are familiar with the Systems Management Architecture for Server Hardware (SMASH) Initiative and the SMWG SM-CLP specifications. For more information on these specifications, see the Distributed Management Task Force (DMTF) website at www.dmtf.org.

The DRAC 5 SM-CLP is a protocol driven by the DMTF and SMWG to provide standards for systems management CLI implementations. The SMWG SM-CLP is a subcomponent of the overall SMASH efforts overseen by DMTF.

DRAC 5 SM-CLP Support

DRAC 5 is the first RAC product that provides support for the SM-CLP standard-based command line protocol. The SM-CLP is hosted from the DRAC 5 controller firmware and supports telnet, SSH, and serial-based interfaces. The DRAC 5 SM-CLP interface is based on the SM-CLP Specification Version 1.0 provided by the DMTF organization.

The following sections provide an overview of the SM-CLP feature that is hosted from the DRAC 5.

SM-CLP Features

The SM-CLP promotes the concept of verbs and targets to provide system management capabilities through the CLI. The verb indicates the operation to perform, and the target determines the entity (or object) that runs the operation.

Below is an example of the SM-CLP command line syntax.

```
<verb> [ <options> ] [ <target> ] [ <properties> ]
```

During a typical SM-CLP session, the user can perform operations using the verbs listed in Table 13-1 and Table 13-2.

Table 13-1. Supported CLI Verbs for System

Verb	Definition
cd	Navigates through the MAP using the shell.
delete	Deletes an object instance.
help	Displays help for a specific target.
reset	Resets the target.
show	Displays the target properties, verbs, and subtargets.
start	Turns on a target.
stop	Shuts down a target.
exit	Exits from the SM-CLP shell session.
version	Displays the version attributes of a target.

Table 13-2. Supported CLI Verbs for Fans, Batteries, Intrusion, Hardware Performance, Power supplies, Temperatures and Voltages

Verb	Definition
cd	Navigates through the MAP using the shell.
help	Displays help for a specific target.
show	Displays the target properties, verbs, and subtargets.
exit	Exits from the SM-CLP shell session.
version	Displays the version attributes of a target.

Using SM-CLP

- 1 SSH (or telnet) to the DRAC 5 with correct credentials.
- 2 At the command prompt, type `smc_lsp`.
The SMCLP prompt (->) is displayed.

SM-CLP Management Operations and Targets

Management Operations

The DRAC 5 SM-CLP enables users to manage the following:

- Server Power Management — Turn on, shutdown, or reboot the system
- System Event Log (SEL) Management — Display or clear the SEL records

Options

Table 13-3 lists the supported SM-CLP options.

Table 13-3. Supported SM-CLP Options

SM-CLP Option	Description
-all	Instructs the verb to perform all possible functions.
-display	Displays the user-defined data.
-examine	Instructs the command processor to validate the command syntax without executing the command.
-help	Displays command verb help.
-version	Displays the command verb version.

Targets

Table 13-4 provides a list of targets provided through the SM-CLP to support these operations.

Table 13-4. SM-CLP Targets

Target	Definition
/system1	The managed system target.
/system1/logs1	The log collections target
/system1/logs1/log1	The System Event Log (SEL) target on the managed system.
/system1/logs1/log1/record1	An individual SEL record instance on the managed system.
/system1/pwrmgtsvc1	The power management service for the system.

Table 13-4. SM-CLP Targets (continued)

Target	Definition
/system1/pwrmgtsvc1/ pwrmgtcapl	Capabilities of the power management service for the system.
/system1/fan1	A fan target on the managed system.
/system1/fan1/ tachsensor1	An individual sensor target on the fan target on the managed system.
/system1/batteries1	A battery target on the managed system.
/system1/batteries1/ sensor1	An individual sensor target on the battery target on the managed system.
/system1/intrusion1	A chassis intrusion target on the managed system.
/system1/intrusion1/ sensor1	An individual sensor target on the chassis intrusion target on the managed system.
/system1/hardwareperformancel	A hardware performance target on the managed system.
/system1/hardwareperformancel/ sensor1	An individual sensor target on the hardware performance target on the managed system.
/system1/powersupplies1	A power supply target on the managed system.
/system1/powersupplies1/ sensor1	An individual sensor target on the power supply target on the managed system.
/system1/temperatures1	A temperature target on the managed system.
/system1/temperatures1/ tempsensor1	An individual sensor target on the temperature target on the managed system.
/system1/voltages1	A voltage target on the managed system.
/system1/voltages1/ voltage sensor1	An individual sensor target on the voltage target on the managed system.
/system1/chassis1	An individual chassis target of the system.

SM-CLP Output Format

The DRAC 5 currently supports text-based output as described in the SM-CLP specifications.

DRAC 5 SM-CLP Examples

The following subsections provide sample scenarios for using the SM-CLP to perform the following operations:

- Server power management
- SEL management
- MAP target navigation
- Display system properties

Server Power Management

Table 13-5 provides examples of using SM-CLP to perform power management operations on a managed system.

Table 13-5. Server Power Management Operations

Operation	Syntax
Logging into the RAC using the telnet/SSH interface	<pre>>ssh 192.168.0.120 >login: root >password:</pre>
Starting the SM-CLP management shell	<pre>- >smclp DRAC5 SM-CLP System Management Shell, version 1.0 Copyright (c) 2004-2008 Dell, Inc. All Rights Reserved -></pre>
Power down the server	<pre>- ->stop /system1 system1 has been stopped successfully</pre>
Power up the server from a powered-off state	<pre>- ->start /system1 system1 has been started successfully</pre>
Reboot the server	<pre>->reset /system1 system1 has been reset successfully</pre>

SEL Management

Table 13-6 provides examples of using the SM-CLP to perform SEL-related operations on the managed system.

Table 13-6. SEL Management Operations

Operation	Syntax
Viewing the SEL	<pre>->show /system1/logs1/log1 /system1/logs1/log1</pre>
	<pre>Targets: Record1 Record2 Record3 Record4 Record5</pre>
	<pre>Properties: InstanceID = IPMI:BMC1 SEL Log MaxNumberOfRecords = 512 CurrentNumberOfRecords = 5 Name = IPMI SEL EnabledState = 2 OperationalState = 2 HealthState = 2 Caption = IPMI SEL Description = IPMI SEL ElementName = IPMI SEL</pre>
	<pre>Commands: cd show help exit version</pre>

Table 13-6. SEL Management Operations (continued)

Operation	Syntax
Viewing the SEL record	<pre>->show /system1/logs1/log1/record4 /system1/logs1/log1/record4 Properties: LogCreationClassName = CIM_RecordLog CreationClassName = CIM_LogRecord LogName = IPMI SEL RecordID = 1 MessageTimeStamp = 20050620100512.000000- 000 Description = FAN 7 RPM: fan sensor, detected a failure ElementName = IPMI SEL Record Commands: cd show help exit version</pre>
Clearing the SEL	<pre>->delete /system1/logs1/log1/record* All records deleted successfully</pre>

Batteries Management

Table 13-7 provides example of using the SM-CLP to perform operations on the batteries.

Table 13-7. Batteries Management Operations

Operation	Syntax
Viewing the status of the batteries	<pre>->show system1/batteries1/sensor1 /system1/batteries1/sensor1: Properties: SystemCreationClassName = CIM_ComputerSystem SystemName = F196P1S CreationClassName = CIM_Sensor DeviceID = BATTERY 1 SensorType = 1 PossibleStates = {"Good" "Bad" "Unknown"} CurrentState = good ElementName = System Board CMOS Battery OtherSensorTypeDescription = CMOS battery sensor. EnabledState = 1 Verbs: cd exit help show version</pre>

MAP Target Navigation

Table 13-8 provides examples of using the `cd` verb to navigate the MAP. In all examples, the initial default target is assumed to be `/`.

Table 13-8. Map Target Navigation Operations

Operation	Syntax
Navigate to the system target and reboot	<code>->cd system1</code> <code>->reset</code>
NOTE: The current default target is <code>/</code> .	
Navigate to the SEL target and display the log records	<code>->cd system1</code> <code>->cd logs1/log1</code> <code>->show</code> <code>->cd system1/logs1/log1</code> <code>->show</code>
Display current target	<code>->cd .</code>
Move up one level	<code>->cd ..</code>
Exiting the shell	<code>->exit</code>

System Properties

The Table 13-9 lists the system properties that are displayed when the user types the following:

```
show /system1
```

These properties are derived from the Base System Profile that is provided by the standards body and is based on the `CIM_ComputerSystem` class as defined by the CIM schema.

For additional information, see the DMTF CIM schema definitions.

Table 13-9. System Properties

Object	Property	Description
CIM_ComputerSystem	Name	Unique identifier of a System instance that exists in the enterprise environment. MaxLen = 256
	ElementName	User-friendly name for the system. MaxLen = 64
	NameFormat	Identifies the method by which the Name is generated. Values: Other, IP, Dial, HID, NWA, HWA, X25, ISDN, IPX, DCC, ICD, E.164, SNA, OID/OSI, WWN, NAA

Table 13-9. System Properties (continued)

Object	Property	Description
	Dedicated	Enumeration indicating whether the system is a special-purpose system or general-purpose system. Values: 0=Not Dedicated 1=Unknown 2=Other 3=Storage 4=Router 5=Switch 6=Layer 3 Switch 7=CentralOffice Switch 8=Hub 9=Access Server 10=Firewall 11=Print 12=I/O 13=Web Caching 14=Management 15=Block Server

Table 13-9. System Properties (continued)

Object	Property	Description
		16=File Server
		17=Mobile User Device,
		18=Repeater
		19=Bridge/Extender
		20=Gateway
		21=Storage Virtualizer
		22=Media Library
		23=Extender Node
		24=NAS Head
		25=Self-Contained NAS
		26=UPS
		27=IP Phone
		28=Management Controller
		29=Chassis Manager
	ResetCapability	Defines the reset methods available on the system Values: 1=Other 2=Unknown 3=Disabled 4=Enabled 5=Not Implemented
	CreationClassName	The superclass from which this instance is derived.

Table 13-9. System Properties (continued)

Object	Property	Description
	EnabledState	Indicates the enabled/disabled states of the system. Values: 0=Unknown 1=Other 2=Enabled 3=Disabled 4=Shutting Down 5=Not Applicable 6=Enabled but Offline 7=In Test 8=Deferred 9=Quiesce 10=Starting
	EnabledDefault	Indicates the default startup configuration for the enabled state of the system. By default, the system is "Enabled" (value=2). Values: 2=Enabled 3=Disabled 4=Not Applicable 5=Enabled but Offline 6=No Default

Table 13-9. System Properties (continued)

Object	Property	Description
	RequestedState	Indicates the last requested or desired state for the system. Values: 2=Enabled 3=Disabled 4=Shut Down 5=No Change 6=Offline 7=Test 8=Deferred 9=Quiesce 10=Reboot 11=Reset 12=Not Applicable
	HealthState	Indicates the current health of the system. Values: 0=Unknown 5=OK 10=Degraded/Warning 15=Minor Failure 20=Major Failure 30=Critical Failure 35=Non-recoverable Error

Table 13-9. System Properties (continued)

Object	Property	Description
	<code>OperationalStatus</code>	Indicates the current status of the system. Values: 0=Unknown 1=Other 2=OK 3=Degraded 4=Stressed 5=Predictive Failure 6=Error 7=Non-Recoverable Error 8=Starting 9=Stopping 10=Stopped 11=In Service 12=No Contact 13=Lost Communication 14=Aborted 15=Dormant 16=Supporting Entity in Error 17=Completed 18=Power Mode
	<code>Description</code>	A text-based description of the system.

Property Names for Fan, Temperature, Numeric Voltage, Power Consumption, and Amperage Sensors

Supported Property Names for Fans, Temperature, Numeric Voltage, Power Consumption, and Amperage Sensors

Table 13-10. Sensors

Object	Property	Description
CIM_NumericSensor	SystemCreationClassName	The name of the system creation class— CIM_ComputerSystem)
	SystemName	The service tag of the system, which is a unique identifier of a system that exists in the enterprise environment
	CreationClassName	The creation class name — CIM_NumericSensor
	DeviceID	The unique ID for the sensor in the system fan1...n (for tachsensor) temp 1...n (for tempsensor) numeric voltage 1...n) for numeralsensor (voltage) (PMBus systems only)) power consumption 1...n (for power consumption (PMBus systems only)) amperage 1...n (for amperage (PMBus systems only))

Supported Property Names for Fans, Temperature, Numeric Voltage, Power Consumption, and Amperage Sensors

Table 13-10. Sensors (continued)

Object	Property	Description
	BaseUnits	The units of measurement of the sensor RPM=Tachometer (for tachsensor) C=Temperature (for tempsensor) V=Voltage (for numericsensor) Watts=Power Consumption (for powerconsumption) Amp=Amperage (for amperage)
	CurrentReading	The current reading of the sensor.
	LowerThresholdNonCritical	The lower threshold non critical value
	UpperThresholdNonCritical	The upper threshold non critical value
	LowerThresholdCritical	The lower threshold critical value
	UpperThresholdCritical	The upper threshold critical value

Supported Property Names for Fans, Temperature, Numeric Voltage, Power Consumption, and Amperage Sensors

Table 13-10. Sensors (continued)

Object	Property	Description
	SupportedThreshold	The supported threshold for the sensor. { "LowerThresholdCritical" } (for tachsensor) { "LowerThresholdNonCritical", "UpperThresholdNonCritical", "UpperThresholdCritical", "LowerThresholdCritical" } (for tempsensor) { } (for voltsensor (numeric sensor)) { "UpperThresholdNonCritical", "UpperThresholdCritical" } (for powerconsumption) { } for amperage)
	SettableThreshold	The threshold levels that you can set for a sensor. { } (no sensor support for setting the threshold values)
	SensorTypes	Type of the sensor: 5=Tachometer (for tachsensor) 2=Temperature (for temperature) 3=Voltage (for voltage) 1=Power Consumption (for powerconsumption) 1=Ampereage (for amperage)
	PossibleStates	The possible states of the sensor. { "unknown", "warning", "failed", "non-recoverable" }

Supported Property Names for Fans, Temperature, Numeric Voltage, Power Consumption, and Amperage Sensors

Table 13-10. Sensors (continued)

Object	Property	Description
	CurrentState	The current state as reported by a sensor
	ElementName	The name of the sensor
	OtherSensorTypeDescription	If the <code>sensortype</code> property contains a value of "1" (others), this property gives additional description about that sensor. "Power consumption sensor." for <code>powerconsumption</code> "Amperage sensor." for <code>amperage</code>
	EnabledState	Indicates if the sensor is enabled or disabled. 1=Enabled

Property Names for Power Supply Sensors

Table 13-11. Supported Property Names for Power Supply Sensors

Object	Property	Description
CIM_NumericSensor	SystemCreationClassName	The name of the system creation class (CIM_ComputerSystem)
	SystemName	The service tag of the system, which is a unique identifier of a system that exists in the enterprise environment
	CreationClassName	The creation class name — CIM_PowerSupply
	DeviceID	The unique ID for the sensor in the system. <code>pwrsupply 1...n</code>

Table 13-11. Supported Property Names for Power Supply Sensors (continued)

Object	Property	Description
	TotalOutputPower	The total power output as shown on the DRAC user interface
	ElementName	Name of the particular sensor.
	OperationalStatus	Current operational status of the power supply unit.
	HealthState	The health status of the power supply unit.
	EnabledState	Indicates if the sensor is enabled or disabled 1=Enabled

Property Names for Intrusion, Battery, Voltage, and Hardware Performance Sensors

Table 13-12. Supported Property Names for Intrusion, Battery, Voltage, and Hardware Performance Sensors

Object	Property	Description
CIM_NumericSensor	SystemCreationClassName	The name of the system creation class—CIM_ComputerSystem)
	SystemName	The service tag of the system, which is a unique identifier of a system that exists in the enterprise environment
	CreationClassName	The creation class name —CIM_Sensor
	DeviceID	Unique ID for the sensor in the system Intrusion1...n (for intrusion sensor) Battery1...n (for battery sensor) Voltage1...n (for voltage sensor) Hardware performance sensor1...n (for hardware performance sensor)
	SensorType	1=Other 3=Voltage (for voltage sensor)

Table 13-12. Supported Property Names for Intrusion, Battery, Voltage, and Hardware Performance Sensors (*continued*)

Object	Property	Description
	PossibleStates	The possible states for the sensor { "no intrusion","chassis intrusion","drive bay intrusion," "I/O card area intrusion," "processor area intrusion," "LAN disconnect," "unauthorized dock," "FAN area intrusion" } (for the Intrusion sensor) { "absent," "low," "failed," "good" } (for the Battery sensor) { "good," "bad," "unknown" } (for the Voltage sensor) { "Normal," "Others," "Thermal Protection," "Cooling Capacity changed," "Power Capacity changed," "User Configuration" } (for the Hardware Performance sensor)
	CurrentState	Current state reported by the sensor.
	ElementName	The name of the sensor
	OtherSensorTypeDescription	If the <code>sensortype</code> property contains a value of "1" (others), this property gives additional description about that sensor. "Chassis intrusion sensor" (for Intrusion sensor) "CMOS battery sensor" (for Battery sensor) "Hardware performance sensor" (for Hardware Performance)
	EnabledState	Indicates if the sensor is enabled or disabled 1=Enabled (for all sensors)

Property Names for Fan and Power Supply Redundancy Set Sensors

Table 13-13. Supported Property Names for Fan and Power Supply Redundancy Set Sensors

Object	Property	Description
CIM_RedundancySet	InstanceID	Instance number
	RedundancyStatus	The redundancy status.
	TypeOfSet	3=Load balanced (for fan redundancy) 4=Sparing (for Power Supply redundancy)
	MinNumberNeeded	0=Unknown
	ElementName	Name of the sensor

Property Names for Chassis Sensors

Table 13-14. Supported Property Names for Chassis Sensors

Object	Property	Description
CIM_Chassis	CreationClassName	The name of the creation class—CIM_Chassis
	PackageType	Type of package 3=Chassis
	ChassisPackageType	Chassis package type 17=Main system chassis
	Manufacturer	Manufacturer "Dell"
	Model	The model name of the system
	ElementName	Element name

Property Names for Power Management Service

Table 13-15. Supported Property Names for Power Management Service

Object	Property	Description
CIM_PowerManagement Service	CreationClassName	The name of the creation class—CIM_PowerManagementService
	Name	IPMI Power Service
	ElementName	Dell Server Power Management Service
	powerstate	Current power state of the system. 2=On 6=Off Can be set to the following values: 2=Power On 6=Power Off 5=Power Reset 9=Powercycle the system

Using the `set` verb, you can set the power state of the system. for example, to turn on the system if it is off:

```
set powerstate=2
```

Property Names for Power Capability

Table 13-16. Supported Property Names for Power Capability

Object	Property	Description
CIM_PowerManagementCapabilities	InstanceID	Unique instance ID for the power capabilities
	PowerChangeCapabilities	3=Power State Settable
	ElementName	Dell Server Power Management Service
	PowerStatesSupported	2=Power On 6=Power Off 5=Power Reset 9=Powercycle the system

Monitoring and Alert Management

This section explains how to monitor the DRAC 5 and procedures to configure your system and the DRAC 5 to receive alerts.

Configuring the Managed System to Capture the Last Crash Screen

Before the DRAC 5 can capture the last crash screen, you must configure the managed system with the following prerequisites.

- 1 Install the managed system software. For more information about installing the managed system software, see the *Server Administrator User's Guide*.
- 2 Run a supported Microsoft Windows operating system with the Windows "automatically reboot" feature deselected in the **Windows Startup and Recovery Settings**.
- 3 Enable the Last Crash Screen (disabled by default).

To enable using local RACADM, open a command prompt and type the following commands:

```
racadm config -g cfgRactuning -o  
cfgRactTuneAsrEnable 1
```

- 4 Enable the Auto Recovery timer and set the **Auto Recovery** action to **Reset**, **Power Off**, or **Power Cycle**. To configure the **Auto Recovery** timer, you must use Server Administrator or IT Assistant.

For information about how to configure the **Auto Recovery** timer, see the *Server Administrator User's Guide*. To ensure that the last crash screen can be captured, the **Auto Recovery** timer must be set to 60 seconds or greater. The default setting is 480 seconds.

The last crash screen is not available when the **Auto Recovery** action is set to **Shutdown** or **Power Cycle** if the managed system is powered off.

Disabling the Windows Automatic Reboot Option

To ensure that the DRAC 5 Web-based interface last crash screen feature works properly, disable the **Automatic Reboot** option on managed systems running the Microsoft Windows Server 2003 and Windows 2000 Server operating systems.

Disabling the Automatic Reboot Option in Windows Server 2003

- 1 Open the Windows Control Panel and double-click the System icon.
- 2 Click the Advanced tab.
- 3 Under Startup and Recovery, click Settings.
- 4 Deselect the Automatically Reboot check box.
- 5 Click OK twice.

Disabling the Automatic Reboot Option in Windows 2000 Server

- 1 Open the Windows Control Panel and double-click the System icon.
- 2 Click the Advanced tab.
- 3 Click the Startup and Recovery... button.
- 4 Deselect the Automatically Reboot check box.

Configuring Platform Events

Platform event configuration provides a mechanism for configuring the remote access device to perform selected actions on certain event messages. These actions include reboot, power cycle, power off, power reduction, and triggering an alert (Platform Events Trap [PET] and/or e-mail).

The filterable Platform Events include the following:

- Fan Probe Failure
- Battery Probe Warning
- Battery Probe Failure
- Discrete Voltage Probe Failure
- Temperature Probe Warning
- Temperature Probe Failure
- Chassis Intrusion Detected

- Redundancy Degraded
- Redundancy Lost
- Processor Warning
- Processor Failure
- Processor Absent
- PS/VRM/D2D Warning
- PS/VRM/D2D Failure
- Power Supply Absent
- Hardware Log Failure
- Automatic System Recovery
- System Power Probe Warning
- System Power Probe Failure

When a platform event occurs (for example, a fan probe failure), a system event is generated and recorded in the System Event Log (SEL). If this event matches a platform event filter (PEF) in the Platform Event Filters list in the Web-based interface and you have configured this filter to generate an alert (PET or e-mail), then a PET or e-mail alert is sent to a set of one or more configured destinations.

If the same platform event filter is also configured to perform an action (such as rebooting the system), the action is performed.

Configuring Platform Event Filters (PEF)

Configure your platform event filters before you configure the platform event traps or e-mail alert settings.

Configuring PEF Using the Web User Interface

- 1** Log in to the remote system using a supported Web browser. See "Accessing the Web-Based Interface" on page 48.
- 2** Click the **Alert Management** tab and then click **Platform Events**.
- 3** Enable global alerts.
 - a** Click **Alert Management** and select **Platform Events**.
 - b** Select the **Enable Platform Event Filter Alert** check box.

- 4 Under **Platform Events Filters Configuration**, select the **Enable Platform Event Filter** alerts check box and then click **Apply Changes**.
- 5 Under **Platform Event Filters List**, click a filter that you want to configure.
- 6 In the **Set Platform Events** page, make the appropriate selections and then click **Apply Changes**.



NOTE: Generate Alert must be enabled for an alert to be sent to any valid, configured destination (PET or e-mail).

Configuring PEF Using the RACADM CLI

- 1 Enable PEF.

Open a command prompt, type the following command, and press <Enter>:

```
racadm config -g cfgIpmiPef -o cfgIpmiPefEnable -i 1 1
```

where 1 and 1 are the PEF index and the enable/disable selection, respectively.

The PEF index can be a value from 1 through 17. The enable/disable selection can be set to 1 (Enabled) or 0 (Disabled).

For example, to enable PEF with index 5, type the following command:

```
racadm config -g cfgIpmiPef -o cfgIpmiPefEnable -i 5 1
```

- 2 Configure your PEF actions.

At the command prompt, type the following command and press <Enter>:

```
racadm config -g cfgIpmiPef -i <index> -o cfgIpmiPefAction <action>
```

where the <action> values bits are as follows:

- <action> value bit 0 – 1 = enable alert action, 0 = disable alert
- <action> value bit 1 – 1 = power off; 0 = no power off
- <action> value bit 2 – 1 = reboot; 0 = no reboot

- `<action>` value bit 3 – 1 = power cycle; 0 = no power cycle
- `<action>` value bit 4 – 1 = power reduction; 0 = no power reduction

For example, to enable PEF to reboot the system, type the following command:

```
racadm config -g cfgIpmiPef -o cfgIpmiPefAction -i
1 2
```

where 1 is the PEF index and 2 is the PEF action to reboot.

Configuring PET

Configuring PET Using the Web User Interface

- 1 Login to the remote system using a supported Web browser. See "Accessing the Web-Based Interface" on page 48.
- 2 Ensure that you followed the procedures in "Configuring PEF Using the Web User Interface" on page 259.
- 3 Configure your PET policy.
 - a In the **Alert Management** tab, click **Traps Settings**.
 - b Under **Destination Configuration Settings**, configure the **Community String** field with the appropriate information and then click **Apply Changes**.
- 4 Configure your PET destination IP address
 - a In the **Destination Number** column, click a destination number.
 - b Ensure that the **Enable Destination** check box is selected.
 - c In the **Destination IP Address** field, type a valid PET destination IP address.
 - d Click **Apply Changes**.
 - e Click **Send Test Trap** to test the configured alert (if desired).

 **NOTE:** Your user account must have **Test Alerts** permission to perform this procedure. See Table 5-4.

 - f Repeat step a through step e for any remaining destination numbers.

Configuring PET Using RACADM CLI

- 1 Enable your global alerts.

Open a command prompt, type the following command, and press <Enter>:

```
racadm config -g cfgIpmiLan -o  
cfgIpmiLanAlertEnable 1
```

- 2 Enable PET.

At the command prompt, type the following commands and press <Enter> after each command:

```
racadm config -g cfgIpmiPet -o  
cfgIpmiPetAlertEnable -i 1 1
```

where 1 and 1 are the PET destination index and the enable/disable selection, respectively.

The PET destination index can be a value from 1 through 4. The enable/disable selection can be set to 1 (Enabled) or 0 (Disabled).

For example, to enable PET with index 4, type the following command:

```
racadm config -g cfgIpmiPet -o  
cfgIpmiPetAlertEnable -i 4 0
```

- 3 Configure your PET policy.

At the command prompt, type the following command and press <Enter>:

```
racadm config -g cfgIpmiPet -o  
cfgIpmiPetAlertDestIPAddr -i 1 <IP_address>
```

where 1 is the PET destination index and <IP_address> is the destination IP address of the system that receives the platform event alerts.

- 4 Configure the Community Name string.

At the command prompt, type:

```
racadm config -g cfgIpmiLan -o  
cfgIpmiPetCommunityName <Name>
```

Configuring E-Mail Alerts

Configuring E-mail Alerts Using the Web User Interface

- 1 Login to the remote system using a supported Web browser.
See "Accessing the Web-Based Interface" on page 48.
- 2 Ensure that you followed the procedures in "Configuring PEF Using the Web User Interface" on page 259.
- 3 Configure your e-mail alert settings.
 - a In the **Alert Management** tab, click **Email Alert Settings**.
 - b Under **SMTP (Email) Server Address settings**, configure the **SMTP (Email) Server IP address** field with the appropriate information and then click **Apply Changes**.
- 4 Configure your e-mail alert destination.
 - a In the **Email Alert Number** column, click an e-mail alert number.
 - b Ensure that the **Enable Email Alert** check box is selected.
 - c In the **Destination Email Address** field, type a valid e-mail address.
 - d In the **Email Description** field, enter a description (if required).
 - e Click **Apply Changes**.
 - f Click **Send Test Email** to test the configured e-mail alert (if desired).

 **NOTE:** Your user account must have **Test Alerts** permission to perform this procedure. See Table 5-4.

 - g Repeat step a through step e for any remaining e-mail alert settings.
- 5 Enable global alerts.
 - a Click **Alert Management** and select **Platform Events**.
 - b Select the **Enable Platform Event Filter Alert** check box.

Configuring E-Mail Alerts Using RACADM CLI

1 Enable your global alerts.

Open a command prompt, type the following command, and press <Enter>:

```
racadm config -g cfgIpmiLan -o  
cfgIpmiLanAlertEnable 1
```

2 Enable e-mail alerts.

At the command prompt, type the following commands and press <Enter> after each command:

```
racadm config -g cfgEmailAlert -o  
cfgEmailAlertEnable -i 1 1
```

where 1 and 1 are the e-mail destination index and the enable/disable selection, respectively.

The e-mail destination index can be a value from 1 through 4. The enable/disable selection can be set to 1 (Enabled) or 0 (Disabled).

For example, to enable e-mail with index 4, type the following command:

```
racadm config -g cfgEmailAlert -o  
cfgEmailAlertEnable -i 4 1
```

3 Configure your e-mail settings.

At the command prompt, type the following command and press <Enter>:

```
racadm config -g cfgEmailAlert -o  
cfgEmailAlertAddress -i 1 <e-mail_address>
```

where 1 is the e-mail destination index and <e-mail_address> is the destination e-mail address that receives the platform event alerts.

To configure a custom message, at the command prompt, type the following command and press <Enter>:

```
racadm config -g cfgEmailAlert -o  
cfgEmailAlertCustomMsg -i 1 <custom_message>
```

where 1 is the e-mail destination index and <custom_message> is the custom message.

Testing e-mail Alerting

The RAC e-mail alerting feature allows users to receive e-mail alerts when a critical event occurs on the managed system. The following example shows how to test the e-mail alerting feature to ensure that the RAC can properly send out e-mail alerts across the network.

```
racadm testemail -i 2
```



NOTE: Ensure that the **SMTP** and **Email Alert** settings are configured before testing the e-mail alerting feature. See "Configuring E-Mail Alerts" on page 263 for more information.

Testing the RAC SNMP Trap Alert Feature

The RAC SNMP trap alerting feature allows SNMP trap listener configurations to receive traps for system events that occur on the managed system.

The following example shows how a user can test the SNMP trap alert feature of the RAC.

```
racadm testtrap -i 2
```

Before you test the RAC SNMP trap alerting feature, ensure that the SNMP and trap settings are configured correctly. See "**testtrap**" on page 337 and "**testemail**" on page 336 subcommand descriptions to configure these settings.

Frequently Asked Questions

Why is the following message displayed:

Remote Access: SNMP Authentication Failure

As part of discovery, IT Assistant attempts to verify the device's get and set community names. In IT Assistant, you have the get **community name = public** and the set **community name = private**. By default, the community name for the DRAC 5 agent is public. When IT Assistant sends out a set request, the DRAC 5 agent generates the SNMP authentication error because it will only accept requests from **community = public**.

You can change the DRAC 5 community name using RACADM.

To see the DRAC 5 community name, use the following command:

```
racadm getconfig -g cfgOobSnmp
```

To set the DRAC 5 community name, use the following command:

```
racadm config -g cfgOobSnmp -o  
cfgOobSnmpAgentCommunity <community name>
```

To prevent SNMP authentication traps from being generated, you must enter community names that will be accepted by the agent. Since the DRAC 5 only allows one community name, you must use the same **get** and **set** community name for IT Assistant discovery setup.

Configuring Intelligent Platform Management Interface (IPMI)

Configuring IPMI

This section provides information about configuring and using the DRAC 5 IPMI interface. The interface includes the following:

- IPMI over LAN
- IPMI over Serial
- Serial over LAN

The DRAC 5 is fully IPMI 2.0 compliant. You can configure the DRAC IPMI using:

- your browser
- an open source utility, such as *ipmitool*
- the Dell OpenManage IPMI shell, *ipmish*
- RACADM

For more information about using the IPMI Shell, *ipmish*, see the *Dell OpenManage BMC User's Guide* located on the Dell Support website at support.dell.com/manuals.

For more information about using RACADM, see "Using RACADM Remotely" on page 78.

Configuring IPMI Using the Web-Based Interface

- 1 Login to the remote system using a supported Web browser. See "Accessing the Web-Based Interface" on page 48.
- 2 Configure IPMI over LAN.
 - a In the **System** tree, click **Remote Access**.
 - b Click the **Configuration** tab and click **Network**.

c In the **Network Configuration** page under **IPMI LAN Settings**, select **Enable IPMI Over LAN** and click **Apply Changes**.

d Update the IPMI LAN channel privileges, if required.

 **NOTE:** This setting determines the IPMI commands that can be executed from the IPMI over LAN interface. For more information, see the IPMI 2.0 specifications.

Under **IPMI LAN Settings**, click the **Channel Privilege Level Limit** drop-down menu, select **Administrator**, **Operator**, or **User** and click **Apply Changes**.

e Set the IPMI LAN channel encryption key, if required.

 **NOTE:** The DRAC 5 IPMI supports the RMCP+ protocol.

Under **IPMI LAN Settings** in the **Encryption Key** field, type the encryption key and click **Apply Changes**.

 **NOTE:** The encryption key must consist of an even number of hexadecimal characters with a maximum of 40 characters.

3 Configure IPMI Serial over LAN (SOL).

a In the **System** tree, click **Remote Access**.

b In the **Configuration** tab, click **Serial Over LAN**.

c In the **Serial Over LAN Configuration** page, select **Enable Serial Over LAN**.

d Update the IPMI SOL baud rate.

 **NOTE:** To redirect the serial console over LAN, ensure that the SOL baud rate is identical to your managed system's baud rate.

e Click the **Baud Rate** drop-down menu, select the appropriate baud rate, and click **Apply Changes**.

f Update the **Minimum Required Privilege**. This property defines the minimum user privilege that is required to use the **Serial Over LAN** feature.

Click the **Channel Privilege Level Limit** drop-down menu, select **User**, **Operator**, or **Administrator**.

g Click **Apply Changes**.

4 Configure IPMI Serial.

- a In the **Configuration** tab, click **Serial**.
- b In the **Serial Configuration** menu, change the IPMI serial connection mode to the appropriate setting.
Under **IPMI Serial**, click the **Connection Mode Setting** drop-down menu, select the appropriate mode.
- c Set the IPMI Serial baud rate.
Click the **Baud Rate** drop-down menu, select the appropriate baud rate, and click **Apply Changes**.
- d Set the Channel Privilege Level Limit.
Click the **Channel Privilege Level Limit** drop-down menu, select **Administrator**, **Operator**, or **User**.
- e Click **Apply Changes**.
- f Ensure that the serial MUX is set correctly in the managed system's BIOS Setup program.
 - Restart your system.
 - During POST, press <F2> to enter the BIOS Setup program.
 - Navigate to **Serial Communication**.
 - In the **Serial Connection** menu, ensure that **External Serial Connector** is set to **Remote Access Device**.
 - Save and exit the BIOS Setup program.
 - Restart your system.

If IPMI serial is in terminal mode, you can configure the following additional settings:

- Delete control
- Echo control
- Line edit
- New line sequences
- Input new line sequences

For more information about these properties, see the IPMI 2.0 specification.

Configuring IPMI Using the RACADM CLI

- 1 Login to the remote system using any of the RACADM interfaces. See "Using RACADM Remotely" on page 78.
- 2 Configure IPMI over LAN.

Open a command prompt, type the following command, and press <Enter>:

```
racadm config -g cfgIpmlan -o cfgIpmlanEnable 1
```



NOTE: This setting determines the IPMI commands that can be executed from the IPMI over LAN interface. For more information, see the IPMI 2.0 specifications.

- a Update the IPMI channel privileges.

At the command prompt, type the following command and press <Enter>:

```
racadm config -g cfgIpmlan -o  
cfgIpmlanPrivilegeLimit <level>
```

where <level> is one of the following:

- 2 (User)
- 3 (Operator)
- 4 (Administrator)

For example, to set the IPMI LAN channel privilege to 2 (User), type the following command:

```
racadm config -g cfgIpmlan -o  
cfgIpmlanPrivilegeLimit 2
```

- b Set the IPMI LAN channel encryption key, if required.



NOTE: The DRAC 5 IPMI supports the RMCP+ protocol. See the IPMI 2.0 specifications for more information.

At the command prompt, type the following command and press <Enter>:

```
racadm config -g cfgIpmlan -o  
cfgIpmlanEncryptionKey <key>
```

where <key> is a 20-character encryption key in a valid hexadecimal format.

3 Configure IPMI Serial over LAN (SOL).

At the command prompt, type the following command and press <Enter>:

```
racadm config -g cfgIpmiSol -o cfgIpmiSolEnable 1
```

- a** Update the IPMI SOL minimum privilege level.

 **CAUTION: The IPMI SOL minimum privilege level determines the minimum privilege required to activate IPMI SOL. For more information, see the IPMI 2.0 specification.**

At the command prompt, type the following command and press <Enter>:

```
racadm config -g cfgIpmiSol -o  
cfgIpmiSolMinPrivilege <level>
```

where <level> is one of the following:

- 2 (User)
- 3 (Operator)
- 4 (Administrator)

For example, to configure the IPMI privileges to 2 (User), type the following command:

```
racadm config -g cfgIpmiSol -o  
cfgIpmiSolMinPrivilege 2
```

- b** Update the IPMI SOL baud rate.

 **NOTE:** To redirect the serial console over LAN, ensure that the SOL baud rate is identical to your managed system's baud rate.

At the command prompt, type the following command and press <Enter>:

```
racadm config -g cfgIpmiSol -o  
cfgIpmiSolBaudRate <baud_rate>
```

where <baud_rate> is 9600, 19200, 57600, or 115200 bps.

For example:

```
racadm config -g cfgIpmiSol -o  
cfgIpmiSolBaudRate 57600
```

- c Enable SOL.



NOTE: SOL can be enabled or disabled for each individual user.

At the command prompt, type the following command and press <Enter>:

```
racadm config -g cfgUserAdmin -o  
cfgUserAdminSolEnable -i <id> 2
```

where <id> is the user's unique ID.

4 Configure IPMI Serial.

- a Change the IPMI serial connection mode to the appropriate setting.

At the command prompt, type the following command and press <Enter>:

```
racadm config -g cfgSerial -o  
cfgSerialConsoleEnable 0
```

- b Set the IPMI Serial baud rate.

Open a command prompt, type the following command, and press <Enter>:

```
racadm config -g cfgIpmiSerial -o  
cfgIpmiSerialBaudRate <baud_rate>
```

where <baud_rate> is 9600, 19200, 57600, or 115200 bps.

For example:

```
racadm config -g cfgIpmiSerial -o  
cfgIpmiSerialBaudRate 57600
```

- c Enable the IPMI serial hardware flow control.

At the command prompt, type the following command and press <Enter>:

```
racadm config -g cfgIpmiSerial -o  
cfgIpmiSerialFlowControl 1
```

- d Set the IPMI serial channel minimum privilege level.

At the command prompt, type the following command and press <Enter>:

```
racadm config -g cfgIpmiSerial -o  
cfgIpmiSerialChanPrivLimit <level>
```

where <level> is one of the following:

- 2 (User)
- 3 (Operator)
- 4 (Administrator)

For example, to set the IPMI serial channel privileges to 2 (User), type the following command:

```
racadm config -g cfgIpmiSerial -o  
cfgIpmiSerialChanPrivLimit 2
```

- e Ensure that the serial MUX is set correctly in the BIOS Setup program.
 - Restart your system.
 - During POST, press <F2> to enter the BIOS Setup program.
 - Navigate to **Serial Communication**.
 - In the **Serial Connection** menu, ensure that **External Serial Connector** is set to **Remote Access Device**.
 - Save and exit the BIOS Setup program.
 - Restart your system.

The IPMI configuration is complete.

If IPMI serial is in terminal mode, you can configure the following additional settings using `racadm config cfgIpmiSerial` commands:

- Delete control
- Echo control
- Line edit

- New line sequences
- Input new line sequences

For more information about these properties, see the IPMI 2.0 specification.

Using the IPMI Remote Access Serial Interface

In the IPMI serial interface, the following modes are available:

- **IPMI terminal mode** — Supports ASCII commands that are submitted from a serial terminal. The command set has a limited number of commands (including power control) and supports raw IPMI commands that are entered as hexadecimal ASCII characters.
- **IPMI basic mode** — Supports a binary interface for program access, such as the IPMI shell (IPMISH) that is included with the Baseboard Management Utility (BMU).

To configure the IPMI mode using RACADM:

- 1 Disable the RAC serial interface.

At the command prompt, type:

```
racadm config -g cfgSerial -o  
cfgSerialConsoleEnable 0
```

- 2 Enable the appropriate IPMI mode.

For example, at the command prompt, type:

```
racadm config -g cfgIpmiSerial -o  
cfgIpmiSerialConnectionMode <0 or 1>
```

See "DRAC 5 Property Database Group and Object Definitions" on page 345 for more information.

Configuring Serial Over LAN



NOTE: For complete Serial Over LAN information, see the *Dell OpenManage Baseboard Management Controller User's Guide*.

- 1 Expand the **System** tree and click **Remote Access**.
- 2 Click the **Configuration** tab and then click **Serial Over LAN**.
- 3 Configure the Serial Over LAN settings.
Table 15-1 provides information about the **Serial Over LAN Configuration** page settings.
- 4 Click **Apply Changes**.
- 5 Configure the advanced settings, if required. Otherwise, click the appropriate **Serial Over LAN Configuration** page button to continue (see Table 15-2).

To configure the advanced settings:

- a Click **Advanced Settings**.
- b In the **Serial Over LAN Configuration Advanced Settings** page, configure the advanced settings as required. See Table 15-3.
- c Click **Apply Changes**.
- d Click the appropriate **Serial Over LAN Configuration Advanced Settings** page button to continue. See Table 15-4 or description of the **Serial Over LAN Configuration Advanced Settings** page buttons.

Table 15-1. Serial Over LAN Configuration Page Settings

Setting	Description
Enable Serial Over LAN	Enables Serial Over LAN. Checked=Enabled; Unchecked=Disabled.
Baud Rate	The IPMI data speed. Select 9600 bps, 19.2 kbps, 57.6 kbps, or 115.2 kbps.
Channel Privilege Level Limit	Sets the IPMI Serial Over LAN minimum user privilege: Administrator, Operator, or User.

Table 15-2. Serial Over LAN Configuration Page Buttons

Button	Description
Print	Prints the Serial Over LAN Configuration page.
Refresh	Refreshes the Serial Over LAN Configuration page.
Advanced Settings	Opens the Serial Over LAN Configuration Advanced Settings page.
Apply Changes	Applies the Serial Over LAN Configuration page settings.

Table 15-3. Serial Over LAN Configuration Advanced Settings Page Settings

Setting	Description
Character Accumulate Interval	The amount of time that the BMC will wait before transmitting a partial SOL character data package. 1-based 5ms increments.
Character Send Threshold	The BMC will send an SOL character data package containing the characters as soon as this number of characters (or greater) has been accepted. 1-based units.

Table 15-4. Serial Over LAN Configuration Advanced Settings Page Buttons

Button	Description
Print	Prints the Serial Over LAN Configuration Advanced Settings page.
Refresh	Refreshes the Serial Over LAN Configuration Advanced Settings page.
Go Back To Serial Over LAN Configuration Page	Returns to the Serial Over LAN Configuration page.
Apply Changes	Applies the Serial Over LAN Configuration Advanced Settings page settings.

Recovering and Troubleshooting the Managed System

This section explains how to perform tasks related to recovering and troubleshooting a crashed remote system using the DRAC 5 Web-based interface.

- "First Steps to Troubleshoot a Remote System" on page 277
- "Managing Power on a Remote System" on page 277
- "Using the System Event Log (SEL)" on page 281
- "Viewing the Last System Crash Screen" on page 283

First Steps to Troubleshoot a Remote System

The following questions are commonly used to troubleshoot high-level problems in the managed system:

- 1 Is the system powered on or off?
- 2 If powered on, is the operating system functioning, crashed, or just frozen?
- 3 If powered off, did the power turn off unexpectedly?

For crashed systems, check the last crash screen (see "Viewing the Last System Crash Screen" on page 283), and use console redirection (see "Supported Screen Resolutions Refresh Rates on the Managed System" on page 162) and remote power management (see "Managing Power on a Remote System" on page 277) to restart the system and watch the reboot process.

Managing Power on a Remote System

The DRAC 5 enables you to remotely perform several power management actions on the managed system so you can recover after a system crash or other system event.

Use the **Power Management** page to do the following:

- Perform an orderly shutdown through the operating system when rebooting, and power the system on or off.

- View the system’s current **Power Status**—either **ON** or **OFF**.

To access the **Power Management** page from the **System** tree, click **System** and then click the **Power Management** tab.

 **NOTE:** You must have **Execute Server Action Commands** permission to perform power management actions.

Selecting Power Control Actions from the DRAC 5 GUI

- 1 Select one of the following **Power Control Actions**.
 - **Power On System**— Turns on the system power (equivalent to pressing the power button when the system power is off).
 - **Power Off System**— Turns off the system power (equivalent to pressing the power button when the system power is on).
 - **Reset System**— Resets the system (equivalent to pressing the reset button); the power is not turned off by using this function.
 - **Power Cycle System**— Power off, then reboot (cold boot) the system.
- 2 Click **Apply** to perform the power management action (for example, cause the system to power cycle).
- 3 Click the appropriate **Power Management** page button to continue (see Table 16-1).

Table 16-1. Power Management Page Buttons (Top Right)

Button	Action
Print	Prints the Power Management page
Refresh	Reloads the Power Management page

Selecting Power Control Actions from the DRAC 5 CLI

Use the `racadm serveraction` command to perform power management operations on the host system.

```
racadm serveraction <action>
```

The options for the `<action>` string are:

- `powerdown` — Powers down the managed system.
- `powerup` — Powers up the managed system.

- **powercycle** — Issues a power-cycle operation on the managed system. This action is similar to pressing the power button on the system's front panel to power down and then power up the system.
- **powerstatus** — Displays the current power status of the server ("ON", or "OFF")
- **hardreset** — Performs a reset (reboot) operation on the managed system.

Viewing System Information

The **System Summary** page displays information about the following system components:

- Main System Chassis
- Remote Access Controller
- Baseboard Management Controller

To access the system information, expand the **System** tree and click **Properties**.

Main System Chassis

Table 16-2 and Table 16-3 describes the main system chassis properties.



NOTE: To receive **Host Name** and **OS Name** information, you must have DRAC 5 services installed on the managed system.

Table 16-2. System Information Fields

Field	Description
Description	System description.
BIOS Version	System BIOS version.
Service Tag	System Service Tag number.
Host Name	Host system's name.
OS Name	Operating system running on the system.

Table 16-3. Auto Recovery Fields

Field	Description
Recovery Action	When a "system hang" is detected, the DRAC can be configured to do one of the following actions: No Action, Hard Reset, Power Down, or Power Cycle.
Initial Countdown	The number of seconds after a "system hang" is detected at which the DRAC will perform a Recovery Action.
Present Countdown	The current value, in seconds, of the countdown timer.

Table 16-4. Embedded NIC MAC Address

Field	Description
NIC1 Ethernet	The NIC 1 Ethernet address.
NIC2 Ethernet	The NIC 2 Ethernet address.

Remote Access Controller

Table 16-5 describes the Remote Access Controller properties.

Table 16-5. RAC Information Fields

Field	Description
Name	Short name.
Product Information	Verbose Name.
Hardware Version	Remote Access Controller card version, or "unknown".
Firmware Version	DRAC 5 current firmware version level.
Firmware Updated	Date and time that the firmware was last updated.
RAC Time	System clock setting.

Baseboard Management Controller

Table 16-6 describes the Baseboard Management Controller properties.

Table 16-6. BMC Information Fields

Field	Description
Name	"Baseboard Management Controller".
IPMI Version	Intelligent Platform Management Interface (IPMI) version.
Number of Possible Active Sessions	Maximum number of session that can be active at the same time.
Number of Current Active Sessions	Total number of current active sessions.
Firmware Version	Version of the BMC firmware.
LAN Enabled	LAN Enabled or LAN Disabled.

Using the System Event Log (SEL)

The **SEL Log** page displays system-critical events that occur on the managed system.

To view the System Event Log:

- 1 In the **System** tree, click **System**.
- 2 Click the **Logs** tab and then click **System Event Log**.

The **System Event Log** page displays the event severity and provides other information as shown in Table 16-7.

- 3 Click the appropriate **System Event Log** page button to continue (see Table 16-8).

Table 16-7. Status Indicator Icons



Icon/Category	Description
	A green check mark indicates a healthy (normal) status condition.
	A yellow triangle containing an exclamation point indicates a warning (noncritical) status condition.
	A red X indicates a critical (failure) status condition.

Table 16-7. Status Indicator Icons (continued)

Icon/Category	Description
	A question mark icon indicates that the status is unknown.
Date/Time	The date and time that the event occurred. If the date is blank, then the event occurred at System Boot. The format is mm/dd/yyyy hh:mm:ss, based on a 24-hour clock.
Description	A brief description of the event

Table 16-8. SEL Page Buttons

Button	Action
Print	Prints the SEL in the sort order that it appears in the window.
Clear Log	Clears the SEL. NOTE: The Clear Log button appears only if you have Clear Logs permission.
Save As	Opens a pop-up window that enables you to save the SEL to a directory of your choice. NOTE: If you are using Internet Explorer and encounter a problem when saving, be sure to download the Cumulative Security Update for Internet Explorer, located on the Microsoft Support website at support.microsoft.com .
Refresh	Reloads the SEL page.

Using the Command Line to View System Log

```
racadm getsel -i
```

The `getsel -i` command displays the number of entries in the SEL.

```
racadm getsel <options>
```



NOTE: If no arguments are specified, the entire log is displayed.



NOTE: See "getsel" on page 323 for more information on the options you can use.

The `clrsel` command removes all existing records from the SEL.

```
racadm clrsel
```

Using the POST and Operating System Boot Capture Logs

This feature of the DRAC 5 allows you to play back a stop motion video of the last three instances of the BIOS POST and operating system boot.

To view the POST and operating system Boot Capture logs:

- 1 In the System tree, click System.
- 2 Click the **Logs** tab and then click **Boot Capture** tab.
- 3 Select the log number of the POST or operating system Boot Capture log. The video of the logs is played on a new screen.
- 4 Click **Stop** to stop the video.

Viewing the Last System Crash Screen



CAUTION: The last crash screen feature requires the managed system with the **Auto Recovery** feature configured in **Server Administrator**. In addition, ensure that the **Automated System Recovery** feature is enabled using the DRAC. Navigate to the **Services** page under the **Configuration** tab in the **Remote Access** section to enable this feature.

The **Last Crash Screen** page displays the most recent crash screen, which includes information about the events that occurred before the system crash. The last system crash information is saved in DRAC 5 memory and is remotely accessible.

To view the **Last Crash Screen** page:

- 1 In the System tree, click System.
- 2 Click the **Logs** tab and then click **Last Crash**.

The **Last Crash Screen** page provides the following buttons (see Table 16-9) in the top-right corner of the screen:

Table 16-9. Last Crash Screen Page Buttons

Button	Action
Print	Prints the Last Crash Screen page.
Save	Opens a pop-up window that enables you to save the Last Crash Screen to a directory of your choice.
Delete	Deletes the Last Crash Screen page.
Refresh	Reloads the Last Crash Screen page.



NOTE: Due to fluctuations in the Auto Recovery timer, the **Last Crash Screen** may not be captured when the System Reset Timer is set to a value less than 30 seconds. Use Server Administrator or IT Assistant to set the System Reset Timer to at least 30 seconds and ensure that the **Last Crash Screen** functions properly. See "Configuring the Managed System to Capture the Last Crash Screen" on page 257 for additional information.

Recovering and Troubleshooting the DRAC 5

This section explains how to perform tasks related to recovering and troubleshooting a crashed DRAC 5.

You can use one of the following tools to troubleshoot your DRAC 5:

- RAC Log
- Diagnostic Console
- Trace Log
- racdump
- coredump

Using the RAC Log

The **RAC Log** is a persistent log maintained in the DRAC 5 firmware. The log contains a list of user actions (such as log in, log out, and security policy changes) and alerts issued by the DRAC 5. The oldest entries are overwritten when the log becomes full.

To access the RAC Log from the DRAC 5 user interface (UI):

- 1** In the **System** tree, click **Remote Access**.
- 2** Click the **Logs** tab and then click **RAC Log**.

The **RAC Log** provides the information listed in Table 17-1.

Table 17-1. RAC Log Page Information

Field	Description
Date/ Time	The date and time (for example, Dec 19 16:55:47). When the DRAC 5 initially starts and is unable to communicate with the managed system, the time will be displayed as System Boot.
Source	The interface that caused the event.
Description	A brief description of the event and the user name that logged into the DRAC 5.

Using the RAC Log Page Buttons

The RAC Log page provides the buttons listed in Table 17-2.

Table 17-2. RAC Log Buttons

Button	Action
Print	Prints the RAC Log page.
Clear Log	Clears the RAC Log entries. NOTE: The Clear Log button only appears if you have Clear Logs permission.
Save As	Opens a pop-up window that enables you to save the RAC Log to a directory of your choice. NOTE: If you are using Internet Explorer and encounter a problem when saving, be sure to download the Cumulative Security Update for Internet Explorer, located on the Microsoft Support website at support.microsoft.com .
Refresh	Reloads the RAC Log page.

Using the Command Line

Use the `getraclog` command to view the RAC log entries.

```
racadm getraclog -i
```

The `getraclog -i` command displays the number of entries in the DRAC 5 log.

```
racadm getraclog [options]
```



NOTE: For more information, see "getraclog" on page 321.

You can use the `clrraclog` command to clear all entries from the RAC log.

```
racadm clrraclog
```

Using the Diagnostic Console

The DRAC 5 provides a standard set of network diagnostic tools (see Table 17-3) that are similar to the tools included with Microsoft Windows or Linux-based systems. Using the DRAC 5 Web-based interface, you can access the network debugging tools.

To access the **Diagnostic Console** page:

- 1 In the **System** tree, click **Remote Access**.
- 2 Click the **Diagnostics** tab.

Table 17-3 describes the options that are available on the **Diagnostic Console** page. Type a command and click **Submit**. The debugging results appear in the **Diagnostic Console** page.

To refresh the **Diagnostic Console** page, click **Refresh**. To execute another command, click **Go Back to Diagnostics Page**.

Table 17-3. Diagnostic Commands

Command	Description
arp	Displays the contents of the Address Resolution Protocol (ARP) table. ARP entries may not be added or deleted.
ifconfig	Displays the contents of the network interface table.

Table 17-3. Diagnostic Commands (continued)

Command	Description
netstat	Prints the content of the routing table. If the optional interface number is provided in the text field to the right of the netstat option, then netstat prints additional information regarding the traffic across the interface, buffer usage, and other network interface information.
ping <IP Address>	Verifies that the destination IP address is reachable from the DRAC 5 with the current routing-table contents. A destination IP address must be entered in the field to the right of this option. An Internet control message protocol (ICMP) echo packet is sent to the destination IP address based on the current routing-table contents.
gettracelog	Displays the DRAC 5 trace log. See "gettracelog" on page 325 for more information.

Using the Trace Log

The internal DRAC 5 Trace Log is used by administrators to debug DRAC 5 alerting and networking issues.

To access the Trace Log from the DRAC 5 Web-based interface:

- 1 In the System tree, click **Remote Access**.
- 2 Click the **Diagnostics** tab.
- 3 Type the **gettracelog** command, or the **racadm gettracelog** command in the **Command** field.



NOTE: You can use this command from the command line interface also. See "gettracelog" on page 325 for more information.

The Trace Log tracks the following information:

- DHCP — Traces packets sent to and received from a DHCP server.
- IP — Traces IP packets sent and received.

The trace log may also contain DRAC 5 firmware-specific error codes that are related to the internal DRAC 5 firmware, not the managed system's operating system.



NOTE: The DRAC 5 will not echo an ICMP (ping) with a packet size larger than 1500 bytes.

Using the racdump

The `racadm racdump` command provides a single command to get dump, status, and general DRAC 5 board information.



NOTE: This command is available only on Telnet and SSH interfaces. For more inform, see the "racdump" on page 317 command.

Using the coredump

The `racadm coredump` command displays detailed information related to any recent critical issues that have occurred with the RAC. The coredump information can be used to diagnose these critical issues.

If available, the coredump information is persistent across RAC power cycles and will remain available until either of the following conditions occur:

- The coredump information is cleared using the `coredumpdelete` subcommand.
- Another critical condition occurs on the RAC. In this case, the coredump information will be relative to the last critical error that occurred.

The `racadm coredumpdelete` command can be used to clear any currently resident `coredump` data stored in the RAC.

See the "coredump" on page 302 and "coredumpdelete" on page 303 for more information.

Sensors

Hardware sensors or probes help you to monitor the systems on your network in a more efficient way by enabling you to take appropriate actions to prevent disasters, such as system instability or damage.

You can use the DRAC 5 to monitor hardware sensor for batteries, fan probes, chassis intrusion, power supplies, power consumed, temperature, and voltages.

Battery Probes

The Battery probes provide information about the system board CMOS and storage RAM on motherboard (ROMB) batteries.



NOTE: The Storage ROMB battery settings are available only if the system has a ROMB.

Fan Probes

The fan probe sensor provides information on:

- fan redundancy — the ability of the secondary fan to replace the primary fan if the primary fan fails to dissipate heat at a pre-set speed.
- fan probe list — provides information on the fan speed for all fans in the system.

Chassis Intrusion Probes

The chassis intrusion probes provides status of the chassis, whether chassis is open or closed.

Power Supplies Probes

The power supplies probes provides information on:

- status of the power supplies, whether within the normal threshold value or has crossed threshold value.



NOTE: You can set threshold values only from the Dell OpenManage Server Administrator. See the *Dell OpenManage Server Administrator User's Guide* for more information.

- power supply redundancy, that is, the ability of the redundant power supply to replace the primary power supply if the primary power supply fails.



NOTE: If there is only one power supply in the system, the Power Supply Redundancy section will not display.

Hardware Performance Probes

The hardware performance sensor provides status of the performance of your central processing unit (CPU), whether degraded or normal. The status of the hardware performance sensors is degraded when the CPU is in throttled state.

Power Monitoring Probes

Power monitoring provides information about the *real time* consumption of power, in watts and amperes. This information is provided to the DRAC 5 through the baseboard management controller (BMC) firmware sensors.



NOTE: This feature is supported only on limited Dell PowerEdge x9xx and xx0x systems.

DRAC 5 provides advanced power monitoring features. This includes:

- Graphical representation of the system power level in Watts and power supplies in Amperes over a time period.
- Maximum, minimum, and average power consumption statistics for the system in Watts and BTU/Hr (British Thermal Unit per Hour) over the last 1 hour, 1 day, and 1 week from the current DRAC time as a graph.
- Power consumed by the system in Watts and the average current consumed by each power supply in Amperes.

Graph Information

The **Graph Information** page displays the graphs for the system power level in Watts and power supplies in Amperes over a time period. The page auto refreshes every minute.



NOTE: The data is obtained by the DRAC 5 every five minutes and is lost after a DRAC reset, AC power cycle, or a firmware update.



NOTE: The graphs may display gaps either when the system is powered down or when the BMC resets. This is because the power sensors are unavailable during this period.

Power Consumption in Watts displays the time period over which the data for power is collected. You can set the X-axis range to 1 hour, 1 day, or 1 week from the drop-down menu available on this page. The time period is from the current time set on the DRAC. The Y-axis displays the power consumed by the system in Watts.

Power Consumption in Amperes displays the time period over which the data for current is collected. You can set the X-axis range to 1 hour, 1 day, or 1 week from the drop-down menu available on this page. The time period is from the current DRAC time. The Y-axis displays the current consumed by the power supplies in Amperes. If there are more than one power supply units on the system and if the readings are the same, the current graphs may overlap each other.

Power Consumption Information

The **Power Consumption Information** page displays the power consumed by the system in Watts and the average current consumed by each power supply in Amperes.

This page also displays the status of the probes, probe name, power consumed, the minimum and maximum thresholds at which warning and failure alerts are generated, location of the power supply unit, and the average current consumed by each power supply in Amperes.

Power Statistics

The **Power Statistics** page displays the average power consumption and the maximum and the minimum power consumption statistics for the system in Watts and BTU/Hr (British Thermal Unit per Hour) over the last 1 hour, 1 day, or 1 week from the current DRAC time. The data is obtained by the DRAC 5 and is reset if the DRAC undergoes a reset for any reason.

Temperature Probes

The temperature sensor provides information about the system board ambient temperature. The temperature probes indicate whether the status of the probes is within the pre-set warning and critical threshold value.

Voltage Probes

The following are typical voltage probes. Your system may have these and/or others present.

- CPU [n] VCORE
- System Board 0.9V PG
- System Board 1.5V ESB2 PG
- System Board 1.5V PG
- System Board 1.8V PG
- System Board 3.3V PG
- System Board 5V PG
- System Board Backplane PG
- System Board CPU VTT
- System Board Linear PG

The voltage probes indicate whether the status of the probes is within the pre-set warning and critical threshold values.

RACADM Subcommand Overview

This section provides descriptions of the subcommands that are available in the RACADM command line interface.

help



NOTE: To use this command, you must have **Log In DRAC 5** permission.

Table A-1 describes the **help** command.

Table A-1. Help Command

Command	Definition
help	Lists all of the subcommands available to use with racadm and provides a short description for each.

Synopsis

```
racadm help
```

```
racadm help <subcommand>
```

Description

The **help** subcommand lists all of the subcommands that are available when using the **racadm** command along with a one-line description. You may also type a subcommand after **help** to get the syntax for a specific subcommand.

Output

The **racadm help** command displays a complete list of subcommands.

The **racadm help <subcommand>** command displays information for the specified subcommand only.

Supported Interfaces

- Local RACADM
- Remote RACADM
- Telnet/SSH/Serial RACADM

arp

 **NOTE:** To use this command, you must have **Execute Diagnostic Commands** permission.

Table A-2 describes the `arp` command.

Table A-2. arp Command

Command	Definition
<code>arp</code>	Displays the contents of the ARP table. ARP table entries may not be added or deleted.

Synopsis

```
racadm arp
```

Supported Interfaces

- Remote RACADM
- Telnet/SSH/Serial RACADM

clearasrscreen

 **NOTE:** To use this command, you must have **Clear Logs** permission.

Table A-3 describes the `clearasrscreen` subcommand.

Table A-3. clearasrscreen

Subcommand	Definition
<code>clearasrscreen</code>	Clears the last crash screen that is in memory.

Synopsis

```
racadm clearasrscreen
```

Supported Interfaces

- Local RACADM
- Remote RACADM
- Telnet/SSH/Serial RACADM

config



NOTE: To use the **getconfig** command, you must have **Log In DRAC 5** permission.

Table A-4 describes the **config** and **getconfig** subcommands.

Table A-4. config/getconfig

Subcommand	Definition
config	Configures the DRAC 5.
getconfig	Gets the DRAC 5 configuration data.

Synopsis

```
racadm config [-c|-p] -f <filename>
```

```
racadm config -g <groupName> -o <objectName> [-i  
<index>] <Value>
```

Supported Interfaces

- Local RACADM
- Remote RACADM
- Telnet/SSH/Serial RACADM

Description

The **config** subcommand allows the user to set DRAC 5 configuration parameters individually or to batch them as part of a configuration file. If the data is different, that DRAC 5 object is written with the new value.

Input

Table A-5 describes the **config** subcommand options.



NOTE: The **-f** and **-p** options are not supported for the serial/telnet/ssh console.

Table A-5. config Subcommand Options and Descriptions

Option	Description
-f	The -f <i><filename></i> option causes config to read the contents of the file specified by <i><filename></i> and configure the DRAC 5. The file must contain data in the format specified in "Parsing Rules" on page 87.
-p	The -p, or password option, directs config to delete the password entries contained in the config file -f <i><filename></i> after the configuration is complete.
-g	The -g <i><groupName></i> , or group option, must be used with the -o option. The <i><groupName></i> specifies the group containing the object that is to be set.
-o	The -o <i><objectName></i> <i><Value></i> , or object option, must be used with the -g option. This option specifies the object name that is written with the string <i><value></i> .
-i	The -i <i><index></i> , or index option, is only valid for indexed groups and can be used to specify a unique group. The <i><index></i> is a decimal integer from 1 through 16. The index is specified here by the index value, not a "named" value.
-c	The -c, or check option, is used with the config subcommand and allows the user to parse the .cfg file to find syntax errors. If errors are found, the line number and a short description of what is incorrect are displayed. Writes do not occur to the DRAC 5. This option is a check only.

Output

This subcommand generates error output upon encountering either of the following:

- Invalid syntax, group name, object name, index, or other invalid database members
- RACADM CLI failures

This subcommand returns an indication of how many configuration objects that were written out of how many total objects were in the .cfg file.

Examples

- `racadm config -g cfgLanNetworking -o cfgNicIpAddress 10.35.10.100`

Sets the `cfgNicIpAddress` configuration parameter (object) to the value 10.35.10.110. This IP address object is contained in the group `cfgLanNetworking`.

- `racadm config -f myrac.cfg`

Configures or reconfigures the DRAC 5. The `myrac.cfg` file may be created from the `getconfig` command. The `myrac.cfg` file may also be edited manually as long as the parsing rules are followed.



NOTE: The `myrac.cfg` file does not contain password information. To include this information in the file, it must be input manually. If you want to remove password information from the `myrac.cfg` file during configuration, use the `-p` option.

getconfig

getconfig Subcommand Description

The `getconfig` subcommand allows the user to retrieve DRAC 5 configuration parameters on an individual basis, or all the RAC configuration groups may be retrieved and saved into a file.

Input

Table A-6 describes the `getconfig` subcommand options.



NOTE: The `-f` option without a file specification will output the contents of the file to the terminal screen.

Table A-6. getconfig Subcommand Options

Option	Description
-f	The -f <i><filename></i> option directs getconfig to write the entire RAC configuration to a configuration file. This file can be used for batch configuration operations using the config subcommand. NOTE: The -f option does not create entries for the cfglpmiPet and cfglpmiPef groups. You must set at least one trap destination to capture the cfglpmiPet group to the file.
-g	The -g <i><groupName></i> , or group option, can be used to display the configuration for a single group. The groupName is the name for the group used in the racadm.cfg files. If the group is an indexed group, use the -i option.
-h	The -h, or help option, displays a list of all available configuration groups that you can use. This option is useful when you do not remember exact group names.
-i	The -i <i><index></i> , or index option, is valid only for indexed groups and can be used to specify a unique group. The <i><index></i> is a decimal integer from 1 through 16. If -i <i><index></i> is not specified, a value of 1 is assumed for groups, which are tables that have multiple entries. The index is specified by the index value, not a "named" value.
-o	The -o <i><objectname></i> or object option specifies the object name that is used in the query. This option is optional and can be used with the -g option.
-u	The -u <i><username></i> , or user name option, can be used to display the configuration for the specified user. The <i><username></i> option is the login name for the user.
-v	The -v option displays additional details with the display of the properties and is used with the -g option.

Output

This subcommand generates error output upon encountering either of the following:

- Invalid syntax, group name, object name, index, or other invalid database members
- racadm CLI transport failures

If errors are not encountered, this subcommand displays the contents of the specified configuration.

Examples

- `racadm getconfig -g cfgLanNetworking`
Displays all of the configuration properties (objects) that are contained in the group `cfgLanNetworking`.
- `racadm getconfig -f myrac.cfg`
Saves all group configuration objects from the RAC to `myrac.cfg`.
- `racadm getconfig -h`
Displays a list of the available configuration groups on the DRAC 5.
- `racadm getconfig -u root`
Displays the configuration properties for the user named root.
- `racadm getconfig -g cfgUserAdmin -i 2 -v`
Displays the user group instance at index 2 with verbose information for the property values.

Synopsis

```
racadm getconfig -f <filename>
```

```
racadm getconfig -g <groupName> [-i <index>]
```

```
racadm getconfig -u <username>
```

```
racadm getconfig -h
```

Supported Interfaces

- Local RACADM
- Remote RACADM
- Telnet/SSH/Serial RACADM

coredump

 **NOTE:** To use this command, you must have **Execute Debug Commands** permission.

Table A-7 describes the **coredump** subcommand.

Table A-7. coredump

Subcommand	Definition
coredump	Displays the last DRAC 5 core dump.

Synopsis

```
racadm coredump
```

Description

The **coredump** subcommand displays detailed information related to any recent critical issues that have occurred with the RAC. The coredump information can be used to diagnose these critical issues.

If available, the coredump information is persistent across RAC power cycles and will remain available until either of the following conditions occur:

- The coredump information is cleared with the **coredumpdelete** subcommand.
- Another critical condition occurs on the RAC. In this case, the coredump information will be relative to the last critical error that occurred.

See the **coredumpdelete** subcommand for more information about clearing the **coredump**.

Supported Interfaces

- Remote RACADM
- Telnet/SSH/Serial RACADM

coredumpdelete



NOTE: To use this command, you must have **Clear Logs** or **Execute Debug Commands** permission.

Table A-8 describes the `coredumpdelete` subcommand.

Table A-8. coredumpdelete

Subcommand	Definition
<code>coredumpdelete</code>	Deletes the core dump stored in the DRAC 5.

Synopsis

```
racadm coredumpdelete
```

Description

The `coredumpdelete` subcommand can be used to clear any currently resident `coredump` data stored in the RAC.



NOTE: If a `coredumpdelete` command is issued and a `coredump` is not currently stored in the RAC, the command will display a success message. This behavior is expected.

See the `coredump` subcommand for more information on viewing a `coredump`.

Supported Interfaces

- Local RACADM
- Remote RACADM
- Telnet/SSH/Serial RACADM

fwupdate



NOTE: To use this command, you must have **Configure DRAC 5** permission.



NOTE: Before you begin your firmware update, see "Connecting to the Managed System Through the Local Serial Port or Telnet Management Station (Client System)" on page 64 for additional instructions.

Table A-9 describes the `fwupdate` subcommand.

Table A-9. fwupdate

Subcommand	Definition
<code>fwupdate</code>	Updates the firmware on the DRAC 5.

Synopsis

```
racadm fwupdate -s
```

```
racadm fwupdate -g -u -a <TFTP_Server_IP_Address> -d  
<path>
```

```
racadm fwupdate -p -u -d <path>
```

Description

The `fwupdate` subcommand allows users to update the firmware on the DRAC 5. The user can:

- Check the firmware update process status
- Update the DRAC 5 firmware from a TFTP server by providing an IP address and optional path
- Update the DRAC 5 firmware from the local file system using local RACADM

Supported Interfaces

- Local RACADM
- Remote RACADM
- Telnet/SSH/Serial RACADM

Input

Table A-10 describes the `fwupdate` subcommand options.



NOTE: The `-p` option is supported in local and remote RACADM and is not supported with the serial/telnet/ssh console. The `-p` option is not supported on the Linux platform.

Table A-10. fwupdate Subcommand Options

Option	Description
-u	The update option performs a checksum of the firmware update file and starts the actual update process. This option may be used along with the -g or -p options. At the end of the update, the DRAC 5 performs a soft reset.
-s	The status option returns the current status of where you are in the update process. This option is always used by itself.
-g	The get option instructs the firmware to get the firmware update file from the TFTP server. The user must also specify the -a and -d options. In the absence of the -a option, the defaults are read from properties contained in the group cfgRemoteHosts , using properties cfgRhostsFwUpdateIpAddr and cfgRhostsFwUpdatePath .
-a	The IP Address option specifies the IP address of the TFTP server.
-d	The -d , or directory , option specifies the directory on the TFTP server or on the DRAC 5's host server where the firmware update file resides.
-p	The -p , or put , option is used to update the firmware file from the managed system to the DRAC 5. The -u option must be used with the -p option.

Output

Displays a message indicating which operation is being performed.

Examples

- `racadm fwupdate -g -u -a 143.166.154.143 -d <path>`

In this example, the **-g** option tells the firmware to download the firmware update file from a location (specified by the **-d** option) on the TFTP server at a specific IP address (specified by the **-a** option). After the image file is downloaded from the TFTP server, the update process begins. When completed, the DRAC 5 is reset.

If the download exceeds 15 minutes and times out, transfer the firmware flash image to a local drive on the server. Then, using Console Redirection, connect to the remote system and install the firmware locally using local `racadm`.

- `racadm fwupdate -s`

This option reads the current status of the firmware update.

- `racadm fwupdate -p -u -d c:\ <images>`

In this example, the firmware image for the update is provided by the host's file system.

- `racadm -r 192.168.0.120 -u root -p racpassword fwupdate -g -u -a 192.168.0.120 -d <images>`

In this example, RACADM is used to remotely update the firmware of a specified DRAC using the provided DRAC username and password. The image is retrieved from a TFTP server.

 **NOTE:** The `-p` option is supported in local and remote RACADM and is not supported with the serial/telnet/ssh console. The `-p` option is not supported on the Linux platform.

getssninfo

 **NOTE:** To use this command, you must have **Log In To DRAC 5** permission.

Table A-11 describes the `getssninfo` subcommand.

Table A-11. getssninfo Subcommand

Subcommand	Definition
<code>getssninfo</code>	Retrieves session information for one or more currently active or pending sessions from the Session Manager's session table.

Synopsis

```
racadm getssninfo [-A] [-u <username> | *]
```

Description

The `getssninfo` command returns a list of users that are connected to the DRAC. The summary information provides the following information:

- Username
- IP address (if applicable)
- Session type (for example, serial or telnet)
- Consoles in use (for example, Virtual Media or Virtual KVM)

Supported Interfaces

- Local RACADM
- Remote RACADM
- Telnet/SSH/Serial RACADM

Input

Table A-12 describes the `getssninfo` subcommand options.

Table A-12. getssninfo Subcommand Options

Option	Description
-A	The -A option eliminates the printing of data headers.
-u	The -u <username> user name option limits the printed output to only the detail session records for the given user name. If an "*" symbol is given as the user name, all users are listed. Summary information is not printed when this option is specified.

Examples

- `racadm getssninfo`

Table A-13 provides an example of output from the `racadm getssninfo` command.

Table A-13. getssninfo Subcommand Output Example

User	IP Address	Type	Consoles
root	192.168.0.10	Telnet	Virtual KVM

- `racadm getssninfo -A`
"root" 143.166.174.19 "Telnet" "NONE"
- `racadm getssninfo -A -u *`
"root" "143.166.174.19" "Telnet" "NONE"
"bob" "143.166.174.19" "GUI" "NONE"

getsysinfo

 **NOTE:** To use this command, you must have **Log In To DRAC 5** permission.

Table A-14 describes the `racadm getsysinfo` subcommand.

Table A-14. getsysinfo

Command	Definition
<code>getsysinfo</code>	Displays DRAC 5 information, system information, and watchdog status information.

Synopsis

```
racadm getsysinfo [-d] [-s] [-w] [-A]
```

Description

The `getsysinfo` subcommand displays information related to the RAC, managed system, and watchdog configuration.

Supported Interfaces

- Local RACADM
- Remote RACADM
- Telnet/SSH/Serial RACADM

Input

Table A-15 describes the `getsysinfo` subcommand options.

Table A-15. getsysinfo Subcommand Options

Option	Description
<code>-d</code>	Displays DRAC 5 information.
<code>-s</code>	Displays system information
<code>-w</code>	Displays watchdog information
<code>-A</code>	Eliminates the printing of headers/labels.

If the `-w` option is not specified, then the other options are used as defaults.

Output

The `getsysinfo` subcommand displays information related to the RAC, managed system, and watchdog configuration.

Sample Output

RAC Information:

```
RAC Date/Time           = Mon Oct 26 19:05:33 2009
Firmware Version       = 1.50
Firmware Build        = 09.10.21
Last Firmware Update  = Wed Oct 21 21:57:33 2009
Hardware Version      = A00
Current IP Address    = 192.168.1.21
Current IP Gateway    = 0.0.0.0
Current IP Netmask    = 255.255.255.0
DHCP Enabled          = 1
MAC Address           = 00:1c:23:d7:1a:d9
Current DNS Server 1  = 0.0.0.0
Current DNS Server 2  = 0.0.0.0
DNS Servers from DHCP = 0
Register DNS RAC Name = 0
DNS RAC Name          = rac-297GP1S
Current DNS Domain    =
```

System Information:

```
System Model           = PowerEdge 2950
System Revision        = [N/A]
System BIOS Version    = 1.3.7
BMC Firmware Version  = 02.28
Service Tag           = 297GP1S
Express Service Tag    = 4910296528
Host Name              =
```

```
OS Name =
Power Status = ON
Watchdog Information:
Recovery Action = None
Present countdown value = 15 seconds
Initial countdown value = 15 seconds
Embedded NIC MAC Addresses:
NIC1 Ethernet = 00:1A:A0:11:93:68
NIC2 Ethernet = 00:1A:A0:11:93:6A
```

Examples

- `racadm getsysinfo -A -s`
"System Information:" "PowerEdge 2900" "A08" "1.0"
"EF23VQ-0023" "Hostname"

"Microsoft Windows 2000 version 5.0, Build Number
2195, Service Pack 2" "ON"
- `racadm getsysinfo -w -s`

```
System Information:
System Model = PowerEdge 2900
System BIOS Version = 0.2.3
BMC Firmware Version = 0.17
Service Tag = 48192
Express Service Tag = 4910296528
Host Name = racdev103
OS Name = Microsoft Windows Server
2003
Power Status = OFF

Watchdog Information:
Recovery Action = None
Present countdown value = 0 seconds
Initial countdown value = 0 seconds
```

Restrictions

The Hostname and OS Name fields in the **getsysinfo** output display accurate information only if Dell OpenManage is installed on the managed system. If OpenManage is not installed on the managed system, these fields may be blank or inaccurate.

getractive



NOTE: To use this command, you must have **Log In DRAC 5** permission.

Table A-16 describes the **getractive** subcommand.

Table A-16. **getractive**

Subcommand	Definition
<code>getractive</code>	Displays the current time from the remote access controller.

Synopsis

```
racadm getractive [-d]
```

Description

With no options, the **getractive** subcommand displays the time in a common readable format.

With the **-d** option, **getractive** displays the time in the format, *yyyymmddhhmmss.mmmmmms*, which is the same format returned by the UNIX **date** command.

Output

The **getractive** subcommand displays the output on one line.

Sample Output

```
racadm getractive
Thu Dec  8 20:15:26 2005
```

```
racadm getractive -d
20051208201542.000000
```

Supported Interfaces

- Local RACADM
- Remote RACADM
- Telnet/SSH/Serial RACADM

ifconfig



NOTE: To use this command, you must have **Execute Diagnostic Commands** or **Configure DRAC 5** permission.

Table A-17 describes the `ifconfig` subcommand.

Table A-17. ifconfig

Subcommand	Definition
<code>ifconfig</code>	Displays the contents of the network interface table.

Synopsis

```
racadm ifconfig
```

netstat



NOTE: To use this command, you must have **Execute Diagnostic Commands** permission.

Table A-18 describes the `netstat` subcommand.

Table A-18. netstat

Subcommand	Definition
<code>netstat</code>	Displays the routing table and the current connections.

Synopsis

```
racadm netstat
```

Supported Interfaces

- Remote RACADM
- Telnet/SSH/Serial RACADM

ping



NOTE: To use this command, you must have **Execute Diagnostic Commands** or **Configure DRAC 5** permission.

Table A-19 describes the `ping` subcommand.

Table A-19. `ping`

Subcommand	Definition
<code>ping</code>	Verifies that the destination IP address is reachable from the DRAC 5 with the current routing-table contents. A destination IP address is required. An ICMP echo packet is sent to the destination IP address based on the current routing-table contents.

Synopsis

```
racadm ping <ipaddress>
```

Supported Interfaces

- Remote RACADM
- Telnet/SSH/Serial RACADM

setniccfg



 **NOTE:** To use the `setniccfg` command, you must have **Configure DRAC 5** permission.

Table A-20 describes the `setniccfg` subcommand.

Table A-20. setniccfg

Subcommand	Definition
<code>setniccfg</code>	Sets the IP configuration for the controller.

 **NOTE:** The terms NIC and Ethernet management port may be used interchangeably.

Synopsis

```
racadm setniccfg -d
racadm setniccfg -s [<ipAddress> <netmask> <gateway>]
racadm setniccfg -o [<ipAddress> <netmask> <gateway>]
```

Description

The `setniccfg` subcommand sets the controller IP address.

- The `-d` option enables DHCP for the Ethernet management port (default is DHCP enabled).
- The `-s` option enables static IP settings. The IP address, netmask, and gateway can be specified. Otherwise, the existing static settings are used. *<ipAddress>*, *<netmask>*, and *<gateway>* must be typed as dot-separated strings.

```
racadm setniccfg -s 192.168.0.120 255.255.255.0
192.168.0.1
```

- The `-o` option disables the Ethernet management port completely. *<ipAddress>*, *<netmask>*, and *<gateway>* must be typed as dot-separated strings.

```
racadm setniccfg -o 192.168.0.120 255.255.255.0
192.168.0.1
```

Output

The `setniccfg` subcommand displays an appropriate error message if the operation is not successful. If successful, a message is displayed.

Supported Interfaces

- Local RACADM
- Remote RACADM
- Telnet/SSH/Serial RACADM

getniccfg



NOTE: To use the `getniccfg` command, you must have **Log In To DRAC 5** permission.

Table A-21 describes the `setniccfg` and `getniccfg` subcommands.

Table A-21. setniccfg/getniccfg

Subcommand	Definition
<code>getniccfg</code>	Displays the current IP configuration for the controller.

Synopsis

```
racadm getniccfg
```

Description

The `getniccfg` subcommand displays the current Ethernet management port settings.

Sample Output

The `getniccfg` subcommand will display an appropriate error message if the operation is not successful. Otherwise, on success, the output displayed in the following format:

```
NIC Enabled      = 1
DHCP Enabled     = 1
IP Address       = 192.168.0.1
Subnet Mask      = 255.255.255.0
```

Gateway = 192.168.0.1

Supported Interfaces

- Local RACADM
- Remote RACADM
- Telnet/SSH/Serial RACADM

getsvctag

 **NOTE:** To use this command, you must have **Log In To DRAC 5** permission.

Table A-22 describes the `getsvctag` subcommand.

Table A-22. `getsvctag`

Subcommand	Definition
<code>getsvctag</code>	Displays a service tag.

Synopsis

```
racadm getsvctag
```

Description

The `getsvctag` subcommand displays the service tag of the host system.

Example

Type `getsvctag` at the command prompt. The output is displayed as follows:

```
Y76TP0G
```

The command returns 0 on success and nonzero on errors.

Supported Interfaces

- Local RACADM
- Remote RACADM
- Telnet/SSH/Serial RACADM

racdump



NOTE: To use this command, you must have **Debug** permission.

Table A-23 describes the **racdump** subcommand.

Table A-23. racdump

Subcommand	Definition
racdump	Displays status and general DRAC 5 information.

Synopsis

```
racadm racdump
```

Description

The **racdump** subcommand provides a single command to get dump, status, and general DRAC 5 board information.

The following information is displayed when the **racdump** subcommand is processed:

- General system/RAC information
- Coredump
- Session information
- Process information
- Firmware build information

Supported Interfaces

- Remote RACADM
- Telnet/SSH/Serial RACADM

racreset



 **NOTE:** To use this command, you must have **Configure DRAC 5** permission.

Table A-24 describes the **racreset** subcommand.

Table A-24. racreset

Subcommand	Definition
racreset	Resets the DRAC 5.

 **CAUTION:** When you issue a **racreset** subcommand, the DRAC may require up to one minute to return to a usable state.

Synopsis

```
racadm racreset [hard | soft]
```

Description

The **racreset** subcommand issues a reset to the DRAC 5. The reset event is written into the DRAC 5 log.

A hard reset performs a deep reset operation on the RAC. A hard reset should only be performed as a last-case resort to recover the RAC.

 **CAUTION:** You must reboot your system after performing a hard reset of the DRAC 5 as described in Table A-25.

Table A-25 describes the **racreset** subcommand options.

Table A-25. racreset Subcommand Options

Option	Description
hard	A <i>hard</i> reset performs a deep reset operation on the remote access controller. A hard reset should only be used as a last case resort of resetting the RAC controller for recovery purposes.
soft	A <i>soft</i> reset performs a graceful reboot operation on the RAC.

Examples

- `racadm racreset`
Start the DRAC 5 soft reset sequence.
- `racadm racreset hard`
Start the DRAC 5 hard reset sequence.

Supported Interfaces

- Local RACADM
- Remote RACADM
- Telnet/SSH/Serial RACADM

racresetcfg



NOTE: To use this command, you must have **Configure DRAC 5** permission.

Table A-26 describes the `racresetcfg` subcommand.

Table A-26. racresetcfg

Subcommand	Definition
<code>racresetcfg</code>	Resets the entire RAC configuration to factory default values.

Synopsis

```
racadm racresetcfg
```

Supported Interfaces

- Local RACADM
- Remote RACADM
- Telnet/SSH/Serial RACADM

Description

The `racresetcfg` command removes all database property entries that have been configured by the user. The database has default properties for all entries that are used to restore the card back to its original default settings. After resetting the database properties, the DRAC 5 resets automatically.

 **CAUTION:** This command deletes your current RAC configuration and resets the RAC and serial configuration to the original default settings. After reset, the default name and password is `root` and `calvin`, respectively, and the IP address is `192.168.0.120`. If you issue `racresetcfg` from a network client (for example, a supported Web browser, telnet/ssh, or remote RACADM), you must use the default IP address.

 **NOTE:** This subcommand will also reset the serial interface to its default baud rate (57600) and COM port. The serial settings may need to be reconfigured through the BIOS setup screen for the server in order to access the RAC through the serial port.

serveraction

 **NOTE:** To use this command, you must have **Execute Server Control Commands** permission.

Table A-27 describes the `serveraction` subcommand.

Table A-27. serveraction

Subcommand	Definition
<code>serveraction</code>	Executes a managed system reset or power-on/off/cycle.

Synopsis

```
racadm serveraction <action>
```

Description

The `serveraction` subcommand enables users to perform power management operations on the host system. Table A-28 describes the `serveraction` power control options.

Table A-28. serveraction Subcommand Options

String	Definition
<action>	Specifies the action. The options for the <action> string are: <ul style="list-style-type: none">• powerdown — Powers down the managed system.• powerup — Powers up the managed system.• powercycle — Issues a power-cycle operation on the managed system. This action is similar to pressing the power button on the system's front panel to power down and then power up the system.• powerstatus — Displays the current power status of the server ("ON", or "OFF")• hardreset — Performs a reset (reboot) operation on the managed system.

Output

The **serveraction** subcommand displays an error message if the requested operation could not be performed, or a success message if the operation completed successfully.

Supported Interfaces

- Local RACADM
- Remote RACADM
- Telnet/SSH/Serial RACADM

getraclog



NOTE: To use this command, you must have **Log In DRAC 5** permission.

Table A-29 describes the **racadm getraclog** command.

Table A-29. getraclog

Command	Definition
getraclog -i	Displays the number of entries in the DRAC 5 log.
getraclog	Displays the DRAC 5 log entries.

Synopsis

```
racadm getraclog -i
```

```
racadm getraclog [-A] [-o] [-c count] [-s start-record]  
[-m]
```

Description

The `getraclog -i` command displays the number of entries in the DRAC 5 log.

The following options allow the `getraclog` command to read entries:

- `-A` — Displays the output with no headers or labels.
- `-c` — Provides the maximum count of entries to be returned.
- `-m` — Displays one screen of information at a time and prompts the user to continue (similar to the UNIX `more` command).
- `-o` — Displays the output in a single line.
- `-s` — Specifies the starting record used for the display



NOTE: If no options are provided, the entire log is displayed.

Output

The default output display shows the record number, time stamp, source, and description. The timestamp begins at midnight, January 1 and increases until the system boots. After the system boots, the system's timestamp is used.

Sample Output

```
Record:          1  
Date/Time:      Dec  8 08:10:11  
Source:         login[433]  
Description:    root login from 143.166.157.103
```

Supported Interfaces

- Local RACADM
- Remote RACADM
- Telnet/SSH/Serial RACADM

clrraclog



NOTE: To use this command, you must have **Clear Logs** permission.

Synopsis

```
racadm clrraclog
```

Description

The `clrraclog` subcommand removes all existing records from the RAC log. A new single record is created to record the date and time when the log was cleared.

getsel



NOTE: To use this command, you must have **Log In To DRAC 5** permission.

Table A-30 describes the `getsel` command.

Table A-30. `getsel`

Command	Definition
<code>getsel -i</code>	Displays the number of entries in the System Event Log.
<code>getsel</code>	Displays SEL entries.

Synopsis

```
racadm getsel -i
```

```
racadm getsel [-E] [-R] [-A] [-o] [-c count] [-s count]  
[-m]
```

Description

The `getsel -i` command displays the number of entries in the SEL.

The following `getsel` options (without the `-i` option) are used to read entries.

- `-A` — Specifies output with no display headers or labels.
- `-c` — Provides the maximum count of entries to be returned.
- `-o` — Displays the output in a single line.

- s — Specifies the starting record used for the display
- E — Places the 16 bytes of raw SEL at the end of each line of output as a sequence of hex values.
- R — Only the raw data is printed.
- m — Displays one screen at a time and prompts the user to continue (similar to the UNIX **more** command).

 **NOTE:** If no arguments are specified, the entire log is displayed.

Output

The default output display shows the record number, timestamp, severity, and description.

For example:

```
Record:          1
Date/Time:      11/16/2005 22:40:43
Severity:       Ok
Description:    System Board SEL: event log sensor for
System Board, log cleared was asserted
```

Supported Interfaces

- Local RACADM
- Remote RACADM
- Telnet/SSH/Serial RACADM

clrsel

 **NOTE:** To use this command, you must have **Clear Logs** permission.

Synopsis

```
racadm clrsel
```

Description

The **clrsel** command removes all existing records from the system event log (SEL).

Supported Interfaces

- Local RACADM
- Remote RACADM
- Telnet/SSH/Serial RACADM

gettracelog



NOTE: To use this command, you must have **Log In To DRAC 5** permission.

Table A-31 describes the `gettracelog` subcommand.

Table A-31. `gettracelog`

Command	Definition
<code>gettracelog -i</code>	Displays the number of entries in the DRAC 5 trace log.
<code>gettracelog</code>	Displays the DRAC 5 trace log.

Synopsis

```
racadm gettracelog -i
```

```
racadm gettracelog [-A] [-o] [-c count] [-s  
startrecord] [-m]
```

Description

The `gettracelog` (without the `-i` option) command reads entries. The following `gettracelog` entries are used to read entries:

`-i` — Displays the number of entries in the DRAC 5 trace log

`-m` — Displays one screen at a time and prompts the user to continue (similar to the UNIX `more` command).

`-o` — Displays the output in a single line.

`-c` — specifies the number of records to display

`-s` — specifies the starting record to display

`-A` — does not display headers or labels

Output

The default output display shows the record number, timestamp, source, and description. The timestamp begins at midnight, January 1 and increases until the system boots. After the system boots, the system's timestamp is used.

For example:

```
Record:          1
Date/Time:      Dec  8 08:21:30
Source:         ssnmgrd[175]
Description:    root from 143.166.157.103: session timeout
sid 0be0aef4
```

Supported Interfaces

- Local RACADM
- Remote RACADM
- Telnet/SSH/Serial RACADM

sslcsrgen



NOTE: To use this command, you must have **Configure DRAC 5** permission.

Table A-32 describes the `sslcsrgen` subcommand.

Table A-32. sslcsrgen

Subcommand	Description
<code>sslcsrgen</code>	Generates and downloads an SSL certificate signing request (CSR) from the RAC.

Synopsis

```
racadm sslcsrgen [-g] [-f <filename>]
```

```
racadm sslcsrgen -s
```

Description

The `sslsrsgen` subcommand can be used to generate a CSR and download the file to the client's local file system. The CSR can be used for creating a custom SSL certificate that can be used for SSL transactions on the RAC.

Options

 **NOTE:** The `-f` option is not supported for the serial/telnet/ssh console.

Table A-33 describes the `sslsrsgen` subcommand options.

Table A-33. sslsrsgen Subcommand Options

Option	Description
<code>-g</code>	Generates a new CSR.
<code>-s</code>	Returns the status of a CSR generation process (generation in progress, active, or none).
<code>-f</code>	Specifies the filename of the location, <code><filename></code> , where the CSR will be downloaded.

 **NOTE:** If the `-f` option is not specified, the filename defaults to `sslsr` in your current directory.

If no options are specified, a CSR is generated and downloaded to the local file system as `sslsr` by default. The `-g` option cannot be used with the `-s` option, and the `-f` option can only be used with the `-g` option.

The `sslsrsgen -s` subcommand returns one of the following status codes:

- CSR was generated successfully.
- CSR does not exist.
- CSR generation in progress.

Restrictions

The `sslsrsgen` subcommand can only be executed from a local or remote RACADM client and cannot be used in the serial, telnet, or SSH interface.

 **NOTE:** Before a CSR can be generated, the CSR fields must be configured in the RACADM `cfgRacSecurity` group. For example: `racadm config -g cfgRacSecurity -o cfgRacSecCsrCommonName MyCompany`

Examples

```
racadm sslcsrigen -s
```

or

```
racadm sslcsrigen -g -f c:\csr\csrtest.txt
```

Supported Interfaces

- Local RACADM
- Remote RACADM
- Telnet/SSH/Serial RACADM

sslcertupload



NOTE: To use this command, you must have **Configure DRAC 5** permission.

Table A-34 describes the `sslcertupload` subcommand.

Table A-34. sslcertupload

Subcommand	Description
sslcertupload	Uploads a custom SSL server or CA certificate from the client to the RAC.

Synopsis

```
racadm sslcertupload -t <type> [-f <filename>]
```

Options

Table A-35 describes the `sslcertupload` subcommand options.

Table A-35. sslcertupload Subcommand Options

Option	Description
-t	Specifies the type of certificate to upload, either the CA certificate or server certificate. 1 = server certificate 2 = CA certificate
-f	Specifies the file name of the certificate to be uploaded. If the file is not specified, the <code>sslcert</code> file in the current directory is selected.

The `sslcertupload` command returns 0 when successful and returns a nonzero number when unsuccessful.

Restrictions

The `sslcertupload` subcommand can only be executed from a local or remote RACADM client. The `sslsrngen` subcommand cannot be used in the serial, telnet, or SSH interface.

Example

```
racadm sslcertupload -t 1 -f c:\cert\cert.txt
```

Supported Interfaces

- Local RACADM
- Remote RACADM

sslcertdownload



NOTE: To use this command, you must have **Configure DRAC 5** permission.

Table A-36 describes the `sslcertdownload` subcommand.

Table A-36. sslcertdownload

Subcommand	Description
sslcertdownload	Downloads an SSL certificate from the RAC to the client's file system.

Synopsis

```
racadm sslcertdownload -t <type> [-f <filename>]
```

Options

Table A-37 describes the `sslcertdownload` subcommand options.

Table A-37. sslcertdownload Subcommand Options

Option	Description
-t	Specifies the type of certificate to download, either the Microsoft Active Directory certificate or server certificate. 1 = server certificate 2 = Microsoft Active Directory certificate
-f	Specifies the file name of the certificate to be uploaded. If the -f option or the filename is not specified, the <code>sslcert</code> file in the current directory is selected.

The `sslcertdownload` command returns 0 when successful and returns a nonzero number when unsuccessful.

Restrictions

The `sslcertdownload` subcommand can only be executed from a local or remote RACADM client. The `sslsrsgen` subcommand cannot be used in the serial, telnet, or SSH interface.

Example

```
racadm sslcertdownload -t 1 -f c:\cert\cert.txt
```

Supported Interfaces

- Local RACADM
- Remote RACADM

sslcertview



NOTE: To use this command, you must have **Configure DRAC 5** permission.

Table A-38 describes the `sslcertview` subcommand.

Table A-38. sslcertview

Subcommand	Description
<code>sslcertview</code>	Displays the SSL server or CA certificate that exists on the RAC.

Synopsis

```
racadm sslcertview -t <type> [-A]
```

Options

Table A-39 describes the `sslcertview` subcommand options.

Table A-39. sslcertview Subcommand Options

Option	Description
<code>-t</code>	Specifies the type of certificate to view, either the Microsoft Active Directory certificate or server certificate. 1 = server certificate 2 = Microsoft Active Directory certificate
<code>-A</code>	Prevents printing headers/labels.

Output Example

```
racadm sslcertview -t 1
```

```
Serial Number           : 00
```

```
Subject Information:
```

```
Country Code (CC)      : US
```

```
State (S)               : Texas
```

```
Locality (L)           : Round Rock
```

```
Organization (O)       : Dell Inc.
```

```
Organizational Unit (OU) : Remote Access Group
Common Name (CN)       : DRAC5 default certificate
```

Issuer Information:

```
Country Code (CC)      : US
State (S)              : Texas
Locality (L)           : Round Rock
Organization (O)       : Dell Inc.
Organizational Unit (OU) : Remote Access Group
Common Name (CN)       : DRAC5 default certificate
```

```
Valid From             : Jul  8 16:21:56 2005 GMT
Valid To               : Jul  7 16:21:56 2010 GMT
```

```
racadm sslcertview -t 1 -A
```

```
00
US
Texas
Round Rock
Dell Inc.
Remote Access Group
DRAC5 default certificate
US
Texas
Round Rock
Dell Inc.
Remote Access Group
DRAC5 default certificate
Jul  8 16:21:56 2005 GMT
Jul  7 16:21:56 2010 GMT
```

Supported Interfaces

- Local RACADM
- Remote RACADM
- Telnet/SSH/Serial RACADM

sslkeyupload



NOTE: To use this command, you must have **Configure DRAC 5** permission.

Table A-40 describes the `sslkeyupload` subcommand.

Table A-40. sslkeyupload

Subcommand	Description
<code>sslkeyupload</code>	Uploads SSL key from the client to the DRAC 5.

Synopsis

```
racadm sslkeyupload -t <type> [-f <filename>]
```

Options

Table A-41 describes the `sslkeyupload` subcommand options.

Table A-41. sslkeyupload Subcommand Options

Option	Description
<code>-t</code>	Specifies the key to upload. 1 = server certificate
<code>-f</code>	Specifies the file name of the certificate to be uploaded. If the file is not specified, the <code>sslcert</code> file in the current directory is selected.

The `sslkeyupload` command returns 0 when successful and returns a nonzero number when unsuccessful.

Restrictions

The `sslkeyupload` subcommand can only be executed from a local or remote RACADM client. The `sslsrsgen` subcommand cannot be used in the serial, telnet, or SSH interface.

Example

```
racadm sslcertupload -t 1 -f c:\cert\cert.txt
```

Supported Interfaces

- Local RACADM
- Remote RACADM

sslresetcfg



NOTE: To use this command, you must have **Configure DRAC 5** permission.

Table A-42 describes the `sslresetcfg` subcommand.

Table A-42. `sslresetcfg`

Subcommand	Description
<code>sslresetcfg</code>	Restores the web-server certificate to factory default and restarts the web-server. The certificate takes effect 30 seconds after the command is entered.

Synopsis

```
racadm sslresetcfg
```

Example

```
$ racadm sslresetcfg
```

Certificate generated successfully and webserver restarted.

Supported Interfaces

- Local RACADM
- Remote RACADM
- Telnet/SSH/Serial

krbkeytabupload



NOTE: To use this command, you must have **Configure DRAC 5** permission.

Table A-43 describes the `krbkeytabupload` subcommand.

Table A-43. krbkeytabupload

Subcommand	Description
krbkeytabupload	Uploads a Kerberos keytab file.

Synopsis

```
racadm krbkeytabupload [-f <filename>]
```

Options

Table A-44 describes the `krbkeytabupload` subcommand options.

Table A-44. krbkeytabupload Subcommand Options

Option	Description
-f	Specifies the file name of the keytab to be uploaded. If the file is not specified, the keytab file in the current directory is selected.

The `krbkeytabupload` command returns 0 when successful and returns a nonzero number when unsuccessful.

Restrictions

The `krbkeytabupload` subcommand can only be executed from a local or remote RACADM client.

Example

```
racadm krbkeytabupload -f c:\keytab\krbkeytab.tab
```

Supported Interfaces

- Local RACADM
- Remote RACADM

testemail

Table A-45 describes the **testemail** subcommand.

Table A-45. testemail configuration

Subcommand	Description
testemail	Tests the RAC's e-mail alerting feature.

Synopsis

```
racadm testemail -i <index>
```

Description

Sends a test e-mail from the RAC to a specified destination.

Prior to executing the test e-mail command, ensure that the specified index in the RACADM **cfgEmailAlert** group is enabled and configured properly. Table A-46 provides a list and associated commands for the **cfgEmailAlert** group.

Table A-46. testemail Configuration

Action	Command
Enable the alert	<pre>racadm config -g cfgEmailAlert -o cfgEmailAlertEnable -i 1 1</pre>
Set the destination e-mail address	<pre>racadm config -g cfgEmailAlert -o cfgEmailAlertAddress -i 1 user1@mycompany.com</pre>
Set the custom message that is sent to the destination e-mail address	<pre>racadm config -g cfgEmailAlert -o cfgEmailAlertCustomMsg -i 1 "This is a test!"</pre>
Ensure the SNMP IP address is configured properly	<pre>racadm config -g cfgRemoteHosts -o cfgRhostsSmptServerIpAddr -i 192.168.0.152</pre>

Table A-46. testemail Configuration (continued)

Action	Command
View the current e-mail alert settings	<code>racadm getconfig -g cfgEmailAlert -i <index></code> where <index> is a number from 1 to 4

Options

Table A-47 describes the `testemail` subcommand options.

Table A-47. testemail Subcommands

Option	Description
<code>-i</code>	Specifies the index of the e-mail alert to test.

Output

None.

Supported Interfaces

- Local RACADM
- Remote RACADM
- Telnet/SSH/Serial RACADM

testtrap



NOTE: To use this command, you must have **Test Alerts** permission.

Table A-48 describes the `testtrap` subcommand.

Table A-48. testtrap

Subcommand	Description
<code>testtrap</code>	Tests the RAC's SNMP trap alerting feature.

Synopsis

```
racadm testtrap -i <index>
```

Description

The **testtrap** subcommand tests the RAC's SNMP trap alerting feature by sending a test trap from the RAC to a specified destination trap listener on the network.

Before you execute the **testtrap** subcommand, ensure that the specified index in the RACADM **cfgIpmiPet** group is configured properly.

Table A-49 provides a list and associated commands for the **cfgIpmiPet** group.

Table A-49. cfgEmailAlert Commands

Action	Command
Enable the alert	<pre>racadm config -g cfgIpmiPet -o cfgIpmiPetAlertEnable -i 1 1</pre>
Set the destination e-mail IP address	<pre>racadm config -g cfgIpmiPet -o cfgIpmiPetAlertDestIpAddr -i 1 192.168.0.110</pre>
View the current test trap settings	<pre>racadm getconfig -g cfgIpmiPet -i <index></pre> <p>where <index> is a number from 1 to 4</p>

Input

Table A-50 describes the **testtrap** subcommand options.

Table A-50. testtrap Subcommand Options

Option	Description
-i	Specifies the index of the trap configuration to use for the test Valid values are from 1 to 4.

Supported Interfaces

- Local RACADM
- Remote RACADM
- Telnet/SSH/Serial RACADM

vmdisconnect



NOTE: To use this command, you must have **Access Virtual Media** permission.

Table A-51 describes the **vmdisconnect** subcommand.

Table A-51. vmdisconnect

Subcommand	Description
vmdisconnect	Closes all open RAC virtual media connections from remote clients.

Synopsis

```
racadm vmdisconnect
```

Description

The **vmdisconnect** subcommand allows a user to disconnect another user's virtual media session. Once disconnected, the web-based interface will reflect the correct connection status. This is available only through the use of local or remote **racadm**.

The **vmdisconnect** subcommand enables a RAC user to disconnect all active virtual media sessions. The active virtual media sessions can be displayed in the RAC web-based interface or by using the **racadm getsysinfo** subcommand.

Supported Interfaces

- Local RACADM
- Remote RACADM
- Telnet/SSH/Serial RACADM

vmkey

 **NOTE:** To use this command, you must have **Access Virtual Media** permission.

Table A-52 describes the **vmkey** subcommand.

Table A-52. vmkey

Subcommand	Description
vmkey	Performs virtual media key-related operations.

Synopsis

```
racadm vmkey <action>
```

If *<action>* is configured as *reset*, the virtual flash memory is reset to the default size of 16 MB.

Description

When a custom virtual media key image is uploaded to the RAC, the key size becomes the image size. The **vmkey** subcommand can be used to reset the key back to its original default size, which is 16 MB on the DRAC 5.

Supported Interfaces

- Local RACADM
- Remote RACADM
- Telnet/SSH/Serial RACADM

usercontentupload

 **NOTE:** To use this command, you must have **Configure DRAC 5** permission.

Table A-53 describes the **usercontentupload** subcommand.

Table A-53. usercontentupload

Subcommand	Description
usercontentupload	Uploads a user certificate or a user CA certificate from the client to the DRAC.

Synopsis

```
racadm usercertupload -t <type> [-f <filename>] -i <index>
```

Options

Table A-54 describes the `usercertupload` subcommand options.

Table A-54. usercertupload Subcommand Options

Option	Description
-t	Specifies the type of certificate to upload, either the CA certificate or server certificate. 1 = user certificate 2 = user CA certificate
-f	Specifies the file name of the certificate to be uploaded. If the file is not specified, the <code>sslcert</code> file in the current directory is selected.
-i	Index number of the user. Valid values 1-16.

The `usercertupload` command returns 0 when successful and returns a nonzero number when unsuccessful.

Restrictions

The `usercertupload` subcommand can only be executed from a local or a remote RACADM client.

Example

```
racadm usercertupload -t 1 -f c:\cert\cert.txt -i 6
```

Supported Interfaces

- Local RACADM
- Remote RACADM

usercertview



NOTE: To use this command, you must have **Configure DRAC 5** permission.

Table A-55 describes the `usercertview` subcommand.

Table A-55. usercertview

Subcommand	Description
<code>usercertview</code>	Displays the user certificate or user CA certificate that exists on the DRAC.

Synopsis

```
racadm sslcertview -t <type> [-A] -i <index>
```

Options

Table A-56 describes the `sslcertview` subcommand options.

Table A-56. sslcertview Subcommand Options

Option	Description
<code>-t</code>	Specifies the type of certificate to view, either the user certificate or the user CA certificate. 1 = user certificate 2 = user CA certificate
<code>-A</code>	Prevents printing headers/labels.
<code>-i</code>	Index number of the user. Valid values are 1-16.

Supported Interfaces

- Local RACADM
- Remote RACADM
- Telnet/SSH/Serial RACADM

localConRedirDisable



NOTE: Only a local racadm user can execute this command.

Table A-57 describes the localConRedirDisable subcommand.

Table A-57. localConRedirDisable

Subcommand	Description
localConRedirDisable	Disables console redirection to the management station.

Synopsis

```
racadm localConRedirDisable <option>
```

If <option> is set to 1, console redirection is disabled.

Supported Interfaces

- Local RACADM

DRAC 5 Property Database Group and Object Definitions

The DRAC 5 property database contains the configuration information for the DRAC 5. Data is organized by associated object, and objects are organized by object group. The IDs for the groups and objects that the property database supports are listed in this section.

Use the group and object IDs with the `racadm` utility to configure the DRAC 5. The following sections describe each object and indicate whether the object is readable, writable, or both.

All string values are limited to displayable ASCII characters, except where otherwise noted.

Displayable Characters

Displayable characters include the following set:

abcdefghijklmnopqrstuvwxwz

ABCDEFGHIJKLMNPOQRSTUVWXYZ

0123456789~`!@#\$\$%^&*()_+ -= { } [] | \ : " ; ' < > , . ? /

idRacInfo

This group contains display parameters to provide information about the specifics of the DRAC 5 being queried.

One instance of the group is allowed. The following subsections describe the objects in this group.

idRacProductInfo (Read Only)

Legal Values

String of up to 63 ASCII characters.

Default

"Dell Remote Access Controller 5"

Description

Uses a text string to identify the product.

idRacDescriptionInfo (Read Only)**Legal Values**

String of up to 255 ASCII characters.

Default

"This system component provides a complete set of remote management functions for Dell PowerEdge servers."

Description

A text description of the RAC type.

idRacVersionInfo (Read Only)**Legal Values**

String of up to 63 ASCII characters.

Default

"1.0"

Description

A string containing the current product firmware version.

idRacBuildInfo (Read Only)**Legal Values**

String of up to 16 ASCII characters.

Default

The current RAC firmware build version. For example, "05.12.06".

Description

A string containing the current product build version.

idRacName (Read Only)**Legal Values**

String of up to 15 ASCII characters.

Default

DRAC 5

Description

A user assigned name to identify this controller.

idRacType (Read Only)**Default**

6

Description

Identifies the remote access controller type as the DRAC 5.

cfgLanNetworking

This group contains parameters to configure the DRAC 5 NIC.

One instance of the group is allowed. All changes/updates to the objects in this group will require the DRAC 5 NIC to be reset, which may cause a brief loss in connectivity. Objects that change the DRAC 5 NIC IP address settings will close all active user sessions and require users to reconnect using the updated IP address settings.

cfgDNSDomainNameFromDHCP (Read/Write)

 **NOTE:** To modify this property, you must have **Configure DRAC 5** permission.

Legal Values

1 (TRUE)

0 (FALSE)

Default

1

Description

Specifies that the RAC DNS Domain Name should be assigned from the network DHCP server.

cfgDNSDomainName (Read/Write)

 **NOTE:** To modify this property, you must have **Configure DRAC 5** permission.

Legal Values

String of up to 254 ASCII characters. Characters are restricted to alphanumeric, '-' and '.'

 **NOTE:** Microsoft Active Directory only supports Fully Qualified Domain Names (FQDN) of 64 bytes or fewer.

Default

""

Description

The DNS domain name. This parameter is only valid if `cfgDNSDomainNameFromDHCP` is set to 0 (FALSE).

cfgDNSRacName (Read/Write)

 **NOTE:** To modify this property, you must have **Configure DRAC 5** permission.

Legal Values

String of up to 63 ASCII characters.



NOTE: Some DNS servers only register names of 31 characters or fewer.

Default

rac-service tag

Description

Displays the RAC name, which is *rac-service tag* (by default). This parameter is only valid if `cfgDNSRegisterRac` is set to 1 (TRUE).

cfgDNSRegisterRac (Read/Write)



NOTE: To modify this property, you must have **Configure DRAC 5** permission.

Legal Values

1 (TRUE)

0 (FALSE)

Default

0

Description

Registers the DRAC 5 name on the DNS server.

cfgDNSServersFromDHCP (Read/Write)



NOTE: To modify this property, you must have **Configure DRAC 5** permission.

Legal Values

1 (TRUE)

0 (FALSE)

Default

0

Description

Specifies that the DNS server IP addresses should be assigned from the DHCP server on the network.

cfgDNSServer1 (Read/Write)



NOTE: To modify this property, you must have **Configure DRAC 5** permission.

Legal Values

A string representing a valid IP address. For example: "192.168.0.20".

Description

Specifies the IP address for DNS server 1. This property is only valid if `cfgDNSServersFromDHCP` is set to 0 (FALSE).



NOTE: `cfgDNSServer1` and `cfgDNSServer2` may be set to identical values while swapping addresses.

cfgDNSServer2 (Read/Write)



NOTE: To modify this property, you must have **Configure DRAC 5** permission.

Legal Values

A string representing a valid IP address. For example: "192.168.0.20".

Default

0.0.0.0

Description

Retrieves the IP address for DNS server 2. This parameter is only valid if `cfgDNSServersFromDHCP` is set to 0 (FALSE).



NOTE: `cfgDNSServer1` and `cfgDNSServer2` may be set to identical values while swapping addresses.

cfgNicEnable (Read/Write)



NOTE: To modify this property, you must have **Configure DRAC 5** permission.

Legal Values

1 (TRUE)
0 (FALSE)

Default

0

Description

Enables or disables the RAC network interface controller. If the NIC is disabled, the remote network interfaces to the RAC will no longer be accessible, and the RAC will only be available through the serial or local RACADM interfaces.

cfgNicIpAddress (Read/Write)



NOTE: To modify this property, you must have **Configure DRAC 5** permission. This parameter is only configurable if the **cfgNicUseDhcp** parameter is set to 0 (FALSE).

Legal Values

A string representing a valid IP address. For example: "192.168.0.20".

Default

192.168.0.120

Description

Specifies the static IP address to assign to the RAC. This property is only valid if **cfgNicUseDhcp** is set to 0 (FALSE).

cfgNicNetmask (Read/Write)



NOTE: To modify this property, you must have **Configure DRAC 5** permission. This parameter is only configurable if the **cfgNicUseDhcp** parameter is set to 0 (FALSE).

Legal Values

A string representing a valid subnet mask. For example: "255.255.255.0".

Default

255.255.255.0

Description

The subnet mask used for static assignment of the RAC IP address. This property is only valid if `cfgNicUseDhcp` is set to 0 (FALSE).

`cfgNicGateway` (Read/Write)

 **NOTE:** To modify this property, you must have **Configure DRAC 5** permission. This parameter is only configurable if the `cfgNicUseDhcp` parameter is set to 0 (FALSE).

Legal Values

A string representing a valid gateway IP address. For example: "192.168.0.1".

Default

192.168.0.1

Description

The gateway IP address used for static assignment of the RAC IP address. This property is only valid if `cfgNicUseDhcp` is set to 0 (FALSE).

`cfgNicUseDhcp` (Read/Write)

 **NOTE:** To modify this property, you must have **Configure DRAC 5** permission.

Legal Values

1 (TRUE)

0 (FALSE)

Default

0

Description

Specifies whether DHCP is used to assign the RAC IP address. If this property is set to 1 (TRUE), then the RAC IP address, subnet mask, and gateway are assigned from the DHCP server on the network. If this property is set to 0 (FALSE), the static IP address, subnet mask, and gateway is assigned from the `cfgNicIpAddress`, `cfgNicNetmask`, and `cfgNicGateway` properties.

 **NOTE:** If you are updating your system remotely, use the `setniccfg` command.

cfgNicSelection (Read/Write)



NOTE: To modify this property, you must have **Configure DRAC 5** permission.

Legal Values

0 (shared)

1 (shared with failover)

2 (dedicated)

Default

2

Description

Specifies the current mode of operation for the RAC network interface controller (NIC). Table B-1 describes the supported modes.

Table B-1. cfgNicSelection Supported Modes

Mode	Description
Shared	Used if the host server integrated NIC is shared with the RAC on the host server. This mode enables configurations to use the same IP address on the host server and the RAC for common accessibility on the network.
Shared with Failover	Enables teaming capabilities between host server integrated network interface controllers.
Dedicated	Specifies that the RAC NIC is used as the dedicated NIC for remote accessibility.

cfgNicMacAddress (Read Only)

Legal Values

A string representing the RAC NIC MAC address.

Default

The current MAC address of the RAC NIC. For example, "00:12:67:52:51:A3".

Description

The RAC NIC MAC address.

cfgNicVlanEnable (Read/Write)



NOTE: To modify this property, you must have **Configure DRAC 5** permission.

Legal Values

1 (TRUE)

0 (FALSE)

Default

0

Description

Enables or disables the VLAN capabilities of the RAC/BMC.

cfgNicVlanId (Read/Write)



NOTE: To modify this property, you must have **Configure DRAC 5** permission.

Legal Values

0 – 4094

Default

0

Description

Specifies the VLAN ID for the network VLAN configuration. This property is only valid if `cfgNicVlanEnable` is set to 1 (enabled).

cfgNicVlanPriority (Read/Write)



NOTE: To modify this property, you must have **Configure DRAC 5** permission.

Legal Values

0 – 7

Default

0

Description

Specifies the VLAN Priority for the network VLAN configuration. This property is only valid if `cfgNicVlanEnable` is set to 1 (enabled).

cfgRemoteHosts

This group provides properties that allow configuration of various remote components, which include the SMTP server for e-mail alerts and TFTP server IP addresses for firmware updates.

cfgRhostsSmtServerIpAddr (Read/Write)

NOTE: To modify this property, you must have **Configure DRAC 5** permission.

Legal Values

A string representing a valid SMTP server IP address. For example, `192.168.0.55`.

Default

0.0.0.0

Description

The IP address of the network SMTP server. The SMTP server transmits e-mail alerts from the RAC if the alerts are configured and enabled.

cfgRhostsFwUpdateTftpEnable (Read/Write)

NOTE: To modify this property, you must have **Configure DRAC 5** permission.

Legal Values

1 (TRUE)

0 (FALSE)

Default

1

Description

Enables or disables the RAC firmware update from a network TFTP server.

cfgRhostsFwUpdateIpAddr (Read/Write)

NOTE: To modify this property, you must have **Configure DRAC 5** permission.

Legal Values

A string representing a valid TFTP server IP address. For example, 192.168.0.61.

Default

0.0.0.0

Description

Specifies the network TFTP server IP address that is used for TFTP RAC firmware update operations.

cfgRhostsFwUpdatePath (Read/Write)

NOTE: To modify this property, you must have **Configure DRAC 5** permission.

Legal Values

String. Maximum length = 255.

Default

""

Description

Specifies TFTP path where the RAC firmware image file exists on the TFTP server. The TFTP path is relative to the TFTP root path on the TFTP server.



NOTE: The server may still require you to specify the drive (for example, **C**).

cfgUserAdmin

This group provides configuration information about the users who are allowed to access the RAC through the available remote interfaces.

Up to 16 instances of the user group are allowed. Each instance represents the configuration for an individual user.

cfgUserAdminIpmiLanPrivilege (Read/Write)



NOTE: To modify this property, you must have **Configure Users** permission.

Legal Values

2 (User)

3 (Operator)

4 (Administrator)

15 (No access)

Default

4 (User 2)

15 (All others)

Description

The maximum privilege on the IPMI LAN channel.

cfgUserAdminIpmiSerialPrivilege (Read/Write)



NOTE: To modify this property, you must have **Configure Users** permission.

Legal Values

2 (User)

3 (Operator)

4 (Administrator)

15 (No access)

Default

4 (User 2)

15 (All others)

Description

The maximum privilege on the IPMI serial channel.

cfgUserAdminPrivilege (Read/Write)



NOTE: To modify this property, you must have **Configure Users** permission.

Legal Values

0x0000000 to 0x00001ff, and 0x0

Default

0x0000000

Description

This property specifies the allowed role-based authority privileges allowed for the user. The value is represented as a bitmask that allows for any combination of privilege values. Table B-2 describes the allowed user privileges' bit masks.

Table B-2. Bit Masks for User Privileges

User Privilege	Privilege Bit Mask
Log In To DRAC 5	0x0000001
Configure DRAC 5	0x0000002
Configure Users	0x0000004
Clear Logs	0x0000008
Execute Server Control Commands	0x0000010
Access Console Redirection	0x0000020
Access Virtual Media	0x0000040
Test Alerts	0x0000080
Execute Debug Commands	0x0000100

Examples

Table B-3 provides sample privilege bit masks for users with one or more privileges.

Table B-3. Sample Bit Masks for User Privileges

User Privilege(s)	Privilege Bit Mask
The user is not allowed to access the RAC.	0x00000000
The user may only login to RAC and view RAC and server configuration information.	0x00000001
The user may login to RAC and change configuration.	$0x00000001 + 0x00000002 = 0x00000003$
The user may login to RAC, access virtual media, and access console redirection.	$0x00000001 + 0x00000040 + 0x00000080 = 0x000000C1$

cfgUserAdminUserName (Read/Write)



NOTE: To modify this property, you must have **Configure Users** permission.

Legal Values

String. Maximum length = 16.

Default

""

Description

The name of the user for this index. The user index is created by writing a string into this name field if the index is empty. Writing a string of double quotes ("") deletes the user at that index. You cannot change the name. You must delete and then recreate the name. The string must not contain "/" (forward slash, "\" (backslash), "." (period), "@" ("at" symbol) or quotations marks.



NOTE: This property value **MUST** be unique from other user instances.

cfgUserAdminPassword (Write Only)

 **NOTE:** To modify this property, you must have **Configure Users** permission.

Legal Values

A string of up to 20 ASCII characters.

Default

""

Description

The password for this user. The user passwords are encrypted and cannot be seen or displayed after this property is written.

cfgUserAdminEnable

 **NOTE:** To modify this property, you must have **Config Users** permission.

Legal Values

1 (TRUE)

0 (FALSE)

Default

0

Description

Enables or disables an individual user.

cfgUserAdminSolEnable

 **NOTE:** To modify this property, you must have **Config Users** permission.

Legal Values

1 (TRUE)

0 (FALSE)

Default

0

Description

Enables or disables Serial Over LAN (SOL) user access.

cfgEmailAlert

This group contains parameters to configure the RAC e-mail alerting capabilities.

The following subsections describe the objects in this group. Up to four instances of this group are allowed.

cfgEmailAlertIndex (Read Only)

Legal Values

1-4

Default

This parameter is populated based on the existing instances.

Description

The unique index of an alert instance.

cfgEmailAlertEnable (Read/Write)

Legal Values

1 (TRUE)

0 (FALSE)

Default

0

Description

Specifies the destination e-mail address for e-mail alerts. For example, user1@company.com.

cfgEmailAlertAddress (Read Only)**Legal Values**

E-mail address format, with a maximum length of 64 ASCII characters.

Default

""

Description

The e-mail address of the alert source.

cfgEmailAlertCustomMsg (Read Only)**Legal Values**

String. Maximum Length = 32.

Default

""

Description

Specifies a custom message that is sent with the alert.

cfgSessionManagement

This group contains parameters to configure the number of sessions that can connect to the DRAC 5.

One instance of the group is allowed. The following subsections describe the objects in this group.

cfgSsnMgtConsRedirMaxSessions (Read/Write)

NOTE: To modify this property, you must have **Configure DRAC 5** permission.

Legal Values

1 – 2

Default

2

Description

Specifies the maximum number of console redirection sessions allowed on the RAC.

cfgSsnMgtRacadmTimeout (Read/Write)

NOTE: To modify this property, you must have **Configure DRAC 5** permission.

Legal Values

10 –1920

Default

30

Description

Defines the idle time-out in seconds for the Remote RACADM interface. If a remote RACADM session remains inactive for more than the specified time, the session will be closed.

cfgSsnMgtWebserverTimeout (Read/Write)

NOTE: To modify this property, you must have **Configure DRAC 5** permission.

Legal Values

60 – 1920

Default

300

Description

Defines the Web server time-out. This property sets the amount of time in seconds that a connection is allowed to remain idle (there is no user input). The session is cancelled if the time limit set by this property is reached. Changes to this setting do not affect the current session (you must log out and log in again to make the new settings effective).

An expired Web server session logs out the current session.

cfgSsnMgtSshIdleTimeout (Read/Write)



NOTE: To modify this property, you must have **Configure DRAC 5** permission.

Legal Values

0 (No time-out)

60 – 1920

Default

300

Description

Defines the Secure Shell idle time-out. This property sets the amount of time in seconds that a connection is allowed to remain idle (there is no user input). The session is cancelled if the time limit set by this property is reached. Changes to this setting do not affect the current session (you must log out and log in again to make the new settings effective).

An expired Secure Shell session displays the following error message only after you press <Enter>:

```
Warning: Session no longer valid, may have timed out
```

After the message appears, the system returns you to the shell that generated the Secure Shell session.

cfgSsnMgtTelnetTimeout (Read/Write)



NOTE: To modify this property, you must have **Configure DRAC 5** permission.

Legal Values

0 (No timeout)

60 – 1920

Default

0

Description

Defines the Telnet idle time-out. This property sets the amount of time in seconds that a connection is allowed to remain idle (there is no user input). The session is cancelled if the time limit set by this property is reached. Changes to this setting do not affect the current session (you must log out and log in again to make the new settings effective).

An expired Telnet session displays the following error message only after you press <Enter>:

```
Warning: Session no longer valid, may have timed out
```

After the message appears, the system returns you to the shell that generated the Telnet session.

cfgSerial

This group contains configuration parameters for the DRAC 5 serial port.

One instance of the group is allowed. The following subsections describe the objects in this group.

cfgSerialBaudRate (Read/Write)

 **NOTE:** To modify this property, you must have **Configure DRAC 5** permission.

Legal Values

9600, 28800, 57600, 115200

Default

57600

Description

Sets the baud rate on the DRAC 5 serial port.

cfgSerialConsoleEnable (Read/Write)

 **NOTE:** To modify this property, you must have **Configure DRAC 5** permission.

Legal Values

1 (TRUE)

0 (FALSE)

Default

0

Description

Enables or disables the RAC serial console interface.

cfgSerialConsoleQuitKey (Read/Write)

 **NOTE:** To modify this property, you must have **Configure DRAC 5** permission.

Legal Values

STRING

MaxLen = 2

Default

^\ (<Ctrl><\>)



NOTE: The "^\ " is the <Ctrl> key.

Description

This key or key combination terminates text console redirection when using the **connect com2** command. The **cfgSerialConsoleQuitKey** value can be represented by:

- ASCII value — For example: "^\ a"
ASCII values may be represented using the following Escape Key codes:
 - (a) ^ followed by any alphabetic (a-z, A-Z)
 - (b) ^ followed by the listed special characters: [] \ ^ _

cfgSerialConsoleIdleTimeout (Read/Write)

NOTE: To modify this property, you must have **Configure DRAC 5** permission.

Legal Values

0 = No time-out

60 – 1920

Default

300

Description

The maximum number of seconds to wait before an idle serial session is disconnected.

cfgSerialConsoleNoAuth (Read/Write)

 **NOTE:** To modify this property, you must have **Configure DRAC 5** permission.

Legal Values

0 (enables serial login authentication)

1 (disables serial login authentication)

Default

0

Description

Enables or disables the RAC serial console login authentication.

cfgSerialConsoleCommand (Read/Write)

 **NOTE:** To modify this property, you must have **Configure DRAC 5** permission.

Description

Specifies a serial command that is executed after a user logs into the serial console interface.

Default

""

Example

```
"connect com2"
```

cfgSerialHistorySize (Read/Write)

 **NOTE:** To modify this property, you must have **Configure DRAC 5** permission.

Legal Values

0 – 8192

Default

8192

Description

Specifies the maximum size of the serial history buffer.

cfgSerialSshEnable (Read/Write)

NOTE: To modify this property, you must have **Configure DRAC 5** permission.

Legal Values

1 (TRUE)

0 (FALSE)

Default

1

Description

Enables or disables the secure shell (SSH) interface on the DRAC 5.

cfgSerialTelnetEnable (Read/Write)

NOTE: To modify this property, you must have **Configure DRAC 5** permission.

Legal Values

1 (TRUE)

0 (FALSE)

Default

0

Description

Enables or disables the telnet console interface on the RAC.

cfgSerialCom2RedirEnable (Read/Write)

NOTE: To modify this property, you must have **Configure DRAC 5** permission.

Default

1

Legal Values

- 1 (TRUE)
- 0 (FALSE)

Description

Enables or disables the console for COM 2 port redirection.

cfgNetTuning

This group enables users to configure the advanced network interface parameters for the RAC NIC. When configured, the updated settings may take up to a minute to become active.

 **CAUTION: Use extra precaution when modifying properties in this group. Inappropriate modification of the properties in this group can result in your RAC NIC become inoperable.**

cfgNetTuningNicAutoneg (Read/Write)

 **NOTE:** To modify this property, you must have **Configure DRAC 5** permission.

Legal Values

- 1 (Enabled)
- 0 (Disabled)

Default

1

Description

Enables autonegotiation of physical link speed and duplex. If enabled, autonegotiation takes priority over values set in the `cfgNetTuningNic100MB` and `cfgNetTuningNicFullDuplex` objects.

cfgNetTuningNic100MB (Read/Write)



NOTE: To modify this property, you must have **Configure DRAC 5** permission.

Legal Values

0 (10 MBit)

1 (100 MBit)

Default

1

Description

Specifies the speed to use for the RAC NIC. This property is not used if the `cfgNetTuningNicAutoNeg` is set to 1 (enabled).

cfgNetTuningNicFullDuplex (Read/Write)



NOTE: To modify this property, you must have **Configure DRAC 5** permission.

Legal Values

0 (Half Duplex)

1 (Full Duplex)

Default

1

Description

Specifies the duplex setting for the RAC NIC. This property is not used if the `cfgNetTuningNicAutoNeg` is set to 1 (enabled).

cfgNetTuningNicMtu (Read/Write)



NOTE: To modify this property, you must have **Configure DRAC 5** permission.

Legal Values

576 – 1500

Default

1500

Description

The size in bytes of the maximum transmission unit used by the DRAC 5 NIC.

cfgNetTuningTcpSrttDflt (Read/Write)

NOTE: To modify this property, you must have **Configure DRAC 5** permission.

Legal Values

6 – 384

Default

6

Description

The smoothed round trip time-out base default value for TCP retransmission round trip time in $\frac{1}{2}$ second units. (Type hexadecimal values.)

cfgOobSnmpp

The group contains parameters to configure the SNMP agent and trap capabilities of the DRAC 5.

One instance of the group is allowed. The following subsections describe the objects in this group.

cfgOobSnmppAgentCommunity (Read/Write)

NOTE: To modify this property, you must have **Configure DRAC 5** permission.

Legal Values

String. Maximum Length = 31.

Default

public

Description

Specifies the SNMP Community Name used for SNMP Traps.

cfgOobSnmpAgentEnable (Read/Write)

NOTE: To modify this property, you must have **Configure DRAC 5** permission.

Legal Values

1 (TRUE)

0 (FALSE)

Default

0

Description

Enables or disables the SNMP agent in the RAC.

cfgRacTuning

This group is used to configure various RAC configuration properties, such as valid ports and security port restrictions.

cfgRacTunePluginType

NOTE: To modify this property, you must have **Configure DRAC 5** permission.

Legal Values

1 (TRUE) — Java Plug-in

0 (FALSE) — Native Plug-in

Default

0

Description

Configures the virtual KVM (vKVM) plug-in type.

cfgRacTuneHttpPort (Read/Write)

 **NOTE:** To modify this property, you must have **Configure DRAC 5** permission.

Legal Values

10 – 65535

Default

80

Description

Specifies the port number to use for HTTP network communication with the RAC.

cfgRacTuneHttpsPort (Read/Write)

 **NOTE:** To modify this property, you must have **Configure DRAC 5** permission.

Legal Values

10 – 65535

Default

443

Description

Specifies the port number to use for HTTPS network communication with the RAC.

cfgRacTuneIplRangeEnable

 **NOTE:** To modify this property, you must have **Configure DRAC 5** permission.

Legal Values

1 (TRUE)

0 (FALSE)

Default

0

Description

Enables or disables the IP Address Range validation feature of the RAC.

cfgRacTuneIpRangeAddr

NOTE: To modify this property, you must have **Configure DRAC 5** permission.

Legal Values

String, IP address formatted. For example, 192.168.0.44.

Default

192.168.1.1

Description

Specifies the acceptable IP address bit pattern in positions determined by the 1's in the range mask property (**cfgRacTuneIpRangeMask**).

cfgRacTuneIpRangeMask

NOTE: To modify this property, you must have **Configure DRAC 5** permission.

Legal Values

Standard IP mask values with left-justified bits

Default

255.255.255.0

Description

String, IP-address formatted. For example, 255.255.255.0.

cfgRacTuneIpBlkEnable

NOTE: To modify this property, you must have **Configure DRAC 5** permission.

Legal Values

1 (TRUE)
0 (FALSE)

Default

0

Description

Enables or disables the IP address blocking feature of the RAC.

cfgRacTunIpBlkFailcount

NOTE: To modify this property, you must have **Configure DRAC 5** permission.

Legal Values

2 – 16

Default

5

Description

The maximum number of login failure to occur within the window before the login attempts from the IP address are rejected.

cfgRacTunIpBlkFailWindow

NOTE: To modify this property, you must have **Configure DRAC 5** permission.

Legal Values

2 – 65535

Default

60

Description

Defines the timespan in seconds that the failed attempts are counted. When the failure attempts age to this limit, the failures are dropped from the count.

cfgRacTuneIpBlkPenaltyTime



NOTE: To modify this property, you must have **Configure DRAC 5** permission.

Legal Values

2 – 65535

Default

300

Description

Defines the timespan in seconds that session requests from an IP address with excessive failures are rejected.

cfgRacTuneSshPort (Read/Write)



NOTE: To modify this property, you must have **Configure DRAC 5** permission.

Legal Values

1 – 65535

Default

22

Description

Specifies the port number used for the RAC SSH interface.

cfgRacTuneTelnetPort (Read/Write)



NOTE: To modify this property, you must have **Configure DRAC 5** permission.

Legal Values

1 – 65535

Default

23

Description

Specifies the port number used for the RAC telnet interface.

cfgRacTuneRemoteRacadmEnable (Read/Write)

NOTE: To modify this property, you must have **Configure DRAC 5** permission.

Legal Values

1 (TRUE)

0 (FALSE)

Default

1

Description

Enables or disables the Remote RACADM interface in the RAC.

cfgRacTuneConRedirEncryptEnable (Read/Write)

NOTE: To modify this property, you must have **Configure DRAC 5** permission.

Legal Values

1 (TRUE)

0 (FALSE)

Default

0

Description

Encrypts the video in a console redirection session.

cfgRacTuneConRedirPort (Read/Write)

NOTE: To modify this property, you must have **Configure DRAC 5** permission.

Legal Values

1 – 65535

Default

5901

Description

Specifies the port to be used for keyboard and mouse traffic during Console Redirection activity with the RAC.



NOTE: This object requires a DRAC 5 reset before it becomes active.

cfgRacTuneConRedirVideoPort (Read/Write)

NOTE: To modify this property, you must have **Configure DRAC 5** permission.

Legal Values

1 – 65535

Default

5901

Description

Specifies the port to be used for video traffic during Console Redirection activity with the RAC.



NOTE: This object requires a DRAC 5 reset before it becomes active.

cfgRacTuneAsrEnable (Read/Write)

NOTE: To modify this property, you must have **Configure DRAC 5** permission.

Legal Values

0 (FALSE)

1 (TRUE)

Default

1

Description

Enables or disables the crash screen capture feature of the RAC.

 **NOTE:** This object requires a DRAC 5 reset before it becomes active.

cfgRacTuneDaylightOffset (Read/Write)

 **NOTE:** To modify this property, you must have **Configure DRAC 5** permission.

Legal Values

0 – 60

Default

0

Description

Specifies the daylight savings offset (in minutes) to use for the RAC Time.

cfgRacTuneTimezoneOffset (Read/Write)

 **NOTE:** To modify this property, you must have **Configure DRAC 5** permission.

Legal Values

-720 – 780

Default

0

Description

Specifies the timezone offset (in minutes) from GMT/UTC to use for the RAC Time. Some common timezone offsets for timezones in the United States are shown below:

-480 (PST — Pacific Standard Time)

-420 (MST — Mountain Standard Time)

-360 (CST — Central Standard Time)

-300 (EST — Eastern Standard Time)

cfgRacTuneWebserverEnable (Read/Write)

 **NOTE:** To modify this property, you must have **Configure DRAC 5** permission.

Legal Values

0 (FALSE)

1 (TRUE)

Default

1

Description

Enables and disables the RAC Web server. If this property is disabled, the RAC will not be accessible using client Web browsers or remote RACADM. This property has no effect on the telnet/ssh/serial or local RACADM interfaces.

cfgRacTuneLocalServerVideo (Read/Write)



NOTE: To modify this property, you must have **Configure DRAC 5** permission.

Legal Values

1 (Enables)

0 (Disables)

Default

1

Description

Enables (switches ON) or disables (switches OFF) the local server video.

cfgRacTuneLocalConfigDisable



NOTE: To modify this property, you must have **Configure DRAC 5** permission.

Legal Values

1 (TRUE)

0 (FALSE)

Default

0

Description

Enables or disables the ability of a local user to configure the DRAC 5 using local racadm or the Dell OpenManage Server Administrator Utilities.

cfgRacTuneCtrlIEConfigDisable



NOTE: To modify this property, you must have **Configure DRAC 5** permission.

Legal Values

1 (TRUE)

0 (FALSE)

Default

0

Description

Enables or disables the ability to disable the ability of the local user to configure the DRAC 5 from the BIOS POST option-ROM.

cfgRacTuneVirtualConsoleAuthorizeMultipleSessions (Read/Write)



NOTE: To modify this property, you must have **Configure DRAC 5** permission. This object can be used only with remote or firmware (SSH or Telnet) RACADM and not with local RACADM or with earlier DRAC products.

Legal Values

0 (If the user of the first session has not responded for session sharing request by subsequent user, the next session user gets an access denied error after the default timeout value of 30 seconds.)

1 (If the user of the first session has not responded for session sharing request by subsequent user, the next session user gets a read only access after the default timeout value of 30 seconds.)

2 (If the user of the first session has not responded for session sharing request by subsequent user, the next session user gets administrator access after default timeout value of 30 seconds.)

Default

0

Description

If a first user is already using the Virtual Console, the value of this object effects the privileges granted to the subsequent user's shared request after the timeout of 30 seconds.

ifcRacManagedNodeOs

This group contains properties that describe the Managed Server operating system.

One instance of the group is allowed. The following subsections describe the objects in this group.

ifcRacMnOsHostname (Read/Write)

NOTE: To modify this property, you must have **Configure DRAC 5** permission.

Legal Values

String. Maximum Length = 255.

Default

""

Description

The host name of the managed system.

ifcRacMnOsOsName (Read/Write)

NOTE: To modify this property, you must have **Configure DRAC 5** permission.

Legal Values

String. Maximum Length = 255.

Default

""

Description

The operating system name of the managed system.

cfgRacSecurity

This group is used to configure settings related to the RAC SSL certificate signing request (CSR) feature. The properties in this group **MUST** be configured prior to generating a CSR from the RAC.

See the RACADM `sslcsrgen` subcommand details for more information on generating certificate signing requests.

cfgRacSecCsrCommonName (Read/Write)



NOTE: To modify this property, you must have **Configure DRAC 5** permission.

Legal Values

String. Maximum Length = 254.

Default

""

Description

Specifies the CSR Common Name (CN).

cfgRacSecCsrOrganizationName (Read/Write)



NOTE: To modify this property, you must have **Configure DRAC 5** permission.

Legal Values

String. Maximum Length = 254.

Default

""

Description

Specifies the CSR Organization Name (O).

cfgRacSecCsrOrganizationUnit (Read/Write)



NOTE: To modify this property, you must have **Configure DRAC 5** permission.

Legal Values

String. Maximum Length = 254.

Default

""

Description

Specifies the CSR Organization Unit (OU).

cfgRacSecCsrLocalityName (Read/Write)



NOTE: To modify this property, you must have **Configure DRAC 5** permission.

Legal Values

String. Maximum Length = 254.

Default

""

Description

Specifies the CSR Locality (L).

cfgRacSecCsrStateName (Read/Write)



NOTE: To modify this property, you must have **Configure DRAC 5** permission.

Legal Values

String. Maximum Length = 254.

Default

""

Description

Specifies the CSR State Name (S).

cfgRacSecCsrCountryCode (Read/Write)

 **NOTE:** To modify this property, you must have **Configure DRAC 5** permission.

Legal Values

String. Maximum Length = 2.

Default

""

Description

Specifies the CSR Country Code (CC)

cfgRacSecCsrEmailAddr (Read/Write)

 **NOTE:** To modify this property, you must have **Configure DRAC 5** permission.

Legal Values

String. Maximum Length = 254.

Default

""

Description

Specifies the CSR e-mail Address.

cfgRacSecCsrKeySize (Read/Write)

 **NOTE:** To modify this property, you must have **Configure DRAC 5** permission.

Legal Values

1024

2048

4096

Default

1024

Description

Specifies the SSL asymmetric key size for the CSR.

cfgRacVirtual

This group contains parameters to configure the DRAC 5 Virtual Media feature. One instance of the group is allowed. The following subsections describe the objects in this group.

cfgVirMediaAttached (Read/Write)



NOTE: To modify this property, you must have **Configure DRAC 5** permission.

Legal Values

1 (TRUE)

0 (FALSE)

Default

0

Description

This object is used to attach your virtual devices to the system via the USB bus. When the devices are attached the server will recognize valid USB Mass Storage devices attached to the system. This is equivalent to attaching a local USB CDROM/Floppy drive to a USB port on the system. When the devices are attached you then can connect to the virtual devices remotely using DRAC5 web-based interface or the CLI. Setting this object to 0 will cause the devices to detach from the USB bus.



NOTE: You must restart your system to enable all changes.

cfgVirAtapiSvrPort (Read/Write)



NOTE: To modify this property, you must have **Access Virtual Media** permission.

Legal Values

1 – 65535

Default

3669

Description

Specifies the port number used for encrypted virtual media connections to the RAC.

cfgVirAtapiSvrPortSsl (Read/Write)

NOTE: To modify this property, you must have **Configure DRAC 5** permission.

Legal Values

Any unused port number between 0 and 65535 decimal.

Default

3669

Description

Sets the port used for SSL Virtual Media connections.

cfgVirMediaKeyEnable (Read/Write)



NOTE: To modify this property, you must have **Configure DRAC 5** permission.

Legal Values

1 (TRUE)

0 (FALSE)

Default

0

Description

Enables or disables the virtual media key feature of the RAC.

cfgVirMediaPluginTypr (Read/Write)



NOTE: To modify this property, you must have **Configure DRAC 5** permission.

Legal Values

1 (Java Plug-in)

0 (Native Plug-in)

Default

0

Description

Sets the virtual media plug-in type.

cfgVirtualBootOnce (Read/Write)



NOTE: To modify this property, you must have **Configure DRAC 5** permission.

Legal Values

0 — Disable: Disables this option.

1 — Virtual Flash/Virtual Media: Boot from Virtual Flash or any Virtual Media device.

2 — Virtual Floppy: Boot from Virtual floppy device.

- 3 — Virtual CD/DVD/ISO: Boot from Virtual CD/DVD/ISO.
- 4 — PXE: PXE (network) boot the server.
- 5 — Hard drive: Boot into the default hard disk.
- 6 — Utility Partition: Boot into the Utility Partition. A Utility partition should exist.
- 7 — Default CD/DVD: Default CD/DVD drive of the server.
- 8 — BIOS Setup: BIOS Setup screen.
- 9 — Primary Removable Media: Boot from a USB removable media emulated as a bootable floppy.

Default

0

Description

Sets the boot once device. If this property is set to a supported device and the host system is rebooted, the system attempts to boot from the selected device—if the appropriate media is installed in the device.



NOTE: To enable the Boot Once feature for the *Virtual Flash* device, go to the BIOS Setup and manually change the boot order during system reboot.



NOTE: Boot once devices other than *Virtual Flash (1)*, *PXE (4)*, and *Disable (0)* are supported only on some systems with supported BIOS and Baseboard Management Controller (BMC) firmware versions. See the Dell website at www.dell.com to check if your system supports all the boot once devices.



NOTE: On systems not supporting *Virtual Floppy* and *Virtual CD/DVD/ISO*, use '1' (*Virtual Flash/Virtual Media*) to perform the Boot Once either to *Virtual Floppy*, or *Virtual CD/DVD/ISO* or *Virtual Flash*. In this case, set the required virtual device as the first boot device in the BIOS Setup. DRAC 5 automatically disconnects this device once the system reboots to the device, and another reboot is applied to the system.



NOTE: On systems supporting *Virtual Floppy* and *Virtual CD/DVD/ISO* as separate options, DRAC 5 does not automatically disconnect or detach the virtual media connection after Boot Once.

cfgFloppyEmulation (Read/Write)



NOTE: To modify this property, you must have **Configure DRAC 5** permission.

Legal Values

1 (True)

0 (False)

Default

0

Description

When set to 0, the Virtual Floppy drive is recognized as a removable disk by Windows operating systems. Windows operating systems will assign a drive letter that is C: or higher during enumeration. When set to 1, the Virtual Floppy drive will be seen as a floppy drive by Windows operating systems. Windows operating systems will assign a drive letter of A: or B:.

cfgActiveDirectory

This group contains parameters to configure the DRAC 5 Active Directory feature.

cfgADracDomain (Read/Write)

NOTE: To modify this property, you must have **Configure DRAC 5** permission.

Legal Values

Any printable text string with no white space. Length is limited to 254 characters.

Default

""

Description

Active Directory Domain in which the DRAC resides.

cfgADracName (Read/Write)

NOTE: To modify this property, you must have **Configure DRAC 5** permission.

Legal Values

Any printable text string with no white space. Length is limited to 254 characters.

Default

""

Description

Name of DRAC as recorded in the Active Directory forest.

cfgADEnable (Read/Write)



NOTE: To modify this property, you must have **Configure DRAC 5** permission.

Legal Values

1 (TRUE)

0 (FALSE)

Default

0

Description

Enables or disables Active Directory user authentication on the RAC. If this property is disabled, local RAC authentication is used for user logins instead.

cfgADSpecifyServerEnable (Read/Write)



NOTE: To modify this property, you must have **Configure DRAC 5** permission.

Legal Values

1 or 0 (True or False)

Default

0

Description

1 (True) enables you to specify an LDAP or a Global Catalog server. 0 (False) disables this option.

cfgADDomainController (Read/Write)

NOTE: To modify this property, you must have **Configure DRAC 5** permission.

Legal Values

Valid IP address or fully qualified domain name (FQDN)

Default

No default values

Description

DRAC 5 uses the value you specify, to search the LDAP server for user names.

cfgADGlobalCatalog (Read/Write)

NOTE: To modify this property, you must have **Configure DRAC 5** permission.

Legal Values

Valid IP address or FQDN

Default

No default values

Description

DRAC 5 uses the value you specify, to search the Global Catalog server for user names.

cfgAODomain (Read/Write)

NOTE: To modify this property, you must have **Configure DRAC 5** permission.

Legal Values

Valid IP address or FQDN

Format

<domain>: <IP or FQDN>

Default

No default values

Description

DRAC 5 uses the value you specify, to search the Association Object for user names.

cfgADSmartCardLogonEnable (Read/Write)

NOTE: To modify this property, you must have **Configure DRAC 5** permission.

Legal Values

1 (TRUE)

0 (FALSE)

Default

0

Description

Enables or disables the Smart Card logon on DRAC 5.

cfgADCRLEnable (Read/Write)

NOTE: To modify this property, you must have **Configure DRAC 5** permission.

Legal Values

1 (TRUE)

0 (FALSE)

Default

0

Description

Enables or disables the Certificate Revocation List (CRL) check for Active Directory-based Smart Card users.

cfgADAuthTimeout (Read/Write)



NOTE: To modify this property, you must have **Configure DRAC 5** permission.

Legal Values

15 – 300

Default

120

Description

Specifies the number of seconds to wait for Active Directory authentication requests to complete before timing out.

cfgADRootDomain (Read/Write)



NOTE: To modify this property, you must have **Configure DRAC 5** permission.

Legal Values

Any printable text string with no white space. Length is limited to 254 characters.

Default

""

Description

Root domain of the Domain Forest.

cfgADType (Read/Write)



NOTE: To modify this property, you must have **Configure DRAC 5** permission.

Legal Values

1 = Enables Extended Schema with Active Directory.

2 = Enables Standard Schema with Active Directory.

Default

1 = Extended Schema

Description

Determines the schema type to use with Active Directory.

cfgADSSOEnable (Read/Write)



NOTE: To modify this property, you must have **Configure DRAC 5** permission.

Legal Values

1 (TRUE)

0 (FALSE)

Default

0

Description

Enables or disables Active Directory single sign-on authentication on the RAC.

cfgStandardSchema

This group contains parameters to configure the Standard Schema settings.

cfgSSADRoleGroupIndex (Read Only)

Legal Values

Integer from 1 to 5.

Description

Index of the Role Group as recorded in the Active Directory.

cfgSSADRoleGroupName (Read/Write)



NOTE: To modify this property, you must have **Configure DRAC 5** permission.

Legal Values

Any printable text string with no white space. Length is limited to 254 characters.

Default

(blank)

Description

Name of the Role Group as recorded in the Active Directory forest.

cfgSSADRoleGroupDomain (Read/Write)

NOTE: To modify this property, you must have **Configure DRAC 5** permission.

Legal Values

Any printable text string with no white space. Length is limited to 254 characters.

Default

(blank)

Description

Active Directory Domain in which the Role Group resides.

cfgSSADRoleGroupPrivilege (Read/Write)

NOTE: To modify this property, you must have **Configure DRAC 5** permission.

Legal Values

0x00000000 to 0x000001ff

Default

(blank)

Description

Use the bit mask numbers in Table B-4 to set role-based authority privileges for a Role Group.

Table B-4. Bit Masks for Role Group Privileges

Role Group Privilege	Bit Mask
Log In To DRAC 5	0x00000001
Configure DRAC 5	0x00000002
Configure Users	0x00000004
Clear Logs	0x00000008
Execute Server Control Commands	0x00000010
Access Console Redirection	0x00000020
Access Virtual Media	0x00000040
Test Alerts	0x00000080
Execute Debug Commands	0x00000100

cfgIpmiSerial

This group specifies properties used to configure the IPMI serial interface of the BMC.

cfgIpmiSerialConnectionMode (Read/Write)



NOTE: To modify this property, you must have **Configure DRAC 5** permission.

Legal Values

0 (Terminal)

1 (Basic)

Default

1

Description

When the DRAC 5 **cfgSerialConsoleEnable** property is set to 0 (disabled), the DRAC 5 serial port becomes the IPMI serial port. This property determines the IPMI defined mode of the serial port.

In Basic mode, the port uses binary data with the intent of communicating with an application program on the serial client. In Terminal mode, the port assumes that a dumb ASCII terminal is connected and allows very simple commands to be entered.

cfgIpmiSerialBaudRate (Read/Write)



NOTE: To modify this property, you must have **Configure DRAC 5** permission.

Legal Values

9600, 19200, 57600, 115200

Default

57600

Description

Specifies the baud rate for a serial connection over IPMI.

cfgIpmiSerialChanPrivLimit (Read/Write)



NOTE: To modify this property, you must have **Configure DRAC 5** permission.

Legal Values

2 (User)

3 (Operator)

4 (Administrator)

Default

4

Description

Specifies the maximum privilege level allowed on the IPMI serial channel.

cfgIpmiSerialFlowControl (Read/Write)



NOTE: To modify this property, you must have **Configure DRAC 5** permission.

Legal Values

- 0 (None)
- 1 (CTS/RTS)
- 2 (XON/XOFF)

Default

1

Description

Specifies the flow control setting for the IPMI serial port.

cfgIpmiSerialHandshakeControl (Read/Write)

NOTE: To modify this property, you must have **Configure DRAC 5** permission.

Legal Values

- 0 (FALSE)
- 1 (TRUE)

Default

1

Description

Enables or disables the IPMI terminal mode handshake control.

cfgIpmiSerialLineEdit (Read/Write)

NOTE: To modify this property, you must have **Configure DRAC 5** permission.

Legal Values

- 0 (FALSE)
- 1 (TRUE)

Default

1

Description

Enables or disables line editing on the IPMI serial interface.

cfgIpmiSerialEchoControl (Read/Write)

NOTE: To modify this property, you must have **Configure DRAC 5** permission.

Legal Values

0 (FALSE)

1 (TRUE)

Default

1

Description

Enables or disables echo control on the IPMI serial interface.

cfgIpmiSerialDeleteControl (Read/Write)

NOTE: To modify this property, you must have **Configure DRAC 5** permission.

Legal Values

0 (FALSE)

1 (TRUE)

Default

0

Description

Enables or disables delete control on the IPMI serial interface.

cfgIpmiSerialNewLineSequence (Read/Write)

NOTE: To modify this property, you must have **Configure DRAC 5** permission.

Legal Values

0 (None)

- 1 (CR-LF)
- 2 (NULL)
- 3 (<CR>)
- 4 (<LF-CR>)
- 5 (<LF>)

Default

1

Description

Specifies the newline sequence specification for the IPMI serial interface.

cfgIpmiSerialInputNewLineSequence (Read/Write)



NOTE: To modify this property, you must have **Configure DRAC 5** permission.

Legal Values

- 0 (<ENTER>)
- 1 (NULL)

Default

1

Description

Specifies the input newline sequence specification for the IPMI serial interface.

cfgIpmiSol

This group is used to configure the Serial-Over-LAN capabilities of the system.

cfgIpmiSolEnable (Read/Write)



NOTE: To modify this property, you must have **Configure DRAC 5** permission.

Legal Values

- 0 (FALSE)

1 (TRUE)

Default

1

Description

Enables or disables Serial Over LAN (SOL).

cfgIpmiSolBaudRate (Read/Write)



NOTE: To modify this property, you must have **Configure DRAC 5** permission.

Legal Values

9600, 19200, 57600, 115200

Default

57600

Description

The baud rate for serial communication over LAN.

cfgIpmiSolMinPrivilege (Read/Write)



NOTE: To modify this property, you must have **Configure DRAC 5** permission.

Legal Values

2 (User)

3 (Operator)

4 (Administrator)

Default

4

Description

Specifies the minimum privilege level required for serial over LAN access.

cfgIpmiSolAccumulateInterval (Read/Write)

 **NOTE:** To modify this property, you must have **Configure DRAC 5** permission.

Legal Values

1 – 255.

Default

10

Description

Specifies the typical amount of time that the BMC waits before transmitting a partial SOL character data packet. This value is 1-based 5ms increments.

cfgIpmiSolSendThreshold (Read/Write)

 **NOTE:** To modify this property, you must have **Configure DRAC 5** permission.

Legal Values

1 – 255

Default

255

Description

The SOL threshold limit value.

cfgIpmiLan

This group is used to configure the IPMI-Over-LAN capabilities of the system.

cfgIpmiLanEnable (Read/Write)

 **NOTE:** To modify this property, you must have **Configure DRAC 5** permission.

Legal Values

0 (FALSE)

1 (TRUE)

Default

1

Description

Enables or disables the IPMI-Over-LAN interface.

cfgIpmiLanPrivLimit (Read/Write)

NOTE: To modify this property, you must have **Configure DRAC 5** permission.

Legal Values

2 (User)

3 (Operator)

4 (Administrator)

Default

0

Description

Specifies the maximum privilege level allowed for IPMI over LAN access.

cfgIpmiLanAlertEnable (Read/Write)

NOTE: To modify this property, you must have **Configure DRAC 5** permission.

Legal Values

0 (FALSE)

1 (TRUE)

Default

1

Description

Enables or disables global e-mail alerting. This property overrides all individual e-mail alerting enable/disable properties.

cfgIpmiEncryptionKey (Read/Write)



NOTE: To view or modify this property, you must have **Configure DRAC 5** permission and administrator privileges.

Legal Values

A string of hexadecimal digits from 0 to 20 characters with no spaces.

Default

"00000000000000000000"

Description

The IPMI encryption key.

cfgIpmiPetCommunityName (Read/Write)



NOTE: To modify this property, you must have **Configure DRAC 5** permission.

Legal Values

A string up to 18 characters.

Default

"public"

Description

The SNMP community name for traps.

cfgIpmiPef

This group is used to configure the platform event filters available on the managed server.

The event filters can be used to control policy related to actions that are triggered when critical events occur on the managed system.

cfglpmiPefName (Read Only)

Legal Values

String. Maximum Length = 255.

Default

The name of the index filter.

Description

Specifies the name of the platform event filter.

cfglpmiPefIndex (Read Only)

Legal Values

1 – 17

Default

The index value of a platform event filter object.

Description

Specifies the index of a specific platform event filter.

cfglpmiPefAction (Read/Write)



NOTE: To modify this property, you must have **Configure DRAC 5** permission.

Legal Values

0 (None)

1 (Power Down)

2 (Reset)

3 (Power Cycle)

Default

0

Description

Specifies the action that is performed on the managed system when the alert is triggered.

cfgIpmiPefEnable (Read/Write)



NOTE: To modify this property, you must have **Configure DRAC 5** permission.

Legal Values

0 (FALSE)

1 (TRUE)

Default

1

Description

Enables or disables a specific platform event filter.

cfgIpmiPet

This group is used to configure platform event traps on the managed system.

cfgIpmiPetIndex (Read/Write)



NOTE: To modify this property, you must have **Configure DRAC 5** permission.

Legal Values

1 – 4

Default

The appropriate index value.

Description

Unique identifier for the index corresponding to the trap.

cfgIpmiPetAlertDestIpAddr (Read/Write)



NOTE: To modify this property, you must have **Configure DRAC 5** permission.

Legal Values

String representing a valid IP address. For example, 192.168.0.67.

Default

0.0.0.0

Description

Specifies the destination IP address for the trap receiver on the network. The trap receiver receives an SNMP trap when an event is triggered on the managed system.

cfgIpmiPetAlertEnable (Read/Write)

NOTE: To modify this property, you must have **Configure DRAC 5** permission.

Legal Values

0 (FALSE)

1 (TRUE)

Default

1

Description

Enables or disables a specific trap.

cfgLogging

This group is used to enable or disable the OEM event log filtering.

cfgLoggingSELOEMEventFilterEnable (Read/Write)**Legal Values**

0 (SEL Log filtering is Disabled)

1 (SEL Log filtering is Enabled)

Default

0

Description

Enables or disables the SEL Log filtering.

Supported RACADM Interfaces

The following table provides an overview of RACADM subcommands and their corresponding interface support.

Table C-1. RACADM Subcommand Interface Support

Subcommand	Telnet/SSH/Serial	Local RACADM	Remote RACADM
arp	✓	✗	✓
clearasrscreen	✓	✓	✓
clrraclog	✓	✓	✓
clrsel	✓	✓	✓
coredump	✓	✗	✓
coredumpdelete	✓	✓	✓
fwupdate	✓	✓	✓
getconfig	✓	✓	✓
getniccfg	✓	✓	✓
getraclog	✓	✓	✓
getractime	✓	✓	✓
getsel	✓	✓	✓
getssninfo	✓	✓	✓
getsvctag	✓	✓	✓
getsysinfo	✓	✓	✓
gettracelog	✓	✓	✓
help	✓	✓	✓

Table C-1. RACADM Subcommand Interface Support (continued)

Subcommand	Telnet/SSH/Serial	Local RACADM	Remote RACADM
ifconfig	✓	✗	✓
netstat	✓	✗	✓
ping	✓	✗	✓
racdump	✓	✗	✓
racreset	✓	✓	✓
racresetcfg	✓	✓	✓
serveraction	✓	✓	✓
setniccfg	✓	✓	✓
sslcertdownload	✗	✓	✓
sslcertupload	✗	✓	✓
sslcertview	✓	✓	✓
sslcsrgen	✓	✓	✓
sslkeyupload	✗	✓	✓
sslresetcfg	✓	✓	✓
testemail	✓	✓	✓
testtrap	✓	✓	✓
vmdisconnect	✓	✓	✓
vmkey	✓	✓	✓
usercontentupload	✗	✓	✓
usercontentview	✓	✓	✓
localConRedirDisable	✗	✓	✗

✓ = Supported; ✗ = Not supported

Index

A

- Active Directory
 - adding DRAC 5 users, 124
 - configuring access to the DRAC 5, 117
 - extending schemas, 117
 - logging in to the DRAC 5, 142
 - objects, 113
 - schema extensions, 112
 - using with extended schema, 112
 - using with standard schema, 106
 - using with the DRAC 5, 105

B

- BIOS setup
 - configuring on a managed system, 51
- Boot Once, 389
- bootable image file
 - creating, 203

C

- Certificate Signing Request (CSR)
 - about, 216
 - generating a new certificate, 218
- certificates

- exporting the root CA certificate, 138
- SSL and digital, 215
- uploading a server certificate, 219
- viewing a server certificate, 220

- configuration file
 - creating, 85

- configuring
 - serial mode, 275
 - serial over LAN, 275
 - terminal mode, 275

- connect com2
 - using, 50

- console redirection
 - configuring, 163
 - opening a session, 164
 - using, 161

D

- DRAC 5
 - accessing through a network, 73
 - adding and configuring users, 95
 - configuring, 38, 109, 126
 - configuring network settings, 72
 - configuring properties, 47
 - configuring the NIC, 75
 - creating a configuration file, 85
 - downloading firmware, 41
 - enabling security options, 225

- enabling serial/telnet/ssh console, 57
- securing communications, 215
- updating the firmware, 40

E

- e-mail alerts
 - configuring, 263
 - configuring using RACADM CLI, 264
 - configuring using the web user interface, 263
- enabling
 - single sign-on, 151
- example
 - see* sample
- extended schema
 - using with Active Directory, 112

F

- features
 - DRAC 5, 29
 - DRAC 5 hardware, 26
- firmware
 - downloading, 41
 - updating, 40
- frequently asked questions
 - managing and recovering a remote system, 92
 - using console redirection, 173

- using the DRAC 5 with Active Directory, 144
- using Virtual Media, 205

H

- hardware
 - installing, 35
- hardware specifications, 26
 - connectors, 26
 - DRAC 5 ports, 27
 - power requirements, 26

I

- IP blocking
 - about, 228
 - enabling, 229
- IPMI
 - configuring, 61, 267
 - configuring using the RACADM CLI, 270
 - configuring using the Web-based interface, 267
- IpRange
 - about, 225
 - enabling, 226

K

- kerberos authentication, 147
 - prerequisites, 147

L

last crash screen
capturing on the managed system, 257

Linux XTerm

configuring for telnet console redirection, 68

logs

operating system boot, 283
POST, 283

M

managed system

accessing through the local serial port, 64
capturing the last crash screen, 257
configuring BIOS setup, 51
enabling serial or telnet console, 50
installing software, 38

management station

configuring, 162
configuring a Red Hat Enterprise Linux management station, 39
configuring terminal emulation, 65
installing and removing RACADM, 40
installing the software, 39

mouse pointer

synchronizing, 172

N

network properties

configuring manually, 90
configuring using racadm, 90

O

operating system boot, 283

Operating System Boot Capture

Logs, 283

other documents you may need, 30

P

parsing rules, 87

PEF

configuring, 259
configuring using RACACM CLI, 260
configuring using the web user interface, 259

PET

configuring, 261
configuring using RACADM CLI, 262
configuring using the web user interface, 261

platform events

configuring, 258

prerequisites

setting up kerberos authentication, 147

- setting up single sign-on, 151
- property database groups
 - cfgRacManagedNodesOs, 383
 - cfgActiveDirectory, 391
 - cfgEmailAlert, 361
 - cfgIpmiLan, 404
 - cfgIpmiPef, 406
 - cfgIpmiPet, 408
 - cfgIpmiSerial, 398
 - cfgIpmiSol, 402
 - cfgLanNetworking, 347
 - cfgNetTuning, 370
 - cfgOobSnmp, 372
 - cfgRacSecurity, 384
 - cfgRacTuning, 373
 - cfgRacVirtual, 387
 - cfgRemoteHosts, 355
 - cfgSerial, 365
 - cfgSessionManagement, 362
 - cfgUserAdmin, 357
 - idRacInfo, 345

R

- RAC serial
 - configuring, 61
- RAC serial interface
 - about, 51
- RACADM
 - attaching virtual media, 191
 - configuring serial and telnet, 58
 - installing and removing, 40
 - supported interfaces, 411
- RACADM CLI

- configuring e-mail alerts, 264
- configuring PEF, 260
- configuring PET, 262
- RACADM subcommands
 - arp, 296
 - cleararscreen, 296
 - clrraclog, 323
 - clrsel, 324
 - config, 297
 - coredump, 302
 - coredumpdelete, 303
 - fwupdate, 303
 - getconfig, 299
 - getniccfg, 315
 - getraclog, 321
 - getractime, 311
 - getsel, 323
 - getssninfo, 306
 - getsvctag, 316
 - getsysinfo, 308
 - gettracelog, 325
 - help, 295
 - ifconfig, 312
 - localConRedirDisable, 343
 - netstat, 312
 - ping, 313
 - racdump, 317
 - racreset, 318
 - racresetcfg, 319
 - serveraction, 320
 - setniccfg, 314
 - sslcertupload, 328, 333
 - sslcertview, 331
 - sslcsrgen, 326
 - testemail, 336

- testtrap, 337
- usercertupload, 340
- userertview, 342
- vmdisconnect, 339
- vmkey, 340

racadm utility

- configuring network properties, 90
- parsing rules, 87
- subcommands, 295

reboot option

- disabling, 258

Red Hat Enterprise Linux

- configuring for serial console redirection, 52

remote access connections

- supported, 28

S

Secure Shell (SSH)

- using, 71, 220

Secure Sockets Layer (SSL)

- about, 215
- importing the firmware certificate, 140

security

- enabling, 225
- using SSL and digital certificates, 215

serial console

- connecting the DB-9 cable, 65
- using, 70

serial mode

- configuring, 61

Serial Over LAN (SOL)

- configuring, 275

server certificate

- uploading, 219
- viewing, 220

Server Management Command Line Protocol (SM-CLP)

- about, 233
- support, 233

services

- configuring, 221

Single Sign-On, 143

single sign-on

- configuring the DRAC 5, 151
- logging into the DRAC 5, 152
- prerequisites, 151

snap-in

- installing the Dell extension, 123

software

- configuring, 37
- installing, 37

Specify Server, 131

sslcrtdownload, 329

standard schema

- using with Active Directory, 106

system

- configuring to use a DRAC 5, 36

T

telnet console

using, 70

terminal mode

configuring, 61, 63

U

usercertupload, 340

V

video viewer

accessing the viewer menu

bar, 168

using, 167

virtual flash

configuring, 195

disabling, 194

enabling, 194

using, 194

virtual media

about, 183

attaching, 190

booting, 192

detaching, 190

installing the operating
system, 193

installing the plug-in, 185

running, 186

supported configurations, 186

VM-CLI

about, 196

deploying the operating
system, 204

operating system shell

options, 201

parameters, 198

using, 196

W

web browser

configuring, 43

web user interface

accessing, 48

configuring e-mail alerts, 263

configuring PEF, 259

configuring PET, 261