

Dell™ Latitude™ XT User's Guide

Model PP12S

Notes, Notices, and Cautions



NOTE: A NOTE indicates important information that helps you make better use of your Tablet-PC.



NOTICE: A NOTICE indicates either potential damage to hardware or loss of data and tells you how to avoid the problem.



CAUTION: A CAUTION indicates a potential for property damage, personal injury, or death.

Information in this document is subject to change without notice.

© 2007–2008 Dell Inc. All rights reserved.

Reproduction in any manner whatsoever without the written permission of Dell Inc. is strictly forbidden.

Trademarks used in this text: *Dell*, the *DELL* logo, *Latitude*, *Travellite*, *Wi-Fi Catcher*, and *ExpressCharge*, are trademarks of Dell Inc.; *Intel*, *Pentium*, and *Celeron* are registered trademarks of Intel Corporation; *Bluetooth* is a registered trademark owned by Bluetooth SIG, Inc. and is used by Dell under license; *TouchStrip* is a trademark of Zvetco Biometrics, LLC; *Blu-ray Disc* is a trademark of the Blu-ray Disc Association; *Microsoft*, *Windows*, *Windows Server*, *MS-DOS*, *Aero*, *Windows Vista*, and the *Windows Vista* start button are either trademarks or registered trademarks of Microsoft Corporation in the United States and/or other countries.

Other trademarks and trade names may be used in this document to refer to either the entities claiming the marks and names or their products. Dell Inc. disclaims any proprietary interest in trademarks and trade names other than its own.

Model PP12S

May 2008

P/N PU189

Rev. A03

Contents

1	Resources	13
	Finding Information	13
	Getting Help	21
	Obtaining Assistance	21
	Dell Support Service	21
	Problems With Your Order	23
	Product Information	23
	Returning Items for Warranty Repair or Credit	24
	Before You Call	24
	Contacting Dell	26
2	About Your Tablet-PC	27
	Front View	27
	Left Side View	32
	Right Side View	34
	Back View	36
	Top View	39
	Bottom View	40
	Pen View	41
	Specifications	42

3 Setting Up and Using Your Tablet-PC . . . 51

Transferring Information to a New Tablet-PC	51
Transferring Information in Windows Vista®	51
Transferring Information in Windows XP	51
Using Notebook Mode	54
Using Tablet Mode	55
Converting Your Tablet-PC Between Notebook and Tablet Modes	55
Right- and Left-handed Use	59
Screen Orientation	61
Controlling Your Tablet-PC in Tablet Mode	62
Using the Pen	65
Using Touch	70
Accessing Management Tasks and User Information	71
QuickSet	71
Control Panel	72
Help and Support	72
Windows Vista Mobility Center	72
Using a Battery	73
Battery Performance	73
Checking the Battery Charge	74
Power Meter	75
Conserving Battery Power	76
Power Management Modes	77
Configuring Power Management Settings	79
Charging the Main Battery	79
Removing the Main Battery	80
Installing the Main Battery	81
Storing a Battery	81
Using a Keyboard	82

	Numeric Keypad	82
	Key Combinations	82
	Touch Pad	85
	Changing the Track Stick or Pointer Cap	86
	Using the Display	87
	Adjusting Brightness on the LED Backlit Thin-and-Light LCD	88
	Adjusting Brightness on the Dual-bulb (CCFL) LCD	88
	Using Cards	89
	ExpressCards	89
	Smart Cards	91
	Secure Digital (SD) Cards	93
4	Using Your Tablet-PC With a Projector	95
	Display Positions	95
	Classic Notebook	95
	Tablet	95
	Display Modes	96
	Clone Mode (Mirrored)	96
	Extended Desktop Mode	97
	Changing the Display Settings for the Projector	97
5	Setting Up and Using Networks	99
	Connecting a Network or Broadband Modem	99
	Network Setup Wizard	100
	Wireless Local Area Network (WLAN)	100

What You Need to Establish a WLAN Connection	101
Checking Your Wireless Network Adapter	101
Setting Up a New WLAN Using a Wireless Router and a Broadband Modem	102
Connecting to a WLAN	103
Mobile Broadband/Wireless	
Wide Area Network (WWAN)	105
What You Need to Establish a Mobile Broadband Network Connection	105
Checking Your Dell Mobile Broadband Card	106
Connecting to a Mobile Broadband Network	107
Enabling/Disabling the Dell Mobile Broadband Card	108
Managing Your Network Settings Through the Dell QuickSet Location Profiler	108
Dell Wi-Fi Catcher™ Network Locator	109
Microsoft® Windows® Firewall	109
6 Securing Your Tablet-PC	111
Security Cable Lock	111
Smart Cards and Biometric Readers	111
Passwords	112
About Passwords	112
Using a Primary (or System) Password	113
Using an Administrator Password	114
Using a Hard Drive Password	114
Trusted Platform Module (TPM)	115
Enabling the TPM Feature	116
Security Management Software	116

	Activating the Security Management Software . . .	116
	Using the Security Management Software	117
	Computer Tracking Software	117
	If Your Tablet-PC Is Lost or Stolen	117
7	Cleaning Your Tablet-PC	119
	Tablet-PC, Keyboard, and Display	119
	Touch Pad	119
	Optical Drives and Optical Drive Media	120
8	Troubleshooting	121
	Dell Diagnostics	121
	When to Use the Dell Diagnostics	121
	Starting the Dell Diagnostics From Your Hard Drive	121
	Starting the Dell Diagnostics From the Drivers and Utilities Media	123
	Dell Diagnostics Main Menu	123
	Dell Support Utility for Windows Vista	125
	Accessing the Dell Support Utility	125
	Clicking the Dell Support Icon	126
	Windows Hardware Troubleshooter	126
	Solving Problems	126
	Hard Drive Problems	127
	Optical Drive Problems	128
	E-Mail and Internet Problems	128
	Error Messages	129

IEEE 1394 Device Problems	130
Lockups and Software Problems	130
Memory Problems	132
Network Problems	133
Power Problems	133
Printer Problems	134
Scanner Problems	134
Sound and Speaker Problems	135
Touch Pad or Mouse Problems	136
Troubleshooting Stylus and Touch Problems	137
Display Problems	138
Power Lights	139
9 Using the System Setup Program	141
Overview	141
System Setup Screens	142
Viewing the System Setup Screens	142
Commonly Used Options	142
Changing the Boot Sequence	142
10 Reinstalling Software	145
Drivers	145
What Is a Driver?	145
Identifying Drivers	145
Reinstalling Drivers and Utilities	146
Restoring Your Operating System	148
Using Microsoft Windows System Restore	149
Using Dell Factory Image Restore	150

Using the Operating System Media	151
11 Adding and Replacing Parts	155
Before You Begin	155
Recommended Tools	155
Turning Off Your Tablet-PC	155
Before Working Inside Your Tablet-PC	156
Main Battery	157
Removing the Main Battery	158
Installing the Main Battery	159
Hard Drive	159
Removing the Hard Drive	160
Installing the Hard Drive	161
Subscriber Identity Module (SIM) Card	162
Removing the SIM Card	162
Installing the SIM Card	163
Internal Card With Bluetooth® Wireless Technology	163
Remove the Internal Card Caddy	164
Installing a Bluetooth Card	165
Installing the Main Battery	167
Memory and Mini-Card Cover	167
Removing the Memory and Mini-Card Cover	168
Installing the Memory and Mini-Card Cover	168
Memory	168
Removing a Memory Module	169
Installing a Memory Module	169
Mini-Card	170

Removing a Mini-Card	171
Installing a Mini-Card	173
Hinge Cover	174
Removing the Hinge Cover	174
Installing the Hinge Cover	175
Keyboard	175
Removing the Keyboard	176
Installing the Keyboard	177
Coin-Cell Battery	177
Removing the Coin-cell Battery	178
Installing the Coin-Cell Battery	178
Display Assembly	179
Removing the Display Assembly	179
Installing the Display Assembly	182
Palm Rest	186
Removing the Palm Rest	186
Installing the Palm Rest	189
System Board	189
Removing the System Board	189
Installing the System Board	191
Fan	191
Removing the Fan	191
Installing the Fan	193
Pen and Whip Antenna Assembly	193
Removing the Pen and Whip Antenna Assembly	193
Installing the Pen and Whip Antenna Assembly	195
Wireless Switch	195

Removing the Wireless Switch	195
Installing the Wireless Switch	197
12 Dell™ D/Bay	199
About the Dell D/Bay	199
Setting Up and Using the D/Bay	199
Removing and Installing Devices When the Tablet-PC Is Turned Off	200
Removing and Installing Devices While the Tablet-PC Is Running	201
13 Media Base (Optional)	203
Left View	203
Right View	204
Back View	204
Top View	208
Setting Up Your Media Base	209
Securing the Media Base	210
Docking Your Tablet-PC to the Media Base	211
Undocking Your Tablet-PC From the Media Base	212
Installing the Optical Drive in the Media Base	213
Removing the Optical Drive From the Media Base	213
Media Base Specifications	214

14	Battery Slice (Optional)	217
	Top View	217
	Bottom View	218
	Setting Up Your Battery Slice	218
	Docking Your Tablet-PC to the Battery Slice	219
	Undocking Your Tablet-PC From the Battery Slice	220
	Charging Your Battery Slice	222
	Battery-Slice Power-Status LED	222
	Battery Slice Specifications	222
15	Traveling With Your Tablet-PC	225
	Identifying Your Tablet-PC	225
	Packing the Tablet-PC	225
	Travel Tips	226
	Traveling by Air	227
16	Appendix	229
	FCC Notice (U.S. Only)	229
	FCC Class B	229
	Macrovision Product Notice	230
17	Glossary	231

Resources

Finding Information



NOTE: Some features or media may be optional and may not ship with your Tablet-PC. Some features or media may not be available in certain countries.



NOTE: Additional information may ship with your Tablet-PC.

What Are You Looking For?	Find It Here
<ul style="list-style-type: none">• A diagnostic program for my Tablet-PC• Drivers for my Tablet-PC• My device documentation	Drivers and Utilities Media NOTE: The <i>Drivers and Utilities</i> media may be optional and may not ship with your Tablet-PC

What Are You Looking For?

- Notebook System Software (NSS)

Find It Here

Documentation and drivers are already installed on your Tablet-PC. You can use the *Drivers and Utilities* media to reinstall drivers (see "Reinstalling Drivers and Utilities" on page 146) or to run the Dell Diagnostics (see "Dell Diagnostics" on page 121).

Readme files may be included on your media to provide last-minute updates about technical changes to your Tablet-PC or advanced technical-reference material for technicians or experienced users.

**NOTE:**

Drivers and documentation updates can be found at support.dell.com.

What Are You Looking For?

- How to set up my Tablet-PC
- Summary of your Tablet-PC features
- Available accessories for your Tablet-PC

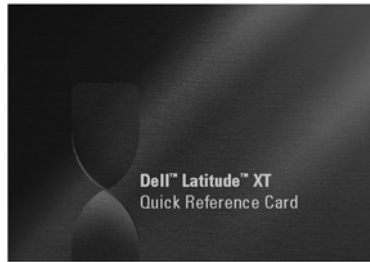
Find It Here**Quick Reference Card**

NOTE: This document is available as a PDF at support.dell.com. This publication may not be included with your system.

What Are You Looking For?

- Service Tag and Express Service Code
- Microsoft® Windows® License Label

Find It Here

Service Tag and Microsoft® Windows® License

NOTE: Your Tablet-PC's Service Tag label is located on the bottom of your Tablet-PC near the memory and Mini-Card cover (see "Bottom View" on page 40).

NOTE: You can also find your Service Tag information through the System Setup program. See "System Setup Screens" on page 142.

Your Tablet-PC's Service Tag contains both a Service Tag number and an Express Service Code.

- Use the Service Tag to identify your Tablet-PC when you use support.dell.com or contact support.
- Enter the Express Service Code to direct your call when contacting support.



NOTE: Your Tablet-PC's Microsoft® Windows® License label is located under the main battery in the battery bay of your Tablet-PC (see "Removing the Main Battery" on page 158).

- Use the product key on the license label if you need to reinstall your operating system.

NOTE: As an increased security measure, the newly designed Microsoft Windows license label incorporates a missing portion or "hole" to discourage removal of the label.

What Are You Looking For?

- Solutions — Troubleshooting hints and tips, articles from technicians, online courses, and frequently asked questions
- Community — Online discussion with other Dell customers
- Upgrades — Upgrade information for components, such as the system memory, the hard drive, and the operating system
- Customer Care — Contact information, service call and order status, warranty, and repair information
- Service and Support — Service call status and support history, service contract, online discussions with technical support
- Dell Technical Update Service — Proactive e-mail notification of software and hardware updates for my Tablet-PC
- Reference — Tablet-PC documentation, details on my Tablet-PC configuration, product specifications, and white papers
- Downloads — Certified drivers, patches, and software updates
- Notebook System Software (NSS) — If you reinstall the operating system for your Tablet-PC, you should also reinstall the NSS utility. NSS provides critical updates for your operating system and support for processors, optical drives, USB devices, and so on. NSS is necessary for correct operation of your Dell Tablet-PC. The software automatically detects your Tablet-PC and operating system, and installs the updates appropriate for your configuration.

Find It Here

Dell Support Website — support.dell.com

NOTE: Select your region or business segment to view the appropriate support site.

To download Notebook System Software:

- 1** Go to support.dell.com and click **Drivers & Downloads**.
- 2** Enter your Service Tag or Product Type and Product Model, and click **Go**.
- 3** Scroll to **System and Configuration Utilities**→ **Dell Notebook System Software** and click **Download Now**.
- 4** Select **Drivers & Downloads** and click **Go**.

NOTE: The support.dell.com user interface may vary depending on your selections.

What Are You Looking For?

- Software upgrades and troubleshooting hints — Frequently asked questions, hot topics, and general health of your computing environment
- How to find information about your Tablet-PC and its components
- How to connect to the Internet
- How to add user accounts for different people
- How to transfer files and settings from another Tablet-PC
- How to use Microsoft Windows Vista and Windows XP
- How to work with programs and files
- How to personalize my desktop

Find It Here**Dell Support Utility (Windows Vista®)**

The Dell Support Utility is an automated upgrade and notification system installed on your Tablet-PC. This support provides real-time health scans of your computing environment, software updates, and relevant self-support information. Access the Dell Support Utility from the  icon in the Windows Notification area. For more information, see "Dell Support Utility for Windows Vista" on page 125.

Windows Welcome Center

The Windows Welcome Center automatically appears when you use the Tablet-PC for the first time. You can choose to have it appear every time you start your Tablet-PC, or turn it off. Once turned off, to access the Welcome Center:

- Windows Vista — Click **Start**  → **Welcome Center**.
- Windows XP — Click **Start** → **Help and Support** → **Welcome to Tablet PC**.

Windows Help and Support

- 1** Click **Start**  (or **Start** in Windows XP) → **Help and Support**.
- 2** In *Search Help*, type a word or phrase that describes your problem, and then press <Enter> or click the magnifying glass.
- 3** Click the topic that describes your problem.
- 4** Follow the instructions on the screen.

What Are You Looking For?

- Information on tablet features and functionality, network activity, the Power Management Wizard, hotkeys, and other items controlled by Dell QuickSet

- How to reinstall my operating system

Find It Here**Dell QuickSet Help**

To view *Dell QuickSet Help*, press the QuickSet tablet settings button (see "Front View" on page 27), or right-click the QuickSet icon in the Microsoft® Windows® Notification area, and select **Help**. The Windows Notification area is located in the lower-right corner of your screen.

Operating System Media

The operating system is already installed on your Tablet-PC. To reinstall your operating system, use the *Operating System* media. See "Reinstalling the Operating System" on page 152.



After you reinstall your operating system, use the *Drivers and Utilities* media to reinstall drivers for the devices that came with your Tablet-PC.

Your operating system product key is on the Microsoft® Windows® License Label located in your Tablet-PC's main battery bay (see "Removing the Main Battery" on page 158).

NOTE: The color of your media varies based on the operating system you ordered.

Getting Help

Obtaining Assistance

 **CAUTION:** Before working inside your Tablet-PC, follow the safety instructions located in the *Product Information Guide*.

If you experience a problem with your Tablet-PC, complete the following steps to troubleshoot and diagnose the problem:

- 1 See "Troubleshooting" on page 121 for information and procedures that pertain to the problem your Tablet-PC is experiencing.
- 2 Run Dell Diagnostics. See "Dell Diagnostics" on page 121.
- 3 Fill out the "Diagnostics Checklist" on page 25. This checklist helps you to organize information Dell's support services will need to troubleshoot your Tablet-PC.
- 4 Use Dell's extensive suite of online services available at Dell Support (support.dell.com) for help with installation and troubleshooting procedures. See "Online Services" on page 22 for a more extensive list of Dell Support online services and features.
- 5 If the preceding steps have not resolved the problem, see "Contacting Dell" on page 26.

 **NOTE:** Call Dell Support from a telephone at or near the Tablet-PC so that the support staff can assist you with any necessary procedures.

 **NOTE:** Dell's Express Service Code system may not be available in all countries.

When prompted by Dell's automated telephone system, enter your Express Service Code to route the call directly to the proper support personnel. If you do not have an Express Service Code, open the **Dell Accessories** folder, double-click the **Express Service Code** icon, and follow the directions.

For instructions on using the Dell Support, see "Technical Support and Customer Service" on page 22.

Dell Support Service

 **NOTE:** Some of the following services are not always available in all locations outside the continental U.S. Call your local Dell representative for information on availability.

Technical Support and Customer Service

Dell's support service is available to answer your questions about Dell™ hardware. Our support staff uses Tablet-PC-based diagnostics to provide fast, accurate answers.

To contact Dell's support service, see "Before You Call" on page 24, and then see the contact information for your region or go to support.dell.com.

DellConnect

DellConnect is a simple online access tool that allows a Dell service and support associate to access your Tablet-PC through a broadband connection, diagnose your problem and repair it all under your supervision. For more information, go to support.dell.com and click **DellConnect**.

Online Services

You can learn about Dell products and services on the following websites:

www.dell.com

www.dell.com/ap (Asian/Pacific countries only)

www.dell.com/jp (Japan only)

www.euro.dell.com (Europe only)

www.dell.com/la (Latin American and Caribbean countries)

www.dell.ca (Canada only)

You can access Dell Support through the following websites and e-mail addresses:

- Dell Support websites
support.dell.com
support.jp.dell.com (Japan only)
support.euro.dell.com (Europe only)
- Dell Support e-mail addresses
mobile_support@us.dell.com
support@us.dell.com
la-techsupport@dell.com (Latin America and Caribbean countries only)

apsupport@dell.com (Asian/Pacific countries only)

- Dell Marketing and Sales e-mail addresses
apmarketing@dell.com (Asian/Pacific countries only)
sales_canada@dell.com (Canada only)
- Anonymous file transfer protocol (FTP)
<ftp.dell.com>

Log in as user: `anonymous`, and use your e-mail address as your password.

AutoTech Service

Dell's automated support service—AutoTech—provides recorded answers to the questions most frequently asked by Dell customers about their portable and desktop computers.

When you call AutoTech, use your touch-tone telephone to select the subjects that correspond to your questions. For the telephone number to call for your region, see "Contacting Dell" on page 26.

Automated Order-Status Service

To check on the status of any Dell products you have ordered, you can go to support.dell.com, or you can call the automated order-status service. A recording prompts you for the information needed to locate and report on your order. For the telephone number to call for your region, see "Contacting Dell" on page 26.

Problems With Your Order

If you have a problem with your order, such as missing parts, wrong parts, or incorrect billing, contact Dell for customer assistance. Have your invoice or packing slip handy when you call. For the telephone number to call for your region, see "Contacting Dell" on page 26.

Product Information

If you need information about additional products available from Dell, or if you would like to place an order, visit the Dell website at www.dell.com. For the telephone number to call for your region or to speak to a sales specialist, see "Contacting Dell" on page 26.

Returning Items for Warranty Repair or Credit

Prepare all items being returned, whether for repair or credit, as follows:

- 1 Call Dell to obtain a Return Material Authorization Number, and write it clearly and prominently on the outside of the box.
For the telephone number to call for your region, see "Contacting Dell" on page 26.
- 2 Include a copy of the invoice and a letter describing the reason for the return.
- 3 Include a copy of the Diagnostics Checklist (see "Diagnostics Checklist" on page 25), indicating the tests that you have run and any error messages reported by the Dell Diagnostics (see "Dell Diagnostics" on page 121).
- 4 Include any accessories that belong with the item(s) being returned (power cables, software, guides, and so on) if the return is for credit.
- 5 Pack the equipment to be returned in the original (or equivalent) packing materials.

You are responsible for paying shipping expenses. You are also responsible for insuring any product returned, and you assume the risk of loss during shipment to Dell. Collect On Delivery (C.O.D.) packages are not accepted.

Returns that are missing any of the preceding requirements will be refused at Dell's receiving dock and returned to you.

Before You Call



NOTE: Have your Express Service Code ready when you call. The code helps Dell's automated-support telephone system direct your call more efficiently. You may also be asked for your Service Tag (located on the bottom of your Tablet-PC).

Remember to fill out the Diagnostics Checklist (see "Diagnostics Checklist" on page 25). If possible, turn on your Tablet-PC before you call Dell for assistance and call from a telephone at or near the Tablet-PC. You may be asked to type some commands at the keyboard, relay detailed information during operations, or try other troubleshooting steps possible only at the Tablet-PC itself. Ensure that the Tablet-PC documentation is available.



CAUTION: Before working inside your Tablet-PC, follow the safety instructions in your *Product Information Guide*.

Diagnostics Checklist

Name:

Date:

Address:

Phone number:

Service Tag (bar code on the bottom of your Tablet-PC):

Express Service Code:

Return Material Authorization Number (if provided by Dell support technician):

Operating system and version:

Devices:

Expansion cards:

Are you connected to a network? Yes No

Network, version, and network adapter:

Programs and versions:

See your operating system documentation to determine the contents of the system's start-up files. If the Tablet-PC is connected to a printer, print each file. Otherwise, record the contents of each file before calling Dell.

Error message, beep code, or diagnostic code:

Description of problem and troubleshooting procedures you performed:

Contacting Dell

For customers in the United States, call 800-WWW-DELL (800-999-3355).



NOTE: If you do not have an active Internet connection, you can find contact information on your purchase invoice, packing slip, bill, or Dell product catalog.

Dell provides several online and telephone-based support and service options. Availability varies by country and product, and some services may not be available in your area. To contact Dell for sales, technical support, or customer service issues:

- 1 Visit support.dell.com.
- 2 Verify your country or region in the **Choose A Country/Region** drop-down menu at the bottom of the page.
- 3 Click **Contact Us** on the left side of the page.
- 4 Select the appropriate service or support link based on your need.
- 5 Choose the method of contacting Dell that is convenient for you.

About Your Tablet-PC

NOTICE: To avoid damaging your display, ensure that your Tablet-PC is in notebook mode and that the display is closed when you travel.

Front View



- | | | | |
|---|--|---|----------------------|
| 1 | grip | 2 | display |
| 3 | ambient light sensor (with Dual-bulb CCFL LCD option only) | 4 | device status lights |
| 5 | digital array microphone | 6 | biometric reader |

- | | |
|---|---------------------------------------|
| 7 touch pad | 8 touch pad buttons |
| 9 track stick buttons | 10 keyboard |
| 11 track stick | 12 rotating hinge |
| 13 digital array microphone | 14 power button |
| 15 Windows [®] security button | 16 screen rotate button |
| 17 QuickSet tablet settings button | 18 e-mail application shortcut button |







GRIP — Use to open the display.

DISPLAY — For more information about your display, see "Using the Display" on page 87.

AMBIENT LIGHT SENSOR — Depending on the display option you chose when ordering your Tablet-PC, your Tablet-PC may or may not have an ambient light sensor. The ambient light sensor detects available environmental light and automatically increases or decreases the display backlighting to compensate for low-light and high-light environments. Press <Fn> and the left-arrow key to enable or disable the sensor (see "Adjusting Brightness on the Dual-bulb (CCFL) LCD" on page 88).

DEVICE STATUS LIGHTS



-  Turns on when the Tablet-PC reads or writes data.
 -  **NOTICE:** To avoid loss of data, never turn off the Tablet-PC while the  light is flashing.
 -  Turns on steadily or blinks to indicate battery charge status.
 -  Turns on when wireless devices are enabled.
 -  Turns on when Bluetooth[®] wireless technology is enabled. To enable or disable Bluetooth wireless technology, move the wireless switch to the "on" position (see "Dell Wi-Fi Catcher™ Network Locator" on page 109 for more information).
- NOTE:** Bluetooth wireless technology is an optional feature on your Tablet-PC, so the  icon turns on only if you ordered Bluetooth wireless technology with your Tablet-PC. For more information, see the documentation that came with your Bluetooth wireless device.

If the Tablet-PC is connected to an electrical outlet, the  light operates as follows:

- Solid blue: The battery is charging.
- Flashing blue: The battery is charged and in maintenance charge mode.
- Off: The battery is adequately charged (or external power is not available to charge the battery).

If the Tablet-PC is running on a battery, the  light operates as follows:

- Off: The Tablet-PC is turned off, or the system is running on battery power and the battery is adequately charged to sustain the system.
- Flashing amber: The battery charge is low.
- Solid amber: The battery charge is critically low.

DIGITAL ARRAY MICROPHONE — Digital directional microphones for conferencing and chat.

BIOMETRIC READER — Helps to keep your Dell™ Tablet-PC secure. When you slide your finger over the reader, it uses your unique fingerprint to authenticate your user identity. For information on how to activate and use the security management software that controls the biometric reader, see "Security Management Software" on page 116.

TOUCH PAD — Provides the functionality of a mouse (see "Touch Pad" on page 85).

TOUCH PAD BUTTONS/TRACK STICK BUTTONS — When you use the touch pad and track stick, use these buttons to move the cursor on the display (see "Customizing the Touch Pad and Track Stick or Pointer" on page 86).

KEYBOARD — The keyboard includes a numeric keypad as well as the Windows logo key. For information on supported keyboard shortcuts, see "Using a Keyboard" on page 82.

TRACK STICK — Provides the functionality of a mouse (see "Customizing the Touch Pad and Track Stick or Pointer" on page 86).

ROTATING HINGE — Rotate the hinge to transform the PC into tablet mode. See "Using Tablet Mode" on page 55.

POWER BUTTON — Press the power button to turn on the Tablet-PC or exit a power management mode (see "Power Management Modes" on page 77).



NOTICE: To avoid losing data, turn off your Tablet-PC by performing a Microsoft® Windows® operating system shutdown rather than by pressing the power button. See "Turning Off Your Tablet-PC" on page 155 for instructions on performing an operating system shutdown.

If the Tablet-PC stops responding, press and hold the power button until the Tablet-PC turns off completely (which may take several seconds).

The power button is surrounded by a backlit ring which is illuminated blue when you turn on the Tablet-PC, and blinks when the Tablet-PC is in a power-management mode.

WINDOWS SECURITY BUTTON — If you are using your Tablet-PC in tablet mode, you can press the Windows security button to access the Windows Task Manager dialog box or a login screen, the same way you use the <Ctrl><Alt> key combination in notebook mode. See "Using Tablet Buttons" on page 62 for more information.

SCREEN ROTATE BUTTON — While the Tablet-PC is in tablet mode, you can use the screen rotate button to change the display orientation from portrait to landscape mode. See "Using Tablet Buttons" on page 62 for more information.

QUICKSET TABLET SETTING BUTTON — Access Dell QuickSet to view and configure options for your Tablet-PC and pen. See "Using Tablet Buttons" on page 62 for more information.

E-MAIL APPLICATION SHORTCUT BUTTON — Launches your e-mail application. See "Using Tablet Buttons" on page 62 for more information.

KEYBOARD STATUS LIGHTS



Three keyboard status lights on your Tablet-PC indicate when the following functions are activated by the corresponding key combination.

Key Combination	Function
<Fn><F4>	Turns on when the numeric keypad is enabled. Located above the upper edge of the keyboard.
<Caps Lock>	Turns on when the uppercase letter function is enabled. Located on the <Caps Lock> key.
<Fn><F5>	Turns on when the scroll lock function is enabled. Located above the upper edge of the keyboard.

Left Side View



- | | | | |
|---|-------------------------------|---|---------------------|
| 1 | pen indicator LED | 2 | pen |
| 3 | external wireless WAN antenna | 4 | IEEE 1394 connector |

NOTE: The external antenna is provided with WWAN cards only and is not included in the standard computer configuration. The computer comes with a plug that you need to remove prior to installing the antenna and WWAN card.

- | | | | |
|---|---------------|---|----------|
| 5 | USB connector | 6 | air vent |
| 7 | speaker | | |

PEN — To eject the pen from the compartment, press and release the end of the pen.

PEN INDICATOR LED — Indicates pen status. See "Ejecting and Storing the Pen" on page 65.

EXTERNAL WIRELESS WAN ANTENNA — If your Tablet-PC supports wireless wide area network (WWAN) connectivity, you must extend and orient the external WWAN antenna for optimal signal strength.

IEEE 1394 CONNECTOR



Connect FireWire devices, such as a camera, external hard drive, or external CD-ROM drive. Supports hot swapping, multiple speeds on the same bus, and time-based data transfer. This provides bandwidth for multimedia operations.

USB CONNECTOR

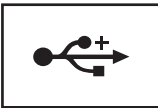

Connect USB devices, such as a mouse, keyboard, or printer.

AIR VENTS — The Tablet-PC uses an internal fan to create airflow through the vents, which prevents the Tablet-PC from overheating.

⚠ CAUTION: Do not block, push objects into, or allow dust to accumulate in the air vents. Do not store your Tablet-PC in a low-airflow environment, such as a closed briefcase, while it is running. Restricting the airflow can damage the Tablet-PC or cause a fire. The Tablet-PC turns on the fan when the Tablet-PC gets hot. Fan noise is normal and does not indicate a problem with the fan or the Tablet-PC.

SPEAKER — To adjust the volume of the integrated speaker, use the volume-control keyboard shortcuts (see "Key Combinations" on page 82).

Right Side View



- | | |
|---------------------------------|-------------------------|
| 1 wireless radio on/off switch | 2 Wi-Fi Catcher™ button |
| 3 USB connector | 4 ExpressCard slot |
| 5 Secure Digital (SD) card slot | 6 headphones connector |
| 7 microphone connector | 8 security cable slot |

WIRELESS RADIO ON/OFF SWITCH — When enabled through Dell QuickSet, this switch can scan for a wireless local area network (WLAN) in your vicinity. You can also use it to rapidly turn off or on any wireless devices such as WLAN cards and internal cards with Bluetooth wireless technology (see "Dell Wi-Fi Catcher™ Network Locator" on page 109). When moved toward the front of the Tablet-PC, the switch is off; when moved toward the back of the Tablet-PC, the switch is on.

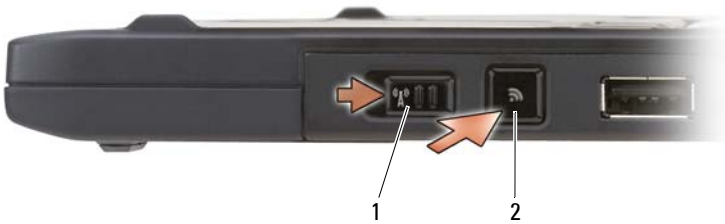

- | | |
|--------------------------------|-------------------------|
| 1 wireless radio on/off switch | 2 Wi-Fi Catcher™ button |
|--------------------------------|-------------------------|

BACKLIT WI-FI CATCHER™ BUTTON — Scans for WLAN networks (see "Dell Wi-Fi Catcher™ Network Locator" on page 109). The light operates as follows:

- Flashing blue: Searching for networks
- Solid blue: Strong network found
- Solid yellow: Weak network found
- Flashing yellow: Error
- Off: Wireless radio switch is off, no signal is found, or Microsoft Windows is running.

USB CONNECTOR

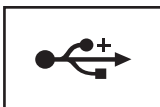

Connect USB devices, such as a mouse, keyboard, or printer.

EXPRESSCARD SLOT — Supports one ExpressCard, such as the optional smart-card reader. For more information, see "Using Cards" on page 89.

SECURE DIGITAL (SD) CARD SLOT — Supports one Secure Digital memory card, a storage device used in portable devices such as digital cameras, handheld computers, PDAs, and GPS units.

AUDIO CONNECTORS



Attach headphones to the  connector.

Attach a microphone to the  connector.

SECURITY CABLE SLOT — Lets you attach a commercially available antitheft device to the Tablet-PC (see "Security Cable Lock" on page 111).

Back View



- | | | | |
|---|----------------------|---|-----------------------|
| 1 | AC adapter connector | 2 | video connector |
| 3 | tablet back button | 4 | scroll control button |
| 5 | network connector | 6 | powered USB connector |
| 7 | rotating hinge | 8 | tablet grip |
| 9 | pen tether slot | | |

AC ADAPTER CONNECTOR



Connects an AC adapter to the Tablet-PC.



The AC adapter converts AC power to the DC power required by the Tablet-PC. You can connect the AC adapter with your Tablet-PC turned either on or off.



CAUTION: The AC adapter works with electrical outlets worldwide. However, power connectors and power strips vary among countries. Using an incompatible cable or improperly connecting the cable to the power strip or electrical outlet may cause fire or equipment damage.



NOTICE: When you disconnect the AC adapter cable from the Tablet-PC, grasp the connector, not the cable itself, and pull firmly but gently to avoid damaging the cable. When you wrap the AC adapter cable, ensure that you follow the angle of the connector on the AC adapter to avoid damaging the cable.

VIDEO CONNECTOR



Connects video devices, such as a monitor.

TABLET BACK BUTTON — Use to navigate while in tablet mode. See "Using the Back Button" on page 62.

SCROLL CONTROL BUTTON — Use to navigate while in tablet mode. See "Using the Scroll Control" on page 62.



NOTICE: To avoid damaging the Tablet-PC, do not plug a telephone line into the network connector or USB connectors.

NETWORK CONNECTOR (RJ-45)

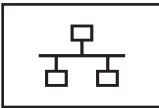

Connects video devices, such as a monitor.

POWERED USB CONNECTOR



Connects video devices, such as a monitor.

ROTATING HINGE — Converts Tablet-PC between notebook and tablet modes.

PEN TETHER SLOT — Use to connect a tether between the Tablet-PC and the pen.

Top View



Turns on steadily or blinks to indicate battery charge status.



Turns on when you turn on the Tablet-PC and blinks when the Tablet-PC is in a power management mode.

Bottom View

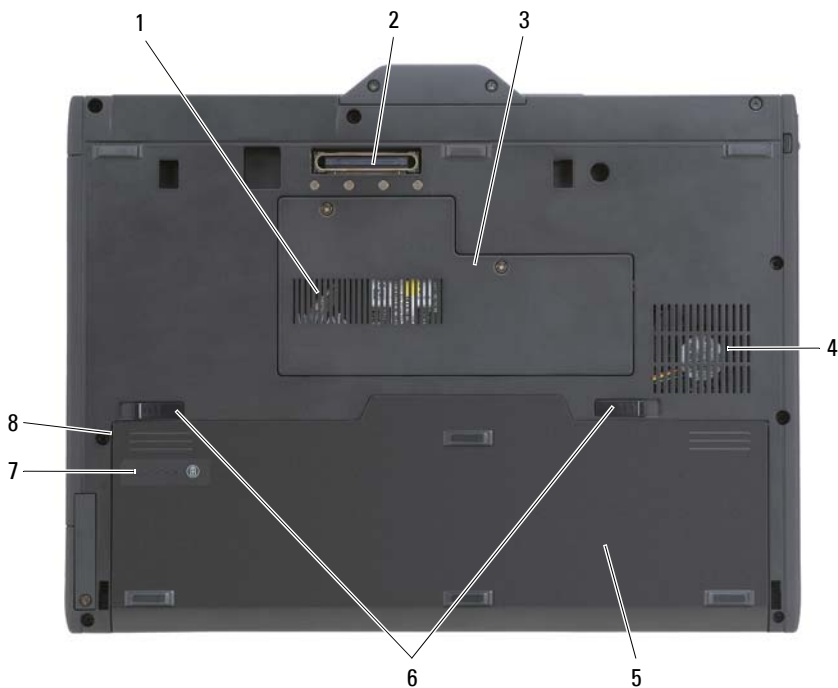

- | | | | |
|---|-----------------------------------|---|------------------------------------|
| 1 | air vent | 2 | docking-device connector |
| 3 | memory module and Mini-Card cover | 4 | fan vent |
| 5 | main battery | 6 | battery-bay latch releases (2) |
| 7 | battery charge gauge/health gauge | 8 | battery bay (beneath main battery) |

➡ NOTE: Your Tablet-PC's Microsoft® Windows® License label is located under the main battery in the battery bay of your Tablet-PC (see "Removing the Main Battery" on page 158).

AIR VENTS — The Tablet-PC uses an internal fan to create airflow through the vents, which prevents the Tablet-PC from overheating.

⚠ CAUTION: Do not block, push objects into, or allow dust to accumulate in the air vents. Do not store your Tablet-PC in a low-airflow environment, such as a closed briefcase, while it is running. Restricting the airflow can damage the Tablet-PC or cause a fire. The Tablet-PC turns on the fan when the Tablet-PC gets hot. Fan noise is normal and does not indicate a problem with the fan or the Tablet-PC.

DOCKING-DEVICE CONNECTOR — Lets you attach your Tablet-PC to a media base or battery slice. See "Docking Your Tablet-PC to the Media Base" on page 211 and "Docking Your Tablet-PC to the Battery Slice" on page 219 for more information.

MEMORY MODULE AND MINI-CARD COVER — Covers the compartment that contains the memory module and any Mini-Cards installed on your Tablet-PC (see "Memory" on page 42 and "Communications" on page 43).

BATTERY CHARGE GAUGE/HEALTH GAUGE — Provides information on the battery charge (see "Checking the Battery Charge" on page 74).

BATTERY — When a battery is installed, you can use the Tablet-PC without connecting the Tablet-PC to an electrical outlet (see "Using a Battery" on page 73).

BATTERY-BAY LATCH RELEASES — Release the battery (see "Before Working Inside Your Tablet-PC" on page 156 for instructions).

Pen View

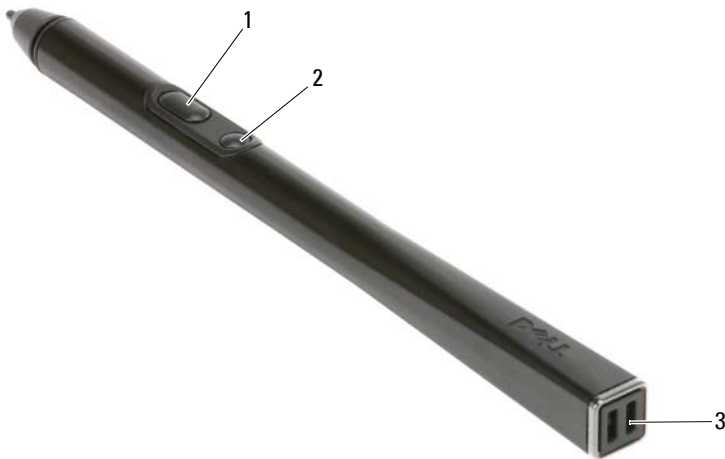

- 1 right-click pen button 2 erase pen button 3 pen tether slots

Specifications

 **NOTE:** Offerings may vary by region. For more information regarding the configuration of your Tablet-PC, click **Start**  (or **Start** in Windows XP) → **Help and Support**, and then select the option to view information about your Tablet-PC.

Processor

Processor type	Intel® Core™ Duo or Intel® Core™ Solo
L1 cache	64 KB (internal) each processor core
L2 cache	up to 4 MB
External bus frequency	533 MHz or 667 MHz

System Information

System chipset	AMD RS600ME/SB600
Data bus width	64 bits
DRAM bus width	64 bits
Processor address bus width	32 bits
Flash EPROM	2 MB
PCI bus	32 bits

Memory

Integrated memory on system board	1 GB
Optional memory:	
Memory module connector	one user-accessible SODIMM socket
Memory module capacities	1 GB and 2 GB
Maximum system memory capacity	3 GB
Memory type	3.3-V SODIMM

Storage

Internal hard drive:	
Form factor	1.8-inch PATA HDD or optional 1.8-inch PATA Solid State HDD

Storage	
Speed	4200-rpm
Max size	100 GB 32 GB (optional 1.8-inch PATA Solid State HDD only)
Dell D/Bay (external):	
Power requirement	powered USB port
Optical drive support	CD-ROM, DVD +/-RW, DVD-ROM

Ports and Connectors	
Audio	microphone connector, stereo headphone/speakers connector
IEEE 1394	4-pin serial connector
Mini-card	two Mini-card slots
Network adapter	RJ-45 port
USB	two 4-pin USB 2.0-compliant connectors
Powered USB	5-pin power supply and 4-pin USB 2.0-compliant connector
Video	15-hole connector

Communications	
Network adapter	10/100/1000 Ethernet LAN with ASF 2.0 support on system board
Wireless	internal WLAN, WWAN (with optional Mini-Card), and Bluetooth® wireless support

Video	
Video type	integrated on system board, 128-bit hardware accelerated
Data bus	integrated video
Video controller	integrated graphics (UMA) AMD RS600

Video (continued)

Video memory	up to 256 MB shared Video Memory (512 MB + system memory)
LCD interface	LVDS

Audio

Audio type	two-channel high definition audio (Azalia)
Audio controller	IDT STAC9205 Codec
Stereo conversion	24-bit (analog-to-digital and digital-to-analog)
Interfaces:	
Internal	high definition audio (Azalia)
External	microphone-in connector, stereo headphones/speakers connector
Speaker	one 4-ohm speaker
Internal speaker amplifier	2-Watt channel into 4 ohms
Volume controls	keyboard shortcuts, program menus
Stereo Digital Microphone Array	
Windows Vista [®]	supports Windows Vista native microphone processing
Windows XP	includes Knowles Intellisonic microphone processing

Display

Both LED backlit thin-and-light LCD and Dual-bulb (CCFL) LCD options:

Panel design	12.1 inches WXGA
Display area	261.12 mm (H) x 163.20 mm (V) 12.1 inches diagonal
Aspect ratio	16:10
Number of pixels	1280 x 3 (RGB) x 800 dots

Display (continued)

Pixel pitch	0.204 x 0.204 nominal
Display mode	normally white
Viewing angles:	
Horizontal	+/- 70 degrees
Vertical	+/- 70 degrees

LED backlit thin-and-light LCD option:

Luminescence	220 nits Typ
--------------	--------------

Dual-bulb (CCFL) LCD option:

Luminescence	400 nits Typ
--------------	--------------

Tablet Input Devices

Digitizer

Interface	capacitive touch
Input resolution	1000 dpi
Position report rate	133 PPS
Coordinate accuracy (average)	+/- 0.4 mm
Coordinate jitter (maximum)	+/- 0.4 mm

Pen

Dimensions:

Length	133 mm (5.2 inches)
Diameter	9 mm (0.35 inches)
Type	two-button, battery-less

Notebook Input Devices

Keyboard:

Number of keys	84 (U.S. and Canada); 85 (U.K., Europe); 89 (Japan); 86 (Brazil)
----------------	--

Notebook Input Devices

Layout	QWERTY/AZERTY/Kanji
Touch pad:	
X/Y position resolution (graphics tablet mode)	240 cpi
Size:	
Width	56.7-mm (2.23-inch) sensor-active area
Height	35.9-mm (1.41-inch) rectangle
Track Stick:	
X/Y position resolution (graphics tablet mode)	160 count/sec @ 100 gf

Biometric Reader

Type	UPEK TCS3 TouchStrip™ strip sensor with CMOS active capacitive pixel-sensing technology
Array size	248 x 2 pixels

Battery

Type	4-cell "smart" lithium ion (28 WHr) 6-cell "smart" lithium ion (42 WHr)
Dimensions:	
Depth	96.84 mm (3.81 inches)
Height	13.7 mm (0.54 inch)
Width	264.27 mm (10.4 inches)
Weight	0.26 kg (0.57 lb) (4 cell) 0.34 kg (0.74 lb) (6 cell)
Voltage	11.1 VDC
Charge time (approximate)	4 hours (with computer off)

Battery (continued)

Operating time	Battery operating time varies depending on operating conditions and can be significantly reduced under certain power-intensive conditions See "Using a Battery" on page 73 for more information on battery life.
Life span (approximate)	300 discharge/charge cycles
Temperature range:	
Operating	0° to 35°C (32° to 95°F)
Storage	-40° to 65°C (-40° to 149°F)

AC Adapter

Input voltage	90–264 VAC
Input current (maximum)	1.1 A
Input frequency	47–63 Hz
Output current	3.3 A (maximum at 4-second pulse); 2.3 A (continuous)
Output power	45 W, 65 W (optional), or Auto Air 65 W (optional)
Rated output voltage	19.5 VDC
Dimensions:	
Height	16.0 mm (0.63 inches)
Width	63.0 mm (2.48 inches)
Depth	88.0 mm (3.46 inches)
Weight (with cables)	0.195 kg (0.43 lb)
Temperature range:	
Operating	0° to 40°C (32° to 104°F)
Storage	-10° to 70°C (-50° to 158°F)

Physical

Height:

With LED backlit thin-and-light LCD 25.4 mm (1.0 inches) (system closed/LED standard configuration)

With Dual-bulb CCFL LCD

29.85 mm (1.2 inches) (system closed/DLV standard configuration)

Width

297.0 mm (11.7 inches)

Depth

218.6 mm (8.6 inches)

Weight

1.62 kg (3.57 lb) (with 4-cell battery/LED standard configuration)

1.93 kg (4.25 lb) (with 6-cell battery/DLV standard configuration)

Environmental

Temperature range:

Operating 0° to 35°C (32° to 95°F)

Storage -40° to 65°C (-40° to 149°F)

Relative humidity (maximum):

Operating 10% to 90% (non-condensing)

Storage 5% to 95% (non-condensing)

Maximum vibration (using a random-vibration spectrum that simulates user environment):

Operating 0.9 GRMS

Storage 1.3 GRMS

Maximum shock (measured with hard drive in head-parked position and a 2-ms half-sine pulse):

Operating 122 G

Storage 163 G

Environmental (continued)

Altitude (maximum):

Operating	-15.2 to 3048 m (-50 to 10,000 ft)
Storage	-15.2 to 10,668 m (-50 to 35,000 ft)
Airborne contaminant level	G2 or lower as defined by ANSI/ISA-S71.04-1985

Setting Up and Using Your Tablet-PC

Transferring Information to a New Tablet-PC

Microsoft® Windows® provides a wizard to help you transfer files and other data from one Dell™ computer to another—for example, from an *old* computer or Tablet-PC to a *new* computer or Tablet-PC.

Transferring Information in Windows Vista®

- 1 Click Start , and then click **Transfer files and settings**→ **Start Windows Easy Transfer**.
- 2 In the **User Account Control** dialog box, click **Continue**.
- 3 Click **Start a new transfer** or **Continue a transfer in progress**.

Follow the instructions provided on the screen by the Windows Vista Easy Transfer wizard.

Transferring Information in Windows XP

You can transfer the data to the new computer over a network or serial connection, or you can store it on removable media, such as a writable CD, for transfer to the new computer.



NOTE: You can transfer information from an old computer to a new computer by directly connecting a serial cable to the input/output (I/O) ports of the two computers. To transfer data over a serial connection, you must access the Network Connections utility from the Control Panel and perform additional configuration steps, such as setting up an advanced connection and designating the host computer and the guest computer.

For instructions on setting up a direct cable connection between two computers, see Microsoft Knowledge Base Article #305621, titled *How to Set Up a Direct Cable Connection Between Two Computers in Windows XP*. This information may not be available in certain countries.

For transferring information to a new computer, you must run the Files and Settings Transfer Wizard. You can use the *Operating System* media (if available) for this process or you can create a wizard disk with the Files and Settings Transfer Wizard.

Running the Files and Settings Transfer Wizard With the Operating System Media



NOTE: This procedure requires the *Operating System* media. This media is optional and may not be included with certain computers.

To prepare a new computer for the file transfer:

- 1 Open the Files and Settings Transfer Wizard: click **Start**→**All Programs**→**Accessories**→**System Tools**→**Files and Settings Transfer Wizard**.
- 2 When the **Files and Settings Transfer Wizard** welcome screen appears, click **Next**.
- 3 On the **Which computer is this?** screen, click **New Computer**→**Next**.
- 4 On the **Do you have a Windows XP CD?** screen, click **I will use the wizard from the Windows XP CD**→**Next**.
- 5 When the **Now go to your old computer** screen appears, go to your old or source computer. Do *not* click **Next** at this time.

To copy data from the old computer:

- 1 On the old computer, insert the Windows XP *Operating System* media.
- 2 On the **Welcome to Microsoft Windows XP** screen, click **Perform additional tasks**.
- 3 Under **What do you want to do?**, click **Transfer files and settings**→**Next**.
- 4 On the **Which computer is this?** screen, click **Old Computer**→**Next**.
- 5 On the **Select a transfer method** screen, click the transfer method you prefer.
- 6 On the **What do you want to transfer?** screen, select the items you want to transfer and click **Next**.

After the information has been copied, the **Completing the Collection Phase** screen appears.

- 7 Click **Finish**.

To transfer data to the new computer:

- 1 On the **Now go to your old computer** screen on the new computer, click **Next**.
- 2 On the **Where are the files and settings?** screen, select the method you chose for transferring your settings and files and click **Next**.

The wizard reads the collected files and settings and applies them to your new computer.

When all of the settings and files have been applied, the **Finished** screen appears.

- 3 Click **Finished** and restart the new computer.

Running the Files and Settings Transfer Wizard Without the Operating System Media

To run the Files and Settings Transfer Wizard without the *Operating System* media, you must create a wizard disk that will allow you to create a backup image file to removable media.

To create a wizard disk, use your new computer with Windows XP and perform the following steps:

- 1 Open the Files and Settings Transfer Wizard: click **Start**→ **All Programs**→ **Accessories**→ **System Tools**→ **Files and Settings Transfer Wizard**.
- 2 When the **Files and Settings Transfer Wizard** welcome screen appears, click **Next**.
- 3 On the **Which computer is this?** screen, click **New Computer**→ **Next**.
- 4 On the **Do you have a Windows XP CD?** screen, click **I want to create a Wizard Disk in the following drive**→ **Next**.
- 5 Insert the removable media, such as a writable CD, and click **OK**.
- 6 When the disk creation completes and the **Now go to your old computer** message appears, *do not* click **Next**.
- 7 Go to the old computer.

To copy data from the old computer:

- 1 On the old computer, insert the wizard disk.
- 2 Click **Start**→ **Run**.
- 3 In the **Open** field on the **Run** window, browse to the path for **fastwiz** (on the appropriate removable media) and click **OK**.

- 4 On the **Files and Settings Transfer Wizard** welcome screen, click **Next**.
- 5 On the **Which computer is this?** screen, click **Old Computer**→ **Next**.
- 6 On the **Select a transfer method** screen, click the transfer method you prefer.
- 7 On the **What do you want to transfer?** screen, select the items you want to transfer and click **Next**.

After the information has been copied, the **Completing the Collection Phase** screen appears.

- 8 Click **Finish**.

To transfer data to the new computer:

- 1 On the **Now go to your old computer** screen on the new computer, click **Next**.
- 2 On the **Where are the files and settings?** screen, select the method you chose for transferring your settings and files and click **Next**. Follow the instructions on the screen.

The wizard reads the collected files and settings and applies them to your new computer.

When all of the settings and files have been applied, the **Finished** screen appears.

- 3 Click **Finished** and restart the new computer.



NOTE: For more information about this procedure, search support.dell.com for document #154781 (*What Are The Different Methods To Transfer Files From My Old Computer To My New Dell™ Computer Using the Microsoft® Windows® XP Operating System?*).



NOTE: Access to the Dell™ Knowledge Base document may not be available in certain countries.

Using Notebook Mode

Your Tablet-PC can be used either in notebook mode or tablet mode. To use your Tablet-PC in notebook mode, open the display until it reaches a comfortable viewing angle, and use the keyboard and display as you would those of any other notebook computer.



 **NOTE:** You can use all the pen and touch screen input methods (see "Controlling Your Tablet-PC in Tablet Mode" on page 62) while in notebook mode except for the scroll control and back button, which are not accessible with the display in this configuration.

Using Tablet Mode

 **NOTICE:** To avoid damaging your display, ensure that your Tablet-PC is in notebook mode and that the display is closed when you travel.

Your Tablet-PC converts from notebook mode to tablet mode with a 180-degree clockwise twist of the display's rotating hinge.

Converting Your Tablet-PC Between Notebook and Tablet Modes

To convert your Tablet-PC to tablet mode:

 **NOTICE:** Forcing the hinge beyond the 180-degree point will damage your Tablet-PC.

➔ NOTICE: Ensure that the display does not scrape the keycaps as you rotate the display, or you may cause damage to your keyboard.

- 1 Open the display of the Tablet-PC until it reaches a 90-degree angle, perpendicular to the base.
- 2 Brace the base with one hand on the palm rest, grasp the top of the display with the other hand, and, following the directional arrow inscribed on the hinge cover, turn the rotating hinge clockwise 180 degrees until you feel the display engage securely.



- | | | | |
|---|----------------|---|-------------------|
| 1 | display | 2 | display assembly |
| 3 | rotating hinge | 4 | directional arrow |

- 3 Lay the display assembly on the base with the display facing upwards.



When you convert your Tablet-PC between notebook and tablet modes, the screen orientation of your Tablet-PC will automatically change according to the settings you have established in the Dell QuickSet application or the Pen and Tablet settings application, most commonly from landscape (notebook mode) to portrait (tablet mode). See "QuickSet" on page 71 for more information on customizing your Tablet-PC settings.

To convert your Tablet-PC from tablet mode to notebook mode:

- ➔ **NOTICE:** Forcing the hinge beyond the 180-degree point will damage your Tablet-PC.
 - ➔ **NOTICE:** Ensure that the display assembly does not scrape the keycaps as you rotate the display, or you may cause damage to your keyboard.
- 1 Lift the display until it reaches a 90-degree angle, perpendicular to the base.



- 2 Brace the base with one hand on the palm rest, grasp the top of the display with the other hand, and, following the directional arrow inscribed on the grip, turn the rotating hinge counter-clockwise 180-degrees until you feel the display assembly engage securely in the notebook mode configuration.



- 1 display assembly
- 2 rotating hinge
- 3 directional arrow on grip

3 Adjust the display to a comfortable viewing angle.

Right- and Left-handed Use

Your Tablet-PC can be adjusted for either right- or left-handed use. Several settings within the operating system enable you to customize the Tablet-PC depending on whether you are right- or left-handed.

- Right-handed use:
Hold the Tablet-PC on your left forearm with your left hand on the grip, and the scroll control and back button within reach of your fingers. You

can hold the pen in your right hand or use a right-hand finger to operate the tablet buttons and display.



- Left-handed use:
Hold the Tablet-PC on your right forearm with your right hand on the grip. You can hold the pen in your left hand, manipulate the scroll control and back buttons with your left hand, or use a left-hand finger to operate the tablet buttons and display.



Screen Orientation

You can change the display orientation of your Tablet-PC from portrait to landscape in several different ways:

- Press the screen rotate tablet button to rotate the screen 90-degrees clockwise.
- Right-click the **QuickSet** icon in the Notification area, click **Tablet Settings**→ **Display**, then choose the orientation you want from the **Screen Orientation** pull-down menu.
- In Windows Vista, click **Start**  → **Control Panel**→ **Mobile PC**→ **Tablet PC Settings**→ **Display**.
- In Windows XP, click **Start**→ **Control Panel**→ **Printers and Other Hardware**→ **Tablet and Pen Settings** and then click the **Display** tab.

- In Windows Vista, press the Windows Logo key and <x> to open **Windows Mobility Center**, and then click the button in the **Screen Orientation** window until the display is in the desired orientation.

Controlling Your Tablet-PC in Tablet Mode

In tablet mode, you can control your Tablet-PC using the following methods:

- Using the scroll control
- Using the back button
- Using the tablet buttons
- Using the pen
- Using touch

Using the Scroll Control

- To scroll through a list of items or a set of pages one at a time, shift the scroll control up or down and release. The control automatically returns to the center/neutral position when released.
- To rapidly scroll through a list of items or a set of pages, shift the control up or down and hold it, releasing it when you wish to stop scrolling.
- To select objects, press and release the scroll control when it is in the center/neutral position.
- To launch context sensitive menus, press and hold the scroll control until a complete circle is drawn on the display, and then release. This is equivalent to clicking the right mouse button on a notebook computer.

Using the Back Button

Use the back button, located adjacent to the scroll control, to move backward in applications that support navigation, such as web browsers and Windows Explorer, and to close the active window.

- To move backward, press and release the back button.
- To close the active window, press and hold the back button.
- To customize the back button behavior, use the **Tablet and Pen Settings**.

Using Tablet Buttons

Your Tablet-PC has four tablet buttons located beside the power button.

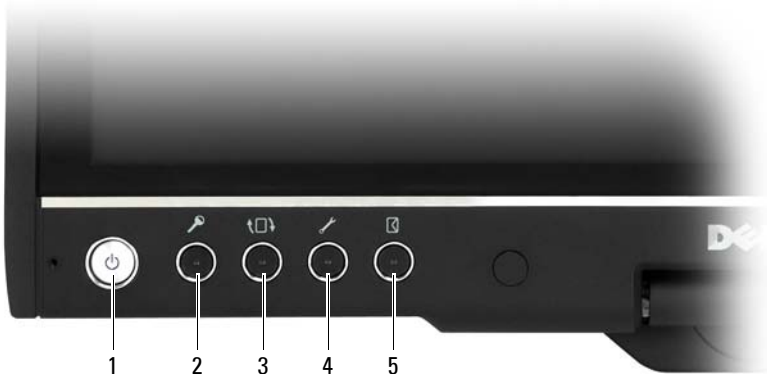

- | | | | |
|---|------------------------------------|---|---------------------------------|
| 1 | power button | 2 | Windows security button |
| 3 | screen rotate button | 4 | QuickSet tablet settings button |
| 5 | e-mail application shortcut button | | |

WINDOWS SECURITY BUTTON



If you are using your Tablet-PC in tablet mode, you can press the Windows security button to access the **Windows Task Manager** dialog box or a login screen, the same way you use the <Ctrl><Alt> key combination in notebook mode.

SCREEN ROTATE BUTTON

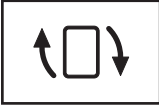

While the Tablet-PC is in tablet mode, you can use the screen rotate button to change the display orientation from portrait to landscape mode:

- Each time you press and release the screen rotate button, the screen image rotates clockwise 90 degrees.
 - If you press and hold the screen rotate button, the display switches off. The computer will not recognize input until you press and hold the screen rotate button a second time, or use the pen to wake the Tablet-PC. This feature provides a convenient way to prevent inadvertent input while carrying your Tablet-PC.
-

QUICKSET TABLET SETTINGS BUTTON



Press this button to view and configure options for the Tablet-PC and the pen through Dell QuickSet. You can configure this button using **Tablet PC Settings** (Windows Vista) or **Tablet Settings** (Windows XP).

E-MAIL APPLICATION SHORTCUT BUTTON



Launches either Microsoft Outlook or Outlook Express if you have one of these applications installed on your Tablet-PC. You can configure this button using **Tablet PC Settings** (Windows Vista) or **Tablet Settings** (Windows XP).

Disabling and Enabling Tablet Buttons

You can disable and enable the tablet buttons using the Dell QuickSet application. To access QuickSet, click the QuickSet icon in the Notification area, or press the QuickSet tablet settings button.

You can change the actions assigned to the back button, the tablet settings button, the e-mail application shortcut button, and the scroll control (Windows Vista).

To access the settings for these buttons:

- In Windows Vista, click **Start** → **Control Panel** → **Mobile PC** → **Tablet PC Settings** → **Set tablet buttons to perform certain tasks**.
- In Windows XP, click **Start** → **Control Panel** → **Printers and Other Hardware** → **Tablet and Pen Settings**, and then click the **Tablet Buttons** tab.

Using the Pen

Ejecting and Storing the Pen

Press and release the pen to eject it from the pen compartment. To protect the pen when you are not using it, insert the pen, tip first, into the pen compartment on the Tablet-PC. Press to engage the pen in its compartment.



- | | | | |
|---|-------------------|---|-----------------|
| 1 | pen indicator LED | 2 | pen compartment |
| 3 | pen | | |

When you remove the pen from the pen compartment, the pen indicator LED blinks quickly to indicate that the pen has been removed.

If the pen is not in its compartment when the Tablet-PC shuts down or enters sleep or hibernate mode, the pen indicator LED blinks slowly to remind you to replace the pen in the compartment. The behavior of the pen indicator LED can be enabled or disabled through the QuickSet tablet settings application (see "Dell QuickSet Help" on page 20 for instructions on accessing QuickSet).

Replacing the Pen Tip

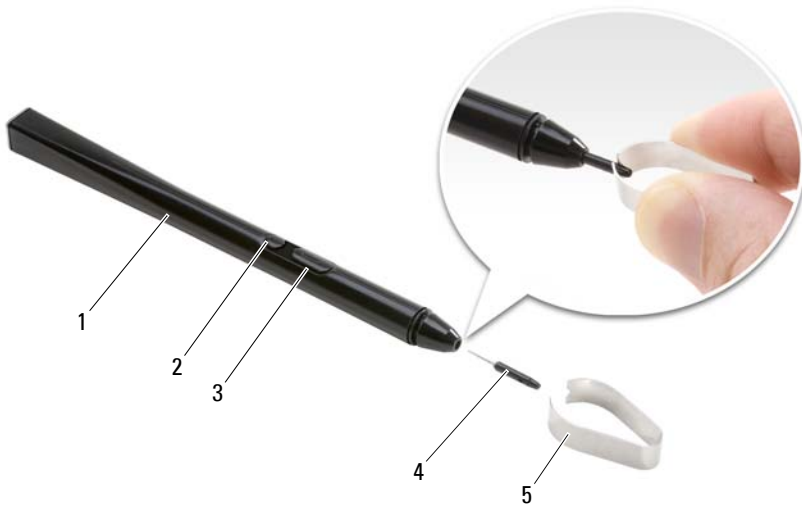

- | | | | |
|---|------------------------|---|------------------|
| 1 | pen | 2 | erase pen button |
| 3 | right-click pen button | 4 | pen tip |
| 5 | pen-tip remover tool | | |

Your Tablet-PC ships with several of each of two types of pen tips: hard (simulates the feel of a ballpoint pen) and soft (simulates the feel of a felt-tip pen).

To replace a pen tip:

- 1 Use the pen-tip remover tool to grasp the pen tip, then firmly pull the tip from the pen.

- 2 With your fingers, place a new tip into the pen, and insert the tip until it is fully seated in the pen.

Calibrating the Pen

The pen can function at the default calibration or at a calibration set by you or by another user. Dell recommends that you use the pen only while it is calibrated to your personal calibration settings. Calibration optimizes pen performance for each user.

To calibrate the pen:

- 1 Press the **QuickSet** tablet settings button, click **Control Tablet PC Settings**→ **Pen and Input Settings**.
- 2 At the bottom of the **General** tab, tap the **Calibrate** button.
- 3 Follow the instructions on the screen. The calibration markers are displayed on the screen as plus signs (+). Tap the pen in the exact center of each of the calibration markers.



NOTE: Be sure to calibrate the pen for use in both portrait and landscape display orientations.

Using the Pen Like a Mouse

You can use the pen with your Tablet-PC the same way you use a mouse or touch pad with a notebook computer. When you hold the pen near the display, you see a small cursor. Moving the pen moves the cursor.

- To click, tap once.
- To double-click, tap the display twice.
- To open a menu, tap the menu name, and then the menu item.
- To drag an item, such as a file or icon, touch the pen to the item and drag it to another destination on the display.
- There are two ways to right-click (to open a context-sensitive menu):
 - Hold down the right-click pen button and then tap the display. When you hold down the right-click pen button, the cursor is surrounded with a circle.

- Touch the pen on the screen and hold it in place momentarily until Windows draws a complete circle around the cursor. When the circle is complete, lift the pen to display the context menu. If you move or lift the pen before the circle is complete, the right-click action is cancelled.

To get help and practice using the pen as a mouse by using the online training and tutorials:

- In Windows Vista, click **Start**  → **All Programs** → **Tablet PC** → **Tablet PC Pen Training**, and then click **Using a pen instead of a mouse**.
- In Windows XP, click **Start** → **Get Going with Tablet PC**, and then click **Start**. This tutorial provides pen training.

Entering, Editing, and Erasing Text With the Pen

The handwriting recognition software makes it easy to enter text into your applications with the pen. Some applications, such as Windows Journal, allow you to write with the pen directly into the application window.

When an application does not directly support pen input, you can use the **Tablet PC Input Panel** to enter text into your application. If you tap in an editable area, the Tablet PC Input Panel icon appears. Tap the icon and the **Input Panel** slides out from the edge of the display. You can also open the **Input Panel** by tapping the Input Panel tab, which is docked at the edge of the screen when the **Input Panel** is hidden.

The **Input Panel** allows you to enter and edit text in different modes. You can write words just like you write on paper, you can write one character at a time, or you can "type" by tapping the pen on the keys of an image of a keyboard. To change the input mode, right-click the **QuickSet** icon in the Notification area, click **Pen and Input Settings** → **Input Mode**, and then select the desired input mode.

Edit text in the **Input Panel** using gestures, such as lining through text you want to delete, or tapping buttons.

Erase text in the **Input Panel** using the erase pen button, or by lining through text you want to delete.

To get help and practice writing and editing with **Input Panel**:

- In Windows Vista, click **Start**  → **All Programs** → **Tablet PC** → **Tablet PC Pen Training**, and tap each of the Input Panel topics.

- In Windows XP, click **Start** → **Get Going with Tablet PC** and then click **Start**. This tutorial provides Input Panel training. You can access additional tutorials by clicking **Start** → **All Programs** → **Tablet PC** → **Tablet PC Tutorials**.

Using Pen Flicks in Windows Vista

Pen flicks enable you to use the pen to perform actions that normally require a keyboard, such as pressing <Page Up> or using the directional arrow keys. Pen flicks are quick, directional gestures; you quickly draw a short line in one of eight directions. When a pen flick is recognized, the Tablet-PC performs the action assigned.

The horizontal and vertical pen flicks are, by default, assigned to navigational actions, corresponding to the keys <Left-Arrow>, <Right-Arrow>, <Page Up>, and <Page Down>. The default assignments for the diagonal pen flicks are editing actions: delete, copy, paste, and undo.

To customize pen flicks, click **Start**  → **Control Panel** → **Mobile PC** → **Pen and Input Devices** and click the **Flicks** tab. You can choose to turn pen flicks off, use the navigational pen flicks only, or use the navigational and editing pen flicks. You can also assign a new action to any of the eight pen flicks and adjust how easily your pen flicks are recognized.

To learn more about pen flicks and practice using them, click **Start**  → **All Programs** → **Tablet PC** → **Pen Flicks Training**.

Setting Pen Preferences

You can customize several pen behaviors in the operating system to help make using your Tablet-PC more comfortable. For example, if your double-taps are sometimes not recognized because you do not tap them fast enough, you can set a slower speed so that you have more time to tap.

In Windows Vista, you can customize the visual feedback that displays for each type of tap, and you can customize the actions assigned to pen flicks.

To access pen preferences and options:

- In Windows Vista, click **Start**  → **Control Panel** → **Mobile PC** → **Pen and Input Devices**.
- In Windows XP, click **Start** → **Control Panel** → **Printers and Other Hardware** → **Tablet and Pen Settings**.

The pen preferences and options you set are specific to the pen and the Tablet-PC.

Setting Pointer Device (Mouse) Preferences

Pointer device preferences, such as pointer speed, click speed, and pointer (mouse) trails, are set in the **Mouse Properties** window. These preferences apply to any pointer device in the system.

To access pointing device preferences:



- In Windows Vista, click **Start**  → **Control Panel** → **Hardware and Sound** → **Mouse**.
- In Windows XP, click **Start** → **Control Panel** → **Printers and Other Hardware** → **Mouse**.

Using Touch

Your Tablet-PC is able to distinguish between the pen and your fingertip (touch mode). When you use touch mode, a translucent image of a computer mouse, called the touch pointer, floats beneath your finger. The touch pointer has left and right mouse buttons that you can tap with your finger. You use the area beneath the buttons to drag the touch pointer.

Your Tablet-PC ships with a digitizer utility which you can use to set one of four modes for using touch:

- Pen only — Touch mode is disabled.
- Touch only — Pen input is disabled.
- Auto mode — If the pen is close to the display, pen mode is active. If the pen is not within range, double-tap the display with your finger to enter touch mode. Touch mode remains active until the pen is close to the display again.
- Dual mode — Microsoft Vista switches automatically between the pen and touch modes, based on its internal programming.

To access the digitizer utility from the Windows Notification area and set the input mode, right-click  in Windows Vista or  in Windows XP, click **Properties**, and then click the **Digitizer Options** tab. Click the radio button for the input mode you want to set, and click **Apply**.

In Windows Vista, to learn more about touch mode and practice using it, click **Start**  → **All Programs** → **Tablet PC** → **Tablet PC Touch Training**.

Accessing Management Tasks and User Information

You can use QuickSet, the Control Panel, Help and Support, and the Windows Vista Mobility Center to access online information, customize settings, and manage tasks.

QuickSet



NOTICE: If you uninstall QuickSet from your Tablet-PC you will also delete the tablet button drivers. To reinstall QuickSet and the tablet button drivers, go to support.dell.com.

QuickSet gives you easy access to settings and controls for customizing your Tablet-PC. You can access Dell QuickSet from the QuickSet icon in the Windows Notification area or through the **Windows Mobility Center**.

Depending on what you want to do, you can start QuickSet by either *clicking*, *double-clicking*, or *right-clicking* the QuickSet icon in the Windows Notification area.

The Windows Notification area is located in the lower-right corner of your screen.

Clicking the QuickSet Icon



NOTE: The following features may not be available on certain computers.

Click the QuickSet icon to:

- Control internal network adapter activity.
- Manage hot key pop-ups:
 - Enable or disable the appearance of the Brightness Meter on your screen.
 - Enable or disable the appearance of the Volume Meter on your screen.
 - Turn the Wireless Activity Indicator on or off.
 - Enable or disable hardware buttons on your Tablet-PC.

Double-Clicking the QuickSet Icon

Double-click the QuickSet icon to launch QuickSet and access the QuickSet launch panel. The main menu provides links to QuickSet features that help you configure settings for:

- Network connectivity
- Display settings
- System settings

Right-Clicking the QuickSet Icon

Right-click the QuickSet icon to:

- Select **Open** to launch QuickSet.
- View the Dell QuickSet Help file.
- View the version and copyright date of the QuickSet application program installed on your computer.
- Control Tablet-PC settings.

Control Panel

To access the Control Panel, click **Start**  (or **Start** in Windows XP) and then click **Control Panel**. The Control Panel contains several categories of tasks for managing your Tablet-PC. Clicking each category displays more information. To display these tasks as task icons, click **Switch to Classic View** in Windows XP or **Classic View** in Windows Vista.

Help and Support

To access Help and Support, click **Start**  (or **Start** in Windows XP) and then click **Help and Support**. Help and Support provides information for understanding how to manage your Tablet-PC.

Windows Vista Mobility Center

The **Windows Mobility Center** contains a set of tiles through which you can configure settings on your computer. There are additional tiles that have been customized by Dell.

You can access the **Windows Mobility Center** using any of the following methods:

- Double-click the QuickSet icon in the Windows Notification area and click **Mobility Center**.
- Click the **Start** button and point to the **Mobility Center**.
- Click **Start**→ **All Programs**→ **Accessories**, and point to **Mobility Center**.
- Right-click the battery icon in the Windows Notification area, and point to **Mobility Center**.
- Double-click the **Mobility Center** icon in the **Control Panel**.

You can access the QuickSet categories through the **Mobility Center**. Click one of the tiles, such as **Networking**, **Display Settings**, or **System Configuration**, in the **Customized by Dell Inc.** section, and the QuickSet application launches with the corresponding category open.

Using a Battery

 **CAUTION:** Using an incompatible battery may increase the risk of fire or explosion. Replace the battery only with a compatible battery purchased from Dell. The battery is designed to work with your Dell Tablet-PC. Do not use a battery from other Tablet-PCs with your Tablet-PC.

 **CAUTION:** Do not dispose of batteries with household waste. When your battery no longer holds a charge, call your local waste disposal or environmental agency for advice on disposing of a lithium-ion battery. See "Battery Disposal" in the *Product Information Guide*.

 **CAUTION:** Misuse of the battery may increase the risk of fire or chemical burn. Do not puncture, incinerate, disassemble, or expose the battery to temperatures above 65°C (149°F). Keep the battery away from children. Handle damaged or leaking batteries with extreme care. Damaged batteries may leak and cause personal injury or equipment damage.

Battery Performance

 **NOTE:** For information about the Dell warranty for your Tablet-PC, see the *Product Information Guide* or separate paper warranty document that shipped with your Tablet-PC.

For optimal Tablet-PC performance and to help preserve BIOS settings, operate your Dell™ Tablet-PC with the main battery installed at all times. One battery is supplied as standard equipment in the battery bay.

 **NOTE:** Because the battery may not be fully charged, use the AC adapter to connect your new Tablet-PC to an electrical outlet the first time you use the Tablet-PC. For best results, operate the Tablet-PC with the AC adapter until the battery is fully charged. To view battery charge status, check the Power Meter in Power Options (see "Accessing Power Options Properties" on page 79).

Battery operating time varies depending on operating conditions. You can use an optional battery slice (see "Battery Slice (Optional)" on page 217) to significantly increase operating time.

 **NOTE:** Battery operating time (the time the battery can hold a charge) decreases over time. Depending on how often the battery is used and the conditions under which it is used, you may need to purchase a new battery during the life of your Tablet-PC.

 **NOTE:** It is recommended that you connect your Tablet-PC to an electrical outlet when writing to a CD or DVD.



Operating time is significantly reduced when you perform operations including, but not limited to, the following:

- Using optical drives.
- Using wireless communications devices, ExpressCards, media memory cards, or USB devices.
- Using high-brightness display settings, 3D screen savers, or other power-intensive programs such as complex 3D graphics applications.
- Running the Tablet-PC in maximum performance mode. See "Configuring Power Management Settings" on page 79 for information about accessing Windows Power Options Properties or Dell QuickSet, which you can use to configure power management settings.

You can check the battery charge before you insert the battery into the Tablet-PC. You can also set power management options to alert you when the battery charge is low.

Checking the Battery Charge

The following features provide information on the battery charge:

- Dell QuickSet Battery Meter
- Microsoft Windows **Power Meter** window and **Power** icon ( in Windows Vista and  in Windows XP)
- Battery charge gauge and health gauge



- Low-battery warning

Dell™ QuickSet Battery Meter

If Dell QuickSet is installed, press <Fn><F3> to display the QuickSet Battery Meter. The Battery Meter displays status, battery health, charge level, and charge completion time for the battery in your Tablet-PC.

For more information about QuickSet, right-click the QuickSet icon in the Windows Notification area, and click **Help**.

Power Meter

The Power Meter indicates the remaining battery charge. To check the Power Meter, move your cursor over the **Power** icon ( in Windows Vista and  in Windows XP) in the Notification area to display the **Power** icon pop-up.

If the computer is connected to an electrical outlet, the **Power** icon pop-up displays the (plugged in charging) message.

Charge Gauge

By either pressing once or *pressing and holding* the status button on the charge gauge on the battery, you can check:

- Battery charge (check by pressing and *releasing* the status button)
- Battery health (check by pressing and *holding* the status button)

The battery operating time is largely determined by the number of times it is charged. After hundreds of charge and discharge cycles, batteries lose some charge capacity—or battery health. That is, a battery can show a status of "charged" but maintain a reduced charge capacity (health).

Check the Battery Charge

To check the battery charge, *press and release* the status button on the battery charge gauge to illuminate the charge-level lights. Each light represents approximately 20 percent of the total battery charge. For example, if the battery has 80 percent of its charge remaining, four of the lights are on. If no lights appear, the battery has no charge.

Check the Battery Health



NOTE: You can check battery health in one of two ways: by using the charge gauge on the battery as described below and by using the Battery Meter in Dell QuickSet. For information about QuickSet, right-click the icon in the Windows Notification area, and click **Help**.

To check the battery health using the charge gauge, *press and hold* the status button on the battery charge gauge for at least 3 seconds. If no lights appear, the battery is in good condition, and more than 80 percent of its original charge capacity remains. Each light represents incremental degradation. If five lights appear, less than 60 percent of the charge capacity remains, and you should consider replacing the battery.

Low-Battery Warning



NOTICE: To avoid losing or corrupting data, save your work immediately after a low-battery warning. Then connect the Tablet-PC to an electrical outlet, or dock the Tablet-PC onto an optional battery slice. If the battery runs completely out of power, hibernate mode begins automatically.

A pop-up window warns you when the battery charge is approximately 90 percent depleted. If both the main battery and the battery slice are installed, the low-battery warning means that the combined charge of both batteries is approximately 90 percent depleted. The Tablet-PC enters hibernate mode when the battery charge is at a critically low level.

You can change the settings for the battery alarms in **QuickSet** or the **Power Options Properties** window. See "Configuring Power Management Settings" on page 79 for information about accessing **QuickSet** or the **Power Options Properties** window.

Conserving Battery Power

Perform the following actions to conserve battery power:

- Connect the Tablet-PC to an electrical outlet when possible because battery life is largely determined by the number of times the battery is used and recharged.
- Place the Tablet-PC in sleep mode or hibernate mode when you leave the Tablet-PC unattended for long periods of time. See "Power Management Modes" on page 77.

- Use the Power Management Wizard or the **Power Options Properties** window to select options to optimize your computer's power usage. These options can also be set to change when you press the power button, close the display, or press <Fn><Esc>.



NOTE: See "Configuring Power Management Settings" on page 79 for information on conserving battery power.

Power Management Modes

Sleep Mode in Windows Vista

Sleep mode conserves power by turning off the display and the hard drive after a predetermined period of inactivity (a time-out). When the Tablet-PC exits sleep mode, it returns to the same operating state it was in before entering sleep mode.



NOTICE: If your Tablet-PC loses AC and battery power while in sleep mode, it may lose data.

To enter sleep mode in Windows Vista, click **Start** , and move your mouse over the right triangle beside the lock option to open the **Power Options Properties** window, and then click **Sleep**.

Depending on how you set the power management options in the **Power Options Properties** window or the QuickSet Power Management Wizard, you may also use one of the following methods:

- Press the power button
- Close the display
- Press <Fn><Esc>

To exit sleep mode, press the power button or open the display, depending on how you set the power management options. You cannot make the Tablet-PC exit sleep mode by pressing a key or touching the touch pad or track stick.

Hibernate Mode

Hibernate mode conserves power by copying system data to a reserved area on the hard drive and then completely turning off the Tablet-PC. When the Tablet-PC exits hibernate mode, it returns to the same operating state it was in before entering hibernate mode.



NOTICE: You cannot remove devices or undock your Tablet-PC while your Tablet-PC is in hibernate mode.

Your Tablet-PC enters hibernate mode if the battery charge level becomes critically low.

To Manually Enter Hibernate Mode in Windows Vista

Click **Start** , and move your mouse over the right triangle beside the Lock icon to open the **Power Options Properties** window, and then click **Hibernate**.



NOTE: In Windows Vista, if your Tablet-PC has **Hybrid Sleep** enabled, then **Hibernate** is not displayed.

To Manually Enter Hibernate Mode in Windows XP

To manually enter hibernate mode in Windows XP, you must enable hibernate mode.

To enable hibernate mode:

- 1 Click **Start**→ **Control Panel**→ **Performance and Maintenance**→ **Power Options**.
- 2 Click the **Hibernate** tab.
- 3 Select **Enable hibernation**.
- 4 Click **Apply** and **Ok**.

To enter hibernate mode:

- 1 Press the <Ctrl><Alt> key combination.
- 2 Select **Shut Down**→ **Hibernate**.

Alternative Methods for Entering Hibernate Mode

Depending on how your power management options are set, you can also use one of the following methods to enter hibernate mode:

- Press the power button
- Close the display
- Press <Fn><Esc>



NOTE: Some ExpressCards may not operate correctly after the Tablet-PC exits hibernate mode. Remove and reinsert the card (see "Removing an ExpressCard" on page 91), or simply restart (reboot) your Tablet-PC.

To Exit Hibernate Mode

To exit hibernate mode, press the power button. The Tablet-PC may take a short time to exit hibernate mode. You cannot make the Tablet-PC exit hibernate mode by pressing a key or touching the touch pad or track stick. For more information on hibernate mode, see the documentation that came with your operating system.

Configuring Power Management Settings

You can use the QuickSet Power Management Wizard or Windows Power Options Properties to configure the power management settings on your Tablet-PC. For more information about QuickSet, right-click the QuickSet icon in the Windows Notification area and click **Help**.

Accessing Power Options Properties

- Click the Windows **Power**  icon in the Notification area to display the **Power** icon pop-up window.
- Select one of the following from the **Select a Power Plan** section:
 - **Dell Recommended**
 - **Power Saver**
 - **High Performance**
 - Any custom power plan you have created
- To access additional power options, click **More Power Options** at the bottom of the pop-up.

Charging the Main Battery

When you connect the Tablet-PC to an electrical outlet or install a battery while the Tablet-PC is connected to an electrical outlet, the Tablet-PC checks the battery charge and temperature. If necessary, the AC adapter then charges the battery and maintains the battery charge.

 **NOTE:** With Dell™ ExpressCharge™, when the Tablet-PC is turned off, the AC adapter charges a completely discharged battery to 80 percent in about 1 hour and to 100 percent in approximately 2 hours. Charge time is longer with the Tablet-PC turned on. You can leave the battery in the Tablet-PC for as long as you like. The battery's internal circuitry prevents the battery from overcharging.

If the battery is hot from being used in your Tablet-PC or being in a hot environment, the battery may not charge when you connect the Tablet-PC to an electrical outlet.

The battery is too hot to start charging if the  light flashes alternately green and orange. Disconnect the Tablet-PC from the electrical outlet and allow the Tablet-PC and the battery to cool to room temperature. Then connect the Tablet-PC to an electrical outlet to continue charging the battery.

For information about resolving problems with a battery, see "Power Problems" on page 133.

Removing the Main Battery



CAUTION: Using an incompatible battery may increase the risk of fire or explosion. Replace the battery only with a compatible battery purchased from Dell. The battery is designed to work with your Dell™ Tablet-PC. Do not use a battery from other Tablet-PCs or computers with your Tablet-PC.



CAUTION: Before performing these procedures, turn off the Tablet-PC, disconnect the AC adapter from the electrical outlet and the Tablet-PC, disconnect any modem from the wall connector and Tablet-PC, and remove any other external cables from the Tablet-PC.



NOTICE: You must remove all external cables from the Tablet-PC to avoid possible connector damage.

To remove the battery:

- 1 If the Tablet-PC is connected to a docking device such as the optional media base or battery slice (docked), undock it. See "Undocking Your Tablet-PC From the Media Base" on page 212 or "Undocking Your Tablet-PC From the Battery Slice" on page 220.
- 2 Ensure that the Tablet-PC is turned off or suspended in a power management mode.
- 3 Slide the battery-bay latch releases on the bottom of the Tablet-PC, and then remove the battery from the bay.

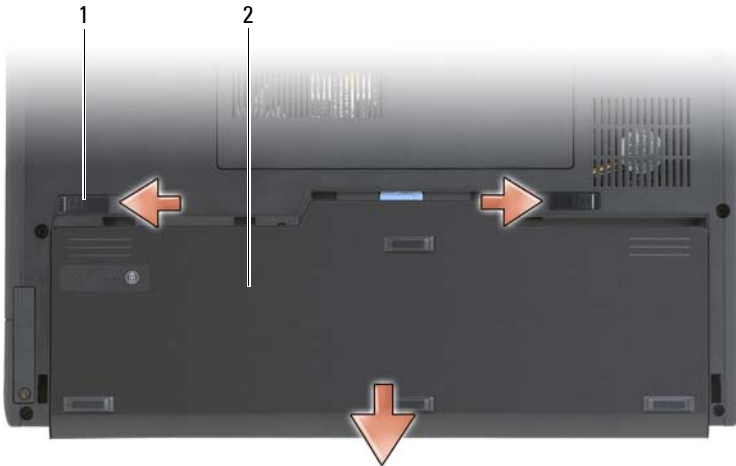

- 1 battery release latches (2) 2 battery

Installing the Main Battery

- 1 If the Tablet-PC is connected to a docking device such as the optional media base or battery slice (docked), undock it. See "Undocking Your Tablet-PC From the Media Base" on page 212 or "Undocking Your Tablet-PC From the Battery Slice" on page 220.
- 2 Turn the Tablet-PC upside-down.
- 3 Align the battery with the battery bay sides, then slide the battery into the bay and ensure that the two latch releases engage.

Storing a Battery

Remove the battery when you store your Tablet-PC for an extended period of time. A battery discharges during prolonged storage. After a long storage period, recharge the battery fully (see "Charging the Main Battery" on page 79) before you use it.

Using a Keyboard

Numeric Keypad

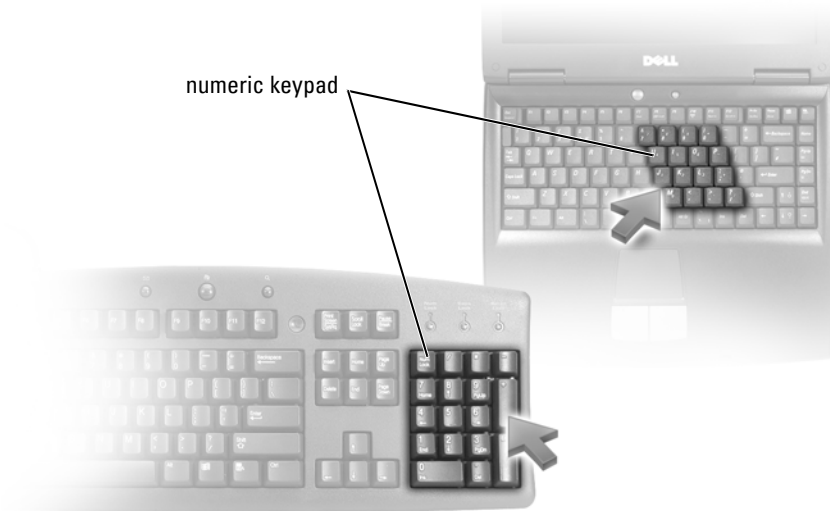

The numeric keypad functions like the numeric keypad on an external keyboard. Each key on the keypad has multiple functions. The keypad numbers and symbols are marked in blue on the right of the keypad keys. To type a number or symbol, hold down <Fn> and press the desired key.

- To enable the keypad, press <Num Lk> in Windows Vista or <Fn><Num Lk> in Windows XP.
- To disable the keypad, press <Num Lk> or <Fn><Num Lk> again.

Key Combinations

System Functions

<Ctrl><Shift><Esc>	Opens the Task Manager window.
--------------------	---------------------------------------

Battery

<Fn><F3>	Displays the Dell™ QuickSet Battery Meter.
----------	--

Display Functions

<Fn><F8>	Switches the video image to the next display option. The options include the integrated display, an external monitor, and both displays simultaneously.
<Fn><F7>	Scales between wide-screen and standard aspect ratio video resolutions.
<Fn> and left-arrow key	Activates the ambient light sensor, which controls brightness of the display based on light level in the current environment.
<Fn> and up-arrow key	Increases brightness on the integrated display only (not on an external monitor).
<Fn> and down-arrow key	Decreases brightness on the integrated display only (not on an external monitor).

Power Management

<Fn><Esc>	Activates a power management mode. You can reprogram this keyboard shortcut to activate a different power management mode using the Advanced tab in the Power Options Properties window.
<Fn><F1>	Puts the Tablet-PC into hibernate mode. Dell QuickSet is required (see "QuickSet" on page 71).

Speaker Functions

<Fn><Insert>	Increases the volume of the integrated speakers and external speakers, if attached.
<Fn><End>	Decreases the volume of the integrated speakers and external speakers, if attached.
<Fn><Delete>	Enables and disables the integrated speakers and external speakers, if attached.

Microsoft® Windows® Logo Key Functions



NOTE: Some of the following key functions only apply to Windows Vista.

Windows logo key and <Tab>	Cycle through programs on the Windows Notification area by using Windows Flip 3-D (only if using the Aero™ interface).
<Ctrl> and Windows logo key and <Tab>	Use the arrow keys to cycle through programs on the Windows Notification area by using Windows Flip 3-D (only if using the Aero™ interface).
Windows logo key and spacebar	Bring all gadgets to the front and select Windows Sidebar (if using Windows Sidebar).
Windows logo key and <g>	Cycles through Windows Sidebar gadgets (if using Windows Sidebar).
Windows logo key and <u>	Opens the Ease of Access Center .
Windows logo key and <x>	Opens the Windows Mobility Center .
Windows logo key and any number key	Opens the Quick Launch shortcut that is in the position that corresponds to the number. For example, use the Windows logo key and <1> to launch the first shortcut in the Quick Launch menu.
Windows logo key and <m>	Minimizes all open windows.
Windows logo key and <Shift><m>	Restores all minimized windows. This key combination functions as a toggle to restore minimized windows following the use of the Windows logo key and <m> key combination.
Windows logo key and <e>	Runs Windows Explorer.
Windows logo key and <r>	Opens the Run dialog box.
Windows logo key and <f>	Opens the Search Results dialog box.
Windows logo key and <Ctrl><f>	Opens the Search Results-Computer dialog box (if the Tablet-PC is connected to a network).
Windows logo key and <Fn><F12>	Opens the System Properties dialog box.

To adjust keyboard operation, such as the character repeat rate:

- In Windows Vista, click **Control Panel**→ **Hardware and Sound**, and either click **Keyboard** or click one of the two options under the **Keyboard** link.
- In Windows XP, click **Control Panel**→ **Printers and Other Hardware**→ **Keyboard**.

For information about the Control Panel, see Windows Help and Support. To access Help and Support, click **Start**  (or **Start** in Windows XP)→ **Help and Support**.

Touch Pad

The touch pad detects the pressure and movement of your finger to allow you to move the cursor on the display. Use the touch pad and touch pad buttons as you would use a mouse.



1 touch pad

2 touch pad buttons

- To move the cursor, lightly slide your finger over the touch pad.
- To select an object, lightly tap once on the surface of the touch pad or use your thumb to press the left touch pad button.
- To select and move (or drag) an object, position the cursor on the object and tap twice on the touch pad. On the second tap, leave your finger on the touch pad and move the selected object by sliding your finger over the surface.
- To double-click an object, position the cursor on the object and tap twice on the touch pad or use your thumb to press the left touch pad button twice.

You can also use the track stick to move the cursor. Press the track stick left, right, up, or down to change the direction of the cursor on the display. Use the track stick and track stick buttons as you would use a mouse.

Customizing the Touch Pad and Track Stick or Pointer

You can use the Control Panel mouse options to adjust settings for the mouse and the track stick (Windows Vista) or pointer (Windows XP).

- In Windows Vista, click **Control Panel**→ **Mouse**.
- In Windows XP, click **Control Panel**→ **Printers and Other Hardware**→ **Mouse**.

Changing the Track Stick or Pointer Cap

You can replace your track stick or pointer cap if it wears down from prolonged use or if you prefer a different color. You can purchase additional caps by visiting the Dell website at dell.com.



- 1 Pull the cap off the track stick.
 - 2 Align the new cap over the square track-stick post and gently press the cap down onto the post.
- ➔ **NOTICE:** The track stick cap can damage the display if it is not properly seated on the post.
- 3 Test the track stick to ensure that the cap is seated properly.

Using the Display

Your Tablet-PC has two display options available:

- LED backlit thin-and-light LCD (optimized for indoor viewing)
- Dual-bulb (CCFL) LCD (optimized for outdoor viewing)

Depending on which display option you selected, how you adjust the brightness on your display will differ.

Adjusting Brightness on the LED Backlit Thin-and-Light LCD

When a Dell Tablet-PC equipped with the LED backlit thin-and-light LCD display is running on battery power, you can conserve power by setting the display brightness to the lowest comfortable setting by pressing <Fn> and the up- or down-arrow key on the keyboard.

 **NOTE:** Brightness key combinations only affect the display on your Tablet-PC, not monitors or projectors that you attach to your Tablet-PC or docking device. If your Tablet-PC is connected to an external monitor and you try to change the brightness level, the Brightness Meter may appear, but the brightness level on the external device does not change.

You can press the following keys to adjust display brightness:

- Press <Fn> and the up-arrow key to increase brightness on the integrated display only (not on an external monitor).
- Press <Fn> and the down-arrow key to decrease brightness on the integrated display only (not on an external monitor).

 **NOTE:** If your operating system display default is set to a specific value, you may have to reset your manual selections after using sleep, standby, or hibernate mode.

Adjusting Brightness on the Dual-bulb (CCFL) LCD

The Dual-bulb LCD includes an integrated ambient light sensor (see "Front View" on page 27).



1 ambient light sensor

The ambient light sensor is located on the front of the Tablet-PC display. The sensor detects available environmental light and automatically increases or decreases the display backlighting to compensate for low-light and high-light environments.

You can enable or disable the ambient light sensor feature by pressing the <Fn> and left-arrow key combination.



NOTE: Do not cover the ambient light sensor with any adhesive labels. If covered up, the sensor—when enabled—automatically sets the display brightness to the minimum level.

The ambient light sensor is disabled when your Tablet-PC is shipped to you. If you enable the sensor and then use any of the display brightness key combinations, the sensor is disabled and the display brightness is increased or decreased accordingly.

Dell QuickSet allows you to enable or disable the ambient light sensor feature. You can also adjust maximum and minimum brightness settings that are activated when you enable the ambient light sensor feature. For more information about QuickSet, right-click the QuickSet icon in the Windows Notification area, and click **Help**.



NOTE: Rebooting the Tablet-PC returns the ambient light sensor to the setting it was before it was adjusted.



NOTE: The ambient light sensor adjusts the display backlighting on your Tablet-PC display only. It does not control the brightness on any external monitors or projectors.

Using Cards

ExpressCards

ExpressCards provide additional memory, wired and wireless communications, multimedia, and security features. ExpressCards support two form factors:

- ExpressCard/34 (34-mm wide)
- ExpressCard/54 (54-mm wide in an L-shape with a 34-mm connector)

The 34-mm card fits into both the 34-mm and 54-mm card slots. The 54-mm card only fits into a 54-mm card slot.

 **NOTE:** An ExpressCard is not a bootable device.

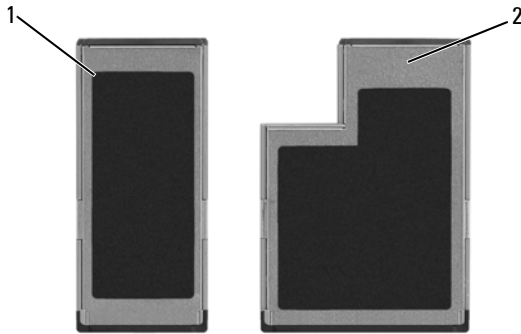

1 ExpressCard/34

2 ExpressCard/54

Installing an ExpressCard

You can install an ExpressCard while the Tablet-PC is running. The Tablet-PC automatically detects the card.

ExpressCards are generally marked with a symbol (such as a triangle or an arrow) or a label to indicate which end to insert into the slot. The cards are keyed to prevent incorrect insertion. If card orientation is not clear, see the documentation that came with the card.

 **CAUTION:** Before you begin any of the procedures in this section, follow the safety instructions in the *Product Information Guide*.

To install an ExpressCard:

- 1 Hold the card with the top side of the card facing up.
- 2 Slide the card into the slot until the card is completely seated in its connector.

If you encounter too much resistance, do not force the card. Check the card orientation and try again.



The Tablet-PC recognizes the ExpressCard and automatically loads the appropriate device driver. If the configuration program tells you to load the manufacturer's drivers, use the CD that came with the ExpressCard.

Removing an ExpressCard

⚠ CAUTION: Before you begin any of the procedures in this section, follow the safety instructions in the *Product Information Guide*.

Press the card into the slot to eject the card.



Smart Cards

📄 NOTE: You can use smart cards with your Tablet-PC only if you have also purchased the optional smart-card reader that installs into the ExpressCard slot.

About Smart Cards

Smart cards are portable credit-card shaped devices with internal integrated circuits. The top surface of the smart card usually contains an embedded processor under the gold contact pad. The combination of the small size and integrated circuits make smart cards valuable tools for security, data storage, and special programs. Using smart cards can improve system security by combining something a user has (the smart card) with something only the user should know (a PIN) to provide more secure user-authentication than passwords alone.

For more information about how to secure your Tablet-PC, see "Securing Your Tablet-PC" on page 111.

Installing a Smart Card

You can install a smart card in the Tablet-PC while the Tablet-PC is running. The Tablet-PC automatically detects the card.

To install a smart card:

 **NOTE:** You can use smart cards with your Tablet-PC only if you have also purchased the optional smart-card reader that installs into the ExpressCard slot.

- 1 Hold the card so that the gold contact pad is facing upward and pointing toward the smart-card reader's slot.

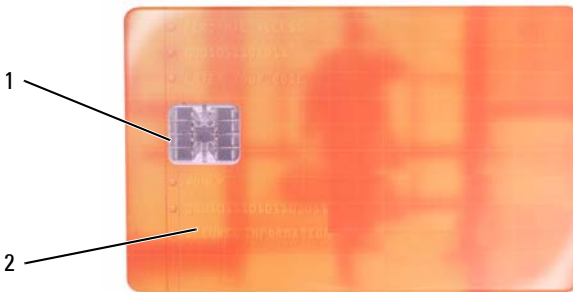

1 gold contact pad

2 smart card (top)

- 2 Slide the smart card into the smart card slot until the card is completely seated in its connector. The smart card will protrude approximately 1/2 inch from the slot.

If you encounter too much resistance, do not force the card. Check the card orientation and try again.

Secure Digital (SD) Cards

Secure Digital (SD) cards are storage media used in portable devices such as digital cameras, handheld computers, PDAs, and GPS units.

Installing an SD Card

- 1 Hold the card so that the gold contact pad is facing upward and pointing toward the SD card slot. The SD card slot is located above the ExpressCard slot.
- 2 Slide the SD card into the SD card slot until the card is completely seated in its connector. The SD card will protrude approximately 1/2 inch from the slot.

If you encounter too much resistance, do not force the card. Check the card orientation and try again.



Using Your Tablet-PC With a Projector

You can use the Tablet-PC display in the notebook or tablet position and set the display orientation to either landscape or portrait. The position and orientation of the Tablet-PC display affect how a projector displays the image from the Tablet-PC. In addition to the display position and orientation, you can adjust the projected image using the Tablet-PC clone and extended desktop modes.

Display Positions

Your Tablet-PC display operates in two positions: classic notebook and tablet.

Classic Notebook

Classic notebook is the standard position with the display raised above the keyboard and touch pad. In this position, the display has a landscape orientation and you use the keyboard and touch pad as input devices.

Tablet

To use your Tablet-PC in tablet position, raise the display and rotate it 180 degrees, and then fold the display over the keyboard with the display facing upwards. In this position, you use either touch or the digitizer pen as input devices; that is, you touch the screen with either your finger or the digitizer pen.

In tablet position, the display image has a portrait orientation. You can switch the display image between portrait and landscape orientation using the Screen Rotate button. See "Using Tablet Buttons" on page 62 for more information on the Screen Rotate button.

 **NOTE:** When the Tablet-PC display has a portrait orientation and you are using clone mode, the projector displays an image that is rotated sideways and not viewable. To correct the displayed image, change the Tablet-PC display to landscape orientation using the Screen Rotate button or use the projector's menu options or other features to rotate the displayed image. See "Using Tablet Buttons" on page 62 for more information on the Screen Rotate button.

Display Modes

The Tablet-PC includes the clone and extended desktop modes for adjusting the image displayed by a projector.

Clone Mode (Mirrored)

The clone mode enables the projector to display the exact image that is on the Tablet-PC display. In clone mode, the projector displays mouse cursor movement and handwriting or drawing with the digitizer pen. Clone mode is useful when using the mouse cursor as a pointing device or when you want the projector to display user activity that is occurring on the Tablet-PC.

 **NOTE:** When you initially connect the Tablet-PC to a projector, the Microsoft Windows operating system asks you to specify default display settings. To enable clone mode, select **Duplicate my desktop on all displays (mirrored)**. To send the Tablet-PC display to the projector, use the <Fn><F8> key combination. You can change the default display settings at a later time.

Considerations for Using Portrait or Landscape Orientation in Clone Mode

Because clone mode displays the exact image from the Tablet-PC, using the landscape or portrait orientation affects the image displayed by the projector. Landscape is the typical orientation in clone mode and is displayed normally by the projector.

When the Tablet-PC display is in tablet position and you are using a portrait orientation in clone mode, the projector displays an image that is rotated sideways and not viewable. To correct the projected image you can:

- Use the Screen Rotate button to change the Tablet-PC display to landscape orientation. See "Using Tablet Buttons" on page 62 for more information on the Screen Rotate button.
- Use the projector's menu options or other features to rotate the projected image.

Considerations for Display Resolution and Aspect Ratio in Clone Mode

If the projector has a lower display resolution and aspect ratio than the Tablet-PC display, then the Tablet-PC graphics subsystem uses the lowest display resolution and aspect ratio. Changing to a lower display resolution and aspect ratio alters the image quality.

For example, if the Tablet-PC has a display resolution of 1280 x 800 pixels with a 16:10 aspect ratio and the projector is using a 1024 x 768 display resolution with a 4:3 aspect ratio, then you may notice that:

- The projected image is not as sharp as it would be with a 1280 x 800 display resolution. The loss of sharpness is particularly noticeable when reading text.
- Round objects appear flattened. This alteration is a result of shifting from the 16:10 to the 4:3 aspect ratio.

Extended Desktop Mode

Extended desktop mode enables you to configure two displays that each have their own attributes. You can use the Tablet-PC display in tablet mode with portrait orientation using a 1280 x 800 resolution, and the projector can use the standard landscape orientation at a lower resolution and aspect ratio.

When using extended desktop mode, you start applications on the Tablet-PC and then "drag" the applications that you want to be viewed from the projector to the extended desktop. Extended desktop mode is useful when you want to maintain user activity on the Tablet-PC without displaying this activity with the projector.



NOTE: When you initially connect the Tablet-PC to a projector, the Windows operating system asks you to specify default display settings. To enable extended desktop mode, select **Show different parts of my desktop on each display (extended)**. To send the Tablet-PC display image to the projector, use the <Fn><F8> key combination. You can then "drag" the applications you want to project from the Tablet-PC to the extended desktop (the projector). You can change the default display settings at a later time.

Changing the Display Settings for the Projector

To change the default display settings:

- 1 Open the ATI CATALYST® Control Center:

- In Windows® Vista®, right-click the desktop and select **ATI CATALYST® Control Center**.
 - In Windows XP, select **Start→ All Programs→ Catalyst Control Center→ Advanced→ Catalyst Control Center - Advanced**.
- 2** Select **Displays Manger** under **Graphics Settings**.
The projector is displayed as an icon in the right-hand pane under **Desktop and Display Setup**.
 - 3** Right-click the projector icon and select **Clone Desktop 1 with monitor** for clone mode or **Extend Main onto monitor** for extended desktop mode.

Afterwards, you may access these settings by using the <Fn><F8> key combination.

Setting Up and Using Networks

Setting up a computer network provides connectivity between your Tablet-PC and the Internet, another computer, or a network. For example, with a network set up in a home or small office you can print to a shared printer, access drives and files on another computer, browse other networks, or access the Internet. You can set up a local area network (LAN) using a network or broadband modem cable or set up a wireless LAN (WLAN).

Microsoft Windows provides a wizard to help guide you through the process of networking computers. For more information about networking, see "Windows Help and Support" on page 19.

Connecting a Network or Broadband Modem

Before you connect your Tablet-PC to a network, the Tablet-PC must have a network adapter installed and a network cable connected to it.

- 1 Connect the network cable to the network adapter connector on the back of your Tablet-PC.



NOTE: Insert the cable connector until it clicks into place, and then gently pull the cable to ensure that it is securely attached.

- 2 Connect the other end of the network cable to a network connection device or a network wall connector.



NOTE: Do not use a network cable with a telephone wall connector.



Network Setup Wizard

Windows Vista

- 1 Click **Start**  and then click **Connect To** → **Set up a connection or network**.
- 2 Select an option under **Choose a connection option**.
- 3 Click **Next**, and then follow the instructions in the wizard.

Windows XP

- 1 Click **Start** and then click **Control Panel**.
- 2 Click **Network and Internet Connections**.
- 3 Select a network setup task and follow the instructions in the wizard.

Wireless Local Area Network (WLAN)

A WLAN is a series of interconnected computers that communicate with each other over the air waves rather than through a network cable connected to each computer. In a WLAN, a radio communications device called an access point or wireless router connects network computers and provides Internet, or network, access. The access point or wireless router and the wireless network adapter in the computer or Tablet-PC communicate by broadcasting data from their antennas over the air waves.

What You Need to Establish a WLAN Connection

Before you can set up a WLAN, you need:

- High-speed (broadband) Internet access (such as cable or DSL)
- A broadband modem that is connected and working
- A wireless router or access point
- A wireless network adapter for each computer or Tablet-PC that you want to connect to your WLAN
- A network cable with a network (RJ-45) connector

Checking Your Wireless Network Adapter

Depending on what you selected when you purchased your Tablet-PC, the Tablet-PC has a variety of configurations. To confirm that your Tablet-PC has a wireless network adapter and to determine the type of card, use one of the following:

- The Windows **Start** button ( in Windows Vista) and the **Connect To** option
- The order confirmation for your Tablet-PC

Start Button and Connect To Option

To view your wireless network adapter:

- In Windows Vista, click **Start**  → **Connect To** → **View network computers and devices**.
- In Windows XP, click **Start** → **Connect To** → **Wireless Network Connection**.

If Wireless Network Connection does not appear, your Tablet-PC may not have a wireless network adapter installed.

If Wireless Network Connection appears, you have a wireless network adapter. To view detailed information about the wireless network adapter:



- 1** Right-click **Wireless Network Connection**.
- 2** Click **Properties**.

The **Wireless Network Connection Properties** window appears. The wireless network adapter's name and model number are listed on the **General** tab.

The Order Confirmation for Your Tablet-PC

The order confirmation that you received when you ordered your Tablet-PC lists the hardware and software that shipped with your Tablet-PC.

Setting Up a New WLAN Using a Wireless Router and a Broadband Modem

- 1 Contact your Internet service provider (ISP) to obtain specific information about the connection requirements for your broadband modem.
 - 2 Ensure that you have wired Internet access through your broadband modem before you attempt to set up a wireless Internet connection (see "Connecting a Network or Broadband Modem" on page 99).
 - 3 Install any software required for your wireless router. Your wireless router may have been shipped with an installation media. Installation media usually contains installation and troubleshooting information. Install the required software according to the instructions provided by the router manufacturer.
 - 4 Shut down your Tablet-PC and any other wireless-enabled computers in the vicinity through the Windows **Start** button ( in Windows Vista) menu.
 - 5 Disconnect your broadband modem power cable from the electrical outlet.
 - 6 Disconnect the network cable from the Tablet-PC and the broadband modem.
 - 7 Disconnect the AC adapter cable from your wireless router to ensure that there is no power connected to the router.
-  **NOTE:** Wait for a minimum of 5 minutes after disconnecting your broadband modem before you continue with the network setup.
- 8 Insert a network cable into the network (RJ-45) connector on the unpowered broadband modem.
 - 9 Connect the other end of the network cable into the Internet network (RJ-45) connector on the unpowered wireless router.
 - 10 Ensure that no network or USB cables, other than the network cable connecting the broadband modem and the wireless router, are connected to the broadband modem.

 **NOTE:** Restart your wireless equipment in the order described below to prevent a potential connection failure.

- 11 Turn on *only* your broadband modem and wait for at least 2 minutes for the broadband modem to stabilize. After 2 minutes, proceed to step 12.
- 12 Turn on your wireless router and wait for at least 2 minutes for the wireless router to stabilize. After 2 minutes, proceed to the step 13.
- 13 Start your Tablet-PC and wait until the boot process completes.
- 14 See the documentation that came with your wireless router to do the following in order to set up the wireless router:
 - a Establish communication between your Tablet-PC and your wireless router.
 - b Configure your wireless router to communicate with your broadband router.
 - c Find out your wireless router's broadcast name. The technical term for the name of your router's broadcast name is Service Set Identifier (SSID) or network name.
- 15 If necessary, configure your wireless network adapter to connect to the wireless network (see "Connecting to a WLAN" on page 103).

Connecting to a WLAN

 **NOTE:** Before you connect to a WLAN, ensure that you have followed the instructions in "Wireless Local Area Network (WLAN)" on page 100.

 **NOTE:** The following networking instructions do not apply to internal cards with Bluetooth® wireless technology or cellular products.

This section provides general procedures for connecting to a network using wireless technology. Specific network names and configuration details vary. See "Wireless Local Area Network (WLAN)" on page 100 for more information about how to prepare for connecting your Tablet-PC to a WLAN.

Your wireless network adapter requires specific software and drivers for connecting to a network. The software is already installed.

 **NOTE:** If the software is removed or corrupted, follow the instructions in the user documentation for your wireless network adapter. Verify the type of wireless network adapter installed in your Tablet-PC and then search for that name on the

Dell™ Support website at support.dell.com. For information on the type of wireless network adapter that is installed in your Tablet-PC, see "Checking Your Wireless Network Adapter" on page 101.

Determining the Wireless Network Device Manager

Depending on the software installed on your Tablet-PC, different wireless configuration utilities may manage your network devices:

- Your wireless network adapter's client utility
- The operating system

To determine which wireless configuration utility is managing your wireless network adapter:

- In Windows Vista, click **Start**  → **Connect To** → **Manage wireless networks**. Double-click a profile to open the wireless network properties screen.
- In Windows XP, click **Start** → **All Programs** → **Dell Wireless** → **Dell Wireless WLAN Card Utility**.

For specific information about the wireless configuration utility installed on your Tablet-PC, see your wireless network documentation in "Windows Help and Support" on page 19.

Completing the Connection to the WLAN

When you turn on your Tablet-PC and a network (for which your Tablet-PC is not configured) is detected, a pop-up appears in the lower-right corner of the Windows desktop.

Follow any instructions that appear on your screen.

Once you have configured your Tablet-PC for the wireless network that you selected, another pop-up notifies you that your Tablet-PC is connected to that network.

Thereafter, whenever you log on to your Tablet-PC within the range of the wireless network that you selected, the same pop-up notifies you of the wireless network connection.



NOTE: If you select a secure network, you must enter a WEP or WPA key when prompted. Network security settings are unique to your network. Dell cannot provide this information.



NOTE: Your Tablet-PC can take up to 1 minute to connect to the network.

Monitoring the Status of the Wireless network adapter Through Dell QuickSet

The wireless activity indicator provides you with an easy way to monitor the status of your Tablet-PC's wireless devices. To turn the wireless activity indicator on or off, click the QuickSet icon in the taskbar and select **Hotkey Popups**. If **Wireless Activity Indicator Off** is not checked, the indicator is on. If **Wireless Activity Indicator Off** is checked, the indicator is off.

The wireless activity indicator displays whether your Tablet-PC's integrated wireless devices are enabled or disabled. When you turn the wireless networking function on or off, the wireless activity indicator changes to display the status.

For more information about the Dell QuickSet wireless activity indicator, right-click the QuickSet icon in the taskbar and select **Help**.

Mobile Broadband/Wireless Wide Area Network (WWAN)

A Mobile Broadband network, also known as a wireless wide area network (WWAN), is a high-speed digital cellular network that provides Internet access over a much wider geographical area than a WLAN, which typically covers only from 100 to 1000 feet. Your Tablet-PC can maintain Mobile Broadband network access as long as the Tablet-PC is within a cellular-data coverage zone. Contact your service provider for coverage of a high-speed digital cellular network.

 **NOTE:** Even if you are able to make a call from your cellular phone in a specific geographical location, that location may not necessarily be within a cellular-data coverage zone.

What You Need to Establish a Mobile Broadband Network Connection

 **NOTE:** Depending on your Tablet-PC, you can use either a Mobile Broadband ExpressCard or Mini-Card, but not both, to establish a Mobile Broadband network connection.

To set up a Mobile Broadband network connection, you need:

- A Mobile Broadband ExpressCard or Mini-Card (depending on your Tablet-PC's configuration)

 **NOTE:** For instructions on using ExpressCards, see "ExpressCards" on page 89

- An activated Mobile Broadband ExpressCard or activated Subscriber Identity Module (SIM) for your service provider
- An extended whip antenna.



- The Dell Mobile Broadband Card Utility (already installed on your Tablet-PC if you purchased the card when you purchased your Tablet-PC, or on the CD that accompanied your card if purchased separately from your Tablet-PC)

If the utility is corrupted or deleted from your Tablet-PC, see the Dell Mobile Broadband Card Utility user's guide for instructions. The user's guide is available through Windows Help and Support (see "Windows Help and Support" on page 19) or on the CD that accompanied your card if you purchased it separately from your Tablet-PC.

Checking Your Dell Mobile Broadband Card

Depending on what you selected when you purchased your Tablet-PC, the Tablet-PC has a variety of configurations. To determine the type of Mobile Broadband card installed on your Tablet-PC, see one of the following:

- Your order confirmation
- Microsoft Windows Help and Support or My Computer.

Windows Vista

- 1 Click Start  → Help and Support → Use Tools to view your computer information and diagnose problems.
- 2 Under Tools, click My Computer Information → Find information about the hardware installed on this computer.

On the My Computer Information - Hardware screen, you can view the type of Mobile Broadband card installed in your Tablet-PC as well as other hardware components.



NOTE: The Mobile Broadband card is listed under **Modems**.

Windows XP

- 1 Click Start → My Computer → View System Information.
- 2 Click the **Hardware** tab.
- 3 Click **Device Manager**. The Device Manager displays the hardware components installed on the system.

Connecting to a Mobile Broadband Network



NOTE: These instructions only apply to Mobile Broadband ExpressCards or Mini-Cards. They do not apply to internal cards with wireless technology.



NOTE: Before you connect to the Internet, you must activate Mobile Broadband service through your cellular service provider. For instructions and for additional information about using the Dell Mobile Broadband Card Utility, see the user's guide available through Windows Help and Support (see "Windows Help and Support" on page 19). The user's guide is also available on the Dell Support website at support.dell.com and on the CD included with your Mobile Broadband card, if you purchased the card separately from your Tablet-PC.

Use the Dell Mobile Broadband Card Utility to establish and manage a Mobile Broadband network connection to the Internet:

- 1 Click the Dell Mobile Broadband Card Utility icon  on the Windows desktop, to run the utility.
- 2 Click **Connect**.



NOTE: The **Connect** button changes to the **Disconnect** button.

- 3 Extend the external whip antenna and adjust orientation to achieve optimal signal strength.

- 4 Follow the instructions on the screen to manage the network connection with the utility.

Or

- 1 Click **Start**  (or **Start** in Windows XP) → **All Programs** → **Dell Wireless**.
- 2 Select the option for Broadband and follow the instructions on the screen.
- 3 Extend the external whip antenna and adjust orientation to achieve optimal signal strength.

Enabling/Disabling the Dell Mobile Broadband Card



NOTE: If you are unable to connect to a Mobile Broadband network, ensure that you have all the components for establishing a Mobile Broadband connection (see "What You Need to Establish a Mobile Broadband Network Connection" on page 105), and then verify that your Mobile Broadband card is enabled by verifying the setting of the wireless switch.

You can turn your Tablet-PC's wireless devices on and off with the wireless switch on the left side of the Tablet-PC (see "Left Side View" on page 32).

If the switch is in the "on" position, move the switch to the "off" position to disable the switch and the Mobile Broadband card. If the switch is in the "off" position, move the switch to the "on" position to enable the switch and the Dell Mobile Broadband card. For information about the wireless switch positions, see "Dell Wi-Fi Catcher™ Network Locator" on page 109.

To monitor the status of your wireless device, see "Monitoring the Status of the Wireless network adapter Through Dell QuickSet" on page 105.

Managing Your Network Settings Through the Dell QuickSet Location Profiler

The Dell QuickSet Location Profiler helps you manage network settings that correspond to your Tablet-PC's physical location. It includes two categories of profile settings:

- **Location Profile Settings**
- **General Mobility Settings**

You can use **Location Profile Settings** to create profiles for accessing the Internet with your Tablet-PC in your office, home, or other public places with Internet services. **General Mobility Settings** allows you to change the way network connections are handled. The profiles consist of different network settings and equipment that you need when using your Tablet-PC in different locations.

For more information about Dell QuickSet, right-click the QuickSet icon in the taskbar and select **Help**.

Dell Wi-Fi Catcher™ Network Locator

The wireless switch on your Dell Tablet-PC uses the Dell Wi-Fi Catcher Network Locator to scan specifically for WiFi WLAN in your vicinity.

To scan for WiFi WLAN, slide and hold the switch in the "momentary" position for a few seconds. The Wi-Fi Catcher Network Locator functions regardless of whether your Tablet-PC is turned on or off, in hibernate, sleep, or standby mode, as long as the switch is configured through Dell QuickSet or the BIOS (system setup program) to control WiFi network connections.



NOTE: The Dell Wi-Fi Catcher Network Locator light appears only when the computer is turned off and wireless networking is activated in the system setup program. While working in a Microsoft Windows operating system, the light is designed not to appear.

Because the Wi-Fi Catcher Network Locator is disabled and not configured for use when your Tablet-PC is shipped to you, you must first use Dell QuickSet to enable and configure the switch to control WiFi network connections.

For more information on the Wi-Fi Catcher Network Locator and to enable the feature through Dell QuickSet, right-click the QuickSet icon in the taskbar and select **Help**.

Microsoft® Windows® Firewall

Windows Firewall provides basic protection from unauthorized access to your Tablet-PC while it is connected to the Internet. Windows Firewall is automatically enabled when you run the Network Setup Wizard.

When Windows Firewall is enabled for a network connection, the Firewall icon appears with a red background in the **Network Connections** section of the Control Panel.

To access options for enabling Windows Firewall:

- In Windows Vista, click **Start**  → **Control Panel** → **Security** → **Windows Firewall**.
- In Windows XP, click **Start** → **Control Panel** → **Security Center** → **Windows Firewall**.



NOTE: Enabling Windows Firewall does not reduce the need for virus-checking software.

For more information, see "Windows Help and Support" on page 19.

Securing Your Tablet-PC

Security Cable Lock

➔ **NOTICE:** Before you buy an antitheft device, ensure that it will work with the security cable slot on your Tablet-PC.

✍ **NOTE:** Your Tablet-PC does not ship with a security cable lock.

A security cable lock is a commercially available antitheft device. To use the lock, attach it to the security cable slot on your Tablet-PC. For more information, see the instructions included with the device.



Smart Cards and Biometric Readers

✍ **NOTE:** For information on how to secure your Tablet-PC while traveling, see "Traveling With Your Tablet-PC" on page 225.

Smart cards are portable credit-card shaped devices with internal integrated circuits. Using smart cards can improve system security by combining something a user has (the smart card) with something only the user should know (a PIN) to provide more secure user-authentication than passwords alone. See "Smart Cards" on page 91 for more information.

A biometric reader is a strip sensor located on your Tablet-PC's display. When you slide your finger over the reader, it uses your unique fingerprint to authenticate your user identity and help keep your Tablet-PC secure.



NOTE: You must purchase optional software in order to configure and use your biometric reader. See the documentation that ships with the biometric software for further information.

Passwords

About Passwords



NOTE: Passwords are disabled when you receive your Tablet-PC.

A primary (or system) password, an administrator password, and a hard drive password all prevent unauthorized access to your Tablet-PC in different ways. The following table identifies types and features of passwords available on your Tablet-PC.

Type of Password	Features
Primary (or system)	<ul style="list-style-type: none">• Protects the Tablet-PC from unauthorized access
Administrator	<ul style="list-style-type: none">• Gives system administrators or service technicians access to Tablet-PCs for repair or reconfiguration• Allows you to restrict access to system setup in the same way a primary password restricts access to the Tablet-PC• Can be used instead of the primary password
Hard drive	<ul style="list-style-type: none">• Helps protect the data on your hard drive or external hard drive (if one is being used) from unauthorized access



NOTE: Some hard drives do not support hard drive passwords.

 **NOTICE:** Passwords provide a high level of security for data in your Tablet-PC or hard drive. However, they are not foolproof. If you require more security, obtain and use additional forms of protection, such as smart cards, data encryption programs, or PC Cards with encryption features.

When using passwords, observe the following guidelines:

- Choose passwords that you can remember, but not ones that are easy to guess. For example, do not use the names of family members or pets for passwords.
- It is recommended that you do not write down passwords. If you do write it down, however, ensure that the password is stored in a secure place.
- Do not share passwords with other people.
- Ensure that people are not watching you when you type your password.

If you forget any of your passwords, contact Dell (see "Contacting Dell" on page 26). For your protection, Dell technical support staff will ask you for proof of your identity to ensure that only an authorized person can use the Tablet-PC.

Using a Primary (or System) Password

The primary password allows you to protect the Tablet-PC from unauthorized access.

When you first start your Tablet-PC, you must assign a primary password at the prompt.

If you do not enter a password within 2 minutes, the Tablet-PC returns to its previous operating state.

 **NOTICE:** If you disable the administrator password, the primary password is also disabled.

To add or change passwords, access **User Accounts** from the **Control Panel**.

If you have assigned an administrator password, you can use it instead of the primary password. The Tablet-PC does not specifically prompt you for the administrator password.

Using an Administrator Password

The administrator password is designed to give system administrators or service technicians access to computers for repair or reconfiguration. The administrators or technicians can assign identical administrator passwords to groups of computers, allowing you to assign a unique primary password.

To set or change administrator passwords, access **User Accounts** from the Control Panel.

When you set an administrator password, the **Configure Setup** option becomes available in system setup. The **Configure Setup** option allows you to restrict access to system setup in the same way that a primary password restricts access to the Tablet-PC.

The administrator password can be used instead of the primary password. Whenever you are prompted to enter the primary password, you can enter the administrator password.



NOTICE: If you disable the administrator password, the primary password is also disabled.



NOTE: The administrator password provides access to the Tablet-PC, but it does not provide access to the hard drive when a hard drive password is assigned.

If you forget the primary password and do not have an administrator password assigned, or if you have both a primary and an administrator password assigned but forget them both, contact your system administrator or contact Dell (see "Contacting Dell" on page 26).

Using a Hard Drive Password

The hard drive password helps protect the data on your hard drive from unauthorized access. You can also assign a password for an external hard drive (if one is being used) that can be the same as or different from the password for the primary hard drive.

To assign or change a hard drive password, enter system setup (see "Using the System Setup Program" on page 141).

After assigning a hard drive password, you must enter it each time you turn on the Tablet-PC and each time you restore the Tablet-PC to normal operation from sleep, standby, or hibernate mode.

If the hard drive password is enabled, you must enter it each time you turn on the Tablet-PC: A message appears asking for the hard drive password.

To continue, enter your password (with no more than eight characters) and press <Enter>.

If you do not enter a password within 2 minutes, the Tablet-PC returns to its previous operating state.

If you enter the wrong password, a message tells you that the password is invalid. Press <Enter> to try again.

If you do not enter the correct password in three attempts, the Tablet-PC tries to start from another bootable device if the **Boot First Device** option in system setup is set to allow start-up from another device. If the **Boot First Device** option is not set to allow the Tablet-PC to start from another device, the Tablet-PC returns to the operating state it was in when you turned it on.

If the hard drive password, the external hard drive password, and the primary password are the same, the Tablet-PC prompts you only for the primary password. If the hard drive password is different from the primary password, the Tablet-PC prompts you for both. Two different passwords provide greater security.



NOTE: The administrator password provides access to the Tablet-PC, but it does not provide access to the hard drive when a hard drive password is assigned.

Trusted Platform Module (TPM)



NOTE: Computers shipping into China are not equipped with the TPM feature.



NOTE: The TPM feature supports encryption only if the operating system supports TPM. For more information, see the TPM software documentation and the help files that came with the software.

TPM is a hardware-based security feature that can be used to create and manage computer-generated encryption keys. When combined with security software, the TPM enhances existing network and computer security by enabling features such as file protection capabilities and protected e-mail. The TPM feature is enabled through a system setup option.



NOTICE: To secure your TPM data and encryption keys, follow the backup procedures documented in the *Broadcom Secure Foundation Getting Started Guide*. In the event of these backups being incomplete, lost, or damaged, Dell will be unable to assist in the recovery of encrypted data.

Enabling the TPM Feature

- 1 Enable the TPM software:
 - a Restart the Tablet-PC and press <F2> during the Power On Self Test to enter the system setup program.
 - b Select **Security**→ **TPM Security** and press <Enter>.
 - c Under **TPM Security**, select **On**.
 - d Press <Esc> to exit the setup program.
 - e If prompted, click **Save/Exit**.
 - 2 Activate the TPM setup program:
 - a Restart the Tablet-PC and press <F2> during the Power On Self Test to enter the system setup program.
 - b Select **Security**→ **TPM Activation** and press <Enter>.
 - c Under **TPM Activation**, select **Activate** and press <Enter>.
-  **NOTE:** You only need to activate the program once.
- d Once the process is complete, the Tablet-PC either restarts automatically or prompts you to restart your Tablet-PC.

Security Management Software

The security management software is designed to use four different features to help you secure your Tablet-PC:

- Log-in management
- Pre-boot authentication (using a biometric reader, smart card, or password)
- Encryption
- Private information management

Activating the Security Management Software

 **NOTE:** You must first enable the TPM in order for the security management software to have full functionality.

- 1 Enable the TPM feature (see "Enabling the TPM Feature" on page 116).
- 2 Load the security management software:
 - a Turn on (or restart) your Tablet-PC.

- b When the DELL™ logo appears, press <F2> immediately. If you wait too long and the Windows logo appears, continue to wait until you see the Windows desktop. Then shut down your Tablet-PC and try again.
- c In the drop-down menu, select **Wave EMBASSY Trust Suite** and press <Enter> to create the icons for the software components on the Tablet-PC desktop.
- d Press <Esc> to exit the setup program.
- e If prompted, click **Save/Exit**.

Using the Security Management Software

For information about how to use the software and the different security features, see the *Getting Started Guide* for the software. To access the *Getting Started Guide*:

- In Windows® Vista®, click **Start**  → **All Programs** → **Wave EMBASSY Trust Suite** → **Getting Started Guide**.
- In Windows XP, click **Start** → **All Programs** → **Security by Wave Systems** → **Getting Started with EMBASSY Trust Suite**.

Computer Tracking Software

Computer tracking software may enable you to locate your Tablet-PC if it is lost or stolen. The software is optional and may be purchased when you order your Dell™ Tablet-PC, or you can contact your Dell sales representative for information about this security feature.



NOTE: Computer tracking software may not be available in certain countries.



NOTE: If you have computer tracking software and your Tablet-PC is lost or stolen, you must contact the company that provides the tracking service to report the missing Tablet-PC.

If Your Tablet-PC Is Lost or Stolen

- Call a law enforcement agency to report the lost or stolen Tablet-PC. Include the Service Tag in your description of the Tablet-PC. Ask that a case number be assigned and write down the number, along with the name, address, and phone number of the law enforcement agency. If possible, obtain the name of the investigating officer.



NOTE: If you know where the Tablet-PC was lost or stolen, call a law enforcement agency in that area. If you do not know, call a law enforcement agency where you live.

- If the Tablet-PC belongs to a company, notify the security office of the company.
- Contact Dell customer service to report the missing Tablet-PC. Provide the Tablet-PC Service Tag, the case number, and the name, address, and phone number of the law enforcement agency to which you reported the missing Tablet-PC. If possible, give the name of the investigating officer.

The Dell customer service representative will log your report under the Tablet-PC Service Tag and record the Tablet-PC as missing or stolen. If someone calls Dell for technical assistance and gives your Service Tag, the Tablet-PC is identified automatically as missing or stolen. The representative will attempt to get the phone number and address of the caller. Dell will then contact the law enforcement agency to which you reported the missing Tablet-PC.

Cleaning Your Tablet-PC

 **CAUTION:** Before you begin any of the procedures in this section, follow the safety instructions in the *Product Information Guide*.

Tablet-PC, Keyboard, and Display

 **CAUTION:** Before you clean your Tablet-PC, disconnect the Tablet-PC from the electrical outlet and, if necessary, the optional media base or battery slice. Remove any installed batteries. Clean your Tablet-PC with a soft cloth dampened with water. Do not use liquid or aerosol cleaners, which may contain flammable substances.

- Use a can of compressed air to remove dust from between the keys on the keyboard.



NOTICE: To avoid damaging the Tablet-PC or display, do not spray cleaning solution directly onto the display. Only use products specifically designed for cleaning displays, and follow the instructions that are included with the product.

- Moisten a soft, lint-free cloth with either water or a display cleaner, and wipe the display until it is clean.
- Moisten a soft, lint-free cloth with water and wipe the Tablet-PC and keyboard. Do not allow water from the cloth to seep between the touch pad and the surrounding palm rest.

Touch Pad

- 1 Shut down and turn off your Tablet-PC.
- 2 Disconnect any attached devices from the Tablet-PC and from their electrical outlets.
- 3 If applicable, undock your Tablet-PC from the optional media base or battery slice.
- 4 Remove any installed batteries (see "Removing the Main Battery" on page 158).

- 5 Moisten a soft, lint-free cloth with water, and wipe it gently across the surface of the touch pad. Do not allow water from the cloth to seep between the touch pad and the surrounding palm rest.

Optical Drives and Optical Drive Media

 **NOTICE:** Always use compressed air to clean the lens in an optical drive, and follow the instructions that come with the compressed-air product. Never touch the lens in the drive.

 **NOTE:** Unless you purchased either an optional external D/Bay or an optional media base with your Tablet-PC, you may not be able to use optical drives or optical drive media with your Tablet-PC.

If you notice problems, such as skipping, with the playback quality of your optical media, try cleaning the disc.

- 1 Hold the disc by its outer edge. You can also touch the inside edge of the center hole.

 **NOTICE:** To avoid damaging the surface, do not wipe in a circular motion around the disc.

- 2 With a soft, lint-free cloth, gently wipe the bottom of the disc (the unlabeled side) in a straight line from the center to the outer edge of the disc.

For stubborn dirt, try using water or a diluted solution of water and mild soap. You can also purchase commercial products that clean discs and provide some protection from dust, fingerprints, and scratches. Cleaning products for CDs are also safe to use on DVDs.

Troubleshooting

Some of the tools you may be using as you troubleshoot problems on your Tablet-PC include:

- Dell Diagnostics
- Dell Support Utility (Windows Vista® only)
- Windows® Hardware Troubleshooter

Dell Diagnostics



CAUTION: Before you begin any of the procedures in this section, follow the safety instructions in the *Product Information Guide*.



NOTICE: The Dell Diagnostics works only on Dell™ computers.

When to Use the Dell Diagnostics

If you experience a problem with your Tablet-PC, perform the checks in Lockups and Software Problems (see "Lockups and Software Problems" on page 130), and run the Dell Diagnostics before you contact Dell for technical assistance.

It is recommended that you print these procedures before you begin.

See "Using the System Setup Program" on page 141 to review your Tablet-PC's configuration information, and ensure that the device that you want to test displays in the system setup program and is active.





Start the Dell Diagnostics from your hard drive or from the *Drivers and Utilities* media.



NOTE: The *Drivers and Utilities* media is optional and may not ship with your Tablet-PC.

Starting the Dell Diagnostics From Your Hard Drive

The Dell Diagnostics is located on a hidden diagnostic utility partition on your hard drive.

-  **NOTE:** If your Tablet-PC does not display a screen image, contact Dell (see "Contacting Dell" on page 26).
-  **NOTE:** If the Tablet-PC is connected to a docking device (docked), undock it. See "Undocking Your Tablet-PC From the Media Base" on page 212 and "Undocking Your Tablet-PC From the Battery Slice" on page 220 for instructions if applicable.
- 1 Ensure that the Tablet-PC is connected to an electrical outlet that is known to be working properly.
 - 2 Turn on (or restart) your Tablet-PC.
 - 3 Start the Dell Diagnostics in one of the following two ways:
 -  **NOTE:** If you wait too long and the operating system logo appears, continue to wait until you see the Microsoft® Windows® desktop; then, shut down your Tablet-PC and try again.
 - When the DELL™ logo appears, press <F12> immediately. Select **Diagnostics** from the boot menu and press <Enter>.
 -  **NOTE:** Before attempting the following option, the Tablet-PC must be powered down completely.
 - Press and hold the <Fn> key while powering the Tablet-PC on.
 -  **NOTE:** If you see a message stating that no diagnostics utility partition has been found, run the Dell Diagnostics from the *Drivers and Utilities* media.

The Tablet-PC runs the Pre-boot System Assessment (PSA), a series of initial tests of your system board, keyboard, display, memory, hard drive, etc.

- During the assessment, answer any questions that appear.
- If failures are detected during the Pre-boot System Assessment, write down the error code(s) and contact Dell (see "Contacting Dell" on page 26).

If the Pre-boot System Assessment completes successfully, the following message appears: "Booting Dell Diagnostic Utility Partition.Press any key to continue."

- 4 Press any key to start the Dell Diagnostics from the diagnostics utility partition on your hard drive.
- 5 When the Dell Diagnostics Main Menu appears, select the test you want to run. See "Dell Diagnostics Main Menu" on page 123.

Starting the Dell Diagnostics From the Drivers and Utilities Media

- 1 Insert the *Drivers and Utilities* media.
- 2 Shut down and restart the Tablet-PC.

When the DELL logo appears, press <F12> immediately.

 **NOTE:** If you wait too long and the operating system logo appears, continue to wait until you see the Microsoft® Windows® desktop; then, shut down your Tablet-PC and try again.

 **NOTE:** The next steps change the boot sequence for one time only. On the next start-up, the Tablet-PC boots according to the devices specified in the system setup program.

- 3 When the boot device list appears, highlight CD/DVD/CD-RW and press <Enter>.
- 4 Select the **Boot from CD-ROM** option from the menu that appears and press <Enter>.
- 5 Type 1 to start the CD menu and press <Enter> to proceed.
- 6 Select **Run the 32 Bit Dell Diagnostics** from the numbered list. If multiple versions are listed, select the version appropriate for your Tablet-PC.
- 7 When the Dell Diagnostics **Main Menu** appears, select the test you want to run.

Dell Diagnostics Main Menu

- 1 After the Dell Diagnostics loads and the **Main Menu** appears, click the button for the option you want.

 **NOTE:** It is recommended that you select **Test System** to run a complete test on your Tablet-PC.

Option	Function
Test Memory	Run the stand-alone memory test
Test System	Run System Diagnostics
Exit	Exit the Diagnostics

- 2 After you have selected the **Test System** option from the main menu, the following menu appears:



NOTE: It is recommended that you select **Extended Test** from the menu below to run a more thorough check of devices in the Tablet-PC.

Option	Function
Express Test	Performs a quick test of devices in the system. This typically can take 10 to 20 minutes.
Extended Test	Performs a thorough check of devices in the system. This typically can take an hour or more.
Custom Test	Use to test a specific device or customize the tests to be run.
Symptom Tree	This option allows you to select tests based on a symptom of the problem you are having. This option lists the most common symptoms.

- 3 If a problem is encountered during a test, a message appears with an error code and a description of the problem. Write down the error code and problem description and contact Dell (see "Contacting Dell" on page 26).



NOTE: The Service Tag for your Tablet-PC is located at the top of each test screen. If you contact Dell, technical support will ask for your Service Tag.

- 4 If you run a test from the **Custom Test** or **Symptom Tree** option, click the applicable tab described in the following table for more information.



Tab	Function
Results	Displays the results of the test and any error conditions encountered.
Errors	Displays error conditions encountered, error codes, and the problem description.
Help	Describes the test and may indicate requirements for running the test.

Tab	Function (<i>continued</i>)
Configuration	<p>Displays your hardware configuration for the selected device.</p> <p>The Dell Diagnostics obtains configuration information for all devices from system setup, memory, and various internal tests, and it displays the information in the device list in the left pane of the screen. The device list may not display the names of all the components installed on your Tablet-PC or all devices attached to your Tablet-PC.</p>
Parameters	Allows you to customize the test by changing the test settings.

- 5 When the tests are complete, close the test screen to return to the **Main Menu** screen. To exit the Dell Diagnostics and restart the Tablet-PC, close the **Main Menu** screen.
- 6 Remove the Dell *Drivers and Utilities* media (if applicable).

Dell Support Utility for Windows Vista

The Dell Support Utility, installed on your Tablet-PC, provides self-support information, software updates, and health scans of your computing environment.

Access the Dell Support Utility from the  icon in the Windows Notification area or from the Windows Vista® Start  menu.

Accessing the Dell Support Utility

If the Dell Support icon does not appear in your Windows Notification area:

- 1 Click Start  → All Programs → Dell Support → Dell Support Settings.
- 2 Ensure that the **Show icon on the Windows Notification area** option is checked.



NOTE: If the Dell Support Utility is not available from the Windows Vista start button  menu, go to **support.dell.com** and download the software.

The Dell Support Utility is customized for your computing environment. The  icon in the Windows Notification area functions differently when you click, double-click, or right-click the icon.

Clicking the Dell Support Icon

Click or right-click the  icon to perform the following tasks:

- Check your computing environment
- View the Dell Support Utility settings
- Access the help file for the Dell Support Utility
- View frequently asked questions
- Learn more about the Dell Support Utility
- Turn the Dell Support Utility off

Windows Hardware Troubleshooter

If a device is either not detected during the operating system setup or is detected but incorrectly configured, you can use the Hardware Troubleshooter to resolve the incompatibility.

To start the Hardware Troubleshooter:

- 1 Click **Start**  (or **Start** in Windows XP) and click **Help and Support**.
- 2 Type `hardware troubleshooter` in the search field and press <Enter> to start the search.

In Windows XP, click **Hardware Troubleshooter** as displayed in the search results.

- 3 Select the option that best describes the problem and follow the remaining troubleshooting steps.

Solving Problems

Follow these tips when you troubleshoot your Tablet-PC:

- If you added or removed a part before the problem started, review the installation procedures and ensure that the part is correctly installed.

- If a peripheral device does not work, ensure that the device is properly connected.
- If an error message appears on the screen, write down the exact message. This message may help support personnel diagnose and fix the problem.
- If an error message occurs in a program, see the program's documentation.



NOTE: The procedures in this document were written for the Windows default view, so they may not apply if you set your Dell™ Tablet-PC to the Windows Classic view.

Hard Drive Problems



CAUTION: Before you begin any of the procedures in this section, follow the safety instructions in the *Product Information Guide*.

ENSURE THAT MICROSOFT® WINDOWS® RECOGNIZES THE DRIVE —

- In Windows Vista, click **Start**  and click **Computer**.
- In Windows XP, click **Start** and click **My Computer**.

If the drive is not displayed, perform a full scan with your antivirus software to check for and remove viruses. Viruses can sometimes prevent Windows from recognizing the drive.

RUN CHECK DISK —

1 Click **Start**  → **Computer**.

In Windows XP, click **Start** → **My Computer**.

2 Right-click the local disk.

3 Click **Properties** → **Tools** → **Check Now**.

In Windows Vista, the **User Account Control** window may appear. If you are an administrator on the Tablet-PC, click **Continue**; otherwise, contact your administrator to continue the desired action.

4 Follow the instructions on the screen.

TEST THE DRIVE — Insert another drive to eliminate the possibility that the original drive is defective.

RUN THE WINDOWS HARDWARE TROUBLESHOOTER — See "Windows Hardware Troubleshooter" on page 126.

RUN THE DELL DIAGNOSTICS — See "Dell Diagnostics" on page 121.

Optical Drive Problems

 **NOTE:** Unless you purchased either an optional external D/Bay or an optional media base with your Tablet-PC, you may not be able to use optical drives or optical drive media with your Tablet-PC.

 **NOTE:** High-speed optical drive vibration is normal and may cause noise, which does not indicate a defect in the drive or the media.

 **NOTE:** Because of different regions worldwide and different disc formats, not all DVD titles work in all DVD drives.

CLEAN THE OPTICAL DRIVE OR OPTICAL DRIVE MEDIA — See "Optical Drives and Optical Drive Media" on page 120.

CHECK THE CABLE CONNECTIONS

ADJUST THE WINDOWS VOLUME CONTROL —

- Click the speaker icon in the lower-right corner of your screen.
- Ensure that the volume is turned up by clicking the slidebar and dragging it up.
- Ensure that the sound is not muted by clicking any boxes that are checked.

RUN THE WINDOWS HARDWARE TROUBLESHOOTER — See "Windows Hardware Troubleshooter" on page 126.

RUN THE DELL DIAGNOSTICS — See "Dell Diagnostics" on page 121.

Problems writing to an optical drive

 **NOTE:** Unless you purchased either an optional external D/Bay or an optional media base with your Tablet-PC, you may not be able to use optical drives or optical drive media with your Tablet-PC.

CLOSE OTHER PROGRAMS — The optical drive must receive a steady stream of data during the writing process. If the stream is interrupted, an error occurs. Try closing all programs before you write to the optical.

TURN OFF SLEEP MODE IN WINDOWS VISTA BEFORE WRITING TO A DISC — See "Configuring Power Management Settings" on page 79 or search for the keyword *sleep* in Windows Help and Support for information on power management modes.

E-Mail and Internet Problems

 **CAUTION:** Before you begin any of the procedures in this section, follow the safety instructions in the *Product Information Guide*.

 **NOTE:** Do not plug a telephone cable into the network adapter connector (see "Back View" on page 36).

CHECK THE MICROSOFT OUTLOOK® EXPRESS SECURITY SETTINGS — If you cannot open your e-mail attachments:

- 1 In Outlook Express, click **Tools**→**Options**→**Security**.
- 2 Click **Do not allow attachments** to remove the checkmark, as needed.

ENSURE THAT YOU ARE CONNECTED TO THE INTERNET — Ensure that you have subscribed to an Internet provider. With the Outlook Express e-mail program open, click **File**. If **Work Offline** has a checkmark next to it, click the checkmark to remove it and connect to the Internet. For help, contact your Internet service provider.

Error Messages



CAUTION: Before you begin any of the procedures in this section, follow the safety instructions in the *Product Information Guide*.

NOTICE: If the error message is not listed, see the documentation for the operating system or the program that was running when the message appeared.

A FILENAME CANNOT CONTAIN ANY OF THE FOLLOWING CHARACTERS: \ / : * ? " < > | — Do not use these characters in filenames.

A REQUIRED .DLL FILE WAS NOT FOUND — The program that you are trying to open is missing an essential file. To remove and then reinstall the program:

- 1 Click **Start**  → **Control Panel** → **Programs** → **Programs and Features**.

In Windows XP, click **Start** → **Control Panel** → **Add or Remove Programs**.

- 2 Select the program you want to remove.
- 3 Click **Uninstall** (or **Remove** in Windows XP).
- 4 See the program documentation for installation instructions.

drive letter : \ IS NOT ACCESSIBLE. THE DEVICE IS NOT READY — The drive cannot read the disk. Insert a disk into the drive and try again.

INSERT BOOTABLE MEDIA — Insert a bootable CD or DVD into the optional external D/Bay or the optional media base.

NOT ENOUGH MEMORY OR RESOURCES. CLOSE SOME PROGRAMS AND TRY AGAIN — Close all windows and open the program that you want to use. In some cases, you may have to restart your Tablet-PC to restore Tablet-PC resources. If so, run the program that you want to use first.

OPERATING SYSTEM NOT FOUND — Contact Dell (see "Contacting Dell" on page 26).

IEEE 1394 Device Problems



CAUTION: Before you begin any of the procedures in this section, follow the safety instructions in the *Product Information Guide*.



NOTE: Your Tablet-PC supports only IEEE 1394a standard.

ENSURE THAT THE CABLE FOR THE IEEE 1394 DEVICE IS PROPERLY INSERTED INTO THE DEVICE AND INTO THE CONNECTOR ON THE TABLET-PC

ENSURE THAT THE IEEE 1394 DEVICE IS ENABLED IN SYSTEM SETUP — See "System Setup Screens" on page 142.

ENSURE THAT THE IEEE 1394 DEVICE IS RECOGNIZED BY WINDOWS —

1 Click Start  → Control Panel → Hardware and Sound.

In Windows XP, click Start → My Computer → View System Information → Hardware.

2 Click Device Manager.

If your IEEE 1394 device is listed, Windows recognizes the device.

IF YOU HAVE PROBLEMS WITH A DELL IEEE 1394 DEVICE — Contact Dell (see "Contacting Dell" on page 26).

IF YOU HAVE PROBLEMS WITH AN IEEE 1394 DEVICE NOT PROVIDED BY DELL —

Contact the IEEE 1394 device manufacturer.

Lockups and Software Problems



CAUTION: Before you begin any of the procedures in this section, follow the safety instructions in the *Product Information Guide*.

The Tablet-PC does not start up

ENSURE THAT THE POWER CABLE IS FIRMLY CONNECTED TO THE TABLET-PC AND TO THE ELECTRICAL OUTLET

The Tablet-PC stops responding



NOTICE: You may lose data if you are unable to perform an operating system shutdown.

TURN THE TABLET-PC OFF — If you are unable to get a response by pressing a key on your keyboard or touching your display with the pen or your finger, press and hold the power button for at least 8 to 10 seconds (until the Tablet-PC turns off), and then restart your Tablet-PC.

A program stops responding

END THE PROGRAM —

- 1 Press <Ctrl><Shift><Esc> simultaneously to access the Task Manager.
- 2 Click the **Applications** tab.
- 3 Click to select the program that is no longer responding.
- 4 Click **End Task**.

A program crashes repeatedly



NOTE: Most software includes installation instructions in its documentation, or on a CD or DVD.

CHECK THE SOFTWARE DOCUMENTATION — If necessary, uninstall and then reinstall the program.

A program is designed for an earlier Windows operating system

RUN THE PROGRAM COMPATIBILITY WIZARD — The Program Compatibility Wizard configures a program so that it runs in an environment similar to previous versions of Windows.

Windows Vista

- 1 Click **Start**  → **Control Panel** → **Programs** → **Use an older program with this version of Windows**.
- 2 In the welcome screen, click **Next**.
- 3 Follow the instructions on the screen.

Windows XP

- 1 Click **Start** → **Help and Support** → **Fixing a problem** → **Application and software problems**.
- 2 Click **Run Software that Worked with previous versions**.
- 3 In the welcome screen, click **Next**.
- 4 Follow the instructions on the screen.

A solid blue screen appears

TURN THE TABLET-PC OFF — If you are unable to get a response by pressing a key on your keyboard or touching your display with the pen or your finger, press and hold the power button for at least 8 to 10 seconds (until the Tablet-PC turns off), and then restart your Tablet-PC.

Other software problems

CHECK THE SOFTWARE DOCUMENTATION OR CONTACT THE SOFTWARE MANUFACTURER FOR TROUBLESHOOTING INFORMATION —

- Ensure that the program is compatible with the operating system installed on your Tablet-PC.
- Ensure that your Tablet-PC meets the minimum hardware requirements needed to run the software. See the software documentation for information.
- Ensure that the program is installed and configured properly.
- Verify that the device drivers do not conflict with the program.
- If necessary, uninstall and then reinstall the program.

BACK UP YOUR FILES IMMEDIATELY

USE A VIRUS-SCANNING PROGRAM TO CHECK THE HARD DRIVE, CDS, OR DVDs

SAVE AND CLOSE ANY OPEN FILES OR PROGRAMS AND SHUT DOWN YOUR TABLET-PC THROUGH THE START MENU

Memory Problems



CAUTION: Before you begin any of the procedures in this section, follow the safety instructions in the *Product Information Guide*.

IF YOU RECEIVE AN INSUFFICIENT MEMORY MESSAGE —

- Save and close any open files and exit any open programs you are not using to see if that resolves the problem.
- See the software documentation for minimum memory requirements. If necessary, install additional memory (see "Installing a Memory Module" on page 169).
- Reseat the memory modules (see "Memory" on page 168) to ensure that your Tablet-PC is successfully communicating with the memory.
- Run the Dell Diagnostics (see "Dell Diagnostics" on page 121).

IF YOU EXPERIENCE OTHER MEMORY PROBLEMS —

- Reseat the memory modules (see "Memory" on page 168) to ensure that your Tablet-PC is successfully communicating with the memory.
- Ensure that you are following the memory installation guidelines (see "Installing a Memory Module" on page 169).
- Ensure that the memory you are using is supported by your Tablet-PC. For more information about the type of memory supported by your Tablet-PC, see "Memory" on page 168.

- Run the Dell Diagnostics (see "Dell Diagnostics" on page 121).

Network Problems

 **CAUTION:** Before you begin any of the procedures in this section, follow the safety instructions in the *Product Information Guide*.

CHECK THE NETWORK CABLE CONNECTOR — Ensure that the network cable is firmly inserted into the network connector on the back of the Tablet-PC and the network jack.

CHECK THE NETWORK LIGHTS ON THE BACK OF THE TABLET-PC — If the link integrity light is off, no network communication is occurring. Replace the network cable.

RESTART THE TABLET-PC AND LOG ON TO THE NETWORK AGAIN

CHECK YOUR NETWORK SETTINGS — Contact your network administrator or the person who set up your network to verify that your network settings are correct and that the network is functioning.

RUN THE HARDWARE TROUBLESHOOTER — See "Windows Hardware Troubleshooter" on page 126.

Power Problems

 **CAUTION:** Before you begin any of the procedures in this section, follow the safety instructions in the *Product Information Guide*.

IF THE POWER LIGHT IS BLINKING BLUE — The computer is in sleep or standby mode. Press a key on the keyboard, move the mouse, or press the power button to resume normal operation.

IF THE POWER LIGHT IS OFF — The computer is either turned off or is not receiving power.

- Reseat the power cable in the power connector on the back of the computer and the electrical outlet.
- Bypass power strips, power extension cables, and other power protection devices to verify that the computer turns on properly.
- Ensure that any power strips being used are plugged into an electrical outlet and are turned on.
- Ensure that the electrical outlet is working by testing it with another device, such as a lamp.

IF THE POWER LIGHT IS STEADY AMBER — A device may be malfunctioning or incorrectly installed. Remove and then reinstall all memory modules (see "Memory" on

page 168).

ELIMINATE INTERFERENCE — Some possible causes of interference are:

- Power, keyboard, and mouse extension cables
- Too many devices connected to the same power strip
- Multiple power strips connected to the same electrical outlet

Printer Problems



CAUTION: Before you begin any of the procedures in this section, follow the safety instructions in the *Product Information Guide*.



NOTE: If you need technical assistance for your printer, contact the printer's manufacturer.

CHECK THE PRINTER DOCUMENTATION — See the printer documentation for setup and troubleshooting information.

ENSURE THAT THE PRINTER IS TURNED ON

CHECK THE PRINTER CABLE CONNECTIONS —

- See the printer documentation for cable connection information.
- Ensure that the printer cables are securely connected to the printer and the Tablet-PC.

TEST THE ELECTRICAL OUTLET — Ensure that the electrical outlet is working by testing it with another device, such as a lamp.

VERIFY THAT THE PRINTER IS RECOGNIZED BY WINDOWS —

1 Click Start  → Control Panel → Hardware and Sound → Printer.

In Windows XP, click Start → Control Panel → Printers and Other Hardware → Printers and Faxes.

2 If the printer is listed, right-click the printer icon.

3 Click **Properties** and click **Ports**.

4 Adjust the settings, as needed.

REINSTALL THE PRINTER DRIVER — See the printer documentation for information on reinstalling the printer driver.

Scanner Problems



CAUTION: Before you begin any of the procedures in this section, follow the safety instructions in the *Product Information Guide*.



NOTE: If you need technical assistance for your scanner, contact the scanner's manufacturer.

CHECK THE SCANNER DOCUMENTATION — See the scanner documentation for setup and troubleshooting information.

UNLOCK THE SCANNER — Ensure that your scanner is unlocked (if the scanner has a locking tab or button).

RESTART THE TABLET-PC AND TRY THE SCANNER AGAIN

CHECK THE CABLE CONNECTIONS —

- See the scanner documentation for information on cable connections.
- Ensure that the scanner cables are securely connected to the scanner and the Tablet-PC.

VERIFY THAT THE SCANNER IS RECOGNIZED BY MICROSOFT WINDOWS —

1 Click Start  → Control Panel → Hardware and Sound → Scanners and Cameras.

In Windows XP, click Start → Control Panel → Printers and Other Hardware → Scanners and Cameras.

2 If the scanner is listed, Windows recognizes the scanner.

REINSTALL THE SCANNER DRIVER — See the scanner documentation for instructions.

Sound and Speaker Problems



NOTE: The volume control in MP3 and other media players may override the Windows volume setting. Always check to ensure that the volume on the media player(s) has not been turned down or off.



CAUTION: Before you begin any of the procedures in this section, follow the safety instructions in the *Product Information Guide*.

No sound from integrated speakers

ADJUST THE WINDOWS VOLUME CONTROL — Click or double-click the speaker icon in the lower-right corner of your screen. Ensure that the volume is turned up and that the sound is not muted.

REINSTALL THE SOUND DRIVER — See "Using the Drivers and Utilities Media" on page 147.

No sound from external speakers

ENSURE THAT THE SUBWOOFER AND THE SPEAKERS ARE TURNED ON — See the setup diagram supplied with the speakers. If your speakers have volume controls,

adjust the volume, bass, or treble to eliminate distortion.

ADJUST THE WINDOWS VOLUME CONTROL — Click or double-click the speaker icon in the lower-right corner of your screen. Ensure that the volume is turned up and that the sound is not muted.

DISCONNECT HEADPHONES FROM THE HEADPHONE CONNECTOR — Sound from the speaker is automatically disabled when headphones are connected to the Tablet-PC headphone connector.

TEST THE ELECTRICAL OUTLET — Ensure that the electrical outlet is working by testing it with another device, such as a lamp.

ELIMINATE POSSIBLE INTERFERENCE — Turn off nearby fans, fluorescent lights, or halogen lamps to check for interference.

RUN THE SPEAKER DIAGNOSTICS

REINSTALL THE AUDIO DRIVER — See "Reinstalling Drivers and Utilities" on page 146.

RUN THE HARDWARE TROUBLESHOOTER — See "Windows Hardware Troubleshooter" on page 126.

No sound from headphones

CHECK THE HEADPHONE CABLE CONNECTION — Ensure that the headphone cable is securely inserted into the headphone connector (see "Right Side View" on page 34).

ADJUST THE WINDOWS VOLUME CONTROL — Click or double-click the speaker icon in the lower-right corner of your screen. Ensure that the volume is turned up and that the sound is not muted.

Touch Pad or Mouse Problems

CHECK THE TOUCH PAD SETTINGS —

1 Click Start  (or Start in Windows XP) → Control Panel → Printers and Other Hardware → Mouse.

2 Try adjusting the settings.

CHECK THE MOUSE CABLE — Shut down the Tablet-PC. Disconnect the mouse cable, check it for damage, and firmly reconnect the cable.

If you are using a mouse extension cable, disconnect it and connect the mouse directly to the Tablet-PC.

TO VERIFY THAT THE PROBLEM IS WITH THE MOUSE, CHECK THE TOUCH PAD —

1 Shut down the Tablet-PC.

2 Disconnect the mouse.

3 Turn on the Tablet-PC.

4 At the Windows desktop, use the touch pad to move the cursor around, select an icon, and open it.

If the touch pad operates correctly, the mouse may be defective.

CHECK THE SYSTEM SETUP PROGRAM SETTINGS — Verify that the system setup program lists the correct device for the pointing device option. (The Tablet-PC automatically recognizes a USB mouse without making any setting adjustments.) For more information on using the system setup program, see "Using the System Setup Program" on page 141.

TEST THE MOUSE CONTROLLER — To test the mouse controller (which affects pointer movement) and the operation of the touch pad or mouse buttons, run the Mouse test in the **Pointing Devices** test group in the Dell Diagnostics (see "Dell Diagnostics" on page 121).

REINSTALL THE TOUCH PAD DRIVER — See "Reinstalling Drivers and Utilities" on page 146.

Troubleshooting Stylus and Touch Problems

If you encounter a problem while using the pen or when touching the screen, the **Tablet Settings** window (i.e., **Properties**) and certain Windows **Control Panel** screens are useful to resolve the problem.

Diagnostics

INITIALIZE DIGITIZER — In the system **Control Panel**, open the **N-trig Tablet Settings** icon and click the **Restore defaults** button to set the Tablet-PC pen and touch features to the factory default configuration.

EXECUTE DIGITIZER SELF-TEST DIAGNOSTICS — In the system **Control Panel**, open the **N-trig Tablet Settings** icon and click the **Trouble Shooting** button to execute a diagnostic self test. This test verifies that the digitizer hardware is fully functional. During the test, the pop-up window provides instruction to the user and reports the test result. If the test result produces a diagnostic code, **contact Dell** (see "Contacting Dell" on page 26).

EITHER TOUCH OR PEN MODE NOT FUNCTIONING — on the system **Control Panel**, open the **N-trig Tablet Settings** icon. Select the preferred mode of operation to enable Touch, Pen, Dual, or Auto (Windows Vista only).

Touch Not Functioning

VERIFY TOUCH INPUT IS ENABLED — In the system **Control Panel** open the **Pen and Input Devices** icon. On the **Touch** screen, ensure that the option **Use your**

finger as an input device is checked. Select other settings on this screen as desired to configure how the Touch feature will perform.

TOUCH TUNING — In the system Control Panel, open the N-trig **Tablet Settings** icon and click the **Digitizer Options** tab. In the **Touch Tuning** frame, click the **Reset** button and follow the instructions provided.

Pen Pressure Sensitivity Problems

ENABLE STYLUS PRESSURE SENSITIVITY — In Windows Journal select the **Tools** drop-down menu and then select **Options**. In the **Options** window, click the **Note Format** tab, and then select the **Pen Settings...** button. In the **Pen and Highlighter Settings** window, ensure that the option **Pressure sensitive** is checked.

Pen Problems



CAUTION: Before you begin any of the procedures in this section, follow the safety instructions in the *Product Information Guide*.

The pen stops working

CHECK TIP INSTALLATION —

- Replace the pen tip. See "Replacing the Pen Tip" on page 66.
- If this does not solve the problem, contact Dell. See "Contacting Dell" on page 26.

Display Problems



CAUTION: Before you begin any of the procedures in this section, follow the safety instructions in the *Product Information Guide*.

The screen is difficult to read

ROTATE THE DISPLAY TO ELIMINATE SUNLIGHT GLARE AND POSSIBLE INTERFERENCE

ADJUST THE WINDOWS DISPLAY SETTINGS —

1 Click **Start**  → **Control Panel** → **Hardware and Sound** → **Personalization** → **Display Settings**.

In Windows XP, click **Start** → **Control Panel** → **Appearance and Themes** → **Display**.

2 Adjust **Resolution** and **Colors** settings, as needed.

If only part of the display is readable

CONNECT AN EXTERNAL MONITOR —

- 1 Shut down your Tablet-PC and connect an external monitor to the Tablet-PC.
- 2 Turn on the Tablet-PC and the monitor and adjust the monitor brightness and contrast controls.

If the external monitor works, the Tablet-PC display or video controller may be defective. Contact Dell (see "Contacting Dell" on page 26).

When using a projector, the projected image is rotated and unreadable

ROTATE THE DISPLAY IMAGE TO A READABLE ORIENTATION USING THE SCREEN

ROTATE BUTTON — See "Using Tablet Buttons" on page 62 for more information on the Screen Rotate button. See "Using Your Tablet-PC With a Projector" on page 95 for more information on using the Tablet-PC with a projector.

Power Lights

 **CAUTION:** Before you begin any of the procedures in this section, follow the safety instructions in the *Product Information Guide*.

The power button LED ring, located on the Tablet-PC, display illuminates and blinks or remains solid to indicate different states:

- If the power light is blinking blue, the computer is in sleep or standby mode. Press a key on the keyboard, move the mouse, or press the power button to resume normal operation.
- If the power light is off, the computer is either turned off or is not receiving power.
 - Reseat the power cable into both the power connector on the back of the computer and the electrical outlet.
 - If the computer is plugged into a power strip, ensure that the power strip is plugged into an electrical outlet and that the power strip is turned on.
 - Bypass power protection devices, power strips, and power extension cables to verify that the computer turns on properly.
 - Ensure that the electrical outlet is working by testing it with another device, such as a lamp.

- If the power light is blinking blue, the computer is receiving electrical power, but an internal power problem might exist.
- If the power light is steady amber, a device may be malfunctioning or incorrectly installed.
 - Remove and then reinstall the memory modules (see "Memory" on page 168).
- Eliminate interference. Some possible causes of interference are:
 - Power, keyboard, and mouse extension cables
 - Too many devices on a power strip
 - Multiple power strips connected to the same electrical outlet

Using the System Setup Program

Overview



NOTE: Your operating system may automatically configure most of the options available in the system setup program, thus overriding options that you set through the system setup program. (An exception is the **External Hot Key** option, which you can disable or enable only through the system setup program.) For more information on configuring features for your operating system, click **Start**  (or **Start** in Windows® XP) → **Help and Support**.

You can use the system setup program as follows:

- To set or change user-selectable features—for example, your Tablet-PC password
- To verify information about the Tablet-PC's current configuration, for example, the amount of system memory

After you set up the Tablet-PC, run the system setup program to familiarize yourself with your system configuration information and optional settings. You may want to write down the information for future reference.

The system setup screens display the current setup information and settings for your Tablet-PC, such as:

- System configuration
- Boot order
- Boot (start-up) configuration and docking-device configuration settings
- Basic device-configuration settings
- System security and hard-drive password settings



NOTE: Unless you are an expert computer user or are directed to do so by Dell technical support, do not change the system setup settings. Certain changes might make your Tablet-PC work incorrectly.

System Setup Screens

Viewing the System Setup Screens

- 1 Turn on (or restart) your Tablet-PC.
- 2 When the DELL™ logo appears, press <F2> immediately. If you wait too long and the Microsoft® Windows® logo appears, continue to wait until you see the Windows desktop. Then shut down your Tablet-PC and try again.



NOTE: For information about a specific item on a system setup screen, highlight the item and see the **Help** area on the screen.

On each screen, the system setup options are listed at the left. To the right of each option is the setting or value for that option. You can change settings that appear as white type on the screen. Options or values that you cannot change (because they are determined by the Tablet-PC) appear less bright.

The upper-right corner of the screen displays help information for the currently highlighted option; the lower-right corner displays information about the Tablet-PC. System-setup key functions are listed across the bottom of the screen.

Commonly Used Options

Certain options require that you reboot the Tablet-PC for new settings to take effect.



NOTE: The information in this document may vary from the selections displayed on the system setup screens. Review the selections and instructions provided on the system setup screens for specific directions.

Changing the Boot Sequence

The *boot sequence*, or *boot order*, tells the Tablet-PC where to look to find the software needed to start the operating system. You can control the boot sequence and enable or disable devices using the **Boot Order** page of the system setup program.



NOTE: To change the boot sequence on a one-time-only basis, see "Performing a One-Time Boot" on page 143.

The **Boot Order** page displays a general list of the bootable devices that may be installed in your Tablet-PC, including but not limited to the following:

- Modular Bay HDD
- Internal HDD
- Optical Drive

During the boot routine, the Tablet-PC starts at the top of the list and scans each enabled device for the operating system start-up files. When the Tablet-PC finds the files, it stops searching and starts the operating system.

To control the boot devices, select (highlight) a device by pressing the down-arrow or up-arrow key, and then enable or disable the device or change its order in the list.

- To enable or disable a device, highlight the item and press the space bar. Enabled items appear as white and display a small triangle to the left; disabled items appear blue or dimmed without a triangle.
- To reorder a device in the list, highlight the device and then press <u> or <d> (not case-sensitive) to move the highlighted device up or down.

Boot sequence changes take effect as soon as you save the changes and exit the system setup program.

Performing a One-Time Boot

You can set a one-time-only boot sequence without entering the system setup program. (You can also use this procedure to boot the Dell Diagnostics on the diagnostics utility partition on your hard drive.)

- 1** Shut down the Tablet-PC through the **Start** ( in Windows Vista®) menu.
- 2** If the Tablet-PC is connected to a docking device (docked), undock it. See the documentation that came with your docking device for instructions.
- 3** Connect the Tablet-PC to an electrical outlet.
- 4** Turn on the Tablet-PC. When the DELL logo appears, press <F12> immediately.

If you wait too long and the Windows logo appears, continue to wait until you see the Windows desktop. Then shut down your Tablet-PC and try again.

- 5 When the boot device list appears, highlight the device from which you want to boot and press <Enter>.

The Tablet-PC boots to the selected device.

The next time you reboot the Tablet-PC, the previous boot order is restored.

Reinstalling Software

Drivers

What Is a Driver?

A driver is a program that controls a device such as a printer, mouse, or keyboard. All devices require a driver program.

A driver acts like a translator between the device and any other programs that use the device. Each device has its own set of specialized commands that only its driver recognizes.

Dell ships your Tablet-PC to you with required drivers already installed—no further installation or configuration is needed.



NOTICE: The *Drivers and Utilities* media may contain drivers for operating systems that are not on your Tablet-PC. Ensure that you are installing software appropriate for your operating system.

Many drivers, such as the keyboard driver, come with your Microsoft® Windows® operating system. You may need to install drivers if you:

- Upgrade your operating system
- Reinstall your operating system
- Connect or install a new device

Identifying Drivers

If you experience a problem with any device, identify whether the driver is the source of your problem and, if necessary, update the driver.

- 1 Click **Start** , and right-click **Computer**.
In Windows XP, click **Start** and right-click **My Computer**.
- 2 Click **Properties**→ **Device Manager**.

In Windows XP, click **Properties**→**Hardware**→**Device Manager**.

 **NOTE:** In Windows Vista®, the **User Account Control** window may appear. If you are an administrator on the Tablet-PC, click **Continue**; otherwise, contact your administrator to continue.

Scroll down the list to see if any device has an exclamation point (a yellow circle with a [!]) on the device icon.

If an exclamation point is next to the device name, you may need to reinstall the driver or install a new driver (see "Reinstalling Drivers and Utilities" on page 146).

Reinstalling Drivers and Utilities

 **NOTICE:** The Dell Support website at support.dell.com and your *Drivers and Utilities* media provide approved drivers for Dell™ computers. If you install drivers obtained from other sources, your Tablet-PC might not work correctly.

Using Windows Device Driver Rollback

If a problem occurs on your Tablet-PC after you install or update a driver, use Windows Device Driver Rollback to replace the driver with the previously installed version.

1 Click **Start** , and right-click **Computer**.

In Windows XP, click **Start** and right-click **My Computer**.

2 Click **Properties**→**Device Manager**.

In Windows XP, click **Properties**→**Hardware**→**Device Manager**.

 **NOTE:** In Windows Vista, the **User Account Control** window may appear. If you are an administrator on the Tablet-PC, click **Continue**; otherwise, contact your administrator to enter the Device Manager.

3 Right-click the device for which the new driver was installed and click **Properties**.

4 Click the **Driver** tab→**Roll Back Driver**.

If Device Driver Rollback does not resolve the problem, then use System Restore (see "Restoring Your Operating System" on page 148) to return your Tablet-PC to the operating state that existed before you installed the new driver.

Using the Drivers and Utilities Media

If using Device Driver Rollback or System Restore (see "Restoring Your Operating System" on page 148) does not resolve the problem, then reinstall the driver from the *Drivers and Utilities* media.

- 1 Save and close any open files, and exit any open programs.
- 2 Insert the *Drivers and Utilities* media.

In most cases, the CD/DVD starts running automatically. If it does not, start Windows Explorer, click your CD/DVD drive directory to display the CD/DVD contents, and then double-click the **autorcd.exe** file. The first time that you run the CD/DVD, it might prompt you to install setup files. Click **OK**, and follow the instructions on the screen to continue.

- 3 From the **Language** drop-down menu in the toolbar, select your preferred language for the driver or utility (if available).
- 4 At the welcome screen, click **Next** and wait for the CD/DVD to complete the hardware scan.
- 5 To detect other drivers and utilities, under **Search Criteria**, select the appropriate categories from the **System Model**, **Operating System**, and **Topic** drop-down menus.

A link or links appear(s) for the specific drivers and utilities used by your Tablet-PC.

- 6 Click the link of a specific driver or utility to display information about the driver or utility that you want to install.
- 7 Click the **Install** button (if present) to begin installing the driver or utility. At the welcome screen, follow the screen prompts to complete the installation.

If no **Install** button is present, automatic installation is not an option. For installation instructions, either see the appropriate instructions in the following subsections, or click **Extract**, follow the extracting instructions, and then read the readme file.

If instructed to navigate to the driver files, click the CD/DVD directory on the driver information window to display the files associated with that driver.

Manually Reinstalling Drivers

After extracting the driver files to your hard drive as described in the previous section, do the following:

- 1 Click **Start** , and right-click **Computer**.
In Windows XP, click **Start** and right-click **My Computer**.

- 2 Click **Properties**→ **Device Manager**.

In Windows XP, click **Properties**→ **Hardware**→ **Device Manager**.



NOTE: In Windows Vista, the **User Account Control** window may appear. If you are an administrator on the Tablet-PC, click **Continue**; otherwise, contact your administrator to enter the Device Manager.

- 3 Double-click the type of device for which you are installing the driver (for example, **Audio** or **Video**).
- 4 Double-click the name of the device for which you are installing the driver.
- 5 Click **Driver**→ **Update Driver**→ **Browse my computer for driver software**.



NOTE: In Windows XP, the Hardware Update Wizard may display. In this case, follow the wizard instructions instead of completing the remainder of this procedure.

- 6 Click **Browse** and browse to the location to which you previously copied the driver files.
- 7 When the name of the appropriate driver appears, click the name of the driver→ **OK**→ **Next**.
- 8 Click **Finish** and restart your Tablet-PC.

Restoring Your Operating System

You can restore your operating system in the following ways:

- System Restore returns your Tablet-PC to an earlier operating state without affecting data files. Use System Restore as the first solution for restoring your operating system and preserving data files.
- Dell Factory Image Restore returns your hard drive to the operating state it was in when you purchased the Tablet-PC. All data on the hard drive and any programs installed after you received the Tablet-PC are permanently deleted. Use Dell Factory Image Restore only if System Restore did not resolve your operating system problem.

- If you received an *Operating System* disc with your Tablet-PC, you can use it to restore your operating system. However, using the *Operating System* disc also deletes all data on the hard drive. Use the disc *only* if System Restore did not resolve your operating system problem.

Using Microsoft Windows System Restore

The Windows operating systems provide a System Restore option which allows you to return your Tablet-PC to an earlier operating state (without affecting data files) if changes to the hardware, software, or other system settings have left the Tablet-PC in an undesirable operating state. Any changes that System Restore makes to your Tablet-PC are completely reversible.



NOTICE: Make regular backups of your data files. System Restore does not monitor your data files or recover them.



NOTE: The procedures in this document were written for the Windows default view, so they may not apply if you set your Dell™ Tablet-PC to the Windows Classic view.

Starting System Restore

Use System Restore to return the system to a previous state. In the event that System Restore does not resolve the issue, you may undo the last system restore.

Windows Vista

- 1 Click Start .
- 2 In the Search box, type System Restore and press <Enter>.



NOTE: The **User Account Control** window may appear. If you are an administrator on the Tablet-PC, click **Continue**; otherwise, contact your administrator to continue the desired action.

- 3 Click Next and follow the remaining prompts on the screen.

Windows XP

- 1 Click Start → Help and Support
- 2 In the Search box, type System Restore and press <Enter>.
- 3 Select **Run the System Restore Wizard** as displayed in the search results.

- 4 Click **Next** and follow the remaining prompts on the screen.

Undoing the Last System Restore

-  **NOTICE:** Before you undo the last system restore, save and close all open files and exit any open programs. Do not alter, open, or delete any files or programs until the system restoration is complete.

Windows Vista

- 1 Click **Start** .
- 2 In the **Start Search** box, type **System Restore** and press <Enter>.
- 3 Click **Undo my last restoration** and click **Next**.

Windows XP

- 1 Click **Start** → **Help and Support**
- 2 In the **Search** box, type **System Restore** and press <Enter>.
- 3 Select **Run the System Restore Wizard** as displayed in the search results.
- 4 Select **Undo the last restoration**.
- 5 Click **Next** and follow the remaining prompts on the screen.

Using Dell Factory Image Restore

-  **NOTICE:** Using Dell Factory Image Restore permanently deletes all data on the hard drive and removes any programs or drivers installed after you received your Tablet-PC. If possible, back up the data before using this option. Use Dell Factory Image Restore only if System Restore did not resolve your operating system problem.

-  **NOTE:** Dell Factory Image Restore may not be available in certain countries or on certain computers.

Use Dell Factory Image Restore only as the last method to restore your operating system. These options restore your hard drive to the operating state it was in when you purchased the Tablet-PC. Any programs or files added since you received your Tablet-PC—including data files—are permanently deleted from the hard drive. Data files include documents, spreadsheets, e-mail messages, digital photos, music files, and so on. If possible, back up all data before using Dell Factory Image Restore.

- 1 Turn on the Tablet-PC. When the Dell logo appears, press <F8> several times to access the Vista Advanced Boot Options Window.
- 2 Select **Repair Your Computer**.
The System Recovery Options window appears.
- 3 Select a keyboard layout and click **Next**.
- 4 To access the recovery options, log on as a local user. To access the command prompt, type `administrator` in the User name field, then click **OK**.
- 5 Click **Dell Factory Image Restore**.



NOTE: Depending upon your configuration, you may need to select **Dell Factory Tools**, then **Dell Factory Image Restore**.

The Dell Factory Image Restore welcome screen appears.

- 6 Click **Next**.

The **Confirm Data Deletion** screen appears.



NOTICE: If you do not want to proceed with Dell Factory Image Restore, click **Cancel**.

- 7 Click the checkbox to confirm that you want to continue reformatting the hard drive and restoring the system software to the factory condition, then click **Next**.

The restore process begins and may take five or more minutes to complete. A message appears when the operating system and factory-installed applications have been restored to factory condition.

- 8 Click **Finish** to reboot the system.

Using the Operating System Media

Before you Begin

If you are considering reinstalling the Windows operating system to correct a problem with a newly installed driver, first try using Windows Device Driver Rollback. See "Using Windows Device Driver Rollback" on page 146. If Device Driver Rollback does not resolve the problem, then use System

Restore to return your operating system to the operating state it was in before you installed the new device driver. See "Using Microsoft Windows System Restore" on page 149.

 **NOTICE:** Before performing the installation, back up all data files on your primary hard drive. For conventional hard drive configurations, the primary hard drive is the first drive detected by the Tablet-PC.

To reinstall Windows, you need the following items:

- Dell™ *Operating System* media
- Dell *Drivers and Utilities* media

 **NOTE:** The Dell *Drivers and Utilities* media contains drivers that were installed during the assembly of the Tablet-PC. Use the Dell *Drivers and Utilities* media to load any required drivers. Depending on the region from which you ordered your Tablet-PC, or whether you requested the media, the Dell *Drivers and Utilities* media and *Operating System* media may not ship with your Tablet-PC.

Reinstalling the Operating System

The reinstallation process can take 1 to 2 hours to complete. After you reinstall the operating system, you must also reinstall the device drivers, virus protection program, and other software.

- 1 Save and close any open files and exit any open programs.
- 2 Insert the *Operating System* media.

 **NOTE:** When reinstalling Windows XP, insert the operating system media into an externally powered USB optical drive.

- 3 Click **Exit** if the **Install Windows** message appears.
- 4 Restart the Tablet-PC.

When the DELL logo appears, press <F12> immediately.

 **NOTE:** If you wait too long and the operating system logo appears, continue to wait until you see the Microsoft® Windows® desktop; then, shut down your Tablet-PC and try again.

 **NOTE:** The next steps change the boot sequence for one time only. On the next start-up, the Tablet-PC boots according to the devices specified in the system setup program.

- 5 When the boot device list appears, highlight **CD/DVD/CD-RW Drive** and press <Enter>.

- 6** Press any key to **Boot from CD-ROM**.
- 7** Follow the instructions on the screen to complete the installation.

Adding and Replacing Parts

Before You Begin

This chapter provides procedures for removing and installing the components in your Tablet-PC. Unless otherwise noted, each procedure assumes the following:

- You have performed the steps in "Turning Off Your Tablet-PC" on page 155 and "Before Working Inside Your Tablet-PC" on page 156.
- You have read the safety information in the Dell™ *Product Information Guide*.

Recommended Tools

The procedures in this document may require the following tools:

- Small flat-blade screwdriver
- #0 Phillips screwdriver
- #1 Phillips screwdriver
- Small plastic scribe
- Flash BIOS update program CD

Turning Off Your Tablet-PC



NOTICE: To avoid losing data, save and close all open files and exit all open programs before you turn off your Tablet-PC.

- 1 Shut down the operating system:

- In Windows Vista:

Click **Start** , then click the arrow in the lower-right corner of the **Start** menu as shown below, and then click **Shut Down**.



- In Windows XP:

Click Start → Turn Off Computer → Turn Off.

The Tablet-PC turns off after the operating system shutdown process is complete.

- 2 Ensure that the Tablet-PC and all attached devices are turned off. If your Tablet-PC and attached devices did not automatically turn off when you shut down your operating system, press and hold the power button for about 4 seconds to turn them off.

Before Working Inside Your Tablet-PC

Use the following safety guidelines to help protect your Tablet-PC from potential damage and to help to ensure your own personal safety.



CAUTION: Before you begin any of the procedures in this section, follow the safety instructions in the *Product Information Guide*.



NOTICE: Handle components and cards with care. Do not touch the components or contacts on a card. Hold a card by its edges or by its metal mounting bracket. Hold a component such as a processor by its edges, not by its pins.



NOTICE: Only a certified service technician should perform repairs on your Tablet-PC. Damage due to servicing that is not authorized by Dell is not covered by your warranty.



NOTICE: When you disconnect a cable, pull on its connector or on its pull-tab, not on the cable itself. Some cables have connectors with locking tabs; if you are disconnecting this type of cable, press in on the locking tabs before you disconnect the cable. As you pull connectors apart, keep them evenly aligned to avoid bending any connector pins. Also, before you connect a cable, ensure that both connectors are correctly oriented and aligned.



NOTICE: To avoid damaging the Tablet-PC, perform the following steps before you begin working inside the Tablet-PC.

- 1 Ensure that the work surface is flat and clean to prevent the Tablet-PC cover from being scratched.
- 2 Turn off your Tablet-PC (see "Turning Off Your Tablet-PC" on page 155).

- 3 If the Tablet-PC is connected to a docking device (docked), undock it. See "Undocking Your Tablet-PC From the Media Base" on page 212, or "Undocking Your Tablet-PC From the Battery Slice" on page 220.
- ➡ **NOTICE:** To disconnect a network cable, first unplug the cable from your Tablet-PC and then unplug the cable from the network device.
- 4 Disconnect all network cables from the Tablet-PC.
- 5 Disconnect your Tablet-PC and all attached devices from their electrical outlets.
- 6 Close the display and turn the Tablet-PC upside-down on a flat work surface.
- ➡ **NOTICE:** To avoid damaging the system board, you must remove the main battery before you service the Tablet-PC.
- 7 Remove the main battery (see "Removing the Main Battery" on page 158).
- 8 Turn the Tablet-PC top-side up.
- 9 Open the display.
- 10 Press the power button to ground the system board.
- ⚠ **CAUTION:** To guard against electrical shock, always unplug your Tablet-PC from the electrical outlet before opening the display.
- ➡ **NOTICE:** Before touching anything inside your Tablet-PC, ground yourself by touching an unpainted metal surface, such as the metal at the back of the Tablet-PC. While you work, periodically touch an unpainted metal surface to dissipate static electricity, which could harm internal components.
- 11 Remove any installed ExpressCards or Smart Cards from the appropriate slots (see "Removing an ExpressCard" on page 91).
- 12 Remove the hard drive (see "Removing the Hard Drive" on page 160).



Main Battery

- ⚠ **CAUTION:** Before you begin any of the procedures in this section, follow the safety instructions in the *Product Information Guide*.
- ➡ **NOTICE:** Only a certified service technician should perform repairs on your Tablet-PC. Damage due to servicing that is not authorized by Dell is not covered by your warranty.



NOTE: Your Tablet-PC's Service Tag and Microsoft® Windows® License labels are located under the main battery in the battery bay of your Tablet-PC

Removing the Main Battery

- 1 Follow the procedures in "Before You Begin" on page 155.
- 2 Turn off your Tablet-PC (see "Turning Off Your Tablet-PC" on page 155).
- 3 If the Tablet-PC is connected to a docking device such as the optional Media Base or Battery Slice (docked), undock it. See "Undocking Your Tablet-PC From the Media Base" on page 212, or "Undocking Your Tablet-PC From the Battery Slice" on page 220.
-  **NOTICE:** To disconnect a network cable, first unplug the cable from your Tablet-PC and then unplug the cable from the network device.
- 4 Disconnect all network cables from the Tablet-PC.
-  **NOTICE:** To avoid damaging the system board, you must remove the main battery before you service the Tablet-PC.
- 5 Close the display and turn the Tablet-PC upside-down on a flat work surface.
- 6 Slide the two battery-bay latch releases on the bottom of the Tablet-PC outward to each side.
- 7 Slide the main battery from the battery bay.

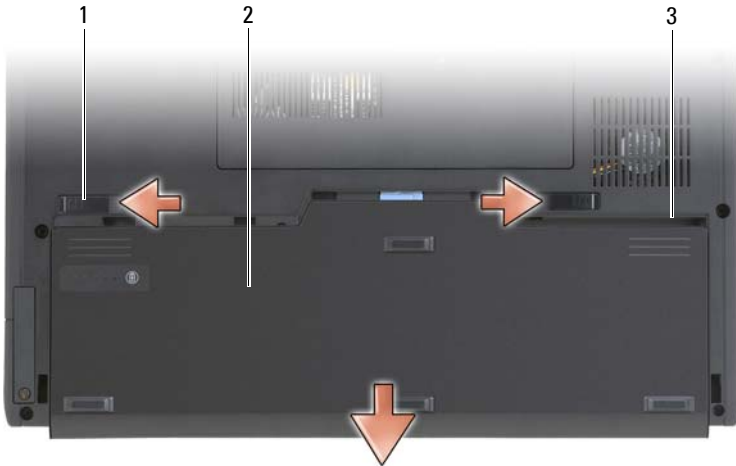

- 1 battery release latches (2) 2 battery
3 battery bay

Installing the Main Battery

- 1 Align the main battery with the sides of the battery bay.
- 2 Slide the main battery into the battery bay until you feel a click, ensuring that the battery is firmly and properly seated.
- 3 Turn the Tablet-PC top-side up on a flat work surface and open the display.
- 4 Connect any network cables.
- 5 Turn on your Tablet-PC by pressing the power button.

Hard Drive

- ⚠ CAUTION:** If you remove the hard drive from the Tablet-PC when the drive is hot, *do not touch* the metal housing of the hard drive.
- ⚠ CAUTION:** Before working inside your Tablet-PC, follow the safety instructions located in the *Product Information Guide*.

➔ **NOTICE:** To prevent data loss, turn off your Tablet-PC (see "Turning Off Your Tablet-PC" on page 155) before removing the hard drive. Do not remove the hard drive while the Tablet-PC is on, in sleep, standby, or hibernate mode.

➔ **NOTICE:** Hard drives are extremely fragile; even a slight bump can damage the drive.

🔧 **NOTE:** Dell does not guarantee compatibility or provide support for hard drives from sources other than Dell.

Removing the Hard Drive

- 1 Follow the procedures in "Before You Begin" on page 155.
- 2 Turn the Tablet-PC over, and loosen the two captive screws on the metal bracket that holds the hard drive.

➔ **NOTICE:** When the hard drive is not in the Tablet-PC, store it in protective antistatic packaging. See "Protecting Against Electrostatic Discharge" in the *Product Information Guide*.

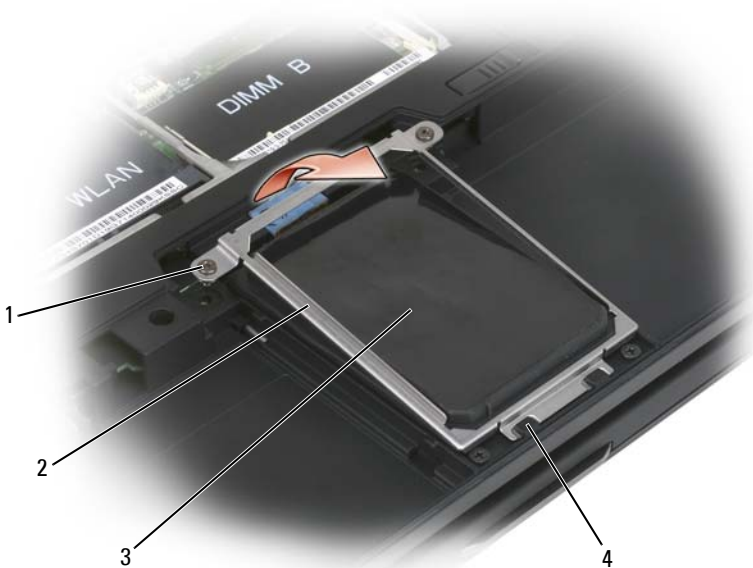

- | | | | |
|---|--------------------|---|-------------------|
| 1 | captive screws (2) | 2 | metal bracket |
| 3 | hard drive | 4 | securing tabs (2) |

3 Holding the metal bracket by the sides, slide the bracket toward the back of the Tablet-PC to dislodge the bracket from the two metal clips and set the bracket aside.

4 Use the pull-tab to disconnect the hard drive cable from the system board connector and remove the hard drive from the Tablet-PC.



- | | | | |
|---|----------------|---|------------|
| 1 | pull-tab | 2 | hard drive |
| 3 | alignment ribs | | |

Installing the Hard Drive

1 Follow the procedures in "Before You Begin" on page 155.

 **NOTICE:** When the hard drive is not in the Tablet-PC, store it in protective antistatic packaging. See "Protecting Against Electrostatic Discharge" in the *Product Information Guide*.

- 2 Remove the new drive from its packaging.
Save the original packaging for storing or shipping the hard drive.

 **NOTICE:** Use firm and even pressure to slide the drive into place. If you use excessive force, you may damage the connector.

- 3 Place the hard drive into the hard drive bay, seating it firmly between the hard drive alignment ribs in the base.
- 4 Connect the hard drive cable to the system board connector.
- 5 Insert the two metal tabs of the metal bracket under the metal clips in the hard drive bay, then lower the bracket down over the hard drive.
- 6 Tighten the two captive screws on the metal bracket.
- 7 Use the *Operating System* media to install the operating system for your Tablet-PC. (See "Using the Operating System Media" on page 151.)
- 8 Use the *Drivers and Utilities* media to install the drivers and utilities for your Tablet-PC. (See "Using the Drivers and Utilities Media" on page 147).

Subscriber Identity Module (SIM) Card

 **NOTICE:** To protect the SIM card from electrostatic discharge (ESD), do not touch the SIM card connector. Also, take care when removing the card to slide the card completely out of the metal tabs before lifting the card out of the slot. The card is brittle and may easily break.

 **NOTE:** The SIM card is located in the battery bay. You must remove the main battery before you can access the SIM card.

Removing the SIM Card

- 1 Follow the procedures in "Before You Begin" on page 155.
- 2 Push in the SIM card, then release the card.
- 3 Pull the SIM card from the SIM card slot and place it to one side.



1 SIM card

2 battery bay

 **NOTE:** When you replace the SIM card, ensure that you insert the SIM card into the SIM card slot with the cut-off corner of the card facing toward the front of the Tablet-PC.

Installing the SIM Card

- 1 Insert the SIM card into the slot with the cut-off corner of the card facing toward the front of the Tablet-PC.
- 2 Push the card until it is firmly seated in the connector.

 **NOTE:** If the card extends out into the battery bay, it is not fully installed.

Internal Card With Bluetooth[®] Wireless Technology

 **CAUTION:** Before performing the following procedures, follow the safety instructions in your *Product Information Guide*.

 **NOTICE:** To avoid electrostatic discharge, ground yourself by using a wrist grounding strap or by periodically touching a connector on the back panel of the Tablet-PC.

 **NOTICE:** To avoid damaging the system board, you must remove the main battery before you begin working inside the Tablet-PC.

If you ordered an internal card with Bluetooth wireless technology with your Tablet-PC, it is already installed.

Remove the Internal Card Caddy

If your Tablet-PC has Bluetooth wireless technology, the Bluetooth card is installed in the internal card caddy.

➔ NOTICE: Before touching anything inside your Tablet-PC, ground yourself by touching an unpainted metal surface, such as the metal at the back of your computer. While you work, periodically touch an unpainted metal surface to dissipate static electricity, which could harm internal components.

- 1 Follow the procedures in "Before You Begin" on page 155.
- 2 Close the display and turn your Tablet-PC top-down on a flat work surface. Orient the unit so that the front is toward you.
- 3 Find the internal card caddy. It is located near the front left corner (see the picture below).

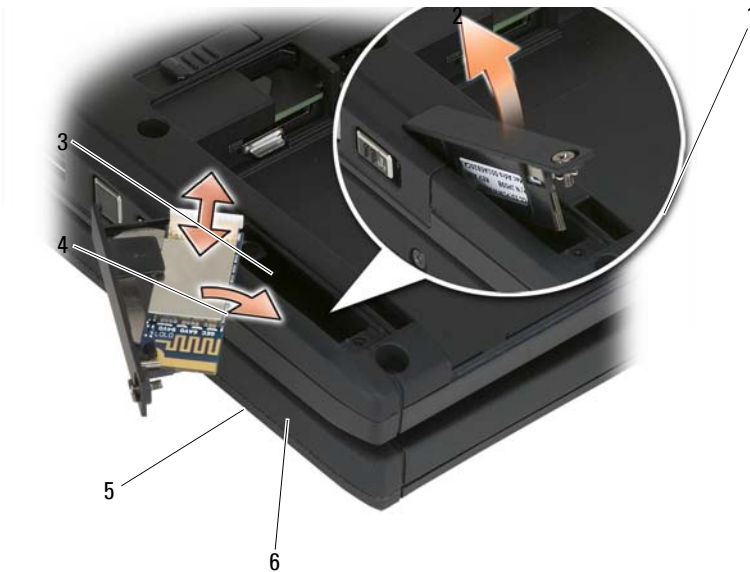

- | | | | |
|---|----------------------|---|-----------------------|
| 1 | captive screw | 2 | card caddy |
| 3 | cable connector | 4 | plastic alignment tab |
| 5 | plastic securing tab | 6 | Bluetooth card |

 **NOTICE:** Be careful when removing the card to avoid damaging the card, card cable, or surrounding components.

- 4 Loosen the captive screw and, lifting the end with the captive screw first, gently remove the card caddy from your Tablet-PC. If a card is installed in the card caddy, ensure that excessive force is not applied to the connecting cable.
- 5 If a card is installed in the card caddy, disconnect the cable from the card. Remove the card from the card caddy by gently lifting the plastic securing tab and sliding the card out of the caddy.
- 6 If no card was installed in the card caddy, find the cable in the space opened by removing the card caddy and gently lift the connector end out so that it is accessible.

Installing a Bluetooth Card

 **NOTICE:** Before touching anything inside your Tablet-PC, ground yourself by touching an unpainted metal surface, such as the metal at the back of your Tablet-PC. While you work, periodically touch an unpainted metal surface to dissipate static electricity, which could harm internal components.

- 1 Seat the Bluetooth card into the card caddy, sliding the corner with the hole under the plastic securing tab. The connector end of the card should be pointing away from the card caddy end with the captive screw.
- 2 Connect the Bluetooth card cable to the card.
- 3 Fold the excess cable as shown in the picture below and hold it next to the card.



- 4 Insert the tabbed-end of the card caddy into the base, then lower the screw end into the base. See the picture below.



- 5 Tighten the captive screw.

Installing the Main Battery

- 1 Align the main battery with the sides of the battery bay.
- 2 Slide the main battery into the battery bay until you feel a click, ensuring that the battery is firmly and properly seated. Verify that the battery release tabs are positioned toward the middle of the unit.
- 3 Turn your Tablet-PC top-side up on a flat work surface and open the display.
- 4 Dock and/or reconnect cables to your Tablet-PC as needed.
- 5 Power on your Tablet-PC by pressing the power button. Verify that the operating system starts normally.

Memory and Mini-Card Cover

! **CAUTION:** Before you begin any of the procedures in this section, follow the safety instructions located in the *Product Information Guide*.

- ➔ NOTICE:** To prevent damage to the system board, remove the main battery before you service the Tablet-PC.

Removing the Memory and Mini-Card Cover

- 1 Follow the procedures in "Before You Begin" on page 155.
- 2 Turn the Tablet-PC upside-down, loosen the two captive screws on the memory and Mini-Card cover, and remove the cover.



Installing the Memory and Mini-Card Cover

- 1 Follow the procedures in "Before You Begin" on page 155.
- 2 Turn the Tablet-PC upside-down, fit the cover into place, and tighten the two captive screws on the memory and Mini-Card cover.

Memory

You can increase your Tablet-PC memory by installing memory modules on the system board. See "Specifications" on page 42 for information on the memory supported by your Tablet-PC. Install only memory modules that are intended for your Tablet-PC.



CAUTION: Before you begin any of the procedures in this section, follow the safety instructions located in the *Product Information Guide*.



NOTICE: To prevent damage to the system board, remove the main battery before you service the Tablet-PC.

Removing a Memory Module

- 1 Follow the procedures in "Before You Begin" on page 155.
- 2 Remove the memory and Mini-Card cover. See "Removing the Memory and Mini-Card Cover" on page 168.



NOTE: Memory modules purchased from Dell are covered under your Tablet-PC warranty.



NOTICE: To prevent damage to the memory module connector, do not use tools to spread the memory-module securing clips.

- 3 Ground yourself by touching one of the metal connectors on the back of the Tablet-PC.
- 4 Use your fingertips to carefully spread apart the securing clips on each end of the memory module connector until the module pops up.
- 5 Remove the module from the connector and set aside.

Installing a Memory Module

- 1 Ground yourself by touching one of the metal connectors on the back of the Tablet-PC.



NOTE: If the memory module is not installed properly, the Tablet-PC may not boot properly. No error message indicates this failure.

- 2 Align the notch in the module edge connector with the tab in the connector slot.
- 3 Slide the module firmly into the slot at a 45-degree angle, and rotate the module down until it clicks into place. If you do not feel the click, remove the module and reinstall it.

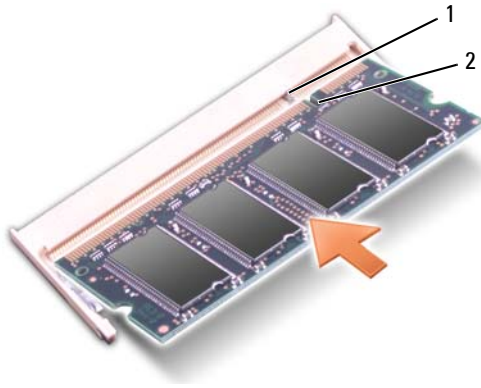

1 tab

2 notch

4 Replace the memory and Mini-Card cover, and tighten the two captive screws (see "Installing the Memory and Mini-Card Cover" on page 168).

➔ **NOTICE:** If the cover is difficult to close, remove the module and reinstall it. Forcing the cover to close may damage your Tablet-PC.

5 Insert the battery into the battery bay, or connect the AC adapter to your Tablet-PC and an electrical outlet.

6 Turn on the Tablet-PC.

As the Tablet-PC boots, it detects the additional memory and automatically updates the system configuration information.

To confirm the amount of memory installed in the Tablet-PC:

- In Windows Vista, click **Start** , and right-click **Computer** → **Properties**.
- In Windows XP, click **Start**, and right-click **My Computer** → **Properties**.

Mini-Card

Your Tablet-PC supports a wireless wide area network (WWAN) card and a Wireless Local Area Network (WLAN) card; both Mini-Cards are installed the same way, although they have different connectors on the system board. If you ordered a Mini-Card with your Tablet-PC, the card is already installed.

 **CAUTION:** Before you begin any of the procedures in this section, follow the safety instructions located in the *Product Information Guide*.

- ➔ NOTICE:** To prevent damage to the system board, remove the main battery before you service the Tablet-PC.

Removing a Mini-Card

- 1 Follow the procedures in "Before You Begin" on page 155.
- 2 Remove the memory and Mini-Card cover. See "Removing the Memory and Mini-Card Cover" on page 168.



1 WWAN slot

2 WLAN slot

- 3 Ground yourself by touching one of the metal connectors on the back of the Tablet-PC.

✎ NOTE: If you leave the area, ground yourself again when you return to the Tablet-PC.

- 4 Disconnect the cables from the card.

✎ NOTE: The solid black and white cables belong to the WLAN Mini-Card if you have installed one, while the white-striped gray, white-striped black, and the solid gray cables belong to the WWAN Mini-Card you may have installed.

✎ NOTE: Depending on the type of Mini-Card you have, not all cables may be in use.

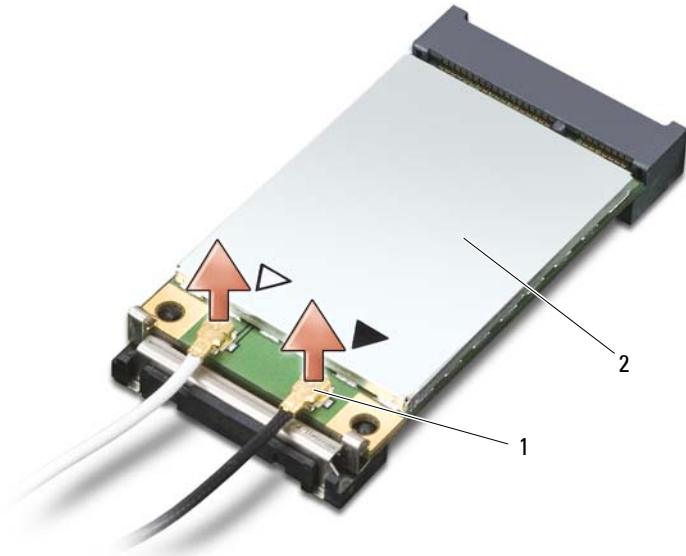

1 antenna cable connectors (2) 2 Mini-Card

- 5** Release the card by pushing the metal securing tab away from the card until the card pops up slightly.

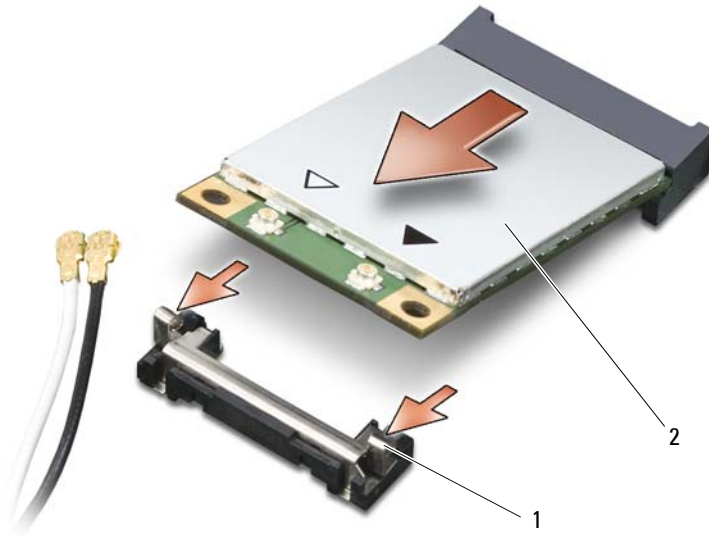

1 metal securing tabs (2) 2 Mini-Card

6 Slide the card at a 45-degree angle out of its connector.

Installing a Mini-Card

➔ **NOTICE:** To avoid damaging the Mini-Card, never place cables on top of or under the card.

➔ **NOTICE:** The connectors are keyed to ensure correct insertion. If you feel resistance, check the connectors and realign the card.

✎ **NOTE:** Depending on the type of Mini-Card you have, not all cables may be in use.

✎ **NOTE:** Do not insert a Mobile Broadband (WWAN) network adapter into the WLAN card connector, or vice-versa.

✎ **NOTE:** The Mini-Card may have two or three connectors, depending on the type of card you ordered.

1 Move any cables out of the way to make space for the Mini-Card.

- 2 Align the card with the connector at a 45-degree angle, and press the card into the connector until it clicks.
-  **NOTE:** For more specific information about which cable to connect to which connector, see the documentation that came with your Mini-Card.
- 3 Connect the cables to the Mini-Card, ensuring that you route the cables correctly.
 - 4 Replace the memory and Mini-Card cover, and tighten the two captive screws. See "Installing the Memory and Mini-Card Cover" on page 168.

Hinge Cover



CAUTION: Before you begin any of the procedures in this section, follow the safety instructions in the *Product Information Guide*.



NOTICE: To avoid electrostatic discharge, ground yourself by using a wrist grounding strap or by periodically touching an unpainted metal surface (such as a connector on the back of the Tablet-PC).



NOTICE: The hinge cover is fragile and can be damaged if extreme force is used. Be careful when removing the hinge cover.

Removing the Hinge Cover

- 1 Follow the procedures in "Before You Begin" on page 155.
 - 2 Turn the Tablet-PC top-side up, and then open the display all the way (180 degrees) so that the display rests on your work surface.
-  **NOTICE:** To avoid damaging the hinge cover, do not lift the cover on both sides simultaneously. Removing the hinge cover in a different way than described may cause the plastic to break.

- ➔ **NOTICE:** To avoid electrostatic discharge, ground yourself by using a wrist grounding strap or by periodically touching an unpainted metal surface (such as the back panel) on the Tablet-PC.

Removing the Keyboard

- 1 Follow the instructions in "Before You Begin" on page 155.
- 2 Remove the hinge cover (see "Removing the Hinge Cover" on page 174).
- ➔ **NOTICE:** The keycaps on the keyboard are fragile, easily dislodged, and time-consuming to replace. Be careful when removing and handling the keyboard.
- 3 Remove the two M2 x 3-mm screws to either side of the rotating hinge at the top of the keyboard.

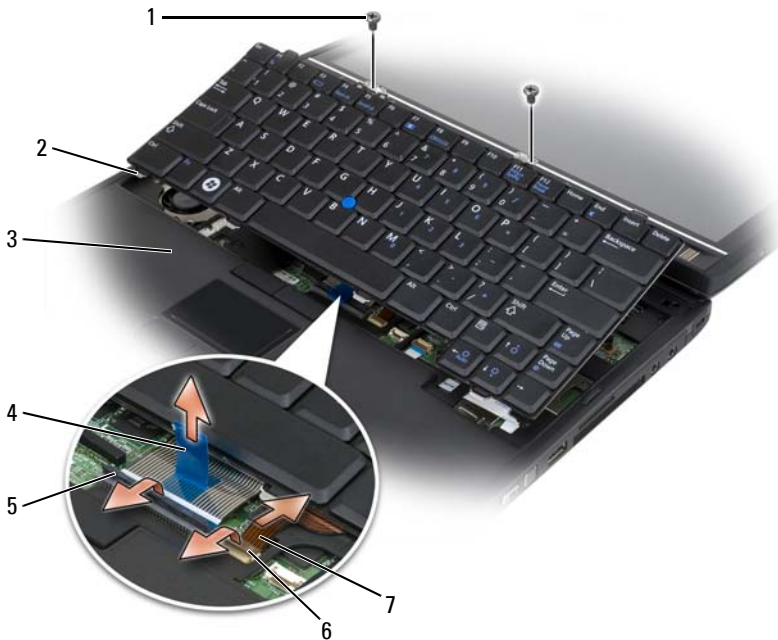

- | | | | |
|---|----------------------------|---|-------------------------------|
| 1 | screws (2) | 2 | keyboard tabs (4) |
| 3 | palm rest | 4 | keyboard-cable pull-tab |
| 5 | keyboard-cable locking arm | 6 | track stick-cable locking arm |
| 7 | track stick cable | | |



NOTE: Lift the keyboard carefully in [step 4](#) to ensure that you do not pull on the keyboard cable.

- 4 Rotate the keyboard up 45-degrees to gain access to the keyboard connector.
- 5 Lift the keyboard cable locking arm up to access the keyboard cable. Pull up on the keyboard cable pull-tab to remove the keyboard cable from the connector. (Do not pull on the keyboard cable pull-tab to disengage the locking arm. This will damage the connector and or the keyboard cable.)
- 6 Lift the connector locking arm up to access the track stick cable. Pull up on the track stick cable pull-tab to remove the track stick cable from the connector. (Do not pull on the track stick cable pull-tab to disengage the connector locking arm. This will damage the connector and or the keyboard cable.)
- 7 Lift the keyboard from the computer and place it to one side.

Installing the Keyboard



NOTE: When you replace the keyboard, ensure that the keyboard tabs are completely in place to avoid scratching the palm rest.

- 1 Slip the track stick cable into the track stick cable connector on the system board and press the track stick-cable locking arm down to hold the cable in place. Use the pull-tabs on the track stick cable to install the track stick cable into the connector.
- 2 Insert the keyboard cable into the keyboard cable connector on the system board and press the keyboard-cable locking arm down to hold the cable in place. Use the pull-tabs on the keyboard cable to install the keyboard cable into the connector.
- 3 Holding the keyboard at a slight angle, insert the four metal tabs of the keyboard into the four metal slots of the palm rest.
- 4 Tighten the two M2 x 3-mm screws at the top of the keyboard.
- 5 Install the hinge cover (see "Installing the Hinge Cover" on page 175).

Coin-Cell Battery



CAUTION: Before performing the following procedures, follow the safety instructions in your *Product Information Guide*.

- ➔ **NOTICE:** To avoid electrostatic discharge, ground yourself by using a wrist grounding strap or by periodically touching a connector on the back panel of the Tablet-PC.
- ➔ **NOTICE:** To avoid damaging the system board, you must remove the main battery before you begin working inside the Tablet-PC.

Removing the Coin-cell Battery

- 1 Follow the procedures in "Before You Begin" on page 155.
- 2 Remove the hinge cover (see "Removing the Hinge Cover" on page 174).
- 3 Remove the keyboard (see "Removing the Keyboard" on page 176).
- 4 Remove the coin-cell battery connector from the connector on the system board.
- 5 Using your fingers, pry the coin-cell battery from the system base.



- 1 coin-cell battery connector 2 coin-cell battery

Installing the Coin-Cell Battery

- 1 Place the battery into position, pressing firmly to affix the battery to the sticky tape on the base.

- 2 Connect the coin-cell battery connector to the connector on the system board.
- 3 Install the keyboard (see "Installing the Keyboard" on page 177).
- 4 Install the hinge cover (see "Installing the Hinge Cover" on page 175).

Display Assembly



CAUTION: Before performing the following procedures, follow the safety instructions in your *Product Information Guide*.



NOTICE: To avoid electrostatic discharge, ground yourself by using a wrist grounding strap or by periodically touching a connector on the back panel of the Tablet-PC.



NOTICE: To avoid damaging the system board, you must remove the main battery before you begin working inside the Tablet-PC.

Removing the Display Assembly

- 1 Follow the procedures in "Before You Begin" on page 155.
- 2 Remove the hinge cover (see "Removing the Hinge Cover" on page 174).
- 3 Remove the keyboard (see "Removing the Keyboard" on page 176).
- 4 Remove any installed Mini-Cards (see "Removing a Mini-Card" on page 171).
- 5 Use the pull-tab to disconnect the display cable from the system board.



- | | | | |
|---|----------------------------|---|-------------------------|
| 1 | display | 2 | M2.5 x 5-mm screws (5) |
| 3 | display connector pull-tab | 4 | display cable connector |
| 5 | antenna cables (3) | 6 | antenna channel |

- 6** Feed the Mini-Card antenna cables from the bottom through the cable channel to the top of the system.
- 7** Loosen the five M2.5 x 5-mm screws.
- 8** Turn the system upside-down and remove the base grip:
 - a** Remove the two M2.5 x 5-mm screws.

- b Pry the base grip from the back of the rotating hinge and set the base grip aside.

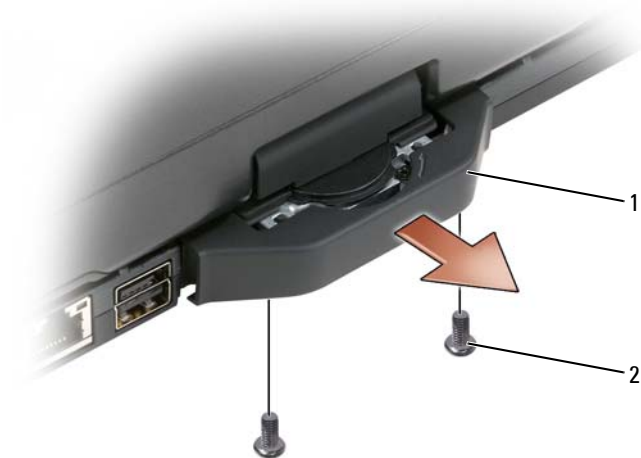

1 base grip

2 M2.5 x 5-mm screws (2)

- 9 Turn the system top-side up, and remove the two M2.5 x 5-mm screws from the top of the rotating hinge.



- 1 M2.5 x 5-mm screws (2)
- 10 Lift the display assembly from the base, and place the display assembly to one side.

Installing the Display Assembly

- 1 Place the display assembly on the base.
- 2 Feed the Mini-Card antenna cables from the top through the antenna channel to the bottom of the system.

Align the shrink tube that is wrapped around the antenna cables to the edge of the palm rest. Make sure the antenna cables are flat (contained within the recessed area) and do not overlap. Secure the antenna cables with the tape that was removed from the cables when removing the display assembly.



NOTE: If the cables do not lie flat in the recessed area or if they overlap the palm rest, then the keyboard will not sit flat on the palm rest.

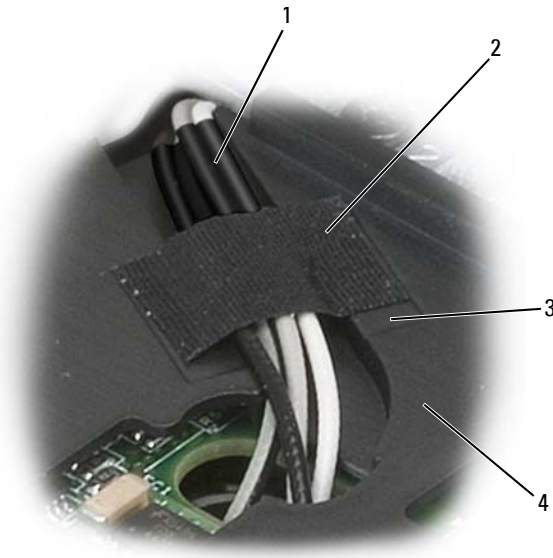

- | | | | |
|---|-------------|---|-----------|
| 1 | shrink tube | 2 | tape |
| 3 | tape recess | 4 | palm rest |

- 3** Connect the display cable to the system. When doing so, make sure that:
- The pull-tab is lying flat in the recessed area. If the bale wire is not flush to the palm rest, the keyboard will not sit flat on the palm rest.
 - The LCD cable wires are flush to or below the palm rest surface so that the keyboard can sit flat on the palm rest.



- | | | | |
|---|----------------------------|---|-------------------------|
| 1 | display | 2 | M2.5 x 5-mm screws (5) |
| 3 | display connector pull-tab | 4 | display cable connector |
| 5 | antenna cables (3) | 6 | antenna channel |

- 4 Tighten the five M2.5 x 5-mm screws.
- 5 Close the Tablet-PC and turn it around so that you can access the back of the rotating hinge.
- 6 Tighten the two M2.5 x 5-mm screws on the top of the rotating hinge.



- 1** M2.5 x 5-mm screws (2)
- 7** Turn the Tablet-PC upside-down and install the base grip:
 - a** Clip the base grip onto the back of the rotating hinge.
 - b** Tighten the two M2.5 x 5-mm screws.

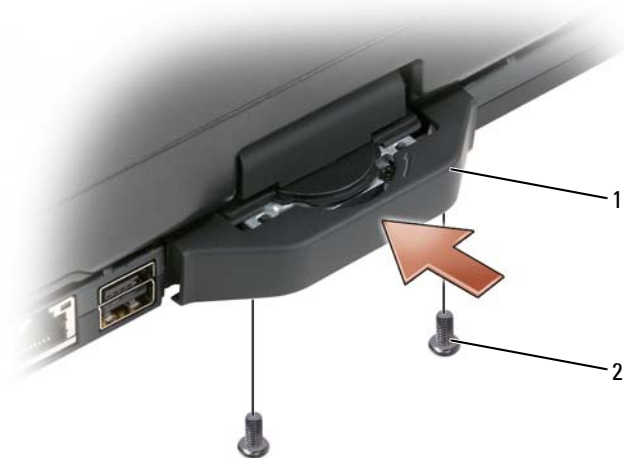

1 base grip

2 M2.5 x 5-mm screws (2)

- 8 Install any applicable Mini-Cards (see "Installing a Mini-Card" on page 173).
- 9 Install the keyboard (see "Installing the Keyboard" on page 177).
- 10 Install the hinge cover (see "Installing the Hinge Cover" on page 175).

Palm Rest



CAUTION: Before performing the following procedures, follow the safety instructions in your *Product Information Guide*.



NOTICE: To avoid electrostatic discharge, ground yourself by using a wrist grounding strap or by periodically touching a connector on the back panel of the Tablet-PC.



NOTICE: To avoid damaging the system board, you must remove the main battery before you begin working inside the Tablet-PC.

Removing the Palm Rest

- 1 Follow the procedures in "Before You Begin" on page 155.

- 2 Remove the hard drive (see "Removing the Hard Drive" on page 160).
- 3 Remove the hinge cover (see "Removing the Hinge Cover" on page 174).
- 4 Remove the display assembly (see "Removing the Display Assembly" on page 179).
- 5 Remove the keyboard (see "Removing the Keyboard" on page 176).
- 6 Remove any installed Mini-Cards (see "Removing a Mini-Card" on page 171).
- 7 Disconnect the touch pad cable.
- 8 Turn the Tablet-PC upside down and remove the eleven M2.5 x 5-mm screws.



- 9 From the top side of the Tablet-PC, remove the four M2.5 x 5-mm screws labeled with a "P".

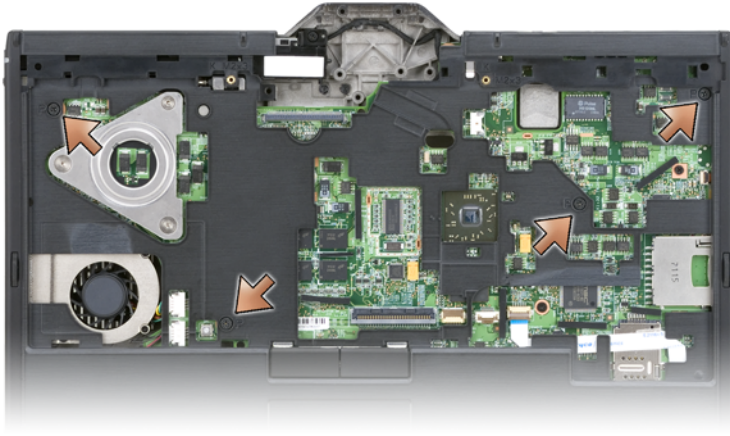

- 10** Disengage the five snaps at the front of the system by using your fingers to pry the edge of the base away from the palm rest.
- 11** Turn the Tablet-PC top-side up and, lifting the front end slightly upward and moving in a clock-wise manner, disengage the snaps at the sides and back of the system.

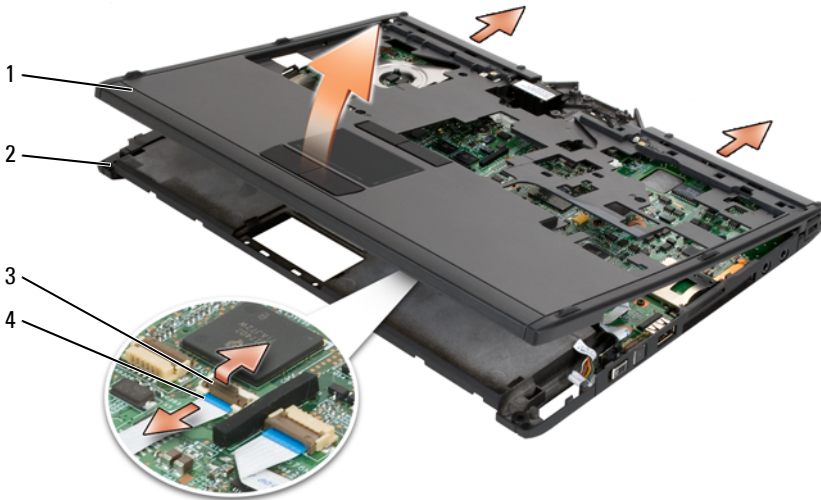

- | | | | |
|---|-----------------------------|---|-----------------|
| 1 | palm rest | 2 | base |
| 3 | touch pad cable-locking arm | 4 | touch pad cable |

Installing the Palm Rest

- 1 Place the palm rest on top of the base, and engage the snaps around the palm rest edges by pressing with your fingers in a counter-clockwise manner.
- 2 Turn the Tablet-PC upside down and tighten the eleven M2.5 x 5-mm bottom screws.
- 3 Turn the Tablet-PC top-side up and tighten the five M2.5 x 5-mm screws labeled with a "P".
- 4 Connect the touch pad cable to the system board connector.
- 5 Install any Mini-Cards (see "Installing a Mini-Card" on page 173).
- 6 Install the keyboard (see "Installing the Keyboard" on page 177).
- 7 Install the display assembly (see "Installing the Display Assembly" on page 182).
- 8 Install the hinge cover (see "Installing the Hinge Cover" on page 175).
- 9 Install the hard drive (see "Installing the Hard Drive" on page 161).

System Board

 **CAUTION:** Before performing the following procedures, follow the safety instructions in your *Product Information Guide*.

 **NOTICE:** To avoid electrostatic discharge, ground yourself by using a wrist grounding strap or by periodically touching a connector on the back panel of the Tablet-PC.

 **NOTICE:** To avoid damaging the system board, you must remove the main battery before you begin working inside the Tablet-PC.

Removing the System Board

- 1 Follow the procedures in "Before You Begin" on page 155.
- 2 Remove the hinge cover (see "Removing the Hinge Cover" on page 174).

- 3 Remove the display assembly (see "Removing the Display Assembly" on page 179).
- 4 Remove the keyboard (see "Removing the Keyboard" on page 176).
- 5 Remove any installed Mini-Cards (see "Removing a Mini-Card" on page 171).
- 6 Remove the palm rest (see "Removing the Palm Rest" on page 186).
- 7 Remove the speaker from the base:
 - a Disconnect the speaker cable from the speaker system board connector.
 - b Lift the speaker from the base and set the speaker aside.

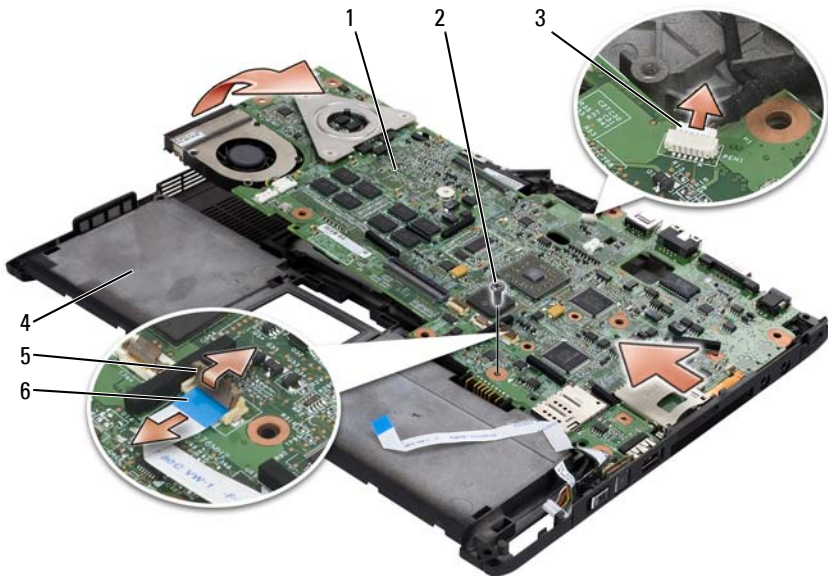

- | | | | |
|---|-----------------------------------|---|-----------------------|
| 1 | system board | 2 | M2.5 x 5 screw |
| 3 | pen indicator cable | 4 | base |
| 5 | wireless-switch cable-locking arm | 6 | wireless switch cable |

- 8 Disconnect the wireless switch cable from the system board.

- 9 Disconnect the pen indicator cable from the system board.
- 10 Remove the M2.5 x 5-mm screw marked with a silver triangle.
- 11 Remove the system board from the base, lifting from right to left, and set the system board aside.

Installing the System Board

- 1 Seat the system board into the base from left to right.
- 2 Tighten the M2.5 x 5-mm screw into the screw hole marked with a silver triangle on the system board.
- 3 Connect the pen indicator cable to the system board.
- 4 Connect the wireless switch cable to the system board.
- 5 Replace the speaker module:
 - a Lower the speaker into the base.
 - b Connect the speaker cable to the speaker system board connector.
- 6 Install the palm rest (see "Installing the Palm Rest" on page 189).
- 7 Install any Mini-Cards (see "Installing a Mini-Card" on page 173).
- 8 Install the keyboard (see "Installing the Keyboard" on page 177).
- 9 Install the display assembly (see "Installing the Display Assembly" on page 182).
- 10 Install the hinge cover (see "Installing the Hinge Cover" on page 175).

Fan

 **CAUTION:** Before performing the following procedures, follow the safety instructions in your *Product Information Guide*.

 **NOTICE:** To avoid electrostatic discharge, ground yourself by using a wrist grounding strap or by periodically touching a connector on the back panel of the Tablet-PC.

 **NOTICE:** To avoid damaging the system board, you must remove the main battery before you begin working inside the Tablet-PC.

Removing the Fan

- 1 Follow the procedures in "Before You Begin" on page 155.

- 2 Remove the hinge cover (see "Removing the Hinge Cover" on page 174).
- 3 Remove the display assembly (see "Removing the Display Assembly" on page 179).
- 4 Remove the keyboard (see "Removing the Keyboard" on page 176).
- 5 Remove any installed Mini-Cards (see "Removing a Mini-Card" on page 171).
- 6 Remove the palm rest (see "Removing the Palm Rest" on page 186).
- 7 Remove the system board (see "Removing the System Board" on page 189), and place it upside-down on a clean work surface.
- 8 Disconnect the fan cable from the system board.
- 9 Using a #0 Phillips screwdriver, remove the four M2 x 3-mm screws, and lift the fan from the system board.

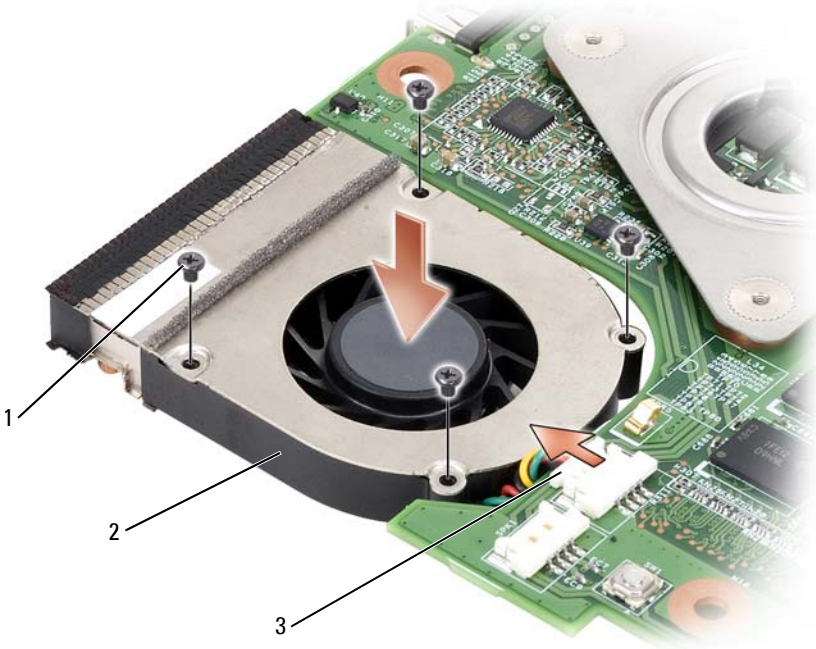

- | | | | |
|---|----------------------|---|-----|
| 1 | M2 x 3-mm screws (4) | 2 | fan |
| 3 | fan cable connector | | |

Installing the Fan

- 1 Seat the fan into the system board, and tighten the four M2 x 3-mm screw using a #0 Phillips screwdriver.
- 2 Connect the fan cable to the system board.
- 3 Install the system board (see "Installing the System Board" on page 191).
- 4 Install the palm rest (see "Installing the Palm Rest" on page 189).
- 5 Install the keyboard (see "Installing the Keyboard" on page 177).
- 6 Install the display assembly (see "Installing the Display Assembly" on page 182).
- 7 Install the hinge cover (see "Installing the Hinge Cover" on page 175).
- 8 Install any Mini-Cards (see "Installing a Mini-Card" on page 173).

Pen and Whip Antenna Assembly



CAUTION: Before performing the following procedures, follow the safety instructions in your *Product Information Guide*.



NOTICE: To avoid electrostatic discharge, ground yourself by using a wrist grounding strap or by periodically touching a connector on the back panel of the Tablet-PC.



NOTICE: To avoid damaging the system board, you must remove the main battery before you begin working inside the Tablet-PC.

Removing the Pen and Whip Antenna Assembly

- 1 Follow the procedures in "Before You Begin" on page 155.
- 2 Remove the hinge cover (see "Removing the Hinge Cover" on page 174).
- 3 Remove the display assembly (see "Removing the Display Assembly" on page 179).
- 4 Remove the keyboard (see "Removing the Keyboard" on page 176).

- 5 Remove any installed Mini-Cards (see "Removing a Mini-Card" on page 171).
- 6 Remove the palm rest (see "Removing the Palm Rest" on page 186).
- 7 Remove the system board (see "Removing the System Board" on page 189).
- 8 Remove the two M2 x 3-mm screws.
- 9 Remove the pen missing cable and whip antenna cable from their routing channels, then lift the pen assembly and whip antenna assembly from the base.

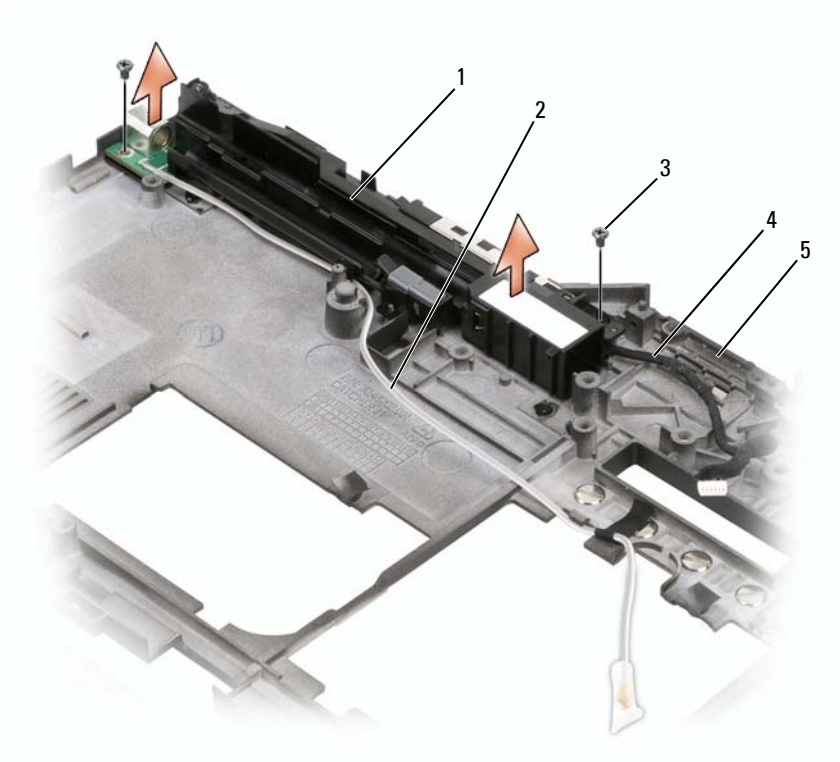

- | | | | |
|---|-------------------------------|---|--------------------|
| 1 | pen and whip antenna assembly | 2 | pen-missing cable |
| 3 | M2 x 3-mm screws (2) | 4 | whip antenna cable |
| 5 | base | | |

Installing the Pen and Whip Antenna Assembly

- 1 Seat the pen-missing cable and whip antenna cable into their routing channels. Route the pen-missing cable through the base hooks by the grip area. Use tape to hold the cable down through the base hooks.
- 2 Tighten the two M2 x 3-mm screws.
- 3 Install the system board (see "Installing the System Board" on page 191).
- 4 Install the palm rest (see "Installing the Palm Rest" on page 189).
- 5 Install the display assembly (see "Installing the Display Assembly" on page 182).
- 6 Install any Mini-Cards (see "Installing a Mini-Card" on page 173).
- 7 Install the keyboard (see "Installing the Keyboard" on page 177).
- 8 Install the hinge cover (see "Installing the Hinge Cover" on page 175).

Wireless Switch



CAUTION: Before performing the following procedures, follow the safety instructions in your *Product Information Guide*.



NOTICE: To avoid electrostatic discharge, ground yourself by using a wrist grounding strap or by periodically touching a connector on the back panel of the Tablet-PC.



NOTICE: To avoid damaging the system board, you must remove the main battery before you begin working inside the Tablet-PC.

Removing the Wireless Switch

- 1 Follow the procedures in "Before You Begin" on page 155.
- 2 Remove the hinge cover (see "Removing the Hinge Cover" on page 174).
- 3 Remove the display assembly (see "Removing the Display Assembly" on page 179).

- 4 Remove the keyboard (see "Removing the Keyboard" on page 176).
- 5 Remove any installed Mini-Cards (see "Removing a Mini-Card" on page 171).
- 6 Remove the palm rest (see "Removing the Palm Rest" on page 186).
- 7 Remove the system board (see "Removing the System Board" on page 189).
- 8 Remove the M2.5 x 5-mm screw.
- 9 Lift the wireless switch from the base, and set the switch aside.

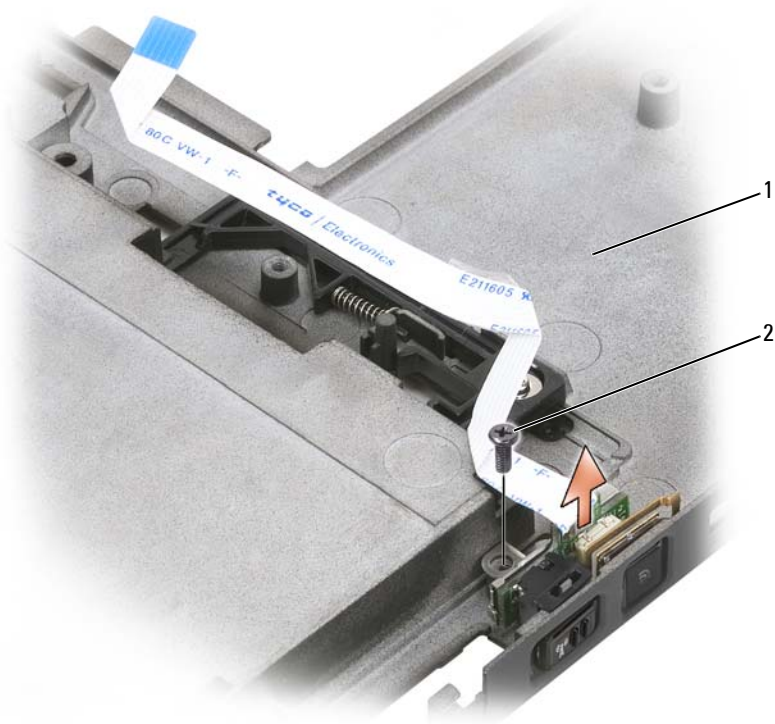

1 base

2 M2.5 x 5-mm screw

Installing the Wireless Switch

- 1** Set the wireless switch into the base.
- 2** Tighten the M2.5 x 5-mm screw. Slide the wireless On/Off switch to confirm that the board is connected to the base correctly. If the switch is too tight, then the alignment of the board to the base shifted during assembly. Loosen the M2.5 x 5-mm screw and confirm that the alignment of the bracket hole to the base hole is concentric.
- 3** Install any Mini-Cards (see "Installing a Mini-Card" on page 173).
- 4** Install the keyboard (see "Installing the Keyboard" on page 177).
- 5** Install the display assembly (see "Installing the Display Assembly" on page 182).
- 6** Install the hinge cover (see "Installing the Hinge Cover" on page 175).

12

Dell™ D/Bay

⚠ CAUTION: Before performing any of the procedures in this section, follow the safety instructions in your *Product Information Guide*.

About the Dell D/Bay

You can install Dell Latitude™ D-Family devices such as a floppy drive, hard drive, or optical drive using the Dell D/Bay.

Setting Up and Using the D/Bay

Connect the D/Bay cable to the powered USB connector on your Tablet-PC or optional media base.



Removing and Installing Devices When the Tablet-PC Is Turned Off

➡ NOTICE: To prevent damage to devices, place them in a safe, dry place when they are not installed in the computer. Avoid pressing down on them or placing heavy objects on top of them.

- 1 Press the device latch release so that the latch release pops out.



- 2 Pull the device by the latch release to remove the device from the D/Bay.



- 3 Insert the new device into the bay, push the device until you feel a click, and push the device latch release in so that it is flush with the bay.
- 4 Connect the D/Bay cable to the powered USB connector on your Tablet-PC or media base.

Removing and Installing Devices While the Tablet-PC Is Running

- 1 Double-click the **Safely Remove Hardware** icon on the Windows Notification area.
 - 2 Click the device you want to eject.
- NOTICE:** To prevent damage to devices, place them in a safe, dry place when they are not installed in the computer. Avoid pressing down on them or placing heavy objects on top of them.
- 3 Press the device latch release so that the latch release pops out.



- 4 Pull the device by the latch release to remove the device from the D/Bay.



- 5** Insert the new device into the bay, push the device until you feel a click, and push the device latch release in so that it is flush with the bay.
Windows automatically recognizes the new device.
- 6** If necessary, enter your password to unlock your drive.

Media Base (Optional)

Left View



USB CONNECTOR

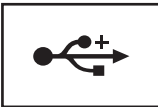

The USB 2.0-compliant connector allows you to connect USB devices, such as a mouse, keyboard, or printer.

OPTICAL DRIVE — Allows you to use CD and DVD media.

Right View



- 1 USB connector
- 2 Tablet-PC release lever
- 3 security cable slot

USB CONNECTOR

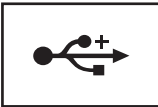

The USB 2.0-compliant connector allows you to connect USB devices, such as a mouse, keyboard, or printer.

TABLET-PC RELEASE LEVER — Releases the Tablet-PC from the media base if the media base is not secured by an antitheft device.

SECURITY CABLE SLOT — Lets you attach a commercially available antitheft device to the media base. Instructions for installing antitheft devices are usually included with the device. For more information, see "Securing the Media Base" on page 210.

Back View

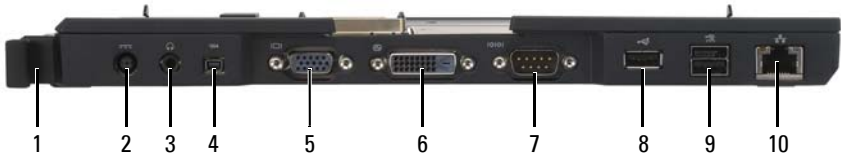

- | | | | |
|---|-------------------------|----|---|
| 1 | Tablet-PC release lever | 2 | AC adapter connector |
| 3 | audio connector | 4 | IEEE 1394 |
| 5 | VGA video connector | 6 | digital video interface (DVI) connector |
| 7 | serial connector | 8 | USB connector |
| 9 | powered USB connector | 10 | network connector |

TABLET-PC RELEASE LEVER — Lets you undock the Tablet-PC from the media base (see "Undocking Your Tablet-PC From the Media Base" on page 212).

AC ADAPTER CONNECTOR



Connects an AC adapter to the media base and to AC power to convert AC power to the DC power required by the media base. You can connect the AC adapter with your media base either turned on or off. For more information, see "Setting Up Your Media Base" on page 209.



CAUTION: If you are using a multiple-outlet power strip, use caution when you plug the AC adapter power cable into the power strip. Some power strips may allow you to insert the connector incorrectly. Incorrect insertion of the power connector could result in permanent damage to your media base as well as electric shock and/or fire. Ensure that you insert the ground prong of the power plug into the mating ground contact of the power strip.



NOTICE: When you disconnect the AC adapter from the media base, hold the adapter cable connector, not the cable itself, and pull firmly to avoid damaging the cable.

AUDIO CONNECTOR



Connect headphones or speakers. The connector is a stereo output connector.

IEEE 1394 CONNECTOR



Connect FireWire devices such as a camera, external hard drive, or external CD-ROM drive. Supports hot swapping, multiple speeds on the same bus, and time-based data transfer, providing bandwidth for multimedia operation.

VGA VIDEO CONNECTOR



Connects an external VGA monitor.



NOTE: When your Tablet-PC is docked, use the video connector on the media base.

DIGITAL-VIDEO INTERFACE (DVI) CONNECTOR



Connects an external DVI-compatible monitor, such as a flat-panel monitor. With an adapter cable, you can also connect an external VGA-compatible monitor to the DVI connector.

SERIAL CONNECTOR



Connects a serial device, such as a serial mouse or a handheld device.

USB CONNECTOR

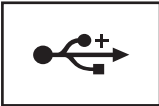

Connect USB devices, such as a mouse, keyboard, or printer.

POWERED USB CONNECTOR



Connect optional external D/Bay device, or standard USB devices, such as a mouse, keyboard, or printer.

NETWORK CONNECTOR

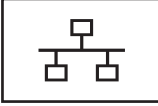

Connects the computer to a network. The solid light on the connector provides link status information. Off indicates no link, green indicates a 10-Mb/sec link, orange indicates a 100-Mb/sec link, and yellow indicates a 1000-Mb/sec link. The blinking yellow light on the connector indicates activity on the wired network connection.

For information on using the network adapter, see the network adapter documentation supplied with your computer under Windows Help and Support. To access Help and Support, see "Windows Help and Support" on page 19.

Top View



- 1 docking connector

DOCKING CONNECTOR — Allows you to dock your Tablet-PC to the media base (see "Docking Your Tablet-PC to the Media Base" on page 211 and "Undocking Your Tablet-PC From the Media Base" on page 212).

Setting Up Your Media Base

⚠ CAUTION: The AC adapter works with electrical outlets worldwide. However, power connectors and power strips vary among countries. Using an incompatible cable or improperly connecting the cable to the power strip or electrical outlet may cause fire or equipment damage.

➡ NOTICE: Always use the Dell AC adapter that came with the media base. If you use any other commercially available AC adapter—or the AC adapter from earlier models of Dell computers—you may damage the media base or the Tablet-PC.

➡ NOTICE: When you disconnect the Dell AC adapter cable from the Tablet-PC or media base, grasp the connector, not the cable itself, and pull firmly but gently to avoid damaging the cable. When you wrap the AC adapter cable, ensure that you follow the angle of the connector on the AC adapter to avoid damaging the cable.

- 1 Connect the AC adapter to the AC adapter connector on the media base and to an electrical outlet.



- 2 Before you dock your Tablet-PC to the media base for the first time, the Tablet-PC operating system must have completed its setup process. Do the following:

- a Ensure that the Tablet-PC is *not* connected to the media base or to the battery slice (docked).
- b Turn on the Tablet-PC.
- c Verify that the Microsoft® Windows® desktop appears.
- d Shut down the Tablet-PC (see "Turning Off Your Tablet-PC" on page 155).

Securing the Media Base

 **NOTE:** If the Tablet-PC is docked to the media base and an antitheft device is attached to the security cable slot on the media base, you cannot undock the Tablet-PC without first removing the antitheft device.



Attach a commercially available antitheft device to the security cable slot on the media base.

Antitheft devices usually include a segment of metal-stranded cable with an attached locking device and associated key. For instructions on installing this kind of antitheft device, see the documentation that accompanied the device.

Docking Your Tablet-PC to the Media Base

NOTE: If you are docking your Tablet-PC for the first time and have not completed the steps in "Setting Up Your Media Base" on page 209, complete them before proceeding to the next step.

NOTE: After docking the Tablet-PC for the first time, the Tablet-PC battery or the Tablet-PC AC adapter connection can power the media base if the media base is not connected to an AC adapter.

NOTE: Your Tablet-PC should be turned off when you dock it to the media base for the first time.

- 1 Ensure that your Tablet-PC is turned off if this is the first time it is being docked to the media base.
- 2 Align the back of the Tablet-PC with the back of the media base at an approximately 30-degree angle, and lower the front of the Tablet-PC onto the media base.



1 Tablet-PC

2 media base

3 Press the Tablet-PC onto the media base until it clicks and the Tablet-PC is firmly seated.

4 Turn on the Tablet-PC.

The operating system recognizes the media base.

Undocking Your Tablet-PC From the Media Base

➡ **NOTICE:** Never undock the Tablet-PC without first preparing the Tablet-PC for undocking. If you undock before preparing the Tablet-PC, you will lose data and the Tablet-PC may not recover normal operation for several minutes, if at all.

1 Before you undock your Tablet-PC, save and close any open files, and exit any open programs.

2 Set your Tablet-PC power management settings so that the Tablet-PC does not enter sleep, standby, or hibernate mode when you close (lower) the display:

a Click the Windows **Power**  icon in the Notification area to display the **Power** icon pop-up window.

b Click **More power options**.

c Under the **When I close the lid** drop-down menu, select **Do nothing**.

➡ **NOTICE:** If the Tablet-PC does not have a charged battery in the battery bay, you must shut down the Tablet-PC through the Windows **Start** menu and then undock the Tablet-PC. If you undock the Tablet-PC without a battery before shutting it down, you will lose data and the Tablet-PC may not recover normal operation for several minutes, if at all.

3 If your media base is secured, remove the lock.

4 Remove the AC adapter connector from the media base

5 Pull the Tablet-PC release lever forward (see "Right View" on page 204) to release the Tablet-PC from the media base.



- 6 Lift the back of the Tablet-PC up and slide the Tablet-PC out towards the back of the media base.

Installing the Optical Drive in the Media Base

- 1 Save and close any open files or programs, and turn off the Tablet-PC (see "Turning Off Your Tablet-PC" on page 155).
- 2 Insert the optical drive into the media bay on the media base (see "Left View" on page 203).
- 3 Insert the securing screw that holds the optical drive in place.
- 4 Turn on the Tablet-PC.
The operating system recognizes the new drive.

Removing the Optical Drive From the Media Base

- 1 Save and close any open files or programs, and turn off the Tablet-PC (see "Turning Off Your Tablet-PC" on page 155).

- 2 Remove the securing screw that secures the optical drive and use your screwdriver to slide the drive out of the media bay.



Media Base Specifications

Physical

Height	12.8 mm (0.50 inches)
Width	295.31 mm (11.63 inches)
Depth	222.56 mm (8.76 inches)
Weight (without optical drive)	0.488 kg (1.076 lb)

Storage

DVD-ROM (optional)
DVD+RW (optional)

Ports and Connectors

Network connector	RJ-45 port for 10/100/1000 Mbits/second Ethernet
USB	three 4-pin USB-2.0 compliant connectors
Powered USB	one 9-pin USB-2.0 compliant connector
Video	15-pin VGA connector
DVI connector	24-hole connector
Serial	9-pin connector; 16550C-compatible UART with 16-byte buffer
Audio	headphone/speaker (line-out) mini connector
IEEE 1394a	4-pin serial connector
Docking	100-pin connector

Battery Slice (Optional)

Top View



- | | | | |
|---|----------------------|---|--------------------|
| 1 | docking connector | 2 | power status light |
| 3 | AC adapter connector | 4 | release lever |

Bottom View



- 1 battery-slice status LED

Setting Up Your Battery Slice

⚠ CAUTION: The AC adapter works with electrical outlets worldwide. However, power connectors and power strips vary among countries. Using an incompatible cable or improperly connecting the cable to the power strip or electrical outlet may cause fire or equipment damage.

➡ NOTICE: Always use the Dell AC adapter that came with your Tablet-PC. If you use any other commercially available AC adapter—or the AC adapter from earlier models of Dell computers—you may damage the battery slice or the Tablet-PC.

➡ NOTICE: When you disconnect the Dell AC adapter cable from the Tablet-PC, grasp the connector, not the cable itself, and pull firmly but gently to avoid damaging the cable. When you wrap the AC adapter cable, ensure that you follow the angle of the connector on the AC adapter to avoid damaging the cable.

Connect the AC adapter to the AC adapter connector on your Tablet-PC and to an electrical outlet.



Docking Your Tablet-PC to the Battery Slice



NOTE: After docking the Tablet-PC to the battery slice, the Tablet-PC AC adapter will also charge the battery slice.

- 1 Align the back of the Tablet-PC with the back of the battery slice at approximately a 30-degree angle, and lower the front of the Tablet-PC onto the battery slice.



1 Tablet-PC

2 battery slice

- 2 Press the Tablet-PC onto the battery slice until you feel a click and the Tablet-PC is firmly seated.
- 3 Turn on the Tablet-PC.
The operating system recognizes the battery slice.

Undocking Your Tablet-PC From the Battery Slice

- 1 Before you undock your Tablet-PC from the battery slice, save and close any open files, and exit any open programs.

- 2 Set your Tablet-PC power management settings so that the Tablet-PC does not enter sleep, standby, or hibernate mode when you close (lower) the display:

Windows Vista

- a Click Start  → Control Panel → Mobile PC → Power Options → Change what closing the lid does.
- b Under the **When I close the lid** drop-down menu, select **Do nothing**.

Windows XP

- a Click Start → Control Panel → Performance and Maintenance → Power Options → Advanced.
 - b Under the **When I close the lid of my portable computer**, select **Do nothing**.
- 3 Pull the Tablet-PC release lever (see "Bottom View" on page 218) to release the Tablet-PC from the battery slice.



- 4 Lift the back of the Tablet-PC up and slide the Tablet-PC out towards the back of the battery slice.

Charging Your Battery Slice

You can recharge your battery slice independent of the Tablet-PC using the AC adapter that shipped with your Tablet-PC. Your battery slice will also recharge whenever it is docked to the Tablet-PC and the Tablet-PC is attached to the electrical outlet using the AC adapter. See "Battery Slice Power Status LED Codes" on page 222 for more information on the battery-slice power-status codes.

Battery-Slice Power-Status LED

Your battery slice includes a power status LED that can indicate the following states:

Battery Slice Power Status LED Codes

LED Codes	Status
Blinking amber, off, blue, off, amber, off, blue, off	You are trying to use an unsupported, non-Dell AC adapter to power your tablet-PC.
Blinking amber, off, amber, off, amber, off, amber, off, long blue, long off	Temporary battery failure with AC adapter present.
Blinking amber, off, amber, off, amber, off, amber, off	Fatal battery failure with AC adapter present.
LED off	Battery in full charge mode with AC adapter present.
Steady blue light	Battery in charge mode with AC adapter present.

Battery Slice Specifications

Physical	
Height	8.5 mm (0.33 inches)
Width	295.32 mm (11.63 inches)
Depth	213.32 mm (8.4 inches)

Physical

Weight	0.60 kg (1.32 lb)
--------	-------------------

AC Adapter

Input voltage	100–240 VAC
---------------	-------------

Input current (maximum)	1.5 A
-------------------------	-------

Input frequency	50–60 Hz
-----------------	----------

Output current (maximum)	3.34 A
--------------------------	--------

Output power	65 W
--------------	------

Rated output voltage	19.5 VDC
----------------------	----------

Dimensions and weight:

Height	28.3 mm (1.11 inches)
--------	-----------------------

Width	57.8 mm (2.28 inches)
-------	-----------------------

Depth	137.2 mm (5.40 inches)
-------	------------------------

Weight (with cables)	0.36 kg (.79 lb)
----------------------	------------------

Ports and Connectors

Docking	100-pin connector
---------	-------------------

Traveling With Your Tablet-PC

- ➡ **NOTICE:** To avoid damaging your display, ensure that your Tablet-PC is in notebook mode and that the display is closed when you travel.

Identifying Your Tablet-PC

- Attach a name tag or business card to the Tablet-PC.
- Write down your Service Tag and store it in a safe place away from the Tablet-PC or carrying case. Use the Service Tag if you need to report a loss or theft to law enforcement officials and to Dell.
- Create a file on the Microsoft® Windows® desktop called **if_found**. Place information such as your name, address, and phone number in this file.
- Contact your credit card company and ask if it offers coded identification tags.

Packing the Tablet-PC

- Remove any external devices attached to the Tablet-PC and store them in a safe place.
- To make the Tablet-PC as light as possible, replace any devices installed in the media bay with the Dell TravelLite™ module.
- Fully charge the main battery and any spare batteries that you plan to carry with you.
- Shut down the Tablet-PC.
- Disconnect the AC adapter.
- ➡ **NOTICE:** When the display is closed, extraneous items on the keyboard or palm rest could damage the display.
- Remove any extraneous items, such as paper clips, pens, and paper, from the keyboard and palm rest and close the display.

- Use the optional Dell™ carrying case to pack the Tablet-PC and its accessories together safely.
- Avoid packing the Tablet-PC with items such as shaving cream, colognes, perfumes, or food.
- ➔ **NOTICE:** If the Tablet-PC has been exposed to extreme temperatures, allow it to acclimate to room temperature for 1 hour before turning it on.
- Protect the Tablet-PC, the batteries, and the hard drive from hazards such as extreme temperatures and overexposure to sunlight, dirt, dust, or liquids.
- Pack the Tablet-PC so that it does not slide around in the trunk of your car or in an overhead storage compartment.

Travel Tips

- ➔ **NOTICE:** Do not move the Tablet-PC while using the optical drive to prevent loss of data.
- ➔ **NOTICE:** Do not check the Tablet-PC as baggage.
 - Consider disabling wireless activity on your Tablet-PC to maximize battery operating time. To disable wireless activity, use the wireless switch (see "Enabling/Disabling the Dell Mobile Broadband Card" on page 108).
 - Consider changing your power management options to maximize battery operating time (see "Configuring Power Management Settings" on page 79).
 - If you are traveling internationally, carry proof of ownership—or of your right to use the Tablet-PC if it is company-owned—to speed your passage through customs. Investigate the customs regulations of the countries you plan to visit, and consider acquiring an international carnet (also known as a *merchandise passport*) from your government.
 - Find out what type of electrical outlets are used in the countries you will visit, and have appropriate power adapters.
 - Check with your credit card company for information about the kinds of emergency travel assistance it offers to users of portable computers.

Traveling by Air



NOTICE: Do not walk the Tablet-PC through a metal detector. Send the Tablet-PC through an X-ray machine or have it hand-inspected.

- Ensure that you have a charged battery available in case you are asked to turn on the Tablet-PC.
- Prior to entering the airplane, verify that using a Tablet-PC is permitted. Some airlines forbid the use of electronic devices during flight. All airlines forbid the use of electronic devices during takeoff and landing.

Appendix

FCC Notice (U.S. Only)

FCC Class B

This equipment generates, uses, and can radiate radio frequency energy and, if not installed and used in accordance with the manufacturer's instruction manual, may cause interference with radio and television reception. This equipment has been tested and found to comply with the limits for a Class B digital device pursuant to Part 15 of the FCC Rules.

This device complies with Part 15 of the FCC Rules. Operation is subject to the following two conditions:

- 1 This device may not cause harmful interference.
- 2 This device must accept any interference received, including interference that may cause undesired operation.



NOTICE: The FCC regulations provide that changes or modifications not expressly approved by Dell Inc. could void your authority to operate this equipment.

These limits are designed to provide reasonable protection against harmful interference in a residential installation. However, there is no guarantee that interference will not occur in a particular installation. If this equipment does cause harmful interference with radio or television reception, which can be determined by turning the equipment off and on, you are encouraged to try to correct the interference by one or more of the following measures:

- Reorient the receiving antenna.
- Relocate the system with respect to the receiver.
- Move the system away from the receiver.
- Plug the system into a different outlet so that the system and the receiver are on different branch circuits.

If necessary, consult a representative of Dell Inc. or an experienced radio/television technician for additional suggestions.

The following information is provided on the device or devices covered in this document in compliance with the FCC regulations:

- Product name: Dell™ Latitude™ XT
- Model number: PP12S
- Company name:
Dell Inc.
Worldwide Regulatory Compliance & Environmental Affairs
One Dell Way
Round Rock, TX 78682 USA
512-338-4400



NOTE: For further regulatory information, see your *Product Information Guide*.

Macrovision Product Notice

This product incorporates copyright protection technology that is protected by method claims of certain U.S. patents and other intellectual property rights owned by Macrovision Corporation and other rights owners. Use of this copyright protection technology must be authorized by Macrovision Corporation, and is intended for home and other limited viewing uses only unless otherwise authorized by Macrovision Corporation. Reverse engineering or disassembly is prohibited.

Glossary

Terms in this Glossary are provided for informational purposes only and may or may not describe features included with your particular Tablet-PC.

A

AC — alternating current — The form of electricity that powers your computer when you plug the AC adapter power cable in to an electrical outlet.

ACPI — advanced configuration and power interface — A power management specification that enables Microsoft® Windows® operating systems to put a computer in sleep or hibernate mode to conserve the amount of electrical power allocated to each device attached to the computer.

AGP — accelerated graphics port — A dedicated graphics port that allows system memory to be used for video-related tasks. AGP delivers a smooth, true-color video image because of the faster interface between the video circuitry and the computer memory.

AHCI — Advanced Host Controller Interface — An interface for a SATA hard drive Host Controller which allows the storage driver to enable technologies such as Native Command Queuing (NCQ) and hot plug.

ambient light sensor — A feature that helps to control display brightness.

antivirus software — A program designed to identify, quarantine, and/or delete viruses from your computer.

ASF — alert standards format — A standard to define a mechanism for reporting hardware and software alerts to a management console. ASF is designed to be platform- and operating system-independent.

B

battery life span — The length of time (years) during which a portable computer battery is able to be depleted and recharged.

battery operating time — The length of time (minutes or hours) that a portable

computer battery powers the computer.

biometric reader — A strip sensor that uses your unique fingerprint to authenticate your user identity to help secure your computer.

BIOS — basic input/output system — A program (or utility) that serves as an interface between the computer hardware and the operating system. Unless you understand what effect these settings have on the computer, do not change them. Also referred to as *system setup*.

bit — The smallest unit of data interpreted by your computer.

Blu-ray Disc™ (BD)— An optical storage technology offering storage capacity of up to 50 GB, full 1080p video resolution (HDTV required), and as many as 7.1 channels of native, uncompressed surround sound.

Bluetooth® wireless technology — A wireless technology standard for short-range (9 m [29 feet]) networking devices that allows for enabled devices to automatically recognize each other.

boot sequence — Specifies the order of the devices from which the computer attempts to boot.

bootable media — A CD or DVD that you can use to start your computer. In case your hard drive is damaged or your computer has a virus, ensure that you always have a bootable CD or DVD available. Your *Drivers and Utilities* media is an example of bootable media.

bps — bits per second — The standard unit for measuring data transmission speed.

BTU — British thermal unit — A measurement of heat output.

bus — A communication pathway between the components in your computer.

bus speed — The speed, given in MHz, that indicates how fast a bus can transfer information.

byte — The basic data unit used by your computer. A byte is usually equal to 8 bits.

C

C — Celsius — A temperature measurement scale where 0° is the freezing point and 100° is the boiling point of water.

cache — A special high-speed storage mechanism which can be either a reserved section of main memory or an independent high-speed storage device. The cache enhances the efficiency of many processor operations. See also *L1 cache* and *L2 cache*.

CCFL — Cold Cathode Fluorescent Lamp— A type of bulb used to illuminate liquid crystal displays, such as those used in notebook computers. CCFLs are able to provide very bright white light without generating high temperatures detrimental to many

computer components.

carnet — An international customs document that facilitates temporary imports into foreign countries. Also known as a *merchandise passport*.

CD-R — CD recordable — A recordable version of a CD. Data can be recorded only once onto a CD-R. Once recorded, the data cannot be erased or written over.

CD-RW — CD rewritable — A rewritable version of a CD. Data can be written to a CD-RW disc, and then erased and written over (rewritten).

CD-RW drive — A drive that can read CDs and write to CD-RW (rewritable CDs) and CD-R (recordable CDs) discs. You can write to CD-RW discs multiple times, but you can write to CD-R discs only once.

CD-RW/DVD drive — A drive, sometimes referred to as a combo drive, that can read CDs and DVDs and write to CD-RW (rewritable CDs) and CD-R (recordable CDs) discs. You can write to CD-RW discs multiple times, but you can write to CD-R discs only once.

clock speed — The speed, given in MHz, that indicates how fast computer components that are connected to the system bus operate.

CMOS — A type of electronic circuit. Computers use a small amount of battery-powered CMOS memory to hold date, time, and system setup options.

COA — Certificate of Authenticity — The Windows alpha-numeric code located on a sticker on your computer. Also referred to as the *Product Key* or *Product ID*.

Control Panel — A Windows utility that allows you to modify operating system and hardware settings, such as display settings.

controller — A chip that controls the transfer of data between the processor and memory or between the processor and devices.

CRIMM — continuity rambus in-line memory module — A special module that has no memory chips and is used to fill unused RIMM slots.

cursor — The marker on a display or screen that shows where the next keyboard, touch pad, or mouse action will occur. It often is a blinking solid line, an underline character, or a small arrow.

D

DDR SDRAM — double-data-rate SDRAM — A type of SDRAM that doubles the data burst cycle, improving system performance.

DDR2 SDRAM — double-data-rate 2 SDRAM — A type of DDR SDRAM that uses a 4-bit prefetch and other architectural changes to boost memory speed to over 400 MHz.

device — Hardware such as a disk drive, printer, or keyboard that is installed in or connected to your computer.

device driver — See *driver*.

DIMM — dual in-line memory module — A circuit board with memory chips that connects to a memory module on the system board.

DIN connector — A round, six-pin connector that conforms to DIN (Deutsche Industrie-Norm) standards; it is typically used to connect PS/2 keyboard or mouse cable connectors.

disk striping — A technique for spreading data over multiple disk drives. Disk striping can speed up operations that retrieve data from disk storage. Computers that use disk striping generally allow the user to select the data unit size or stripe width.

DMA — direct memory access — A channel that allows certain types of data transfer between RAM and a device to bypass the processor.

docking device — provides port replication, cable management, and security features to adapt your notebook to a desktop workspace.

DMTF — Distributed Management Task Force — A consortium of hardware and software companies who develop management standards for distributed desktop, network, enterprise, and Internet environments.

domain — A group of computers, programs, and devices on a network that are administered as a unit with common rules and procedures for use by a specific group of users. A user logs on to the domain to gain access to the resources.

DRAM — dynamic random-access memory — Memory that stores information in integrated circuits containing capacitors.

driver — Software that allows the operating system to control a device such as a printer. Many devices do not work properly if the correct driver is not installed in the computer.

DSL — Digital Subscriber Line — A technology that provides a constant, high-speed Internet connection through an analog telephone line.

dual-core — A technology in which two physical computational units exist inside a single processor package, thereby increasing computing efficiency and multi-tasking ability.

dual display mode — A display setting that allows you to use a second monitor as an extension of your display. Also referred to as *extended display mode*.

DVD-R — DVD recordable — A recordable version of a DVD. Data can be recorded only once onto a DVD-R. Once recorded, the data cannot be erased or written over.

DVD+RW — DVD rewritable — A rewritable version of a DVD. Data can be written to a DVD+RW disc, and then erased and written over (rewritten). (DVD+RW

technology is different from DVD-RW technology.)

DVD+RW drive — drive that can read DVDs and most CD media and write to DVD+RW (rewritable DVDs) discs.

DVI — digital video interface — A standard for digital transmission between a computer and a digital video display.

E

ECC — error checking and correction — A type of memory that includes special circuitry for testing the accuracy of data as it passes in and out of memory.

ECP — extended capabilities port — A parallel connector design that provides improved bidirectional data transmission. Similar to EPP, ECP uses direct memory access to transfer data and often improves performance.

EIDE — enhanced integrated device electronics — An improved version of the IDE interface for hard drives and CD drives.

EMI — electromagnetic interference — Electrical interference caused by electromagnetic radiation.

ENERGY STAR® — Environmental Protection Agency requirements that decrease the overall consumption of electricity.

EPP — enhanced parallel port — A parallel connector design that provides bidirectional data transmission.

ESD — electrostatic discharge — A rapid discharge of static electricity. ESD can damage integrated circuits found in computer and communications equipment.

expansion card — A circuit board that installs in an expansion slot on the system board in some computers, expanding the capabilities of the computer. Examples include video, modem, and sound cards.

expansion slot — A connector on the system board (in some computers) where you insert an expansion card, connecting it to the system bus.

ExpressCard — A removable I/O card adhering to the PCMCIA standard. Modems and network adapters are common types of ExpressCards. ExpressCards support both the PCI Express and USB 2.0 standard.

Express Service Code — A numeric code located on a sticker on your Dell™ computer. Use the Express Service Code when contacting Dell for assistance. Express Service Code service may not be available in some countries.

extended display mode — A display setting that allows you to use a second monitor as an extension of your display. Also referred to as *dual display mode*.

extended PC Card — A PC Card that extends beyond the edge of the PC Card slot

when installed.

F

Fahrenheit — A temperature measurement scale where 32° is the freezing point and 212° is the boiling point of water.

FBD — fully-buffered DIMM — A DIMM with DDR2 DRAM chips and an Advanced Memory Buffer (AMB) that speeds communication between the DDR2 SDRAM chips and the system.

FCC — Federal Communications Commission — A U.S. agency responsible for enforcing communications-related regulations that state how much radiation computers and other electronic equipment can emit.

folder — A term used to describe space on a disk or drive where files are organized and grouped. Files in a folder can be viewed and ordered in various ways, such as alphabetically, by date, and by size.

format — The process that prepares a drive or disk for file storage. When a drive or disk is formatted, the existing information on it is lost.

FSB — front side bus — The data path and physical interface between the processor and RAM.

FTP — file transfer protocol — A standard Internet protocol used to exchange files between computers connected to the Internet.

G

G — gravity — A measurement of weight and force.

GB — gigabyte — A measurement of data storage that equals 1024 MB (1,073,741,824 bytes). When used to refer to hard drive storage, the term is often rounded to 1,000,000,000 bytes.

GHz — gigahertz — A measurement of frequency that equals one thousand million Hz, or one thousand MHz. The speeds for computer processors, buses, and interfaces are often measured in GHz.

graphics mode — A video mode that can be defined as *x* horizontal pixels by *y* vertical pixels by *z* colors. Graphics modes can display an unlimited variety of shapes and fonts.

GUI — graphical user interface — Software that interacts with the user by means of menus, windows, and icons. Most programs that operate on the Windows operating systems are GUIs.

H

hard drive — A drive that reads and writes data on a hard disk. The terms hard drive and hard disk are often used interchangeably.

heat sink — A metal plate on some processors that helps dissipate heat.

hibernate mode — A power management mode that saves everything in memory to a reserved space on the hard drive and then turns off the computer. When you restart the computer, the memory information that was saved to the hard drive is automatically restored.

HTTP — hypertext transfer protocol — A protocol for exchanging files between computers connected to the Internet.

Hyper-Threading — Hyper-Threading is an Intel technology that can enhance overall computer performance by allowing one physical processor to function as two logical processors, capable of performing certain tasks simultaneously.

Hz — hertz — A unit of frequency measurement that equals 1 cycle per second. Computers and electronic devices are often measured in kilohertz (kHz), megahertz (MHz), gigahertz (GHz), or terahertz (THz).

I

IC — integrated circuit — A semiconductor wafer, or chip, on which thousands or millions of tiny electronic components are fabricated for use in computer, audio, and video equipment.

IDE — integrated device electronics — An interface for mass storage devices in which the controller is integrated into the hard drive or CD drive.

IEEE 1394 — Institute of Electrical and Electronics Engineers, Inc. — A high-performance serial bus used to connect IEEE 1394-compatible devices, such as digital cameras and DVD players, to the computer.

infrared sensor — A port that allows you to transfer data between the computer and infrared-compatible devices without using a cable connection.

integrated — Usually refers to components that are physically located on the computer's system board. Also referred to as *built-in*.

I/O — input/output — An operation or device that enters and extracts data from your computer. Keyboards and printers are I/O devices.

I/O address — An address in RAM that is associated with a specific device (such as a serial connector, parallel connector, or expansion slot) and allows the processor to communicate with that device.

IrDA — Infrared Data Association — The organization that creates international

standards for infrared communications.

IRQ — interrupt request — An electronic pathway assigned to a specific device so that the device can communicate with the processor. Each device connection must be assigned an **IRQ**. Although two devices can share the same **IRQ** assignment, you cannot operate both devices simultaneously.

ISP — Internet service provider — A company that allows you to access its host server to connect directly to the Internet, send and receive e-mail, and access websites. The ISP typically provides you with a software package, user name, and access phone numbers for a fee.

K

Kb — kilobit — A unit of data that equals 1024 bits. A measurement of the capacity of memory integrated circuits.

KB — kilobyte — A unit of data that equals 1024 bytes but is often referred to as 1000 bytes.

key combination — A command requiring you to press multiple keys at the same time.

kHz — kilohertz — A measurement of frequency that equals 1000 Hz.

L

L1 cache — Primary cache stored inside the processor.

L2 cache — Secondary cache which can either be external to the processor or incorporated into the processor architecture.

LAN — local area network — A computer network covering a small area. A LAN usually is confined to a building or a few nearby buildings. A LAN can be connected to another LAN over any distance through telephone lines and radio waves to form a wide area network (WAN).

LCD — liquid crystal display — The technology used by portable computer and flat-panel displays.

LED — light-emitting diode — An electronic component that emits light to indicate the status of the computer.

local bus — A data bus that provides a fast throughput for devices to the processor.

LPT — line print terminal — The designation for a parallel connection to a printer or other parallel device.

M

Mb — megabit — A measurement of memory chip capacity that equals 1024 Kb.

Mbps — megabits per second — One million bits per second. This measurement is typically used for transmission speeds for networks and modems.

MB — megabyte — A measurement of data storage that equals 1,048,576 bytes. 1 MB equals 1024 KB. When used to refer to hard drive storage, the term is often rounded to 1,000,000 bytes.

MB/sec — megabytes per second — One million bytes per second. This measurement is typically used for data transfer ratings.

media bay — A bay that supports devices such as optical drives, a second battery, or a Dell TravelLite™ module.

memory — A temporary data storage area inside your computer. Because the data in memory is not permanent, it is recommended that you frequently save your files while you are working on them, and always save your files before you shut down the computer. Your computer can contain several different forms of memory, such as RAM, ROM, and video memory. Frequently, the word memory is used as a synonym for RAM.

memory address — A specific location where data is temporarily stored in RAM.

memory mapping — The process by which the computer assigns memory addresses to physical locations at start-up. Devices and software can then identify information that the processor can access.

memory module — A small circuit board containing memory chips, which connects to the system board.

MHz — megahertz — A measure of frequency that equals 1 million cycles per second. The speeds for computer processors, buses, and interfaces are often measured in MHz.

Mini PCI — A standard for integrated peripheral devices with an emphasis on communications such as modems and NICs. A Mini PCI card is a small external card that is functionally equivalent to a standard PCI expansion card.

Mini-Card — A small card designed for integrated peripherals, such as communication NICs. The Mini-Card is functionally equivalent to a standard PCI expansion card.

modem — A device that allows your computer to communicate with other computers over analog telephone lines. Three types of modems include: external, PC Card, and internal. You typically use your modem to connect to the Internet and exchange e-mail.

module bay — See *media bay*.

MP — megapixel — A measure of image resolution used for digital cameras.

ms — millisecond — A measure of time that equals one thousandth of a second. Access times of storage devices are often measured in ms.

N

network adapter — A chip that provides network capabilities. A computer may include a network adapter on its system board, or it may contain a PC Card with an adapter on it. A network adapter is also referred to as a *NIC* (network interface controller).

NIC — See *network adapter*.

notification area — The section of the Windows Notification area that contains icons for providing quick access to programs and computer functions, such as the clock, volume control, and print status. Also referred to as *system tray*.

ns — nanosecond — A measure of time that equals one billionth of a second.

NVRAM — nonvolatile random access memory — A type of memory that stores data when the computer is turned off or loses its external power source. NVRAM is used for maintaining computer configuration information such as date, time, and other system setup options that you can set.

O

optical drive — A drive that uses optical technology to read or write data from CDs, DVDs, or DVD+RWs. Example of optical drives include CD drives, DVD drives, CD-RW drives, and CD-RW/DVD combo drives.

P

parallel connector — An I/O port often used to connect a parallel printer to your computer. Also referred to as an *LPT port*.

partition — A physical storage area on a hard drive that is assigned to one or more logical storage areas known as logical drives. Each partition can contain multiple logical drives.

PC Card — A removable I/O card adhering to the PCMCIA standard. Modems and network adapters are common types of PC Cards.

PCI — peripheral component interconnect — PCI is a local bus that supports 32- and 64-bit data paths, providing a high-speed data path between the processor and devices such as video, drives, and networks.

PCI Express — A modification to the PCI interface that boosts the data transfer rate between the processor and the devices attached to it. PCI Express can transfer data at speeds from 250 MB/sec to 4 GB/sec. If the PCI Express chip set and the device are capable of different speeds, they will operate at the slower speed.

PCMCIA — Personal Computer Memory Card International Association — The organization that establishes standards for PC Cards.

pen — Input device used to enter data into a Tablet-PC or other slate device.

PIO — programmed input/output — A method of transferring data between two devices through the processor as part of the data path.

pixel — A single point on a display screen. Pixels are arranged in rows and columns to create an image. A video resolution, such as 800 x 600, is expressed as the number of pixels across by the number of pixels up and down.

Plug-and-Play — The ability of the computer to automatically configure devices. Plug and Play provides automatic installation, configuration, and compatibility with existing hardware if the BIOS, operating system, and all devices are Plug and Play compliant.

POST — power-on self-test — Diagnostics programs, loaded automatically by the BIOS, that perform basic tests on the major computer components, such as memory, hard drives, and video. If no problems are detected during POST, the computer continues the start-up.

processor — A computer chip that interprets and executes program instructions. Sometimes the processor is referred to as the CPU (central processing unit).

PS/2 — personal system/2 — A type of connector for attaching a PS/2-compatible keyboard, mouse, or keypad.

PXE — pre-boot execution environment — A WfM (Wired for Management) standard that allows networked computers that do not have an operating system to be configured and started remotely.

R

RAID — redundant array of independent disks — A method of providing data redundancy. Some common implementations of RAID include RAID 0, RAID 1, RAID 5, RAID 10, and RAID 50.

RAM — random-access memory — The primary temporary storage area for program instructions and data. Any information stored in RAM is lost when you shut down your computer.

readme file — A text file included with a software package or hardware product. Typically, readme files provide installation information and describe new product

enhancements or corrections that have not yet been documented.

read-only — Data and/or files you can view but cannot edit or delete. A file can have read-only status if:

- It resides on a physically write-protected CD or DVD.
- It is located on a network in a directory and the system administrator has assigned rights only to specific individuals.

refresh rate — The frequency, measured in Hz, at which your screen's horizontal lines are recharged (sometimes also referred to as its *vertical frequency*). The higher the refresh rate, the less video flicker can be seen by the human eye.

resolution — The sharpness and clarity of an image produced by a printer or displayed on a monitor. The higher the resolution, the sharper the image.

RFI — radio frequency interference — Interference that is generated at typical radio frequencies, in the range of 10 kHz to 100,000 MHz. Radio frequencies are at the lower end of the electromagnetic frequency spectrum and are more likely to have interference than the higher frequency radiations, such as infrared and light.

ROM — read-only memory — Memory that stores data and programs that cannot be deleted or written to by the computer. ROM, unlike RAM, retains its contents after you shut down your computer. Some programs essential to the operation of your computer reside in ROM.

RPM — revolutions per minute — The number of rotations that occur per minute. Hard drive speed is often measured in rpm.

RTC — real time clock — Battery-powered clock on the system board that keeps the date and time after you shut down the computer.

RTCST — real-time clock reset — A jumper on the system board of some computers that can often be used for troubleshooting problems.

S

SAS — serial attached SCSI — A faster, serial version of the SCSI interface (as opposed to the original SCSI parallel architecture).

SATA — serial ATA — A faster, serial version of the ATA (IDE) interface.

ScanDisk — A Microsoft utility that checks files, folders, and the hard disk's surface for errors. ScanDisk often runs when you restart the computer after it has stopped responding.

SCSI — small computer system interface — A high-speed interface used to connect devices to a computer, such as hard drives, CD drives, printers, and scanners. The SCSI can connect many devices using a single controller. Each device is accessed by an

individual identification number on the SCSI controller bus.

SDRAM — synchronous dynamic random-access memory — A type of DRAM that is synchronized with the optimal clock speed of the processor.

serial connector — An I/O port often used to connect devices such as a handheld digital device or digital camera to your computer.

Service Tag — A bar code label on your computer that identifies your computer when you access Dell Support at support.dell.com or when you call Dell for customer service or technical support.

setup program — A program that is used to install and configure hardware and software. The **setup.exe** or **install.exe** program comes with most Windows software packages. *Setup program* differs from *system setup program*.

shortcut — An icon that provides quick access to frequently used programs, files, folders, and drives. When you place a shortcut on your Windows desktop and double-click the icon, you can open its corresponding folder or file without having to find it first. Shortcut icons do not change the location of files. If you delete a shortcut, the original file is not affected. Also, you can rename a shortcut icon.

SIM — Subscriber Identity Module — A SIM card contains a microchip that encrypts voice and data transmissions. SIM cards can be used in phones or portable computers.

smart card — A card that is embedded with a processor and a memory chip. Smart cards can be used to authenticate a user on computers equipped for smart cards.

S/PDIF — Sony/Philips Digital Interface — An audio transfer file format that allows the transfer of audio from one file to another without converting it to and from an analog format, which could degrade the quality of the file.

sleep mode — A power management mode that shuts down all unnecessary computer operations to save energy.

Strike Zone™ — Reinforced area of the platform base that protects the hard drive by acting as a dampening device when a computer experiences resonating shock or is dropped (whether the computer is on or off).

surge protectors — Prevent voltage spikes, such as those that may occur during an electrical storm, from entering the computer through the electrical outlet. Surge protectors do not protect against lightning strikes or against brownouts, which occur when the voltage drops more than 20 percent below the normal AC-line voltage level.

Network connections cannot be protected by surge protectors. Always disconnect the network cable from the network connector during electrical storms.

SVGA — super-video graphics array — A video standard for video cards and controllers. Typical SVGA resolutions are 800 x 600 and 1024 x 768.

The number of colors and resolution that a program displays depends on the

capabilities of the monitor, the video controller and its drivers, and the amount of video memory installed in the computer.

S-video TV-out — A connector used to attach a TV or digital audio device to the computer.

SXGA — super-extended graphics array — A video standard for video cards and controllers that supports resolutions up to 1280 x 1024.

SXGA+ — super-extended graphics array plus — A video standard for video cards and controllers that supports resolutions up to 1400 x 1050.

system board — The main circuit board in your computer. Also known as the *motherboard*.

system setup program— A utility that serves as an interface between the computer hardware and the operating system. System setup allows you to configure user-selectable options in the BIOS, such as date and time or system password. Unless you understand what effect the settings have on the computer, do not change the settings for this program.

T

TAPI — telephony application programming interface — Enables Windows programs to operate with a wide variety of telephony devices, including voice, data, fax, and video.

text editor — A program used to create and edit files that contain only text; for example, Windows Notepad uses a text editor. Text editors do not usually provide word wrap or formatting functionality (the option to underline, change fonts, and so on).

TPM — trusted platform module — A hardware-based security feature that when combined with security software enhances network and computer security by enabling features such as file and e-mail protection.

travel module — A plastic device designed to fit inside the media bay of a portable computer to reduce the weight of the computer.

U

UAC — user account control— Microsoft Windows Vista[®] security feature that, when enabled, provides an added layer of security between user accounts and access to operating system settings.

UMA — unified memory allocation — System memory dynamically allocated to video.

UPS — uninterruptible power supply — A backup power source used when the electrical power fails or drops to an unacceptable voltage level. A UPS keeps a computer running for a limited amount of time when there is no electrical power. UPS systems typically provide surge suppression and may also provide voltage regulation. Small UPS systems provide battery power for a few minutes to enable you to shut down your computer.

USB — universal serial bus — A hardware interface for a low-speed device such as a USB-compatible keyboard, mouse, joystick, scanner, set of speakers, printer, broadband devices (DSL and cable modems), imaging devices, or storage devices. Devices are plugged directly in to a 4-pin socket on your computer or in to a multi-port hub that plugs in to your computer. USB devices can be connected and disconnected while the computer is turned on, and they can also be daisy-chained together.

UTP — unshielded twisted pair — Describes a type of cable used in most telephone networks and some computer networks. Pairs of unshielded wires are twisted to protect against electromagnetic interference, rather than relying on a metal sheath around each pair of wires to protect against interference.

UXGA — ultra extended graphics array — A video standard for video cards and controllers that supports resolutions up to 1600 x 1200.

V

video controller — The circuitry on a video card or on the system board (in computers with an integrated video controller) that provides the video capabilities—in combination with the monitor—for your computer.

video memory — Memory that consists of memory chips dedicated to video functions. Video memory is usually faster than system memory. The amount of video memory installed primarily influences the number of colors that a program can display.

video mode — A mode that describes how text and graphics are displayed on a monitor. Graphics-based software, such as Windows operating systems, displays in video modes that can be defined as x horizontal pixels by y vertical pixels by z colors. Character-based software, such as text editors, displays in video modes that can be defined as x columns by y rows of characters.

video resolution — See *resolution*.

virus — A program that is designed to inconvenience you or to destroy data stored on your computer. A virus program moves from one computer to another through an infected disk, software downloaded from the Internet, or e-mail attachments. When an infected program starts, its embedded virus also starts.

A common type of virus is a boot virus, which is stored in the boot sectors of bootable media. If the bootable media is left in the drive when the computer is shut down and

then turned on, the computer is infected when it reads the boot sectors of the bootable media expecting to find the operating system. If the computer is infected, the boot virus may replicate itself onto all the bootable media that are read or written in that computer until the virus is eradicated.

V — volt — The measurement of electric potential or electromotive force. One V appears across a resistance of 1 ohm when a current of 1 ampere flows through that resistance.

W

W — watt — The measurement of electrical power. One W is 1 ampere of current flowing at 1 volt.

WHr — watt-hour — A unit of measure commonly used to indicate the approximate capacity of a battery. For example, a 66-WHr battery can supply 66 W of power for 1 hour or 33 W for 2 hours.

wallpaper — The background pattern or picture on the Windows desktop. Change your wallpaper through the Windows Control Panel. You can also scan in your favorite picture and make it wallpaper.

WLAN — wireless local area network. A series of interconnected computers that communicate with each other over the air waves using access points or wireless routers to provide Internet access.

write-protected — Files or media that cannot be changed. Use write-protection when you want to protect data from being changed or destroyed.

WWAN — wireless wide area network. A wireless high-speed data network using cellular technology and covering a much larger geographic area than WLAN.

WXGA — wide-aspect extended graphics array — A video standard for video cards and controllers that supports resolutions up to 1280 x 800.

X

XGA — extended graphics array — A video standard for video cards and controllers that supports resolutions up to 1024 x 768.

Z

ZIF — zero insertion force — A type of socket or connector that allows a computer chip to be installed or removed with no stress applied to either the chip or its socket.

Zip — A popular data compression format. Files that have been compressed with the

Zip format are called Zip files and usually have a filename extension of `.zip`. A special kind of zipped file is a self-extracting file, which has a filename extension of `.exe`. You can unzip a self-extracting file by double-clicking it.

Zip drive — A high-capacity floppy drive developed by Iomega Corporation that uses 3.5-inch removable disks called Zip disks. Zip disks are slightly larger than regular floppy disks, about twice as thick, and hold up to 100 MB of data.

