

Dell™ PowerVault™ MD1120 Storage Enclosure

Getting Started With Your System

Mise en route de votre système

Introdução ao uso do seu sistema

Procedimientos iniciales con el sistema

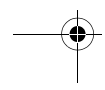
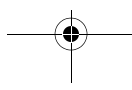
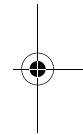
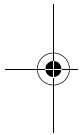



book.book Page 2 Monday, August 18, 2008 7:01 PM

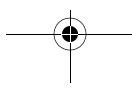
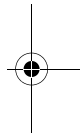
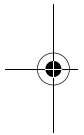

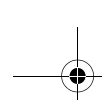

Dell™ PowerVault™ MD1120 Storage Enclosure

Getting Started With Your System

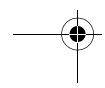
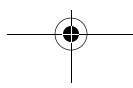
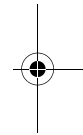
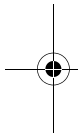

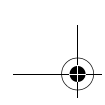

Notes, Notices, and Cautions



NOTE: A NOTE indicates important information that helps you make better use of your computer.



NOTICE: A NOTICE indicates either potential damage to hardware or loss of data and tells you how to avoid the problem.



CAUTION: A CAUTION indicates a potential for property damage, personal injury, or death.

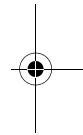
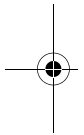

Information in this document is subject to change without notice.

© 2008 Dell Inc. All rights reserved.

Reproduction of these materials in any manner whatsoever without the written permission of Dell Inc. is strictly forbidden.

Trademarks used in this text: *Dell*, the *DELL* logo, *PowerEdge*, *PowerVault* and *Dell OpenManage* are trademarks of Dell Inc.; *Intel*, *Pentium* and *Celeron* are registered trademarks of Intel Corporation; *Microsoft*, *Windows* and *Windows Server* are either trademarks or registered trademarks of Microsoft Corporation in the United States and/or other countries.

Other trademarks and trade names may be used in this document to refer to either the entities claiming the marks and names or their products. Dell Inc. disclaims any proprietary interest in trademarks and trade names other than its own.

Model AMT

August 2008

P/N RU600

Rev. A01

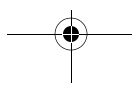

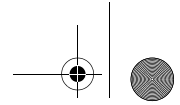

System Features

This section describes the major hardware and software features of your system. It also provides information about other documents you may need when setting up your system and how to obtain technical assistance.

Major features of your system include:

- Enclosure storage in an efficient rack-mount 2U design
- Capacity for 24 2.5-inch, hot-plug, 3.0-Gbps, SAS hard drives
- Host-based RAID support via a PERC 6/E adapter
- Redundant hot-plug power supply and cooling modules that are combined for easy serviceability
- Optional second enclosure management module (EMM) for redundant system management capability
- Support for either of the following direct-attach configurations:
 - Unified mode for direct connectivity of up to 24 hard drives
 - Split mode (with dual EMMs) providing direct connectivity to drives 0 through 11 on one EMM and a separate direct connectivity to drives 12 through 23 on the second EMM
- Support for up to three daisy-chained storage enclosures in unified mode for a total of 72 hard drives
- In-band enclosure management provided through SCSI enclosure services (SES)
- RAID and system management using Dell OpenManage™ Server Administrator Storage Management Service or OpenManage IT Assistant.
- Four sensors for monitoring ambient temperatures
- Over-temperature shutdown capability
- Audible warning for critical component failure (disabled by default)
- Support for a wide range of servers (See your system's readme file for supported systems. An updated readme can be viewed from the Dell website at support.dell.com)

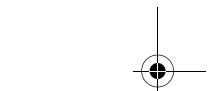
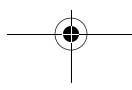
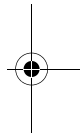
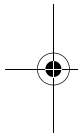

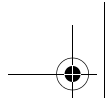

Other Information You May Need

 **CAUTION:** See the safety and regulatory information that shipped with your system. Warranty information may be included within this document or as a separate document.

- The *Rack Installation Instructions* or *Rack Installation Guide* included with your rack solution describes how to install your system into a rack.
- The *Hardware Owner's Manual* provides information about system features and describes how to troubleshoot the system and install or replace system components.
- CDs included with your system provide documentation and tools for configuring and managing your system.
- Release notes or readme files may be included to provide last-minute updates to the system or documentation or advanced technical reference material intended for experienced users or technicians.

Obtaining Technical Assistance

If you do not understand a procedure in this guide or if the system does not perform as expected, see your *Hardware Owner's Manual*.

Dell Enterprise Training and Certification is available; see dell.com/training for more information. This service may not be offered in all locations.

Installation and Configuration

 **CAUTION:** Before performing the following procedure, read and follow the safety instructions and important regulatory information that shipped with your system. For additional safety best practices information, see www.dell.com/regulatory_compliance.

This section describes the steps to set up your system for the first time.

Unpacking the System

Unpack your system and identify each item.

Keep all shipping materials in case you need them later.

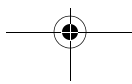

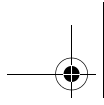

Installing the Rails and System in a Rack

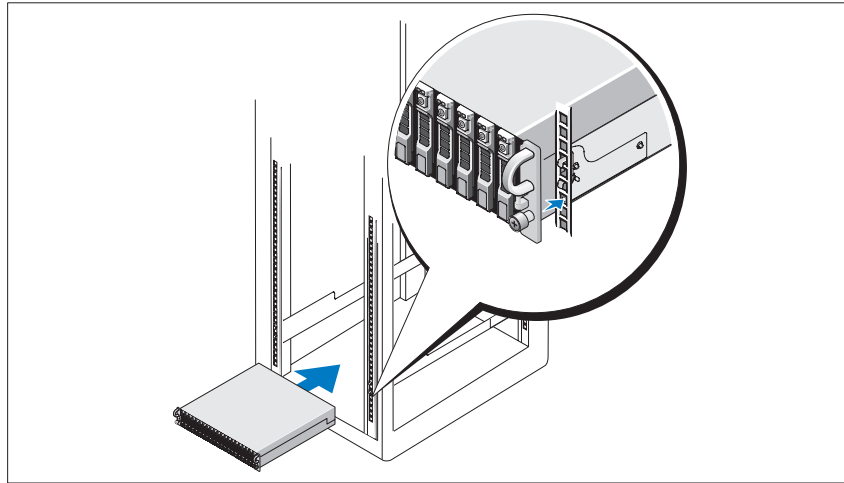

Once you have read the "Safety Instructions" located in the rack installation documentation for your system, install the rails and the system in the rack.

See your rack installation documentation for instructions on installing your system in a rack.

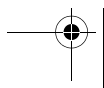
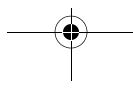
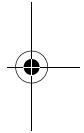
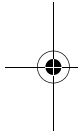

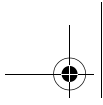

Connecting the Power

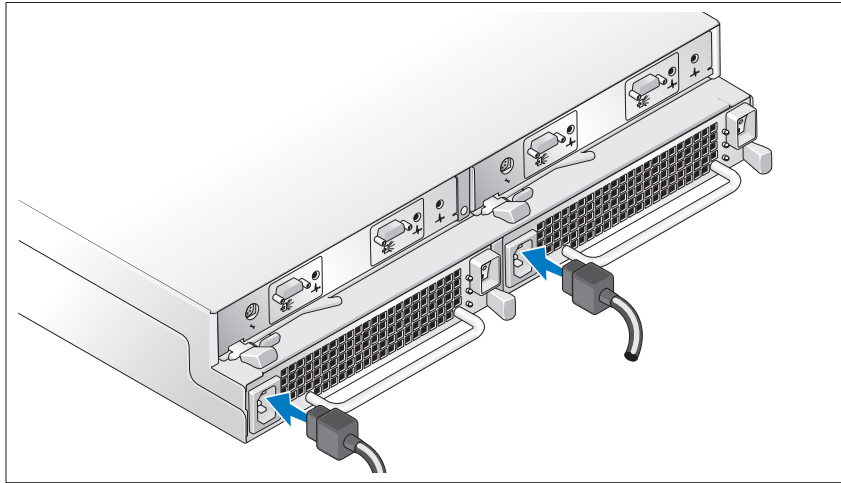

Connect both power cables to the power supply/cooling fan modules.

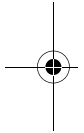

Attaching the Power Cord Retention Bracket

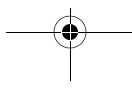
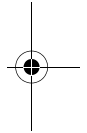
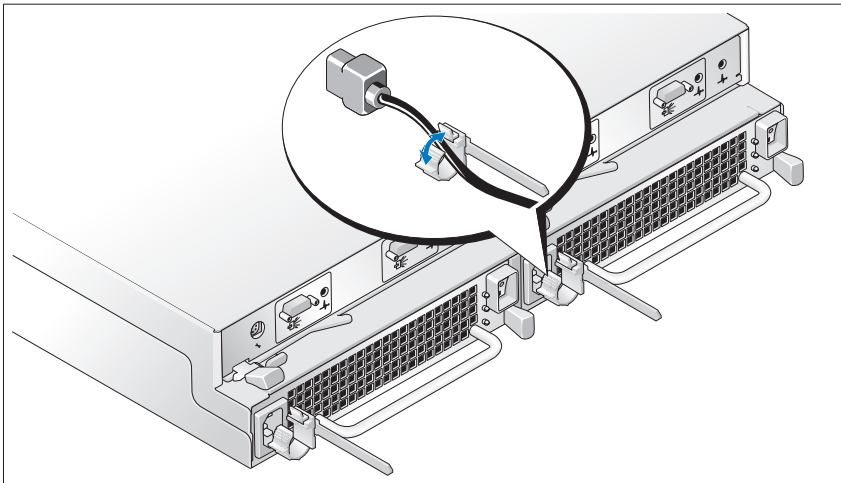



Configure the storage mode for your system by setting the configuration switch on the front of the system and cabling the EMM(s) according to the instructions provided in the *Hardware Owner's Manual*.

Turning on the System

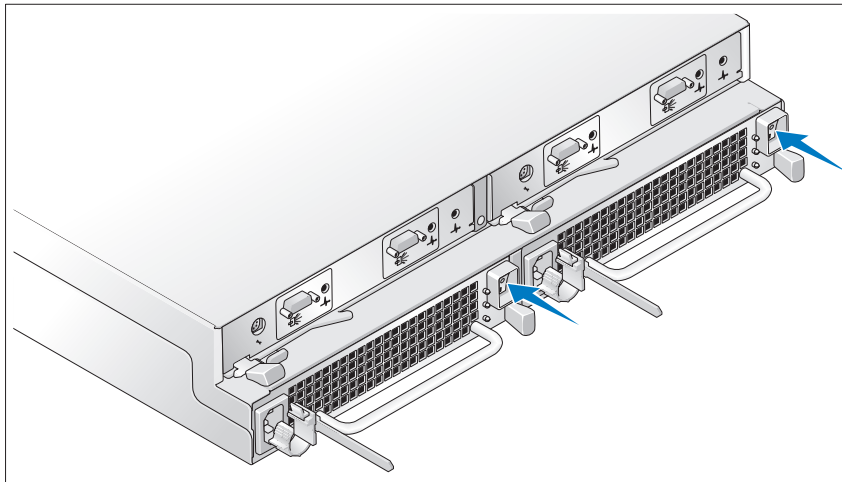

Power on the system by turning on both power supply/cooling fan modules.

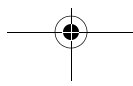
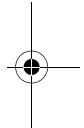
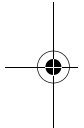

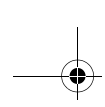

Installing the Bezel

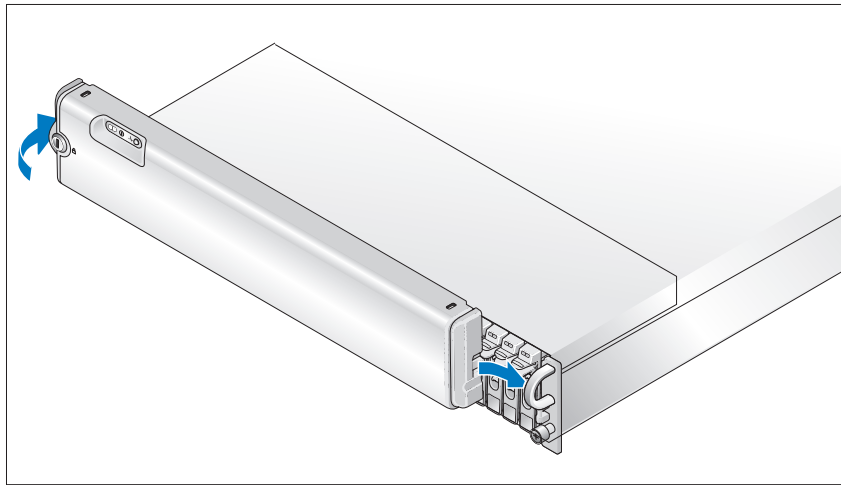

Install the bezel, if desired, by inserting the right edge of the bezel into the right front loop on the system, and then pressing the left edge of the bezel to the system until the bezel snaps into place. (Bezel design may vary slightly from the illustration above.)

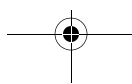

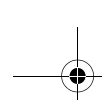

Technical Specifications

Drives

SAS hard drives

Up to 24 2.5-inch SAS hot-plug hard drives (3.0 Gbps), at speeds of 10K or 15K rpm (See your system readme file for supported disk capacities.)

Connectivity

Configurations

Support for either of the following configurations:

- Unified mode for direct connectivity to 24 hard drives
- Split mode with dual EMMs providing a direct connectivity to drives 0 through 11 and a separate direct connectivity to drives 12 through 23
- Up to three daisy-chained storage enclosures in unified mode for a total of 72 hard drives

Enclosure Modules

EMMs

One or two hot-pluggable modules
Each EMM has one temperature sensor

Backplane Board

Connectors

- 24 SAS hard drive connectors
- Two power supply/cooling fan module connectors
- Two sets of EMM connectors (6 connectors each EMM)
- One control panel connector for front LEDs and enclosure mode switch

Sensors

Two temperature sensors

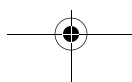
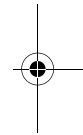
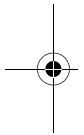

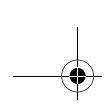

Back-Panel Connectors

SAS connectors (per EMM)	<ul style="list-style-type: none"> • One SAS (SFF 8470) "IN" connector for connection to the host • One SAS (SFF 8470) "OUT" connector for expansion to an additional enclosure
Serial connector (per EMM)	One 6-pin UART mini-DIN connector (for factory use only)

LED Indicators

Front panel	<ul style="list-style-type: none"> • One two-color LED indicator for system status • Two single-color LED indicators for power and split mode
Hard-drive carrier	<ul style="list-style-type: none"> • One single-color activity LED • One two-color LED status indicator per drive
EMM	Three two-color LED status indicators, one each for the two EMM SAS ports and one for the EMM status
Power supply/cooling fan module	Three LED status indicators for power supply status, power supply/fan fault, and AC status

Power Supplies

Wattage	485 W maximum continuous; 604 W peak
Heat dissipation	200 W
Voltage	100–240 V
Frequency	50/60 Hz
Amperage	7.5–3.75 A

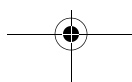



Available Hard Drive Power (Per Slot)

Supported hard drive power consumption (continuous)	Up to 0.5 A at +12 V Up to 1.2 A at +5 V
---	---

Physical

Height	8.60 cm (3.375 inches)
Width	44.50 cm (17.5 inches)
Depth	46.40 cm (18.25 inches)
Weight (maximum configuration kg)	23.60 kg (52 lb)

Environmental

NOTE: For additional information about environmental measurements for specific system configurations, see dell.com/environmental_datasheets. This system is not for use in an office environment.

Temperature	
Operating	10° to 35°C (50° to 95°F)
Storage	-40° to 65°C (-40° to 149°F)
Relative humidity	
Operating	20% to 80% (noncondensing)
Storage	5% to 95% (noncondensing)
Altitude	
Operating	-16 to 3,048 m (-50 to 10,000 ft)
Storage	-16 to 10,600 m (-50 to 35,000 ft)
BTU per hour	1430

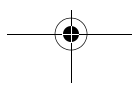
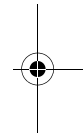
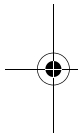

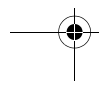
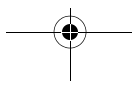
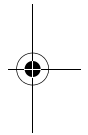
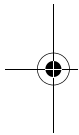
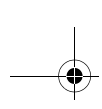

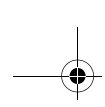

Dell™ PowerVault™ MD1120

Châssis de stockage

Mise en route de votre système

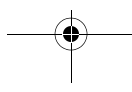
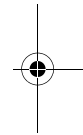
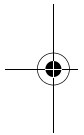

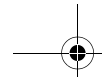

Remarques, avis et précautions



REMARQUE : Une REMARQUE indique des informations importantes qui peuvent vous aider à mieux utiliser votre ordinateur.



AVIS : Un AVIS vous avertit d'un risque de dommage matériel ou de perte de données et vous indique comment éviter le problème.



PRÉCAUTION : Une PRÉCAUTION vous avertit d'un risque d'endommagement du matériel, de blessure corporelle ou de mort.

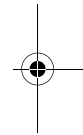
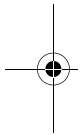

Les informations contenues dans ce document sont sujettes à modification sans préavis.
© 2008 Dell Inc. Tous droits réservés.

La reproduction de ces documents de quelque manière que ce soit sans l'autorisation écrite de Dell Inc. est strictement interdite.

Marques utilisées dans ce document : *Dell*, le logo *DELL*, *PowerEdge*, *PowerVault* et *Dell OpenManage* sont des marques de Dell Inc. ; *Intel*, *Pentium* et *Celeron* sont des marques déposées de Intel Corporation ; *Microsoft*, *Windows* et *Windows Server* sont des marques ou des marques déposées de Microsoft Corporation aux États-Unis et/ou dans d'autres pays.

D'autres marques commerciales et noms de marque peuvent être utilisés dans ce document pour faire référence aux entités se réclamant de ces marques et de ces noms ou de leurs produits. Dell Inc. décline tout intérêt dans l'utilisation des marques commerciales et des noms de marques ne lui appartenant pas.

Modèle AMT

Août 2008

N/P RU600

Rév. A01

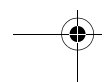
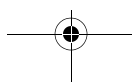

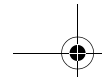

Caractéristiques du système

Cette section décrit les principales caractéristiques matérielles et logicielles du système. Elle contient également des informations relatives à d'autres documents pouvant être utiles à la configuration du système et indique comment obtenir une assistance technique.

Les principales caractéristiques du système sont les suivantes :

- Châssis de stockage à conception optimisée pour montage en rack de 2U
- Possibilité d'installer 24 disques durs à 3 Gbps de 2,5 pouces, de type SAS enfichables à chaud
- Support RAID basé sur l'hôte via un adaptateur PERC 6/E
- Blocs d'alimentation et modules de ventilation redondants et enfichables à chaud, combinés en un seul bloc pour faciliter la maintenance du système
- Second module de gestion du châssis (EMM) en option offrant des fonctions de redondance pour la gestion du système
- Prise en charge de l'une des configurations à connexion directe suivantes :
 - Mode unifié permettant la connexion directe d'un maximum de 24 disques durs
 - Mode divisé permettant la connexion directe des disques 0 à 11 sur un premier module EMM et une connexion directe distincte des disques 12 à 23 sur un second module EMM
- En mode unifié, prise en charge d'un maximum de trois châssis de stockage reliés en série (soit un total de 72 disques durs)
- Gestion intrabande effectuée via des services SCSI de gestion de châssis
- Gestion du système et de la configuration RAID via Dell OpenManage™ Server Administrator Storage Management Service ou OpenManage IT Assistant
- Quatre capteurs assurant le contrôle de la température ambiante
- Fonction d'arrêt en cas de surchauffe
- Alarme sonore signalant les pannes critiques de composants (désactivée par défaut)
- Prise en charge d'une gamme de serveurs très étendue (consultez le fichier readme du système pour obtenir la liste des systèmes pris en charge) La version la plus récente de ce fichier se trouve sur le site support.dell.com.

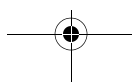
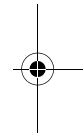
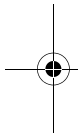

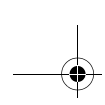

Autres informations utiles



PRÉCAUTION : Consultez les informations de sécurité et de garantie fournies avec votre système. Les informations sur la garantie se trouvent soit dans ce document, soit à part.

- Les documents *Rack Installation Guide* (Guide d'installation du rack) ou *Rack Installation Instructions* (Instructions d'installation du rack) fournis avec la solution rack décrivent l'installation du système.
- Le document *Hardware Owner's Manual* (Manuel du propriétaire) contient des informations sur les caractéristiques du système, ainsi que des instructions relatives au dépannage et à l'installation ou au remplacement de composants.
- Les CD fournis avec le système contiennent la documentation et des outils de configuration et de gestion du système.
- Si des notes d'édition ou des fichiers lisez-moi (readme) sont fournis, ils contiennent des mises à jour de dernière minute apportées au système ou à la documentation, ou bien des informations techniques destinées aux utilisateurs expérimentés ou aux techniciens.

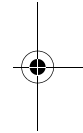
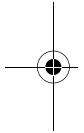

Obtention d'une assistance technique

Si vous ne comprenez pas une procédure décrite dans ce guide ou si le système ne réagit pas comme prévu, reportez-vous au document *Hardware Owner's Manual* (Manuel du propriétaire).

Des formations et certifications Dell Enterprise sont disponibles. Pour plus d'informations, consultez le site dell.com/training. Ce service n'est disponible que dans certains pays.

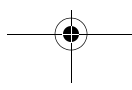

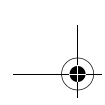

Installation et configuration

⚠ PRÉCAUTION : Avant de commencer la procédure suivante, lisez et respectez les consignes de sécurité et les informations importantes sur les réglementations fournies avec le système. Pour plus d'informations sur les meilleures pratiques en matière de sécurité, voir le site www.dell.com/regulatory_compliance.

Cette section décrit les opérations à effectuer lors de la configuration initiale du système.

Déballage du système

Sortez le système de son emballage et identifiez chaque élément.

Conservez les matériaux d'emballage au cas où vous en auriez besoin ultérieurement.

Installation des rails et du système dans un rack

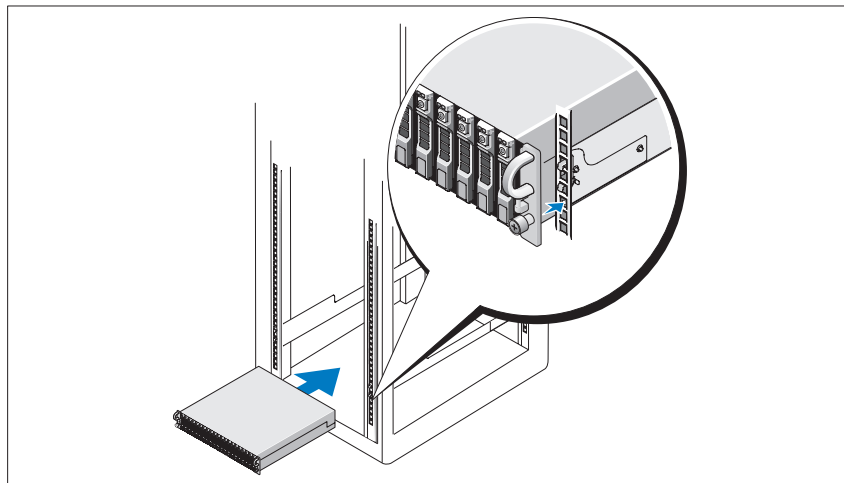

Commencez par lire la section “Safety Instructions” (Consignes de sécurité) qui se trouve dans la documentation d'installation du rack, puis installez les rails et le système dans le rack.

Consultez la documentation d'installation du rack pour obtenir les instructions appropriées.

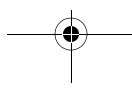



Branchement des câbles d'alimentation

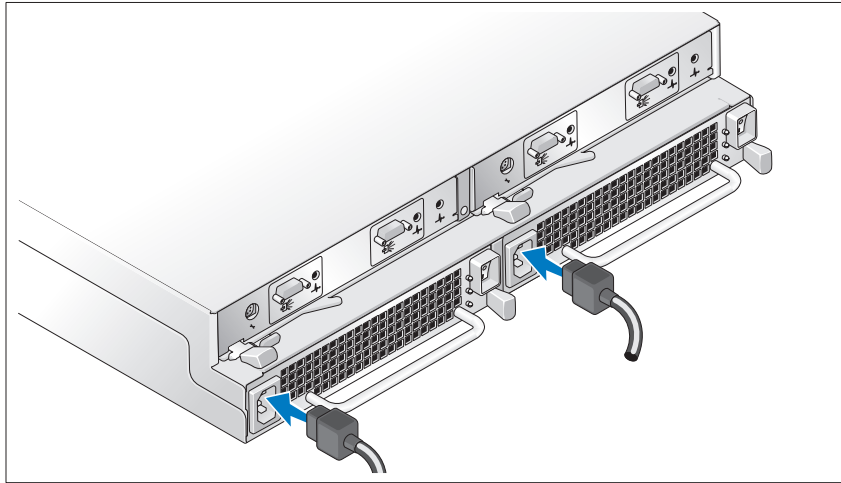

Branchez les deux câbles d'alimentation sur les modules de ventilation/ alimentation.

Fixation du support du câble d'alimentation

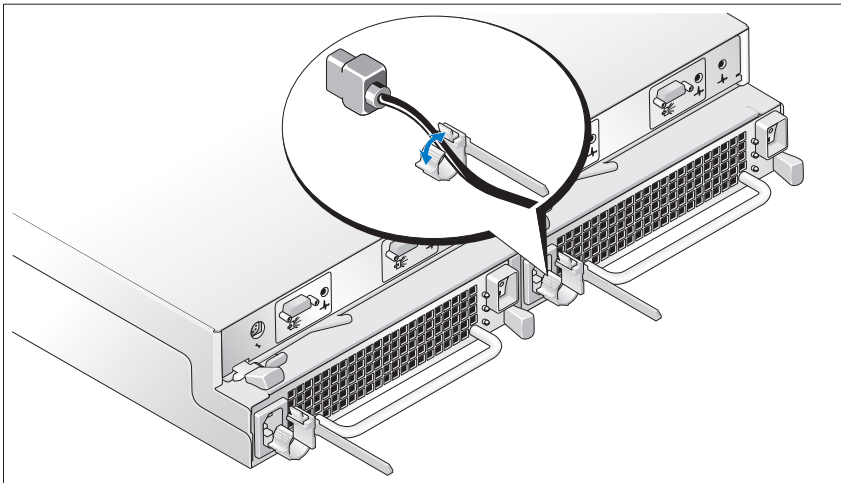



Configurez le mode de stockage du système en réglant le commutateur de configuration situé sur le panneau avant et en câblant le ou les module(s) EMM conformément aux instructions fournies dans le document *Hardware Owner's Manual* (Manuel du propriétaire).

Mise sous tension du système

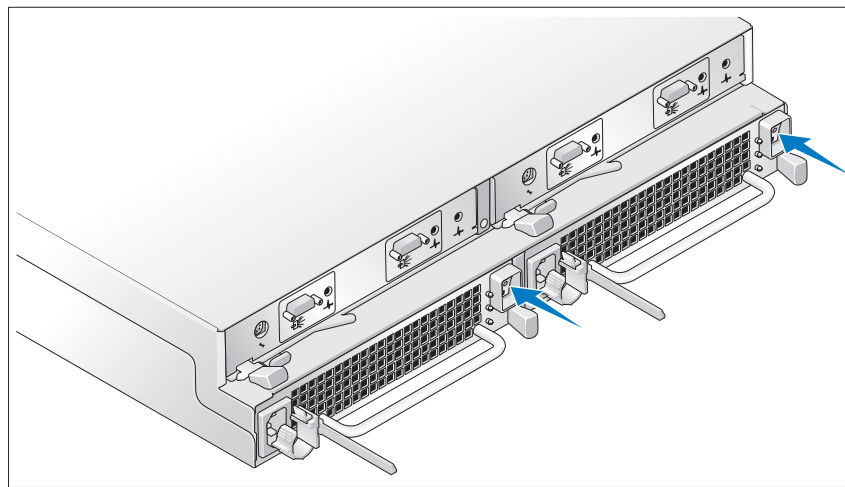

Mettez le système sous tension en allumant les deux modules de ventilation/alimentation.

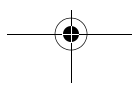
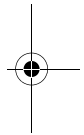
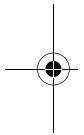

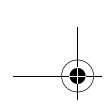

Installation du cadre

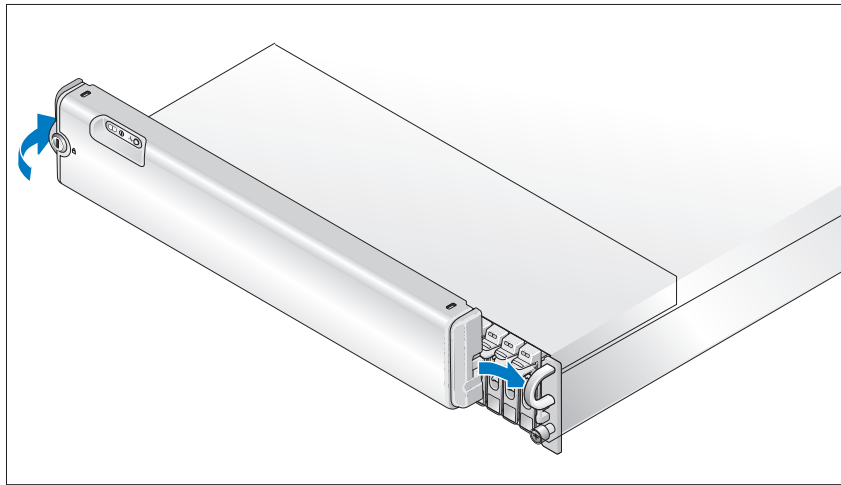

Installez le cadre (facultatif). Pour ce faire, insérez son côté droit dans la poignée de droite située à l'avant du système, puis appuyez sur le côté gauche du cadre jusqu'à ce qu'il s'emboîte sur le système (le cadre peut être légèrement différent de celui représenté dans l'illustration ci-dessus).

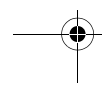
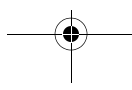
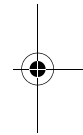
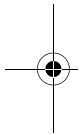

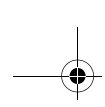

Spécifications techniques

Lecteurs

Disques durs SAS	Maximum de 24 disques durs SAS de 2,5 pouces à 3,0 Gbps, enfichables à chaud, avec une vitesse de rotation de 10 000 à 15 000 tours par minute. Consultez le fichier “Lisez-moi” du système pour les connaître capacités des disques pris en charge.
------------------	--

Connectivité

Configurations	L'une des configurations suivantes est prise en charge : <ul style="list-style-type: none">• Mode unifié permettant la connexion directe de 24 disques durs• Mode divisé avec deux modules EMM, permettant une connexion directe pour les disques 0 à 11 et une connexion directe distincte pour les disques 12 à 23• En mode unifié, prise en charge d'un maximum de trois châssis de stockage reliés en série (soit un total de 72 disques durs)
----------------	--

Modules de châssis

EMM	Un ou deux modules enfichables à chaud Chaque module EMM est équipé d'un capteur de température.
-----	---

Carte de fond de panier

Connecteurs	<ul style="list-style-type: none">• 24 connecteurs de disques durs SAS• Deux connecteurs pour les modules de ventilation/alimentation• Deux groupes de connecteurs pour les modules EMM (six connecteurs par module)• Un connecteur de panneau de commande pour les voyants frontaux et le commutateur de mode du châssis
Capteurs	Deux capteurs de température

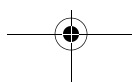

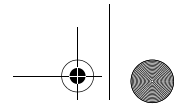

Connecteurs du panneau arrière

Connecteurs SAS (pour chaque module EMM)	<ul style="list-style-type: none"> • Un connecteur SAS (SFF 8470) "IN" pour la connexion à l'hôte • Un connecteur SAS (SFF 8470) "OUT" pour la connexion d'un châssis supplémentaire
Connecteur série (pour chaque module EMM)	Un connecteur UART mini-DIN à 6 broches (utilisation en usine uniquement)

Voyants

Panneau avant	<ul style="list-style-type: none"> • Un voyant bicolore indiquant l'état du système • Deux voyants monochromes (alimentation et mode divisé)
Support du disque dur	<ul style="list-style-type: none"> • Un voyant d'activité monochrome • Un voyant d'état bicolore par lecteur
EMM	Trois voyants d'état bicolores (un pour chaque port SAS du module EMM et un troisième indiquant l'état du module)
Module de ventilation/alimentation	Trois voyants d'état (état du bloc d'alimentation, panne du module d'alimentation/ventilation et état de l'alimentation)

Blocs d'alimentation

Puissance	Puissance maximale de 485 W en continu ; puissance de pointe de 604 W
Dissipation thermique	200 W
Tension	100–240 V
Fréquence	50/60 Hz
Intensité	7,5–3,75 A

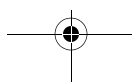

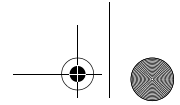

Alimentation disponible pour les disques durs (par logement)

Consommation prise en charge pour l'alimentation des disques durs (en continu)	Jusqu'à 0,5 A à +12 V Jusqu'à 1,2 A à +5 V
--	---

Caractéristiques physiques

Hauteur	8,60 cm (3,375 pouces)
Largeur	44,50 cm (17,5 pouces)
Profondeur	46,40 cm (18,25 pouces)
Poids (configuration maximale)	23,60 kg (52 livres)

Environnement

REMARQUE : Pour plus d'informations concernant les mesures d'exploitation liées à différentes configurations spécifiques, rendez-vous à l'adresse dell.com/environmental_datasheets. Le système n'est pas conçu pour être utilisé dans un environnement de bureau.

Température

Fonctionnement	De 10° à 35°C (50 à 95°F)
Stockage	De -40° à 65°C (-40° à 149°F)

Humidité relative

Fonctionnement	De 20 à 80% (sans condensation)
Stockage	De 5% à 95% (sans condensation)

Altitude

Fonctionnement	De -16 à 3 048 m (de -50 à 10 000 pieds)
Stockage	De -16 à 10 600 m (de -50 à 35 000 pieds)

BTU par heure (Kcal/h)	1 430 (360 kcal/h)
------------------------	--------------------

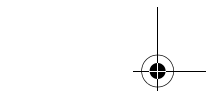
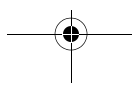
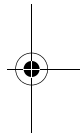
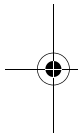

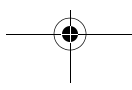
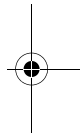
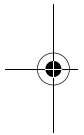

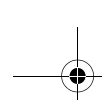

Dell™ PowerVault™ MD1120

Invólucro de armazenamento

Introdução ao uso do seu sistema

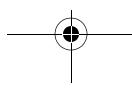
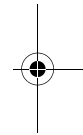
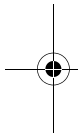

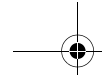

Notas, avisos e advertências



NOTA: as NOTAS fornecem informações importantes que o ajudam a utilizar melhor o computador.



AVISO: um AVISO indica um potencial de danos ao hardware ou de perda de dados e descreve como evitar o problema.



ADVERTÊNCIA: uma ADVERTÊNCIA indica um potencial de danos à propriedade, risco de lesões corporais ou mesmo de morte.

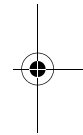
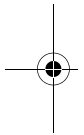

As informações contidas neste documento estão sujeitas a alterações sem aviso prévio.
© 2008 Dell Inc. Todos os direitos reservados.

É expressamente proibida qualquer forma de reprodução deste material sem a permissão por escrito da Dell Inc.

Marcas comerciais contidas neste texto: *Dell*, o logotipo *DELL*, *PowerEdge*, *PowerVault* e *Dell OpenManage* são marcas comerciais da Dell Inc.; *Intel*, *Pentium* e *Celeron* são marcas registradas da Intel Corporation; *Microsoft*, *Windows* e *Windows Server* são marcas comerciais ou registradas da Microsoft Corporation nos Estados Unidos e/ou em outros países.

Outras marcas e nomes comerciais podem ser mencionados neste documento em referência às entidades proprietárias das marcas e nomes ou a seus produtos. A Dell Inc. declara que não tem interesse de propriedade sobre marcas comerciais e nomes comerciais que não sejam os seus próprios.

Modelo AMT

Agosto de 2008

P/N RU600

Rev. A01

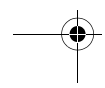
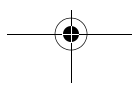

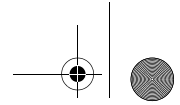

Recursos do sistema

Esta seção descreve os principais recursos de hardware e software do sistema. Também fornece informações sobre outros documentos que podem ser úteis durante a configuração do sistema e quando precisar de assistência técnica.

Os principais recursos do sistema incluem:

- Armazenagem do invólucro em um design eficiente de montagem em rack.
- Capacidade de 24 unidades de disco rígido SAS de 3.0 Gbps, com 2,5 polegadas e conexão automática.
- Suporte a RAID com base em host via adaptador PERC 6/E.
- Fonte de alimentação redundante de conexão automática e módulos de resfriamento combinados para fácil manutenção.
- Segundo módulo opcional de gerenciamento do invólucro (EMM) para proporcionar capacidade de gerenciamento redundante do sistema.
- Suporte para qualquer uma das configurações de conexão direta a seguir:
 - Modo unificado para conectividade direta de até 24 unidades de disco rígido
 - Modo dividido (com EMMs duplas), o qual proporciona conectividade direta para as unidades de 0 a 11 em uma EMM e conectividade direta em separado para as unidades de 12 a 23 na segunda EMM.
- Suporte para até três invólucros de armazenamento conectados em margarida no modo unificado, para um total de 72 unidades de disco rígido.
- Gerenciamento do invólucro in-band proporcionada por serviços de invólucros SCSI (SES).
- Gerenciamento de RAID e sistema por meio do Serviço de Gerenciamento de Armazenamento para o Dell OpenManage™ ou pelo OpenManage IT Assistant.

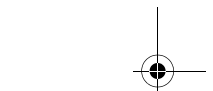
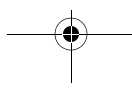
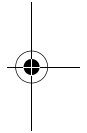
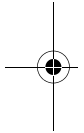

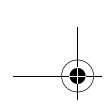

- Quatro sensores para o monitoramento da temperatura ambiente.
- Capacidade de desligamento devido a sobreaquecimento.
- Aviso sonoro para falha crítica de componentes (desativadas por padrão).
- Suporte para ampla variedade de servidores. Consulte o arquivo leia-me do sistema para conhecer os sistemas com suporte. Visualize o arquivo leia-me atualizado no site da Dell, no endereço support.dell.com (em Inglês).

Outras informações úteis

 **ADVERTÊNCIA:** Consulte as informações sobre normalização e segurança fornecidas com o sistema. As informações sobre garantia podem estar incluídas neste documento ou serem fornecidas como um documento separado.

- O documento *Rack Installation Instructions* (Instruções para montagem em rack) ou *Rack Installation Guide* (Guia para instalação em rack) incluído com a solução em rack descreve como instalar o sistema em racks.
- O *Manual do Proprietário de Hardware* fornece informações sobre os recursos do sistema e descreve como solucionar problemas do sistema e instalar ou trocar componentes.
- Os CDs fornecidos com o sistema cotêm documentação e ferramentas para a configuração e o gerenciamento do sistema.
- Eles podem conter também notas de versão e arquivos leia-me (Readme) que descrevem atualizações de última hora do sistema ou documentação e material de referência técnica avançada para usuários experientes ou técnicos.

Como obter assistência técnica

Se não compreender algum procedimento descrito neste guia ou se o sistema não apresentar o desempenho esperado, consulte o *Manual do proprietário de hardware*.

Existem recursos de treinamento e certificação empresarial da Dell; visite o site www.dell.com/training (em inglês) para obter mais informações. Esse serviço pode não ser oferecido em todos os locais.

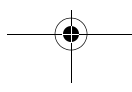

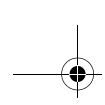

Instalação e configuração

⚠ ADVERTÊNCIA: Antes de executar o seguinte procedimento, leia e siga as instruções de segurança e as informações importantes sobre regulamentação fornecidas com o sistema. Para obter informações adicionais sobre as práticas recomendadas de segurança, consulte www.dell.com/regulatory_compliance.

Esta seção descreve as etapas para a configuração do sistema pela primeira vez.

Remoção do sistema da embalagem

Remova o sistema da embalagem e identifique cada item.

Mantenha todos os materiais de envio para o caso de precisar deles mais tarde.

Instalação dos trilhos e do sistema no rack

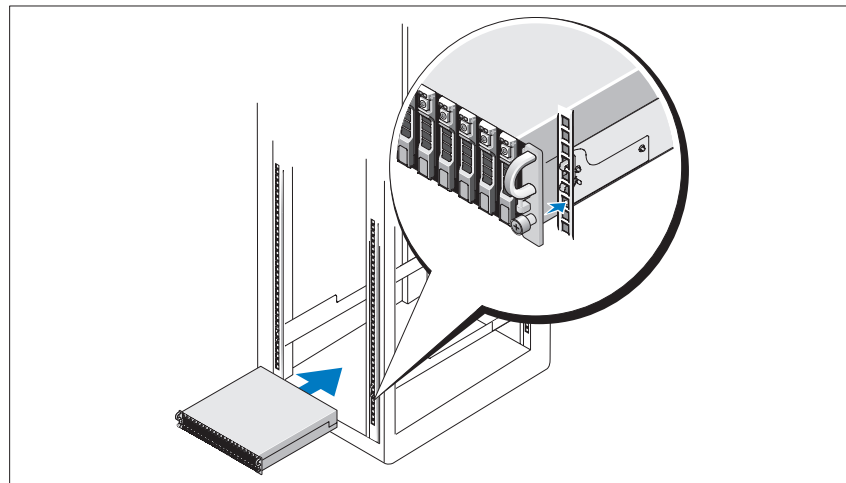

Depois de ler as instruções de segurança localizadas na documentação de instalação do rack para o sistema, instale os trilhos e o sistema no rack.

Consulte o documento de instalação do rack para obter instruções sobre como instalar o seu sistema em um rack.

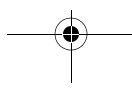



Conexão da energia

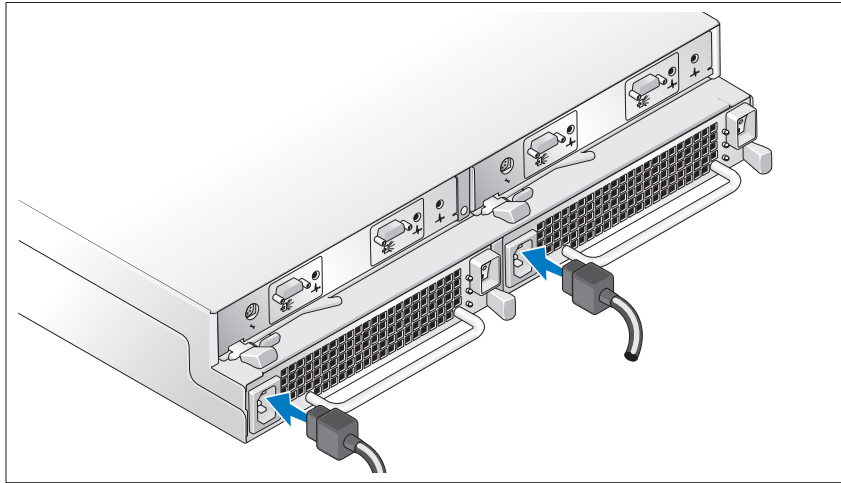

Conecte os cabos de alimentação à fonte de alimentação e aos módulos de ventiladores de resfriamento.



Como conectar o suporte de retenção do cabo de alimentação

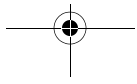
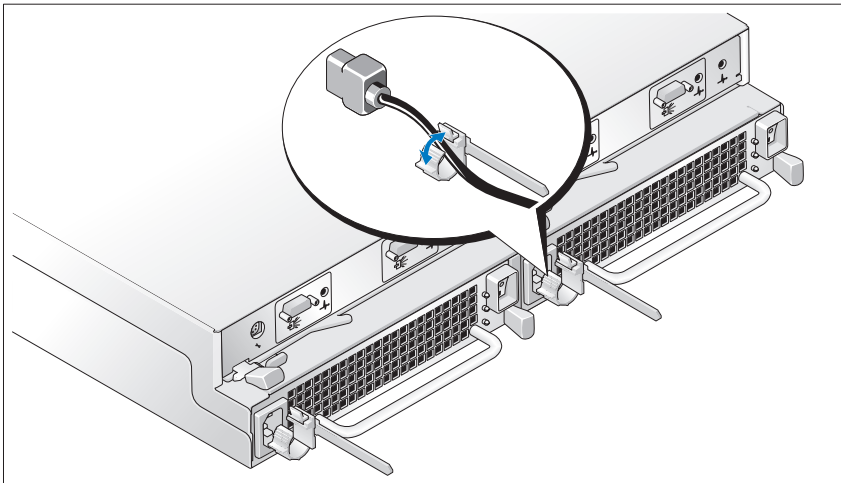



Configure o modo de armazenamento para o sistema definindo o comutador de configuração localizado na parte frontal do sistema e realizando o cabeamento das EMMs de acordo com as instruções fornecidas no *Hardware Owner's Manual* (Manual do proprietário de hardware).

Como ligar o sistema

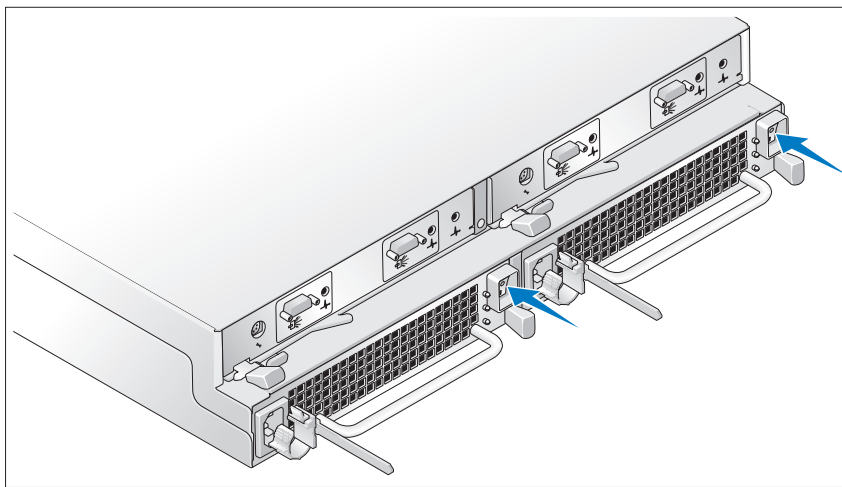

Ative o sistema ligando a fonte de alimentação e os módulos de ventiladores de resfriamento.

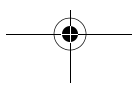
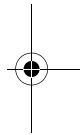
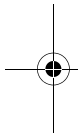

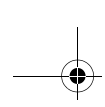

Instalação do painel

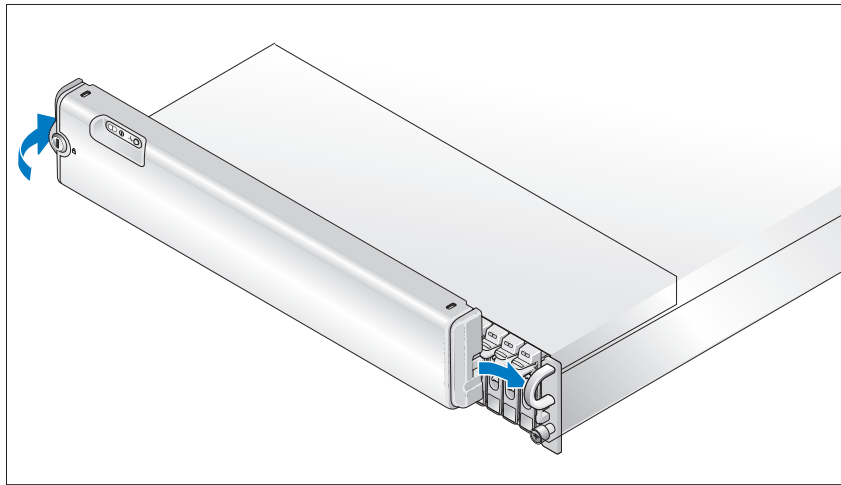

Instale o painel (opcional) inserindo a borda direita do painel na presilha frontal direita do sistema e pressionando a borda esquerda do painel contra o sistema até que se encaixe no lugar (o design do painel pode variar um pouco da ilustração acima).

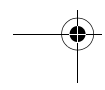
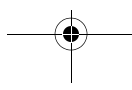
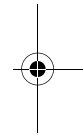
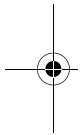

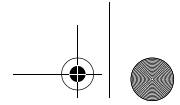

Especificações técnicas

Unidades

Unidades de disco rígido SAS	Até 24 unidades de disco rígido SAS de 2,5 pol. (3,0 Gbps) de conexão automática, a velocidades de 10 K ou 15 K rpm (consulte o arquivo leia-me do sistema para conhecer as capacidades de disco com suporte).
------------------------------	--

Conectividade

Configurações	<p>Suporte para qualquer uma das seguintes configurações:</p> <ul style="list-style-type: none">• Modo unificado para conectividade direta de 24 unidades de disco rígido• Modo dividido com EMMs duplas que proporcionam conectividade direta para as unidades de 0 a 11 e de 12 a 23 em separado• Suporte para até três invólucros de armazenamento conectados em margarida no modo unificado, para um total de 72 unidades de disco rígido
---------------	---

Módulos de invólucro

EMMs	Um ou dois módulos de conexão automática Cada EMM tem um sensor de temperatura
------	---

Placa de backplane

Conectores	<ul style="list-style-type: none">• 24 conectores disco rígido SAS• 2 conectores de fonte de alimentação/módulos de ventiladores de resfriamento• 2 conjuntos de conectores de EMM (6 conectores para cada EMM)• 1 conector do painel de controle para os LEDs frontais e para o comutador do modo de contenção.
------------	---

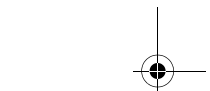
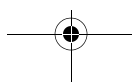

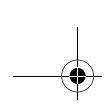

Placa de backplane

Sensores Dois sensores de temperatura

Conectores do painel traseiro

Conectores SAS (por EMM)

- 1 conector “IN” SAS (SFF 8470) para conexão ao host.
- 1 conector “OUT” SAS (SFF 8470) para expansão de invólucro adicional.

Conector serial (por EMM) 1 conector mini-DIN UART de seis pinos (somente para uso da fábrica).

LEDs indicadores

Painel frontal

- 1 LED indicador de duas cores para o status do sistema.
- 2 LEDs indicadores de cor única para energia e modo dividido.

Carregador da unidade de disco rígido

- 1 LED de atividade de cor única.
- 1 LED indicador de status de duas cores por unidade.

EMM 3 LEDs indicadores de status de duas cores, um para cada uma das portas SAS de EMM e um para o status do EMM.

Fonte de alimentação/módulo de ventiladores de resfriamento 3 LEDs indicadores para status da fonte de alimentação, falha de fonte alimentação/ventilador e status da corrente alternada (AC).

Fontes de alimentação

Potência 485 W contínua máxima; pico de 604 W

Dissipação de calor 200 W

Tensão 100–240 V

Frequência 50 ou 60 Hz

Amperagem 7,5–3,75 A

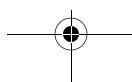

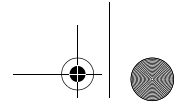

Potência disponível das unidades de disco rígido (por slot)

Consumo de energia dos discos rígidos admitido (contínuo)	Até 0,5 A a +12 V Até 1,2 A a +5 V
---	---------------------------------------

Características físicas

Altura	8,60 cm
Largura	44,50 cm
Profundidade	46,40 cm
Peso (configuração máxima)	23,60 kg

Ambientais

NOTA: Para obter informações adicionais sobre os valores ambientais para configurações de sistema específicas, visite o site dell.com/environmental_datasheets (em inglês) O sistema não se destina à utilização em escritórios.

Temperatura

De funcionamento	10 °C a 35 °C
De armazenamento	-40 °C a 65 °C

Umidade relativa

De funcionamento	20% a 80% (sem condensação)
De armazenamento	5% a 95% (sem condensação)

Altitude

De funcionamento	-16 m a 3.048 m
De armazenamento	-16 m a 10.600 m

BTUs por hora	1.430
---------------	-------

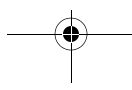
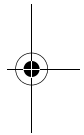
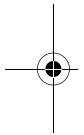

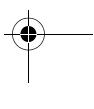
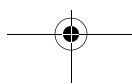
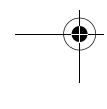
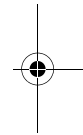
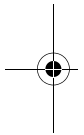
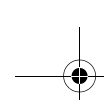

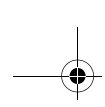

Alojamiento para
almacenamiento
Dell™ PowerVault™ MD1120
Procedimientos iniciales
con el sistema

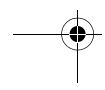
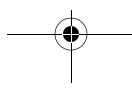
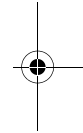
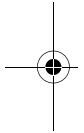

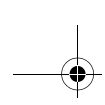

Notas, avisos y precauciones



NOTA: Una NOTA proporciona información importante que le ayudará a utilizar mejor el ordenador.



AVISO: Un AVISO indica la posibilidad de daños en el hardware o la pérdida de datos, e informa de cómo evitar el problema.



PRECAUCIÓN: Un mensaje de PRECAUCIÓN indica el riesgo de daños materiales, lesiones o incluso la muerte.

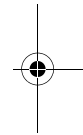
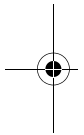

**La información contenida en este documento puede modificarse sin previo aviso.
© 2008 Dell Inc. Todos los derechos reservados.**

Queda estrictamente prohibida la reproducción de este material en cualquier forma sin la autorización por escrito de Dell Inc.

Marcas comerciales utilizadas en este texto: *Dell*, el logotipo de *DELL*, *PowerEdge*, *PowerVault* y *Dell OpenManage* son marcas comerciales de Dell Inc.; *Intel*, *Pentium* y *Celeron* son marcas comerciales registradas de Intel Corporation; *Microsoft*, *Windows* y *Windows Server* son marcas comerciales o marcas comerciales registradas de Microsoft Corporation en los Estados Unidos o en otros países.

Otras marcas y otros nombres comerciales pueden utilizarse en este documento para hacer referencia a las entidades que los poseen o a sus productos. Dell Inc. renuncia a cualquier interés sobre la propiedad de marcas y nombres comerciales que no sean los suyos.

Modelo AMT

Agosto de 2008

N/P RU600

Rev. A01

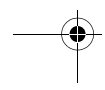
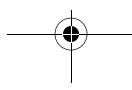

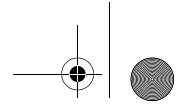

Características del sistema

En esta sección se describen las características principales del hardware y el software del sistema. También se ofrece información sobre otros documentos que puede necesitar para instalar el sistema y sobre cómo obtener asistencia técnica.

Las características principales del sistema son:

- Alojamiento para almacenamiento con un eficiente diseño de montaje en rack 2 U
- Capacidad para 24 unidades de disco duro SAS de 2,5 pulgadas, con acoplamiento activo y a 3 Gbps
- Compatibilidad con RAID basada en host mediante un adaptador PERC 6/E
- Módulos combinados de fuente de alimentación y refrigeración de acoplamiento activo redundantes para una mayor facilidad de reparación
- Un segundo módulo de administración de alojamiento (EMM) opcional para permitir la administración de sistemas redundantes
- Compatibilidad con las configuraciones de conexión directa siguientes:
 - Modo unificado para conectividad directa de hasta 24 unidades de disco duro
 - Modo dividido (con EMM duales) que proporciona conectividad directa a las unidades de la 0 a la 11 en un EMM y conectividad directa separada a las unidades de la 12 a la 23 en el segundo EMM
- Compatibilidad con un máximo de tres alojamientos para almacenamiento conectados secuencialmente en modo unificado para un total de 72 unidades de disco duro
- Administración de alojamiento en banda proporcionado a través de servicios de alojamiento SCSI (SES)
- Administración del sistema y de la RAID mediante Dell OpenManage™ Server Administrator Storage Management Service u OpenManage IT Assistant

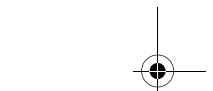
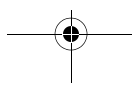
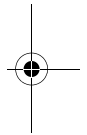
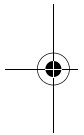

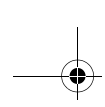

- Cuatro sensores para supervisar la temperatura ambiente
- Capacidad de apagado del sistema en caso de exceso de temperatura
- Advertencia sonora para errores críticos de componentes (opción desactivada de forma predeterminada)
- Compatibilidad con una amplia gama de servidores (Consulte el archivo Léame del sistema para ver los sistemas admitidos. Encontrará un archivo Léame actualizado en la página web de Dell en support.dell.com).

Otra información útil

 **PRECAUCIÓN:** Consulte la información sobre normativas y seguridad suministrada con el sistema. La información sobre la garantía puede estar incluida en este documento o constar en un documento aparte.

- En los documentos *Instrucciones de instalación del rack* o *Guía de instalación del rack* incluidos con el rack se describe cómo instalar el sistema en un rack.
- En el *Manual del propietario del hardware* se proporciona información sobre las características del sistema y se describe cómo solucionar problemas del sistema e instalar o sustituir componentes.
- Los CD que se facilitan con el sistema contienen documentación y herramientas para configurar y administrar el sistema.
- Es posible que se incluyan notas de la versión o archivos Léame para proporcionar actualizaciones de última hora relativas al sistema o a la documentación, o material avanzado de consulta técnica destinado a técnicos o usuarios experimentados.

Obtención de asistencia técnica

Si no comprende algún procedimiento descrito en esta guía o si el sistema no funciona del modo esperado, consulte el *Manual del propietario del hardware*.

Tiene a su disposición el servicio de formación y certificación Dell para empresas. Para obtener más información, visite www.dell.com/training. Es posible que este servicio no se ofrezca en todas las regiones.

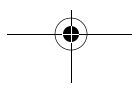



Instalación y configuración

⚠ PRECAUCIÓN: Antes de realizar el procedimiento siguiente, lea y siga las instrucciones de seguridad y la información importante sobre normativas incluidas con el sistema. Para obtener información adicional sobre prácticas recomendadas de seguridad, visite www.dell.com/regulatory_compliance.

En esta sección se describen los pasos para configurar el sistema por primera vez.

Desembalaje del sistema

Desembale el sistema e identifique cada elemento.

Guarde el material de embalaje por si lo necesita más adelante.

Instalación de los rieles y del sistema en un rack

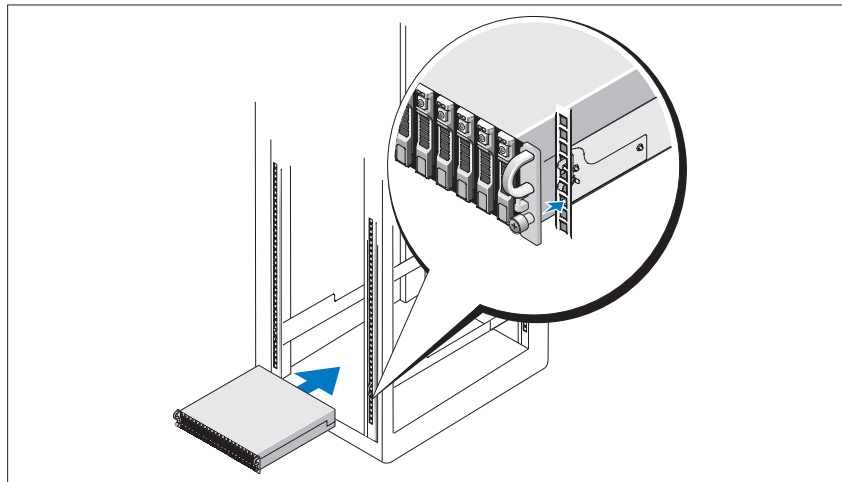

Después de leer las instrucciones de seguridad incluidas en la documentación del sistema relativa a la instalación del rack, instale los rieles y el sistema en el rack.

Consulte la documentación de instalación del rack para obtener instrucciones sobre cómo instalar el sistema en un rack.

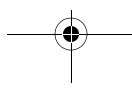



Conexión de la alimentación

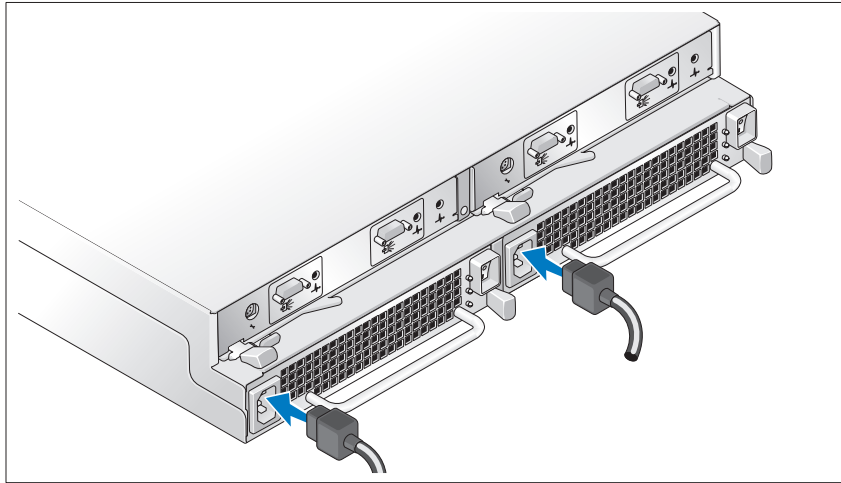

Conecte los dos cables de alimentación a los módulos de fuente de alimentación/ventilador de refrigeración.

Fijación del soporte de retención del cable de alimentación

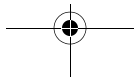
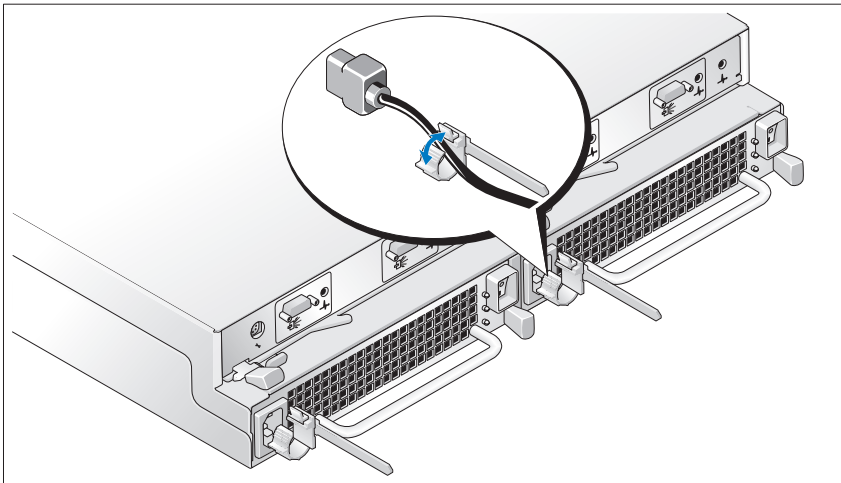



Configure el modo de almacenamiento del sistema colocando el conmutador de configuración de la parte frontal del sistema y conectando los EMM según las instrucciones proporcionadas en el *Manual del propietario del hardware*.

Encendido del sistema

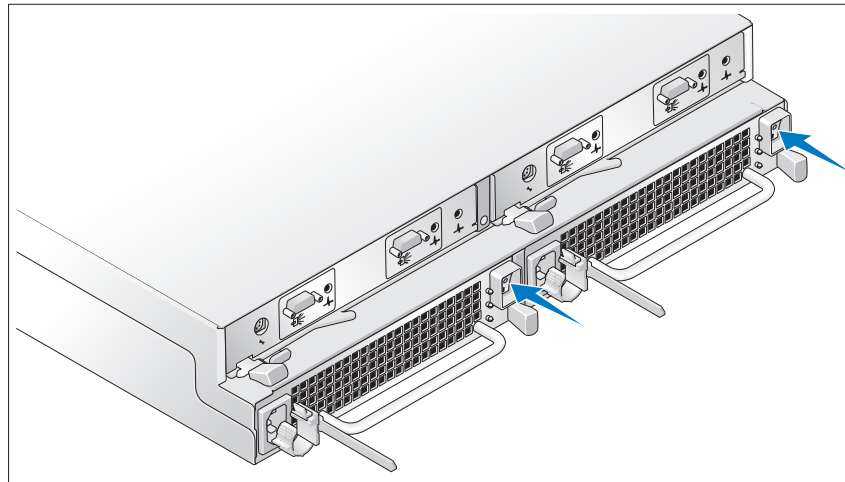

Encienda el sistema activando los dos módulos de fuente de alimentación/ventilador de refrigeración.

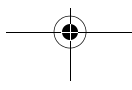

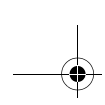

Instalación del embellecedor

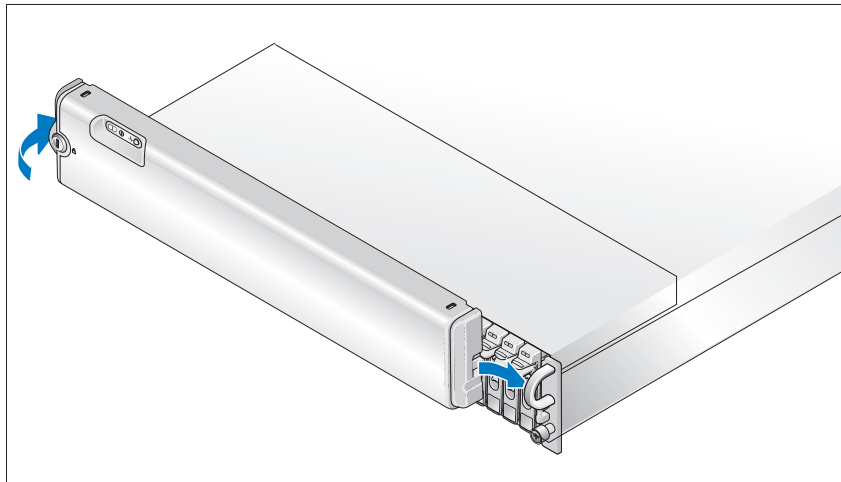

Instale el embellecedor, si lo desea, insertando el extremo derecho del embellecedor en el asa frontal derecha del sistema y luego presionando el extremo izquierdo del embellecedor contra el sistema hasta que se asiente en su lugar. El diseño del embellecedor puede variar ligeramente respecto a la ilustración.

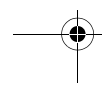
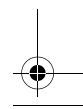
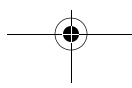
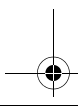
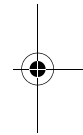
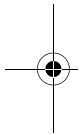

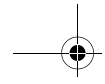

Especificaciones técnicas

Unidades

Unidades de disco duro SAS	Hasta 24 unidades de disco duro SAS de 2,5 pulgadas con acoplamiento activo (3,0 Gbps), a velocidades de 10 o 15 krpm. Para ver las capacidades de disco admitidas, consulte el archivo Léame del sistema.
----------------------------	--

Conectividad

Configuraciones	Se admiten las configuraciones siguientes: <ul style="list-style-type: none">• Modo unificado para conectividad directa de 24 unidades de disco duro• Modo dividido con EMM duales que proporciona conectividad directa a las unidades de la 0 a la 11 y conectividad directa separada a las unidades de la 12 a la 23• Hasta tres alojamientos para almacenamiento conectados secuencialmente en modo unificado para un total de 72 unidades de disco duro
-----------------	---

Módulos de alojamiento

Módulos EMM	Uno o dos módulos de acoplamiento activo Cada EMM dispone de un sensor de temperatura.
-------------	---

Placa de plano posterior

Conectores	<ul style="list-style-type: none">• 24 conectores de unidad de disco duro SAS• Dos conectores de módulo de fuente de alimentación/ventilador de refrigeración• Dos conjuntos de conectores EMM (seis conectores cada EMM)• Un conector del panel de control para LED frontales y conmutador de modo de alojamiento
Sensores	Dos sensores de temperatura

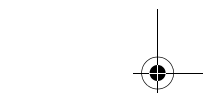
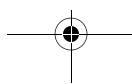

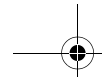

Conectores del panel posterior

Conectores SAS (por EMM)	<ul style="list-style-type: none"> • Un conector SAS (SFF 8470) de entrada para conexión al host • Un conector SAS (SFF 8470) de salida para expansión a un alojamiento adicional
Conector serie (por EMM)	Un miniconector DIN UART de 6 patas (sólo para uso en fábrica)

Indicadores LED

Panel frontal	<ul style="list-style-type: none"> • Un indicador LED de dos colores para el estado del sistema • Dos indicadores LED de un solo color para la alimentación y el modo dividido
Portaunidades de disco duro	<ul style="list-style-type: none"> • Un indicador LED de un solo color de actividad • Un indicador LED de dos colores de estado por disco
EMM	Tres indicadores LED de dos colores de estado, uno para cada uno de los dos puertos SAS del EMM y otro para el estado del EMM
Módulo de fuente de alimentación/ventilador de refrigeración	Tres indicadores LED de estado para el estado de la fuente de alimentación, los fallos de la fuente de alimentación/ventilador y el estado de CA

Fuentes de alimentación

Potencia	485 W continuos como máximo; pico de 604 W
Disipación de calor	200 W
Voltaje	100-240 V
Frecuencia	50/60 Hz
Amperaje	7,5-3,75 A

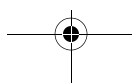

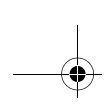

Alimentación de la unidad de disco duro disponible (por ranura)

Consumo de energía admitido de la unidad de disco duro (continuo)	Hasta 0,5 A a +12 V Hasta 1,2 A a +5 V
---	---

Características físicas

Altura	8,6 cm
Anchura	44,5 cm
Profundidad	46,4 cm
Peso en kg (configuración máxima)	23,6 kg

Especificaciones ambientales

NOTA: Para obtener información adicional sobre medidas ambientales relativas a configuraciones de sistema específicas, vaya a dell.com/environmental_datasheets. Este sistema no debe utilizarse en un entorno de oficina.

Temperatura

En funcionamiento	De 10 a 35 °C
En almacenamiento	De -40 a 65 °C

Humedad relativa

En funcionamiento	Del 20 al 80% (sin condensación)
En almacenamiento	Del 5 al 95% (sin condensación)

Altitud

En funcionamiento	De -16 a 3 048 m
En almacenamiento	De -16 a 10 600 m

BTU/h (W)	1 430 (418)
-----------	-------------

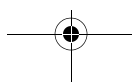
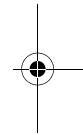
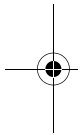

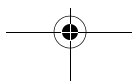
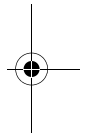
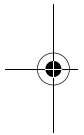



book.book Page 1 Monday, August 18, 2008 7:01 PM

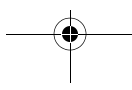
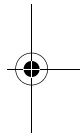
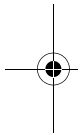

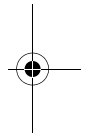
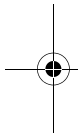
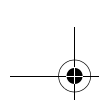

Printed in the U.S.A.
Imprimé aux États-Unis.
Impresso nos EUA.
Impreso en EE. UU.

www.dell.com | support.dell.com



ORU600A01

