

Dell™ PowerEdge™
R610 Systems
Hardware Owner's Manual



Notes, Cautions, and Warnings



NOTE: A NOTE indicates important information that helps you make better use of your computer.



CAUTION: A CAUTION indicates potential damage to hardware or loss of data if instructions are not followed.



WARNING: A WARNING indicates a potential for property damage, personal injury, or death.

Information in this document is subject to change without notice.

© 2009 Dell Inc. All rights reserved.

Reproduction of these materials in any manner whatsoever without the written permission of Dell Inc. is strictly forbidden.

Trademarks used in this text: *Dell*, the *DELL* logo, and *PowerEdge* are trademarks of Dell Inc.; *Intel* is a registered trademark of Intel Corporation in the U.S. and other countries; *Microsoft*, *Windows*, and *Windows Server* are either trademarks or registered trademarks of Microsoft Corporation in the United States and/or other countries.

Other trademarks and trade names may be used in this document to refer to either the entities claiming the marks and names or their products. Dell Inc. disclaims any proprietary interest in trademarks and trade names other than its own.

Contents

- 1 About Your System 11
 - Accessing System Features During Startup** 11
 - Front-Panel Features and Indicators** 12
 - LCD Panel Features** 14
 - Home Screen 15
 - Setup Menu 16
 - View Menu 16
 - Hard-Drive Indicator Patterns for RAID** 17
 - Back-Panel Features and Indicators** 19
 - Power Indicator Codes** 21
 - NIC Indicator Codes** 22
 - LCD Status Messages** 23
 - Viewing Status Messages 23
 - Removing LCD Status Messages 23
 - System Messages** 37
 - Warning Messages** 54
 - Diagnostics Messages** 54
 - Alert Messages** 54
 - Other Information You May Need** 55

2	Using the System Setup Program and UEFI Boot Manager	57
	Choosing the System Boot Mode	57
	Entering the System Setup Program	58
	Responding to Error Messages.	58
	Using the System Setup Program Navigation Keys.	58
	System Setup Options	59
	Main Screen.	59
	Memory Settings Screen	61
	Processor Settings Screen	61
	SATA Settings Screen.	62
	Boot Settings Screen	63
	Integrated Devices Screen	64
	PCI IRQ Assignments Screen.	65
	Serial Communication Screen	65
	Embedded Server Management Screen	66
	Power Management Screen	66
	System Security Screen	68
	Exit Screen	69
	Entering the UEFI Boot Manager.	70
	Using the UEFI Boot Manager Navigation Keys	70
	UEFI Boot Manager Screen.	71
	UEFI Boot Settings Screen	71
	System Utilities Screen	72
	System and Setup Password Features.	72
	Using the System Password	72
	Using the Setup Password	74
	iDRAC Configuration Utility	76

Entering the iDRAC Configuration Utility	76
3 Installing System Components	77
Recommended Tools.	77
Inside the System	77
Removing and Replacing the Optional Front Bezel	78
Information Tag	79
Removing the Information Tag	79
Replacing the Information Tag	80
Opening and Closing the System	80
Opening the System	80
Closing the System	81
Hard Drives.	82
Removing a Drive Blank	82
Installing a Hard-Drive Blank.	83
Removing a Hot-Swap Hard Drive	83
Installing a Hot-Swap Hard Drive	84
Removing a Hard Drive From a Hard-Drive Carrier	85
Installing a Hard Drive Into a Hard-Drive Carrier	85
Power Supplies	87
Removing a Power Supply	87
Installing a Power Supply	88
Removing the Power Supply Blank.	89
Installing the Power Supply Blank	89
Expansion Cards	89
Expansion Card Installation Guidelines	89

Installing an Expansion Card	90
Removing an Expansion Card.	92
Expansion-Card Risers.	92
Removing an Expansion-Card Riser	92
Replacing an Expansion-Card Riser	95
Internal SD Module	95
Installing the Internal SD Module.	95
Removing the Internal SD Module Card	97
Internal SD Flash Card	97
Installing an Internal SD Flash Card	97
Removing an Internal SD Flash Card	98
Internal USB Memory Key	98
Internal USB Cable.	99
Removing the Internal USB Cable	99
Installing the Internal USB Cable.	100
VFlash Media.	100
Installing a VFlash Media Card	101
Removing a VFlash Media Card	101
iDRAC6 Enterprise Card (Optional)	101
Installing an iDRAC6 Enterprise Card.	101
Removing an iDRAC6 Enterprise Card	102
NIC Hardware Key	103
Cooling Fans	104
Removing a Cooling Fan	105
Replacing a Cooling Fan	106
Removing the Fan Assembly	106
Replacing the Fan Assembly	107
Removing the Plastic Fan Guide	108

Replacing the Plastic Fan Guide	108
Optical Drive	108
Removing an Optical Drive	109
Installing an Optical Drive	110
Integrated Storage Controller Card	111
Removing the Integrated Storage Controller Card	111
Installing the Integrated Storage Controller Card	112
RAID Battery	114
Removing a RAID Battery.	114
Installing a RAID Battery	114
Removing the PERC 6/I Battery Cable	114
Installing the PERC 6/I Battery Cable.	115
System Memory	116
General Memory Module Installation Guidelines.	116
Mode-Specific Guidelines	117
Installing Memory Modules	120
Removing Memory Modules	122
Processors	122
Removing a Processor	122
Installing a Processor	125
System Battery	127
Replacing the System Battery	127
Control Panel Assembly	129
Installing the Control Panel Display Module	131
Removing the Control Panel Board.	131
Installing the Control Panel Board	132

SAS Backplane.	132
Removing the SAS Backplane	132
Installing a SAS Backplane.	135
System Board.	135
Removing the System Board	135
Installing the System Board.	138
4 Troubleshooting Your System	141
Safety First—For You and Your System	141
Troubleshooting System Startup Failure.	141
Troubleshooting External Connections	141
Troubleshooting the Video Subsystem.	142
Troubleshooting a USB Device	142
Troubleshooting a Serial I/O Device.	143
Troubleshooting a NIC	143
Troubleshooting a Wet System.	144
Troubleshooting a Damaged System.	145
Troubleshooting the System Battery.	146
Troubleshooting Power Supplies	146
Troubleshooting System Cooling Problems	147
Troubleshooting a Fan	148
Troubleshooting System Memory	148
Troubleshooting an Internal SD Card	150

	Troubleshooting an Internal USB Key	151
	Troubleshooting an Optical Drive	151
	Troubleshooting Hard Drives	152
	Troubleshooting a SAS Controller.	153
	Troubleshooting an External Tape Drive	154
	Troubleshooting Expansion Cards.	155
	Troubleshooting the Processors.	157
5	Running the System Diagnostics.	159
	Using Dell™ PowerEdge™ Diagnostics	159
	System Diagnostics Features	159
	When to Use the System Diagnostics	160
	Running the System Diagnostics	160
	System Diagnostics Testing Options	161
	Using the Custom Test Options	161
	Selecting Devices for Testing	161
	Selecting Diagnostics Options	161
	Viewing Information and Results.	162
6	Jumpers and Connectors	163
	System Board Jumpers	163
	Disabling a Forgotten Password	163
	System Board Connectors	164

7	Getting Help	167
	Contacting Dell.	167
	Glossary	169
	Index	179

About Your System

Accessing System Features During Startup

The following keystrokes provide access to system features during startup.



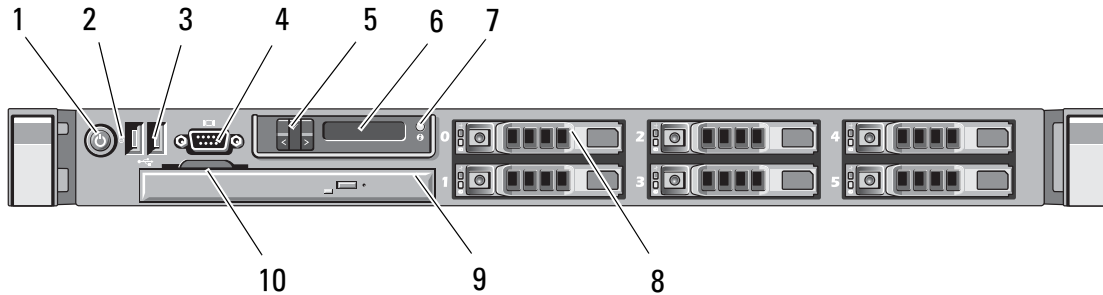

Keystroke	Description
<F2>	Enters the System Setup program. See "Using the System Setup Program and UEFI Boot Manager."
<F10>	Enters System Services, which opens the Unified Server Configurator from which you can access utilities such as system diagnostics. See the Unified Server Configurator user documentation for more information.
<F11>	Boot Mode set to BIOS: Enters the BIOS Boot Manager, which allows you to select a boot device. Boot Mode set to UEFI: Enters the UEFI Boot Manager, which enables you to manage your system's boot options.
<F12>	Enters PXE boot (if enabled in System Setup program).
<Ctrl<E>	Enters the iDRAC6 Configuration Utility, which allows access to the system event log (SEL) and configuration of remote access to the system.
<Ctrl<C>	Enters the SAS Configuration Utility. See your SAS adapter documentation for more information.
<Ctrl<R>	Enters the PERC configuration utility. For more information, see the documentation for your PERC card.
<Ctrl<S>	Enters the utility to configure NIC settings for PXE boot. For more information, see the documentation for your embedded NIC.

Front-Panel Features and Indicators

Figure 1-1. Front Panel Indicators and Features



Item	Indicator, Button, or Connector	Icon	Description
1	Power-on indicator, power button		<p>The power-on indicator lights when the system power is on.</p> <p>The power button controls the DC power supply output to the system. When the system bezel is installed, the power button is not accessible.</p> <p>NOTE: When powering on the system, the video monitor can take up to 25 seconds to display an image, depending on the amount of memory installed in the system.</p> <p>NOTE: On ACPI-compliant operating systems, turning off the system using the power button causes the system to perform a graceful shutdown before power to the system is turned off.</p> <p>NOTE: To force an ungraceful shutdown, press and hold the power button for five seconds.</p>

Item	Indicator, Button, or Connector	Icon	Description
2	NMI button		Used to troubleshoot software and device driver errors when using certain operating systems. This button can be pressed using the end of a paper clip. Use this button only if directed to do so by qualified support personnel or by the operating system's documentation.
3	USB connectors (2)		Connects USB devices to the system. The ports are USB 2.0-complaint.
4	Video connector		Connects a monitor to the system.
5	LCD menu buttons		Allows you to navigate the control panel LCD menu.
6	LCD panel		Provides system ID, status information, and system error messages. The LCD lights blue during normal system operation. The LCD lights amber when the system needs attention, and the LCD panel displays an error code followed by descriptive text. NOTE: If the system is connected to AC power and an error has been detected, the LCD lights amber regardless of whether the system has been powered on.
7	System identification button		The identification buttons on the front and back panels can be used to locate a particular system within a rack. When one of these buttons is pushed, the LCD panel on the front and the system status indicator on the chassis back panel flash blue until one of the buttons is pushed again.

Item	Indicator, Button, or Connector	Icon	Description
8	Hard drives (6)		Up to six 2.5-inch hard drives
9	Optical drive (optional)		One optional slim-line SATA DVD drive or DVD+RW drive. NOTE: DVD devices are data only.
10	System identification panel		A slide-out panel for system information including the Express Service tag, embedded NIC MAC address, and iDRAC6 Enterprise card MAC address. Space is provided for an additional label.

LCD Panel Features

The system's LCD panel provides system information and status messages to signify when the system is operating correctly or when the system needs attention. See "LCD Status Messages" for information on specific status codes.

The LCD backlight lights blue during normal operating conditions and lights amber to indicate an error condition. When the system is in standby mode, the LCD backlight will switch off after five minutes of inactivity, and can be turned on by pressing the Select button on the LCD panel. The LCD backlight will remain off if the "No Message" option is selected through the iDRAC6, the LCD panel, or other tools.

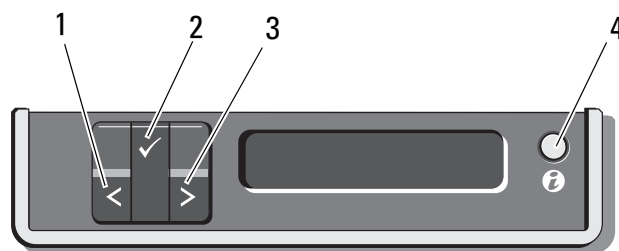

Figure 1-2. LCD Panel Features



Item	Buttons	Description
1	Left	Moves the cursor back in one-step increments.
2	Select	Selects the menu item highlighted by the cursor.
3	Right	Moves the cursor forward in one-step increments. During message scrolling: <ul style="list-style-type: none">• Press once to increase scrolling speed.• Press again to stop.• Press again to return to default scrolling.• Press again to repeat the cycle.
4	System ID	Turns the system ID mode on and off. Press quickly to toggle the system ID on and off. If the system hangs during POST, press and hold the system ID button for more than five seconds to enter BIOS Progress mode.

Home Screen

The Home screen displays user-configurable information about the system. This screen is displayed during normal system operation when there are no status messages or errors present. When the system is in standby mode, the LCD backlight will turn off after five minutes of inactivity if there are no error messages. Press one of the three navigation buttons (Select, Left, or Right) to view the Home screen.

To navigate to the Home screen from another menu, continue to select the up arrow  until the Home icon  is displayed, and then select the Home icon.

Setup Menu

Option	Description
DRAC	Select DHCP or Static IP to configure the network mode. If Static IP is selected, the available fields are IP , Subnet (Sub) , and Gateway (Gtw) . Select Setup DNS to enable DNS and to view domain addresses. Two separate DNS entries are available.
Set error	Select SEL to display LCD error messages in a format that matches the IPMI description in the SEL log. This can be useful when trying to match an LCD message with an SEL entry. Select Simple to display LCD error messages in a more user-friendly description. See "LCD Status Messages" for a list of messages in this format.
Set home	Select the default information to be displayed on the LCD Home screen. See "View Menu" to see the options and option items that can be selected to display by default on the Home screen.

View Menu

Option	Description
DRAC IP	Displays the IPv4 or IPv6 addresses for the iDRAC6. Addresses include DNS (Primary and Secondary) , Gateway, IP , and Subnet (IPv6 does not have Subnet).
MAC	Displays the MAC addresses for DRAC , iSCSIn , or NETn .
Name	Displays the name of the Host , Model , or User String for the system.
Number	Displays the Asset tag or the Service tag for the system.
Power	Displays the power output of the system in BTU/hr or Watts. The display format can be configured in the "Set home" submenu of the Setup menu (see "Setup Menu").

Option	Description
Temperature	Displays the temperature of the system in Celsius or Fahrenheit. The display format can be configured in the "Set home" submenu of the Setup menu (see "Setup Menu").

Hard-Drive Indicator Patterns for RAID

Figure 1-3. Hard Drive Indicators



1 drive-activity indicator (green)

2 drive-status indicator (green and amber)





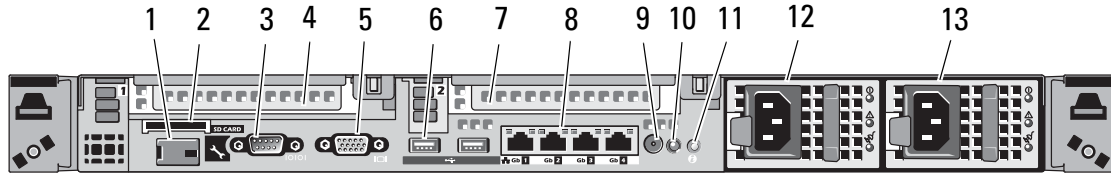

Drive-Status Indicator Pattern (RAID Only)	Description
Blinks green two times per second	Identify drive/preparing for removal
Off	Drive ready for insertion or removal NOTE: The drive status indicator remains off until all hard drives are initialized after system power is applied. Drives are not ready for insertion or removal during this time.
Blinks green, amber, and off	Drive predicted failure
Blinks amber four times per second	Drive failed
Blinks green slowly	Drive rebuilding
Steady green	Drive online

Back-Panel Features and Indicators

Figure 1-4 shows the controls, indicators, and connectors located on the system's back panel.

Figure 1-4. Back-Panel Features and Indicators



Item	Indicator, Button, or Connector	Icon	Description
1	iDRAC6 Enterprise port (optional)		Dedicated management port for the optional iDRAC6 Enterprise card.
2	VFlash media slot (optional)		Connects an external SD memory card for the optional iDRAC6 Enterprise card.
3	serial connector		Connects a serial device to the system.
4	PCIe slot 1		PCI Express (generation 2) x8-wide expansion slot (full-height, half-length)
5	video connector		Connects a VGA display to the system.
6	USB connectors (2)		Connects USB devices to the system. The ports are USB 2.0-complaint.
7	PCIe slot 2		PCIe Gen2 x8-wide expansion slot (full-height, half-length)
8	Ethernet connectors (4)		Embedded 10/100/1000 NIC connectors.
9	system status indicator connector		Connector for attaching a system indicator extension cable that is used on a cable management arm
10	system status indicator		Provides a power on indicator for the back of the system

Item	Indicator, Button, or Connector	Icon	Description
11	system identification button		Turns the system ID modes on and off. The identification buttons on the front and back panels can be used to locate a particular system within a rack. When one of these buttons is pushed, the LCD panel on the front and the system status indicator on the chassis back panel light blue until one of the buttons is pushed again.
12	power supply 1 (PS1)		717-W or 502-W power supply
13	power supply 2 (PS2)		717-W or 502-W power supply

Power Indicator Codes

An LED indicator on the power button indicates when power is supplied to the system and the system is operational.

The power supplies have an indicator that shows whether power is present or whether a power fault has occurred.

- Not lit — AC power is not connected.
- Green — In standby mode, indicates that a valid AC source is connected to the power supply, and that the power supply is operational. When the system is on, it also indicates that the power supply is providing DC power to the system.
- Amber — Indicates a problem with the power supply.
- Alternating green and amber — When hot-adding a power supply, indicates that the power supply is mismatched with the other power supply (a High Output power supply and an Energy Smart power supply are installed in the same system). Replace the power supply that has the flashing indicator with a power supply that matches the capacity of the other installed power supply.



CAUTION: If troubleshooting a PSU mismatch error, replace only the power supply with the flashing indicator. Swapping the opposite power supply to create a matched pair can result in an error condition and unexpected system shutdown. To change from a High Output configuration to an Energy Smart configuration or vice versa, you must power down the system.

Figure 1-5. Power Supply Status Indicator

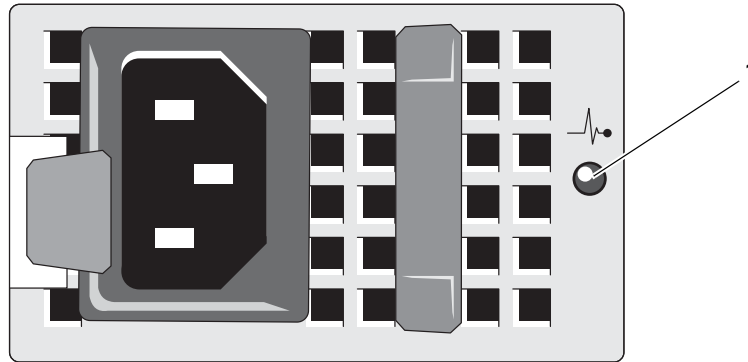

1 power supply status

NIC Indicator Codes

Figure 1-6. NIC Indicators

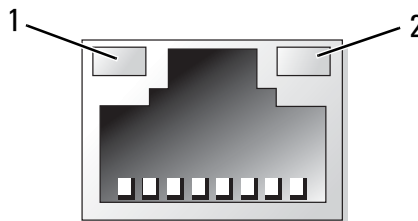

1 link indicator

2 activity indicator

Indicator	Description
Link and activity indicators are off	The NIC is not connected to the network.
Link indicator is green	The NIC is connected to a valid network link at 1000 Mbps.
Link indicator is amber	The NIC is connected to a valid network link at 10/100 Mbps.
Activity indicator is green blinking	Network data is being sent or received.

LCD Status Messages

The following LCD messages refer to events recorded in the System Event Log (SEL). (The messages are shown here in "simple" text format.) For information on the SEL and configuring system management settings, see the systems management software documentation.



NOTE: If your system fails to boot, press the System ID button for at least five seconds until an error code appears on the LCD. Record the code, then see "Getting Help."

Viewing Status Messages

If a system error code occurs, the LCD screen will turn amber. Press the Select button to view the list of errors or status messages. Use the Left and Right buttons highlight an error number, and press Select to view the error.

Removing LCD Status Messages

For faults associated with sensors, such as temperature, voltage, fans, and so on, the LCD message is automatically removed when that sensor returns to a normal state. For other faults, you must take action to remove the message from the LCD display:

- Clear the SEL — You can perform this task remotely, but you will lose the event history for the system.
- Power cycle — Turn off the system and disconnect it from the electrical outlet; wait approximately ten seconds, reconnect the power cable, and restart the system.

To resolve the problem and remove the LCD message, refer to the corrective actions in the following table.

 **NOTE:** The following LCD status messages are displayed in the Simple format. See "Setup Menu" to select the format in which the messages are displayed.

Table 1-1. LCD Status Messages

Code	Text	Cause	Corrective Actions
E1000	Failsafe voltage error. Contact support.	Check the system event log for critical failure events.	Remove AC power to the system for 10 seconds or clear the SEL. If the problem persists, see "Getting Help."
E1114	Ambient Temp exceeds allowed range.	Ambient temperature has reached a point outside of the allowed range.	See "Troubleshooting System Cooling Problems."
E1116	Memory disabled, temp above range. Power cycle AC.	Memory has exceeded allowable temperature and has been disabled to prevent damage to the components.	Remove AC power to the system for 10 seconds and restart the system. See "Troubleshooting System Cooling Problems." If the problem persists, see "Getting Help."
E1210	Motherboard battery failure. Check battery.	CMOS battery is missing or the voltage is outside of the allowable range.	See "Troubleshooting the System Battery."
E1211	RAID Controller battery failure. Check battery.	RAID battery is either missing, bad, or unable to recharge due to thermal issues.	Reseat the RAID battery connector. See "Installing a RAID Battery" and "Troubleshooting System Cooling Problems."

Table 1-1. LCD Status Messages (continued)

Code	Text	Cause	Corrective Actions
E1216	3.3V Regulator failure. Reseat PCIe cards.	3.3V voltage regulator has failed.	Remove and reseat the PCIe expansion cards. If the problem persists, see "Troubleshooting Expansion Cards."
E1229	CPU # VCORE Regulator failure. Reseat CPU.	Specified processor VCORE voltage regulator has failed.	Reseat the processor(s). See "Troubleshooting the Processors." If the problem persists, see "Getting Help."
E122A	CPU # VTT Regulator failure. Reseat CPU.	Specified processor VTT voltage regulator has failed.	Reseat the processor(s). See "Troubleshooting the Processors." If the problem persists, see "Getting Help."
E122C	CPU Power Fault. Power cycle AC.	A power fault was detected when powering up the processor(s).	Remove AC power to the system for 10 seconds and restart the system. If the problem persists, see "Getting Help."
E122D	Memory Regulator # Failed. Reseat DIMMs.	One of the memory regulators has failed.	Reseat the memory modules. See "Troubleshooting System Memory."
E122E	On-board regulator failed. Call support.	One of the on-board voltage regulators failed.	Remove AC power to the system for 10 seconds and restart the system. If the problem persists, see "Getting Help."
E1310	Fan ## RPM exceeding range. Check fan.	RPM of specified fan is outside of the intended operating range.	See "Troubleshooting System Cooling Problems."

Table 1-1. LCD Status Messages (continued)

Code	Text	Cause	Corrective Actions
E1311	Fan module ## RPM exceeding range. Check fan.	RPM of specified fan in specified module is outside of intended operating range.	See "Troubleshooting System Cooling Problems."
E1313	Fan redundancy lost. Check fans.	The system is no longer fan redundant. Another fan failure would put the system at risk of overheating.	Check LCD for additional scrolling messages. See "Troubleshooting a Fan."
E1410	System Fatal Error detected.	A fatal system error has been detected.	Check LCD for additional scrolling messages. Remove AC power to the system for 10 seconds and restart the system. If the problem persists, see "Getting Help."
E1414	CPU # temp exceeding range. Check CPU heatsink.	Specified processor is out of acceptable temperature range.	Ensure that the processor heat sinks are properly installed. See "Troubleshooting the Processors" and "Troubleshooting System Cooling Problems."
E1418	CPU # not detected. Check CPU is seated properly.	Specified processor is missing or bad, and the system is in an unsupported configuration.	Ensure that the specified microprocessor is properly installed. See "Troubleshooting the Processors."
E141C	Unsupported CPU configuration. Check CPU or BIOS revision.	Processors are in an unsupported configuration.	Ensure that your microprocessors match and conform to the type described in the microprocessor technical specifications outlined in your system's <i>Getting Started Guide</i> .

Table 1-1. LCD Status Messages (continued)

Code	Text	Cause	Corrective Actions
E141F	CPU # protocol error. Power cycle AC.	The system BIOS has reported a processor protocol error.	Remove AC power to the system for 10 seconds and restart the system. If the problem persists, see "Getting Help."
E1420	CPU Bus parity error. Power cycle AC.	The system BIOS has reported a microprocessor bus parity error.	Remove AC power to the system for 10 seconds or clear the SEL. If the problem persists, see "Getting Help."
E1422	CPU # machine check error. Power cycle AC.	The system BIOS has reported a machine check error.	Remove AC power to the system for 10 seconds and restart the system. If the problem persists, see "Getting Help."
E1610	Power Supply # (### W) missing. Check power supply.	Specified power supply was removed or is missing from the system.	See "Troubleshooting Power Supplies."
E1614	Power Supply # (### W) error. Check power supply.	Specified power supply has failed.	See "Troubleshooting Power Supplies."
E1618	Predictive failure on Power Supply # (### W). Check PSU.	A power supply fan failure, an over-temperature condition, or power supply communication error has caused the predictive warning of an impending power supply failure.	See "Troubleshooting Power Supplies."

Table 1-1. LCD Status Messages (continued)

Code	Text	Cause	Corrective Actions
E161C	Power Supply # (### W) lost AC power. Check PSU cables.	Specified power supply is attached to the system, but it has lost its AC input.	Check the AC power source for the specified power supply. If the problem persists, see "Troubleshooting Power Supplies."
E1620	Power Supply # (### W) AC power error. Check PSU cables.	Specified power supply's AC input is outside of the allowable range.	Check the AC power source for the specified power supply. If the problem persists, see "Troubleshooting Power Supplies."
E1624	Lost power supply redundancy. Check PSU cables.	The power supply subsystem is no longer redundant. If the remaining power supply fails, the system will shut down.	See "Troubleshooting Power Supplies."
E1626	Power Supply Mismatch. PSU1 = ### W, PSU2 = ### W.	The power supplies in the system are not the same wattage.	Ensure that power supplies with matching wattage are installed. See the Technical Specifications outlined in your system's <i>Getting Started Guide</i> .
E1629	Power required > PSU wattage. Check PSU and config.	The system configuration requires more power than the power supplies can provide, even with throttling.	Turn off power to the system, reduce the hardware configuration or install higher-wattage power supplies, and then restart the system.

Table 1-1. LCD Status Messages (continued)

Code	Text	Cause	Corrective Actions
E1710	I/O channel check error. Review & clear SEL.	The system BIOS has reported an I/O channel check.	Check the SEL for details of the error message. Remove AC power to the system for 10 seconds and restart the system. If the problem persists, see "Getting Help."
E1711	PCI parity error on Bus ## Device ## Function ##	The system BIOS has reported a PCI parity error on a component that resides in PCI configuration space at bus ##, device ##, function ##.	Remove and reseal the PCIe expansion cards. If the problem persists, see "Troubleshooting Expansion Cards."
	PCI parity error on Slot #. Review & clear SEL.	The system BIOS has reported a PCI parity error on a component that resides in the specified slot.	Check the SEL for details of the error message. Remove and reseal the PCIe expansion cards. If the problem persists, see "Troubleshooting Expansion Cards."
E1712	PCI system error on Bus ## Device ## Function ##	The system BIOS has reported a PCI system error on a component that resides in PCI configuration space at bus ##, device ##, function ##.	Remove and reseal the PCIe expansion cards. If the problem persists, see "Troubleshooting Expansion Cards."
	PCI system error on Slot #. Review & clear SEL.	The system BIOS has reported a PCI system error on a component that resides in the specified slot.	Reinstall the expansion-card riser. See "Expansion-Card Risers." If the problem persists, the riser card or system board is faulty. See "Getting Help."

Table 1-1. LCD Status Messages (continued)

Code	Text	Cause	Corrective Actions
E1714	Unknown error. Review & clear SEL.	The system BIOS has determined there has been an error in the system, but is unable to determine its origin.	Remove AC power to the system for 10 seconds and restart the system. If the problem persists, see "Getting Help."
E1715	Fatal I/O error. Review & clear SEL.	The system BIOS has determined there has been an error in the system.	Check the SEL for details of the error message and then clear the SEL. Remove AC power to the system for 10 seconds and restart the system. If the problem persists, see "Getting Help."
E1716	Chipset IERR Bus ## Dev ## Function ##. Review & clear SEL.	The system BIOS has reported a chipset internal error that resides in bus ##, device ##, function##.	Check the SEL for details of the error message and then clear the SEL. Remove AC power to the system for 10 seconds and restart the system. If the problem persists, see "Getting Help."
E1717	CPU ## internal error. Review & clear SEL.	The system BIOS has determined that the specified processor has had an internal error.	Check the SEL for details of the error message and then clear the SEL. Remove AC power to the system for 10 seconds and restart the system. See "Troubleshooting the Processors." If the problem persists, see "Getting Help."

Table 1-1. LCD Status Messages (continued)

Code	Text	Cause	Corrective Actions
E171F	PCIe fatal error on Bus ## Device ## Function ##	The system BIOS has reported a PCIe fatal error on a component that resides in PCI configuration space at bus ##, device ##, function ##.	Remove and reseal the PCIe expansion cards. If the problem persists, see "Troubleshooting Expansion Cards."
	PCIe fatal error on Slot #. Review & clear SEL.	The system BIOS has reported a PCIe fatal error on a component that resides in the specified slot.	Reinstall the expansion-card riser. See "Expansion-Card Risers." If the problem persists, the riser card or system board is faulty. See "Getting Help."
E1810	Hard drive ## fault. Review & clear SEL.	The specified hard drive has experienced a fault.	See "Troubleshooting Hard Drives."
E1812	Hard drive ## removed. Check drive.	The specified hard drive has been removed from the system.	Information only.
E1A11	PCI Riser hardware & configuration mismatch. Reconfigure.	PCIe risers are not configured correctly. Some invalid configurations prevent the system from powering on.	Reinstall the expansion-card riser. See "Expansion-Card Risers." If the problem persists, the riser card or system board is faulty. See "Getting Help."
E1A12	PCI Riser not detected. Check Riser.	One or all of the PCIe risers is missing. This prevents the system from powering on.	Reinstall the missing riser card(s). See "Replacing an Expansion-Card Riser."
E1A14	SAS cable A failure. Check connection.	SAS cable A is missing or bad.	Reseat the cable. If the problem persists, replace cable. If the problem persists, see "Getting Help."

Table 1-1. LCD Status Messages (continued)

Code	Text	Cause	Corrective Actions
E1A15	SAS cable B failure. Check connection.	SAS cable B is missing or bad.	Reseat the cable. If the problem persists, replace cable. If the problem persists, see "Getting Help."
E1A1D	Control panel USB cable not detected. Check cable.	USB cable to the control panel is missing or bad.	Reseat the cable. If the problem persists, replace cable. If the problem persists, see "Getting Help."
E2010	Memory not detected. Inspect DIMMs.	No memory was detected in the system.	Install memory or reseat the memory modules. See "System Memory" or "Troubleshooting System Memory."
E2011	Memory configuration failure. Check DIMMs.	Memory detected, but is not configurable. Error detected during memory configuration.	See "Troubleshooting System Memory."
E2012	Memory configured but unusable. Check DIMMs.	Memory configured, but is unusable.	See "Troubleshooting System Memory."
E2013	BIOS unable to shadow memory. Check DIMMs.	The system BIOS failed to copy its flash image into memory.	See "Troubleshooting System Memory."
E2014	CMOS RAM failure. Power cycle AC.	CMOS failure. CMOS RAM not functioning properly.	Remove AC power to the system for 10 seconds and restart the system. If the problem persists, see "Getting Help."

Table 1-1. LCD Status Messages (continued)

Code	Text	Cause	Corrective Actions
E2015	DMA Controller failure. Power cycle AC.	DMA controller failure.	Remove AC power to the system for 10 seconds and restart the system. If the problem persists, see "Getting Help."
E2016	Interrupt Controller failure. Power cycle AC.	Interrupt controller failure.	Remove AC power to the system for 10 seconds and restart the system. If the problem persists, see "Getting Help."
E2017	Timer refresh failure. Power cycle AC.	Timer refresh failure.	Remove AC power to the system for 10 seconds and restart the system. If the problem persists, see "Getting Help."
E2018	Programmable Timer error. Power cycle AC.	Programmable interval timer error.	Remove AC power to the system for 10 seconds and restart the system. If the problem persists, see "Getting Help."
E2019	Parity error. Power cycle AC.	Parity error.	Remove AC power to the system for 10 seconds and restart the system. If the problem persists, see "Getting Help."
E201A	SuperIO failure. Power cycle AC.	SIO failure.	Remove AC power to the system for 10 seconds and restart the system. If the problem persists, see "Getting Help."

Table 1-1. LCD Status Messages (continued)

Code	Text	Cause	Corrective Actions
E201B	Keyboard Controller error. Power cycle AC.	Keyboard controller failure.	Remove AC power to the system for 10 seconds and restart the system. If the problem persists, see "Getting Help."
E201C	SMI initialization failure. Power cycle AC.	System management interrupt (SMI) initialization failure.	Remove AC power to the system for 10 seconds and restart the system. If the problem persists, see "Getting Help."
E201D	Shutdown test failure. Power cycle AC.	BIOS shutdown test failure.	Remove AC power to the system for 10 seconds and restart the system. If the problem persists, see "Getting Help."
E201E	POST memory test failure. Check DIMMs.	BIOS POST memory test failure.	See "Troubleshooting System Memory." If the problem persists, see "Getting Help."
E2020	CPU configuration failure. Check screen message.	Processor configuration failure.	Check screen for specific error messages. See "Troubleshooting the Processors."
E2021	Incorrect memory configuration. Review User Guide.	Incorrect memory configuration.	Check screen for specific error messages (see "Troubleshooting System Memory").
E2022	General failure during POST. Check screen message.	General failure after video.	Check screen for specific error messages.

Table 1-1. LCD Status Messages (continued)

Code	Text	Cause	Corrective Actions
E2110	Multibit Error on DIMM ##. Reseat DIMM.	The DIMM in slot "##" has had a multi-bit error (MBE).	See "Troubleshooting System Memory."
E2111	SBE log disabled on DIMM ##. Reseat DIMM.	The system BIOS has disabled memory single-bit error (SBE) logging and will not log anymore SBEs until the system is rebooted. "##" represents the DIMM implicated by the BIOS.	Remove AC power to the system for 10 seconds and restart the system. If the problem persists, see "Troubleshooting System Memory."
E2113	Mem mirror OFF on DIMM ## & ##. Power cycle AC	The system BIOS has disabled memory mirroring because it has determined one half of the mirror has had too many errors. "## & ##" represents the DIMM pair implicated by the BIOS.	Remove AC power to the system for 10 seconds and restart the system. If the problem persists, see "Troubleshooting System Memory."
I1910	Intrusion detected. Check chassis cover.	System cover has been removed.	Information only.
I1911	LCD Log full. Check SEL to review all Errors.	LCD overflow message. A maximum of ten error messages can display sequentially on the LCD. The eleventh message instructs the user to check the SEL for details on the events.	Check the SEL for details on the events. Remove AC power to the system for 10 seconds or clear the SEL.
I1912	SEL full. Review & clear log.	The SEL is full of events and is unable to log any more.	Check the SEL for details of the error messages, then clear the SEL.

Table 1-1. LCD Status Messages (continued)

Code	Text	Cause	Corrective Actions
W1228	RAID Controller battery capacity < 24hr.	Warns predictively that the RAID battery has less than 24 hours of charge left.	Allow RAID battery to charge to greater than 24 hours of sustained charge. If problem persists, replace the RAID battery. See "Installing a RAID Battery."
W1627	Power required > PSU wattage. Check PSU and config.	The system configuration requires more power than what the power supply can provide.	Turn off power to the system, reduce the hardware configuration or install higher-wattage power supplies, and then restart the system.
W1628	Performance degraded. Check PSU and system configuration.	The system configuration requires more power than what the power supply can provide, but it can boot if throttled.	Turn off power to the system, reduce the hardware configuration or install higher-wattage power supplies, and then restart the system.

NOTE: For the full name of an abbreviation or acronym used in this table, see the "Glossary."

System Messages

System messages appear on the screen to notify you of a possible problem with the system.



NOTE: If you receive a system message not listed in the table, check the documentation for the application that is running when the message appears or the operating system's documentation for an explanation of the message and recommended action.

Table 1-2. System Messages

Message	Causes	Corrective Actions
128-bit Advanced ECC mode disabled. For 128-bit Advanced ECC, DIMMs must be installed in pairs. Pairs must be matched in size and geometry.	The memory configuration does not match the setting in BIOS. The BIOS setting has been disabled.	Reconfigure the memory modules to support Advanced ECC mode. See "System Memory."
Alert! Advanced ECC Memory Mode disabled! Memory configuration does not support Advanced ECC Memory Mode.	Advanced ECC Memory Mode was enabled in the system setup program, but the current configuration does not support Advanced ECC Memory Mode. A memory module may be faulty.	Ensure that the memory modules are installed in a configuration that supports Advanced ECC Memory Mode. Check other system messages for additional information for possible causes. For memory configuration information, see "System Memory." Check other messages for faulty memory modules. If the problem persists, see "Troubleshooting System Memory."

Table 1-2. System Messages (continued)

Message	Causes	Corrective Actions
Alert! iDRAC6 not responding. Rebooting.	The iDRAC6 is not responding to BIOS communication either because it is not functioning properly or has not completed initialization. The system will reboot.	Wait for the system to reboot.
Alert! iDRAC6 not responding. Power required may exceed PSU wattage.	The iDRAC6 is not responding. The iDRAC6 was remotely reset while system was booting	Remove AC power to the system for 10 seconds and restart the system.
Alert! Continuing system boot accepts the risk that system may power down without warning.	After AC recovery, the iDRAC6 takes longer than normal to boot.	
Alert! Node Interleaving disabled! Memory configuration does not support Node Interleaving.	The memory configuration does not support node interleaving, or the configuration has changed (for example, a DIMM has failed) so that node interleaving cannot be supported. The system will run but node interleaving will be disabled.	Ensure that the memory modules are installed in a configuration that supports node interleaving. Check other system messages for additional information for possible causes. For memory configuration information, see "System Memory." If the problem persists, see "Troubleshooting System Memory."

Table 1-2. System Messages (continued)

Message	Causes	Corrective Actions
Alert! Power required exceeds PSU wattage. Check PSU and system configuration. Alert! Continuing system boot accepts the risk that system may power down without warning.	The system configuration of processor(s), memory modules, and expansion cards may not be supported by the power supplies.	If any system components were just upgraded, return the system to the previous configuration. If the system boots without this warning, then the replaced component(s) are not supported with this power supply. If Energy Smart power supplies are installed, replace them with the High Output power supplies to use the components. See "Power Supplies."
Alert! Redundant memory disabled! Memory configuration does not support redundant memory.	Memory Mirroring was enabled in the system setup program, but the current configuration does not support redundant memory. A memory module may be faulty.	Check the memory modules for failure. See "Troubleshooting System Memory." Reset the memory setting, if appropriate. See "Using the System Setup Program and UEFI Boot Manager."
Alert! System fatal error during previous boot.	An error caused the system to reboot.	Check other system messages for additional information for possible causes.
BIOS MANUFACTURING MODE detected. MANUFACTURING MODE will be cleared before the next boot. System reboot required for normal operation.	System is in manufacturing mode.	Reboot to take the system out of manufacturing mode.

Table 1-2. System Messages (continued)

Message	Causes	Corrective Actions
BIOS Update Attempt Failed!	Remote BIOS update attempt failed.	Retry the BIOS update. If the problem persists, see "Getting Help."
Caution! NVRAM_CLR jumper is installed on system board	NVRAM_CLR jumper is installed in the clear setting. CMOS has been cleared.	Move the NVRAM_CLR jumper to the default position (pins 3 and 5). See "System Board Connectors" for jumper location. After restoring the jumper, update the desired settings in the BIOS System Setup program. See "Using the System Setup Program and UEFI Boot Manager."
CPU set to minimum frequency.	The processor speed may be intentionally set lower for power conservation.	If not an intentional setting, check any other system messages for possible causes.
CPU x installed with no memory.	Memory modules are required but not installed in the indicated processor's memory slots.	Install memory modules for the processor. See "System Memory."

Table 1-2. System Messages (continued)

Message	Causes	Corrective Actions
CPUs with different cache sizes detected. CPUs with different core sizes detected! System halted CPUs with different logical processors detected! System halted CPUs with different power rating detected! System halted	Mismatched processors are installed.	Ensure that all processors have the same cache size, number of cores and logical processors, and power ratings, and that they are properly installed. See "Processors."
Current boot mode is set to UEFI. Please ensure compatible bootable media is available. Use the system setup program to change the boot media as needed.	The boot option selected in the UEFI Boot Manager is not installed in the system.	Ensure that the boot option specified in the UEFI Boot Manager is installed in the system. See "Using the System Setup Program and UEFI Boot Manager."
Decreasing available memory	Faulty or improperly installed memory modules.	Reseat the memory modules. See "Troubleshooting System Memory."
DIMM configuration on each CPU should match.	Invalid memory configuration on a dual-processor system. The DIMM configuration for each processor must be identical.	Ensure that the memory modules are installed in a valid configuration. See "System Memory."

Table 1-2. System Messages (continued)

Message	Causes	Corrective Actions
Embedded NICx and NICy: OS NIC=DISABLED, Management Shared NIC=DISABLED	The OS NIC interface is disabled in BIOS. The Management Shared NIC interface is disabled in management tools.	Check the system management software or the System Setup program for NIC settings. If a problem is indicated, see "Troubleshooting a NIC."
Embedded NICx and NICy: OS NIC=DISABLED, Management Shared NIC=ENABLED	The OS NIC interface is disabled in BIOS. The Management Shared NIC interface is enabled in management tools.	Check the system management software or the System Setup program for NIC settings. If a problem is indicated, see "Troubleshooting a NIC."
Error 8602 - Auxiliary Device Failure. Verify that mouse and keyboard are securely attached to correct connectors.	Mouse or keyboard cable is loose or improperly connected. Defective mouse or keyboard.	Reseat the mouse or keyboard cable. Ensure that the mouse or keyboard is operational. See "Troubleshooting a USB Device."
Gate A20 failure	Faulty keyboard controller; faulty system board.	See "Getting Help."
General failure	The operating system is unable to carry out the command.	This message is usually followed by specific information. Note the information, and take the appropriate action to resolve the problem.
Invalid configuration information - please run SETUP program.	An invalid system configuration caused a system halt.	Run the System Setup program and review the current settings. See "Using the System Setup Program and UEFI Boot Manager."

Table 1-2. System Messages (continued)

Message	Causes	Corrective Actions
Invalid PCIe card found in the Internal_Storage slot!	The system halted because an invalid PCIe expansion card is installed in the dedicated storage controller slot.	Remove the PCIe expansion card and install the integrated storage controller in the dedicated slot. See "Integrated Storage Controller Card."
Keyboard controller failure	Faulty keyboard controller; faulty system board	See "Getting Help."
Keyboard data line failure Keyboard stuck key failure	Keyboard cable connector is improperly connected or the keyboard is defective.	Reseat the keyboard cable. If the problem persists, see "Troubleshooting a USB Device."
Keyboard fuse has failed	Overcurrent detected at the keyboard connector.	See "Getting Help."
Local keyboard may not work because all user accessible USB ports are disabled. If operating locally, power cycle the system and enter system program to change settings.	All USB ports are disabled, preventing keyboard access.	Run the System Setup program and enable one or more USB ports. See "Using the System Setup Program and UEFI Boot Manager."
Manufacturing mode detected	System is in manufacturing mode.	Reboot to take the system out of manufacturing mode.
Maximum rank count exceeded. The following DIMM has been disabled: x	Invalid memory configuration. The system will run but with the specified DIMM disabled.	Ensure that the memory modules are installed in a valid configuration. See "System Memory."

Table 1-2. System Messages (continued)

Message	Causes	Corrective Actions
Memory address line failure at <i>address</i> , read <i>value</i> expecting <i>value</i>	Faulty or improperly installed memory modules.	See "Troubleshooting System Memory."
Memory double word logic failure at <i>address</i> , read <i>value</i> expecting <i>value</i>	Faulty or improperly installed memory modules.	See "Troubleshooting System Memory."
Memory Initialization Warning: Memory size may be reduced	Invalid memory configuration. The system will run but with less memory than is physically available.	Ensure that the memory modules are installed in a valid configuration. See "System Memory."
Memory odd/even logic failure at <i>address</i> , read <i>value</i> expecting <i>value</i>	Faulty or improperly installed memory modules.	See "Troubleshooting System Memory."
Memory set to minimum frequency.	The memory frequency may be intentionally set lower for power conservation. The current memory configuration may support only the minimum frequency.	If not an intentional setting, check any other system messages for possible causes. Ensure that your memory configuration supports the higher frequency. See "System Memory."
Memory tests terminated by keystroke.	POST memory test was terminated by pressing the spacebar.	Information only.
MEMTEST lane failure detected on <i>x</i>	Invalid memory configuration. A mismatched DIMM is installed.	Ensure that the memory modules are installed in a valid configuration. See "System Memory."

Table 1-2. System Messages (continued)

Message	Causes	Corrective Actions
Mirror mode disabled. For mirror mode, DIMMs must be installed in pairs. Pairs must be matched in size and geometry.	The memory configuration does not match the setting in BIOS. The BIOS setting has been disabled.	Reconfigure the memory modules for Memory Mirroring mode. See "System Memory."
No boot device available	Faulty or missing optical drive subsystem, hard drive, or hard-drive subsystem, or no bootable USB key installed.	Use a bootable USB key, CD, or hard drive. If the problem persists, see "Troubleshooting an Internal SD Card," and "Troubleshooting Hard Drives," "Troubleshooting an Optical Drive," and "Troubleshooting a USB Device." See "Using the System Setup Program and UEFI Boot Manager" for information on setting the order of boot devices.
No boot sector on hard drive	Incorrect configuration settings in System Setup program, or no operating system on hard drive.	Check the hard-drive configuration settings in the System Setup program. See "Using the System Setup Program and UEFI Boot Manager." If necessary, install the operating system on your hard drive. See your operating system documentation.
No timer tick interrupt	Faulty system board.	See "Getting Help."

Table 1-2. System Messages (continued)

Message	Causes	Corrective Actions
PCI BIOS failed to install	PCIe device BIOS (Option ROM) checksum failure detected during shadowing. Cables to expansion card(s) loose; faulty or improperly installed expansion card(s).	Reseat the expansion card(s). Ensure that all appropriate cables are securely connected to the expansion card(s). If the problem persists, see "Troubleshooting Expansion Cards."
PCIe Training Error: Expected Link Width is x, Actual Link Width is y.	Faulty or improperly installed PCIe card in the specified slot.	Reseat the PCIe card in the specified slot number. See "Troubleshooting Expansion Cards." If the problem persists, see "Getting Help."
Plug & Play Configuration Error	Error encountered in initializing PCIe device; faulty system board.	Install the NVRAM_CLR jumper in the clear position (pins 1 and 3) and reboot the system. See "System Board Connectors" for jumper location. If the problem persists, see "Troubleshooting Expansion Cards."
Quad rank DIMM detected after single rank or dual rank DIMM in socket.	Invalid memory configuration.	Ensure that the memory modules are installed in a valid configuration. See "System Memory."

Table 1-2. System Messages (continued)

Message	Causes	Corrective Actions
Read fault Requested sector not found	Faulty USB device, USB medium, optical drive assembly, hard drive, or hard-drive subsystem.	Replace the USB medium or device. Ensure that the USB, backplane, or SATA cables are properly connected. See "Troubleshooting a USB Device" or "Troubleshooting Hard Drives" for the appropriate drive(s) installed in your system. See "Troubleshooting a USB Device," "Troubleshooting an Internal SD Card," and "Troubleshooting Hard Drives."
SATA port x device not found	There is no device connected to the specified SATA port.	Information only.
SATA port x device auto- sensing error	The drive connected to the specified SATA port is faulty.	Replace the faulty drive.
SATA port x device configuration error		
SATA port x device error		
Sector not found Seek error Seek operation failed	Faulty hard drive, USB device, or. USB medium.	Replace the USB medium or device. Ensure that the USB or SAS backplane cables are properly connected. See "Troubleshooting a USB Device" or "Troubleshooting Hard Drives" for the appropriate drive(s) installed in your system.

Table 1-2. System Messages (continued)

Message	Causes	Corrective Actions
Shutdown failure	General system error.	Run the online diagnostic tests. See "Running the System Diagnostics."
The amount of system memory has changed	Memory has been added or removed or a memory module may be faulty.	If memory has been added or removed, this message is informative and can be ignored. If memory has not been added or removed, check the SEL to determine if single-bit or multi-bit errors were detected and replace the faulty memory module. See "Troubleshooting System Memory."

Table 1-2. System Messages (continued)

Message	Causes	Corrective Actions
The following DIMMs should match in geometry: x, x, ...	Invalid memory configuration. The specified DIMMs do not match in size, number of ranks, or number of data lanes.	Ensure that the memory modules are installed in a valid configuration. See "System Memory."
The following DIMMs should match in rank count: x, x, ...		
The following DIMMs should match in size: x, x, ...		
The following DIMMs should match in size and geometry: x, x, ...		
The following DIMMs should match in size and rank count: x, x, ...		
Thermal sensor not detected on x	Invalid memory configuration. A mismatched DIMM is installed.	Ensure that the memory modules are installed in a valid configuration. See "System Memory."
Time-of-day clock stopped	Faulty battery or faulty chip.	See "Troubleshooting the System Battery."
Time-of-day not set - please run SETUP program	Incorrect Time or Date settings; faulty system battery.	Check the Time and Date settings. See "Using the System Setup Program and UEFI Boot Manager." If the problem persists, replace the system battery. See "System Battery."

Table 1-2. System Messages (continued)

Message	Causes	Corrective Actions
Timer chip counter 2 failed	Faulty system board.	See "Getting Help."
TPM configuration operation honored. System will now reset.	A TPM configuration command has been entered. The system will reboot and execute the command.	Information only.
TPM configuration operation is pending. Press (I) to Ignore OR (M) to Modify to allow this change and reset the system. WARNING: Modifying could prevent security.	This message displays during system restart after a TPM configuration command has been entered. User interaction is required to proceed.	Enter I or M to proceed.
TPM failure	A Trusted Platform Module (TPM) function has failed.	See "Getting Help."
Unable to launch System Services image. System halted!	System halted after <F10> keystroke because System Services image is either corrupted in the system firmware, or the system firmware has been lost due to system board replacement.	Restart the system and update the Unified Server Configurator repository to the latest software to restore full functionality. See the Unified Server Configuration user documentation or more information.

Table 1-2. System Messages (continued)

Message	Causes	Corrective Actions
	The iDRAC6 Enterprise card flash memory may be corrupted.	Restore the flash memory using the latest version on support.dell.com . See the iDRAC6 user's guide for instructions on performing a field replacement of the flash memory.
Unexpected interrupt in protected mode	Improperly seated memory modules or faulty keyboard/mouse controller chip.	Reseat the memory modules. See "Troubleshooting System Memory." If the problem persists, see "Getting Help."
Unsupported CPU combination Unsupported CPU stepping detected	Processor(s) is not supported by the system.	Install a supported processor or processor combination. See "Processors."
Unsupported DIMM detected. The following DIMM has been disabled: x	Invalid memory configuration. The system will run but with the specified DIMM disabled.	Ensure that the memory modules are installed in a valid configuration. See "System Memory."
Unsupported memory configuration. DIMM mismatch across slots detected: x, x, . . .	Invalid memory configuration. DIMMs are mismatched in the specified slots.	Ensure that the memory modules are installed in a valid configuration. See "System Memory."
Unused memory detected. DIMMs installed in the following slot are not available when in mirror or 128-bit advanced ECC modes: x, x, x	The memory configuration is not optimal for mirroring or Advanced ECC Memory Mode. Modules in the specified slots are unused.	Reconfigure the memory for Memory Mirroring or Advanced ECC Memory Mode, or change the memory mode to Optimized in the BIOS setup screen. See "System Memory."

Table 1-2. System Messages (continued)

Message	Causes	Corrective Actions
Warning: A fatal error has caused system reset! Please check the system event log!	A fatal system error occurred and caused the system to reboot.	Check the SEL for information that was logged during the error. See the applicable troubleshooting section in "Troubleshooting Your System" for any faulty components specified in the SEL.
Warning! Control panel is not installed	The control panel is not installed, or has a faulty cable connection.	Install the control panel, or check the cable connections between the display module, the control panel board, and the system board. See "Installing the Control Panel Display Module."
Warning! No micro code update loaded for processor <i>n</i>	Micro code update failed.	Update the BIOS firmware. See "Getting Help."
Warning! Power required exceeds PSU wattage. Check PSU and system configuration. Warning! Performance degraded. CPU and memory set to minimum frequencies to meet PSU wattage. System will reboot.	The system configuration of processor(s), memory modules, and expansion cards may not be supported by the power supplies.	If any system components were just upgraded, return the system to the previous configuration. If the system boots without this warning, then the replaced component(s) are not supported with this power supply. If Energy Smart power supplies are installed, replace them with the High Output power supplies to use the components. See "Power Supplies."

Table 1-2. System Messages (continued)

Message	Causes	Corrective Actions
Warning! PSU mismatch. PSU redundancy lost. Check PSU.	A High Output power supply and an Energy Smart power supply are installed in the system at the same time.	Install two High Output or two Energy Smart power supplies in the system. You can also run the system on one power supply until you can obtain two power supplies of the same type. See "Troubleshooting Power Supplies."
Warning! Unsupported memory configuration detected. The memory configuration is not optimal. The recommended memory configuration is: <message>	Invalid memory configuration. The system will run but with reduced functionality.	Ensure that the memory modules are installed in a valid configuration. See "System Memory." If the problem persists, see "Troubleshooting System Memory."
Write fault Write fault on selected drive	Faulty USB device, USB medium, optical drive assembly, hard drive, or hard-drive subsystem.	Replace the USB medium or USB device. See "Troubleshooting a USB Device," "Troubleshooting an Internal SD Card," "Troubleshooting an Optical Drive," or "Troubleshooting Hard Drives."

NOTE: For the full name of an abbreviation or acronym used in this table, see the "Glossary."

Warning Messages

A warning message alerts you to a possible problem and prompts you to respond before the system continues a task. For example, before you format a diskette, a message will warn you that you may lose all data on the diskette. Warning messages usually interrupt the task and require you to respond by typing **y** (yes) or **n** (no).

 **NOTE:** Warning messages are generated by either the application or the operating system. For more information, see the documentation that accompanied the operating system or application.

Diagnostics Messages

The system diagnostic utilities may issue messages if you run diagnostic tests on your system. See "Running the System Diagnostics" for more information about system diagnostics.

Alert Messages

Systems management software generates alert messages for your system. Alert messages include information, status, warning, and failure messages for drive, temperature, fan, and power conditions. For more information, see the systems management software documentation.

Other Information You May Need



WARNING: See the safety and regulatory information that shipped with your system. Warranty information may be included within this document or as a separate document.

- The rack documentation included with your rack solution describes how to install your system into a rack.
- The *Getting Started Guide* provides an overview of system features, setting up your system, and technical specifications.
- Any media that ships with your system that provides documentation and tools for configuring and managing your system, including those pertaining to the operating system, system management software, system updates, and system components that you purchased with your system.



NOTE: Always check for updates on support.dell.com and read the updates first because they often supersede information in other documents.

Using the System Setup Program and UEFI Boot Manager

The System Setup program is the BIOS program that enables you to manage your system hardware and specify BIOS-level options. From the System Setup program, you can:

- Change the NVRAM settings after you add or remove hardware
- View the system hardware configuration
- Enable or disable integrated devices
- Set performance and power management thresholds
- Manage system security

Choosing the System Boot Mode

The System Setup program also enables you to specify the boot mode for installing your operating system:

- BIOS boot mode (the default) is the standard BIOS-level boot interface.
- UEFI boot mode is an enhanced 64-bit boot interface based on Unified Extensible Firmware Interface (UEFI) specifications that overlays the system BIOS. See "Entering the UEFI Boot Manager" for more information on this interface.

You select the boot mode in the **Boot Mode** field of the Boot Settings screen of the System Setup program. See "Boot Settings Screen." Once you specify the boot mode, the system boots in that mode and you proceed then to install your operating system from that mode. Thereafter, you must boot the system to the same boot mode (BIOS or UEFI) to access the installed operating system. Trying to boot the operating system from the other boot mode will cause the system to halt immediately at startup.



NOTE: Operating systems must be UEFI-compatible (for example, Microsoft® Windows Server® 2008 x64 version) to be installed from the UEFI boot mode. DOS and 32-bit operating systems do not support UEFI and can only be installed from the BIOS boot mode.

Entering the System Setup Program

- 1 Turn on or restart your system.
- 2 Press <F2> after you see the following message:
<F2> = System Setup

 **NOTE:** The system will not respond until the USB keyboard is active.

If your operating system begins to load before you press <F2>, allow the system to finish booting, and then restart your system and try again.

Responding to Error Messages

If an error message appears while the system is booting, make a note of the message. See "System Messages" for an explanation of the message and suggestions for correcting errors.

 **NOTE:** After installing a memory upgrade, it is normal for your system to display a message that the system memory size has changed the first time you start your system.

Using the System Setup Program Navigation Keys

Keys	Action
Up arrow or <Shift><Tab>	Moves to the previous field.
Down arrow or <Tab>	Moves to the next field.
Spacebar, <+>, <->, left and right arrows	Cycles through the settings in a field. In many fields, you can also type the appropriate value.
<Esc>	Exits the System Setup program and restarts the system if any changes were made.
<F1>	Displays the System Setup program's help file.

 **NOTE:** For most of the options, any changes that you make are recorded but do not take effect until you restart the system.

System Setup Options

Main Screen

Figure 2-1. Main System Setup Program Screen

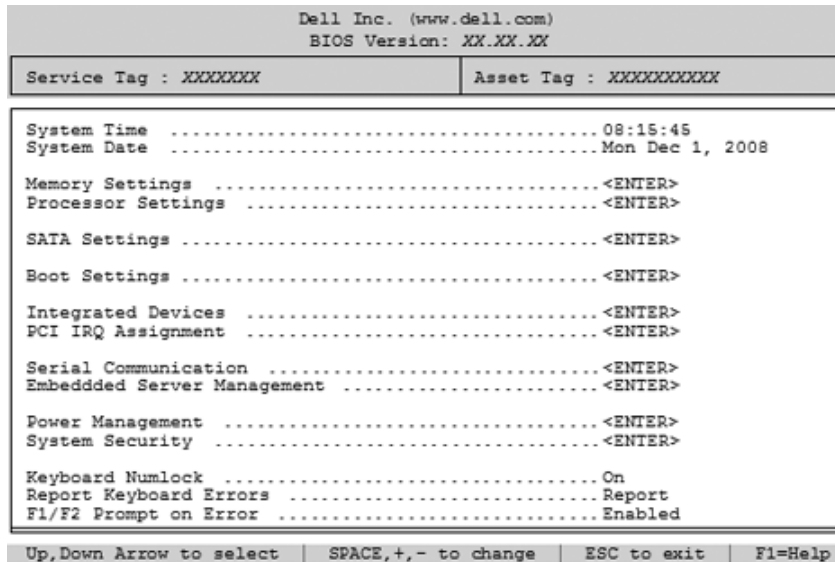

 **NOTE:** The options for the System Setup program change based on the system configuration.

 **NOTE:** The System Setup program defaults are listed under their respective options in the following sections, where applicable.

Option	Description
System Time	Sets the time on the system's internal clock.
System Date	Sets the date on the system's internal calendar.
Memory Settings	Displays information related to installed memory. See "Memory Settings Screen."
Processor Settings	Displays information related to microprocessors (speed, cache size, and so on). See "Processor Settings Screen."
SATA Settings	See "SATA Settings Screen."
Boot Settings	See "Boot Settings Screen."
Integrated Devices	See "Integrated Devices Screen."

Option	Description
PCI IRQ Assignment	Displays a screen to change the IRQ assigned to each of the integrated devices on the PCI bus, and any installed expansion card that requires an IRQ.
Serial Communication (Off default)	See "Serial Communication Screen."
Embedded Server Management	See "Embedded Server Management Screen."
Power Management	See "Power Management Screen."
System Security	Displays a screen to configure the system password and setup password features. See "System Security Screen," "Using the System Password," and "Using the Setup Password" for more information.
Keyboard NumLock (On default)	Determines whether your system starts up with the NumLock mode activated on 101- or 102-key keyboards (does not apply to 84-key keyboards).
Report Keyboard Errors (Report default)	Enables or disables reporting of keyboard errors during the POST. Select Report for host systems that have keyboards attached. Select Do Not Report to suppress all error messages relating to the keyboard or keyboard controller during POST. This setting does not affect the operation of the keyboard itself if a keyboard is attached to the system.
F1/F2 Prompt on Error (Enabled default)	Enables the system to halt on errors during POST, which allows the user to observe events that may scroll by unnoticed during normal POST. You can select F1 to continue or F2 to enter the System Setup program.
	 CAUTION: When setting this option to Disabled, the system will not halt if an error occurs during POST. Any critical errors will be displayed and logged in the system event log.

Memory Settings Screen

Option	Description
System Memory Size	Displays the amount of system memory.
System Memory Type	Displays the type of system memory.
System Memory Speed	Displays the system memory speed.
Video Memory	Displays the amount of video memory.
System Memory Testing (Enabled default)	Specifies whether system memory tests are run at system boot. Options are Enabled and Disabled .
Memory Operating Mode	This field displays the type of memory operation if a valid memory configuration is installed. When set to Optimizer Mode , the memory controllers run independently of each other for improved memory performance. When set to Mirror Mode , memory mirroring is enabled. When set to Advanced ECC Mode , two controllers are joined in 128-bit mode running multi-bit advanced ECC. For information about the memory modes, see "System Memory."
Node Interleaving (Disabled default)	If this field is Enabled , memory interleaving is supported if a symmetric memory configuration is installed. If Disabled , the system supports Non-Uniform Memory architecture (NUMA) (asymmetric) memory configurations.

Processor Settings Screen

Option	Description
64-bit	Specifies if the processor(s) support 64-bit extensions.
Core Speed	Displays the processor clock speed.
Bus Speed	Displays the processor bus speed.
Logical Processor (Enabled default)	On processors that support Simultaneous Multi-Threading (SMT) technology, each processor core supports up to two logical processors. If this field is set to Enabled , the BIOS reports both logical processors. If set to Disabled , only one logical processor is monitored by the BIOS.

Option	Description
Virtualization Technology (Disabled default)	NOTE: Disable this feature if your system will not be running virtualization software. Enabled permits virtualization software to use the virtualization technology incorporated in the processor.
Execute Disable (Enabled default)	Enables or disables Execute Disable Memory Protection Technology .
Number of Cores per Processor (All default)	If set to All , the maximum number of cores in each processor is enabled.
Turbo Mode	If Turbo Boost Technology is supported by the processor(s), enables or disables Turbo Mode .
C States (Enabled default)	When set to Enabled , the processor(s) can operate in all available power states.
Processor X ID	Displays the family, model, Level 3 cache size, Level 2 cache size, and number of cores of each processor.

SATA Settings Screen

Option	Description
Embedded SATA (ATA Mode default)	ATA Mode enables the integrated SATA controller. Off disables the controller.
Port A (Auto default)	Auto enables BIOS support for the device attached to SATA port A. Off disables BIOS support for the device.

Boot Settings Screen

Option	Description
Boot Mode (BIOS default)	 CAUTION: Switching the boot mode could prevent the system from booting if the operating system was not installed in the same boot mode. If the system operating system supports Unified Extensible Firmware Interface, you can set this option to UEFI. Setting this field to BIOS allows compatibility with non-UEFI operating systems. NOTE: Setting this field to UEFI disables the Boot Sequence, Hard-Disk Drive Sequence, and USB Flash Drive Emulation Type fields.
Boot Sequence	If Boot Mode is set to BIOS , this field tells the system where the operating system files needed for startup are located. If Boot Mode is set to UEFI , you can access the UEFI boot manager utility by rebooting the system and pressing F11 when prompted to do so.
Hard-Disk Drive Sequence	Determines the order in which the BIOS will attempt to boot from hard drives in the system during system startup.
USB Flash Drive Emulation Type (Auto default)	Determines the emulation type for a USB flash drive. Hard disk allows the USB flash drive to act as a hard drive. Floppy allows the USB flash drive to act as a removable diskette drive. Auto automatically chooses an emulation type. Auto automatically chooses the appropriate emulation type for the device, except for devices installed in the Internal SD Card slot. A device installed in the Internal SD Card slot will automatically emulate a hard drive. If you install a device in this slot that is configured as a removable diskette drive, you must manually set the emulation type to Floppy .
Boot Sequence Retry (Disabled default)	If this field is enabled and the system has failed to boot, the system will reattempt to boot after 30 seconds.

Integrated Devices Screen

Option	Description
Integrated SAS/RAID Controller (Enabled default)	Enables or disables the integrated storage controller.
User Accessible USB Ports (All Ports On default)	Enables or disables the user-accessible USB ports. Options are All Ports On , Only Back Ports On , and All Ports Off .
Internal USB Port (On default)	Enables or disables the internal USB port.
Internal SD Card Port	Enables or disables the internal SD card port.
Embedded NIC1 and NIC2 Embedded NIC3 and NIC4	Enables or disables the OS interface of the four embedded NICs. (The NICs may also be accessed through the system's management controller.)
Embedded Gb NICx (NIC1 default: Enabled with PXE ; Other NICs: Enabled)	Enables or disables the embedded NICs. Options are Enabled , Enabled with PXE , Enabled with iSCSI Boot , and Disabled . PXE support allows the system to boot from the network.
MAC Address	Displays the MAC address for the NIC.
Capability Detected	Displays the features of the NIC hardware key, if installed. NOTE: Some NIC features may require the installation of an additional driver.
OS Watchdog Timer (Disabled default)	Sets a timer to monitor the operating system for activity, and aids in recovery if the system stops responding. When Enabled , the operating system is allowed to initialize the timer. When Disabled , the timer is not initialized. NOTE: This feature is usable only with operating systems that support WDAT implementations of the Advanced Configuration and Power Interface (ACPI) 3.0b specification.
I/OAT DMA Engine (Disabled default)	When supported, this option enables or disables the I/O Acceleration Technology feature.

Option	Description
Embedded Video Controller (Enabled default)	Enables or disables BIOS support for the integrated video controller. NOTE: Integrated video can only be disabled if a video expansion card is installed. If set to Disabled , virtual KVM and other remote access features will not function.

PCI IRQ Assignments Screen

Option	Description
<PCIe device>	Use the <+> and <-> keys to manually select an IRQ for a given device, or select Default to allow the BIOS to select an IRQ value at system startup.

Serial Communication Screen

Option	Description
Serial Communication (On without Console Redirection default)	Selects whether the serial communication devices (Serial Device 1 and Serial Device 2) are enabled in BIOS. BIOS console redirection can also be enabled and the port address used can be specified. Options are On without Console Redirection , On with Console Redirection via COM1 , On with Console Redirection via COM2 , and Off .
Serial Port Address (Serial Device 1=COM1, Serial Device2=COM2 default)	Sets the serial port addresses for the two serial devices. NOTE: Only Serial Device 2 can be used for Serial Over LAN (SOL). To use console redirection by SOL, configure the same port address for console redirection and the serial device.
External Serial Connector	Specifies whether Serial Device 1 , Serial Device 2 , or Remote Access Device has access to the external serial connector. NOTE: Only Serial Device 2 can be used for Serial Over LAN (SOL). To use console redirection by SOL, configure the same port address for console redirection and the serial device.

Option	Description
Failsafe Baud Rate (115200 default)	Displays the failsafe baud rate used for console redirection. BIOS attempts to determine the baud rate automatically. This failsafe baud rate is used only if the attempt fails. This rate should not be adjusted.
Remote Terminal Type (VT100/VT220 default)	Sets the remote console terminal type, either VT100/VT220 or ANSI.
Redirection After Boot (Enabled default)	Enables or disables BIOS console redirection when the operating system is loaded.

Embedded Server Management Screen

Option	Description
Front Panel LCD Options	Options are User Defined String , Model Number , or None . If the LCD Home display is set to anything other than User Defined String , Model Number , or None , this option in BIOS will display Advanced . You will not be able to edit this setting in BIOS until it is set back to User Defined String , Model Number , or None through another LCD configuration utility (such as the iDRAC6 Configuration Utility or LCD panel menu).
User-Defined LCD String	You can enter a name or other identifier for the system, to be displayed on the LCD module screen.



Power Management Screen

Option	Description
Power Management	Options are OS Control , Active Power Controller , Custom , or Maximum Performance . If you select OS Control , Active Power Controller , or Maximum Performance , the BIOS preconfigures the remaining options on this screen. If you select Custom , you can configure each option independently.

Option	Description
CPU Power and Performance Management	<p>Options are OS Control, Active Power Controller, Custom, or Maximum Performance. For all but the Custom setting, the BIOS pre-configures the power settings on this screen as follows:</p> <p>OS Control sets the CPU power to OS DBPM, the fan power to Minimum Power, and the memory power to Maximum Performance. In this setting, all processor performance information is passed from the system BIOS to the operating system for control. The operating system sets the processor performance based on processor utilization.</p> <p>Active Power Controller sets the CPU power to System DBPM, the fan power to Minimum Power, and the memory power to Maximum Performance. In this setting, processor performance is controlled by the system BIOS.</p> <p>Maximum Performance sets all fields to Maximum Performance.</p> <p>If you select Custom, you can configure each option independently.</p>
Fan Power and Performance Management	Options are Maximum Performance or Minimum Power .
Memory Power and Performance Management	Options are Maximum Performance , a specified frequency, or Minimum Power .

System Security Screen

Option	Description
System Password	<p>Displays the current status of the password security feature and allows a new system password assignment and verification.</p> <p>NOTE: See "Using the System Password" for more information.</p>
Setup Password	<p>Restricts access to the System Setup program by using a setup password.</p> <p>NOTE: See "Using the System Password" for more information.</p>
Password Status (Unlocked default)	<p>When Setup Password is assigned and this field is Locked, the system password cannot be changed or disabled at system start-up.</p> <p>See "Using the System Password" for more information.</p>
TPM Security (Off default)	<p>Sets the reporting of the Trusted Platform Module (TPM) in the system.</p> <p>If Off, the presence of the TPM is not reported to the operating system.</p> <p>If On with Pre-boot Measurements, the system reports the TPM to the operating system and stores the pre-boot measurements to the TPM during POST.</p> <p>If On without Pre-boot Measurements, the system reports the TPM to the operating system and bypasses pre-boot measurements.</p>
TPM Activation (No Change default)	<p>When set to Activate, the TPM is enabled to default settings. When set to Deactivate, the TPM is disabled. The No Change state initiates no action. The operational state of the TPM remains unchanged (all user settings for the TPM are preserved).</p> <p>NOTE: This field is read-only when TPM Security is set to Off.</p>

Option	Description
TPM Clear (No default)	<p> CAUTION: Clearing the TPM will lose all encryption keys in the TPM. This option prevents booting to the operating system and results in data loss if the encryption keys cannot be restored. Back up the TPM keys prior to enabling this option.</p> <p>When set to Yes, all TPM contents are cleared.</p> <p>NOTE: This field is read-only when TPM Security is set to Off.</p>
Power Button (Enabled default)	<p>If Enabled, the power button can turn the system's power off and on. On an ACPI-compliant operating system, the system performs an orderly shutdown before power is turned off.</p> <p>When Disabled, the button can only turn on system power.</p>
NMI Button (Disabled default)	<p> CAUTION: Clearing the TPM will lose all encryption keys in the TPM. This option prevents booting to the operating system and results in data loss if the encryption keys cannot be restored. Back up the TPM keys prior to enabling this option.</p> <p>Enables or disables the NMI feature.</p>
AC Power Recovery (Last default)	<p>Determines how the system reacts when power is restored. If set to Last, the system returns to the last power state. On turns on the system after power is restored. Off allows the system to remain off after power is restored.</p>
AC Power Recovery Delay	<p>Determines when the system restarts after power is restored. Options are Immediate, Random (between 30 to 240 seconds), or a user-defined value of 30 to 240 seconds.</p>

Exit Screen

Press <Esc> to exit the System Setup program; the **Exit** screen displays:

- Save Changes and Exit
- Discard Changes and Exit
- Return to Setup

Entering the UEFI Boot Manager

 **NOTE:** Operating systems must be 64-bit UEFI-compatible (for example, Microsoft® Windows Server® 2008 x64 version) to be installed from the UEFI boot mode. DOS and 32-bit operating systems can only be installed from the BIOS boot mode.

 **NOTE:** The Boot Mode must be set to UEFI in the System Setup program to access the UEFI Boot Manager.

The UEFI Boot Manager enables you to:

- Add, delete, and arrange boot options
- Access the System Setup program and BIOS-level boot options without rebooting

1 Turn on or restart your system.

2 Press <F11> after you see the following message:

<F11> = UEFI Boot Manager

 **NOTE:** The system will not respond until the USB keyboard is active.

If your operating system begins to load before you press <F11>, allow the system to finish booting, and then restart your system and try again.

Using the UEFI Boot Manager Navigation Keys

Keys	Action
Up arrow	Moves to and highlights the previous field.
Down arrow	Moves to and highlights the next field.
Spacebar, <Enter>, <+>, <->	Cycles through the settings in a field.
<Esc>	Refreshes the UEFI Boot Manager screen (page one) or returns to the previous screen.
<F1>	Displays the UEFI Boot Manager help file.

UEFI Boot Manager Screen

Option	Description
Continue	The system attempts to boot to devices starting with the first item in the boot order. If the boot attempt fails, the system will continue with the next item in the boot order until the boot is successful or no more boot options are found.
<Boot options>	Displays the list of available boot options (marked with asterisks). Select the boot option you wish to use and press <Enter>. NOTE: If you hot-swap a boot device, press <ESC> to refresh the list of boot options.
UEFI Boot Settings	Enables you to add, delete, enable, or disable boot options; change boot order; or execute a one-time boot option.
System Utilities	Enables you to access the System Setup program, System Services, and BIOS-level boot options.

UEFI Boot Settings Screen

Option	Description
Add Boot Option	Adds a new boot option.
Delete Boot Option	Deletes an existing boot option.
Enable/Disable Boot Option	Disables and enables an option in the boot option list.
Change Boot Order	Changes the order of the boot option list.
One-Time Boot from File	Sets a one-time boot option not included in the boot option list.

System Utilities Screen

Option	Description
System Setup	Accesses the System Setup program without rebooting.
System Services	Restarts the system and accesses the Unified Server Configurator, which enables you to run utilities such as system diagnostics.
BIOS Boot Manager	Accesses the BIOS-level boot options list without rebooting. This option enables you to conveniently switch to BIOS boot mode if you need to boot to a device with a non-UEFI operating system, such as a bootable DOS media with diagnostics software.
Reboot System	Restarts the system.

System and Setup Password Features

 **NOTE:** For a forgotten password, see "Disabling a Forgotten Password."

Your system is shipped without the system password feature enabled in BIOS. The password features provide a basic level of security for the data on your system.

 **CAUTION:** Anyone can access the data stored on your system if the system is running and unattended.

Using the System Password

When a system password is assigned, the system prompts for the system password after the system starts and only those with the password have full use of the system.

Assigning a System Password

Before assigning a system password, enter the System Setup program and check the **System Password** option.

When a system password is assigned, **System Password** is **Enabled**. If **Password Status** is **Unlocked**, you can change the system password. If **Locked**, you cannot change the system password. Disabling the password jumper on the system board sets **System Password** to **Disabled**, and you cannot change or enter a new system password.

When a system password is not assigned and the password jumper on the system board is in the enabled position, **System Password** is **Not Enabled** and **Password Status** is **Unlocked**. To assign a system password:

- 1 Verify that **Password Status** is **Unlocked**.
- 2 Highlight the **System Password** option and press <Enter>.
- 3 Type your new system password.

You can use up to 32 characters in your password.

As you type, placeholders appear in the field.

The password assignment is not case-sensitive. To erase a character, press <Backspace> or the left-arrow key.

 **NOTE:** To escape from the field without assigning a system password, press <Enter> to move to another field, or press <Esc> prior to completing step 5.

- 4 Press <Enter>.
- 5 To confirm your password, type it a second time and press <Enter>.
System Password changes to **Enabled**. Exit the System Setup program and begin using your system.
- 6 Either reboot the system now for the password protection to take effect or continue working.

 **NOTE:** Password protection does not take effect until the system reboots.

Using Your System Password to Secure Your System

 **NOTE:** If you have assigned a setup password (see "Using the Setup Password" on page 74), the system accepts your setup password as an alternate system password.

When **Password Status** is **Unlocked**, you have the option to leave the password security enabled or to disable password security.

To leave the password security enabled:

- 1 Turn on or reboot your system by pressing <Ctrl> <Alt> .
- 2 Type your password and press <Enter>.

To disable the password security:

- 1 Turn on or reboot your system by pressing <Ctrl> <Alt> .
- 2 Type your password and press <Ctrl> <Enter>.

When **Password Status** is **Locked**, you must type the password and press <Enter> when prompted at reboot.

If an incorrect system password is entered, the system displays a message and prompts you to re-enter your password. You have three attempts to enter the correct password. After the third unsuccessful attempt, the system displays an error message that the system has halted and must be shut down manually using the power button.

Even after you shut down and restart the system, the error message continues to be displayed until the correct password is entered.



NOTE: You can use the **Password Status** option in conjunction with the **System Password** and **Setup Password** options to protect your system from unauthorized changes.

Disabling the System Password

If the system password is already set, you can disable it by typing the password during POST and pressing <Ctrl> <Enter> or you can enter the system setup and press <Enter> twice when you are in the system password menu.

Changing an Existing System Password

- 1** Enter the System Setup program by pressing <F2> during POST.
- 2** Select the **System Security** screen.
- 3** Verify that the **Password Status** is **Unlocked**.
- 4** Type the new system password in the two password fields.

The **System Password** field changes to **Not Enabled** if the password was deleted.

Using the Setup Password

Assigning a Setup Password

You can assign a setup password only when the **Setup Password** is **Not Enabled**. To assign a setup password, highlight the **Setup Password** option and press the <+> or <-> key. The system prompts you to enter and verify the password.

 **NOTE:** The setup password can be the same as the system password. If the two passwords are different, the setup password can be used as an alternate system password. The system password cannot be used in place of the setup password.

You can use up to 32 characters in your password.

As you type, placeholders appear in the field.

The password assignment is not case-sensitive. To erase a character, press <Backspace> or the left-arrow key.

When you verify the password, the **Setup Password** changes to **Enabled**. The next time you enter the System Setup program, the system prompts you for the setup password.

A change to the **Setup Password** option becomes effective immediately (restarting the system is not required).

Operating With a Setup Password Enabled

If **Setup Password** is **Enabled**, you must enter the correct setup password before modifying most of the System Setup options.

If you do not enter the correct password in three attempts, the system lets you view, but not modify, the System Setup screens. The following options are exceptions: If **System Password** is not **Enabled** and is not locked through the **Password Status** option, you can assign a system password. You cannot disable or change an existing system password.

 **NOTE:** You can use the **Password Status** option in conjunction with the **Setup Password** option to protect the system password from unauthorized changes.

Deleting or Changing an Existing Setup Password

- 1** Enter the System Setup program and select the **System Security**.
- 2** Highlight **Setup Password**, press <Enter> to access the setup password window. Press <Enter> twice to clear the existing setup password.

The setting changes to **Not Enabled**.

- 3** If you want to assign a new setup password, perform the steps in "Assigning a Setup Password."

iDRAC Configuration Utility

The iDRAC Configuration Utility is a pre-boot configuration environment that allows you to view and set parameters for the iDRAC6 and for the managed server. The iDRAC Configuration Utility enables you to:

- Configure, enable, or disable the iDRAC6 local area network (LAN) through the dedicated iDRAC6 Enterprise card port or the embedded NICs.
- Enable or disable IPMI over LAN.
- Enable a LAN Platform Event Trap (PET) destination.
- Attach or detach the Virtual Media devices.
- Change the administrative username and password and manage user privileges.
- View System Event Log (SEL) messages or clear messages from the log.

For additional information on using iDRAC6, see the documentation for iDRAC6 and systems management applications.

Entering the iDRAC Configuration Utility

- 1 Turn on or restart your system.
- 2 Press <Ctrl><E> when prompted during POST.

If your operating system begins to load before you press <Ctrl><E>, allow the system to finish booting, restart your system and try again.

Installing System Components

Recommended Tools

- Key to the system keylock
- #1 and #2 Phillips screwdrivers
- #8, #15 and #10 Torx screwdrivers
- Wrist grounding strap

Inside the System

 **CAUTION:** Many repairs may only be done by a certified service technician. You should only perform troubleshooting and simple repairs as authorized in your product documentation, or as directed by the online or telephone service and support team. Damage due to servicing that is not authorized by Dell is not covered by your warranty. Read and follow the safety instructions that came with the product.

Figure 3-1. Inside the System



- | | | | |
|----|------------------------|----|------------------------------------|
| 1 | power supply bays (2) | 2 | expansion-card riser (2) |
| 3 | iDRAC6 Enterprise card | 4 | integrated storage controller card |
| 5 | memory modules (12) | 6 | heat sink/processor (2) |
| 7 | SAS backplane | 8 | hard drives (6) |
| 9 | optical drive | 10 | RAID battery (PERC only) |
| 11 | Internal SD Module | 12 | fans (5 or 6) |

Removing and Replacing the Optional Front Bezel

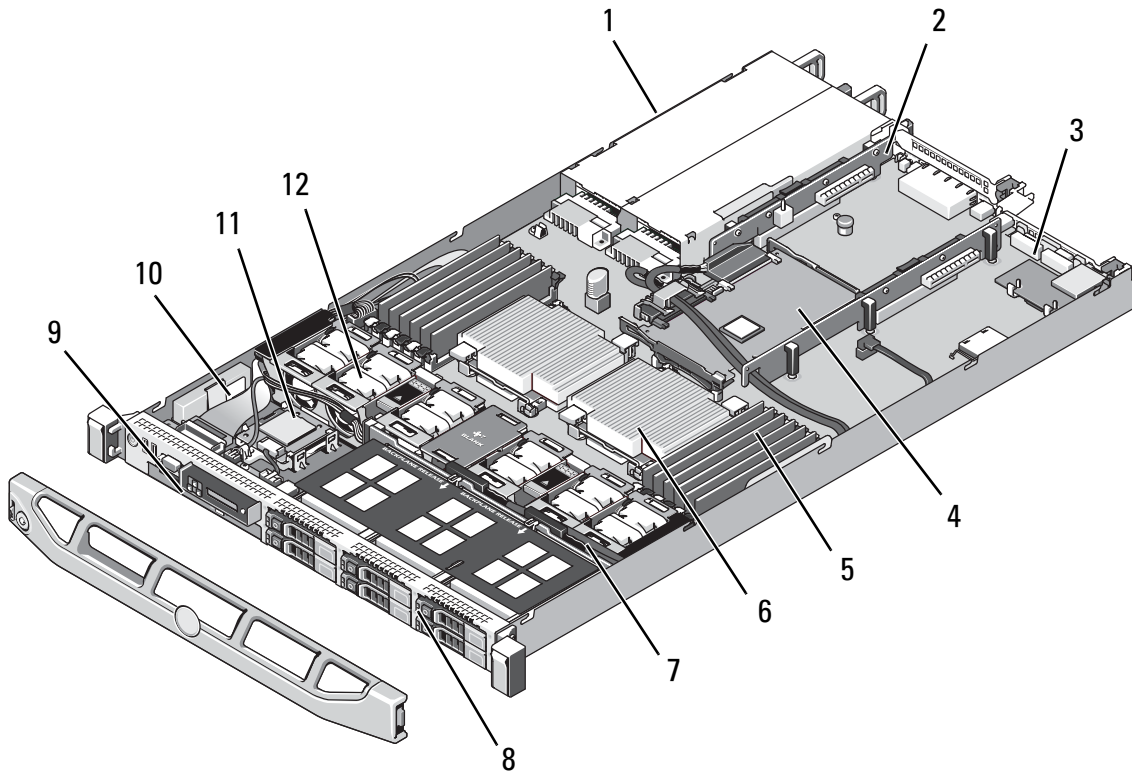
- 1 Unlock the keylock at the left end of the bezel.
- 2 Lift up on the release latch next to the key lock.
- 3 Rotate the left end of the bezel away from the front panel.
- 4 Unhook the right end of the bezel and pull the bezel away from the system.

Figure 3-2. Removing and Replacing the Optional Front Bezel

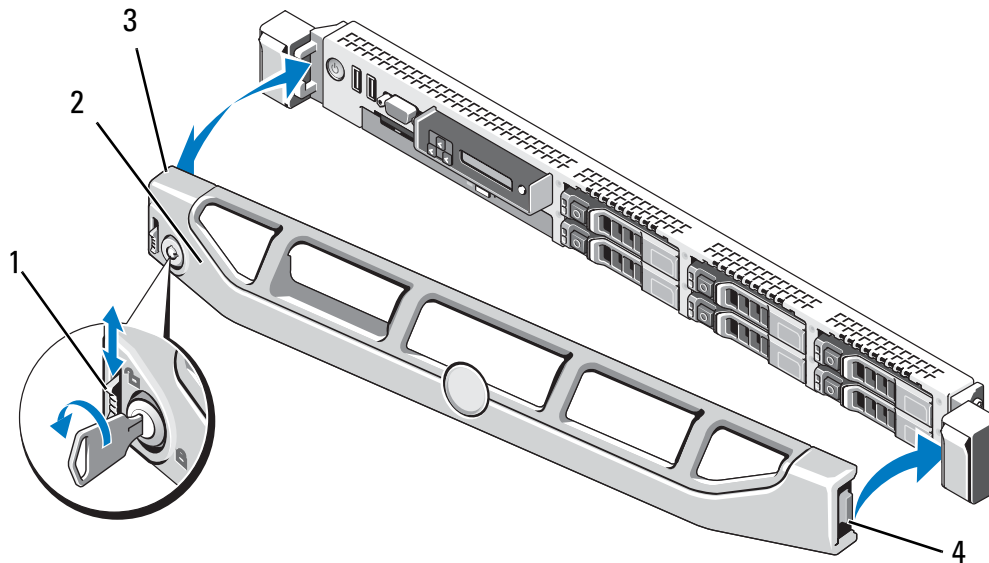

- | | | | |
|---|---------------|---|-----------|
| 1 | release latch | 2 | keylock |
| 3 | bezel | 4 | hinge tab |

To replace the optional bezel, hook the right end of the bezel onto the chassis, then fit the free end of the bezel onto the system. Secure the bezel with the keylock. See Figure 3-2.

Information Tag

The information tag is a slide-out label panel for system information including the Express Service tag, Embedded NIC1 MAC address, and iDRAC6 Enterprise card MAC address.

Removing the Information Tag

- 1 Remove the front bezel. See "Removing and Replacing the Optional Front Bezel."
- 2 Pull the information tag out of its slot in the chassis until it is in the locked position. See Figure 1-1 in "About Your System" for the location of the information tag slot.
- 3 Pull the tag to the right until it disengages from the slot in the chassis to release the left portion of the tag.

- 4 Pull the tag to the left until it disengages from the slot in the chassis to release the right portion of the tag.
- 5 Remove the tag.

Replacing the Information Tag

- 1 Remove the front bezel. See "Removing and Replacing the Optional Front Bezel."
- 2 Locate the information tag slot on the front of the system chassis. See Figure 1-1 in "About Your System" for the location of the information tag slot.
- 3 Holding the information tag horizontally, slide it into the information tag slot until it locks into place.

Opening and Closing the System



CAUTION: Many repairs may only be done by a certified service technician. You should only perform troubleshooting and simple repairs as authorized in your product documentation, or as directed by the online or telephone service and support team. Damage due to servicing that is not authorized by Dell is not covered by your warranty. Read and follow the safety instructions that came with the product.



WARNING: Whenever you need to lift the system, get others to assist you. To avoid injury, do not attempt to lift the system by yourself.

Opening the System

- 1 Turn off the system and attached peripherals, and disconnect the system from the electrical outlet and peripherals.
- 2 Rotate the latch release lock counter clockwise to the unlocked position. See Figure 3-3.
- 3 Lift up on the latch on top of the system and slide the cover back. See Figure 3-3.
- 4 Grasp the cover on both sides and carefully lift the cover away from the system.

Figure 3-3. Removing and Replacing the System Cover

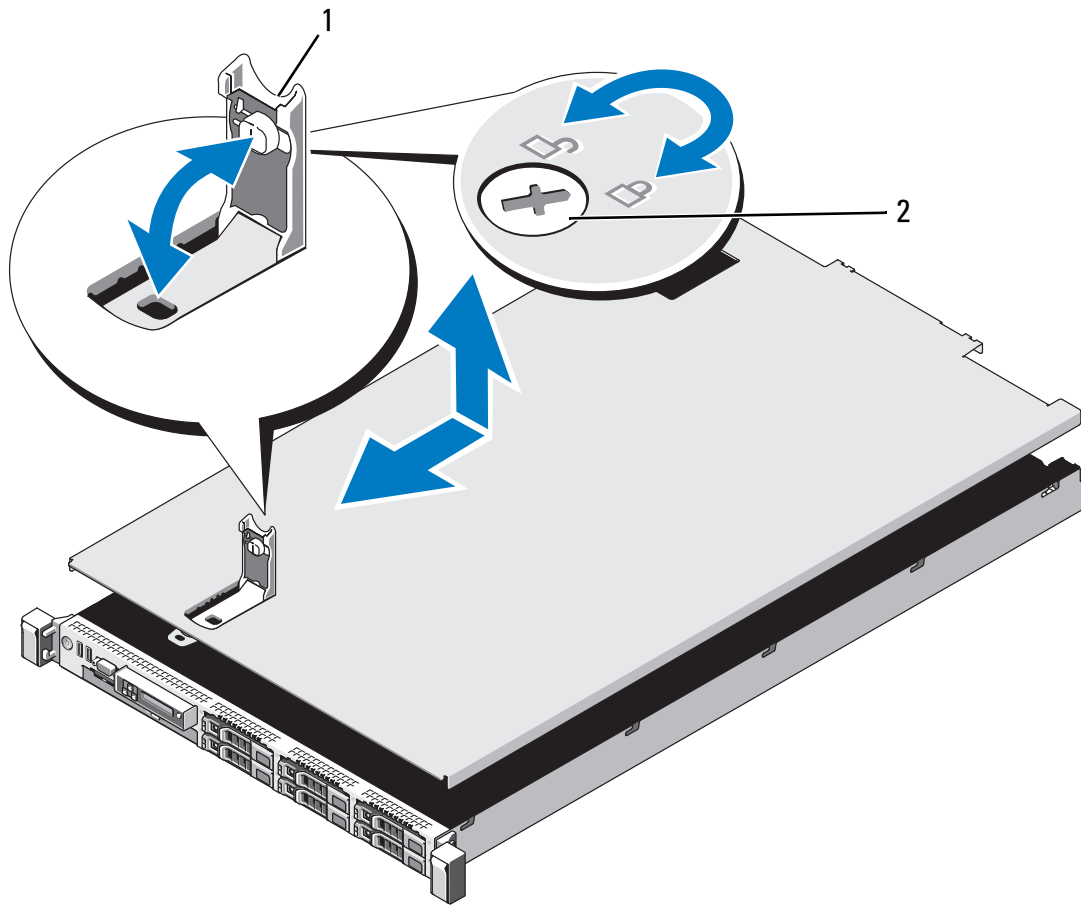

1 latch

2 latch release lock

Closing the System

- 1** Lift up the latch on the cover.
- 2** Place the cover onto the chassis and offset it slightly towards the back of the system, so that the two hooks on the back edge of the cover fit over the corresponding tabs on the back edge of the chassis. See Figure 3-3.
- 3** Slide the cover towards the front of the chassis and close the latch.
- 4** Rotate the latch release lock in a clockwise direction to secure the cover.

Hard Drives

Your system supports up to six 2.5-inch SAS, SATA, or SSD hard drives. See Figure 3-1.

- Mixed hard-drive configurations of SAS and SATA drives are allowed. In this configuration, two SAS drives must be installed in hard-drive slots 0 and 1 only. The remaining slots can have SATA drives installed.
- SSD hard-drive configurations require an integrated PERC storage controller, and all drives must be SSD drives.

All hard drives are installed at the front of the system and connect to the system board through the SAS backplane board. Hard drives are supplied in special hot-swappable drive carriers that fit in the hard-drive bays.

 **CAUTION:** Before attempting to remove or install a drive while the system is running, see the documentation for the integrated storage controller card to ensure that the host adapter is configured correctly to support hot-swap drive removal and insertion.

 **CAUTION:** Do not turn off or reboot your system while the drive is being formatted. Doing so can cause a drive failure.

 **NOTE:** Use only drives that have been tested and approved for use with the SAS backplane board.

When you format a hard drive, allow enough time for the formatting to be completed. Be aware that high-capacity hard drives can take a number of hours to format.

Removing a Drive Blank

 **NOTE:** To maintain proper system cooling, all empty hard-drive bays must have drive blanks installed.

- 1 Remove the front bezel. See "Removing and Replacing the Optional Front Bezel."
- 2 Grasp the front of the hard-drive blank, press the release lever on the right side, and slide the blank out until it is free of the drive bay.

Figure 3-4. Removing or Installing a Hard-Drive Blank

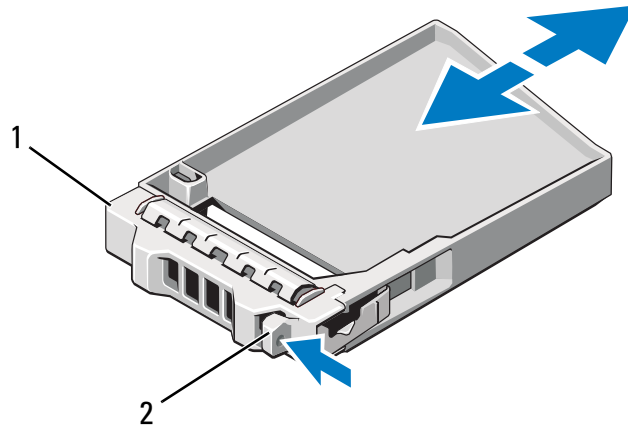

1 hard-drive blank

2 latch

Installing a Hard-Drive Blank

Align the hard-drive blank with the drive bay and insert the blank into the drive bay until the release lever clicks into place.

Removing a Hot-Swap Hard Drive

CAUTION: Ensure that your operating system supports hot-swap drive installation. See the documentation supplied with the operating system.

- 1 Remove the front bezel. See "Removing the Front Bezel."
- 2 Using the RAID management software, prepare the drive for removal. Wait until the hard-drive indicators on the drive carrier signal that the drive can be removed safely. See your storage controller documentation for information about hot-swap drive removal.

If the drive has been online, the green activity/fault indicator will flash as the drive is powered down. When the drive indicators are off, the drive is ready for removal.

- 3 Press the release button and open the drive carrier release handle to release the drive. See Figure 3-5.
- 4 Slide the hard drive out of the drive bay.
- 5 Insert a drive blank in the vacated drive bay. See "Installing a Drive Blank."

CAUTION: To maintain proper system cooling, all empty hard-drive bays must have drive blanks installed.

Installing a Hot-Swap Hard Drive

CAUTION: When installing a hard drive, ensure that the adjacent drives are fully installed. Inserting a hard-drive carrier and attempting to lock its handle next to a partially installed carrier can damage the partially installed carrier's shield spring and make it unusable.

CAUTION: Ensure that your operating system supports hot-swap drive installation. See the documentation supplied with the operating system.

- 1 Remove the front bezel. See "Removing the Front Bezel."
- 2 If a drive blank is present in the bay, remove it. See "Removing a Drive Blank."

Figure 3-5. Installing a Hot-Swap Hard Drive

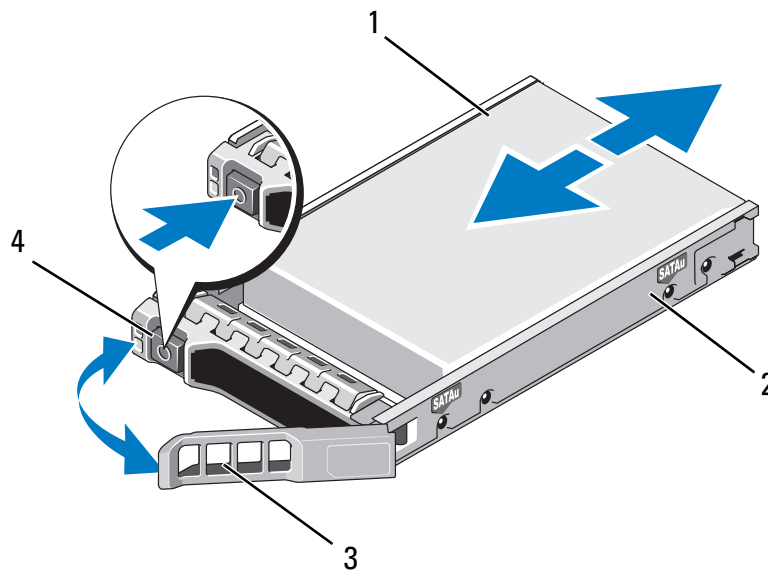

- | | | | |
|---|------------------------------|---|----------------|
| 1 | hard drive | 2 | drive carrier |
| 3 | drive carrier release handle | 4 | release button |

- 3 Install the hot-swap hard drive.
 - a Press the button on the front of the drive carrier.

- b** Insert the hard-drive carrier into the drive bay until the carrier contacts the backplane.
- c** Close the handle to lock the drive in place.

Removing a Hard Drive From a Hard-Drive Carrier

Remove the screws from the slide rails on the hard-drive carrier and separate the hard drive from the carrier. See Figure 3-6.

Installing a Hard Drive Into a Hard-Drive Carrier

- 1** Insert the hard drive into the hard-drive carrier with the connector end of the drive at the back. See Figure 3-6.
- 2** Align the holes on the hard drive with the back set of holes on the hard drive carrier.

When aligned correctly, the back of the hard drive will be flush with the back of the hard-drive carrier.

- 3** Attach the four screws to secure the hard drive to the hard-drive carrier.

Figure 3-6. Installing a Hard Drive Into a Drive Carrier

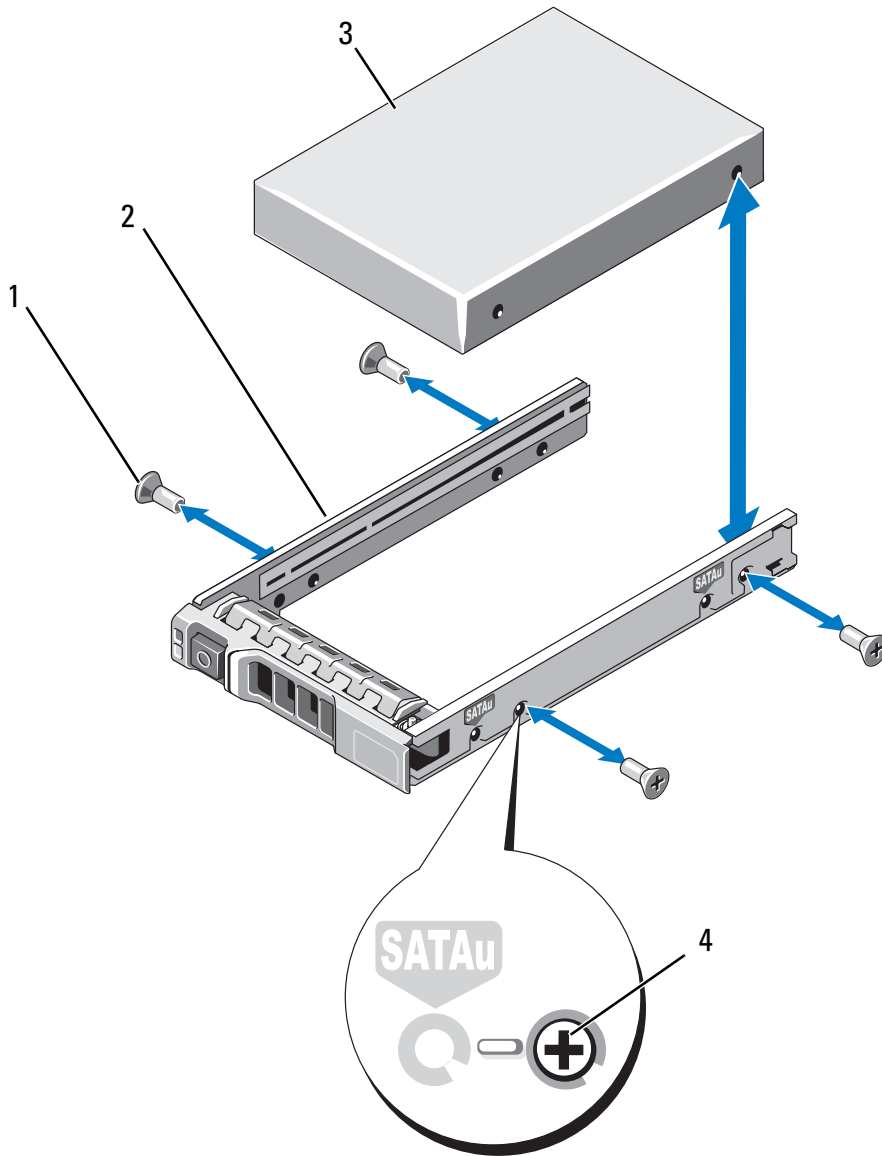

- 1 screws (4)
- 3 hard drive

- 2 drive carrier
- 4 SAS screw hole

Power Supplies

Your system supports the following power supply modules:

- 717-W High Output power supply
- 502-W Energy Smart power supply (the default power supply option for this system)



NOTE: The system does not support a mixed installation of High Output and Energy Smart power supplies.

If only one power supply is installed, it must be installed in the PS1 power supply bay.

Removing a Power Supply



CAUTION: To ensure proper system cooling, the power supply blank must be installed in power supply bay PS2 in a non-redundant configuration. See "Removing the Power Supply Blank."



CAUTION: If troubleshooting a PSU mismatch error, replace only the power supply with the flashing indicator. Swapping the opposite power supply to create a matched pair can result in an error condition and unexpected system shutdown. To change from a High Output configuration to an Energy Smart configuration or vice versa, you must power down the system.

- 1 Disconnect the power cable from the power source and the power supply you intend to remove and remove the cables from the Velcro strap.
- 2 Press the lever release latch and slide the power supply out of the chassis. See Figure 3-7.



NOTE: You may have to unlatch and lift the optional cable management arm if it interferes with power-supply removal. For information about the cable management arm, see the system's rack documentation.

Figure 3-7. Removing and Replacing a Power Supply

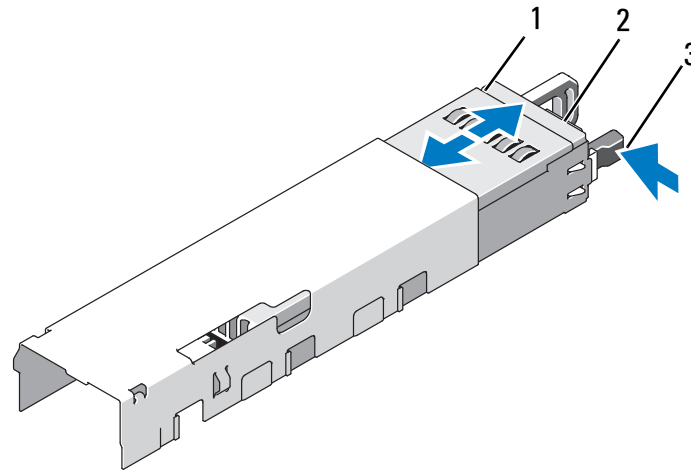

- 1 power supply
- 2 Velcro strap
- 3 release latch

Installing a Power Supply

- 1 On a system with redundant power supplies, verify that both power supplies are the same type and have the same maximum output power.

 **NOTE:** The maximum output power (shown in watts) is listed on the power supply label.

- 2 Slide the new power supply into the chassis until the power supply is fully seated and the release latch snaps into place. See Figure 3-7.

 **NOTE:** If you unlatched the cable management arm in step 2 of the previous procedure, relatch it. For information about the cable management arm, see the system's rack documentation.

- 3 Connect the power cable to the power supply and plug the cable into a power outlet.

 **CAUTION:** When connecting the power cable, secure the cable with the Velcro strap.

 **NOTE:** When installing, hot-swapping, or hot-adding a new power supply in a system with two power supplies, allow several seconds for the system to recognize the power supply and determine its status. The power-supply status indicator turns green to signify that the power supply is functioning properly (see Figure 1-5).

Removing the Power Supply Blank

If you are installing a second power supply, remove the power supply blank in bay PS2 by pulling outward on the blank.

 **CAUTION:** To ensure proper system cooling, the power supply blank must be installed in power supply bay PS2 in a non-redundant configuration. Remove the power supply blank only if you are installing a second power supply.

Installing the Power Supply Blank

 **NOTE:** Install the power supply blank only in power supply bay PS2.

To install the power supply blank, align the blank with the power supply bay and insert the blank into the chassis until it clicks into place.

Expansion Cards

Expansion Card Installation Guidelines

Your system supports one or two x8 Gen2 PCIe expansion cards installed in connectors on two expansion-card risers.

 **CAUTION:** Expansion cards can only be installed in the slots on the two expansion-card risers. Do not attempt to install expansion cards directly into the riser connectors on the system board.

- Both expansion slots support full-height, half-length cards.
- The expansion-card slots are not hot-swappable.
- PCI Express Generation 1 and Generation 2 expansion cards are supported in both slots.

 **CAUTION:** To ensure proper cooling, only one of the two expansion cards can have a power consumption of greater than 15W (up to 25W maximum), not including the integrated storage controller.

- Table 3-1 provides a guide for installing expansion cards to ensure proper cooling and mechanical fit. The expansion cards with the highest priority should be installed first using the slot priority indicated. All other expansion cards should be installed in card priority and slot priority order.

Table 3-1. Expansion-Card Installation Order

Card Priority	Card Type	Slot Priority	Max Allowed	25-W Card?
1	PERC 5/E controller	1, 2	1	Y
2	PERC 6/E controller	1, 2	1	Y
3	10 Gb NIC	2, 1	1	Y
4	All other Dell storage cards	1, 2	1	Y
5	All other NICs	2, 1	2	N*
6	Non-Dell storage cards	1, 2	2	N*

* Refer to the expansion card's documentation to determine if the maximum power exceeds 15W. Any cards that exceed 15W will be affected by the restriction of one 25W card.

Installing an Expansion Card



CAUTION: Many repairs may only be done by a certified service technician. You should only perform troubleshooting and simple repairs as authorized in your product documentation, or as directed by the online or telephone service and support team. Damage due to servicing that is not authorized by Dell is not covered by your warranty. Read and follow the safety instructions that came with the product.

- 1 Unpack the expansion card and prepare it for installation.
For instructions, see the documentation accompanying the card.
- 2 Turn off the system, including any attached peripherals, and disconnect the system from the electrical outlet.
- 3 Open the system. See "Opening the System."
- 4 Open the expansion-card latch and remove the filler bracket. See Figure 3-8.
- 5 Install the expansion card:
 - a Holding the card by its edges, position the card so that the card-edge connector aligns with the expansion-card connector on the expansion-card riser.
 - b Insert the card-edge connector firmly into the expansion-card connector until the card is fully seated.

- c Close the expansion-card latch. See Figure 3-8.

Figure 3-8. Installing or Removing an Expansion Card

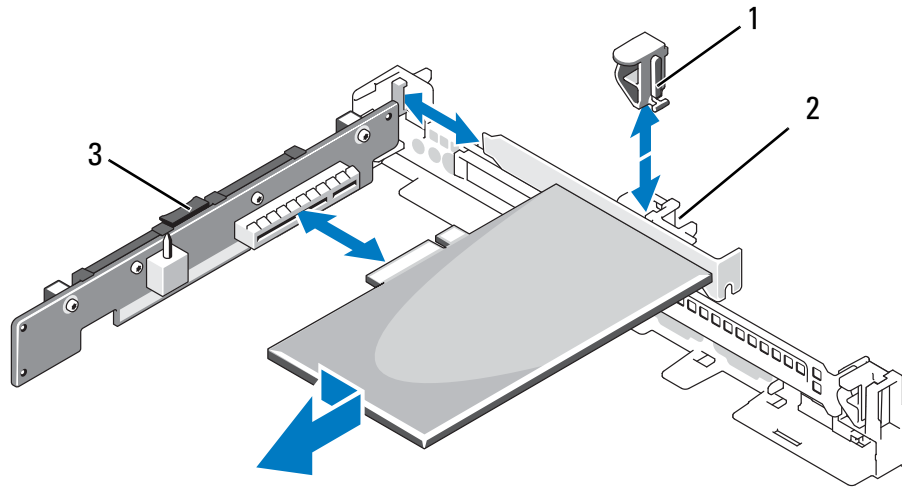

- 1 expansion-card latch
 - 2 expansion card
 - 3 expansion-card riser
- 6** Connect any cables to the expansion card.
- 7** Close the system. See "Closing the System."

Removing an Expansion Card



CAUTION: Many repairs may only be done by a certified service technician. You should only perform troubleshooting and simple repairs as authorized in your product documentation, or as directed by the online or telephone service and support team. Damage due to servicing that is not authorized by Dell is not covered by your warranty. Read and follow the safety instructions that came with the product.

- 1 Turn off the system, including any attached peripherals, and disconnect the system from the electrical outlet.
- 2 Open the system. See "Opening the System."
- 3 Disconnect all cables from the card.
- 4 Remove the expansion card:
 - a Open the expansion-card latch. See Figure 3-8.
 - b Grasp the expansion card by its edges, and carefully remove it from the expansion-card connector.
- 5 If you are removing the card permanently, install a metal filler bracket over the empty expansion slot opening and close the expansion-card latch.
 -  **NOTE:** You must install a filler bracket over an empty expansion slot to maintain Federal Communications Commission (FCC) certification of the system. The brackets also keep dust and dirt out of the system and aid in proper cooling and airflow inside the system.
- 6 Close the system. See "Closing the System."

Expansion-Card Risers

The system's left and center expansion-card risers each support a x8 link Gen1 or Gen2 PCIe expansion card. (An additional slot on riser 1 is reserved for use by the integrated storage controller card.)

Removing an Expansion-Card Riser



CAUTION: Many repairs may only be done by a certified service technician. You should only perform troubleshooting and simple repairs as authorized in your product documentation, or as directed by the online or telephone service and support team. Damage due to servicing that is not authorized by Dell is not covered by your warranty. Read and follow the safety instructions that came with the product.

- 1** Turn off the system, including any attached peripherals, and disconnect the system from the electrical outlet.
- 2** Open the system. See "Opening the System."
- 3** If an expansion card is installed in the expansion slot, remove the card now. See "Removing an Expansion Card."
- 4** If you are removing the riser 1, remove the integrated storage controller card. See "Removing the Integrated Storage Controller Card."
- 5** To remove the expansion-card riser, press the retention latch, then lift the expansion-card riser from the chassis. See Figure 3-9.

Figure 3-9. Installing or Removing an Expansion-Card Riser

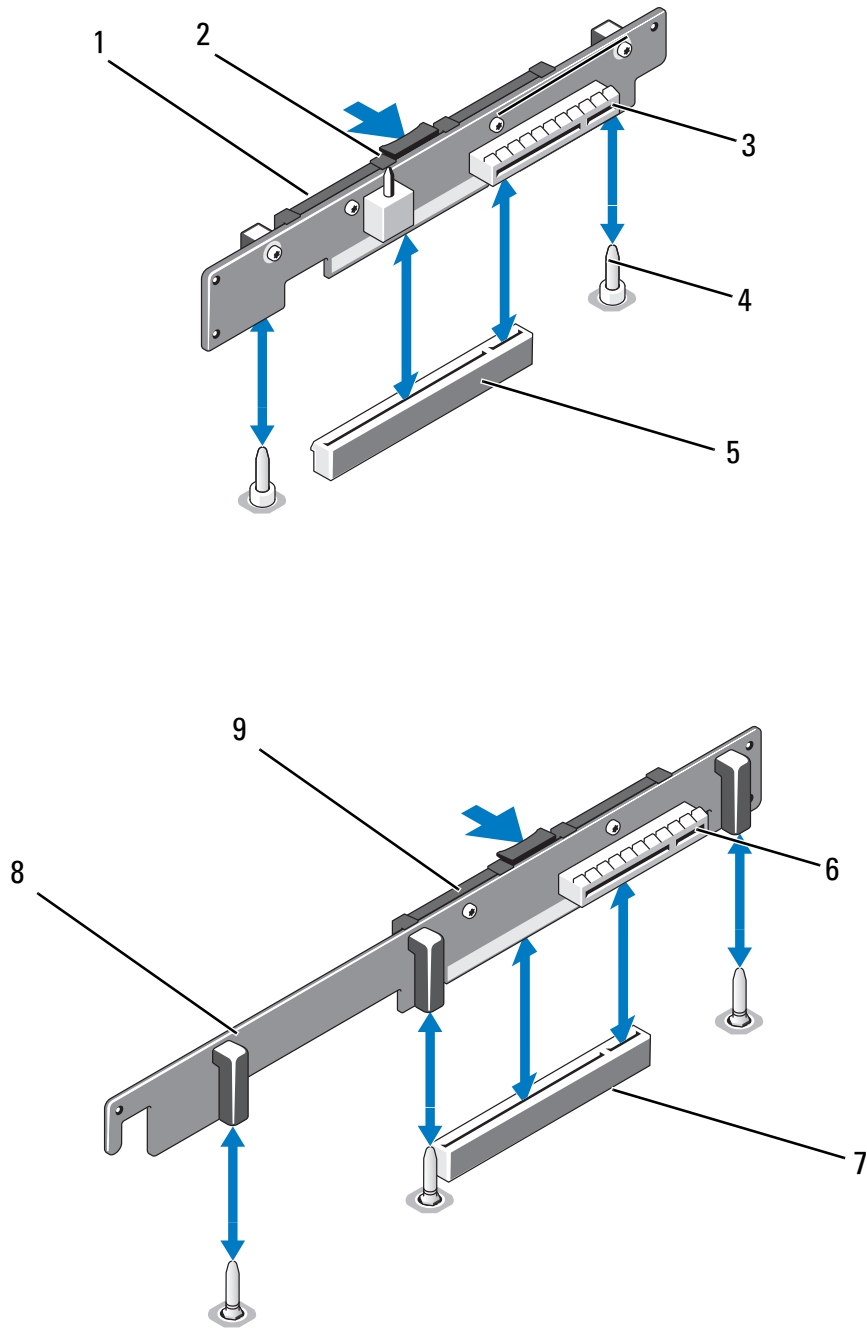

- | | | | |
|---|-----------------------------|---|--|
| 1 | expansion-card riser 2 | 2 | retention latch |
| 3 | expansion card slot 2 | 4 | riser guide posts (2 per riser) |
| 5 | expansion-card riser socket | 6 | expansion card slot 1 |
| 7 | expansion-card riser socket | 8 | integrated storage controller slot (on opposite side of riser) |
| 9 | expansion-card riser 1 | | |

Replacing an Expansion-Card Riser

- 1 To install an expansion-card riser, align the board with the riser guide posts on the system board. See Figure 3-9.
- 2 Lower the expansion-card riser into place until the expansion-card riser connector is fully seated.
- 3 If applicable, reinstall the expansion card. See "Installing an Expansion Card."
- 4 If you are installing expansion-card riser 1, reinstall the integrated storage controller card. See "Installing the Integrated Storage Controller Card."
- 5 Close the system. See "Closing the System."
- 6 Reconnect the system and peripherals to their power sources.

Internal SD Module

Installing the Internal SD Module

 **CAUTION:** Many repairs may only be done by a certified service technician. You should only perform troubleshooting and simple repairs as authorized in your product documentation, or as directed by the online or telephone service and support team. Damage due to servicing that is not authorized by Dell is not covered by your warranty. Read and follow the safety instructions that came with the product.

- 1 Turn off the system, including any attached peripherals, and disconnect the system from the electrical outlet.
- 2 Open the system. See "Opening the System."

- 3 Position the internal SD module tray so the tabs on the underside of the tray fit into the corresponding hooks on the chassis (item 3 in Figure 3-10), then lower the opposite edge of the card into place. See Figure 3-10.

Figure 3-10. Installing the Internal SD Module

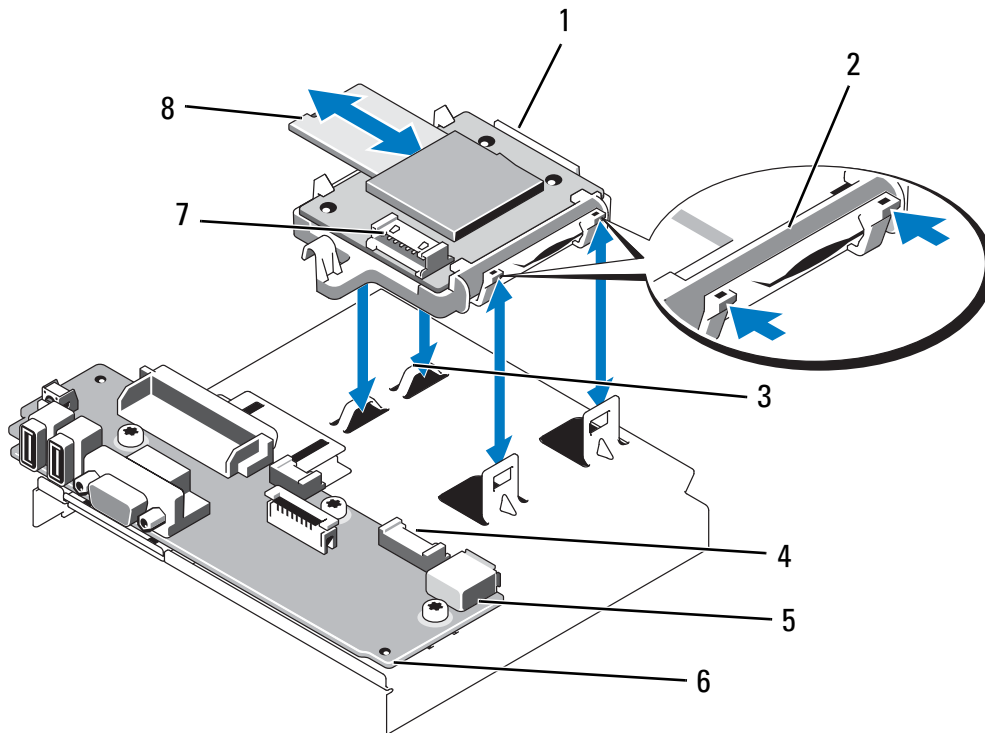

- | | | | |
|---|---------------------------------------|---|--|
| 1 | internal SD module | 2 | latch |
| 3 | hooks (2) | 4 | cable connector on control panel board |
| 5 | internal USB connector | 6 | control panel board |
| 7 | cable connector on internal SD module | 8 | internal SD flash card |

- 4 Connect the internal SD module cable to the connector on the control panel board. See Figure 3-10.
- 5 Close the system. See "Closing the System."
- 6 Reconnect the system and peripherals to their power sources, and turn them on.

Removing the Internal SD Module Card

 **CAUTION:** Many repairs may only be done by a certified service technician. You should only perform troubleshooting and simple repairs as authorized in your product documentation, or as directed by the online or telephone service and support team. Damage due to servicing that is not authorized by Dell is not covered by your warranty. Read and follow the safety instructions that came with the product.

- 1 Turn off the system, including any attached peripherals, and disconnect the system from the electrical outlet.
- 2 Open the system. See "Opening the System."
- 3 Disconnect the internal SD module cable from the module. See Figure 3-10.
- 4 Lift upwards on the latch securing the internal SD module card tray to the chassis, then lift the tray out of the chassis. See Figure 3-10.

Internal SD Flash Card

 **CAUTION:** Many repairs may only be done by a certified service technician. You should only perform troubleshooting and simple repairs as authorized in your product documentation, or as directed by the online or telephone service and support team. Damage due to servicing that is not authorized by Dell is not covered by your warranty. Read and follow the safety instructions that came with the product.

The optional SD Flash Card on the Internal SD module supports an embedded hypervisor for virtualization.

Installing an Internal SD Flash Card

- 1 Turn off the system, including any attached peripherals, and disconnect the system from its electrical outlet.
- 2 Open the system. See "Opening the System."
- 3 Locate the SD card connector on the internal SD module (see Figure 3-10).
- 4 With the label side facing up, insert the contact-pin end of the SD card into the card slot on the module. See Figure 3-10.

 **NOTE:** The slot is keyed to ensure correct insertion of the card.

- 5 Press the card into the card slot to lock it into place.
- 6 Close the system. See "Closing the System."
- 7 Reconnect the system to power and restart the system.

Removing an Internal SD Flash Card

 **CAUTION:** Many repairs may only be done by a certified service technician. You should only perform troubleshooting and simple repairs as authorized in your product documentation, or as directed by the online or telephone service and support team. Damage due to servicing that is not authorized by Dell is not covered by your warranty. Read and follow the safety instructions that came with the product.

- 1 Turn off the system, including any attached peripherals, and disconnect the system from the electrical outlet.
- 2 Open the system. See "Opening the System."
- 3 Locate the SD card slot on the internal SD module and press inward on the card to release it from the slot and remove the card.
- 4 Close the system. See "Closing the System."
- 5 Reconnect the system to power and restart the system.

Internal USB Memory Key

The USB memory key can be used as a boot device, security key, or mass storage device. To use the internal USB connector, the **Internal USB Port** option must be enabled in the **Integrated Devices** screen of the System Setup program.

To boot from the USB memory key, you must configure the USB memory key with a boot image and then specify the USB memory key in the boot sequence in the System Setup program. See "Boot Settings Screen." For information on creating a bootable file on the USB memory key, see the user documentation that accompanied the USB memory key.

 **CAUTION:** Many repairs may only be done by a certified service technician. You should only perform troubleshooting and simple repairs as authorized in your product documentation, or as directed by the online or telephone service and support team. Damage due to servicing that is not authorized by Dell is not covered by your warranty. Read and follow the safety instructions that came with the product.

NOTE: To avoid interference with other components, the maximum allowable dimensions of the USB key are 24 mm (.94 in) wide x 79 mm (3.11 in) long x 8.6 mm (.33 in) high.

- 1 Turn off the system, including any attached peripherals, and disconnect the system from the electrical outlet.
- 2 Open the system. See "Opening the System."
- 3 Locate the USB connector on the control panel board. See Figure 3-11.
- 4 Insert the USB memory key into the USB connector.
- 5 Close the system. See "Closing the System."
- 6 Reconnect the system to power and restart the system.

Figure 3-11. Removing or Installing the Internal USB Memory Key

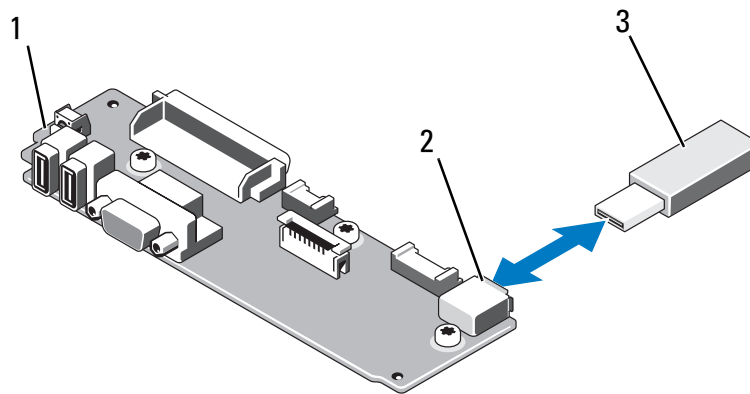

- 1 control panel board
- 3 USB memory key

- 2 USB memory key connector

Internal USB Cable

Removing the Internal USB Cable

CAUTION: Many repairs may only be done by a certified service technician. You should only perform troubleshooting and simple repairs as authorized in your product documentation, or as directed by the online or telephone service and support team. Damage due to servicing that is not authorized by Dell is not covered by your warranty. Read and follow the safety instructions that came with the product.

- 1 Turn off the system, including any attached peripherals, and disconnect the system from the electrical outlet.
- 2 Open the system. See "Opening the System."
- 3 Remove the fan bracket. See "Removing the Fan Assembly."
- 4 Remove the USB cable from the connector on the control panel.
- 5 Remove the USB cable from the cable routing guides on the inside of the chassis. If necessary remove any other cables from the cable routing guides.
- 6 Remove the USB cable from the connector on the system board.

Installing the Internal USB Cable



CAUTION: Many repairs may only be done by a certified service technician. You should only perform troubleshooting and simple repairs as authorized in your product documentation, or as directed by the online or telephone service and support team. Damage due to servicing that is not authorized by Dell is not covered by your warranty. Read and follow the safety instructions that came with the product.

- 1 Turn off the system, including any attached peripherals, and disconnect the system from the electrical outlet.
- 2 Open the system. See "Opening the System."
- 3 Remove the fan bracket. See "Removing the Fan Assembly."
- 4 Connect the USB cable to the connector on the control panel.
- 5 Route the cable through the cable routing guides on the inside of the chassis.
- 6 Connect the USB cable to the connector on the system board.
- 7 Replace the fan bracket. See "Replacing the Fan Assembly."
- 8 Close the system. See "Closing the System."
- 9 Reconnect the system and peripherals to their power sources, and turn them on.

VFlash Media

The VFlash media card is a Secure Digital (SD) card that plugs into the optional iDRAC6 Enterprise card at the back corner of the system.

Installing a VFlash Media Card

- 1 Locate the VFlash media slot at the back corner of the system. See "Back-Panel Features and Indicators" for the location of the media slot.
- 2 With the label side facing up, insert the contact-pin end of the SD card into the card slot on the module.
 **NOTE:** The slot is keyed to ensure correct insertion of the card.
- 3 Press inward on the card to lock it into the slot.

Removing a VFlash Media Card

To remove the VFlash media, push inward on the card to release it, and pull the card from the card slot.

iDRAC6 Enterprise Card (Optional)

Installing an iDRAC6 Enterprise Card

 **CAUTION:** Many repairs may only be done by a certified service technician. You should only perform troubleshooting and simple repairs as authorized in your product documentation, or as directed by the online or telephone service and support team. Damage due to servicing that is not authorized by Dell is not covered by your warranty. Read and follow the safety instructions that came with the product.

- 1 Turn off the system, including any attached peripherals, and disconnect the system from the electrical outlet.
- 2 Open the system. See "Opening the System."
- 3 Remove the plastic filler plug from the system back panel.
- 4 If installed, remove the expansion card from expansion-card riser 1. See "Removing an Expansion Card."
- 5 Install the iDRAC6 Enterprise card:
 - a Angle the card so that the RJ-45 connector fits through the back-panel opening. See Figure 3-12.
 - b Align the front edge of the card with the two front plastic retention standoffs next to the iDRAC6 connector on the system board, and lower the card into place. See Figure 3-12 and Figure 6-1.

When the front of the card is fully seated, the plastic standoffs snap over the edge of the card.

Figure 3-12. Installing or Removing an iDRAC6 Enterprise Card

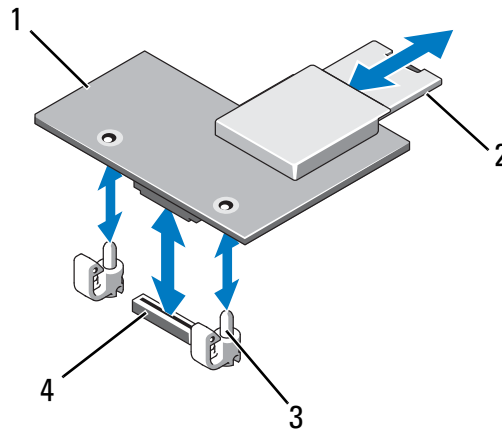

- | | | | |
|---|------------------------------|---|----------------|
| 1 | iDRAC6 Enterprise card | 2 | SD VFlash card |
| 3 | retention standoff posts (2) | 4 | socket |

- 6 Reinstall the left expansion card, if applicable. See "Installing an Expansion Card."
- 7 Close the system. See "Closing the System."
- 8 Reconnect the system and peripherals to their power sources, and turn them on.

Removing an iDRAC6 Enterprise Card

CAUTION: Many repairs may only be done by a certified service technician. You should only perform troubleshooting and simple repairs as authorized in your product documentation, or as directed by the online or telephone service and support team. Damage due to servicing that is not authorized by Dell is not covered by your warranty. Read and follow the safety instructions that came with the product.

- 1 Turn off the system, including any attached peripherals, and disconnect the system from the electrical outlet.
- 2 Disconnect the Ethernet cable from the iDRAC6 Enterprise Card connector on the system back panel. See Figure 1-4.

- 3 Open the system. See "Opening the System."
- 4 Remove the VFlash media from the iDRAC6 Enterprise Card. See "Removing a VFlash Media Card."
- 5 If installed, remove the expansion card from expansion-card riser 2. See "Removing an Expansion Card."
- 6 Remove the iDRAC6 Enterprise card:
 - a Pull back slightly on the two tabs at the front edge of the card and gently lift the front edge of the card off of the retention standoffs. As the card releases from the standoffs, the connector under the card disengages from the system board connector.
 - b Slide the card away from the back of the system until the RJ-45 connector is clear of the back panel, then lift the card out of the system.
- 7 Reinstall the expansion card. See "Installing an Expansion Card."
- 8 Close the system. See "Closing the System."
- 9 Reconnect the system and peripherals to their power sources, and turn them on.

NIC Hardware Key

iSCSI and other functionalities for the system's embedded NICs are enabled by installing an NIC hardware key in the iSCSI key socket on the system board.



CAUTION: Many repairs may only be done by a certified service technician. You should only perform troubleshooting and simple repairs as authorized in your product documentation, or as directed by the online or telephone service and support team. Damage due to servicing that is not authorized by Dell is not covered by your warranty. Read and follow the safety instructions that came with the product.





NOTE: When future NIC functionality is added, you must install a new hardware key that adds that functionality.

- 1 Turn off the system, including any attached peripherals, and disconnect the system from its electrical outlet.
- 2 Open the system. See "Opening the System."

 **NOTE:** IF FAN6 is installed in a single-processor configuration, the fan will still be operational.

Removing a Cooling Fan

 **CAUTION:** Many repairs may only be done by a certified service technician. You should only perform troubleshooting and simple repairs as authorized in your product documentation, or as directed by the online or telephone service and support team. Damage due to servicing that is not authorized by Dell is not covered by your warranty. Read and follow the safety instructions that came with the product.

 **NOTE:** The procedure for removing each individual fan module is the same.

- 1 Turn off the system, including any attached peripherals, and disconnect the system from its electrical outlet.
- 2 Open the system. See "Opening the System."
- 3 Disconnect the fan's power cable from the system board. See Figure 3-14.
- 4 Remove the faulty fan by grasping the two blue touch points on the fan and sliding the fan from the fan assembly. See Figure 3-14.

Figure 3-14. Removing and Replacing a Fan

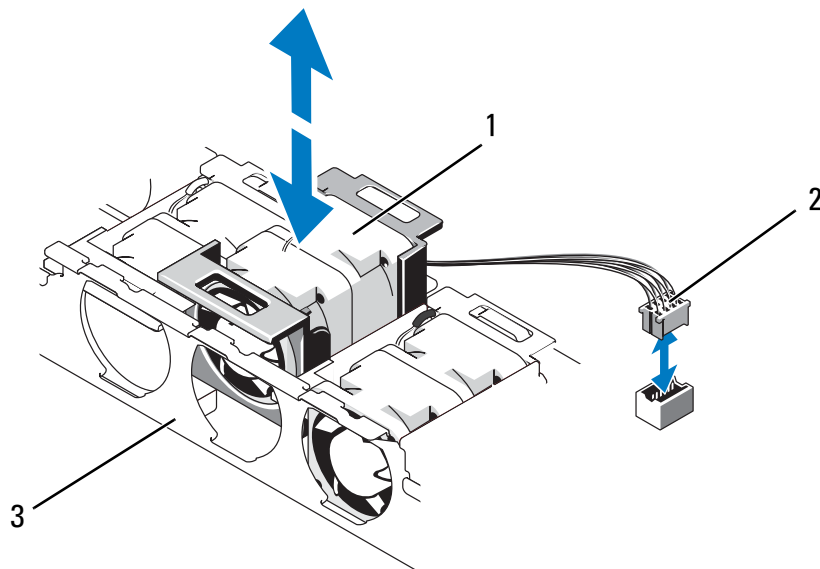

1 fan

2 power cable

3 fan assembly

Replacing a Cooling Fan

- 1 Ensure that the fan is oriented correctly.
Orient the fan module so that the side with the power cable faces towards the back of the system.
- 2 Slide the fan module into the fan assembly until the fan is fully seated. See Figure 3-14.
- 3 Connect the fan's power cable to the power connector on the system board.
- 4 Close the system. See "Closing the System."

Removing the Fan Assembly



CAUTION: Many repairs may only be done by a certified service technician. You should only perform troubleshooting and simple repairs as authorized in your product documentation, or as directed by the online or telephone service and support team. Damage due to servicing that is not authorized by Dell is not covered by your warranty. Read and follow the safety instructions that came with the product.



NOTE: The procedure for removing each individual fan module is the same.

- 1 Turn off the system, including any attached peripherals, and disconnect the system from its electrical outlet.
- 2 Open the system. See "Opening the System."
- 3 Disconnect each fan's power cable from the system board. See Figure 3-14.
- 4 Lift the two latches on the top of the fan assembly, then lift the fan assembly from the chassis.

- 3 Close the system. See "Closing the System."

Removing the Plastic Fan Guide

- 1 Turn off the system, including any attached peripherals, and disconnect the system from its electrical outlet.
- 2 Open the system. See "Opening the System."
- 3 If necessary, remove the fan bracket. See "Removing the Fan Assembly" and place the fan assembly on a flat surface.
- 4 Remove the fan guide by toggling the two small pegs on the plastic guide out of the two holes in the fan assembly. For the location of the fan guide and latches see Figure 3-15.

Replacing the Plastic Fan Guide

- 1 Turn off the system, including any attached peripherals, and disconnect the system from its electrical outlet.
- 2 Open the system. See "Opening the System."
- 3 If necessary, remove the fan bracket. See "Removing the Fan Assembly" and place the fan assembly on a flat surface.
- 4 Replace the guide by aligning the 2 small pegs on the guide with the two holes in the fan bracket. See Figure 3-15.
- 5 Replace the fan bracket. See "Replacing the Fan Assembly."
- 6 Close the system. See "Closing the System."
- 7 Reconnect the system and peripherals to their power sources, and turn them on.

Optical Drive

An optional slimline DVD or DVD-RW optical drive slides into the front panel and connects to the SATA controller on the system board.

 **NOTE:** DVD devices are data only.

Removing an Optical Drive

 **CAUTION:** Many repairs may only be done by a certified service technician. You should only perform troubleshooting and simple repairs as authorized in your product documentation, or as directed by the online or telephone service and support team. Damage due to servicing that is not authorized by Dell is not covered by your warranty. Read and follow the safety instructions that came with the product.

- 1** Remove the bezel. See "Removing and Replacing the Optional Front Bezel."
- 2** Turn off the system, including any attached peripherals, and disconnect the system from its electrical outlet.
- 3** Open the system. See "Opening the System."
- 4** Disconnect the cable connector labeled OPTICAL from the back of the drive.
- 5** To remove the drive carrier, press the release latch, then slide the carrier out of the chassis. See Figure 3-16.
- 6** Close the system. See "Closing the System."
- 7** Replace the front bezel, if applicable. See "Removing and Replacing the Optional Front Bezel."

Figure 3-16. Removing the Optical Drive

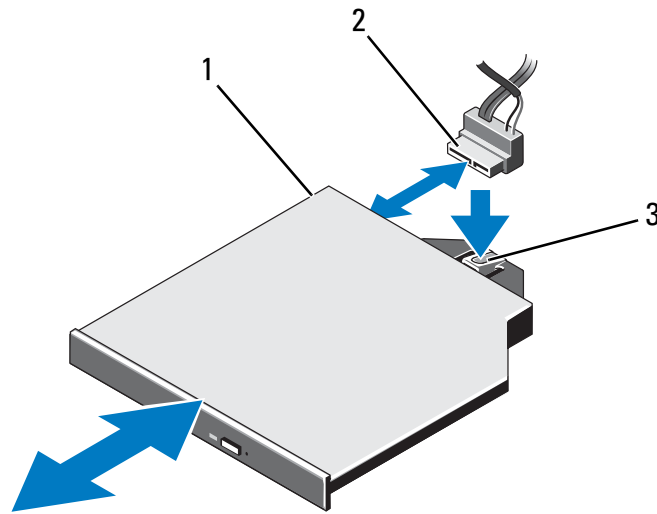

- 1 optical drive
- 3 release latch

- 2 drive cable

Installing an Optical Drive



CAUTION: Many repairs may only be done by a certified service technician. You should only perform troubleshooting and simple repairs as authorized in your product documentation, or as directed by the online or telephone service and support team. Damage due to servicing that is not authorized by Dell is not covered by your warranty. Read and follow the safety instructions that came with the product.

- 1 Remove the bezel. See "Removing and Replacing the Optional Front Bezel."
- 2 Turn off the system, including any attached peripherals, and disconnect the system from its electrical outlet.
- 3 Open the system. See "Opening the System."
- 4 To remove the optical drive blank, press down on the blue release tab at the back of the blank and push the blank out of the system.
- 5 Align the optical drive with its opening in the front panel.
- 6 Slide in the optical drive until the latch snaps into place.
- 7 Connect the cable connector labeled OPTICAL to the back of the drive.

- 8 If not already done, connect the power cable to DVD_PWR and the interface cable to SATA_A on the system board. See Figure 6-1.
- 9 Replace the front bezel, if applicable. See "Removing and Replacing the Optional Front Bezel."
- 10 Reconnect the system and peripherals to their electrical outlets.

Integrated Storage Controller Card

Your system includes a dedicated expansion-card slot on riser 1 for an integrated SAS or PERC controller card that provides the integrated storage subsystem for your system's internal hard drives. The controller supports SAS and SATA hard drives and also enables you to set up the hard drives in RAID configurations as supported by the version of the storage controller included with your system.

Removing the Integrated Storage Controller Card

 **CAUTION: Many repairs may only be done by a certified service technician. You should only perform troubleshooting and simple repairs as authorized in your product documentation, or as directed by the online or telephone service and support team. Damage due to servicing that is not authorized by Dell is not covered by your warranty. Read and follow the safety instructions that came with the product.**

- 1 Turn off the system, including any attached peripherals, and disconnect the system from the electrical outlet.
- 2 Open the system. See "Opening the System."
- 3 Disconnect the data cables from the controller card. See Figure 3-17.
To remove a connector, press the latches on both ends of the connector.
- 4 If you are removing a battery-cached PERC controller, disconnect the RAID battery cable from the card.

 **CAUTION: Disconnecting the RAID battery cable from a PERC card can cause data loss if the "dirty cache" LED on the card is lit. The LED indicates that data is still cached in controller memory and the data was not cleared at system shutdown.**

- 5 Remove the card from the storage controller card slot:

- a Grasp the expansion card by its edges, bend outward on both card-edge guides, and carefully remove the card from the expansion-card connector.
- b With the blue card-edge guides still bent outwards, lift the side of the controller that is adjacent to the blue guide, and then remove the controller towards the front of the chassis.

Installing the Integrated Storage Controller Card



CAUTION: Many repairs may only be done by a certified service technician. You should only perform troubleshooting and simple repairs as authorized in your product documentation, or as directed by the online or telephone service and support team. Damage due to servicing that is not authorized by Dell is not covered by your warranty. Read and follow the safety instructions that came with the product.

- 1 Turn off the system, including any attached peripherals, and disconnect the system from the electrical outlet.
 - 2 Open the system. See "Opening the System."
 - 3 Install the controller card in the expansion slot on riser 1 labeled INT_STORAGE.
 - a Holding the card by its edges, with the card-edge facing the riser, insert one side of the card into the black card-edge guide. Bend outward on the blue card-edge guide, lower the card onto the blue card-edge guide, and release the guide. See Figure 3-17.
 - b Insert the card-edge connector firmly into the expansion-card connector until the card is fully seated and the plastic card guides fit over the edges of the card.
 - 4 Connect the card to the SAS backplane:
 - a Connect the SAS data cable connector labelled "SAS_0" to the white SAS_0 connector on the card, and the connector labelled "SAS_1" to the black SAS_1 connector on the card. See Figure 3-17.
-  **NOTE:** Be sure to connect the cable according to the connector labels on the cable. The cable will not function properly if reversed.
- b Route the SAS data cable through the channel on the inner side of the chassis.

- c** Unlatch the fan assembly and lift it far enough out of the chassis to route the SAS cable along the inside of the chassis, underneath the plastic retention clip. Replace the fan assembly and close the latches. See Figure 3-14, "Removing a Cooling Fan," and "Replacing a Cooling Fan."
- d** Attach the connector labeled "SAS A" to connector SAS A on the backplane, and attach the connector labeled "SAS B" to connector SAS B on the backplane. See Figure 3-17.

Figure 3-17. Installing the Integrated Storage Controller Card

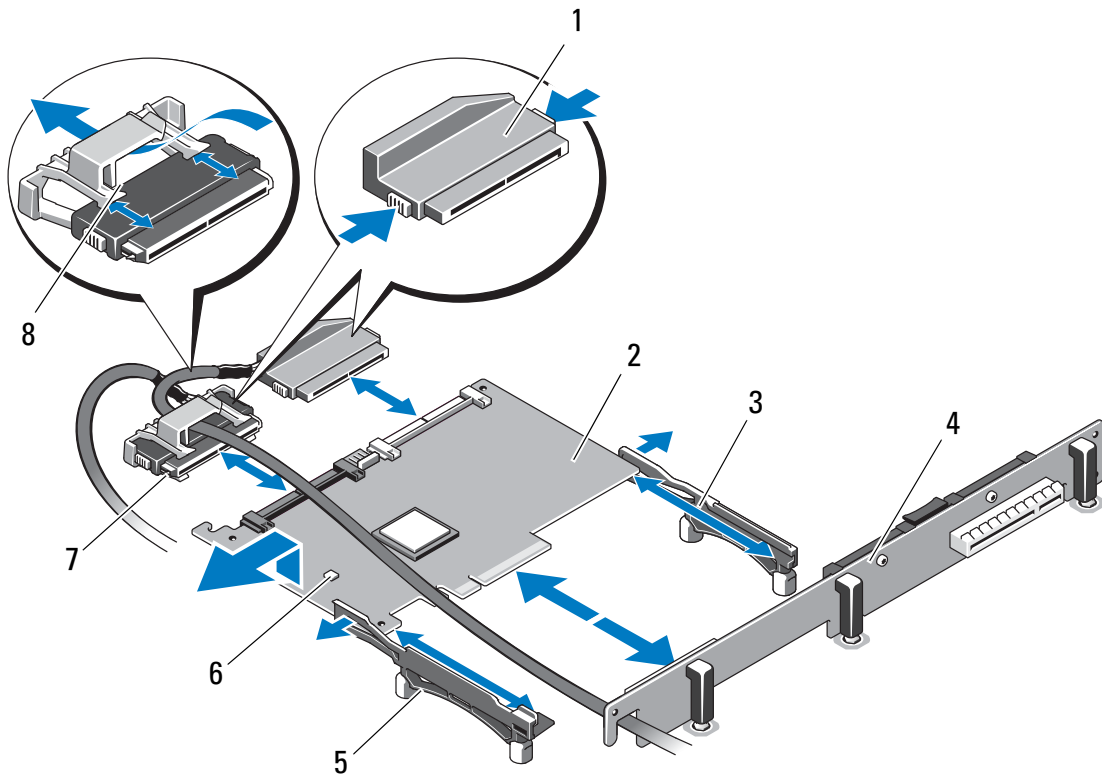

- | | | | |
|---|------------------------------|---|------------------------------------|
| 1 | SAS data cable connector | 2 | integrated storage controller card |
| 3 | back card edge guide (black) | 4 | expansion card riser 1 |
| 5 | front card edge guide (blue) | 6 | RAID battery connector (PERC only) |
| 7 | SAS data cable | 8 | cable retention clip |

- 5** Close the system. See "Closing the System."

- 6 Reconnect the system to its electrical outlet and turn the system on, including any attached peripherals.

RAID Battery

The information in this section applies only to systems with the optional battery-cached PERC controller card.

 **CAUTION: Many repairs may only be done by a certified service technician. You should only perform troubleshooting and simple repairs as authorized in your product documentation, or as directed by the online or telephone service and support team. Damage due to servicing that is not authorized by Dell is not covered by your warranty. Read and follow the safety instructions that came with the product.**

Removing a RAID Battery

 **CAUTION: Before disconnecting the RAID battery cable from the PERC card, perform a controlled shutdown to ensure that data in the cache is written.**

- 1 Pull back gently on the edge of the battery bay and draw out the RAID battery from the battery carrier.
- 2 Disconnect the cable between the RAID battery and the PERC controller card.

Installing a RAID Battery

- 1 Connect the battery cable to the connector on the battery.
- 2 Locate the battery bay on the inner wall of the chassis next to the control panel board. See Figure 3-1.
- 3 Insert the battery into the battery holder.
- 4 Connect the battery cable to the battery connector on the RAID controller.

Removing the PERC 6/I Battery Cable

- 1 Turn off the system, including any attached peripherals, and disconnect the system from the electrical outlet.
- 2 Open the system. See "Opening the System."

- 3 Disconnect the battery cable from the PERC controller. See Figure 3-17 for the battery connection location.

NOTE: Pay attention to the routing of the cable in the chassis for reinstallation.

- 4 Remove the battery cable from the cable clip on the system board nearest PSU #2.
- 5 Follow the cable along the inside wall of the chassis.
- 6 Remove the fan bracket. See "Removing the Fan Assembly" on page 106.
- 7 Remove the fan cable from the plastic cable routing guide. It might be necessary to remove other cables from the routing guide.
- 8 Disconnect the battery cable from the RAID battery.

Installing the PERC 6/I Battery Cable

- 1 Turn off the system, including any attached peripherals, and disconnect the system from the electrical outlet.
- 2 Open the system. See "Opening the System."
- 3 Remove the fan bracket. See "Removing the Fan Assembly" on page 106.
- 4 Connect the battery cable to the RAID battery.
- 5 Route the battery cable on the inside of the chassis wall through the plastic cable routing guide. If any other cables were removed from the routing guide, route those cables through the routing guide as well.
- 6 Route the cable on the inside of the chassis wall, place the cable in the cable clip nearest PSU #2.
- 7 Route the cable to the PERC controller and connect it to the battery connector on the PERC controller.
- 8 Replace the fan bracket. See "Replacing the Fan Assembly" on page 107.
- 9 Close the system. See "Closing the System."
- 10 Reconnect the system to its electrical outlet and turn the system on, including any attached peripherals.

System Memory

Your system supports DDR3 registered DIMMs (RDIMMs) or unbuffered ECC DIMMs (UDIMMs). Single and dual-rank DIMMs can be 1067- or 1333-MHz, and quad-rank DIMMs can be 1067-MHz.

The system contains 12 memory sockets split into two sets of six sockets, one set per each processor. Each six-socket set is organized into three channels of two memory sockets per channel. The first socket of each channel is marked with white release levers.

The maximum memory that is supported on your system varies according to the types and sizes of memory modules being used:

- RDIMMs of sizes 2-GB, 4-GB, and 8-GB are supported for a total of up to 96 GB.
- 1-GB and 2-GB UDIMMs are supported for a total of up to 24 GB.

General Memory Module Installation Guidelines

To ensure optimal performance of your system, observe the following general guidelines when configuring your system memory.



NOTE: Memory configurations that fail to observe these guidelines can prevent your system from starting and producing any video output.

- RDIMMs and UDIMMs cannot be mixed.
- In a dual-processor configuration, the memory configuration for each processor must be identical
- For Optimizer Mode, memory modules are installed in the numeric order of the sockets beginning with A1 or B1.
- For Memory Mirroring or Advanced ECC Mode, the three sockets furthest from the processor are unused and memory modules are installed beginning with socket A2 or B2 and proceeding in the following order: A2, A3, A5, and A6).
- Advanced ECC Mode requires x4 or x8 DRAM device widths.
- The memory speed of each channel depends on the memory configuration:
 - For single or dual-rank memory modules:
 - One memory module per channel supports up to 1333 MHz.

- Two memory modules per channel supports up to 1067 MHz.
- For quad-rank memory modules:
 - One memory module per channel supports up to 1067 MHz.
 - Two memory modules per channel are limited to 800 MHz, regardless of memory module speed.
- If quad-rank memory modules are mixed with single- or dual-rank modules, the quad-rank modules must be installed in the sockets with the white release levers.
- If memory modules with different speeds are installed, they will operate at the speed of the slowest installed memory module(s).

Mode-Specific Guidelines

Three memory channels are allocated to each processor. The number of channels used and the allowable configurations depend on the memory mode selected.

Advanced ECC (Lockstep) Mode Support

In this configuration, the two channels closest to the processor are combined to form one 128-bit channel. This mode supports Single Device Data Correction (SDDC) for both x4- and x8-based memory modules. Memory modules must be identical in size, speed, and technology in corresponding slots.

Memory Mirroring Support

The system supports memory mirroring if identical memory modules are installed in the two channels closest to the processor (memory is not installed in the farthest channel). Mirroring must be enabled in the System Setup program. In a mirrored configuration, the total available system memory is one-half of the total installed physical memory.

Optimizer (Independent Channel) Mode

In this mode, all three channels are populated with identical memory modules. This mode permits a larger total memory capacity but does not support SDDC with x8-based memory modules.

A minimal single-channel configuration of one 1-GB memory module per processor is also supported in this mode.

Table 3-2 and Table 3-3 show sample memory configurations that follow the appropriate memory guidelines stated in this section. The samples show identical memory-module configurations and their the physical and available memory totals. The tables do not show mixed or quad-rank memory-module configurations, nor do they address the memory speed considerations of any configuration.

Table 3-2. RDIMM Memory Configurations

Memory Mode	Memory Module Size	Memory Sockets			Single Processor		Dual Processor	
		1 4	2 5	3 6	Physical Memory (GB)	Available Memory (GB)	Physical Memory (GB)	Available Memory (GB)
Optimizer	2-GB	X			2	all	4	all
		X	X		4		8	
		X	X	X	6		12	
		X X			4		8	
		X X X X			8		16	
		X X X X X X			12		24	
	4-GB	X			4	all	8	all
		X	X		8		16	
		X	X	X	12		24	
		X X			8		16	
		X X X X			16		32	
		X X X X X X			24		48	
	8-GB	X			8	all	16	all
		X	X		16		32	
		X	X	X	24		48	
		X X			16		32	
		X X X X			32		64	
		X X X X X X			48		96	

Table 3-2. RDIMM Memory Configurations (continued)

Memory Mode	Memory Module Size	Memory Sockets			Single Processor		Dual Processor	
		1 4	2 5	3 6	Physical Memory (GB)	Available Memory (GB)	Physical Memory (GB)	Available Memory (GB)
Advanced ECC	2-GB	none	X X X	X X X	4 8	all	8 16	all
	4-GB	none	X X X	X X X	8 16	all	16 32	all
	8-GB	none	X X X	X X X	16 32	all	32 64	all
Mirroring	2-GB	none	X X X	X X X	4 8	2 4	8 16	4 8
	4-GB	none	X X X	X X X	8 16	4 8	16 32	8 16
	8-GB	none	X X X	X X X	16 32	8 16	32 64	16 32

Table 3-3. UDIMM Memory Configurations

Memory Mode	Memory Module Size	Memory Sockets			Single Processor		Dual Processor	
		1 4	2 5	3 6	Physical Memory (GB)	Available Memory (GB)	Physical Memory (GB)	Available Memory (GB)
Optimizer	1-GB	X			1	all	2	all
		X	X		2		4	
		X	X	X	3		6	
		X X	X X		4		8	
		X X	X X	X X	6		12	
	2-GB	X			2	all	4	all
		X	X		4		8	
		X	X	X	6		12	
		X X	X X		8		16	
		X X	X X	X X	12		24	

Table 3-3. UDIMM Memory Configurations (continued)

Memory Mode	Memory Module Size	Memory Sockets			Single Processor		Dual Processor	
		1 4	2 5	3 6	Physical Memory (GB)	Available Memory (GB)	Physical Memory (GB)	Available Memory (GB)
Advanced ECC	1-GB	none	X X X	X X X	2 4	all	4 8	all
	2-GB	none	X X X	X X X	4 8	all	8 16	all
Mirroring	1-GB	none	X X X	X X X	2 4	1 2	4 8	2 4
	2-GB	none	X X X	X X X	4 8	2 4	8 16	4 8

Installing Memory Modules

 **CAUTION:** Many repairs may only be done by a certified service technician. You should only perform troubleshooting and simple repairs as authorized in your product documentation, or as directed by the online or telephone service and support team. Damage due to servicing that is not authorized by Dell is not covered by your warranty. Read and follow the safety instructions that came with the product.

 **WARNING:** The memory modules are hot to the touch for some time after the system has been powered down. Allow time for the memory modules to cool before handling them. Handle the memory modules by the card edges and avoid touching the components on the memory module.

- 1 Turn off the system, including any attached peripherals, and disconnect the system from the electrical outlet.
- 2 Open the system. See "Opening the System."
- 3 Locate the memory module sockets. See Figure 6-1.
- 4 Press the ejectors on the memory module socket down and out, as shown in Figure 3-18, to allow the memory module to be inserted into the socket.
- 5 Handle each memory module only on either card edge, making sure not to touch the middle of the memory module.

- 11 If the value is incorrect, one or more of the memory modules may not be installed properly. Repeat step 2 through step 10 of this procedure, checking to ensure that the memory modules are firmly seated in their sockets.
- 12 Run the system memory test in the system diagnostics. See "Running the System Diagnostics."

Removing Memory Modules

 **CAUTION:** Many repairs may only be done by a certified service technician. You should only perform troubleshooting and simple repairs as authorized in your product documentation, or as directed by the online or telephone service and support team. Damage due to servicing that is not authorized by Dell is not covered by your warranty. Read and follow the safety instructions that came with the product.

 **WARNING:** The memory modules are hot to the touch for some time after the system has been powered down. Allow time for the memory modules to cool before handling them. Handle the memory modules by the card edges and avoid touching the components on the memory module.

- 1 Turn off the system, including any attached peripherals, and disconnect the system from the electrical outlet.
- 2 Open the system. See "Opening the System."
- 3 Locate the memory module sockets. See Figure 6-1.
- 4 Press down and out on the ejectors on each end of the socket until the memory module pops out of the socket. See Figure 3-18.

Handle each memory module only on either card edge, making sure not to touch the middle of the memory module.

- 5 Close the system. See "Closing the System."

Processors

Removing a Processor

 **CAUTION:** Many repairs may only be done by a certified service technician. You should only perform troubleshooting and simple repairs as authorized in your product documentation, or as directed by the online or telephone service and

support team. Damage due to servicing that is not authorized by Dell is not covered by your warranty. Read and follow the safety instructions that came with the product.

- 1 Prior to upgrading your system, download and install the latest system BIOS version from support.dell.com. Follow the instructions included in the file download to install the update on your system.
- 2 Turn off the system, including any attached peripherals, and disconnect the system from the electrical outlet.
- 3 Open the system. See "Opening the System."

△ CAUTION: Never remove the heat sink from a processor unless you intend to remove the processor. The heat sink is necessary to maintain proper thermal conditions.

- 4 Open one of the heat-sink retention latches by pressing the end of the latch, moving it laterally, and lifting the latch upwards. See Figure 3-19.

Figure 3-19. Installing and Removing the Heat Sink

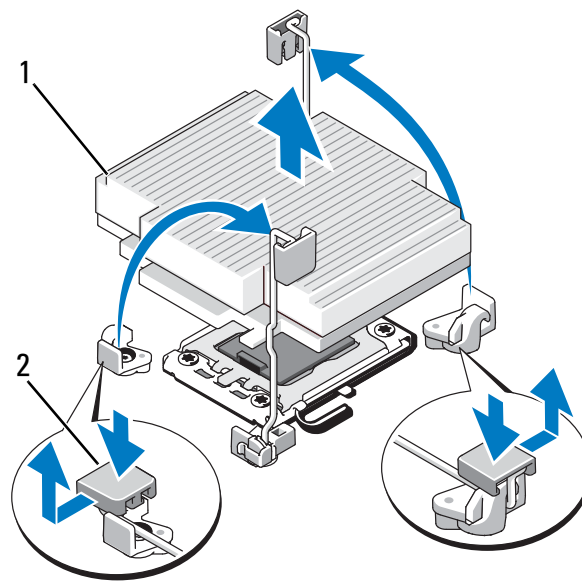

- | | | | |
|---|-----------|---|-------------------------------|
| 1 | heat sink | 2 | heat-sink retention latch (2) |
|---|-----------|---|-------------------------------|
- 5 Wait 30 seconds for the heat sink to loosen from the processor.
 - 6 Open the other heat-sink retention latch.

- 7 Gently lift the heat sink off of the processor and set the heat sink aside upside down (thermal grease side facing up).

 **CAUTION: The processor is held in its socket under strong pressure. Be aware that the release lever can spring up suddenly if not firmly grasped.**

- 8 Position your thumb firmly over the processor socket-release lever and release the lever from the locked position. Rotate the lever 90 degrees upward until the processor is released from the socket. See Figure 3-20.
- 9 Rotate the processor shield upward and out of the way. See Figure 3-20.
- 10 Lift the processor out of the socket and leave the release lever up so that the socket is ready for the new processor.

 **CAUTION: Be careful not to bend any of the pins on the ZIF socket when removing the processor. Bending the pins can permanently damage the system board.**

If you are permanently removing a processor from socket CPU2, you must install a processor blank and a heat-sink blank to ensure proper system cooling. Adding the blanks is similar to adding a processor. See "Installing a Processor."

 **NOTE:** In single-processor configurations, a processor must be installed in socket CPU1. Install the blanks in socket CPU2 only.

Figure 3-20. Installing and Removing a Processor



- | | | | |
|---|--------------------|---|----------------------|
| 1 | processor | 2 | processor shield |
| 3 | notch in processor | 4 | socket key |
| 5 | ZIF socket | 6 | socket-release lever |

Installing a Processor

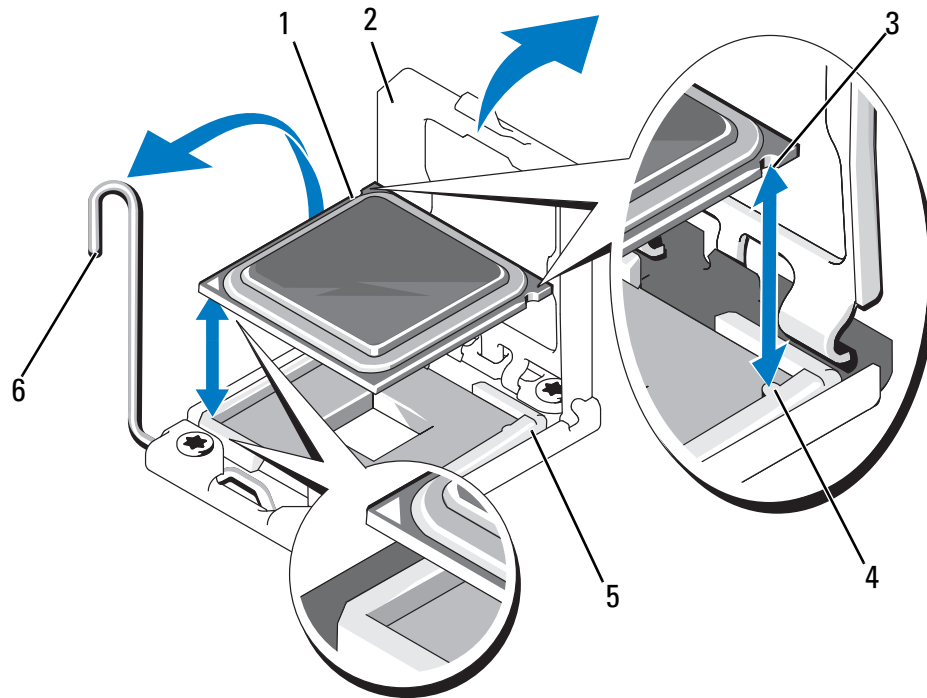
CAUTION: Many repairs may only be done by a certified service technician. You should only perform troubleshooting and simple repairs as authorized in your product documentation, or as directed by the online or telephone service and support team. Damage due to servicing that is not authorized by Dell is not covered by your warranty. Read and follow the safety instructions that came with the product.

- 1 If you are upgrading your processors, prior to upgrading your system, download and install the latest system BIOS version from support.dell.com. Follow the instructions included in the file download to install the update on your system.

NOTE: In single-processor configurations, socket CPU1 must be used.

- 2 If you are adding a second processor for the first time, remove the heatsink blank and the processor blank from the vacant processor socket. Removing the blanks is similar to removing a processor. See "Removing a Processor."
- 3 Unpack the processor if it has not been used previously.
If the processor has already been used, remove any thermal grease from the top of the processor using a lint-free cloth.
- 4 Align the processor with the socket keys on the ZIF socket. See Figure 3-20.
- 5 Install the processor in the socket.

 **CAUTION: Positioning the processor incorrectly can permanently damage the system board or the processor. Be careful not to bend the pins in the socket.**

- a With the release lever on the processor socket in the open position, align the processor with the socket keys and set the processor lightly in the socket.

 **CAUTION: Do not use force to seat the processor. When the processor is positioned correctly, it engages easily into the socket.**

- b Close the processor shield.
- c Rotate the socket release lever down until it snaps into place.

- 6 Install the heat sink.
 - a Using a clean lint-free cloth, remove any thermal grease from the heat sink.
 - b Open the grease packet included with the processor kit and apply a small amount (approximately 1.5 cm (.6 in) in diameter of thermal grease to the center of the top of the new processor.

 **CAUTION: Using excess thermal grease can cause grease to contact the processor shield, which can cause contamination of the processor socket.**

- c Place the heat sink on the processor. See Figure 3-20.
- d Close the two heat-sink retention latches. See Figure 3-20.

- 7 Close the system. See "Closing the System."
- 8 Press <F2> to enter the System Setup program, and check that the processor information matches the new system configuration. See "Entering the System Setup Program."

- 9 Run the system diagnostics to verify that the new processor operates correctly.

See "Running the System Diagnostics" for information about running the diagnostics.

System Battery

Replacing the System Battery



CAUTION: Many repairs may only be done by a certified service technician. You should only perform troubleshooting and simple repairs as authorized in your product documentation, or as directed by the online or telephone service and support team. Damage due to servicing that is not authorized by Dell is not covered by your warranty. Read and follow the safety instructions that came with the product.



WARNING: There is a danger of a new battery exploding if it is incorrectly installed. Replace the battery only with the same or equivalent type recommended by the manufacturer. See your safety information for additional info.

- 1 Turn off the system, including any attached peripherals, and disconnect the system from the electrical outlet.
- 2 Open the system. See "Opening the System."

Figure 3-21. Replacing the System Battery

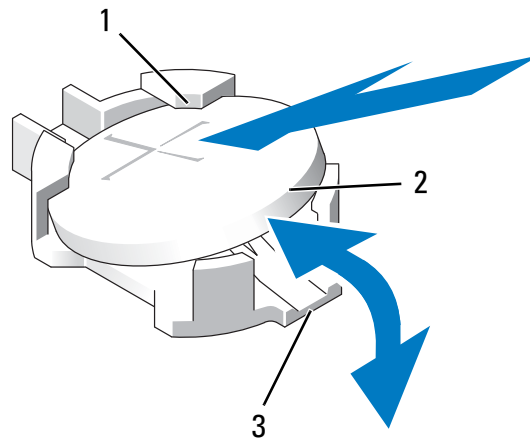

- 1 positive side of battery connector 2 system battery
3 negative side of battery connector

3 Locate the battery socket. See Figure 6-1.

△ CAUTION: To avoid damage to the battery connector, you must firmly support the connector while installing or removing a battery.

4 Remove the system battery.

- a** Support the battery connector by pressing down firmly on the positive side of the connector.
- b** Press the battery toward the positive side of the connector and lift it up out of the securing tabs at the negative side of the connector.

5 Install the new system battery.

- a** Support the battery connector by pressing down firmly on the positive side of the connector.
- b** Hold the battery with the "+" facing up, and slide it under the securing tabs at the positive side of the connector.
- c** Press the battery straight down into the connector until it snaps into place.

6 Close the system. See "Closing the System."

7 Reconnect the system to the electrical outlet and turn the system on, including any attached peripherals.

- 8 Enter the System Setup program to confirm that the battery is operating properly. See "Entering the System Setup Program."
- 9 Enter the correct time and date in the System Setup program's **Time** and **Date** fields, and configure the other settings for your system.
- 10 Exit the System Setup program.

Control Panel Assembly

 **NOTE:** The control panel assembly consists of two separate modules—the display module and the control panel circuit board. Use the following instructions to remove and install either module.

Removing the Control Panel Display Module

 **CAUTION:** Many repairs may only be done by a certified service technician. You should only perform troubleshooting and simple repairs as authorized in your product documentation, or as directed by the online or telephone service and support team. Damage due to servicing that is not authorized by Dell is not covered by your warranty. Read and follow the safety instructions that came with the product.

- 11 Turn off the system and attached peripherals, and disconnect the system from the electrical outlet and peripherals.
- 12 Open the system. See "Opening the System."
- 13 Disconnect the display module cable from the control panel board. See Figure 3-22.
- 14 Using a knife or a small flat-blade screwdriver, insert the blade beneath the front panel of the display and slide the blade across the bottom to lift the panel outward. See Figure 3-22.
- 15 Bend the panel upward to allow access to the mounting screws.

Figure 3-22. Control Panel Removal

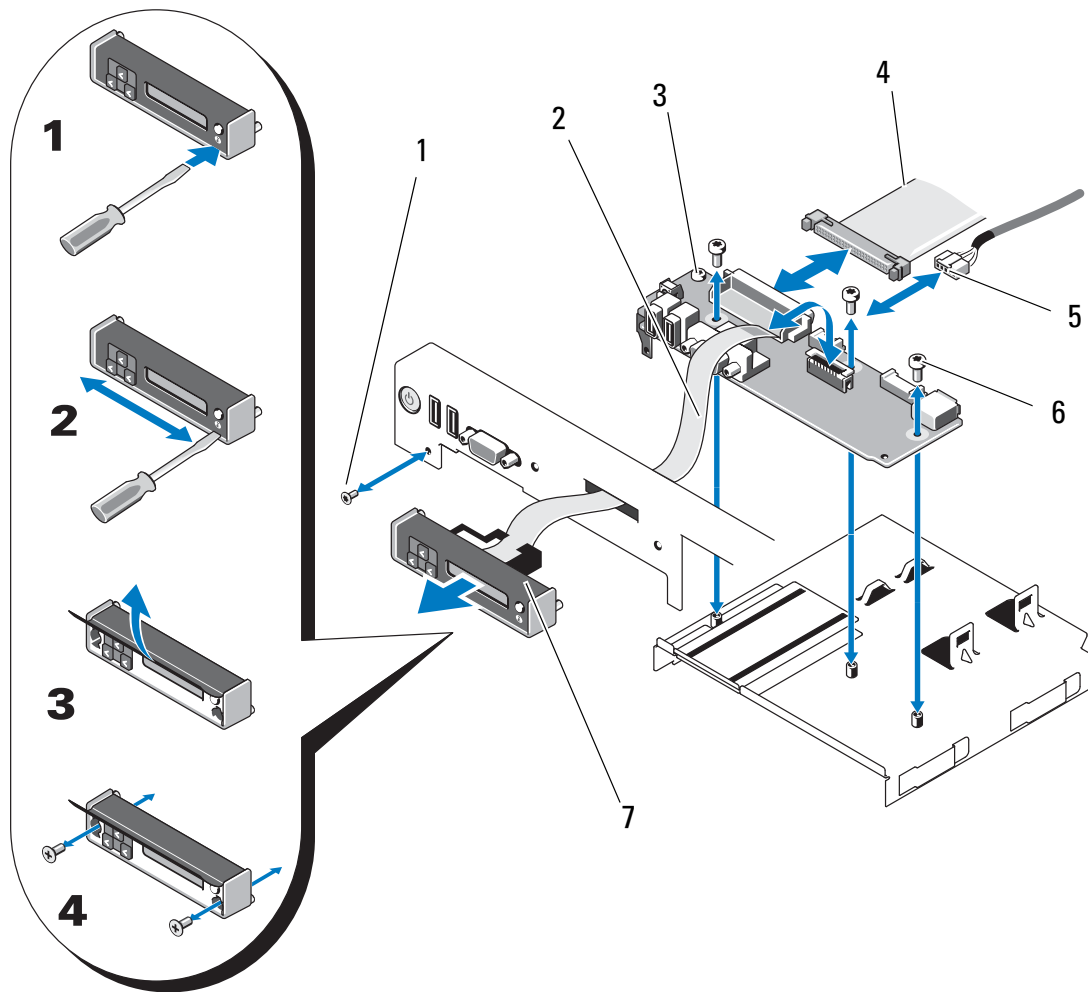

- | | | | |
|---|--------------------------|---|--------------------------|
| 1 | front panel screw (Torx) | 2 | display module cable |
| 3 | control panel board | 4 | control panel cable |
| 5 | USB cable | 6 | mounting screws (3 Torx) |
| 7 | display module | | |

- 16** Using a T10 Torx driver, remove the two screws that secure the display module to the system chassis.
- 17** Remove the display module from the chassis cutout.

Installing the Control Panel Display Module

- 1 Insert the display module into the chassis cutout and secure with the two Torx screws. See Figure 3-22.
- 2 Attach the replacement panel to the front of the display module.
- 3 Connect the display module cable to the control panel board.
- 4 Close the system. See "Closing the System."
- 5 Reconnect the system to the power source and turn on the system and attached peripherals.

Removing the Control Panel Board

 **CAUTION: Many repairs may only be done by a certified service technician. You should only perform troubleshooting and simple repairs as authorized in your product documentation, or as directed by the online or telephone service and support team. Damage due to servicing that is not authorized by Dell is not covered by your warranty. Read and follow the safety instructions that came with the product.**

- 1 Turn off the system and attached peripherals and disconnect the system from the electrical outlet and peripherals.
- 2 Open the system. See "Opening the System."
- 3 Disconnect the display module cable from the control panel board. See Figure 3-22.
- 4 Disconnect the control panel cable and USB cable from the control panel board. See Figure 3-22.
- 5 If applicable, disconnect the Internal SD Module cable and remove the USB key from the control panel module.

 **CAUTION: Do not pull on the cable to unseat the connector. Doing so can damage the cable.**

- 6 Using a T8 Torx driver, remove the screw on the front panel located beneath the left USB connector. See Figure 3-22.
- 7 Using a T10 Torx driver, remove the three screws that secure the control panel board to the system chassis and remove the board.

Installing the Control Panel Board

- 1 Install the front panel screw in the screw hole located beneath the left USB connector. See Figure 3-22.
- 2 Install the control panel board in the system chassis and secure with the three Torx screws. See Figure 3-22.
- 3 Connect the display module cable to the control panel board.
- 4 Connect the control panel cable and USB cable to the control panel board.
- 5 If applicable, reconnect the Internal SD Module cable to the control panel board, and install the USB key.
- 6 Close the system. See "Closing the System."
- 7 Reconnect the system to the power source and turn on the system and attached peripherals.

SAS Backplane

Removing the SAS Backplane

 **CAUTION:** Many repairs may only be done by a certified service technician. You should only perform troubleshooting and simple repairs as authorized in your product documentation, or as directed by the online or telephone service and support team. Damage due to servicing that is not authorized by Dell is not covered by your warranty. Read and follow the safety instructions that came with the product.

- 1 If applicable, remove the bezel. See "Removing the Front Bezel."
- 2 Turn off the system and attached peripherals, and disconnect the system from the electrical outlet.
- 3 Open the system. See "Opening the System."

 **CAUTION:** To prevent damage to the drives and backplane, you must remove the hard drives from the system before removing the backplane.

 **CAUTION:** You must note the number of each hard drive and temporarily label them before removal so that you can replace them in the same locations.

- 4 Remove all hard drives. See "Removing a Hot-Swap Hard Drive."

 **NOTE:** You may find it easier to remove the SAS backplane if you remove the fan assembly first. See "Removing a Cooling Fan."

- 5** Disconnect the power cable from the end of the SAS backplane.
- 6** Disconnect the SAS data cables from the backplane.
- 7** Remove the SAS backplane from the system:
 - a** While pulling the two blue latches towards the front of the system, slide the backplane upward. See Figure 3-23.
 - b** When the backplane cannot slide upward any farther, pull the backplane toward the back of the system to remove it from the retention hooks.
 - c** Lift the board out of the system, being careful to avoid damaging components on the face of the board.
 - d** Place the SAS backplane face down on a work surface.

Figure 3-23. Removing and Installing a SAS Backplane

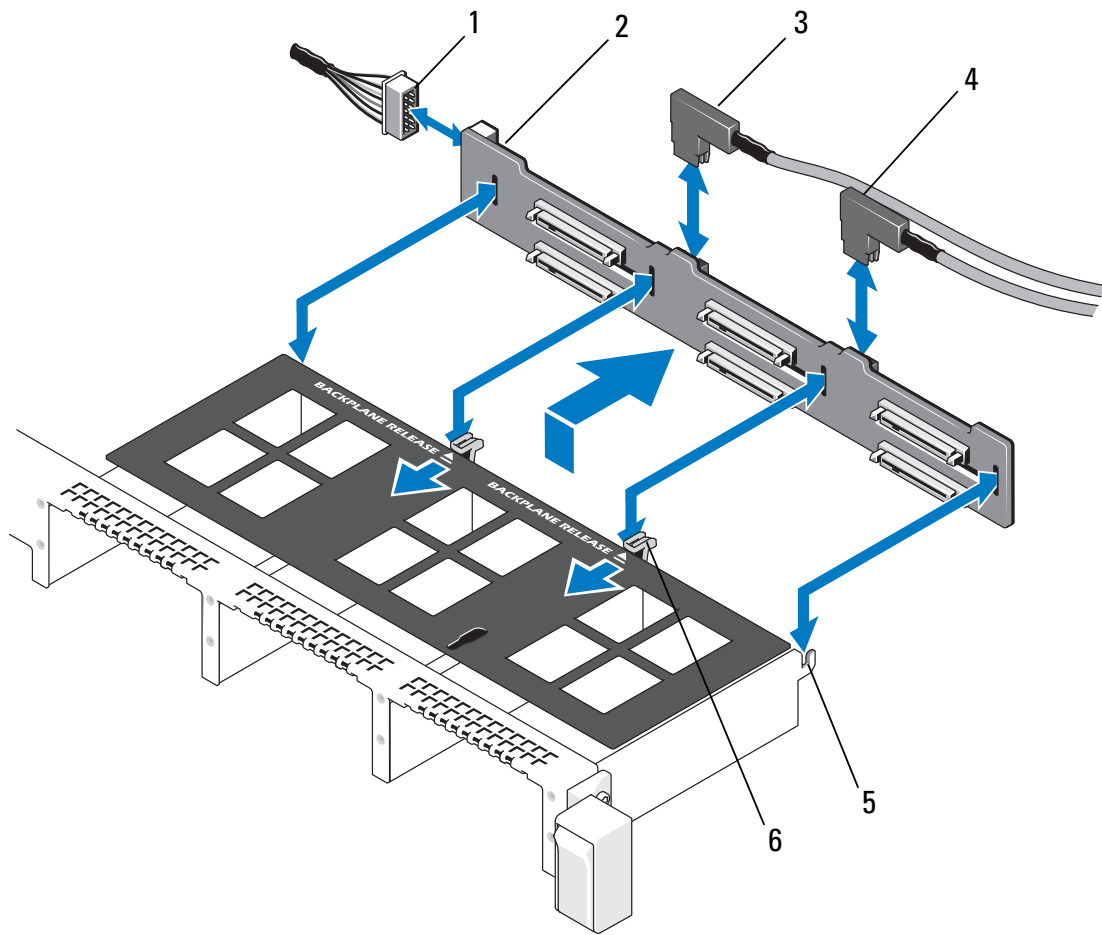

- | | | | |
|---|---------------------------|---|---------------------------------|
| 1 | SAS backplane power cable | 2 | SAS backplane |
| 3 | SAS A cable | 4 | SAS B cable |
| 5 | retention hooks (2) | 6 | backplane retention latches (2) |

Installing a SAS Backplane

- 1 Install the SAS backplane:
 - a Lower the backplane into the system, being careful to avoid damaging components on the face of the board.
 - b Align the slots in the backplane with the retention hooks on the back of the drive bays, then move the backplane forward until the retention hooks fit through the slots in the backplane. See Figure 3-23.
 - c Slide the backplane downward until the two blue retention latches snap into place.
- 2 Connect the SAS data and power cables to the SAS backplane.
- 3 If you removed the fan assembly to improve access to the SAS backplane, replace the fan assembly now. See "Replacing a Cooling Fan."
- 4 Install the hard drives in their original locations.
- 5 Close the system. See "Closing the System."
- 6 Reconnect the system to its electrical outlet and turn the system on, including any attached peripherals.

System Board

Removing the System Board

 **CAUTION:** Many repairs may only be done by a certified service technician. You should only perform troubleshooting and simple repairs as authorized in your product documentation, or as directed by the online or telephone service and support team. Damage due to servicing that is not authorized by Dell is not covered by your warranty. Read and follow the safety instructions that came with the product.

 **CAUTION:** If you are using the Trusted Program Module (TPM) with an encryption key, you may be prompted to create a recovery key during program or system setup. Be sure to create and safely store this recovery key. If you replace this system board, you must supply the recovery key when you restart your system or program before you can access the encrypted data on your hard drives.

- 1 Turn off the system and attached peripherals, and disconnect the system from the electrical outlet.
- 2 Open the system. See "Opening the System."

- 3 Remove the power supply(s). See "Removing a Power Supply."
- 4 Remove all expansion cards and the integrated storage controller card. See "Removing an Expansion Card" and "Removing the Integrated Storage Controller Card."
- 5 Remove the two expansion-card risers. See "Removing an Expansion-Card Riser."
- 6 If installed, remove the iDRAC6 Enterprise card. See "Removing an iDRAC6 Enterprise Card."
- 7 If installed, remove the NIC hardware key from the system board. See "NIC Hardware Key."
- 8 Disconnect and remove the fan assembly. See "Cooling Fans."
- 9 Disconnect all cables from the system board.
- 10 Remove the system board assembly:
 - a Pull up the spring-loaded blue retention pin located in the center of the system board, and then slide the system board assembly toward the front end of the chassis.



CAUTION: Do not lift the system board assembly by grasping a memory module, processor, or other components.

- b Grasp the system board assembly by the blue and black storage card guides, or the edges of the system board tray, and lift the assembly from the chassis. See Figure 3-24.

Figure 3-24. Removing and Installing the System Board

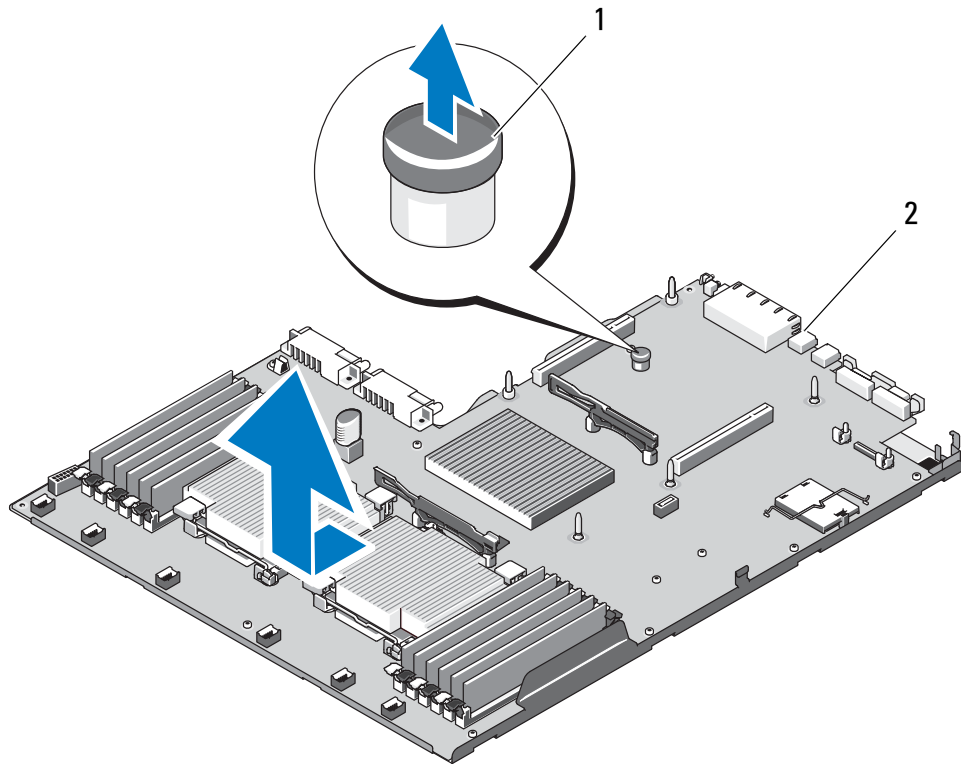

1 retention pin

2 system board assembly

Installing the System Board

- 1 Unpack the new system board and remove the label placard that is inserted in the memory module socket.
- 2 Remove the labels from the placard and affix them to the system information panel on the front of the system. See Figure 1-1.
- 3 Transfer the processors and heat sinks to the new system board. See "Removing a Processor" and "Installing a Processor."
- 4 Remove the memory modules and transfer them to the same locations on the new board. See "Removing Memory Modules" and "Installing Memory Modules."
- 5 Install the new system board:
 - a Holding the system board by the edges of the system board tray, lower the right side of the system board into the chassis.



CAUTION: Do not lift the system board assembly by grasping a memory module, processor, or other components.

- b Slowly lower the left side of the system board into the chassis.
 - c Slightly lift up the front of the system board and maneuver the system board to the bottom of the chassis until it lays completely flat.
 - d Ensure that all retention hooks on the bottom of the chassis are inserted into the retention slots on the system board. See Figure 3-24.
 - e Push the system board toward the back of the chassis until the blue retention pin snaps into place.
- 6 Transfer the NIC hardware key. See "NIC Hardware Key."
- 7 Connect the cables in the order listed below (see Figure 6-1 for the locations of the connectors on the system board):
 - SATA interface cable, if applicable
 - Control panel interface cable connector
 - Optical drive power cable connector
 - Control panel USB interface cable connector
 - SAS backplane power cable connector
- 8 Replace the expansion-card risers. See "Replacing an Expansion-Card Riser."

- 9** Install all expansion cards. See "Installing an Expansion Card."
- 10** Reinstall the integrated storage controller card. See "Installing the Integrated Storage Controller Card."
After connecting the SAS cables to the controller, make sure to place the cables under the guide on the end of riser 1.
- 11** If applicable, reconnect the RAID battery cable to the PERC controller card.
- 12** If applicable, reinstall the iDRAC6 Enterprise card. See "Installing an iDRAC6 Enterprise Card."
- 13** Replace the fan assembly. See "Cooling Fans."
- 14** Close the system. See "Closing the System."
- 15** Reconnect the system to its electrical outlet and turn the system on, including any attached peripherals.
- 16** Replace the bezel. See "Removing and Replacing the Optional Front Bezel."

Troubleshooting Your System

Safety First—For You and Your System

 **CAUTION:** Many repairs may only be done by a certified service technician. You should only perform troubleshooting and simple repairs as authorized in your product documentation, or as directed by the online or telephone service and support team. Damage due to servicing that is not authorized by Dell is not covered by your warranty. Read and follow the safety instructions that came with the product.

Troubleshooting System Startup Failure

If your system halts during startup prior to video imaging or LCD messaging, especially after installing an operating system or reconfiguring your system's hardware, check for the following conditions.

- If you boot the system to the BIOS boot mode after installing an operating system from the UEFI Boot Manager, the system will hang. The reverse is also true. You must boot to the same boot mode in which you installed the operating system. See "Using the System Setup Program and UEFI Boot Manager."
- Invalid memory configurations could cause the system to halt at startup without any video output. See "System Memory."

For all other startup issues, note the LCD panel messages and any system messages that appear onscreen. See "LCD Status Messages" and "System Messages" for more information.

Troubleshooting External Connections

Ensure that all external cables are securely attached to the external connectors on your system before troubleshooting any external devices. See Figure 1-1 and Figure 1-4 for the front- and back-panel connectors on your system.

Troubleshooting the Video Subsystem

- 1 Check the system and power connections to the monitor.
- 2 Check the video interface cabling from the system to the monitor.
- 3 If two monitors are attached to the system, disconnect one monitor. The system supports only one monitor attached to either the front or rear video connector.
- 4 Try using a monitor that is known to be working.
- 5 Run the appropriate online diagnostic test. See "Running the System Diagnostics."

If the tests run successfully, the problem is not related to video hardware.

If the tests fail, see "Getting Help."

Troubleshooting a USB Device

- 1 Use the following steps to troubleshoot a USB keyboard and/or mouse. For other USB devices, go to step 2.
 - a Disconnect the keyboard and mouse cables from the system briefly and reconnect them.
 - b Connect the keyboard/mouse to the USB port(s) on the opposite side of the system.

If the problem is resolved, restart the system, enter the System Setup program, and check if the nonfunctioning USB ports are enabled.
 - c Replace the keyboard/mouse with another working keyboard/mouse.

If the problem is resolved, replace the faulty keyboard/mouse.

If the problem is not resolved, proceed to the next step to begin troubleshooting the other USB devices attached to the system.
- 2 Power down all attached USB devices and disconnect them from the system.
- 3 Reconnect and power on each USB device one at a time.

- 4 If a device causes the same problem, power down the device, replace the USB cable if applicable, and power up the device.
If the problem persists, replace the device.
If all troubleshooting fails, see "Getting Help."

Troubleshooting a Serial I/O Device

- 1 Turn off the system, including any attached peripherals, and disconnect the system from the electrical outlet.
- 2 Swap the serial interface cable with a working cable, and turn on the system and the serial device.
If the problem is resolved, replace the interface cable.
- 3 Turn off the system and the serial device, and swap the device with a comparable device.
- 4 Turn on the system and the serial device.
If the problem is resolved, replace the serial device.
If the problem persists, see "Getting Help."

Troubleshooting a NIC

- 1 Run the appropriate online diagnostic test. See "Running the System Diagnostics."
- 2 Restart the system and check for any system messages pertaining to the NIC controller.
- 3 Check the appropriate indicator on the NIC connector. See "NIC Indicator Codes."
 - If the link indicator does not light, check all cable connections.
 - If the activity indicator does not light, the network driver files might be damaged or missing.
 - Enable autonegotiation.
 - Use another connector on the switch or hub.If you are using a NIC card instead of an embedded NIC, see the documentation for the NIC card.

- 4 Ensure that the appropriate drivers are installed and the protocols are bound. See the NIC's documentation.
- 5 Enter the System Setup program and confirm that the NIC ports are enabled. See "Integrated Devices Screen."
- 6 Ensure that the NICs, hubs, and switches on the network are all set to the same data transmission speed and duplex. See the documentation for each network device.
- 7 Ensure that all network cables are of the proper type and do not exceed the maximum length.

If all troubleshooting fails, see "Getting Help."

Troubleshooting a Wet System

 **CAUTION:** Many repairs may only be done by a certified service technician. You should only perform troubleshooting and simple repairs as authorized in your product documentation, or as directed by the online or telephone service and support team. Damage due to servicing that is not authorized by Dell is not covered by your warranty. Read and follow the safety instructions that came with the product.

- 1 Turn off the system and attached peripherals, and disconnect the system from the electrical outlet.
- 2 Open the system. See "Opening the System."
- 3 Disassemble components from the system. See "Installing System Components."
 - Hard drives
 - SD cards
 - USB memory key
 - NIC hardware key
 - Internal SD Module
 - Expansion cards and both expansion-card risers
 - Integrated storage controller
 - iDRAC6 Enterprise card
 - Power supplies

- Fan assembly
 - Processors and heat sinks
 - Memory modules
- 4 Let the system dry thoroughly for at least 24 hours.
 - 5 Reinstall the processors and heat sinks, memory modules, power supplies, and fan assembly. See "Installing System Components."
 - 6 Close the system. See "Closing the System."
 - 7 Reconnect the system to the electrical outlet, and turn on the system and attached peripherals.
If the system does not start properly, see "Getting Help."
 - 8 If the system starts properly, shut down the system and reinstall all of the remaining components that you removed. See "Installing an Expansion Card."
 - 9 Run the appropriate online diagnostic test. See "Running the System Diagnostics."
If the tests fail, see "Getting Help."

Troubleshooting a Damaged System



CAUTION: Many repairs may only be done by a certified service technician. You should only perform troubleshooting and simple repairs as authorized in your product documentation, or as directed by the online or telephone service and support team. Damage due to servicing that is not authorized by Dell is not covered by your warranty. Read and follow the safety instructions that came with the product.

- 1 Turn off the system and attached peripherals, and disconnect the system from the electrical outlet.
- 2 Open the system. See "Opening the System."
- 3 Ensure that the following components are properly installed:
 - Expansion cards and both expansion-card risers
 - Power supplies
 - Fans
 - Processors and heat sinks

- Memory modules
 - Hard-drive carriers
- 4 Ensure that all cables are properly connected.
 - 5 Close the system. See "Closing the System."
 - 6 Run the system board tests in the system diagnostics. See "Running the System Diagnostics."
- If the tests fail, see "Getting Help."

Troubleshooting the System Battery

- 1 Re-enter the time and date through the System Setup program. See "Using the System Setup Program and UEFI Boot Manager."
- 2 Turn off the system and disconnect it from the electrical outlet for at least one hour.
- 3 Reconnect the system to the electrical outlet and turn on the system.
- 4 Enter the System Setup program.

If the date and time are not correct in the System Setup program, replace the battery. See "Replacing the System Battery."

 **CAUTION: Many repairs may only be done by a certified service technician. You should only perform troubleshooting and simple repairs as authorized in your product documentation, or as directed by the online or telephone service and support team. Damage due to servicing that is not authorized by Dell is not covered by your warranty. Read and follow the safety instructions that came with the product.**

If the problem is not resolved by replacing the battery, see "Getting Help."

Troubleshooting Power Supplies

 **CAUTION: At least one power supply must be installed for the system to operate. Operating the system with only one power supply installed for extended periods of time without a power-supply blank installed in the PS2 power-supply bay can cause the system to overheat.**

- 1 Identify the faulty power supply by the power supply's status indicator. See "Power Indicator Codes."

 **CAUTION:** If troubleshooting a PSU mismatch error, replace only the power supply with the flashing indicator. Swapping the opposite power supply to create a matched pair can result in an error condition and unexpected system shutdown. To change from a High Output configuration to an Energy Smart configuration or vice versa, you must power down the system.

- 2 Reseat the power supply by removing and reinstalling it. See "Power Supplies."

 **NOTE:** After installing a power supply, allow several seconds for the system to recognize the power supply and to determine if it is working properly. The status indicator turns green to signify that the power supply is functioning properly.

If the problem persists, replace the faulty power supply with another power supply of the same type.

- 3 If the problem persists, see "Getting Help."

Troubleshooting System Cooling Problems

 **CAUTION:** Many repairs may only be done by a certified service technician. You should only perform troubleshooting and simple repairs as authorized in your product documentation, or as directed by the online or telephone service and support team. Damage due to servicing that is not authorized by Dell is not covered by your warranty. Read and follow the safety instructions that came with the product.

Ensure that none of the following conditions exist:

- Ensure that none of the following parts are missing: system cover, drive blank, FAN6 blank (in a system with a single processor), power supply blank (in a system with a single power supply), heat sink blank (in single processor configurations), or front or back filler panel.
- Ambient temperature is too high.
- External airflow is obstructed.
- Cables inside the system obstruct airflow.
- An individual cooling fan is removed or has failed. See "Troubleshooting a Fan."
- The expansion card installation restrictions have not been observed. See "Expansion Card Installation Guidelines."

Troubleshooting a Fan

 **CAUTION:** Many repairs may only be done by a certified service technician. You should only perform troubleshooting and simple repairs as authorized in your product documentation, or as directed by the online or telephone service and support team. Damage due to servicing that is not authorized by Dell is not covered by your warranty. Read and follow the safety instructions that came with the product.

- 1 Locate the faulty fan indicated by the LCD panel or the diagnostic software.
- 2 Turn off the system and attached peripherals, and disconnect the system from the electrical outlet.
- 3 Open the system. See "Opening the System."
- 4 Reseat the fan's power cable.
- 5 Close the system and restart it.
- 6 If the fan does not function, turn off the system and install a new fan. See "Cooling Fans."
- 7 Restart the system.

If the replacement fan does not operate, see "Getting Help."

Troubleshooting System Memory

 **CAUTION:** Many repairs may only be done by a certified service technician. You should only perform troubleshooting and simple repairs as authorized in your product documentation, or as directed by the online or telephone service and support team. Damage due to servicing that is not authorized by Dell is not covered by your warranty. Read and follow the safety instructions that came with the product.

- 1 If the system is operational, run the appropriate online diagnostic test. See "Running the System Diagnostics."
If the diagnostics indicates a fault, follow the corrective actions provided by the diagnostic program.
- 2 If the system is not operational, turn off the system and attached peripherals, and unplug the system from the power source. Wait at least 10 seconds and then reconnect the system to power.

- 3** Turn on the system and attached peripherals and note any messages on the screen or LCD panel.
Go to step 12 if an error message appears indicating a fault with a specific memory module.
- 4** Enter the System Setup program and check the system memory setting. See "Memory Settings Screen." Make any changes to the memory settings, if needed.
If the memory settings match the installed memory but a problem is still indicated, go to step 12.
- 5** Turn off the system and attached peripherals, and disconnect the system from the electrical outlet.
- 6** Open the system. See "Opening the System."
- 7** Check the memory channels and ensure that they are populated correctly. See "General Memory Module Installation Guidelines."
- 8** Reseat the memory modules in their sockets. See "Installing Memory Modules."
- 9** Close the system. See "Closing the System."
- 10** Reconnect the system to its electrical outlet, and turn on the system and attached peripherals.
- 11** Enter the System Setup program and check the system memory setting. See "Memory Settings Screen."
If the problem is not resolved, proceed with the next step.
- 12** Turn off the system and attached peripherals, and disconnect the system from the power source.
- 13** Open the system. See "Opening the System."
- 14** If a diagnostic test or error message indicates a specific memory module as faulty, swap or replace the module.
- 15** To troubleshoot an unspecified faulty memory module, replace the memory module in the first DIMM socket with a module of the same type and capacity. See "Installing Memory Modules."
- 16** Close the system. See "Closing the System."

- 17 Reconnect the system to its electrical outlet, and turn on the system and attached peripherals.
- 18 As the system boots, observe any error message that appears on the screen or the LCD panel on the front of the system.
- 19 If the memory problem is still indicated, repeat step 12 through step 18 for each memory module installed.

If the problem persists after all memory modules have been checked, see "Getting Help."

Troubleshooting an Internal SD Card

 **CAUTION:** Many repairs may only be done by a certified service technician. You should only perform troubleshooting and simple repairs as authorized in your product documentation, or as directed by the online or telephone service and support team. Damage due to servicing that is not authorized by Dell is not covered by your warranty. Read and follow the safety instructions that came with the product.

- 1 Enter the System Setup program and ensure that the internal SD card port is enabled. See "Integrated Devices Screen."
- 2 Turn off the system, including any attached peripherals, and disconnect the system from the electrical outlet.
- 3 Open the system. See "Opening the System."
- 4 Locate the SD card and reseal it. See "Removing an Internal SD Flash Card" and "Installing an Internal SD Flash Card."
- 5 Reseat the Internal SD module cable. See "Installing the Internal SD Module."
- 6 Check that the cable leading from the internal SD module to the control panel is installed correctly. See "Installing the Internal SD Module."
- 7 Close the system. See "Closing the System."
- 8 Turn on the system and attached peripherals and check if the SD card is functioning.
- 9 If the problem is not resolved, repeat step 2 and step 3.
- 10 Insert a different SD card that you know works properly.
- 11 Close the system. See "Closing the System."

- 12 Turn on the system and attached peripherals and check if the SD card is functioning.

If the problem is not resolved, see "Getting Help."

Troubleshooting an Internal USB Key

 **CAUTION: Many repairs may only be done by a certified service technician. You should only perform troubleshooting and simple repairs as authorized in your product documentation, or as directed by the online or telephone service and support team. Damage due to servicing that is not authorized by Dell is not covered by your warranty. Read and follow the safety instructions that came with the product.**

- 1 Enter the System Setup program and ensure that the USB port is enabled. See "Integrated Devices Screen."
- 2 Turn off the system, including any attached peripherals, and disconnect the system from the electrical outlet.
- 3 Open the system. See "Opening the System."
- 4 Locate the internal USB key and reseal it. See "Internal USB Memory Key."
- 5 Close the system. See "Closing the System."
- 6 Turn on the system and attached peripherals and check if the USB key is functioning.
- 7 Repeat step 2 and step 3.
- 8 Insert a different USB key that you know works properly.
- 9 Close the system. See "Closing the System."
- 10 Turn on the system and attached peripherals and check if the USB key is functioning.

If the problem is not resolved, see "Getting Help."

Troubleshooting an Optical Drive

 **CAUTION: Many repairs may only be done by a certified service technician. You should only perform troubleshooting and simple repairs as authorized in your product documentation, or as directed by the online or telephone service and**

support team. Damage due to servicing that is not authorized by Dell is not covered by your warranty. Read and follow the safety instructions that came with the product.

- 1 If applicable, remove the bezel. See "Removing the Front Bezel."
- 2 Try using a different DVD.
- 3 Ensure that the device drivers for the optical drive are installed and are configured correctly
- 4 Enter the System Setup program and ensure that the integrated SATA controller and the drive's SATA port are enabled. See "Using the System Setup Program and UEFI Boot Manager."
- 5 Run the appropriate online diagnostic test. See "Running the System Diagnostics."
- 6 Turn off the system and attached peripherals, and disconnect the system from the electrical outlet.
- 7 Open the system. See "Opening the System."
- 8 Ensure that the interface/power cable is securely connected to the optical drive and to the system board.
- 9 Ensure that the power cable is properly connected to the drive.
- 10 Close the system. See "Closing the System."
- 11 Reconnect the system to the electrical outlet, and turn on the system and attached peripherals.

If the problem is not resolved, see "Getting Help."

Troubleshooting Hard Drives

 **CAUTION: Many repairs may only be done by a certified service technician. You should only perform troubleshooting and simple repairs as authorized in your product documentation, or as directed by the online or telephone service and support team. Damage due to servicing that is not authorized by Dell is not covered by your warranty. Read and follow the safety instructions that came with the product.**

 **CAUTION: This troubleshooting procedure can destroy data stored on the hard drive. Before you proceed, back up all files on the hard drive.**

- 1 Run the appropriate online diagnostic test. See "Running the System Diagnostics."

Depending on the results of the diagnostics test, proceed as needed through the following steps.

- 2** If applicable, remove the bezel. See "Removing the Front Bezel."
- 3** If your system has a SAS or PERC controller and your hard drives are configured in a RAID array, perform the following steps.
 - a** Restart the system and enter the host adapter configuration utility program by pressing <Ctrl><R> for a PERC controller or <Ctrl><C> for a SAS controller card.

See the documentation supplied with the host adapter for information about the configuration utility.
 - b** Ensure that the hard drive(s) have been configured correctly for the RAID array.
 - c** Take the hard drive offline and then reseal the hard drive. See "Removing a Hot-Swap Hard Drive."
 - d** Exit the configuration utility and allow the system to boot to the operating system.
- 4** Ensure that the required device drivers for your controller card are installed and are configured correctly. See the operating system documentation for more information.
- 5** Restart the system, enter the System Setup program, and verify that the controller is enabled and the drives appear in the System Setup program. See "Using the System Setup Program and UEFI Boot Manager."

If the problem persists, see "Troubleshooting a SAS Controller."

Troubleshooting a SAS Controller

-  **NOTE:** When troubleshooting a SAS or SAS RAID controller, also see the documentation for your operating system and the controller.
- 1** Run the appropriate online diagnostic test. See "Running the System Diagnostics."
 - 2** Enter the System Setup program and ensure that the SAS or PERC controller is enabled. See "Using the System Setup Program."

3 Restart the system and press the applicable key sequence to enter the configuration utility program:

- <Ctrl><C> for a SAS controller
- <Ctrl><R> for a PERC controller

See the controller's documentation for information about configuration settings.

4 Check the configuration settings, make any necessary corrections, and restart the system.

 **CAUTION: Many repairs may only be done by a certified service technician. You should only perform troubleshooting and simple repairs as authorized in your product documentation, or as directed by the online or telephone service and support team. Damage due to servicing that is not authorized by Dell is not covered by your warranty. Read and follow the safety instructions that came with the product.**

5 Turn off the system and attached peripherals, and disconnect the system from its electrical outlet.

6 Open the system. See "Opening the System."

7 Ensure that the controller card is firmly seated into the expansion card connector. See "Installing the Integrated Storage Controller Card."

8 If you have a battery-cached PERC controller, ensure that the RAID battery is properly connected and, if applicable, the memory module on the PERC card is properly seated.

9 Verify that the cable connections between the SAS backplane and the integrated storage controller are correct. See "Installing a SAS Backplane."

10 Ensure that the cables are firmly connected to the SAS controller and the backplane board.

11 Close the system. See "Closing the System."

12 Reconnect the system to its electrical outlet, and turn on the system and attached peripherals.

If the problem persists, see "Getting Help."

Troubleshooting an External Tape Drive

1 Try using a different tape cartridge.

- 2 Ensure that the device drivers for the tape drive are installed and are configured correctly. See your tape drive documentation for more information about device drivers.
- 3 Reinstall the tape-backup software as instructed in the tape-backup software documentation.
- 4 Ensure that the tape drive's interface cable is fully connected to the tape drive and the external port on the controller card.
- 5 Run the appropriate online diagnostics tests. See "Running the System Diagnostics."
- 6 Turn off the system and attached peripherals, and disconnect the system from the electrical outlet.

 **CAUTION: Many repairs may only be done by a certified service technician. You should only perform troubleshooting and simple repairs as authorized in your product documentation, or as directed by the online or telephone service and support team. Damage due to servicing that is not authorized by Dell is not covered by your warranty. Read and follow the safety instructions that came with the product.**

- 7 Open the system. See "Opening the System."
- 8 Reseat the controller card in the expansion card slot.
- 9 Close the system. See "Closing the System."
- 10 Reconnect the system to the electrical outlet, and turn on the system, including attached peripherals.

If the problem is not resolved, see the documentation for the tape drive for additional troubleshooting instructions.

If you cannot resolve the problem, see "Getting Help."

Troubleshooting Expansion Cards

 **CAUTION: Many repairs may only be done by a certified service technician. You should only perform troubleshooting and simple repairs as authorized in your product documentation, or as directed by the online or telephone service and support team. Damage due to servicing that is not authorized by Dell is not covered by your warranty. Read and follow the safety instructions that came with the product.**



NOTE: When troubleshooting an expansion card, see the documentation for your operating system and the expansion card.

- 1** Run the appropriate online diagnostic test. See "Running the System Diagnostics."
- 2** Turn off the system and attached peripherals, and disconnect the system from the electrical outlet.
- 3** Open the system. See "Opening the System."
- 4** Verify that the installed expansion cards meet the installation guidelines in Table 3-1.
- 5** Ensure that each expansion-card riser is firmly seated in its connector. See "Replacing an Expansion-Card Riser."
- 6** Ensure that each expansion card is firmly seated in its connector. See "Installing an Expansion Card."
- 7** Close the system. See "Closing the System."
- 8** Reconnect the system to the electrical outlet, and turn on the system and attached peripherals.
- 9** Turn off the system and attached peripherals, and disconnect the system from the electrical outlet.
- 10** Open the system. See "Opening the System."
- 11** Remove all expansion cards installed in the system. See "Removing an Expansion Card."
- 12** Close the system. See "Closing the System."
- 13** Reconnect the system to the electrical outlet, and turn on the system and attached peripherals.
- 14** Run the appropriate online diagnostic test.
If the tests fail, see "Getting Help."
- 15** For each expansion card you removed in step 11, perform the following steps:
 - a** Turn off the system and attached peripherals, and disconnect the system from the electrical outlet.
 - b** Open the system. See "Opening the System."
 - c** Reinstall one of the expansion cards.

- d Close the system. See "Closing the System."
- e Run the appropriate diagnostic test.
If the tests fail, see "Getting Help."

Troubleshooting the Processors

 **CAUTION: Many repairs may only be done by a certified service technician. You should only perform troubleshooting and simple repairs as authorized in your product documentation, or as directed by the online or telephone service and support team. Damage due to servicing that is not authorized by Dell is not covered by your warranty. Read and follow the safety instructions that came with the product.**

- 1 Run the appropriate online diagnostics test. See "Running the System Diagnostics."
- 2 Turn off the system and attached peripherals, and disconnect the system from the electrical outlet.
- 3 Open the system. See "Opening the System."
- 4 Ensure that each processor and heat sink are properly installed. See "Removing a Processor."

 **CAUTION: Be careful not to bend any of the pins on the ZIF socket when removing a processor. Bending the pins can permanently damage the system board.**

- 5 Close the system. See "Closing the System."
- 6 Reconnect the system to the electrical outlet, and turn on the system and attached peripherals.
- 7 Run the appropriate online diagnostic test.
If your system only has one processor and a problem is still indicated, see "Getting Help."
- 8 For systems with multiple processors, turn off the system and attached peripherals, and disconnect the system from the electrical outlet.
- 9 Open the system. See "Closing the System."
- 10 Remove processor 2. See "Removing a Processor."
- 11 Close the system. See "Closing the System."

- 12** Reconnect the system to the electrical outlet, and turn on the system and attached peripherals.
- 13** Run the appropriate online diagnostic test.
If the test fails, the processor is faulty. See "Getting Help."
- 14** Turn off the system and attached peripherals, and disconnect the system from the electrical outlet.
- 15** Open the system. See "Closing the System."
- 16** Replace the processor with the processor you removed in step 10. See "Installing a Processor."
- 17** Repeat step 11 through step 13.
If the problem persists, the system board is faulty. See "Getting Help."

Running the System Diagnostics

If you experience a problem with your system, run the diagnostics before calling for technical assistance. The purpose of the diagnostics is to test your system's hardware without requiring additional equipment or risking data loss. If you are unable to fix the problem yourself, service and support personnel can use diagnostics test results to help you solve the problem.

Using Dell™ PowerEdge™ Diagnostics

To assess a system problem, first use the online Dell PowerEdge Diagnostics. Dell PowerEdge Diagnostics is a suite of diagnostic programs, or test modules, that include diagnostic tests on chassis and storage components such as hard drives, physical memory, communications ports, NICs, CMOS, and more. If you are unable to identify the problem using the PowerEdge Diagnostics, use the system diagnostics described in the remainder of this section. The system diagnostics program is run from the iDRAC6 Express System Services menu.

The files required to run PowerEdge Diagnostics for systems running supported Microsoft® Windows® and Linux operating systems are available at support.dell.com and on the CDs that came with your system. For information about using diagnostics, see the *Dell Online PowerEdge Diagnostics User's Guide*.

System Diagnostics Features

The system diagnostics provides a series of menus and options for particular device groups or devices. The system diagnostics menus and options allow you to:

- Run tests individually or collectively.
- Control the sequence of tests.
- Repeat tests.
- Display, print, or save test results.

- Temporarily suspend testing if an error is detected or terminate testing when a user-defined error limit is reached.
- View help messages that briefly describe each test and its parameters.
- View status messages that inform you if tests are completed successfully.
- View error messages that inform you of problems encountered during testing.

When to Use the System Diagnostics

If a major component or device in the system does not operate properly, component failure may be indicated. As long as the microprocessor and the system's input/output devices are functioning, you can use the system diagnostics to help identify the problem.

Running the System Diagnostics

The system diagnostics program is run from the iDRAC6 Express System Services menu.



CAUTION: Use the system diagnostics to test only your system. Using this program with other systems may cause invalid results or error messages.

- 1** As the system boots, press <F10>.
- 2** Select **Diagnostics** from the System Services menu.
- 3** Select **Launch Diagnostics**.
- 4** From the **Diagnostics** main menu, select **Run Diags**, or select **MpMemory** if you are troubleshooting memory.

The **Diagnostics** menu allows you to run all or specific diagnostics tests or to exit.

System Diagnostics Testing Options

Click the testing option in the **Main Menu** window.

Testing Option	Function
Express Test	Performs a quick check of the system. This option runs device tests that do not require user interaction.
Extended Test	Performs a more thorough check of the system. This test can take an hour or longer.
Custom Test	Tests a particular device.
Information	Displays test results.

Using the Custom Test Options

When you select **Custom Test** in the **Main Menu** window, the **Customize** window allows you to select the device(s) to be tested, select specific options for testing, and view the test results.

Selecting Devices for Testing

The left side of the **Customize** window lists devices that can be tested. Click the (+) next to a device or module to view its components. Click (+) on any component to view the tests that are available. Clicking a device, rather than its components, selects all of the components of the device for testing. If an item is grayed-out and you wish to run that test, you can select it by highlighting the item and pressing the spacebar.



NOTE: After you select all the devices and components that you want to test, highlight **All Devices** and then click **Run Tests**.

Selecting Diagnostics Options

From the **Diagnostics Options** area, select the test(s) you want to run on a device.

- **Non-Interactive Tests Only** — Runs only tests that require no user intervention.
- **Quick Tests Only** — Runs only the quick tests on the device.
- **Show Ending Timestamp** — Time stamps the test log.

- **Test Iterations** — Selects the number of times the test is run.
- **Continue on Failure** — Enables the tests to continue without user intervention in the event that one of the tests has failed.
- **Log output file pathname** — Enables you to specify the diskette drive or USB memory key where the test log file is saved. You cannot save the file to a hard drive.

Viewing Information and Results

The following tabs in the **Customize** window provide information about the test and the test results.

- **Results** — Displays the test that ran and the result.
- **Errors** — Displays any errors that occurred during the test.
- **Help** — Displays information about the currently selected device, component, or test.
- **Configuration** — Displays basic configuration information about the currently selected device.
- **Parameters** — Displays parameters that you can set for the test.





Jumpers and Connectors

This section provides specific information about the system jumpers. It also provides some basic information on jumpers and switches and describes the connectors on the various boards in the system.

System Board Jumpers

Figure 6-1 shows the location of the configuration jumpers on the system board. Table 6-1 lists the jumper settings.

Table 6-1. System Board Jumper Settings

Jumper	Setting	Description
PWRD_EN	 (default)	The password feature is enabled (pins 2-4)
		The password feature is disabled (pins 4-6)
NVRAM_CLR	 (default)	The configuration settings are retained at system boot (pins 3-5)
		The configuration settings are cleared at the next system boot (pins 1-3)

Disabling a Forgotten Password

The system's software security features include a system password and a setup password, which are discussed in detail in "Using the System Setup Program and UEFI Boot Manager." The password jumper enables these password features or disables them and clears any password(s) currently in use.

⚠ CAUTION: Many repairs may only be done by a certified service technician. You should only perform troubleshooting and simple repairs as authorized in your product documentation, or as directed by the online or telephone service and support team. Damage due to servicing that is not authorized by Dell is not covered by your warranty. Read and follow the safety instructions that came with the product.

- 1 Turn off the system, including any attached peripherals, and disconnect the system from the electrical outlet.
- 2 Open the system. See "Opening and Closing the System."
- 3 Move the password jumper to the "disabled" position to clear the password. See Table 6-1.

See Figure 6-1 to locate the password jumper on the system board.

- 4 Close the system.
- 5 Reconnect your system and peripherals to their electrical outlets, and turn on the system.

The existing passwords are not disabled (erased) until the system boots with the password jumper plug in the "disabled" position. However, before you assign a new system and/or setup password, you must return the jumper plug to the enabled position.

 **NOTE:** If you assign a new system and/or setup password with the jumper plug still in the "disabled" position, the system disables the new password(s) the next time it boots.

- 6 Turn off the system, including any attached peripherals, and disconnect the system from the electrical outlet.
- 7 Open the system. See "Opening and Closing the System."
- 8 Move the password jumper back to the enabled position to restore the password function. See Table 6-1.
- 9 Close the system.
- 10 Reconnect your system and peripherals to their electrical outlets, and turn on the system.
- 11 Assign a new system and/or setup password.

To assign a new password using the System Setup program, see "Assigning a System Password."

System Board Connectors

See Figure 6-1 and Table 6-2 for the location and description of the system board connectors.

Figure 6-1. System Board Connectors

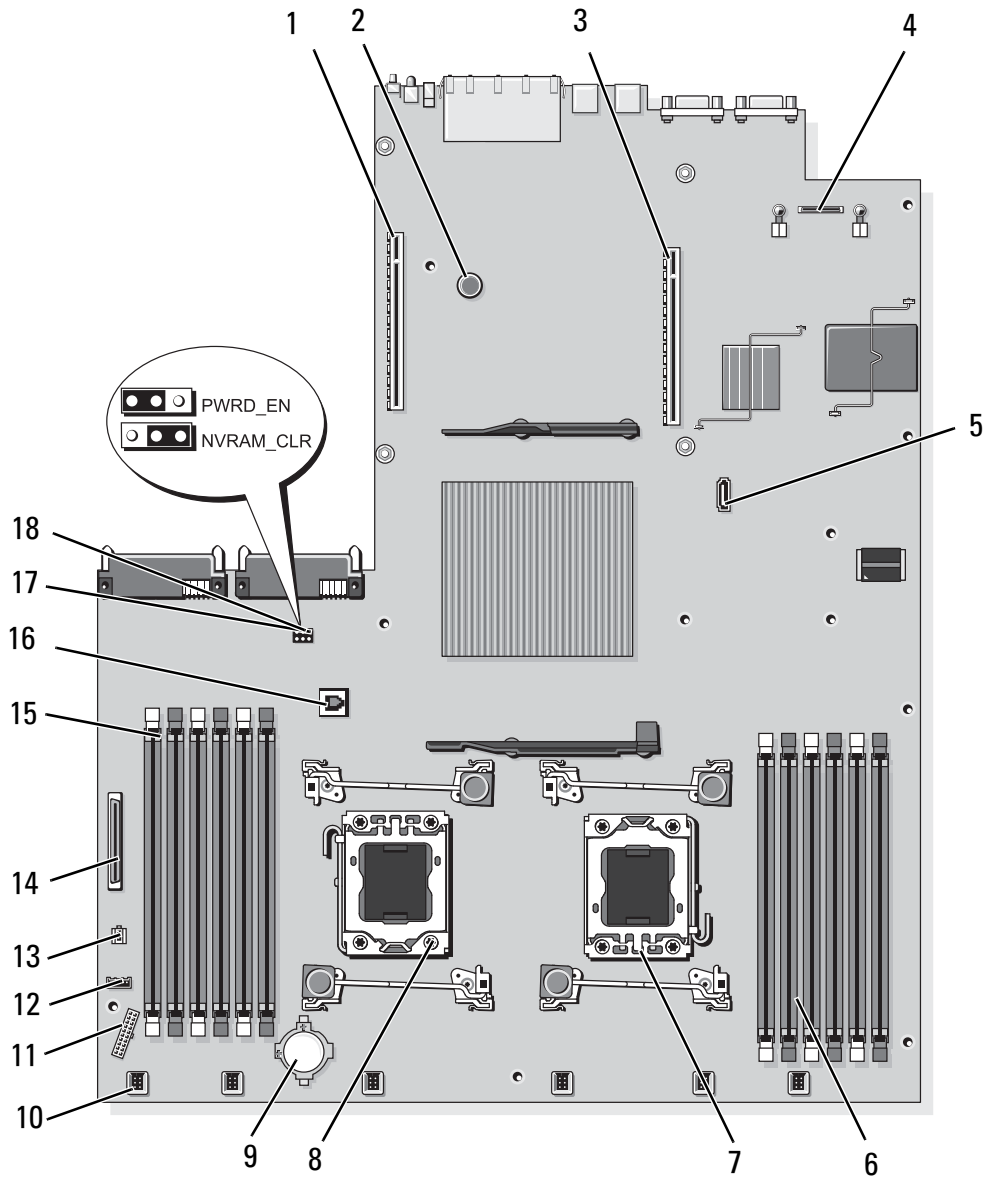

Table 6-2. System Board Connectors

Connector Label	Description
1 IO_RISER2	expansion-card riser 2 connector
2 -	system board assembly retention pin
3 IO_RISER1	expansion-card riser 1 connector
4 iDRAC6	iDRAC6 Enterprise card connector
5 SATA_A	optical drive interface connector
6 B1	memory module slot B1 (white release lever)
B4	memory module slot B4
B2	memory module slot B2 (white release lever)
B5	memory module slot B5
B3	memory module slot B3 (white release lever)
B6	memory module slot B6
7 CPU2	processor socket 2
8 CPU1	processor socket 1
9 BATTERY	connector for the 3.0-V coin battery
10 FAN_MOD n	fan module power connector (6)
11 BP_PWR	SAS backplane power cable connector
12 CTRL_USB	control panel USB interface cable connector
13 DVD_PWR	optical drive power cable connector
14 CTRL_PNL	control panel interface cable connector
15 A1	memory module slot A1 (white release lever)
A4	memory module slot A4
A2	memory module slot A2 (white release lever)
A5	memory module slot A5
A3	memory module slot A3 (white release lever)
A6	memory module slot A6
16 ISCSI_KEY	NIC hardware key connector
17 PWRD_EN	password jumper
18 NVRAM_CLR	configuration jumper

NOTE: For the full name of an abbreviation or acronym used in this table, see the Glossary.

Getting Help

Contacting Dell

For customers in the United States, call 800-WWW-DELL (800-999-3355).

 **NOTE:** If you do not have an active Internet connection, you can find contact information on your purchase invoice, packing slip, bill, or Dell product catalog.

Dell provides several online and telephone-based support and service options. Availability varies by country and product, and some services may not be available in your area. To contact Dell for sales, technical support, or customer service issues:

- 1 Visit support.dell.com.
- 2 Verify your country or region in the **Choose A Country/Region** drop-down menu at the bottom of the page.
- 3 Click **Contact Us** on the left side of the page.
- 4 Select the appropriate service or support link based on your need.
- 5 Choose the method of contacting Dell that is convenient for you.

Glossary

A — Ampere(s).

AC — Alternating current.

ACPI — Advanced Configuration and Power Interface. A standard interface for enabling the operating system to direct configuration and power management.

ambient temperature — The temperature of the area or room where the system is located.

ANSI — American National Standards Institute. The primary organization for developing technology standards in the U.S.

asset tag — An individual code assigned to a system, usually by an administrator, for security or tracking purposes.

backup — A copy of a program or data file. As a precaution, back up your system's hard drive(s) on a regular basis.

blade — A module that contains a processor, memory, and a hard drive. The modules are mounted into a chassis that includes power supplies and fans.

bootable media — A diskette, or USB memory key, or optical media that is used to start your system in lieu of the hard drives.

BTU — British thermal unit.

bus — An information pathway between the components of a system. Your system contains an expansion bus that allows the processor to communicate with controllers for the peripheral devices connected to the system. Your system also contains an address bus and a data bus for communications between the processor and RAM.

C — Celsius.

cache — A fast storage area that keeps a copy of data or instructions for quick data retrieval.

cm — Centimeter(s).

COM n — The device names for the serial ports on your system. Serial ports can be either physical or virtual.

control panel — The part of the system that contains indicators and controls, such as the power button and power indicator.

controller — A chip or expansion card that controls the transfer of data between the processor and memory or between the processor and a peripheral device.

coprocessor — A chip that relieves the system's processor of specific processing tasks. A math coprocessor, for example, handles numeric processing.

CPU — Central processing unit. See *processor*.

DC — Direct current.

DDR — Double-data rate. A technology in memory modules that potentially doubles the data rate by transferring data on both the rising and falling pulses of a clock cycle.

device driver — A program that allows the operating system or some other program to interface correctly with a peripheral.

DHCP — Dynamic Host Configuration Protocol. A method of automatically assigning an IP address to a client system.

diagnostics — A comprehensive set of tests for your system.

DIMM — Dual in-line memory module. See also *memory module*.

DNS — Domain Name System. A method of translating Internet domain names, such as **www.example.com**, into IP addresses, such as 208.77.188.166.

DRAM — Dynamic random-access memory. A system's RAM is usually made up entirely of DRAM chips.

driver — See *device driver*.

DVD — Digital versatile disc or digital video disc.

ECC — Error checking and correction.

EMI — Electromagnetic interference.

ESD — Electrostatic discharge.

ESM — See *iDRAC*.

expansion bus — Your system contains an expansion bus that allows the processor to communicate with controllers for peripherals, such as NICs.

expansion card — An add-in card, such as a NIC or SCSI adapter, that plugs into an expansion-card connector on the system board. An expansion card adds some specialized function to the system by providing an interface between the expansion bus and a peripheral.

expansion-card connector — A connector on the system board or riser board for plugging in an expansion card.

F — Fahrenheit.

FAT — File allocation table. The file system structure used by MS-DOS to organize and keep track of file storage. The Microsoft® Windows® operating systems can optionally use a FAT file system structure.

Fibre Channel — A high-speed network interface used primarily with networked storage devices.

flash memory — A type of electronic chip that can be programmed and

reprogrammed using a software utility.

FTP — File transfer protocol.

g — Gram(s).

G — Gravities.

Gb — Gigabit(s); 1024 megabits or 1,073,741,824 bits.

GB — Gigabyte(s); 1024 megabytes or 1,073,741,824 bytes. However, when referring to hard-drive capacity, the term is usually rounded to 1,000,000,000 bytes.

graphics mode — A video mode that can be defined as x horizontal by y vertical pixels by z colors.

host adapter — A controller that implements communication between the system's bus and the peripheral device, typically a storage device.

hot-swap — The ability to insert or install a device, typically a hard drive or an internal cooling fan, into the host system while the system is powered on and running.

Hz — Hertz.

I/O — Input/output. A keyboard is an input device, and a monitor is an output device. In general, I/O activity can be differentiated from computational activity.

iDRAC — Integrated Dell Remote Access Controller. A systems management hardware and software solution that provides remote management capabilities, crashed system recovery, and power control functions for Dell PowerEdge systems. "iDRAC6" refers to this system's specific implementation of the iDRAC solution.

IP — Internet Protocol.

IPv6 — Internet Protocol version 6.

IPX — Internet package exchange.

IRQ — Interrupt request. A signal that data is about to be sent to or received by a peripheral device travels by an **IRQ** line to the processor. Each peripheral connection must be assigned an **IRQ** number. Two devices can share the same **IRQ** assignment, but you cannot operate both devices simultaneously.

iSCSI — Internet SCSI (see *SCSI*). A protocol that enables SCSI device communication across a network or the Internet.

jumper — Small blocks on a circuit board with two or more pins emerging from them. Plastic plugs containing a wire fit down over the pins. The wire connects the pins and creates a circuit, providing a simple and reversible method of changing the circuitry in a board.

K — Kilo-; 1000.

Kb — Kilobit(s); 1024 bits.

KB — Kilobyte(s); 1024 bytes.

Kbps — Kilobit(s) per second.

KBps — Kilobyte(s) per second.

kg — Kilogram(s); 1000 grams.

kHz — Kilohertz.

KVM — Keyboard/video/mouse. KVM refers to a switch that allows selection of the system from which the video is displayed and for which the keyboard and mouse are used.

LAN — Local area network. A LAN is usually confined to the same building or a few nearby buildings, with all equipment linked by wiring dedicated specifically to the LAN.

LCD — Liquid crystal display.

LED — Light-emitting diode. An electronic device that lights up when a current is passed through it.

local bus — On a system with local-bus expansion capability, certain peripheral devices (such as the video adapter circuitry) can be designed to run much faster than they would with a traditional expansion bus. See also *bus*.

LOM — LAN on motherboard. Also referred to as embedded NIC.

LVD — Low voltage differential.

m — Meter(s).

mA — Milliampere(s).

MAC address — Media Access Control address. Each network device's unique hardware number on a network.

mAh — Milliampere-hour(s).

Mb — Megabit(s); 1,048,576 bits.

MB — Megabyte(s); 1,048,576 bytes. However, when referring to hard-drive capacity, the term is often rounded to mean 1,000,000 bytes.

Mbps — Megabits per second.

MBps — Megabytes per second.

MBR — Master boot record.

memory address — A specific location, usually expressed as a hexadecimal number, in the system's RAM.

memory module — A small circuit board containing DRAM chips that connects to the system board.

memory — An area in your system that stores basic system data. A system can contain several different forms of memory, such as integrated memory (ROM and RAM) and add-in memory modules (DIMMs).

memory key — A portable flash memory storage device integrated with a USB connector.

MHz — Megahertz.

mirroring — A type of data redundancy applicable to hard drives or system memory. When applied to hard drives, a set of physical drives stores data and one or more sets of additional drives stores duplicate copies of the data. Mirroring functionality is provided by software. See also *striping* and *RAID*. When applied to system memory, data in one set of memory modules is duplicated in an identical set of memory modules.

mm — Millimeter(s).

ms — Millisecond(s).

NAS — Network Attached Storage. NAS is one of the concepts used for implementing shared storage on a network. NAS systems have their own operating systems, integrated hardware, and software that are optimized to serve specific storage needs.

NIC — Network interface controller. A device that is installed or integrated in a system to allow connection to a network.

NMI — Nonmaskable interrupt. A device sends an NMI to signal the processor about hardware errors.

ns — Nanosecond(s).

NVRAM — Nonvolatile random-access memory. Memory that does not lose its contents when you turn off your system. NVRAM is used for maintaining the date, time, and system configuration information.

parity — Redundant information that is associated with a block of data.

parity stripe — In RAID arrays, the parity-striped hard drive of a set of striped hard drives contains parity data that enable data recovery in the event that one of the other hard drives fails.

partition — You can divide a hard drive into multiple physical sections called *partitions* with the **fdisk** command. Each partition can contain multiple logical drives. You must format each logical drive with the **format** command.

PCI — Peripheral Component Interconnect. A standard for local-bus implementation.

PCIe — PCI Express. An improved PCI expansion bus technology that uses one or multiple full-duplex serial data lines to interface between the CPU and the expansion card and which greatly increases data bandwidth.

PDU — Power distribution unit. A power source with multiple power outlets that provides electrical power to servers and storage systems in a rack.

peripheral — An internal or external device, such as a diskette drive or keyboard, connected to a system.

pixel — A single point on a video display. Pixels are arranged in rows and columns to create an image. A video resolution, such as 640 x 480, is expressed as the number of pixels across by the number of pixels up and down.

POST — Power-on self-test. Before the operating system loads when you turn on your system, the POST tests various system components such as RAM and hard drives.

processor — The primary computational chip inside the system that controls the interpretation and execution of arithmetic and logic functions. Software written for one processor must usually be revised to run on another processor. *CPU* is a synonym for processor.

PSU — Power supply unit.

PXE — Preboot eXecution Environment. A way of booting a system via a LAN (without a hard drive or bootable diskette).

QPI— QuickPath Interconnect. The bus interface between the processors and between the processors and the IOH chip.

RAID — Redundant array of independent disks. A method of providing data redundancy. Some common implementations of RAID include RAID 0, RAID 1, RAID 5, RAID 10, RAID 50, and RAID 60. See also *mirroring* and *striping*.

RAM — Random-access memory. The system's primary temporary storage area for program instructions and data. Any information stored in RAM is lost when you turn off your system.

RDIMM — A registered DDR3 memory module.

readme file — A text file, usually shipped with software or hardware, that contains information supplementing or updating the product's documentation.

read-only file — A read-only file is one that you are prohibited from editing or deleting.

ROM — Read-only memory. Your system contains some programs essential to its operation in ROM code. A ROM chip retains its contents even after you turn off your system. Examples of code in ROM include the program that initiates your system's boot routine and the POST.

ROMB — RAID on motherboard.

SAN — Storage Area Network. A network architecture that enables remote network-attached storage devices to appear to a server to be locally attached.

SAS — Serial-attached SCSI.

SATA — Serial Advanced Technology Attachment. A standard interface between the system board and storage devices.

SCSI — Small computer system interface. An I/O bus interface.

SD card — Secure digital flash memory card.

SDDC — Single Device Data Correction.

SDRAM — Synchronous dynamic random-access memory.

sec — Second(s).

serial port — A legacy I/O port with a 9-pin connector that transfers data one bit at a time and is most often used to connect a modem to the system.

service tag — A bar code label on the system used to identify it when you call Dell for technical support.

SMART — Self-Monitoring Analysis and Reporting Technology. Allows hard drives to report errors and failures to the system BIOS and then display an error message on the screen.

SMP — Symmetric multiprocessing. Used to describe a system that has two or more processors connected via a high-bandwidth link and managed by an operating system, where each processor has equal access to I/O devices.

SNMP — Simple Network Management Protocol. A standard interface that allows a network manager to remotely monitor and manage workstations.

SSD — Solid State Drives.

striping — Disk striping writes data across three or more disks in an array, but only uses a portion of the space on each disk. The amount of space used by a "stripe" is the same on each disk used. A virtual disk may use several stripes on the same set of disks in an array. See also *guarding*, *mirroring*, and *RAID*.

system board — As the main circuit board, the system board usually contains most of your system's integral components, such as the processor(s), RAM, controllers for peripherals, and various ROM chips. Also referred to as a motherboard or planar.

system configuration information — Data stored in memory that tells a system what hardware is installed and how the system should be configured for operation.

system memory — See *RAM*.

System Setup program — A BIOS-based program that allows you to configure your system's hardware and customize the system's operation by setting features such as password protection. Because the System Setup program is stored in NVRAM, any settings remain in effect until you change them again.

TB — Terabyte(s); 1024 gigabytes or 1,099,511,627,776 bytes. However, when

referring to hard-drive capacity, the term is usually rounded to 1,000,000,000,000 bytes.

TCP/IP — Transmission Control Protocol/Internet Protocol.

termination — Some devices (such as the last device at each end of a SCSI cable) must be terminated to prevent reflections and spurious signals in the cable. When such devices are connected in a series, you may need to enable or disable the termination on these devices by changing jumper or switch settings on the devices or by changing settings in the configuration software for the devices.

TOE — TCP/IP offload engine. A technology that offloads network processing to the network controller.

UDIMM — An unregistered (unbuffered) DDR3 memory module.

UEFI — Unified Extensible Firmware Interface.

uplink port — A port on a network hub or switch used to connect to other hubs or switches without requiring a crossover cable.

UPS — Uninterruptible power supply. A battery-powered unit that automatically supplies power to your system in the event of an electrical failure.

USB — Universal Serial Bus. A USB connector provides a single connection point for multiple USB-compliant devices, such as mice and keyboards. USB devices can be connected and disconnected while the system is running.

USB memory key — See *memory key*.

utility — A program used to manage system resources—memory, disk drives, or printers, for example.

V — Volt(s).

VAC — Volt(s) alternating current.

VDC — Volt(s) direct current.

video adapter — The logical circuitry that provides (in combination with the monitor) your system's video capabilities. A video adapter may be integrated into the system board or may be an expansion card that plugs into an expansion slot.

video memory — Most VGA and SVGA video adapters include memory chips in addition to your system's RAM. The amount of video memory installed primarily influences the number of colors that a program can display (with the appropriate video drivers and monitor capabilities).

video resolution — Video resolution (800 x 600, for example) is expressed as the number of pixels across by the number of pixels up and down. To display a program at a specific graphics resolution, you must install the appropriate video drivers and your monitor must support the resolution.

virtualization — The ability via software to share the resources of a single computer across multiple environments. A single physical system may appear to the user as multiple virtual systems able to host multiple operating systems.

W — Watt(s).

WH — Watt-hour(s).

XML — Extensible Markup Language. XML is a way to create common information formats and to share both the format and the data on the World Wide Web, intranets, and elsewhere.

ZIF — Zero insertion force.

Index

A

Advanced ECC memory
mode, 117

B

back-panel features, 19

batteries
troubleshooting, 146

battery
troubleshooting the RAID card
battery, 153

battery (RAID)
installing, 114
removing, 114

battery (system)
replacing, 127

bezel, 78

blank
hard drive, 82
power supply, 89

C

cabling
optical drive, 108

CD/DVD drive
See optical drive.

connectors
system board, 164
USB, 12
video, 12

contacting Dell, 167

control panel assembly
features, 12
LCD panel features, 14

control panel board
installing, 132
removing, 131

control panel display module
installing, 131
removing, 129

cooling fan
replacing, 106

cooling fans
troubleshooting, 148

cover
closing, 81
opening, 80

D

Dell
contacting, 167

Dell PowerEdge Diagnostics
using, 159

diagnostics
 advanced testing options, 161
 testing options, 161
 using Dell PowerEdge
 Diagnostics, 159
 when to use, 160

DIMMs
 See memory modules (DIMMs).

drive blank
 installing, 83
 removing, 82

drive carrier
 hard drive, 85

E

error messages, 58

expansion cards
 installing, 90
 removing, 92
 SAS controller, 111
 troubleshooting, 155

expansion slots, 89

F

front-panel features, 12

G

guidelines
 expansion card installation, 89
 memory installation, 116

H

hard drive
 drive carrier, 85
 installing, 84
 removing, 83
 troubleshooting, 152

heat sink, 123

I

iDRAC card
 installing, 101
 system port, 19

iDRAC Configuration Utility, 76

indicators
 back-panel, 19
 front-panel, 12
 NIC, 22
 power, 12, 21

information tag
 removing, 79
 replacing, 80

installing
 control panel board, 132
 control panel display module, 131
 expansion card, 90
 hard drive blank, 83
 hard drives, 84
 iDRAC card, 101
 internal USB cable, 100
 memory modules, 120
 optical drive, 108
 PERC 6/I battery cable, 115

- power supply blank, 89
- processor, 125
- RAID battery, 114
- SAS backplane board, 135
- SAS controller, 112
- SD card, 97

internal USB cable

- installing, 100
- removing, 99

J

jumpers (system board), 163

K

keyboards

- troubleshooting, 142

L

LCD panel

- features, 14
- menus, 15

M

Memory Mirroring memory mode, 117

memory mode

- Advanced ECC, 117
- memory mirroring, 117
- Optimizer mode, 117

memory modules (DIMMs)

- configuring, 116
- installing, 120
- RDIMM configurations, 118
- removing, 122
- troubleshooting, 148
- UDIMM configurations, 90, 119

messages

- error messages, 58
- status LCD, 23
- system, 37
- warning, 54

microprocessor

See processor.

N

NIC

- indicators, 22

NIC hardware key, 103

NICs

- back-panel connectors, 19
- troubleshooting, 143

O

optical drive

- installing, 108
- troubleshooting, 151

Optimizer memory mode, 117

P

- password
 - setup, 74
 - system, 72
- passwords
 - disabling, 163
- PERC 6/I battery cable
 - installing, 115
 - removing, 114
- phone numbers, 167
- POST
 - accessing system features, 11
- power indicators, 12, 21
- power supplies
 - indicators, 21
 - removing, 87
 - replacing, 88
 - troubleshooting, 146
- power supply blank, 89
- processor
 - installing, 125
 - removing, 122
 - troubleshooting, 157

R

- RAID battery
 - installing, 114
 - removing, 114
- remote access controller
 - See* iDRAC.
- remove

PERC 6/I battery cable, 114

- removing
 - bezel, 78
 - control panel board, 131
 - control panel display module, 129
 - cover, 80
 - expansion card, 92
 - hard drive blank, 82
 - hard drive from a drive carrier, 85
 - hard drives, 83
 - information tag, 79
 - internal USB cable, 99
 - memory modules, 122
 - power supply, 87
 - power supply blank, 89
 - processor, 122
 - RAID battery, 114
 - SAS backplane board, 132
 - SAS controller, 111
 - SD card, 98
 - system board, 135
- replacing
 - cooling fan, 106
 - information tag, 80
 - power supply, 88
 - system battery, 127

S

- safety, 141
- SAS backplane board
 - installing, 135
 - removing, 132
- SAS controller card

- installing, 112
- removing, 111
- SAS controller daughter card
 - troubleshooting, 153
- SAS RAID controller daughter card
 - troubleshooting, 153
- SD card
 - installing, 97
 - removing, 98
 - troubleshooting, 150-151
- securing your system, 68, 73
- service-only procedure
 - system board, 135
- setup password, 74
- slots
 - See expansion slots.*
- startup
 - accessing system features, 11
- support
 - contacting Dell, 167
- system
 - closing, 81
 - opening, 80
- system board
 - connectors, 164
 - installing, 138
 - jumpers, 163
 - removing, 135
- system cooling
 - troubleshooting, 147
- system features
 - accessing, 11
- system messages, 37
- system password, 72
- system setup program
 - boot settings, 63
 - embedded server management options, 66
 - integrated devices options, 64
 - keystroke to enter, 58
 - memory settings, 61
 - PCI IRQ assignments, 65
 - power management options, 66
 - processor settings, 61
 - SATA settings, 62
 - serial communications options, 65
 - system security options, 68
- system setup screens
 - main, 59
- system startup failure, 141

T

- tape drive (external)
 - troubleshooting, 154
- telephone numbers, 167
- TPM security, 68
- troubleshooting
 - battery, 146
 - cooling fans, 148
 - damaged system, 145
 - expansion cards, 155
 - external connections, 141

- hard drive, 152
- internal USB key, 150-151
- keyboard, 142
- memory, 148
- NIC, 143
- optical drive, 151
- power supplies, 146
- processors, 157
- SAS RAID controller daughter card, 153
- SD card, 150-151
- system cooling, 147
- system startup failure, 141
- tape drive, 154
- video, 142
- wet system, 144

U

- UEFI Boot Manager
 - entering, 70
 - main screen, 71
 - System Utilities screen, 72
 - UEFI Boot Settings screen, 71

USB

- front-panel connectors, 12

USB cable

- internal
 - installing**, 100
 - removing**, 99

USB device

- back-panel connectors, 19

USB key

- troubleshooting, 150-151

V

video

- back-panel connector, 19
- front-panel connectors, 12
- troubleshooting, 142

W

- warning messages, 54

- warranty, 55

wet system

- troubleshooting, 144