

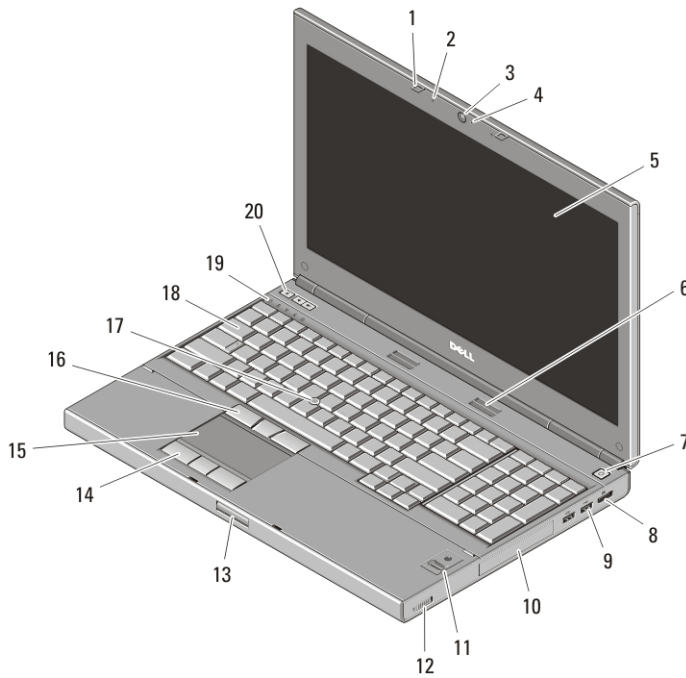
# Dell Precision M4600/M6600 Mobile Workstation

## Setup And Features Information

### About Warnings

 **WARNING:** A WARNING indicates a potential for property damage, personal injury, or death.

### M4600 — Front And Back View



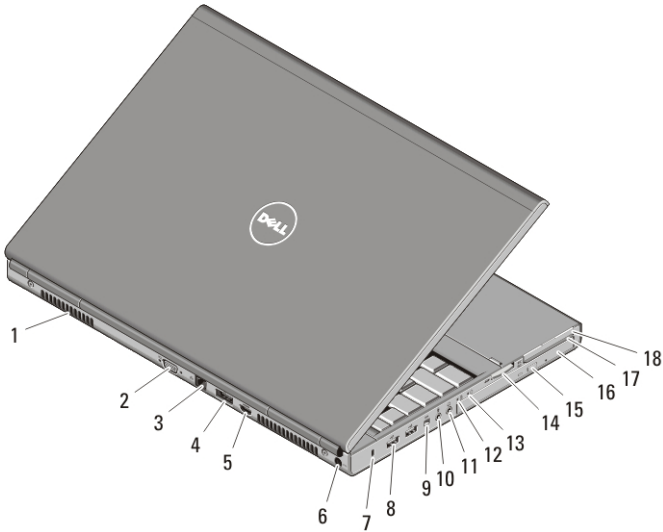
**Figure 1. Front View**

- |                        |                          |
|------------------------|--------------------------|
| 1. display latches (2) | 5. display               |
| 2. microphone          | 6. speakers (2)          |
| 3. camera              | 7. power button          |
| 4. camera LED          | 8. DisplayPort connector |



Regulatory Model: P13F, P10E  
Regulatory Type: P13F001, P10E001  
January 2011

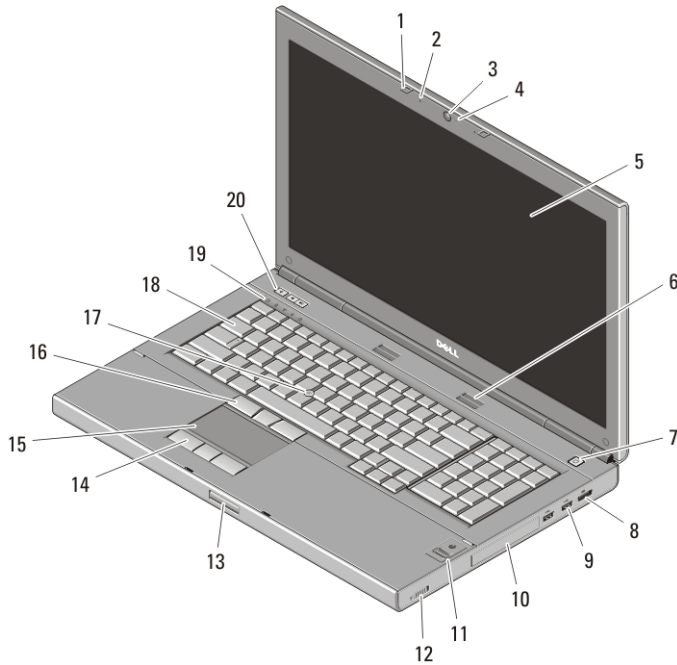
- 9. USB 3.0 connectors (2)
- 10. hard drive
- 11. fingerprint reader (optional)
- 12. wireless switch
- 13. display latch release button
- 14. touchpad buttons (3)
- 15. touchpad
- 16. track stick buttons (3)
- 17. track stick
- 18. keyboard
- 19. device status lights
- 20. volume control buttons



**Figure 2. Back View**

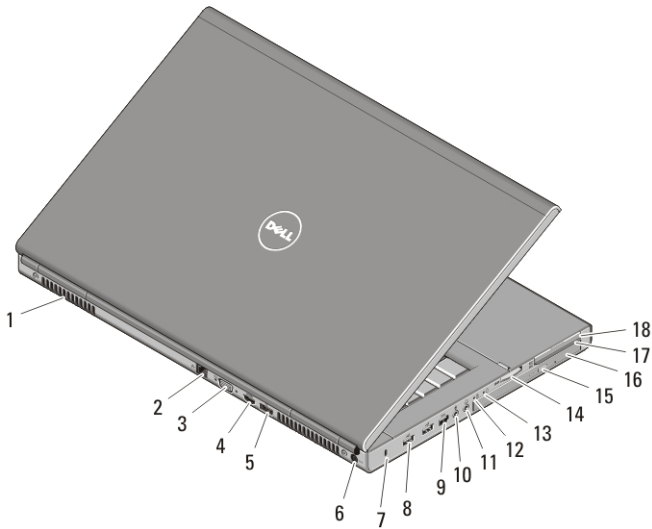
- 1. cooling vents
- 2. VGA connector
- 3. network connector
- 4. eSATA/USB 2.0 connector
- 5. HDMI connector
- 6. power connector
- 7. security cable slot
- 8. USB 2.0 connectors (2)
- 9. IEEE 1394 port (4-pin)
- 10. microphone connector
- 11. headphone connector
- 12. battery status light
- 13. power light
- 14. 8-in-1 card reader slot
- 15. optical drive eject button
- 16. optical drive
- 17. smart card reader slot
- 18. ExpressCard slot

## Precision M6600 — Front And Back View



**Figure 3. Front View**

- |                           |                                   |
|---------------------------|-----------------------------------|
| 1. display latches (2)    | 11. fingerprint reader (optional) |
| 2. microphone             | 12. wireless switch               |
| 3. camera                 | 13. display latch release button  |
| 4. camera LED             | 14. touchpad buttons (3)          |
| 5. display                | 15. touchpad                      |
| 6. speakers (2)           | 16. track stick buttons (3)       |
| 7. power button           | 17. track stick                   |
| 8. DisplayPort connector  | 18. keyboard                      |
| 9. USB 3.0 connectors (2) | 19. device status lights          |
| 10. hard drive            | 20. volume control buttons        |




**Figure 4. Back View**

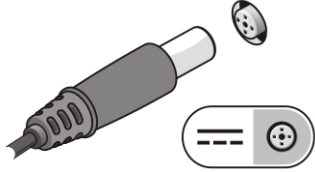
- |                                    |                                |
|------------------------------------|--------------------------------|
| 1. cooling vents                   | 10. microphone connector       |
| 2. network connector               | 11. headphone connector        |
| 3. VGA connector                   | 12. battery status light       |
| 4. HDMI connector                  | 13. power light                |
| 5. eSATA/USB 2.0 connector         | 14. 8-in-1 card reader slot    |
| 6. power connector                 | 15. optical drive eject button |
| 7. security cable slot             | 16. optical drive              |
| 8. USB 2.0 connectors (2)          | 17. smart card reader slot     |
| 9. IEEE 1394 port (6-pin, powered) | 18. ExpressCard slot           |

### Quick Setup

- !** **WARNING:** Before you begin any of the procedures in this section, read the safety information that shipped with your computer. For additional best practices information, see [www.dell.com/regulatory\\_compliance](http://www.dell.com/regulatory_compliance).
- !** **WARNING:** The AC adapter works with electrical outlets worldwide. However, power connectors and power strips vary among countries. Using an incompatible cable or improperly connecting the cable to the power strip or electrical outlet may cause fire or equipment damage.
- △** **CAUTION:** When you disconnect the AC adapter cable from the computer, grasp the connector, not the cable itself, and pull firmly but gently to avoid damaging the cable. When you wrap the AC adapter cable, ensure that you follow the angle of the connector on the AC adapter to avoid damaging the cable.

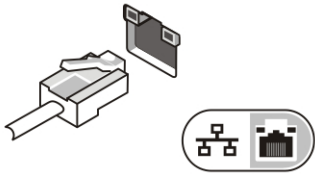
 **NOTE:** Some devices may not be included if you did not order them.

1. Connect the AC adapter to the AC adapter connector on the computer and to the electrical outlet.



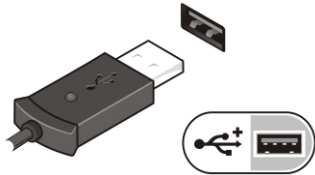
**Figure 5. AC Adapter**

2. Connect the network cable (optional).



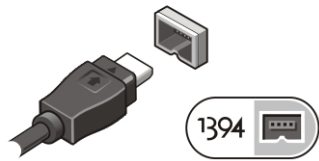
**Figure 6. Network Connector**

3. Connect USB devices, such as a mouse or keyboard (optional).

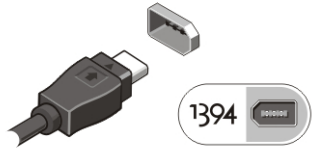


**Figure 7. USB Connector**

4. Connect IEEE 1394 devices, such as a 1394 hard drive (optional).

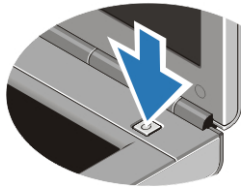


**Figure 8. 1394 Connector on M4600**



**Figure 9. 1394 Connector on M6600**

5. Open the computer display and press the power button to turn on the computer.



**Figure 10. Power Button**

**NOTE:** It is recommended that you turn on and shut down your computer at least once before you install any cards or connect the computer to a docking device or other external device, such as a printer.

## Specifications

**NOTE:** Offerings may vary by region. The following specifications are only those required by law to ship with your computer. For more information regarding the configuration of your computer, click **Start** → **Help and Support** and select the option to view information about your computer.

---

### System Information

---

Chipset	Mobile Intel QM67 Express Chipset
Processor	<ul style="list-style-type: none"> <li>• Intel Core i5 and i7 Dual Core</li> <li>• Intel Core i7 Quad Extreme</li> <li>• Intel Core i7 Quad Core</li> </ul>

---

**Video**


---

Video type	discrete
Data bus	integrated video
Video controller and memory	
M4600	<ul style="list-style-type: none"><li>• AMD FirePro M5950 Mobility Pro Graphics with 1GB GDDR5</li><li>• NVIDIA Quadro 1000M with 2GB GDDR3</li><li>• NVIDIA Quadro 2000M with 2GB GDDR3</li></ul>
M6600	<ul style="list-style-type: none"><li>• AMD FirePro M8900 Mobility Pro Graphics with 2GB GDDR5</li><li>• NVIDIA Quadro 3000M with 2GB GDDR5</li><li>• NVIDIA Quadro 4000M with 2GB GDDR5</li></ul>

---

**Memory**

---


Memory connector	four DIMM slots
	 <b>NOTE:</b> Computers shipped with Intel Core i5 or Intel Core i7 support only two memory connectors.
Memory capacity	1 GB, 2 GB, 4 GB, and 8 GB
Memory type	DDR3 1333MHz (1600 MHz and faster UI)
Minimum memory	2 GB
Maximum memory	32 GB

---

**Battery**

---

Type	lithium ion
Dimensions:	

 **NOTE:** The Dell Precision M6600 Mobile Workstation only supports a 9-cell battery.

6-cell / 9-cell / 9-cell long cycle life (LCL)

Depth	80 mm (3.14 inches)
Height	190 mm (7.48 inches)
Width	20 mm (0.78 inches)

---

**Battery**

---

Weight	6-cell	365 g (0.80 lb)
	9-cell / 9-cell LCL	500 g (1.10 lb)
Voltage	11.10 V	
Temperature range:		
Operating	0 °C to 35 °C (32 °F to 95 °F)	
Non-operating	-40 °C to 65 °C (-40 °F to 149 °F)	
Coin-cell battery	3 V CR2032 lithium ion cell	

---

<b>AC Adapter</b>	<b>M4600</b>	<b>M6600</b>
Input voltage	100–240 VAC	100–240 VAC
Input current (maximum)	2.34 A	3.50 A
Input frequency	50 Hz – 60 Hz	50 Hz – 60 Hz
Output power	180 W	240 W
Output current	9.23 A	12.30 A
Rated output voltage	19.50 VDC	19.50 VDC
Dimensions:	180 W	240 W
Height	30 mm (1.18 inches)	25.40 mm (1 inch)
Width	155 mm (6.10 inches)	200 mm (7.87 inches)
Depth	76 mm (2.99 inches)	100 mm (3.93 inches)
Temperature range:		
Operating	0 °C to 40 °C (32 °F to 104 °F)	
Non Operating	-40 °C to 65 °C (-40 °F to 149 °F)	

---

**Contactless Smart Card**

---

Supported Smart Cards and Technologies	ISO14443A — 160 kbps, 212 kbps, 424 kbps, and 848 kbps
	ISO14443B — 160 kbps, 212 kbps, 424 kbps, and 848 kbps



---

**Contactless Smart Card**

---

ISO15693  
HID iClass  
FIPS201  
NXP Desfire

---

<b>Physical</b>	<b>M4600</b>	<b>M6600</b>
Height	36.5 mm (1.44 inches)	37.20 mm (1.46 inches)
Width	376 mm (14.80 inches)	416.70 mm (16.41 inches)
Depth	256 mm (10.08 inches)	270.60 mm (10.65 inches)
Weight (Minimum)	2.87 kg (6.33 lbs with 6-cell battery and airbay)	3.42 kg (7.53 lbs with 6-cell battery and airbag)

---

**Environmental**

---

## Temperature:

Operating	0 °C to 35 °C (32 °F to 95 °F)
Storage	-40 °C to 65 °C (-40 °F to 149 °F)

## Relative humidity (maximum):

Operating	10% to 90% (noncondensing)
Storage	5% to 95% (noncondensing)

## Airborne contaminant level

G2 or lower as defined by ISA-S71.04-1985

## Altitude (maximum):

Operating	-15.2 to 3048 m (-50 to 10,000 ft)
Non-operating	-15.2 to 10,668 m (-50 to 35,000 ft)

## Finding More Information and Resources

See the safety and regulatory documents that shipped with your computer and the regulatory compliance website at [www.dell.com/regulatory\\_compliance](http://www.dell.com/regulatory_compliance) for more information on:

- Safety best practices
- Regulatory certification
- Ergonomics

See [www.dell.com](http://www.dell.com) for additional information on:

- Warranty
- Terms and Conditions (U.S. only)
- End User License Agreement

Information in this publication is subject to change without notice.

© 2010 Dell Inc. All rights reserved.

Reproduction of these materials in any manner whatsoever without the written permission of Dell Inc. is strictly forbidden.

Trademarks used in this text: Dell™, the DELL logo, Dell Precision™, Precision ON™, ExpressCharge™, Latitude™, Latitude ON™, OptiPlex™, Vostro™, and Wi-Fi Catcher™ are trademarks of Dell Inc. Intel®, Pentium®, Xeon®, Core™, Atom™, Centrino®, and Celeron® are registered trademarks or trademarks of Intel Corporation in the U.S. and other countries. AMD® is a registered trademark and AMD Opteron™, AMD Phenom™, AMD Sempron™, AMD Athlon™, ATI Radeon™, and ATI FirePro™ are trademarks of Advanced Micro Devices, Inc. Microsoft®, Windows®, MS-DOS®, Windows Vista®, the Windows Vista start button, and Office Outlook® are either trademarks or registered trademarks of Microsoft Corporation in the United States and/or other countries. Blu-ray Disc™ is a trademark owned by the Blu-ray Disc Association (BDA) and licensed for use on discs and players. The Bluetooth® word mark is a registered trademark and owned by the Bluetooth® SIG, Inc. and any use of such mark by Dell Inc. is under license. Wi-Fi® is a registered trademark of Wireless Ethernet Compatibility Alliance, Inc.

Other trademarks and trade names may be used in this publication to refer to either the entities claiming the marks and names or their products, Dell Inc. disclaims any proprietary interest in trademarks and trade names other than its own.