

Dell™ Tablet

User's Manual

Model name: T01C/T02D



 **NOTE:** A NOTE indicates important information that helps you make better use of your tablet.

 **CAUTION:** A CAUTION indicates potential damage to hardware or loss of data if instructions are not followed.

 **WARNING:** A WARNING indicates a potential for property damage, personal injury, or death.

© 2013 Dell Inc. All rights reserved.

Information in this document is subject to change without notice. Reproduction of these materials in any manner whatsoever without the written permission of Dell Inc. is strictly forbidden.

Trademarks used in this text: Dell™, the DELL logo, and Inspiron™ are trademarks of Dell Inc.; Intel®, Centrino®, Core™, and Atom™ are either trademarks or registered trademarks of Intel Corporation in the U.S. and other countries; Microsoft®, Windows®, and Windows start button logo are either trademarks or registered trademarks of Microsoft Corporation in the United States and/or other countries; Bluetooth® is a registered trademark owned by Bluetooth SIG, Inc. and is used by Dell under license; Blu-ray Disc™ is a trademark owned by the Blu-ray Disc Association (BDA) and licensed for use on discs and players; Other trademarks and trade names may be used in this document to refer to either the entities claiming the marks and names or their products. Dell Inc. disclaims any proprietary interest in trademarks and trade names other than its own.

Contents

Dell Tablet Features	5
Installation and Charging	6
Insert the microSD card	6
Charge the battery for at least 4 hours	7
Getting Started	7
Turn on/off the tablet	7
Lock and unlock the screen	7
Touch tips	8
Screen orientation	8
Applications and widgets	8
Text entry	9
Managing your tablet settings	10
Internet	11
Connecting to the Internet	11
Browsing the Internet	12
Email	13
Customizing Your Tablet	14
Display settings	14
Sound settings	15
Date, time, and time zone	15
Protecting Your Tablet	15

Protect your tablet data with a screen unlock pattern.....	15
Protect your tablet data with a PIN.....	16
Protect your tablet data with a password.....	16
Applications.....	17
Camera.....	17
Copy files to and from the tablet.....	17
Bluetooth.....	18
Gallery.....	19
Calendar.....	20
Calculator.....	20
Clock.....	20
Troubleshooting.....	21
Warnings and Precautions	22

Dell Tablet Features

The following feagure shows the appearance of your tablet and it is for your reference only.



Buttons/Connectors/Parts Functionality

- | | |
|-------------------------------|---|
| 1 Volume down button | <ul style="list-style-type: none"> • Press to decrease the media volume by one level. • Press and hold to continuously decrease the media volume. |
| 2 Volume up button | <ul style="list-style-type: none"> • Press to increase the media volume by one level. • Press and hold to continuously increase the media volume. |
| 3 Charger jack/Micro USB port | <ul style="list-style-type: none"> • Connects to the smaller end of the USB cable (shielded cable). |
| 4 Headphone connector | <ul style="list-style-type: none"> • Connects to headphones. |
| 5 Front camera | <ul style="list-style-type: none"> • Finds the front views. |
| 6 Power button | <ul style="list-style-type: none"> • Press and hold to turn on your pad. |

Buttons/Connectors/Parts Functionality

7 MicroSD door

8 Menu key

9 Home key

10 Back key

11 Speaker

- In standby mode, press to lock and unlock the screen.
- In standby mode, press and hold to open the options menus.
- Holds the MicroSD card in place.
- Tap to open the menu with options that affect the current application.
- Tap to open the applications list used currently.
- Tap to return to the main screen.
- Tap to return to the previous screen and exit the running application.
- Tap to close the on-screen soft keypad in text input mode.
- Outputs the sound.

Installation and Charging

Insert the microSD card

The following figures show the installation of the microSD card. Follow the step-by-step guide carefully, and ensure that the cards are properly aligned with pad's cards slot.

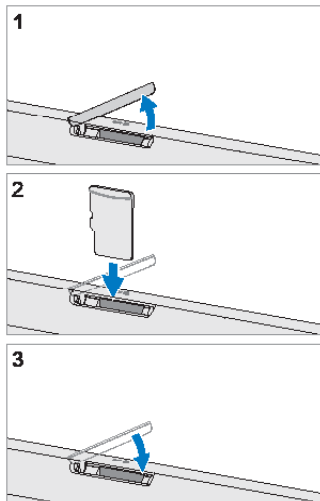
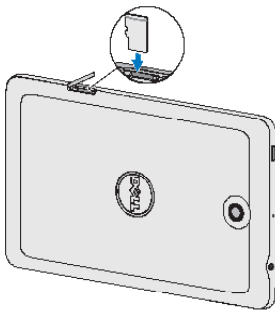

Charge the battery for at least 4 hours

 **NOTE:** Charge the battery in an environmental temperature between 0°C and 40°C.

 **NOTE:** The battery is not fully charged when first unpacked.

1. Connect the charger plug to the USB port of the pad.
2. Connect the charger power plug to a power socket.
3. Wait until the battery is fully charged.

While the battery is being charged, an animated charging icon is displayed. When the charging icon becomes static, the battery is fully charged.

4. Unplug the charger power plug from the power socket and then the charger plug from the USB port of your pad.

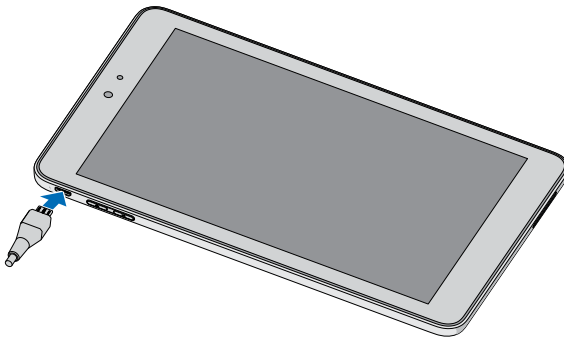

Getting Started

Turn on/off the tablet

 **NOTE:** Use your tablet in an environmental temperature between -10°C and 40°C.

To turn on your pad, press and hold the power button for about 3s.

To turn off your pad, press and hold the power button until an option menu appears, and then select **Power off > OK**.

Lock and unlock the screen

To lock the screen manually, press the power button.

To unlock the screen, press the power button to wake up the screen and then slide  to any direction.

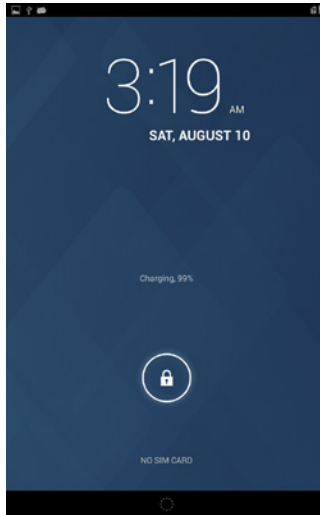

Touch tips

Your tablet has a multi-touch sensitive screen. You can touch the surface of the screen to operate your tablet.

Finger gestures	Allows you to:
Tap	Touch the screen once to access a menu or select an item.
Tap and hold	Touch an item on the screen until it occurs.
Slide	Move an icon across the surface of the screen.
Drag	Tap and hold an icon and then move the icon to the target position.
Two-finger zoom	Tap and hold the screen with two fingers, stretch or combine two fingers to zoom in or out on maps, websites, photos and reading interface.

Screen orientation

For optimal viewing experience, the screen orientation changes automatically depending on how you hold the tablet.

 **NOTE:** To modify the default rotating behavior, slide the notification panel downward and then select to close the **Auto-rotate**.

Applications and widgets

Application: Software which allows you to perform a specific task. Your tablet is preloaded

with a variety of applications, and additional applications can be downloaded from the Android Market.

Widget: A small application which resides on the Home screen and provides quick and easy access to information.

Text entry

You can type text using the on-screen soft keyboard. To open the on-screen keyboard, tap a text box. To close the keyboard, tap **Back key**.



1 Tap to type letters into the text box where the cursor appears.

2 • Touch to delete a typed character, symbol, or a space.

- Tap and hold to quickly delete typed text.

3 • Tap once to show the uppercase keyboard for typing a capital letter.

- Tap twice to enable the Caps Lock mode.
- Tap to change back to the lowercase keyboard.

4 Tap to use voice input. Say the words you want to enter in the microphone. The device enters the words that it can recognize from your voice.

5 Tap to show the keyboard for typing numbers, punctuation marks, and symbols.

Managing your tablet settings

Check storage spaces

Tap  > **Settings** > **Storage**. The screen displays the **Internal/Total** and **MicroSD** storage space.

Erase unwanted application data to free storage space

1 Tap  > **Settings** > **Apps** > **Downloaded/Running/All**.

2 From the Apps list, tap the application whose cache or data you want to remove.

3 In the Application information screen, tap **Force stop** or **Disable**.

To uninstall the SD card

1 Tap  > **Settings** > **Storage**.

2 Tap **Unmount** > **OK** to uninstall the SD card.

 **CAUTION:** It is strongly recommended that you unmount the SD card before removing it. Removing the SD card while the device is working may cause data loss or result in application errors.

Erase all data from your tablet

 **CAUTION:** The following steps will erase all the data including your personal information and downloaded applications from your tablet. Ensure that you back up all the required data before you proceed.

1 Tap  > **Settings** > **Backup & reset** > **Factory data reset**.

2 Tap **Reset tablet**.

3 Tap **Erase everything** after you read the warning.

Internet

Connecting to the Internet

Connect to the Internet using Wi-Fi

You can connect your tablet to the Internet using Wi-Fi.



To connect to a Wi-Fi network, you need access to a wireless point or “hotspot” within a distance of up to 300 feet (100 meters).

 **NOTE:** The range and quality of the Wi-Fi signal is affected by the number of connected devices, infrastructure, and objects through which the signal is transmitted.

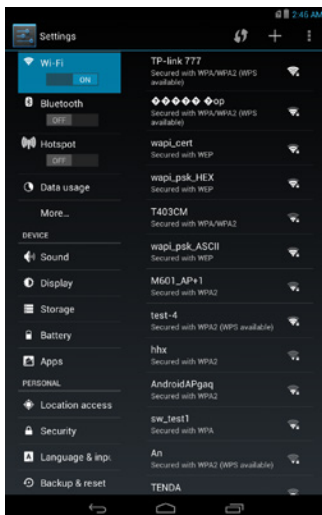
- 1 Tap  > Settings > Wireless & networks > Wi-Fi to enable it. The tablet will automatically scan for available Wi-Fi networks.
- 2 Slide the list and select a Wi-Fi network you want to connect to.
- 3 Enter a password (if necessary), then tap **Connect** to connect to the Wi-Fi network.



 **NOTE:** To connect to a network protected by Wired Equivalent Privacy (WEP), Wi-Fi Protected Access (WPA), WPA2, or Wireless Protected Setup (WPS), you must enter the WEP/WPA/WPA2/WPS security key to obtain authorized access to the network. The next time your device connects to a previously accessed secured wireless network, you will not be asked to enter the WEP/WPA/WPA2/WPS key again, unless you reset your tablet to its factory default settings.

 **NOTE:** To start a new search for available Wi-Fi networks, on the Wi-Fi screen, tap  > **Scan**.

Disable all connections using the airplane mode

Selecting the **Airplane mode** disables all mobile and Wi-Fi connections. This feature is useful when wireless connectivity is strictly prohibited, such as on an airplane.

Tap  > **Settings** > **Wireless & networks** > **More** > **Airplane mode** to enable the **Airplane mode**.

Browsing the Internet

Open the browser

Tap  > **Browser** to open the application.

Use the browser controls bar



Enter the webpage address

View bookmarks, history and save pages

Set up your home page

- 1 On the **Browser** screen, tap  > **Settings** > **General** > **Set homepage** > **Other**.
- 2 Enter the address of the website you want to use as your homepage and then tap **OK**.

Viewing web pages

To navigate on a web page:

Slide your finger horizontally or vertically on the screen to scroll and view desired areas of a web page.

To zoom in on a web page:

Pinch-out a desired area of a web page by moving two fingers apart on the screen.

To zoom out on a web page:

Pinch-in a desired area of a web page by bringing two fingers closer together on the screen.

 **NOTE:** You can also double-tap the desired area of a web page to switch between the zoom-in and zoom-out views of the area.

Email

You can create POP3, IMAP, and exchange email accounts from web-based e-mail services on your tablet.

Open the email application

Tap  > Email to run the application.

Set up an email account

1 On the Email screen, choose a mailbox.

2 Input the address and password of the e-mail account (The same as the account on your personal computer) and then tap **Login**.

 **NOTE:** If the e-mail account you want to set up is not in the tablet's email database, you can tap **Others** to manually enter the email account, and then tap **Next**.

View your emails

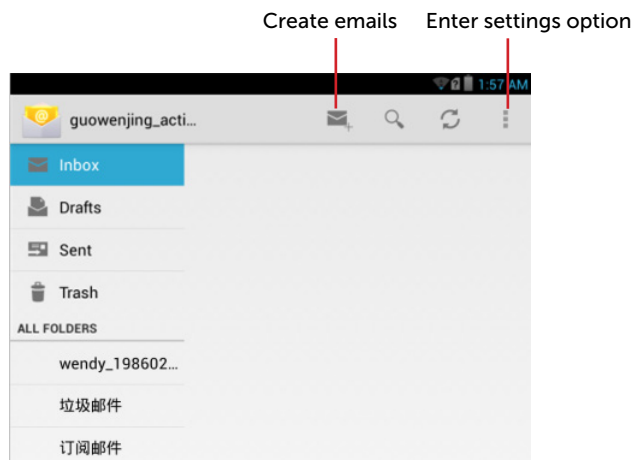

Add emails account

In an e-mail account screen, tap  > **Settings** > **Add account** to set your account.

Create and send emails

1 Tap  > **Email**.

- 2 Select an email account to use if you have set up more than one account on your tablet.
- 3 In an e-mail account screen, tap  to create emails.
- 4 Type the recipient's email address in the **To** field. If you are sending the email to multiple recipients, separate their email addresses with a comma. You can add as many recipients as you need.
- 5 Type the subject.
- 6 Compose your email content.
- 7 Tap **Send**.

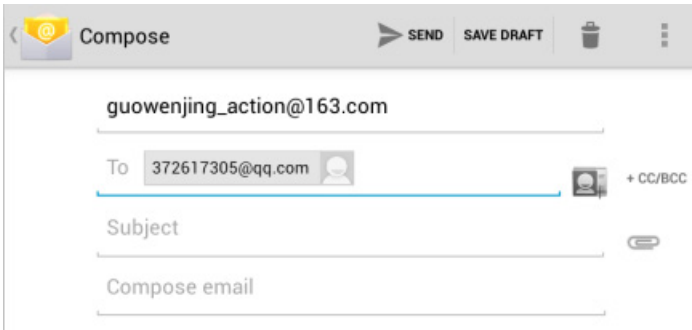

Delete an email account on your tablet

- 1 In an e-mail account screen, tap  > **Settings** and select one account.
- 2 To delete an email account, tap **Remove account** on the context menu. When asked to confirm deletion, tap **OK**.

Customizing Your Tablet

You can customize your tablet, using the options available in the **Settings** screen.

Display settings

To change the display settings:

Tap  > **Settings** > **Display** and then select the desired item under **Display** settings.

Brightness

Drag the brightness slider horizontally or tap the desired portion on the slider. The length of the highlighted bar on the slider determines the brightness of the screen. Tap **OK** to confirm the adjustment.



NOTE: The **Automatic brightness** is enabled by default and

your tablet will adjust the screen brightness automatically based on the surrounding light conditions.

- Wallpaper** Select one picture from the **Gallery**, **Live wallpapers** or **Wallpaper**. After adjust the size and range of the picture, tap **OK**.
- Sleep** Select the sleep time from 15 seconds, 30 seconds, 1 minute, 2 minutes, 5 minutes, 10 minutes and 30 minutes.
- Daydream** While docked or charged, your tablet will enter the screen-protecting mode. Select one or several pictures and configure the daydream time to enable it.
- Font size** Set your tablet's font size from **Small**, **Normal**, **Large** and **Huge**.

Sound settings

To change the sound and ringtone settings:

Tap  > **Settings** > **Sound**, and then select the desired item under **Sound** settings.

- Volumes** Adjust the volume for music, videos, games, notification and alarms.
- Default notification sound** Select a default ringtone for notifications.
- Touch sounds** Select to play the touch sounds or not.
- Screen lock sound** Select to play the screen lock sound or not.

Date, time, and time zone

Your tablet automatically uses the network-provided date, time and time zone by default.

To manually set the date, time, and time zone, you can:

- 1 Tap  > **Settings** > **Date & time**, and disable the automatic date, time and time zone.
- 2 Select to set the date, time, time zone, 24-hour format and date format.

Protecting Your Tablet

Protect your tablet data with a screen unlock pattern

You can protect your tablet data against unauthorized access by locking the touch screen with a screen unlock pattern. Once the unlock pattern is enabled and the screen is locked, you need to draw the correct unlock pattern to unlock the screen.

After you fail to draw the correct unlock pattern on the screen for five consecutive times, you will be asked to wait for 30 seconds before you can try again.

To create a screen unlock pattern

- 1 Tap  > **Settings** > **Security** > **Screen lock** and then select **Pattern** from the options of **None**, **Slide**, **Face unlock**, **Pattern**, **PIN** and **Password**.
- 2 Drag your finger to draw the unlock pattern by connecting at least four dots in a vertical, horizontal and/or diagonal direction. Take your finger off the screen when a pattern is drawn.
- 3 The tablet records the pattern if it is correctly drawn. Tap **Continue**.
- 4 Draw the pattern again as prompted, and then tap **Confirm**.

To disable or change the screen unlock pattern

- 1 Tap  > **Settings** > **Security** > **Screen lock**.
- 2 Draw the pattern you created.
- 3 Select **None** to disable screen unlock security; select **Pattern** to draw a new unlock pattern.

Protect your tablet data with a PIN

To create a PIN

- 1 Tap  > **Settings** > **Security** > **Screen lock** > **PIN**.
- 2 On the **Choose your PIN** page that appears, enter a PIN in the text box. Your PIN must be 4 characters at least.
- 3 Tap **Continue** to proceed.
- 4 Enter the PIN again to confirm.
- 5 Tap **OK**.

To disable or change PIN

- 1 Tap  > **Settings** > **Security** > **Screen lock** > **PIN**.
- 2 Enter the PIN you have enabled.
- 3 Select **None** to disable the PIN; select **PIN** to change PIN.

Protect your tablet data with a password

To create a Password

- 1 Tap  > **Settings** > **Security** > **Screen lock** > **Password**.
- 2 On the **Choose your password** page that appears, enter a password in the text box. A valid password consists of at least 4 characters and contains at least one letter.
- 3 Tap **Continue** to proceed.
- 4 Enter the password again to confirm.
- 5 Tap **OK**.

To disable or change the password

- 1 Tap  > **Settings** > **Security** > **Screen lock** > **Password**.
- 2 Enter the password you have enabled.
- 3 Select **None** to disable the password; select **Password** to change password.

Applications

Camera

Your tablet has a camera with auto-focus feature that allows you to capture and share high-quality pictures and videos.

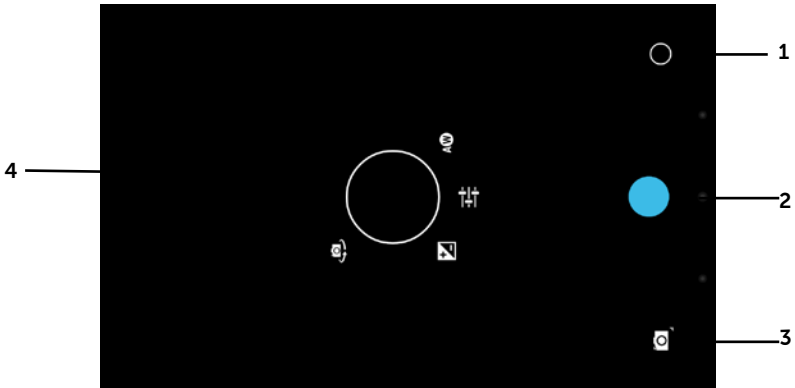

- 1 tap to open the camera setting options and select the desired setting.
- 2 Tap to capture a picture.
- 3 Tap to switch between the camera mode for capturing pictures and the camcorder mode for shooting videos.
- 4 Viewfinder screen.

Copy files to and from the tablet

To exchange pictures, videos, music, and other files between your tablet and a computer, you can use the internal device storage or the SD card as a USB drive, by connecting the tablet to a computer with the included USB cable.

To set the SD card or the internal device storage as a USB drive

- 1 Connect the tablet to the computer by connecting the smaller end of the USB connector into the tablet and the bigger end of the USB connector into the USB port on the computer.
- 2 The USB connected screen appears and the USB connected banner flashes on the status

bar. The USB notification icon appears on the status bar's notification area when the device is connected to the computer.

- 3 Tap to mark the **Media storage**, if you want to transfer files between your computer and the tablet.
- 4 Open the **My Computer** window on your computer to locate two removable drives, which represent respectively the SD card installed in your tablet, and the internal device storage.
- 5 Copy the desired files such as music or pictures from another drive/folder to one of the removable drives, or vice versa.

To turn off USB storage

The tablet will not recognize the SD card and the internal device storage when they are being used as a USB drive. You will not be able to use the device's applications that involve saving or retrieving files on the SD card and on the internal device storage, such as camera or music playback. You need to turn off USB storage to recognize the SD card and the internal device storage, when the device is connected to a computer.

Bluetooth

Bluetooth is a short-range wireless communications technology that lets your device connect over a wireless network to other Bluetooth-enabled devices for data exchange.

Bluetooth on your device operates in three different modes:

- On** Bluetooth is turned on. Your tablet is enabled to detect Bluetooth devices within range, but will not be found by them.
 - Visible** Bluetooth is turned on, and all nearby Bluetooth devices can detect your device.
 - Invisible** Bluetooth is turned on, and all nearby Bluetooth devices can not detect your device.
 - Off** Bluetooth is turned off. Your device cannot send and receive data by Bluetooth.
-

To turn on Bluetooth and make the tablet discoverable

- 1 Tap  > **Settings** > **Wireless & networks** > **Bluetooth**.
- 2 Select the Bluetooth check box and turn on Bluetooth.
- 3 Tap **Visible to all nearby Bluetooth devices** to make the tablet recognizable by other nearby Bluetooth devices.

To pair and connect a Bluetooth device

1 After the Bluetooth is turned on, your tablet starts to scan for Bluetooth devices within range and then displays all detected devices below the **Available devices**.

 **NOTE:** To detect more devices, tap **Search for devices**.

2 To initiate a connection with a device, tap the name of the device.

3 When the pairing is successful, tap the paired device to start connection.

 **NOTE:** To listen to the music using a Bluetooth headset, pair it first with your tablet.

To end a Bluetooth connection

On the Bluetooth connection page, tap  > **Disconnect** to end the Bluetooth connection.

To terminate a pairing partnership

On the Bluetooth connection page, tap  > **Unpair** to erase all pairing information with that device.

Gallery

To view and manage the pictures and videos stored on your tablet, tap  > **Gallery**.

To share or delete albums

All pictures and videos are grouped in separate albums as overlapping according to their dates, sources, or folders in which they are stored. For example, pictures taken using the tablet camera are grouped as Camera, and downloaded pictures are grouped as download.

1 Tap and hold an album until the options appear.

2 Tap more albums to select them if you want to do the same task for those albums.





- To post the selected album to Google and Email, or to send the album using Bluetooth.
- To delete the album, tap .

To browse picture and video thumbnails

1 Tap an album to display the thumbnails of all pictures and videos inside.

2 To browse the thumbnails, tap  to display all the thumbnails in grid view and move the thumbnails horizontally until the desired thumbnail is located.

3 To select a thumbnail, tap and hold it until the options appear; tap more thumbnails as you need.

- To post a selected picture or video to Picasa or to send it using Bluetooth, tap .
- To delete a selected picture or video, tap .
- To set a picture as the wallpaper, tap and hold the picture until the options appear and then select  > **Set picture as > Wallpaper**.
- To set a picture as the contact photo, tap and hold the picture until the options appear and then select  > **Set picture as > Contact photo**.

To display a full picture

Tap a desired picture to display the picture in full screen.

- Slide the picture to view the next or previous one.
- To open the picture viewing controls, tap anywhere on the picture.

Calendar

Use the calendar to schedule and manage your events, meetings, and appointments.

To open the calendar

Tap  > **Calendar** to open the application.

To add a new event

- 1 On the **Calendar** screen, tap to open the new event details screen.
- 2 Type the event name, location, time period, description, repetition and reminders.
- 3 Tap **Done** and the event is created.



Calculator

Tap  > **Calculator** to open the calculator screen. Perform calculations by tapping the corresponding buttons on the calculator panel.

Clock

Tap  > **Clock** to run the application.

To set an alarm

- 1 On the **Clock** main screen, tap  to enter the alarm screen.
- 2 On the **Alarms** screen, tap  to add an alarm.
- 3 Type the alarm time and select **AM** or **PM**.
- 4 Tap **OK** to add the alarm.

Troubleshooting

Problem	Possible causes	Possible solutions
System problems		
Battery does not charge.	The battery or battery charger is damaged.	Contact the dealer.
	The device's temperature is below 0°C or higher than 40°C.	Adjust the battery charging environment to avoid extreme temperatures.
	Poor contact between the battery and charger.	Check all connectors to ensure that all connections have been properly made.
Unable to turn the tablet on.	The battery is empty.	Charge the device.
Shortened standby time.	The duration of standby time is affected by your service provider's system configuration. The same device used with different service providers' systems does not have the same duration of standby time.	If you are located in an area where the network signal is weak, temporarily turn off your device.
	If you are not able to connect to the network, the device will continue to send out signals as it attempts to locate a base station. Doing this consumes battery charge and consequently shortens standby time.	Change your location to one where the network is accessible, or temporarily turn off your device.
Messaging problem		
Unable to send or receive email.	The Internet connection or the email setting is not configured properly.	Check your network connection, and confirm with your email service provider if your email setting has been configured correctly.
Media problems		
Windows Media Player on my computer cannot play the sounds of the video captured using the tablet.	The device records video sounds in amr format, but Windows Media Player does not support amr decoding.	Play the video using a video player with the amr recoder, such as QuickTime.

Internet problems		
Unable to connect to the network.	You are not within the network's service area.	Check the service area with your service provider.
	Poor signal.	Move to an open space or if you are inside a building, move closer to a window.
	Your tablet is in Airplane mode with no wireless connectivity.	Tap  > Settings > Wireless & networks > More to close the Airplane mode .

Warnings and Precautions

Certification Information for CE Statement

Users have to use the connection to USB interfaces with USB 2.0 version or higher.

Battery Caution

Risk of explosion if battery replaced by an incorrect type.

Dispose of used batteries according to the instructions.

The device could be used with a separation distance of 0cm to the human body.

The adapter shall be installed near the equipment and shall be easily accessible.



To prevent possible hearing damage, do not listen at high volume levels for long periods.

Dell code	Size	Model name	Type name
Thunderbird (WLAN-only)	7"	T01C	T01C001
Yellowtail (WLAN-only)	8"	T02D	T02D001

These devices complied with the essential requirements of Article 3 of the R&TTE 1999/5/EC Directive.

All the reports of the applied standards have the Positive Opinion of Notified Body:

PHOENIX TESTLAB, Königswinkel 10 D-32825 Blomberg, Germany

CE 0700

Certification Information for IC/FCC Statement

Federal Communications Commission (FCC) Declaration of Conformity

This device complies with part 15 of the FCC Rules. Operation is subject to the following two conditions: (1) This device may not cause harmful interference, and (2) this device must accept any interference received, including interference that may cause undesired operation.

Changes or modifications not expressly approved by the party responsible for compliance could void the user's authority to operate the equipment.

This device has been tested and found to comply with the limits for a Class B digital, pursuant to Part 15 of the FCC Rules. These limits are designed to provide reasonable protection against harmful interference in a residential installation. This equipment generates, uses and can radiate radio frequency energy and, if not installed and used in accordance with the instructions, may cause harmful interference to radio communications. However, there is no guarantee that interference will not occur in a particular installation. If this equipment does cause harmful interference to radio or television reception, which can be determined by turning the equipment off and on, the user is encouraged to try to correct the interference by one or more of the following measures:

- Reorient or relocate the receiving antenna.
- Increase the separation between the equipment and receiver.
- Connect the equipment into an outlet on a circuit different from that to which the receiver is connected.
- Consult the dealer or an experienced radio/TV technician for help.

FCC Caution:

Changes or modifications not expressly approved by the party responsible for compliance could void the user's authority to operate the equipment.

Industry Canada Note

This complies with Industry Canada license-exempt RSS standard(s). Operation is subject to the following two conditions:

- (1) This device may not cause interference, and
- (2) This device must accept any interference, including interference that may cause undesired operation of the device.

Le présent appareil est conforme aux CNR d'Industrie Canada applicables aux appareils radio exempts de licence. L'exploitation est autorisée aux deux conditions suivantes:

- (1) l'appareil ne doit pas produire de brouillage, et

(2) l'utilisateur de l'appareil doit accepter tout brouillage radioélectrique subi, même si le brouillage est susceptible d'en

This Class B digital apparatus complies with Canadian ICES-003.

Cet appareil numérique de la classe B est conforme à la norme NMB-003 du Canada.

FCC RF Exposure Information (SAR)

This device is designed and manufactured not to exceed the emission limits for exposure to radio frequency (RF) energy set by the Federal Communications Commission of the United States.

During SAR testing, this is set to transmit at its highest certified power level in all tested frequency bands, and placed in positions that simulate RF exposure in usage near the body with the separation of 0mm. Although the SAR is determined at the highest certified power level, the actual SAR level of the device while operating can be well below the maximum value. This is because the device is designed to operate at multiple power levels so as to use only the power required to reach the network. In general, the closer you are to a wireless base station antenna, the lower the power output.

The exposure standard for wireless s employs a unit of measurement known as the Specific Absorption Rate, or SAR. The SAR limit set by the FCC is 1.6W/kg.

This device is compliance with SAR for general population /uncontrolled exposure limits in ANSI/IEEE C95.1-1992 and had been tested in accordance with the measurement methods and procedures specified in IEEE1528. This device has been tested, and meets the FCC RF exposure guidelines when tested with the device directly contacted to the body.

Dell code	Size	FCC ID	The maximum SAR Value
Thunderbird (WLAN-only)	7"	E2K-T01C001	0.33 W/Kg
Yellowtail (WLAN-only)	8"	E2K-T02D001	0.47 W/Kg

SAR compliance for body operation is based on a separation distance of 0mm between the unit and the human body.

IC Radiation Exposure Statement

This EUT is compliance with SAR for general population/uncontrolled exposure limits in IC RSS-102 and had been tested in accordance with the measurement methods and procedures specified in IEEE 1528 and IEC 62209. This equipment should be installed and operated with minimum distance 0 cm between the

radiator and your body. This device and its antenna(s) must not be co-located or operating in conjunction with any other antenna or transmitter.

Cet appareil est conforme aux limites d'exposition DAS incontrôlée pour la population générale de la norme CNR-102 d'Industrie Canada et a été testé en conformité avec les méthodes de mesure et procédures spécifiées dans IEEE 1528 et IEC 62209.

Cet appareil doit être installé et utilisé avec une distance minimale de 0 cm entre l'émetteur et votre corps. Cet appareil et sa ou ses antennes ne doivent pas être co-localisés ou fonctionner en conjonction avec tout autre antenne ou transmetteur.

Dell code	Size	IC
Thunderbird (WLAN-only)	7"	1514B-T01C001
Yellowtail (WLAN-only)	8"	1514B-T02D001