

Dell™ Streak Pro GS01

User's Manual



Notes, Cautions, and Warnings



NOTE: A NOTE indicates important information that helps you make better use of your smartphone.



CAUTION: A CAUTION indicates potential damage to hardware or loss of data if instructions are not followed.



WARNING: A WARNING indicates a potential for property damage, personal injury, or death.

Information in this document is subject to change without notice.

© 2011 Dell Inc. All rights reserved.

Reproduction of these materials in any manner whatsoever without the written permission of Dell Inc. is strictly forbidden.

Trademarks used in this text: Dell™ and the DELL logo are trademarks of Dell Inc.; Adobe Acrobat® is a trademark of Adobe Systems Incorporated which may be registered in certain jurisdictions; Microsoft®, Windows®, Excel®, and Powerpoint® are either trademarks or registered trademarks of Microsoft Corporation in the United States and/or other countries; Bluetooth® is a registered trademark owned by Bluetooth SIG, Inc. and is used by Dell under license.

Other trademarks and trade names may be used in this document to refer to either the entities claiming the marks and names or their products. Dell Inc. disclaims any proprietary interest in trademarks and trade names other than its own.

September 2011 A00

Federal Communications Commission (FCC) Statement

This smartphone complies with Part 15 of the FCC Rules. Operation is subject to the following two conditions:

- 1) this smartphone may not cause harmful interference and
- 2) this smartphone must accept any interference received, including interference that may cause undesired operation of the smartphone.

FCC RF Radiation Exposure Statement:

For body worn operation, this smartphone has been tested and meets FCC RF exposure guidelines when used with an accessory that contains no metal and that positions the handset a minimum of 1.0 cm from the body. Use of other accessories may not ensure compliance with FCC RF exposure guidelines.

CE Marking

This device has been tested to and conforms to the regulatory requirements of the European Union and has attained CE Marking. The CE Mark is a conformity marking consisting of the letters "CE". The CE Mark applies to products regulated by certain European health, safety and environmental protection legislation. The CE Mark is obligatory for products it applies to: the manufacturer affixes the marking in order to be allowed to sell his product in the European market.

Contents

1	Setting Up Your Dell Streak Pro GS01 Smartphone	7
	Getting Your Smartphone Ready for Use	7
	Turning On Your Smartphone	9
	Turning Off Your Smartphone	10
	Turning Off the Screen	10
2	Dell Streak Pro GS01 Smartphone Features	11
	Touch Screen	16
	Screen Orientation	22
	Applications, Widgets, and Shortcuts	22
	The Stage Desktop	23
	Dell Stage Widgets	26
	Status Bar	38
	Quick Buttons	41
	Navigating Applications	41
3	Using Your Dell Streak Pro GS01 Smartphone	43

Calling	43
Managing Contacts	51
Messaging	55
Pop-Up Menu	60
Android Keyboard	61
OpenWnn/Flick Support Keyboard	65
Google Search Widget	67
Power Control Widget	68
Managing Your Smartphone Settings	69
4 Internet	71
Connecting to the Internet	71
Browsing the Internet	76
E-mail	83
Google Applications	85
Dell Applications	125
More Web Applications	133
5 Applications	152
Camera	152
Copying Files to and from the Phone Memory	
Cards	158

	Bluetooth	159
	Photos and Videos	162
	Music	166
	Calendar	168
	Alarm Clock	171
	FM Radio	173
	Calculator	174
	Sound Recorder	174
	Voice Dialer	175
6	Customizing Your Dell Streak Pro GS01 Smartphone	176
	Change the Display Settings	176
	Change Sound and Ringtone Settings	177
	Manually Set the Date, Time and Time Zone	179
	Set the Language	180
7	Protecting Your Dell Streak Pro GS01 Smartphone	181
	Protect Your Smartphone Data With a Screen Unlock Pattern	181
	Protect Your Smartphone Data With a PIN	183
	Protect Your Smartphone Data With a Password	184

	Protect Your Micro-SIM Card With the SIM Lock Password	184
8	Troubleshooting	186
	Starting Your Smartphone in the Safe Mode	192
9	Index	193

1 Setting Up Your Dell Streak Pro GS01 Smartphone

Getting Your Smartphone Ready for Use

 **CAUTION:** You must switch off your phone before removing or inserting the micro-SIM card.

1 Open the micro-SIM and microSD card cover

Using your fingertip, lift the micro-SIM and microSD card cover.

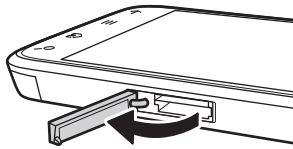

2 Insert the microSD card and the micro-SIM card

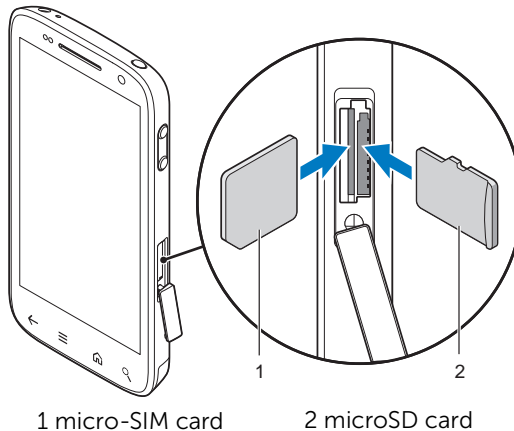

 **NOTE:** The contact side of the micro-SIM card must face towards the front of the phone and the contact side of the microSD card must face towards the back of the phone.

 **NOTE:** The micro-SIM card and microSD card may be pre-installed.

3 Close the micro-SIM and microSD card cover

4 Charge the smartphone

The battery is not fully charged when first unpacked.

- a Plug the supplied USB cable's micro USB connector into the connector on the smartphone.
- b Plug the other end of the cable to the supplied USB wall charger plug.
- c Plug the USB wall charger plug into an electric outlet and charge the smartphone till the battery is fully charged.

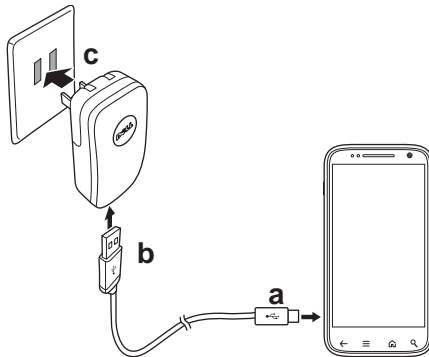



 **NOTE:** Charge the battery in an environmental temperature between 0°C and 45°C.

 **NOTE:** The smartphone is fully charged within two hours when connected to a power outlet.

 **NOTE:** The battery is sealed and cannot be replaced. To change the battery, take it to the nearest customer service center. Do not service the smartphone yourself.

 **NOTE:** To charge your smartphone using a computer, connect the supplied USB cable's micro USB connector to the smartphone, and the other end of the cable to a USB connector on the computer.

 **NOTE:** The type of USB wall charger plug may vary depending on the country/region where you purchased the smartphone.

 **CAUTION:** Do not drop your smartphone or use your smartphone under water. These actions may damage the phone; any damage resulting from these actions will not be covered by the warranty.

 **CAUTION:** Do not tear off any parts of the smartphone housing. This may damage your smartphone; any damage resulting from this action will not be covered by the warranty.

Turning On Your Smartphone

 **NOTE:** Use this smartphone in an environmental temperature between -10°C and 55°C.

- 1 Press and hold the Power button to turn on your smartphone. The operating system starts up.
- 2 If the screen is locked, flick the  icon to the right to unlock the screen.
- 3 If your micro-SIM card is locked by a Personal Identification Number (PIN), type the PIN by touching the corresponding number keys using the on-screen keypad. Touch the **OK** button to confirm your input.
- 4 The smartphone is ready for use when the default Home screen is displayed.

Turning Off Your Smartphone

- 1 Press and hold the Power button.
- 2 Touch the **Power off** option on the screen.

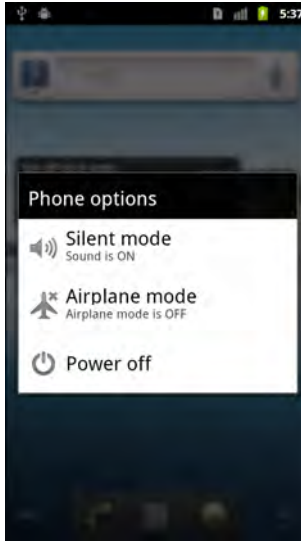

Turning Off the Screen

If both the smartphone and the screen are on, press the Power button to turn off the screen.



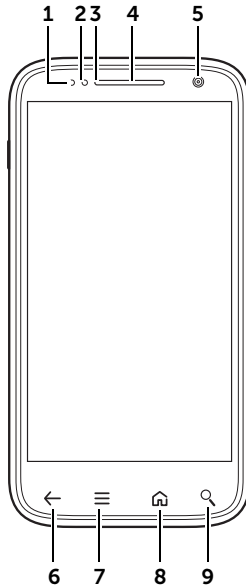

 **NOTE:** If the smartphone is on, but the screen is off, press the Power button to turn on the screen.

2 Dell Streak Pro GS01 Smartphone Features

This section provides information about the features available on your Dell Streak Pro GS01 smartphone.



Feature	Function(s)
1 Proximity sensor	Automatically turns off the screen as you bring the smartphone close to your face to make or receive calls, in order to prevent touching the screen accidentally.
2 Ambient light sensor (ALS)	Controls screen brightness according to the surrounding light.

Feature	Function(s)
3 Battery status indicator	Indicates the battery status: <ul style="list-style-type: none"> • Green: Battery is fully charged. • White: Battery is charging.
4 Earpiece	Use to listen to phone conversations.
5 Front Camera	Use for video calls.
6 Back button 	Touch to return to the previous screen, close a dialog box, menu, or pop-up message, and to dismiss the keyboard.
7 Menu button 	Touch to open or close the pop-up menu that displays the available options for the current application or actions that you can perform on the current screen.
8 Home button 	<ul style="list-style-type: none"> • Touch to return to the default Home screen. • Touch and hold: For quick access to the recently accessed applications.
9 Search button 	Touch to search items on your smartphone, such as a contact or a music file, or search the Internet using Google Search Engine.

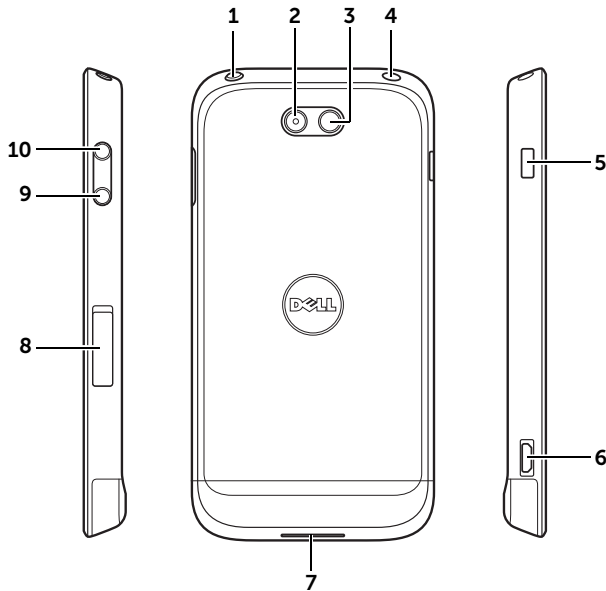

Feature	Function(s)
<p>1 Power and Sleep/Wake button</p>	<ul style="list-style-type: none"> • If the smartphone is off, press and hold to turn on the smartphone. • If the smartphone is on, but the screen is off, press to turn on the screen. • If both the smartphone and the screen are on, <ul style="list-style-type: none"> – Press to turn off the screen. – Press and hold to select one of these options: <ul style="list-style-type: none"> Silent mode: The smartphone is set to vibrate mode; all sounds are disabled except for alarms. Enable airplane mode: Select to disable all wireless connections. Power off: Turn off the smartphone.

Feature	Function(s)
2 Camera flash	For using while capturing photos and videos.
3 Camera lens	Captures photos and videos.
4 Headphone connector	Connects to headphones.
5 Ring/Silent switch	<p>Switches between ring and silent modes.</p> <ul style="list-style-type: none"> • Slide the switch forward to enable silent mode. The  icon appears in the status area. • Slide the switch backward to enable ring mode.
6 Micro-USB connector	<ul style="list-style-type: none"> • Connects to a USB cable to transfer files to a computer. • Connects to a charger to charge the smartphone.
7 Speaker and speakerphone	Audio output for video and music playback.
8 Micro-SIM and microSD card cover	Secures the micro-SIM card and microSD card.
9 Volume down button	<ul style="list-style-type: none"> • While playing media such as music tracks or video clips: <ul style="list-style-type: none"> – Press to decrease the media volume by one level. – Press and hold to continuously decrease the media volume. • Press to mute the ringer while receiving a call. • In all other situations: <ul style="list-style-type: none"> – Press to decrease the ringer volume by one level. – Press and hold to continuously decrease the ringer volume.

Feature	Function(s)
10 Volume up button	<ul style="list-style-type: none">• While playing media such as music tracks or video clips:<ul style="list-style-type: none">– Press to increase the media volume by one level.– Press and hold to continuously increase the media volume.• Press to mute the ringer while receiving a call.• In all other situations:<ul style="list-style-type: none">– Press to increase the ringer volume by one level.– Press and hold to continuously increase the ringer volume.

Touch Screen

Your smartphone has a multi-touch sensitive screen. You can touch the surface of the screen to operate the smartphone.

Finger Gestures

Allows You To:

Touch

Touch gently on the screen with your fingertip.

- Select the items on the screen including options, entries, images, and icons.
- Start applications.
- Press the buttons on the screen.
- Input text using the on-screen keyboard or numeric keypad.



Finger Gestures**Allows You To:**

Touch and hold

Touch and hold your finger on the screen.

Move an item on a Home screen.



Finger Gestures**Allows You To:**

Drag

- 1 Touch and hold your finger on an item on the screen.
 - 2 Keeping your finger in contact with the screen, move your fingertip to the desired location.
 - 3 Take your finger off the screen to drop the item in the desired location.
- Move items such as images and icons on the screen.
 - Delete items such as images and icons from the screen.



Finger Gestures

Allows You To:

Flick or swipe

Move your finger in a vertical or horizontal direction on the screen.

Scroll through Home screens, web pages, lists, entries, photo thumbnails, contacts, and so on.



Finger Gestures**Allows You To:**

Zoom out

Move two fingers close together on the screen.

Reduce the view of an image or web page.



Finger Gestures**Allows You To:**

Zoom in

Move two fingers apart on the screen.

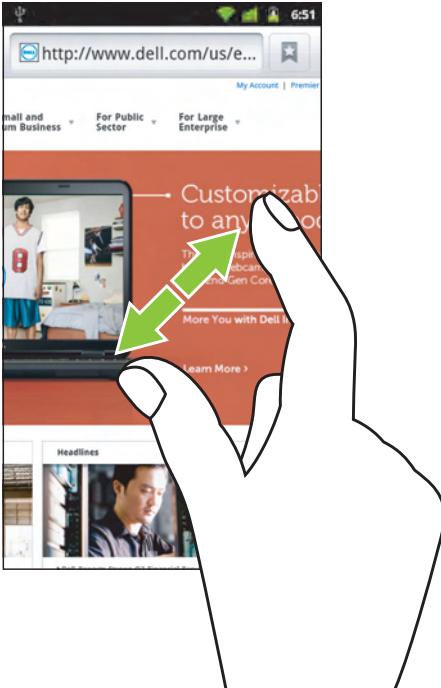

Enlarge the view of an image or web page.



Screen Orientation

For optimal viewing experience, the screen orientation changes automatically to portrait or landscape format depending on how you hold the smartphone.

 **NOTE:** The Home screens are always displayed in portrait format and do not automatically orient to landscape format. Depending on the application, some applications downloaded from the Android Market may not support automatic screen orientation to landscape or portrait format nor support landscape orientation.

 **NOTE:** To modify the default behavior, open the orientation settings by touching  →  → **Settings** → **Display** → **Auto-rotate screen**.

Applications, Widgets, and Shortcuts

Application - Software which allows you to perform a specific task. Your smartphone is preloaded with a variety of applications, and additional applications can be downloaded from the Android Market.

Widget - A small application which resides on a Home screen and provides quick and easy access to information.

Shortcut - A link that you can add on a Home screen to provide quicker access to an application or a folder containing contacts or bookmarks.

The Stage Desktop

As part of the new Dell Stage interface, the Stage desktop is composed of seven individual Home screens. The desktop displays predefined Stage widgets, shortcuts, and widgets to give you quick and easy access to your most recently-used applications, Twitter or Facebook postings, music, pictures, and more.

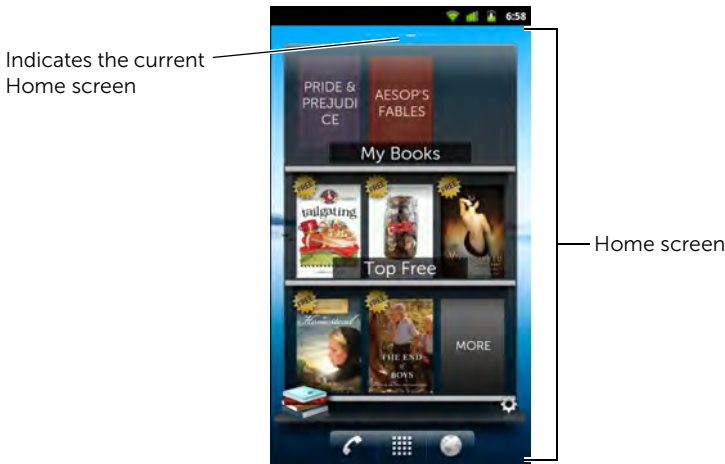

You can customize the Stage desktop to your personal preferences by adding your own shortcuts or widgets, or by displaying your favorite picture as the desktop wallpaper.

 **NOTE:** For more information on using Dell Stage widgets, see "Dell Stage Widgets" on page 26.

 **NOTE:** To return to the default Home screen from anywhere, touch .

 **NOTE:** The availability and functionality of the widgets described in this manual vary by region and software version. You can check if newer versions of the software are available by checking for **System updates** in the **About phone** section of the **Settings** application.

To navigate across the Home screens

Flick the home screen horizontally until the desired Home screen is displayed.



To quickly pan through Home screens

- To activate fast scroll control, flick on the accelerator strip to quickly pan through and go to the desired Home screen.

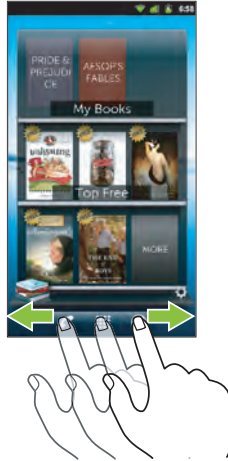

- To go to the left-most Home screen, touch area **1** as shown below. To go to the right-most Home screen, touch area **2** as shown below.



Dell Stage Widgets

 **NOTE:** The availability and functionality of the Dell Stage widgets described in this manual vary by region and software version. You can check if newer versions of the software are available by checking for **System updates** in the **About phone** section of the **Settings** application.

Dell Stage widgets are designed to provide you direct access to your most recently-used applications, e-mails, photos, music, videos, contacts, books, news feeds, radio channels, Facebook & Twitter applications, and frequently-used websites.

You can use the free Home screens to add the other Stage widgets. The following are the available Dell Stage widgets:

- Contacts (see "Using the Contacts Stage widget" on page 27)
- Email (see "Using the Email Stage widget" on page 28)
- Photos (see "Using the Photo Stage widget" on page 29)
- Radio (see "Using the Radio Stage widget" on page 30)
- Social (see "Using the Social Stage widget" on page 31)
- Web (see "Using the Web Stage widget" on page 32)

Adding a Stage Widget

- 1 Navigate to a free Home screen.
- 2 Touch and hold on the Home screen until the **Add to Home screen** menu appears.
- 3 Touch **Stage Widgets**.
- 4 From the **Select Stage Widget** menu, touch to select the Stage widget you want to add to the Home screen.

Deleting a Stage Widget

To delete a Stage widget, touch and hold the Stage widget, and then drag it to the  icon that appears at the bottom of the screen. When the Stage widget turns red, release your finger from the screen.

Using Stage Widgets

Using the Contacts Stage widget

From the **Contacts** Stage widget, you can view all your contacts, or add a new contact quickly.

- Touch a favorite contact to select the action to proceed with.
- Touch  to go to your address book to add a new contact. For information on adding contacts, see "To add a new contact" on page 56.

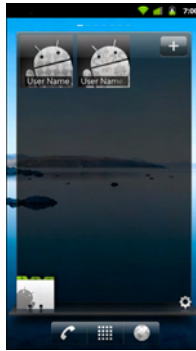

 **NOTE:** The following Settings menu may not be available in all versions of this widget.

To go to **CONTACTS SETTINGS**, touch . You can select the contacts you want to display in this widget view, such as **All Contacts** (default), **Favorites**, **Most Frequent**, and **Most Recent**.

Touch  when you have completed the settings.

Using the Email Stage widget

From the **Email** Stage widget, you can read the e-mail messages in your e-mail account or compose a new message. If you have not set up an e-mail account, touch **ADD AN ACCOUNT** and follow the instructions on the screen to complete your e-mail configuration.

- Touch an e-mail message to view the message.
- To compose a new e-mail message in the **Email** application, touch .

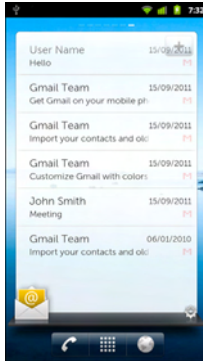

 **NOTE:** The following Settings menu may not be available in all versions of this widget.

To go to **EMAIL SETTINGS**, touch .

- Touch on check boxes to add/remove accounts from this widget view.
- Touch **ADD AN ACCOUNT**, if you want to add more e-mail accounts.

Touch  when you have completed the settings.

Using the Photo Stage widget

- From the **Photo Stage** widget, you can view thumbnails of the pictures taken using the **Camera** application, or thumbnails of the pictures in the "DCIM" folder of the microSD card. Touch a thumbnail to open a picture.



NOTE: Some versions of this widget may display videos and images from other locations.

- Touch  to capture a new picture or video.

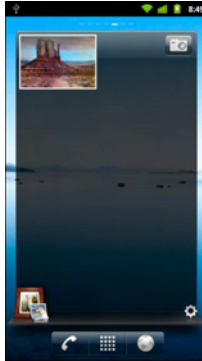

NOTE: The following Settings menu may not be available in all versions of this widget.

To go to **PHOTOS SETTINGS**, touch . Touch on check boxes to select whether you want to display the image files from your smartphone or from Facebook in this widget view.

Touch  when you have completed the settings.

Using the Radio Stage widget

The **Radio** Stage widget displays radio stations from the **TuneIn Radio** application.

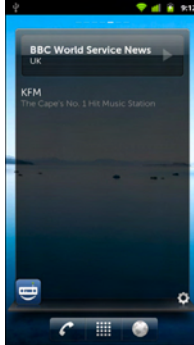

 **NOTE:** The following Settings menu may not be available in all versions of this widget.

To go to **RADIO SETTINGS**, touch .

- To display a list of your preset radio stations in this widget view, touch **Preset Stations**.
- To display the radio stations you have listened to recently in this widget view, touch **Recent Stations**.

Touch  when you have completed the settings.

Using the Social Stage widget

The **Social** Stage widget provides shortcuts to Facebook and Twitter applications.

 **NOTE:** The **Social** Stage Widget displays either Facebook or Twitter. If you want to display both applications on the Home screen, add another **Social** widget to a different screen and sign in to the appropriate service there.

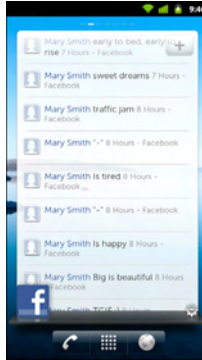

 **NOTE:** The following Settings menu may not be available in all versions of this widget.

To go to **SOCIAL SETTINGS**, touch .

- To set the refresh interval, touch **Refresh** and select the desired refresh frequency.
- To log out from your account, touch **Log Out** and **OK**.

Touch  when you have completed the settings.

Using the Web Stage widget

The **Web** Stage widget displays your website bookmarks. Flick vertically to view the available bookmarks. Touch the website you want to visit, or touch  to use Google Search.



 **NOTE:** The following Settings menu may not be available in all versions of this widget.



To go to **WEB SETTINGS**, touch .

- To display all the available bookmarks in this widget view, touch **Bookmarks**.
- To display only the most frequently-visited sites, touch **Most Visited Sites**.





Touch  when you have completed the settings.

Customizing Your Home Screens



To add an item on a Home screen

- 1 Touch .
- 2 To access the **Add to Home screen** menu, either:
 - Touch and hold an empty area on a home screen.
 - Touch  and then touch the **Add** option.
- 3 Touch the item you want to add on the Home screen:

Items	Steps
Shortcuts Add shortcuts for items that you want to access directly from the Home screen.	Applications: <ol style="list-style-type: none">1 Flick the application menu to locate the desired application.2 Touch the desired application to create the shortcut on the current Home screen. Bookmark: <ol style="list-style-type: none">1 Flick the Bookmarks list to locate the desired bookmark.2 Touch the desired bookmark to create the shortcut on the current Home screen. Contact: <ol style="list-style-type: none">1 Flick the Contacts entries to locate the desired contact.2 Touch the desired contact to create the shortcut on the current Home screen. Direct dial: <p>Touch the desired phone number to create the shortcut on the Home screen. You can touch the shortcut to dial the number directly.</p> Direct message: <p>Touch the desired phone number to create the shortcut on the Home screen. You can touch the shortcut to compose and send a message to the desired phone number.</p>

Items	Steps
Shortcuts	<p>Directions & Navigation: Create a shortcut that you can touch to open Google Maps and view directions to a location.</p> <ol style="list-style-type: none"> 1 Type your destination in the Destination field. 2 Choose how you want to get to your destination by touching the By car , By public transit , By bike , or Walking  icon (from left to right). 3 Type a name for the short cut in the Shortcut name field. 4 Touch the shortcut icon that you want to use for the shortcut. 5 Touch the Save button. <p>NOTE: For more information on getting directions using Google Maps, see "To get directions" on page 105.</p> <p>Latitude: Create a shortcut that you can touch to open Google Latitude to share locations with your friends and family who have signed in to the service with their Google accounts.</p> <p>Music playlist: Create a Play all or a Recently added shortcut that you can touch to play all songs or recently added songs.</p> <p>Settings:</p> <ol style="list-style-type: none"> 1 Scroll through the settings to locate the desired setting. 2 Touch the desired setting to create the shortcut on the current Home screen.

Items	Steps
<p>Widgets</p> <p>Add widgets to display active Home screen windows or controls for your favorite applications or web-based services, such as an analog clock, the music player, the Google Quick Search Box, or a calendar showing upcoming events.</p>	<ol style="list-style-type: none"> 1 Touch and hold an empty area on a Home screen. 2 Touch Widgets in the Add to Home screen menu that appears. 3 Flick the available applications or services to locate the desired one. 4 Touch the desired widget to add it on the Home screen.
<p>Folders</p> <p>Add folders to organize items on your Home screen.</p>	<p>You can create the following folders:</p> <p>New folder: Add a folder where you can store your Home screen shortcuts.</p> <p>All contacts: Add a shortcut to all your contacts stored in the Contacts application.</p> <p>Bluetooth received: Add a shortcut to access files received through Bluetooth.</p> <p>Contacts with phone numbers: Add a shortcut to the contacts with phone numbers.</p> <p>Starred contacts: Add a shortcut to the contacts marked with a star.</p> <ol style="list-style-type: none"> 1 Touch the desired folder to create a folder on the Home screen. 2 Once the folder is on your Home screen, you can drag and drop an item on top of the folder in order to add it to the folder.

Items	Steps
<p>Wallpapers</p> <p>Change the wallpaper of your Home screen.</p> <p>NOTE: You can also touch  →  → Wallpaper to change your Home screen wallpaper.</p>	<p>Gallery: Open the Gallery application and select a saved picture as a wallpaper, or touch  to open the camera application and capture a picture that you can set as a wallpaper.</p> <ol style="list-style-type: none"> 1 Touch a picture category from your collection, such as Camera, bluetooth, and so on. 2 Flick the picture thumbnails horizontally to locate the desired picture. 3 Touch the picture to display it. 4 To cut a portion of the picture as the wallpaper, move the crop frame and drag the angles to locate the desired part. 5 Touch the Save button to set the wallpaper. <p>Wallpapers: Flick to or touch a picture thumbnail to display a picture, then touch Set wallpaper to set it as a wallpaper.</p>

To add an application shortcut to a Home screen

- 1 Touch  at the bottom of the screen to enter the main applications view.
- 2 On the main applications view, touch, and hold a desired application and drag it onto the current Home screen. The application icon appears on the Home screen.

To move a Home screen item

- 1 Touch and hold the item you want to reposition until it magnifies and moves. The smartphone vibrates to indicate that the item's moving mode is activated.

 **NOTE:** To disable the item's moving mode, release the item.

- 2 With your finger remaining in contact with the item on the screen, drag the item to another location on the screen.
- 3 Release the item in the desired location.

To remove a Home screen item

- 1 Touch and hold an item such as a widget, shortcut, or folder that you want to remove, until it magnifies and moves.
- 2 Drag it to the Trash icon  that appears at the bottom of the screen.

To move a Home screen shortcut into a folder

- 1 Touch and hold the shortcut you want to move.
- 2 Drag and drop the shortcut into a folder on the Home screen.



NOTE: Widgets and folders cannot be moved inside a folder.

To open a Home screen folder

- 1 Touch the folder to open the panel displaying the contents of the folder.
- 2 Touch the desired application shortcut to run the application.

To remove a Home screen shortcut from a folder

- 1 Touch a folder on the Home screen to view the contents.
- 2 Touch and hold the shortcut you want to remove.
- 3 Drag the shortcut in the folder to the Trash icon  that appears at the bottom of the screen.

To close a Home screen folder

Touch the Close icon  to close the panel.

To rename a folder

- 1 Touch the folder you want to rename. A panel displaying the contents of the folder appears.
- 2 Touch and hold the top area of the folder panel , until the **Rename folder** menu pops up.
- 3 Touch the Folder name input field to type the name using the on-screen keyboard.
- 4 Touch **OK** to confirm.

Status Bar

The status bar at the top of the Home screen displays the notification, status, and time areas.































1 Notification area	<ul style="list-style-type: none">• The notification area displays notification icons to inform you of missed calls, new e-mail, messages, and so on.• Touch and drag the status bar down to view the notifications listed in the order of arrival time, and then touch a notification to view the desired message, e-mail, or missed call record.
2 Status area	<ul style="list-style-type: none">• Displays status icons to show the current state of your smartphone, such as battery power, charging progress, alarms set, network connections, and so on.• Touch and drag the status bar down to view the information regarding the carrier currently in use, remaining battery charge, and so on.
3 Time area	Displays the current time.

The notification area may also display some of the following icons:

 Missed call	 Problem with sign-in or sync
 Call in progress	 Problem with SMS/MMS delivery
 Call on hold	 microSD card is full or removed
 Call forwarding is enabled	 Preparing the microSD card
 Call in progress using a Bluetooth headset	 The microSD card is safe to remove
 New Gmail message	 Some notifications not displayed
 New SMS/MMS	 Song is playing
 New Google Talk message	 Download in progress
 Google Talk Voice chat is on	 Download is complete
 New voicemail	 Application update is available
 Upcoming calendar event	 USB cable is connected
 New e-mail message	

The status area may also display some of the following icons:

 Alarm is set	 3G data network is connected
 Battery status — 100% full	 3G data network is in use
 Battery is low and needs to be charged	 GPRS data network is connected
 Battery is extremely low and needs to be charged immediately	 GPRS data network is in use
 Battery is charging	 EDGE data network is connected
 Vibrate mode is enabled	 EDGE data network is in use
 Silent mode is enabled	 HSPA data network is connected (only available for carrier-specific versions)
 Microphone is on mute	 HSPA data network is in use (only available for carrier-specific versions)
 Speakerphone is on	 Roaming signal strength — strong
 Signal strength — strong	 Connected to a Wi-Fi network
 No signal	 No micro-SIM card is inserted
 Airplane mode is enabled	 GPS satellites function is enabled
 Bluetooth is enabled	 Receiving location data from GPS satellites
 Connected to a new Bluetooth device	 Ongoing data synchronization
 The headphone is connected	

Quick Buttons

The quick buttons at the bottom of the Home screen allow you to access the application menu and some main functions quickly.

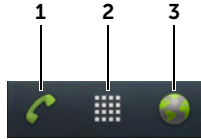

1 Phone button	Touch to open the Phone application to make calls.
2 Launcher button	Touch to display the applications menu: <ul style="list-style-type: none">• The applications menu contains all of the applications on your smartphone, including those you have downloaded from the Android Market.• Touch an application to launch it.
3 Browser button	Touch to open the Browser application.



Navigating Applications

You can find applications available on your smartphone in these screen elements:

Application Drawer

The application drawer can be accessed from any home screen and contains all of the applications installed on the smartphone, including those you have downloaded from the Android Market.



To open the application drawer

- 1 Touch  to display the default Home screen.
- 2 From any of the Home screens, you can:
 - Flick a finger upwards from the bottom the screen.
 - Touch .

To navigate pages of applications

Flick the applications drawer horizontally and touch an application to run it.

To close the application drawer

- Flick a finger downwards in the application drawer.
- To return to the default Home screen, touch .
- To return to the current Home screen, touch .

Application Shortcuts

To quickly launch applications on the Home screen, you can add shortcuts for frequently-used applications to a Home screen or to the folder that you created on a Home screen. For more information, see "Customizing Your Home Screens" on page 33.

To open an application using the application shortcuts

- 1 Touch .
- 2 If the desired application shortcut is displayed on one of the Home screens, touch the shortcut to launch the application.
If the desired application is stored in a folder on one of the Home screens, touch the folder to display the contents of the folder, and then touch the desired application shortcut.

Recent Applications

To open a recently used application



- 1 Touch and hold  to view the recently used applications.
- 2 Touch the desired application shortcut to launch the application.

3 Using Your Dell Streak Pro GS01 Smartphone

Calling





Making Calls

To make calls, you can perform either of the following:

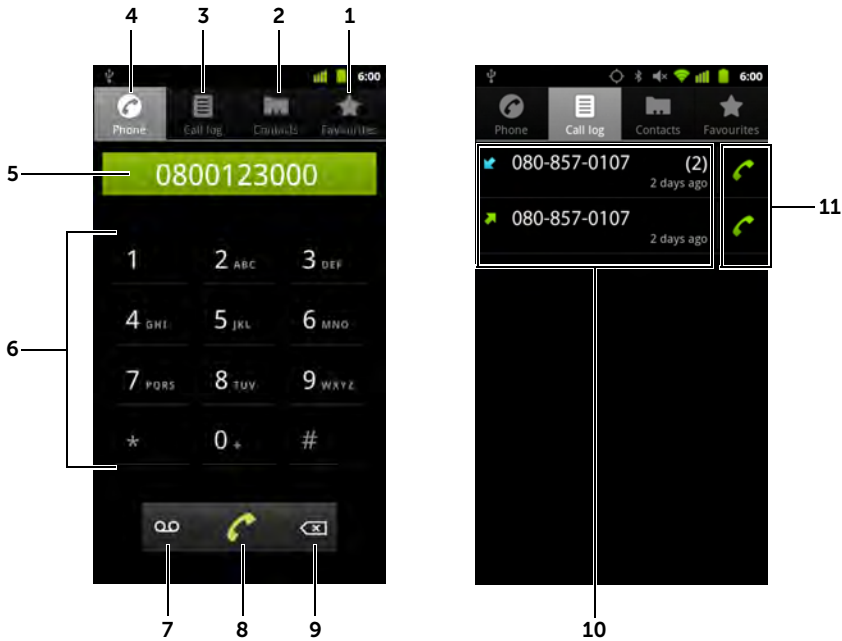
- Touch  on the Home screen to open the Phone application.
- Touch  to open the applications menu and flick the screen horizontally and touch **Phone**  on the applications menu to open the Phone application.

To make a call



- 1 Touch to select a contact from your Favorites contact list. Touch a contact and then touch  to call or touch  to send a text message to the contact.
- 2 Touch to select a contact from your Contacts list. Touch a contact and then touch  to call or touch  to send a text message to the contact.
- 3 Touch to view the call log, call or text message the caller, or save or view the caller in Contacts.
NOTE: To erase all calls from the call log, touch  → **Clear call log** → **OK**.
- 4 Touch to open the on-screen dialpad.
- 5
 - Touch to move the cursor.
 - Touch and hold to bring up the Edit text pop-up menu.
- 6 Type the number to call using the on-screen dialpad.

7 Touch to call your voicemail box.

NOTE: If no voicemail number is stored on your micro-SIM card, you will be prompted to enter a number. Touch **Add number** to enter and save your voicemail number.

8 Touch to call the typed number.

9 Touch to clear an incorrect number.

10 Touch a call record to view the call information, call or send a message to the caller, or save or view the caller in Contacts. For more information on using Contacts, see "Managing Contacts" on page 51.

11 Touch to call a desired phone number or contact from the call log.

To make an international call

1 Touch and hold the number 0 key on the dialpad until "+" appears.

2 Enter the country code, area code, and phone number.

3 Touch  to make the call.

To listen to your voicemail

Touch and hold the number 1 key on the dialpad to call your voicemail box.



NOTE: If no voicemail number is stored on your micro-SIM card, you will be prompted to enter a number. Touch **Add number** to enter and save your voicemail number.

To answer or reject an incoming call

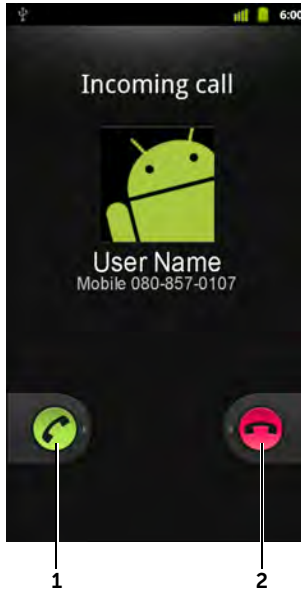





1 Drag  to the right to answer an incoming call.

2 Drag  to the left to reject an incoming call.

Controls during a call



-
- 1**
 - Touch to hold an active call. To resume a held call, touch .
 - Touch  to swap between active and held calls.

 - 2**
 - Touch  to bring up the dialpad and make another call. The first call is placed on hold automatically.
 - Touch  to connect the active and held calls to have a conference call.

 - 3** Touch to accept calls using a Bluetooth headset when a Bluetooth headset is paired with your smartphone. For information on pairing a Bluetooth headset to your smartphone, see "Bluetooth" on page 159.

 - 4** Touch to mute the microphone during a call.
-

5 Touch to turn the speaker on or off.





WARNING: Ensure that you turn off the speaker before you hold the smartphone close to your ear as this could damage your hearing.

6 Touch to open the dialpad for dialing.

7 Touch to end an active call or cancel dialing.

Adjust Call Settings

You can change call settings to suit your personal needs, or enable the call services available from your network service provider.

Touch  →  → **Settings** → **Call settings** → **Call Feature Settings**.

Fixed Dialing Numbers (FDN) Restricts outgoing calls to the phone numbers on the FDN list. To enable this service, you need to enter your micro-SIM card's PIN2 that you can obtain from your network service provider.

Voicemail

- **Voicemail service:** Displays the name of your carrier.
 - **Voicemail settings:** Stores another voicemail number other than the one already on your micro-SIM card.
-

Other call settings

- **Call forwarding:** Diverts incoming calls to a designated phone number when your phone is busy, unreachable, does not answer, or if you want to always forward calls.

To enable call forwarding, enter the number to divert to or touch  to select a contact from your Contacts list, and then touch **Enable**.

NOTE: Your smartphone can use Call forwarding only if the Call forwarding function is supported by your network service provider.

- **Additional settings:**

– **Caller ID:** Shows the caller ID or number on the screen based on the setting.

NOTE: Your smartphone displays the caller ID only if the caller ID function is supported by your network service provider.



– **Call waiting:** Alerts an incoming call with a call waiting tone or message when you are on another call.

NOTE: To use call waiting, you may need to register this service with your service provider.

Internet call settings

- **Accounts:** Add SIP accounts to enable you to make Internet calls.
NOTE: You must have an existing SIP account subscription to use this feature.
 - **Receive incoming calls:** Check this box to enable your phone to receive Internet calls.**To add an account:**
 - 1 Touch the **Add account** button.
 - 2 Select **Username**, and then type the username of your SIP account.
 - 3 Touch **OK**.
 - 4 Select **Password**, and then type desired password.
 - 5 Touch **OK**.
 - 6 Select **Server**, and then type the server address of your SIP account.
 - 7 Select **Set as primary account** if you want to use the SIP account to make outgoing calls.
 - 8 Select **Optional settings** to configure other settings such as **Authentication username**, **Display name**, **Outgoing proxy address**, **Port number**, **Transport type**, and **Send keep-alive**.
 - 9 Touch **≡** → **Save** to save the account.
 - **Use Internet calling:** Select how you want to use the SIP account to make calls. The available options are:
 - **For all calls when data network is available:** Uses the SIP account to make all outgoing calls when a data network is available.
 - **Only for Internet calls:** Uses the SIP account to make outgoing Internet calls only.
 - **Ask for each call:** Whenever you make an outgoing call, the phone prompts you to select how you want to make the call.
-

Dell Streak Pro GS01 supports Teletypewriter (TTY) mode. TTY mode lets a user with speech or hearing disabilities have a phone conversation by typing. To enable TTY mode:

- 1 Touch  →  → **Settings** → **Call settings** → **TTY mode**.
- 2 Touch an option: **TTY Off**, **TTY Full**, **TTY HCO**, or **TTY VCO**.

Managing Contacts

To view and manage your contacts, do one of the following:

- Touch  →  → **Contacts** 
- Touch **Phone**  → **Contacts** .

To add a new contact

Touch the Menu button  → **New contact**.

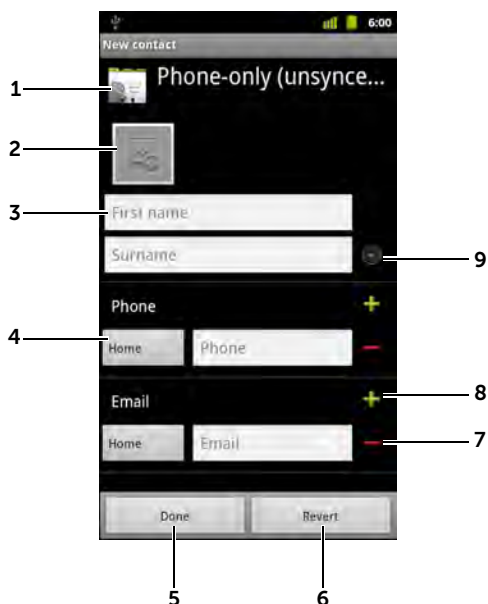

-
- 1 This area shows the location in which the new contact is stored.
 - 2 Touch to capture a photo or select a photo from the **Gallery** application to use as the contact's visual caller ID.
-

-
- 3 Enter the contact information using the on-screen keyboard. Scroll the screen to find more items to fill in.
 - 4 Touch to replace a default information label with another one that you choose from the **Select label** list, for example from **Home** phone number to **Mobile** phone number.
 - 5 Touch to save the new contact to your Contacts list.
 - 6 Touch to return to your Contacts list.
 - 7 Touch to remove an item from the current information category.
 - 8 Touch to add a new item to the current information category, for example a second e-mail address.
 - 9 Touch to fill in more name information. To view other information fields, such as postal address, organization, and more, flick a finger upwards.
-

To find a contact

- 1 To find a contact, you can either:
 - Flick the Contacts list until you find the contact.
 - Touch **≡** → **Search**, and then type either the contact's full name or only the first letters of it into the search box. The screen displays the matching contacts.
- 2 Once the contact is found, touch the contact's entry to view the contact's details.

To call, e-mail, or send a message to a contact

- From the Contacts list, select a desired contact.



-
- 1 Touch to see the actions that you can do with the contact.
 - 2 Touch to call the contact.
-

-
- 3 Touch to text message the contact.
 - 4 Touch to e-mail the contact using Email.
 - 5 Touch to start an instant messaging chat on Google Talk
 - 6 Touch to view the contact's address using Google Maps.
-

- When viewing the contact details:



-
- 1 Touch an action you want to do with the contact.
 - 2 Touch to add the current contact to your **Favorites** list.
 - 3 Touch  to edit the contact details or share the contact information with your friends through e-mail. To designate a ringtone for the contact's incoming calls, or to allow your smartphone to automatically send the contact's calls to your voicemail box, touch **Options**.
-



NOTE: For information about composing and sending SMS and MMS, see "Messaging" on page 55. For more information about instant messaging using Google Talk, see "Google Talk" on page 90. For information about using the e-mail applications, see "Gmail" on page 86 and "E-mail" on page 83.

Contacts settings

To see the contact settings, you can either:

- Touch  →  → **Contacts**  → .
- Touch **Phone**  → **Contacts**  and then touch the Menu button .

Display options Choose from which accounts you want to display the contacts, or set your smartphone to only display the contacts who have phone numbers.

Accounts Contacts stored on your smartphone can be synchronized with a computer using Dell SyncUp; contacts stored on your personal e-mail account like Gmail can be synchronized through an Internet connection.



To select the data to synchronize:

- 1 Select **Background data** to make all the sync options available.
- 2 Select **Auto-sync** to let the smartphone automatically synchronize the selected data in your e-mail account.

To select the data to sync from your e-mail account:

- 1 Touch your e-mail account to open the data list.
- 2 Select the data that you want the smartphone to synchronize automatically: **Sync Books**, **Sync Contacts**, **Sync Gmail**, and/or **Sync Calendar**.



NOTE: If you want to synchronize individual data manually, clear **Auto-sync**, and then from your account, touch a data item to start synchronization of that data.

NOTE: While data is syncing, the sync icon  appears on the status bar, and the sync icon  appears on the option of the data being synced.

Import/Export

You can import contacts from your micro-SIM or microSD card to your phone, export contacts from your phone to your microSD card, or share visible contacts using Bluetooth, Gmail, etc.

Messaging



To compose, send, and read text (SMS) or multimedia (MMS) messages, touch  →  → **Messaging** . The Messaging screen opens with a list of messages or message threads representing all the received, sent, and draft messages.

 **NOTE:** For information about the message thread, see "Receiving text and multimedia messages" on page 58.

To compose and send a text message

- 1 On the Messaging screen, touch the **New message** thread. The compose screen opens.
- 2 In the **To** field, type the mobile phone number or the contact name. As you type a phone number or contact name, matching contacts with their mobile numbers appear below the **To** field. Touch a matched contact to enter the contact's mobile number, or continue typing the desired phone number.

 **NOTE:** Repeat step 2 to add more mobile numbers if you want to send the message to multiple recipients. Use a semi-colon to separate each recipient.

 **NOTE:** To add a subject line to the message, touch  → **Add subject**.

 **NOTE:** When adding a subject, the message automatically changes to MMS format.

- 3 Touch the **Type to compose** text field to start composing your message.
- 4 Touch the **Send** button to send the text message.

- 5 To start a text conversation similar to online instant messaging, you can continue to compose and send messages to the same recipient(s). All of the sent and received messages between you and recipient(s) appear in the form of chat logs.

To compose and send a multimedia message

- 1 In the **To** field, type the recipient's mobile phone number, e-mail address, or contact name. Matching contacts with their mobile numbers or e-mail addresses appear below the **To** field. Touch a matched contact, or continue to type the desired phone number or e-mail address.



NOTE: Repeat step 1 to add more mobile numbers if you want to send the message to multiple recipients. Use a semi-colon to separate each recipient.



NOTE: To add a subject line to the message, touch  → **Add subject**.



- 2 Touch the **Type to compose** text field to start composing your message.
- 3 While editing your message, you can touch  → **Attach** to insert media items into the message.
- 4 When you have completed editing the multimedia message, touch the **Send** button to send the message.

You can attach any of the following items to a multimedia message:

Picture	Open the Gallery application and touch a picture file to attach it to your message.
Capture picture	Open the Camera application to capture a picture, then attach it to your message. For information about the Camera application, see "Camera" on page 152.
Videos	Open the Gallery application and touch a video clip to attach it to your message.
Capture video	Open the Camera application to capture a video clip, then attach it to your message. For more information about the Camcorder application, see "Camera" on page 152.



Audio Open the **Select audio** menu. Touch a desired audio file, and then touch **OK** to attach the file to your message.

Record audio Open the **Recorder** application to record an audio clip.

- Touch  to start recording.
- Touch  to stop recording.
- Touch  to listen to the recording.
- Touch **Use this recording** to attach the recording to your message.



Slideshow Open the **Edit slideshow** screen to create a slide show and attach it to your message.

- 1 Touch **Add slide** to create new slides.
- 2 Touch a created slide such as **Slide 1** to open the slideshow editor screen.
- 3 Touch **Add picture**, and then select the picture you want to add to the slide.
- 4 You can touch the text field on the lower part of the screen to compose a caption for the displayed slide.
- 5 Touch  to preview the slide, remove the picture, add a music to the current slide, add a new slide, or change the slide duration or the text and picture layout.

- When editing multiple slides, touch  to edit the next slide; touch  to return to the previous slide.

NOTE: You can create a slideshow of up to ten slides.

- To replace a picture, on the slideshow editor screen, touch the **Replace picture** button and select a new picture to replace. To remove the current slide, touch the **Remove slide** button. To preview the slideshow, touch the **Preview** button.
-

-
- When complete, touch the **Done** button at the bottom right to attach the slideshow to your message.
 - On the message composer screen, touch the slideshow attachment icon  to play back the slide show; touch **Edit** to modify the slideshow.
 - To remove the slideshow attachment from your message, touch **Edit** →  → **Discard slideshow**.
-

Receiving text and multimedia messages

Depending on your notification settings, the smartphone rings, vibrates, or displays a message briefly in the status bar as a new text or multimedia message arrives.

A new message icon  appears and stays in the notifications area of the status bar to remind you of a new message.







NOTE: To alter the notification settings for new messages, in the **Messaging** application touch  → **Settings** → **Notification settings**. In the **Notification settings** section, you can decide whether to receive a text notification in the status bar when a new message arrives by enabling/disabling **Notifications**. You can also select a ringtone that rings on the arrival of a new message, or let the smartphone vibrate to report a new message.

Text and multimedia messages that are sent to and received from the same contact or a number are grouped into message threads similar to text conversations of an online chat. You can see all of the messages exchanged between you and the contact. Message threads are listed according to when they are sent or received, with the latest message at the top.

To read a text message

To read a text message, you can either:

- Touch and drag down the status bar where the new message icon  is displayed. A list of notifications is displayed. Touch a new message notification to open and read the message.
- Touch  →  → **Messaging**  to open the message list, and then touch a text message or message thread to open and read it.

If the message includes a:

- Website link — touch the link to open the **Browser** application and visit the website.
- Phone number — touch the number to open the **Phone** application and call the number.
- E-mail address — touch the e-mail address to open the **Email/Gmail** application and compose an e-mail to send to the address.



To forward the message

- 1 Touch and hold the message. The **Message options** menu pops up.
- 2 Touch **Forward** to forward the message.

To view a multimedia message

- 1 Touch and drag down the status bar where the new message icon  is displayed. A list of notifications is displayed. Touch a new message notification to open the message.

Or

Touch  →  → **Messaging**  to open the message list, and then touch a multimedia message or message thread to open the message.

- 2 Touch the thumbnail of the attached picture to display the picture; touch the **Play** button  to play back the attached video.



NOTE: Touch the **Download** button, to manually download the media file in the message.

To reply to a text or multimedia message

- 1 Touch a message or message thread to open it.
- 2 Type your reply in the **Type to compose** text field.
- 3 Touch **Send** to send your message to the sender.

To delete a message or a message thread

- 1 In the Messaging list, touch and hold the message thread that you want to delete.
- 2 To delete the entire thread, touch **Delete thread** and then touch **Delete** to confirm deletion.
To delete a message within a thread, touch and hold the message to delete, and then touch **Delete message** on the Message options menu. Touch **Delete** to confirm deletion.



NOTE: To delete all messages in the Messaging list, touch  → **Delete threads**.



To edit message settings

In the Message application, touch  → **Settings** to change the text or multimedia message settings. Follow the instructions on the screen.

Pop-Up Menu

Touch  to open or close the pop-up menu that lists the available options for the current application, or actions that you can perform on the current screen.

To select an option or item on the pop-up menu

- 1 Touch  to open the pop-up menu.
- 2 Touch the desired item on the pop-up menu.
- 3 If the menu has a scroll bar on the right side, you can flick the menu until the desired item is found.
- 4 Touch  again to close the pop-up menu.

Android Keyboard

You can type text using the Android on-screen keyboard. When you start an application or touch a field that requires text input, the on-screen keyboard opens. The keyboard automatically changes to either the portrait or landscape mode based on the orientation of your phone.

To open the Android keyboard

Touch a text field, or touch and hold .

To open the OpenWnn/Flick support keyboard

- Touch and hold a text field to open the **Edit text** context menu→ **Input method**→ **OpenWnn/Flick support**.
- On the Android keyboard, touch and hold  to open the **Select input method** context menu→ **OpenWnn/Flick support**. For information on using the OpenWnn/Flick support keyboard, see "OpenWnn/Flick Support Keyboard" on page 65.



NOTE: To switch back to the Android keyboard from the OpenWnn/Flick support keyboard, touch and hold a text field to open the **Edit text** context menu→ **Input method**→ **Android keyboard**.

To close the keyboard

Touch , or touch and hold .

To display the keyboard

Touch a text field, or touch and hold .

Keyboard Controls

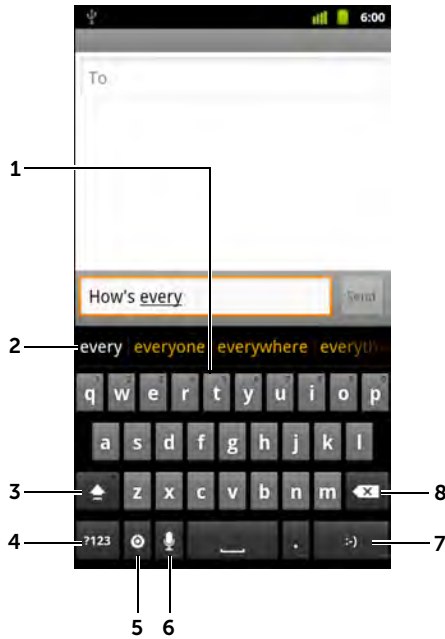

-
- 1**
 - Touch to type letters into the field where the cursor appears.
 - Touch and hold to type accented letters for applicable languages.

 - 2**
 - Based on the letters being typed, the keyboard shows suggested words along the top, the most probable one highlighted in color.
 - You can touch a suggested word to enter it into the text field.
 - Flick this area to the left to see more suggested words.

 - 3**
 - Touch once to show the uppercase keyboard for typing an upper case letter.
 - Touch again to enable the Caps Lock mode.
 - Touch again to change back to the lowercase keyboard.

 - 4**
 - Touch to show the keyboard for typing numbers, punctuation marks, and symbols other than the period.
 - Touch to switch back to the alphabet keyboard.
-

-
- 5
- Touch to open the **Input options** context menu:
 - **Select input method:** Choose to use the Android or OpenWnn/Flick support keyboard.
 - **Android keyboard settings:** Configure the keyboard settings.
 - Touch and hold to choose to use the Android or OpenWnn/Flick support keyboard.



NOTE: To show or hide the key, select the option in **Settings** → **Language & keyboard** → **Android keyboard** → **Show settings key**.

- 6 Touch to use voice input. Say the words you want to enter through the microphone. The device enters the words that it can recognize from your voice.
-

- 7
- Touch to enter the smiley emoticon.
 - Touch and hold to see the other available emoticons.
-

- 8
- Touch to delete a typed character, symbol, or a space to the left of the cursor.
 - Touch and hold to quickly delete typed text.
-

To configure the keyboard settings

- 1 Touch  →  → **Settings** → **Language & keyboard** → **Android keyboard**.
- 2 To enable a setting, touch the setting option to select the check box ; to disable a setting, touch the setting option to clear the check box.

Available keyboard settings

Vibrate on keypress	The smartphone vibrates when you touch a key.
Sound on keypress	The smartphone beeps when you touch a key. NOTE: To activate this feature, you also need to select Settings → Sound → Audible selection .
Popup on keypress	The touched key is enlarged as you touch it on the keyboard.
Touch to correct words	Word suggestions appear when a typed word is touched.

Auto-capitalization	The first letter of the word in a new sentence is capitalized.
Show settings key	Select whether to set the settings key  to Automatic , Always show , or Always hide on the keyboard.
Voice input	Turn on the microphone to enable voice input for the main keyboard or symbols keyboard.
Input languages	Select more input languages. To change to use another input language, use your finger to slide on the spacebar.



Word suggestion settings

Quick fixes	Mark and correct wrong spellings and typos.
Show suggestions	Show suggested words as you type.
Auto-complete	A space or a proper punctuation mark is automatically inserted after a typed word.



Create Your Personal Dictionary

The keyboard uses the default dictionary to display suggested words as you type. You can create a personal dictionary to include words not found in the main dictionary. The keyboard will also look at the words that are added to your personal dictionary to make word suggestions.

To add a word to the dictionary



- 1 Touch  →  → **Settings** → **Language & keyboard** → **User dictionary**.
- 2 Touch  → **Add**.
- 3 Type the desired word into the **Add to dictionary** text field.
- 4 Touch **OK**.

To edit a word in the dictionary

- 1 Touch  →  → **Settings** → **Language & keyboard** → **Android dictionary**.
- 2 Touch the desired word.
- 3 Touch **Edit**.

- 4 Edit the spelling of the word in the **Edit word** text field.
- 5 Touch **OK**.

To delete a word from the dictionary

- 1 Touch  →  → **Settings** → **Language & keyboard** → **User dictionary**.
- 2 Touch the word you want to delete.
- 3 Touch **Delete**.

OpenWnn/Flick Support Keyboard

The OpenWnn/Flick support keyboard allows you to type text and easily switch between English and Japanese language entry.

To open the OpenWnn/Flick support keyboard

Touch and hold a text field to open the **Edit text** context menu → **Input method** → **OpenWnn/Flick support**.

OpenWnn/Flick Support Keyboard Controls



- 1
 - Based on the letters being typed, the keyboard shows suggested words along the top.
 - You can touch a suggested word to enter it into the text field.
 - Touch **記号** to display symbols or smileys on this area, and then touch symbol or smiley to enter it into the text field.

- 2
 - Touch to type letters into the text field where the cursor appears.
 - Touch and hold to type accented letters for applicable languages.

- 3
 - Touch again to enable the Caps Lock mode.
 - Touch again to change back to the lowercase keyboard.

- 4
 - Touch repeatedly to switch between the Japanese, English, or numbers and symbols keyboard.
 - Touch and hold to choose other keyboard options.

- 5 Touch repeatedly to show symbols or smileys on item **1** area.

- 6 Touch to enter a space.

- 7 Touch to move the cursor to the left..

- 8 Touch to move the cursor to the right.

-
- 9 Touch to move the cursor to the next line.

 - 10
 - Touch to delete a typed character, symbol, or a space to the left of the cursor.
 - Touch and hold to quickly delete typed text.

 - 11 Touch to show more suggested words or symbols and smileys.
-



Google Search Widget

You can use the Google Quick Search Box to find websites and information on Google, access applications installed on your smartphone, or find contacts stored in your Contacts list.

To search by typing

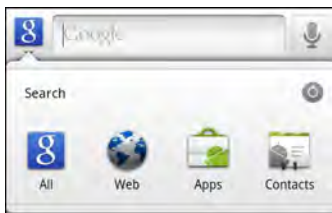
- 1 From the Google Search widget you created on the Home screen, touch  to select the type of your search: **All**, **Web**, **Apps** or **Contacts**.



- 2 Touch the **Google Quick Search Box**. The on-screen keyboard appears.
- 3 Type a keyword or text into the box using the keyboard. As you type, the search results that fully or partially match the text being typed appear below the search box.
- 4 Scroll the listed search results and touch to select a desired keyword. If you only want to view matching web links on Google, touch the  key on the Android keyboard, the  key on the OpenWnn/Flick support keyboard, or touch  next to the search box.
- 5 The matching application or the browser with matching web links opens.

- 6 Touch the desired link if you want to view a web page.

To search by voice

- 1 Touch  that is displayed next to the search box.
- 2 Say the name or keyword of the item you are looking for.
- 3 The browser with matching web links opens.

 **NOTE:** You can also access the Voice Search function by touching



Power Control Widget

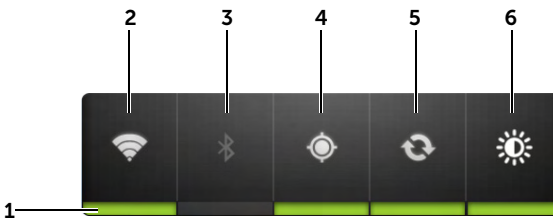

To conserve battery, you may choose to disable one of these modes when not in use.





- 1 Indicates if the appropriate mode is enabled or disabled.
- 2 Touch to enable or disable Wi-Fi connection.
- 3 Touch to enable or disable Bluetooth.
- 4 Touch to enable or disable the **Use GPS satellites** mode, which allows you to pinpoint locations down to the street-level. This mode requires a clear view of the sky and more battery power.
- 5 Touch to enable or disable the Auto-sync mode, which lets your phone automatically sync your Gmail data and Outlook data using Dell Mobile Sync.
- 6 Touch repeatedly to adjust the brightness of your display backlight.

Managing Your Smartphone Settings



To check storage spaces

Touch  →  → **Settings** → **Storage**. The screen displays the total and available space on the internal and external microSD card, and also the available space on the phone memory.

To erase unwanted application data to free storage space

- 1 Touch  →  → **Settings** → **Applications** → **Manage applications**.
- 2 From the **Manage applications** list, touch the application whose cache or data you want to remove.
- 3 In the **Application info** screen, touch **Clear data** under **Storage** to erase unwanted application data; touch **Clear cache** under **Cache** to erase unwanted cache.



To erase all data on the microSD card

- 1 Touch  →  → **Settings** → **Storage**.
- 2 Touch **Erase SD card** under **SD card** to erase the data on the internal SD card or touch **Erase SD card** under **External SD card** to erase the data on the external SD card.
- 3 Touch the **Erase SD card** button.

To remove the microSD card safely

 **CAUTION:** Removing the microSD card while the smartphone is working may cause data loss or result in application errors.

 **CAUTION:** It is strongly recommended to unmount the microSD card before removing it.

- 1 Touch  →  → **Settings** → **Storage**.
- 2 Touch **Unmount SD card**.
- 3 Lift open the micro-SIM and microSD card cover.
- 4 Using a fingertip, push the microSD card to eject the card out of the slot.

- 5 Remove the microSD card from your smartphone.

To erase all data from your smartphone

 **CAUTION:** The following steps will erase all the data including your Google account and downloaded applications from your smartphone. Ensure that you back up all the required data before you proceed.

- 1 Touch  →  → **Settings** → **Privacy** → **Factory data reset**.
- 2 Touch **Reset phone**.

 **NOTE:** You need to draw your screen unlock pattern if it is enabled.

- 3 Touch **Erase everything** after you read the warning.

To reset your smartphone to the default state

 **CAUTION:** The following steps will restore your smartphone to the default state and erase all data and downloaded applications stored on it. Ensure that you back up all the required data before you reset the smartphone.

- 1 Press and hold the Power button and then touch the **Power off** option → **OK** on the screen to turn off the smartphone.
- 2 Simultaneously press and hold the Power button and the volume down button until the smartphone displays "Fastboot" on the upper left corner of the screen.

4 Internet

Connecting to the Internet



NOTE: The availability and functionality of the web-based applications described in this manual vary by region and software version. See to the online help of the applications for the most up-to-date instructions.

To browse the web and access web-based utilities such as instant messaging, one of the following data networking connections must be available:





- GPRS
- EDGE
- 3G
- HSPA
- Wi-Fi

GPRS/EDGE/3G/HSPA

To connect to the internet using GPRS, EDGE, 3G, or HSPA

Your smartphone is configured with GPRS, EDGE, 3G, or HSPA network available with the service provider of the micro-SIM card installed in your smartphone. However, this is only limited to voice calling and text messaging. If a Wi-Fi connection is currently available, the smartphone automatically uses the Wi-Fi connection to access the internet. The internet connection through GPRS, EDGE, 3G, or HSPA becomes temporarily inactive, until the Wi-Fi connection ends.

If you want to connect to the internet using a GPRS, EDGE, 3G, or HSPA data network:

- 1 Touch  →  → **Settings** → **Wireless & networks**, then clear the **Wi-Fi** check box to disable Wi-Fi.
- 2 Touch  →  → **Settings** → **Wireless & networks** → **Mobile networks**, then touch **Data enabled**.



NOTE: Depending on whether a GPRS, EDGE, 3G, or HSPA network is currently in use, a corresponding data network icon appears on the status bar after a data connection is established. For information about identifying the data network icons, see "Status Bar" on page 38.

You can set the smartphone to search for available networks if you are outside your home network or want to register to a different network.

To manually select a new network

- 1 Touch → → **Settings** → **Wireless & networks** → **Mobile networks** → **Network operators** → **Search networks**. A list of networks currently available is displayed.
- 2 Select a network manually from the network list.

To automatically select a new network

Touch → → **Settings** → **Wireless & networks** → **Mobile networks** → **Network operators** → **Select automatically**.

To schedule mobile data connection

You can schedule your data connection to minimize the amount of time that you use your data connection to save battery power.

- 1 To enable this feature, touch → → **Settings** → **Wireless & networks** → **Mobile networks** → **Schedule data connection** → **Enable**.
- 2 In the **off-peak hours** section, set a time range as off-peak hours.
 - Touch **Start Time**. Adjust the time by touching or , or touch the hour and minute fields to enter a time. Touch **Set** when done.
 - Touch **End Time** and repeat the step above to set **End Time**.
- 3 Touch **Cellular Data Timeout** to set the timeout value. For example, if you select **15 minutes**, data connection will be turned off after 15 minutes of inactivity.

To resume data connection, turn on the display of your smartphone.



NOTE: You can also touch **Cellular Data Timeout** in the **peak hours** section to set the timeout value for peak hours.



Wi-Fi

You can use your smartphone to connect to the Internet using Wi-Fi. To use Wi-Fi on your smartphone, you need access to a wireless access point or “hotspot” within a distance of up to 300 feet (100 meters).



NOTE: The range and quality of the Wi-Fi signal is affected by the number of connected devices, infrastructure, and objects through which the signal is transmitted.

To turn on Wi-Fi and connect to a network

- 1 Touch  →  → **Settings** → **Wireless & networks** → **Wi-Fi** to select the Wi-Fi check box. The smartphone scans for available wireless networks.
- 2 Touch **Wi-Fi settings**. The network names and security settings (Open network or Secured with WEP/WPA/WPA2/WPS) of discovered Wi-Fi networks are displayed in the **Wi-Fi networks** list.
- 3 Flick the list and touch to select a Wi-Fi network to connect to.
- 4 Enter a password (if necessary), then touch **Connect** to connect to the Wi-Fi network.





NOTE: To connect to a network protected by Wired Equivalent Privacy (WEP), WPA (Wi-Fi Protected Access), WPA2, or WPS (Wireless Protected Setup), you must enter the WEP/WPA/WPA2/WPS security key to obtain authorized access to the network. The next time your smartphone connects to a previously accessed secured wireless network, you will not be required to enter the WEP/WPA/WPA2/WPS key again, unless you reset your smartphone to its factory default settings.





NOTE: Your smartphone has the ability to maintain a constant internet connection through Wi-Fi or mobile networks (GPRS, EDGE, 3G, or HSPA). However, Wi-Fi connection has priority over mobile network connection if both are available.

To check the current Wi-Fi network connection

From the status bar:

When your smartphone is connected to a wireless network, the Wi-Fi icon  in the status bar indicates the signal strength (number of bands that light up). If **Wireless & networks** → **Wi-Fi settings** → **Network notification** is enabled, the  icon appears in the status bar as the smartphone discovers an accessible Wi-Fi network within range.



From the Wi-Fi network:

- 1 Touch  →  → **Settings** → **Wireless & networks** → **Wi-Fi settings**.
- 2 Touch the Wi-Fi network that the smartphone is currently connected to (labeled **Connected**). A window opens displaying the Wi-Fi network's name, status, security info, signal strength, link speed, and IP address.



NOTE: If you want to disconnect the Wi-Fi network from your smartphone, touch **Forget** on the screen. You will need to configure the Wi-Fi settings again if you want to restore connection to this wireless network.

To connect to another Wi-Fi network

- 1 Touch  →  → **Settings** → **Wireless & networks** → **Wi-Fi settings**. The detected Wi-Fi networks are displayed in the **Wi-Fi networks** list.



NOTE: To start a new search for available Wi-Fi networks, on the **Wi-Fi settings** screen, touch the Menu button  → **Scan**.

- 2 Flick through the Wi-Fi networks list and touch the name of the network you want to connect to.





NOTE: If the wireless network you want to connect to is not in the list of detected networks, flick to the bottom of the list to touch **Add Wi-Fi network**. Enter the Wi-Fi network settings, and then touch **Save**.

Virtual Private Network (VPN)

Your Dell Streak Pro GS01 Smartphone supports connection to a Virtual Private Network (VPN).

To add a VPN

- 1 Touch  →  → **Settings** → **Wireless & networks** → **VPN settings** → **Add VPN**.



 **NOTE:** Consult your network administrator to obtain the protocol being used by the network and other required information to set up VPN.

- 2 Touch the network protocol used by your network.
- 3 Configure the VPN name, server name, DNS domains, select encryption, and other information that is required to set up the VPN.

 **NOTE:** The required settings vary depending on the selected protocol.

- 4 Touch  → **Save**.

To connect to VPN

- 1 Touch  →  → **Settings** → **Wireless & networks** → **VPN settings**.
- 2 Touch the VPN name that you want to connect to.
- 3 Type your username and password.
- 4 Touch **Connect**.

Disable All Connections Using the Airplane Mode

Selecting the Airplane mode disables all mobile and Wi-Fi connections. This feature is useful when wireless connectivity is strictly prohibited, such as on an airplane.



Touch  →  → **Settings** → **Wireless & networks** → **Airplane mode** to enable or disable the Airplane mode.

 **NOTE:** Airplane mode can also be enabled or disabled by pressing and holding the Power button. When the Phone options menu appears, select **Airplane mode**.

Browsing the Internet

To open the browser

To open the browser, you can perform either of the following:



- Touch the Browser button  on the Home screen to open the Browser application quickly.
- Touch  →  → **Browser** .

To use the browser controls bar



- 1 Touch the web page address field and type the address of the web page you want to go to.
- 2 Touch to view bookmarks, most visited web pages, and browsing history.

To go to a web page

- 1 On the browser screen, touch the web page address field on the screen.
- 2 Type the web page address using the on-screen keyboard. As you type the address, matching web page addresses appear.
- 3 Touch an address displayed on the screen to go directly to that web page, or complete typing the web page address, and then touch the  key on the Android keyboard, the  key on the OpenWnn/Flick support keyboard, or  on the browser controls bar.

To set up your home page

To manually enter a home page:

- 1 Touch  → **More** → **Settings** → **Set home page**.
- 2 Enter the web address of the website you want to use as your home page and then touch **OK**.

To set the current page as the home page:

- 1 Go to the web page that you want to set as the home page.
- 2 Touch  → **More** → **Settings** → **Set homepage**.
- 3 Touch **Use current page** → **OK**.

To select a home page from bookmarks:

- 1 Touch  from the browser control bar to view the lists of bookmarks, most visited sites, and browsing history.
- 2 Touch and hold a desired bookmark to display the commands menu → **Set as homepage**.

Viewing Web Pages

To navigate on a web page

Flick your finger horizontally or vertically on the screen to scroll and view desired areas of a web page.

To zoom in on a web page

Pinch-out a desired area of a web page by moving two fingers apart on the screen.



To zoom out on a web page

Pinch-in a desired area of a web page by bringing two fingers closer together on the screen.

To refresh a web page

Touch  → **Refresh**.

To view the next or previous page

Touch  to view the previous page; touch  → **Forward** to view the next page.

To open a new window

Touch  → **New window**. A new browser window opens and displays the home page.

To switch between browser windows

You can open multiple browser windows and easily switch from one web page to another.

- 1 On a browser window, touch  → **Windows**.



NOTE: To close a browser window, touch  on the browser window.

- 2 Touch the web address of a desired web page. The window opens displaying the page in full screen.

To find text within a web page

- 1 When viewing a web page, touch  → **More** → **Find on page**.
- 2 Type the search item in the search bar.

- 3 Touch  or  to go to the previous or next matching item.

 **NOTE:** Touch  to close the search bar.

To copy text on a web page

You can copy and paste text from a web page to your e-mail, text, or multimedia messages.

- 1 Go to the web page from where you want copy the text.
- 2 Locate the text you want to copy and then touch  → **More** → **Select text**.
- 3 Position your finger at the start of the text you want to copy and then drag to the end of the text you want to copy. The selected text is highlighted in orange.
- 4 Touch the highlighted text to copy the text to the clipboard.
- 5 To paste text on an e-mail, text, or multimedia message, touch and hold the text field on a message or e-mail screen and then touch **Paste** on the pop-up menu.

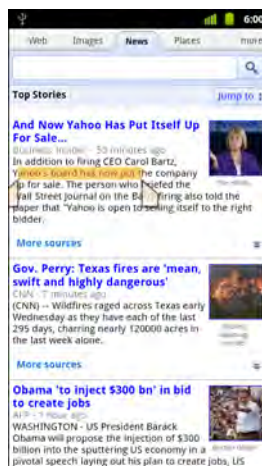

To view information of a web page

- 1 When viewing a web page, touch  → **More** → **Page info**.
- 2 Touch **OK** to close the window.

To share a web page link

- 1 When viewing a web page, touch  → **More** → **Share page**.
- 2 Touch an application for sharing such as Bluetooth, Email/Gmail, Facebook, Messaging, My tag, SyncUP, or Twitter.



Using Web Links, History, and Downloads

To select a link on a web page

Move to a link you want on a web page. The link is framed by an orange box when you touch it.

Link type	Functionality
Web page address	Touch and hold the link to open a pop-up menu that allows you to copy the link of the web page to the clipboard, save the link or share the link through Bluetooth, SyncUP, Facebook, Gmail, text messaging, Twitter, etc.
E-mail address	<ul style="list-style-type: none">• Touch to send an e-mail to the e-mail address.• Touch and hold till a pop-up menu appears.<ul style="list-style-type: none">– Touch Send email to send an e-mail to the e-mail address.– Touch Copy to copy the e-mail address to the clipboard. You can paste the e-mail address later to a new contact or while composing a new e-mail.
Phone number	Touch to open the Phone application to call the phone number. NOTE: You can call a number from the web page only if the feature is supported by your service provider.

To check the history of visited web pages

- 1 On the browser screen, touch  → **History**, or touch  → **Bookmarks**.
- 2 Touch the **History** tab .
- 3 Touch the day when your desired web page was last visited.
- 4 Touch a web address to open the web page.



NOTE: To check your most visited web pages, touch the **Most visited** tab .

To allow download of web applications



CAUTION: Applications downloaded from the web can be from unknown sources. To protect your smartphone and personal data, download applications only from trusted sources such as Android Market.

To download web applications, enable your smartphone's downloading feature.

- 1 Touch → → **Settings** → **Applications**.
- 2 Touch **Unknown sources** to select the check box.
- 3 When the **Attention** dialog box appears, touch **OK**.

To install an application

- 1 On the browser screen, touch the application you want to download.
- 2 The application details screen appears. Read details about the application, such as its cost, overall rating, comments by users, the developer contact info, and more.
- 3 To install the application, select either **Install** (free applications) or **Buy** (applications that require purchase).

To check downloads

On the browser screen, touch → **More** → **Downloads**.

Manage Bookmarks

You can store as many bookmarks as you want on your smartphone.

To bookmark a web page

- 1 On the browser screen, go to the web page you want to bookmark.
- 2 Touch or touch → **Bookmarks**. The **Bookmarks** window opens.
- 3 On the **Bookmarks** tab, touch **Add**.

- 4 Enter the bookmark name or edit the web address as needed.
- 5 Touch **OK** to save the web page as a bookmark.

To open a bookmark

- 1 On the browser screen, touch  or touch **≡** → **Bookmarks**. The **Bookmarks** window opens.
- 2 On the **Bookmarks** window, you can either:
 - Touch the bookmark you want to open in the same browser window.
 - Touch and hold the bookmark you want to open, then on the pop-up menu touch **Open** to open the bookmark in the same browser window, or **Open in new window** to open the bookmark in a new window.

To manage your bookmarks

- 1 On the browser screen, touch  or touch **≡** → **Bookmarks**.
- 2 On the **Bookmarks** window, touch and hold a desired bookmark to open a pop-up menu that provides the following options:

Edit bookmark	Touch to open the Edit bookmark window. Enter the bookmark name and address and touch OK .
Add shortcut to Home	Touch to create the bookmark shortcut on the current Home screen. Then you can touch the shortcut on the Home screen to start the browser and go directly to the bookmarked page.
Share link	Touch to share the link through Bluetooth, Facebook, Email/Gmail, Messaging, My Tag, SyncUP, or Twitter.
Copy link URL	Copy the link of the web page to the clipboard.
Delete bookmark	Touch to delete the selected bookmark.
Set as homepage	Set the selected bookmark as the home page.

To configure browser settings

On the browser screen, touch **≡** → **More** → **Settings** to adjust the browser settings.

E-mail

You can create POP3, IMAP, and exchange e-mail accounts from web-based e-mail services on your smartphone.

To open the e-mail application

Touch  →  → **Email** .



To set up an e-mail account

- 1 On the **Set up email** screen, type the e-mail address and password of the e-mail account you want to add and then touch **Next**.

 **NOTE:** If the e-mail account you want to set up is not in the smartphone e-mail database, you will be asked to manually enter the e-mail account settings, including the e-mail server, protocol, and so on after touching **Next**.

 **NOTE:** Touch **Manual setup** rather than **Next** to directly enter incoming and outgoing server settings for the account being set up.

- 2 Enter the name for the account and the name you want displayed in outgoing e-mails and then touch **Done**.

After creating one e-mail account, touch  → **Accounts** → touch  again → **Add account**, if you need to create another e-mail account.



To compose and send e-mails



- 1 Touch  →  → **Email** .

- 2 In an e-mail account inbox, touch  → **Compose**.

- 3 Type the recipient's e-mail address in the **To** field. As you type information, matching contacts appear on the screen. Touch the recipient to automatically add the e-mail address, or continue typing the e-mail address completely. If you are sending the e-mail to multiple recipients, separate their e-mail addresses with a comma. You can add as many recipients as you need.

- 4 Type the subject.
- 5 Compose your message.
- 6 Touch  → **Send**.





 **NOTE:** If you want to save the message as a draft and modify it later, touch  or touch **Save as draft**.

 **NOTE:** When you receive a new e-mail, the e-mail icon  appears on the status bar to alert you of a new e-mail. Drag down the status bar to open the Notifications panel and touch the new e-mail to view it.

To delete an e-mail

- 1 On the e-mail account inbox, touch and hold the e-mail you want to delete.
- 2 On the pop-up menu, touch **Delete**.

To delete or edit an e-mail account on your smartphone

- 1 Touch  →  → **Email** .
- 2 Touch  → **Accounts**.
- 3 To delete an e-mail account, touch and hold the account you want to remove under the Accounts bar, then touch **Remove account** on the pop-up menu. When the confirm deletion screen is displayed, touch **OK**.
- 4 To edit an e-mail account, touch and hold the account you want to edit, then touch **Account settings** on the pop-up menu.

Google Applications





 **NOTE:** An active Wi-Fi or mobile data network connection (GPRS, EDGE, 3G, or HSPA) is required to be able to connect to the web. For more information about configuring your smartphone for web connectivity, see "Connecting to the Internet" on page 71.

 **NOTE:** Not all applications are available in all versions of this product.

Books

Books allows you to download books from the Google ebook website and read them on your smartphone.



To read books

- 1 Touch  →  → **Books** .
- 2 Touch a book cover to open the book.
- 3 Flick your finger sideways or touch the side of a book to turn a page.
- 4 Touch the center of the book to display the book information and the page slider.
- 5 To advance to other pages in the book, drag the slider to the desired location.
- 6 Touch  to customize viewing options, view the contents page, share the book, search a word in the book, or return to the Books Home screen.

To sort books

- 1 On the Books Home screen, touch  > **Sort order**.
- 2 On the pop-up menu, touch **Recently read**, **Title**, or **Author** to sort the book list.
- 3 Touch **OK**.

To manage books

- 1 On the Books Home screen, touch  > **Manage eBooks**.
- 2 Touch  of the book to remove it from your shelf.
- 3 Touch  of the book to pin it. When a book is pinned, you can read the book even if your smartphone is offline.

To manage Books settings

To manage book settings, touch  > **Settings**.

Gmail

Gmail is a web-based e-mail service provided by Google.

To open Gmail

Touch  →  → **Gmail** .

To set up your Google account

You need to sign in to a Google account to use Google applications and services such as Gmail, Google Maps, Google Talk, and Android Market. Signing in to your Google account also synchronizes all e-mails and contacts on your Google account with your smartphone.

 **NOTE:** You will not be required to sign in with your Google account if you have already signed in previously when using an application that requires signing in to your Google account.

- 1 On the **Add a Google Account** screen, touch the **Next** button to proceed.
- 2 Touch the **Sign in** button. Enter your Google user name and password, then touch the **Sign in** button.

 **NOTE:** If you need to use a different Google user name and password with your smartphone, you must erase all data from your smartphone by performing a Factory Reset (see "To erase all data from your smartphone" on page 70).

 **NOTE:** Signing in to your Google Account requires an Internet connection. Ensure that your smartphone has an active Wi-Fi or mobile data connection (GPRS, EDGE, 3G, or HSPA) before you sign in. For more information about setting up a data connection, see "Connecting to the Internet" on page 71.

 **NOTE:** Touch the **Create** button if you do not have a Google Account.

Your Gmail inbox opens as the default Gmail view. All your received e-mails are delivered to your inbox.

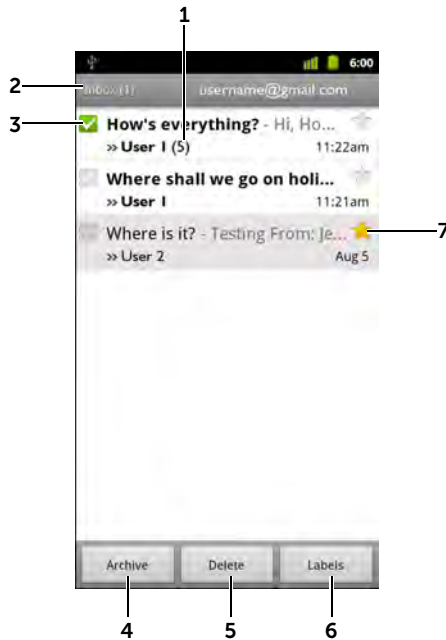

1 Indicates the number of e-mails grouped under the same subject.

2 Folder (or Label) and number of unread e-mails.

3 Touch the check box to select the e-mail.

4 Touch to store the selected e-mail thread in the All Mail folder.

5 Touch to delete the selected e-mail thread.

6 Touch to label the selected e-mail thread.

7 Starred e-mail. Touch the star to add or remove the star.

To refresh Gmail

Touch  → **Refresh** to send or receive e-mails and to synchronize your e-mails with your Gmail account on the web.

To view e-mails in different folders or with labels

To view e-mails stored in the folders other than the inbox, such as in the Sent or All Mail folders, or to view labeled or starred e-mails:

- 1 Touch  → **Go to labels**.
- 2 Touch the folder that stores the e-mails you want to view, or touch the label with which the e-mails are marked.

To read e-mails

- When you receive a new e-mail, the e-mail icon  appears on the status bar to alert you of a new e-mail. Drag down the status bar to open the Notifications panel and touch the new e-mail to view it.
- While in the inbox or in any other folder, scroll the e-mail threads on the screen, and then touch an e-mail to open it.

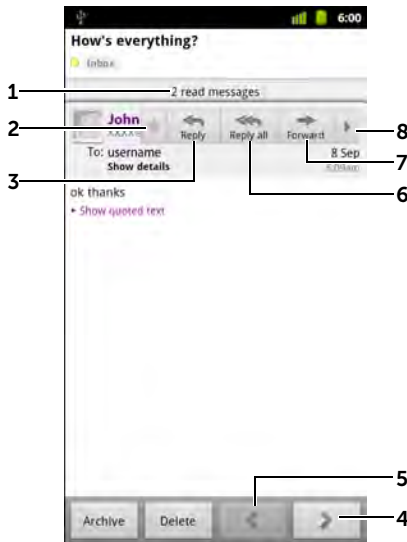

-
- 1 Touch to view previous e-mails with the same subject.

 - 2 Touch to star an e-mail. To check the starred e-mails, in **Inbox**, touch  → **Go to labels** → **Starred**.

 - 3 Touch to reply to the contact.

 - 4 Touch to read the next e-mail thread.









 - 5 Touch to read the previous e-mail thread.

 - 6 Touch to reply to all contacts in the mail loop.

 - 7 Touch to forward the e-mail to another contact.

 - 8 Touch to open or close the **Reply all** and **Forward** buttons.
-



To create and send an e-mail

- 1 Touch  → **Compose**.
- 2 Enter the contact's e-mail address in the **To** field. To send e-mail to multiple contacts, separate their e-mail addresses with a comma. To send a carbon copy (Cc) or a blind carbon copy (Bcc), touch  → **Add Cc/Bcc**.
- 3 Enter the e-mail subject.
- 4 Compose your e-mail. To attach a picture, touch  → **Attach**. Select the picture you want to attach from the Gallery application (for more information, see "Photos and Videos" on page 162).
 **NOTE:** Touch  to remove an attachment.
- 5 Touch  to send the e-mail.
 **NOTE:** To save the e-mail as draft, touch .

Google Talk

Google Talk is an instant messaging application provided by Google.

To activate Google Talk

- 1 Touch  →  → **Google Talk** .
- 2 Sign in to Google Talk with your Google account. If you do not have a Google account, follow the instructions on the screen to create an account (see "To set up your Google account" on page 86).
- 3 The Talk window opens with your friends list.

To sign in automatically

You can sign in to your Google Talk account automatically whenever you turn on the smartphone.

- 1 In the friends list, touch  → **Settings**.
- 2 Select **Sign in automatically**.

To add a new friend to your friends list

 **NOTE:** You can only add friends who have a Google Account.

- 1 In the friends list, touch  → **Add friend**.
- 2 Enter the Google Talk instant messaging ID or Gmail address of the friend you want to add to your friends list.

 **NOTE:** When you type the instant messaging ID of a friend who is already a contact saved in Contacts with the same ID, this matching contact will display on the screen before you finish typing. You can touch the contact whose ID is then entered automatically.

- 3 Touch **Send invitation**.

To view and accept an invitation

- 1 In the friends list, touch  → **More** → **Invites**. All chat invitations you have sent or received but have not been answered are listed on the pending invitations screen.
- 2 Touch a pending invitation.
- 3 Touch **Accept** or **Cancel**.

When a friend accepts your chat invitation, the pending invitation disappears from the list.

To change your online status and message

- 1 Touch your name bar to display the Set Status screen.
- 2 Touch the status bar to open the pop-up menu.
- 3 Select the status you want from the Status menu.
- 4 To enter your status message, touch the text field and enter your message.
- 5 To change your ID photo, touch the photo to open Gallery, then select the photo to use.
- 6 To enable video chat, select the **Allow video and voice chats** box.
- 7 When finished, touch **Done**.

To start a conversation

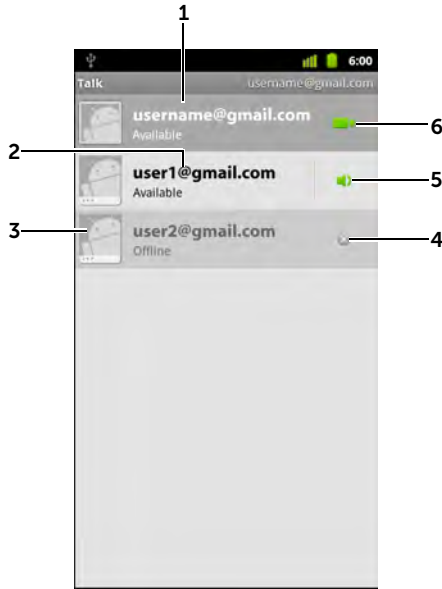

-
- 1 Touch to change your online status.

 - 2 Touch to open a chat window and start a conversation.

 - 3 Touch to select how you want to send a message to your friend.

 - 4 Indicates that your friend is offline.

 - 5
 - Indicates that your friend is online and voice chat is enabled at his end.
 - Touch to call your friend.

 - 6 Indicates that you are online and you have video calls enabled.

- 1 Touch to select a friend in the friends list.
- 2 Type your message in the text field.
- 3 Touch the **Send** button to send the message.

To add a friend to an active conversation

- 1 On the chat screen, touch  → **Add to chat**.
- 2 Select the friend you want to invite to the current conversation.

To disable the chat log

On the chat screen, touch  → **Chat off record**. The subsequent chat conversations will not be recorded. To resume the chat log, touch **Chat on record**.

To switch between active conversations

- 1 While on a chat screen or in the friends list, touch  → **Switch chats**.
- 2 In the panel that opens, touch the name of the friend you want to chat with.

To close a conversation

- In your friends list, touch and hold the name of a friend with an active chat. Touch **End chat** on the menu that pops up.
- On a chat screen, touch  → **End chat**.

To display all friends in your friends list

Only the friends you chat with most frequently are listed as the most popular friends. If you want to display all your friends, touch  → **All friends**.

To show a friend in the most popular list

- 1 In the friends list, touch and hold the friend's name to open the options menu.
- 2 Touch **Show friend**.

To always show a friend in most popular list

You can let a friend always appear in your most popular friends list.

- 1 In the friends list, touch and hold the friend's name to open the options menu.
- 2 Touch **Always show friend**.



NOTE: To remove a friend from the most popular list, in the friends list, touch and hold the friend you want to remove from the list, and then touch **Auto-show friend** in the options menu.



NOTE: To keep a friend from appearing in the most popular list, touch and hold the friend's name, and then touch **Hide friend** in the menu.

To block a friend from sending you messages

- 1 In the friends list, find the friend to block.
- 2 Touch and hold the friend's name, and then touch **Block friend**.

Your friend is removed from your friends list and is added to the blocked friends list.



NOTE: To unblock a friend, in the friends list, touch  → **More** → **Blocked**. In the blocked friends list, touch the name of the friend to unblock, then touch **OK**.

To permanently remove a friend

- 1 In the friends list, find the friend to remove.
- 2 Touch and hold the friend's name, and then touch **Remove friend**.

To find out what device your friend uses to chat on Google talk

- 1 In the friends list, touch  → **Settings** → **Mobile indicator**.
- 2 In the friends list, check the image that appears next to your friend's name. For example, if your friend is using an Android phone, the Android image will appear. If no image is displayed, it indicates that your friend has signed in to Google using a computer.

To sign out from Google Talk

In the friends list, touch  → **Sign out**.



Maps

Google Maps helps you find your current location, view real-time traffic situations, and get directions to your destination. You can also use the search tool to locate addresses or places of interest on a map or in a street view.

 **NOTE:** The Google Maps application does not completely cover every location.

To enable location source

To search for desired places or find your current location using Google Maps, you need to enable My location sources:

- 1 Touch  →  → **Settings** → **Location & security**.
- 2 Select **Use wireless networks**, **Use GPS satellites**, or both.

 **NOTE:** Selecting **Use GPS satellites** allows you to pinpoint locations down to the street-level. However, this mode requires a clear view of the sky and more battery power.

To open Google Maps



Touch  →  → **Maps** .

To see your location on a map

On the Maps screen, touch . Your location is marked on the map with a blinking blue arrowhead.

 **NOTE:** Selecting Enable GPS satellites allows you to pinpoint your current location down to the street-level. However, this mode requires a clear view of the sky and more battery power.

To find a location on the map

- 1 On the Maps screen, touch  → **Search** or touch the Search bar on top of the screen.
- 2 To search by typing:
 - a Type the place you want to find in the search box. You can enter an address, a city or country, or a type of business or organization such as a “restaurant” or “school”.
 - b Touch the search key on the keyboard or the search icon  on the search box.



To search by voice:

- a Touch  .
- b Say your destination.

 **NOTE:** As you enter information, previous searches or matching locations appear below the search box. You can touch a place name or address to show the location on the map.

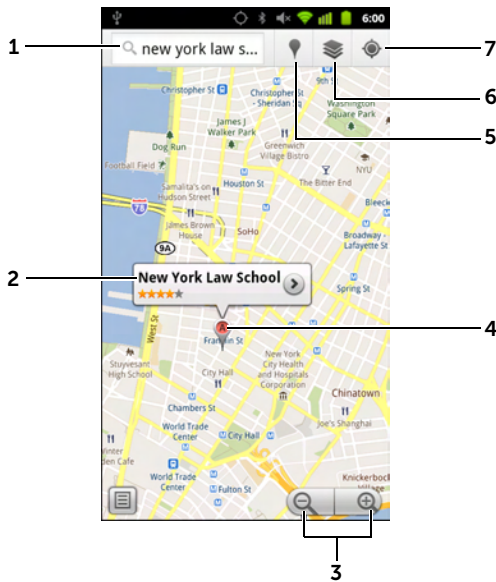
- 3 The search results are marked on the map by lettered balloons.



-
- 1 Type the place you want to search here or to search by voice, touch  → **Search** →  .

 - 2 Touch the place name to view the address, details, and reviews for the place if the information is available. For more information, see "To view the details of a place" on page 98.

 - 3 Touch to zoom in or out on the map.

 - 4 The search result is marked by a lettered marker. Touch the marker to display the name of the place.

 - 5 Touch to open the Places application and search for places such as restaurants, banks, etc. that are near your current location, see "Places" on page 112.

 - 6 Touch to select map layers or change the map view. For more information, see "To change map layers" on page 99.

 - 7 Touch to view your current location on the map.
-

To view the details of a place

When you touch a place name on the map view, the following screen appears, showing the address, details and review for the place (if available).





- 1 Touch to display the map view.
- 2 Touch to obtain directions. For more information, see "To get directions" on page 105.
- 3 Touch to check in at the place.
- 4 Touch to rate the place.
- 5 Flick to read user comments and review about the place.
- 6 Touch to call the phone number of the place.
- 7 Touch to access more available options such as viewing the place in street view, sharing the place, searching nearby areas, and buzz about the place.
- 8 Touch to open browser and view more information about the place.
- 9 Touch to star the place.

To move around a map

- 1 Flick or drag the map in any direction on the screen to view the desired areas.
- 2 If you spot a place of interest while navigating the map, touch and hold the place to display the address (a picture thumbnail is also displayed if the street view for the location is available).

To zoom-in or zoom-out on a map

Touch  to zoom out and touch  to zoom in.

To change map layers

Google Maps opens with the default map layer. You can apply different types of layers to view additional information or images on the map.

- 1 Touch .
- 2 From the Layers menu, touch the desired layer to display it on the map.



Map layer

The map layer displays streets, highways, buildings, main establishments, mass transit stations, parks, rivers, lakes, mountains, boundaries, and so on.



Traffic layer

The traffic layer displays colored lines along the roads where real-time traffic data can be collected. Green lines indicate good traffic speeds, yellow lines indicate slower speeds, and brown lines indicate congested traffic. 

 indicates where construction work is taking place;  indicates where the road is blocked.

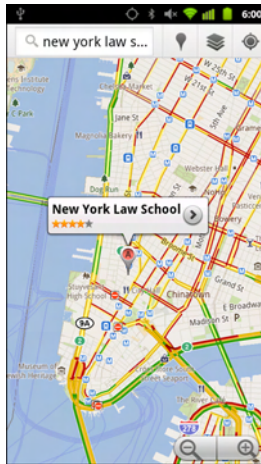

Satellite layer

The satellite layer displays the map in non-real-time satellite view.

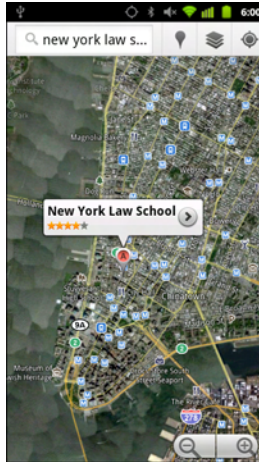

Terrain layer

The terrain layer combines street maps with visual information about terrains.



Transit Lines layer

The transit lines layer displays colored lines along the public transportation routes, such as the subway, bus, etc. The color coding varies depending on your location.



Latitude layer

The Latitude layer displays photo icons of your friends to indicate their location on the map. For more information, see "Using Google Latitude" on page 107.

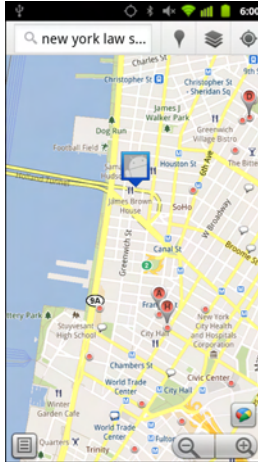

Wikipedia layer

The Wikipedia layer displays Wikipedia icons on the map where information about a place is available. Touch  to view the information of the place.

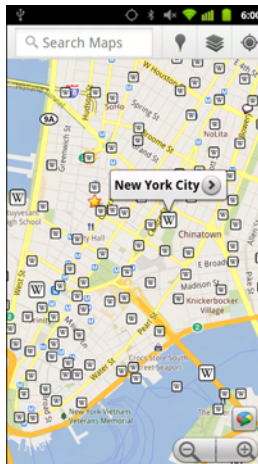

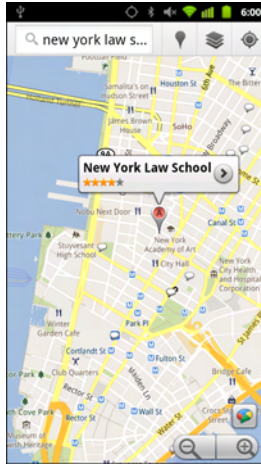

Buzz layer

The buzz layer displays buzz icons on the map. Touch  to view user comments about the location.



My Maps

The My Maps feature allows you to access personalized annotated and customized maps that you have created in Google Maps from your computer. You can create a custom map for your holiday destination with interesting places. Then, you can view this personalized map on your smartphone.



 **NOTE:** To remove all of the layers other than the map layer, touch  → **Clear Map**.

To view a map in street view

You can switch to street view for the location that you found on the map. The street view is composed of imagery captured from the streets.

- 1 Locate a place of interest on the map. For more information, see "To find a location on the map" on page 96 and "To move around a map" on page 99.
- 2 On the map, touch the name or address of the place.

- 3 On the location details screen, touch  → **Street View**.
- 4 To view the area around the place, turn the view on the screen with your finger.
- 5 To move the view along the street, drag Pegman on the map to your desired directions or destination.

 **NOTE:** While viewing a street view of a location, touch  → **Compass mode** to enable the compass mode, which allows you to view the area around the selected location by tilting or turning your smartphone, rather than by moving the view on the screen with your finger.

To get directions

Use Google Maps to obtain directions to your destination.

- 1 When viewing a map:

touch  → **Directions**.

Or

When a place is found:

- a Touch the place's name or address displayed on the map.
 - b On the location details screen, touch  → **Get directions**.
- 2 Enter the starting point in the first text field and your destination in the second text field.

 **NOTE:** By default, your current location is the starting point, and the place you found on the map is your destination.

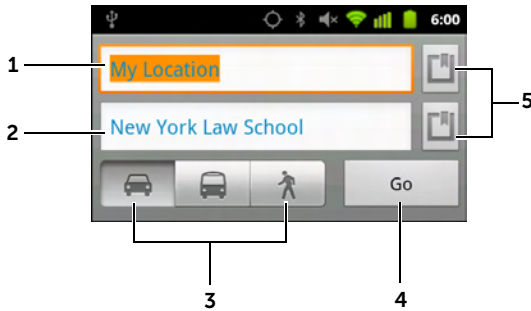

-
- 1 Starting point

 - 2 Destination

 - 3 Choose how you want to get to your destination: driving, public transportation, or walking.

 - 4 Touch to render directions.

 - 5 Touch to set your current location, a contact address, or a place on the map as the starting point or destination.

- 3 Touch **Go**. The directions to your destination are listed.
- 4 Touch the Menu button $\equiv \rightarrow$ **See map**, or touch a direction instruction on the list to show the directions or routes on the map.

To clear a map

Touch the Menu button $\equiv \rightarrow$ **Clear Map**. All the search results, directions and traffic indicators are deleted from the map.

Using Google Latitude



NOTE: To use Google Latitude, you will be required to sign in to a Google account.

The Google Latitude location service allows you to share locations with your friends and family who have signed in to the service with their Google accounts. You can also send instant messages and e-mails, make phone calls, and get directions to your friends' locations.

To let your friends view your location and accept their invitations, you need to enable **Latitude**.

- 1 While viewing a map in any mode, touch  → **Join Latitude**.
- 2 Sign in to Google Latitude with your Google account. If you do not have a Google account, follow the instructions on the screen to create an account (see "To set up your Google account" on page 86).

To launch Latitude

- Touch  →  → **Latitude** .
- While viewing a map, touch  → **Latitude**.

To invite friends to share locations

- 1 On the Latitude screen, touch  → **Add friends**.
- 2 Choose the friends you want to share locations with:
 - **Select from Contacts:** Select friends from your contacts. Friends already using Latitude have an icon next to their names.
 - **Add via email address:** Enter an e-mail address.
- 3 Touch **Add friends** then **Yes**.
- 4 Your friends already using Latitude receive an e-mail request and a notification on Latitude requesting them to share locations. If they have not yet joined Latitude, they receive an e-mail that requests them to sign in to Latitude with their Google accounts.

To accept an invitation

When you receive a request to share your location with a friend on Latitude, choose how you want to respond:

- **Accept and share your location:** You can see your friend's location, and your friend can see yours.
- **Accept, but hide your location:** You can see your friend's location, but they cannot see yours.
- **Don't accept:** Reject the sharing request. No location information is shared.

To show your friends

You can show your friends on the map or in the list view.

- **Map view**

When you open Google Maps, it displays the locations of your friends. Each friend is marked by a photo icon with an arrow that indicates their location. To see a friend's profile and communicate with them, touch the photo, then touch their location callout right above their photo. To see other friends, touch either one of the arrow buttons next to the callout.

- **List view**

To show a list of your friends, touch  → **Latitude**. To see a friend's profile and communicate with them, touch the friend's name from the list.

To connect with your friends

Touch a friend's name in map view or list view to open the friend's profile. In the profile screen, you can communicate with your friend and configure privacy options.

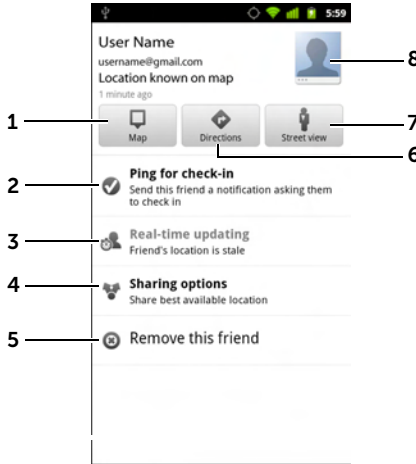

- 1 See the friend's location on the map.
- 2 **Ping for check in:** Ping the friend by sending a notification to ask him/her to check in, if the friend's device/Maps version is supported.
- 3 **Real-time updating:** Get real time updated location of the friend, if the friend's device/Maps version is supported.
- 4 **Sharing options:**
 - **Share best available location:** Share street-level location with your friend.
 - **Share only city level location:** Share only the city or the approximate area you are in, not the street-level location. Your friend can see your photo icon in the middle of the city you are in.
 - **Hide from this friend:** Stop location sharing with this friend. Your friend cannot see your photo icon on the map.
- 5 **Remove this friend:** Remove this friend from your list and end all location sharing.
- 6 Get directions to the friend's location.

-
- 7 Switch to street view of the friend's location.
 - 8 Touch the thumbnail to open the pop-up menu. Depending on available settings, you may use **Messaging** and **Gmail** services to send a message to your friend.
-

To control what to share and change your public profile

- 1 In Maps, touch ☰ → **Latitude**.
- 2 Touch your name to open your public profile window.

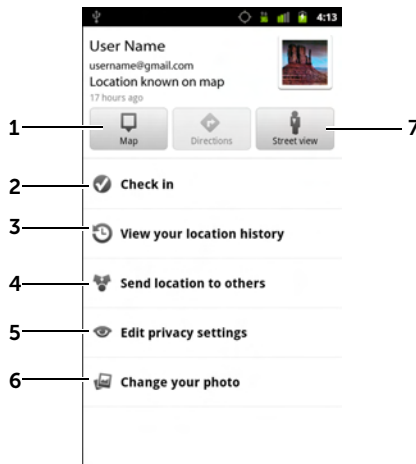

- 3 Set the following options based on your preferences.

-
- 1 See your location on the map.
 - 2 **Check in:** Choose a place to check in to.
 - 3 **Change your photo:**
Change the picture that your friends see on the map or in their list of friends.
You can capture a picture using the Camera application, or select a picture from the Gallery.
-

- 4 **Send location to others:**
Touch to select a way to send your location to others, such as **Bluetooth**, **Messaging**, or **Gmail**, etc.

5 Edit privacy settings: Manage how your location is shared with your friends.

- **Detect your location:** Latitude automatically detects and updates your current location.

NOTE: To let Latitude report your location, you must enable My location sources. For more information, see "To enable location source" on page 95.

- **Set your location:** Select a location from the map, contact addresses or nearby places, or type an address.
- **Do not update your location.** Your location is not updated and your friends will not be able to see your location on their maps.

6 Switch to street view of your location.

Places

Touch  →  → **Places** .

Places automatically detects your current location and guides you to nearby restaurants, coffee shops, bars, hotels, attractions, ATMs, gas stations, etc.

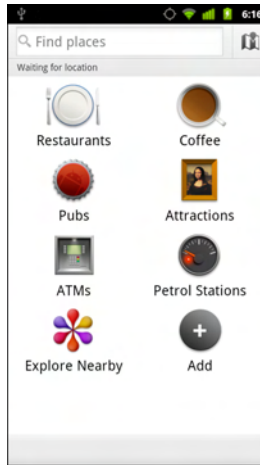

- 1 Touch to select a category.
- 2 From the list of places, touch the desired one to view more details. For more information on using the controls on this screen, see "To view the details of a place" on page 98.

Navigation



NOTE: Google Maps Navigation is not available in all areas.



NOTE: Google Maps Navigation is only available for use in the United States at this time.



WARNING: Ensure that you use this application in a safe and responsible manner. You must obey local traffic laws, posted road signs, and safety regulations. Do not operate your smartphone while driving.

Touch  →  → **Navigation** .

Google Maps Navigation is an internet-connected GPS satellite navigation system with voice guidance. Navigation provides the following features:

Feature	Description
Searching in plain language	Type a place, a name of a business, or a kind of business. 
Searching by voice	Speak your destination using Google Search by voice (English only). 
Traffic view	Traffic view provides live traffic data and shows up-to-date traffic status on the screen. Touch  → Layers → Traffic to turn on Traffic view.
Searching along route	Search for any kind of business along your route. Touch  → Layers to access popular types of places.

Feature	Description
Satellite View	Satellite view allows you to view your route overlaid on 3D satellite views with Google's high-resolution aerial imagery. Touch  → Layers → Satellite to turn on Satellite view.
Car dock mode	Place your phone in a car dock to access Navigation and Voice Search easily.
Navigation shortcut	<ul style="list-style-type: none"> • Speak Destination: Speak your destination. • Type Destination: Type your destination. • Contacts: Select a destination from the location of your contacts. • Starred Places: Select a destination from the list of Starred Places.

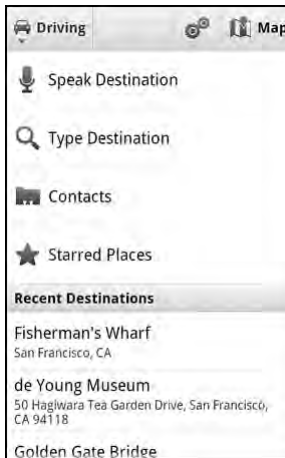

Feature	Description
Walking navigation	Get voice-guided navigation for walking directions. Your smartphone vibrates for turn notifications.

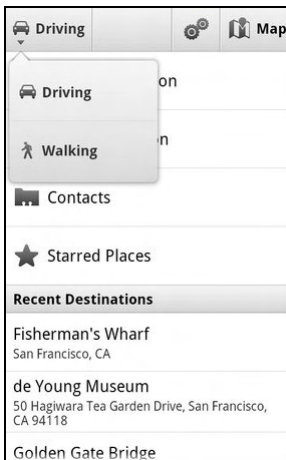

News and Weather

Touch  →  → **News and Weather** .

Weather

The Weather service automatically detects your current location and shows the local weather information.

If your current location is temporarily unavailable, you can set the location manually using the following instructions:

- 1 In the **News and Weather** screen, touch  → **Settings** → **Weather settings**.
- 2 Clear the **Use my location** check box.
- 3 Touch **Set location**.
- 4 Enter a city or postal code.

- 5 Touch . The weather information will be updated to the location you manually set.

News

When holding the smartphone in portrait format, flick pages horizontally to view news topics, such as Top Stories, U.S., Sports, and Entertainment. Touch the news headline you are interested in to view the full content.

To add/remove news topics

To manage the news topics displayed on your smartphone:

- 1 In the **News and Weather** screen, touch  → **Settings** → **News settings**.
- 2 Touch **Select news topics**.
 - Select the check boxes next to the news topics you want to display on the smartphone.
 - Clear the check boxes next to the unwanted news topics.
 - To create customized news topics, touch **Customised topic** and type the topic, and then touch **OK**.

To refresh news and weather settings

- 1 In the **News and Weather** screen, touch  → **Settings** → **Refresh settings**.
- 2 To refresh the settings automatically, select the **Auto-refresh** check box.
- 3 Touch **Refresh interval** to adjust the refresh interval. Faster refresh intervals use more battery power.



NOTE: To refresh the settings manually, in the **News and Weather** screen, touch  → **Refresh**.

YouTube





YouTube is an Internet video streaming service that allows you to view videos uploaded by YouTube members.

 **NOTE:** Browsing and watching videos does not require you to sign in to a YouTube account. However, to use full YouTube features, such as commenting on videos, adding videos to your favorites, or uploading videos, you must create and sign in to a YouTube account.

To open YouTube



Touch  →  → **YouTube** .

To search for a video by typing

- 1 Touch the  icon on the top right of the YouTube screen, or touch  → **Search** to open the search bar.
- 2 Type the video name or keyword into the search box using the on-screen keyboard. The search results that fully or partially match the text being typed appear below the search box. You can:
 - a Scroll the search results and touch the desired result.
 - b Touch the  key on the Android keyboard, the  key on the OpenWnn/Flick support keyboard, or the search icon  on the search box to search for results that match the entered text, and then touch a desired search result.
- 3 The videos that match the selected result are listed.
- 4 Touch the video to start playing the video.



 **NOTE:** You can touch **All time** (or the current time filter setting) at the top of the search results screen. From the **Time filter** pop-up menu, select a time frame you want to filter the search results. The videos that match the selected time frame will be listed.

To search for a video by voice command

- 1 Touch the  icon on the top right corner of the YouTube screen, or touch  → **Search** to open the search bar.
- 2 Touch .
- 3 Say the video name or a keyword.
- 4 The videos that match the words you said are listed.
- 5 Touch the video to start playing the video.

To watch videos in the Portrait format

- 1 Place the smartphone in the Portrait format.
- 2 Select a video on the YouTube screen. Touch the video to start the playback in the top half of the screen.
- 3 Touch the screen to pause the playback. When paused, the  icon appears.
- 4 Touch the screen again to resume the playback.



While the video is playing, you can touch  if you like the video, or touch  if you do not like the video. You can also touch **More** to add the video to your favorites, save it to a playlist, share it, copy its URL, or flag it.

In the bottom half of the screen, you can flick the **Info**, **Related videos** and **Comments** tabs to view the information about this video, browse related videos, and read comments.

 **NOTE:** Some of the features above may require signing in to your YouTube account.

To watch videos in the Landscape format

- 1 Place the smartphone in the Landscape format.
- 2 Select a video on the YouTube screen. Touch the video to start the playback in full screen.
- 3 To control video playback, touch anywhere on the screen to bring up the controls.

- 4 Touch the screen again to pause the playback. When paused, the  icon appears.
- 5 Touch the screen again to resume the playback.
- 6 To end playback, touch  or .



NOTE: In full screen, you can touch **HQ** to toggle High Quality (HQ) mode or touch **CC** to enable subtitles (if available).

To use YouTube menu options

In YouTube, you can touch  to access the following menu options, some of which may require signing in to your YouTube account.

Home	Return to the YouTube main screen.
Browse	Browse videos from a list of categories.
Search	Search for videos.
My Channel	Access your video uploads, favorite videos, video playlists, and video subscriptions. You can also sign out from this page.
Upload	Upload videos from your smartphone.
Settings	Customize your YouTube preferences and settings.





NOTE: For more information on using YouTube, touch  → **Settings** → **Help**.

Android Market

You can use Android Market to download and install applications and games on your smartphone.

 **NOTE:** Applications downloaded from Android Market may not support automatic screen orientation to portrait or landscape.

To open Android Market

- 1 Touch  →  → **Market** .
- 2 Sign in to Android Market with your Google account. If you do not have a Google account, follow the instructions on the screen to create an account (see "To set up your Google account" on page 86).
- 3 Touch the **Accept** button after you read and agree with the **Android Market Terms of Service**.
- 4 The Android Market screen opens.



- 1 The Market screen displays popular application categories here for direct access.

- 2
 - Touch **Apps** to view the application categories. All applications available for download are sorted by these categories.
 - Touch **Games** to view the game categories. All games available for download are sorted by these categories.

- 3 The Market screen opens with featured applications for direct access.

- 4 Shows user rating about the item and whether it is free or requires a purchase.

- 5 Touch **My apps** to view your downloads.

- 6 Touch to search Android Market for applications or games.

When a category is selected, for example, touch the **Games** tab→
Brain & Puzzle:

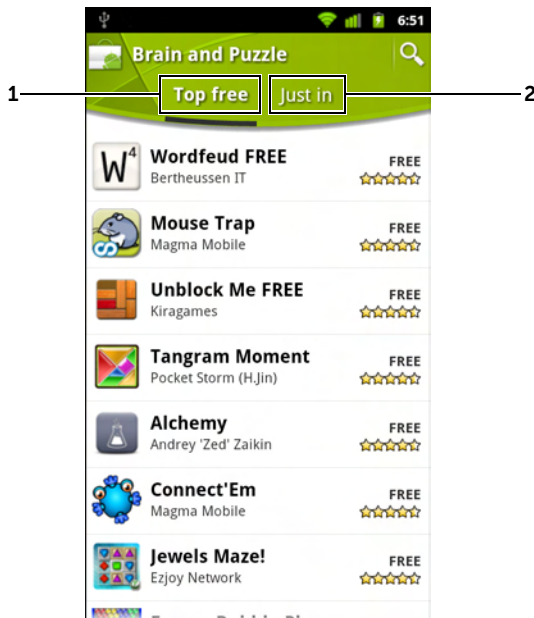

- 1 Touch **Top free** to sort the items by rating.

- 2 Touch **Just in** to sort by date.

To download and install an application or game

- 1 Scroll and browse listed applications or games to locate the desired application.
- 2 Touch the application or game you want to download and install.
- 3 On the application details screen, you can read the introduction to the application or game, user ratings and comments, and developer information.



NOTE: Touch  → **Security** to view the functions or data that the application or game can access on your smartphone.

- 4 On the application details screen, touch **Install** or **Free** to start download and installation. The application's download screen displays the progress of the download.



NOTE: If the application requires access to any of your data or functions on your smartphone, Market displays the information that the application can access. Touch the **OK** button to start download and installation.



NOTE: During installation, the downloading icon  appears in the notification area of the status bar. Touch the notification area of the status bar to open the Notifications panel and check download progress.



NOTE: To stop downloading an application, touch **Cancel download** on the application's download screen.

- 5 After the application is downloaded and installed on your smartphone, the download complete icon  appears in the notification area of the status bar.

To open an application or game

From the Market screen:

- 1 Touch **My apps** on the Market screen.
- 2 Touch the installed application in the list.
- 3 Touch the **Open** button. The selected application starts running.

From the main application menu:

- 1 Touch .
- 2 Touch the application's icon.

From the status bar:

- 1 Drag down the status bar to view the Notifications panel where the download complete icon  appears to indicate a recently downloaded application.
- 2 Touch the name of the application you want to open.



To uninstall an application or game

- 1 On the My apps screen, touch the application you want to uninstall.
- 2 Touch **Uninstall**.
- 3 After the uninstall is completed, you can select the reason for removing the application.



Synchronizing Your Google Data



Through a web connection, your smartphone can synchronize your Google data including Gmail, calendar, and contacts with your computer or any other device that you use to access your Google account.

To select the applications to synchronize

- 1 Touch  →  → **Settings** → **Accounts & sync**.
- 2 Under the **General sync settings** bar, touch to select **Background data** to make all the sync options available.

- 3 Under the **General sync settings** bar, touch to select **Auto-sync** to allow the device to automatically synchronize the selected data.
- 4 Under the **Manage accounts** bar, touch your account to select the data that you want the smartphone to synchronize automatically: **Books, Contacts, Gmail, and/or Calendar**.

 **NOTE:** If you want to synchronize individual applications manually, touch to clear the **Auto-sync** check box, then touch a data option to start synchronization of the touched data. To sync all of the data manually, touch  → **Sync now**.

 **NOTE:** While data is syncing, the sync icon  appears on the status bar, and the sync icon  appears on the option of the data being synced.



 **NOTE:** To add and synchronize more accounts, touch **Add account** and follow the on-screen instructions to proceed.

Dell Applications



Dell Backup and Restore

Dell Backup and Restore allows you to create security backups of your smartphone's data to the memory card.

To create a backup

- 1 Touch  →  → **Backup & Restore** .
- 2 Touch **Backup**.
- 3 Type a name for the backup file.
- 4 Touch **OK**.

To restore data

- 1 Touch  →  → **Backup & Restore** .
- 2 Touch **Restore**.
- 3 Touch a backup file to restore.
- 4 On the warning message, touch **OK** to continue.

Dell SyncUp

Dell SyncUp allows you to sync your smartphone with a computer using Wi-Fi connections or upload files to the Dell SyncUp cloud storage.

To open Dell SyncUp

- 1 Touch  →  → **Dell SyncUp** .



 **NOTE:** You need to log in with your Dell SyncUp account to use this application. To create an account, touch **Create New Account**, and then follow the instructions on the screen to complete setup.

- 2 Touch **Log in**.
- 3 Type your login and password.
- 4 Touch **Preferences** to manage PC Sync and Online settings.

To sync with a computer

Ensure that Wi-Fi is enabled on your phone and the computer, and then touch **PC Sync**.



To sync with Dell SyncUp online

- 1 Touch **Online Files**.
- 2 Type the e-mail address or nickname and password of your Dell SyncUp account.
- 3 Touch **Log in**.
- 4 To upload files, touch  → **Upload**.
- 5 Touch the type of file to upload.
- 6 Browse for the file.
- 7 Touch the file to start uploading.
- 8 To access online settings, touch  → **Online Settings**.
- 9 To logout, touch  → **Logout**.

PhotoStage

PhotoStage displays pictures and videos stored on the smartphone's memory card and as well as those uploaded to your Picasa web album and Facebook account that you have synced with your phone.

To open PhotoStage

- 1 Touch  →  → **PhotoStage** . Pictures and videos are grouped into **Recent**, **Library**, and **Facebook**.
- 2 Flick on the page tabs to scroll through: **Recent**, **Library**, and **Facebook** tabs.
- 3 Touch a thumbnail to view the picture or video in full screen.

To display a full picture

Touch a thumbnail to view the picture in full screen.

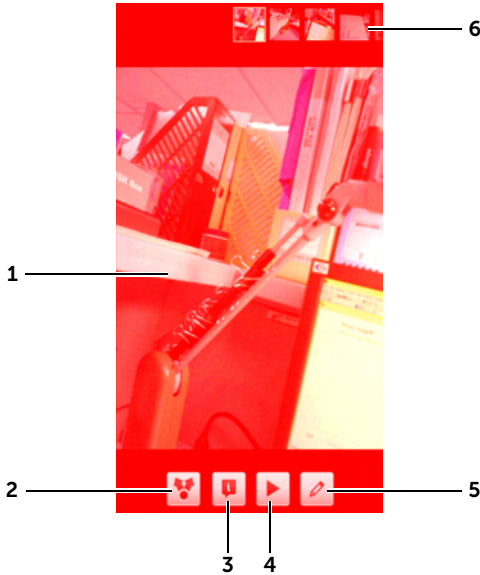

-
- Flick horizontally to view the next or the previous picture.
 - To zoom in or zoom out on the picture, you can:
 - Touch anywhere on the picture twice.
 - Pinch the picture with two fingers, then move the fingers apart to enlarge the picture, or bring them closer together to reduce the picture.
 - When a picture is enlarged, flick or drag the enlarged picture across the screen until the required area appears.
 - To see the viewing controls, touch anywhere on the screen.

2 Touch to share the picture:

- Select **Picasa**, **Twitter**, or **Facebook** to upload the picture to Picasa, Twitter, or Facebook to allow your friends see it.
- Select **Bluetooth** to send the picture to another paired Bluetooth device, or print the picture using a paired Bluetooth printer.
- Send the picture using **Messaging**, **Gmail**, or **SoftaBank Mail**.
- Select **SyncUp** to save the picture on Dell SyncUp cloud storage so you can access it anywhere. For more information about Dell SyncUp, see "Dell SyncUp" on page 125.

3 Touch to view the picture information.

4 Touch to play slideshow.

5 Touch for more actions:

- **Crop**: Touch to drag and move the frame to crop the desired portion of the picture.
- **Rotate**: Touch to rotate the picture 90 degrees clockwise.
- **Fix Red Eye**: Touch to remove red eye.
- **Auto-Fix**: Touch to automatically fix the picture settings. Touch **Save** at the top of the screen to apply the changes and save the picture as a new file.

7 Touch  to zoom-in or  to zoom-out the picture.

NOTE: You can also tap twice anywhere inside the picture frame to toggle between the zoom-in and zoom-out states. After a picture is zoomed in, you can flick the screen to see the desired portion of the picture.

8 Touch to return to the camera viewfinder.



To play a video

1 Touch a video thumbnail to view it on full screen.

2 Touch a video to start playback.

 **NOTE:** You may prompted to select a video player to start playback.

3 To control playback, use the controls below the viewing screen:

- Touch the  button to pause and the  button to resume playback.

- Touch or drag the blue playback progress bar to rewind or fast-forward the video.

To share a picture or video

When viewing picture or video thumbnails, touch and hold a thumbnail and then drag the thumbnail to an application icon for sharing.

To configure PhotoStage settings



On any PhotoStage screen, touch  → **Settings**.

- **General Settings:** Touch to view the software version and check for latest updates.
- **Account Settings:** Touch to set up and sync your Facebook account and Picasa web album.
- **Slideshow Settings:** Touch to set up the slideshow transition, duration, and slideshow music.
- **Favorite Contacts:** Touch to add favorite contacts.

Dell Stage Remote







With Dell Stage Remote you can play videos, music, and view pictures from other Dell Stage Remote compatible devices that are on the same network with your smartphone and vice versa.

You must configure the smartphone when using Dell Stage Remote for the first time.

- 1 Touch  →  → **Stage Remote** .
- 2 Touch **Start**.
- 3 Type the desired name of your smartphone in the textbox.
- 4 Select the **Make this device visible in the Stage Remote network** check box.
- 5 To use this device as the content source, select the **Use this device as a source** check box.
- 6 Touch **Add a PIN** to configure a PIN. When configured, other devices will be prompted to type the correct PIN before allowing to browse the content of your smartphone.

- 7 Touch **Next**.
- 8 Select the check box of the type of files that will be visible to other devices, and then touch **Next**.
- 9 The smartphone displays compatible devices on the network. Select the check box of the device(s) to view and share contents.
- 10 Touch **Done**.

To use Stage Remote

- 1 Touch  →  → **Stage Remote** .
- 2 Touch the type of file you want to view or play.
- 3 The connected devices are displayed as tabs on the top of the screen. Flick to scroll through the tabs and view the contents as thumbnails.
- 4 Touch a thumbnail to play the file or view in full screen. For pictures and music, you can select more than one file to play or view. Touch and hold a thumbnail until check boxes appear. Touch the check boxes to select the files, and then touch **Play selected music** or **View selected photos**.
- 5 Touch where you want to play or view the file.
- 6 During playback, touch anywhere on the screen to display the playback controls.
- 7 Displayed playback controls vary depending on the type of file being played and the number selected files.
 - Touch  to pause playback.
 - Touch  to stop playback.
 - Touch  or  to go to the next or previous file.

Dell Work Profile

Dell Work Profile, also known as Divide, creates a separate work profile on your smartphone to safeguard your work data and applications but still allows you to consolidate work and personal life right on your smartphone.

You may be prompted to install additional components when using Divide for the first time. Divide activation is also required.

- 1 Touch **☰** → **Settings** → **Work Profile**.
- 2 Type your email address and password.
- 3 Select the **I agree to the Terms of Service and Privacy Policy** check box.
- 4 Touch **Activate**.

 **NOTE:** Depending on your work email address, you may need to select an account type and enter the server name, domain, and other information. Consult with your network administrator for the required information.

After Divide activation, the smartphone automatically switches to work profile.

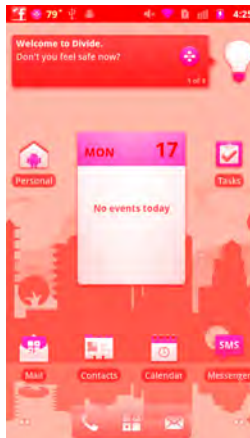







The work profile home screen works similar to the standard Dell home screen.

 **NOTE:** Not all applications are available when using the work profile.

To switch between personal and work profile

To switch between personal and work profile, do one of the following:

- Touch the  twice.
- Drag the notifications bar downwards, and then touch **Switch to personal profile** or **Switch to work profile**.
- In work profile, touch  →  → **Personal**  to switch to your personal profile or in personal profile, touch  →  → **Divide**  to switch to work profile.

To configure work profile settings

In work profile, touch  → **Preferences**.

In personal profile, touch  → **Settings** → **Work profile** → **Work profile settings**.



More Web Applications

 **NOTE:** An active Wi-Fi or mobile data network connection (GPRS, EDGE, 3G, or HSPA) is required to be able to connect to the web. For more information about configuring your smartphone for web connectivity, see "Connecting to the Internet" on page 71.

 **NOTE:** Not all applications are available in all versions of this product.

AccuWeather



AccuWeather is an Internet application designed to provide a four-day weather forecast at a glance. An hourly weather information is also available.

- 1 Touch  →  → **AccuWeather** .



 **NOTE:** When opening AccuWeather for the first time, you will be asked to read and agree with the application's terms and conditions.

- 2 Type a city into the search box using the keyboard.



 **NOTE:** To add your current location, touch .

- 3 Touch the  key on the Android keyboard or the  key on the OpenWnn/Flick support keyboard to start the search.
- 4 Scroll the listed search results and touch to select a desired city.

To add more locations

- 1 On the AccuWeather screen, touch  → **Locations**.
- 2 Touch  → **Add Location**.
- 3 Type a city into the search box using the keyboard.

 **NOTE:** To add your current location, touch .

- 4 Touch the  key on the Android keyboard or the  key on the OpenWnn/Flick support keyboard to start the search.
- 5 Scroll the listed search results and touch to select a desired city.

To refresh the weather information

On the AccuWeather screen, touch  → **Refresh**.

To switch between locations

- 1 On the AccuWeather screen, touch  on the upper-right corner of the screen.
- 2 Touch a location that you want to view.

To view hourly weather information

On the AccuWeather screen, touch  → **Hourly**.

To change the units

- 1 On the AccuWeather screen, touch  → **More** → **Units**.
- 2 On the pop-up menu, touch **Imperial** or **Metric**.

To change the time format



- 1 On the AccuWeather screen, touch  → **More** → **Time Format**.
- 2 On the pop-up menu, touch **12 Hour** or **24 Hour**.

Amazon Kindle

Amazon Kindle allows you to purchase books from the Kindle store and read books right on your smartphone.



NOTE: You must create an account and register your device with Amazon Kindle to use this application.

- 1 Touch  →  → **Amazon Kindle** .



NOTE: To create an Amazon account, touch **Don't have an Amazon account?**, and then follow the on-screen instructions to create your account.

- 2 Type the e-mail address and the password that you used to create the Amazon account.
- 3 Touch **Register** to register your device. The Kindle Home screen appears.

To read books

- 1 The Kindle Home screen displays free and purchased books from the Kindle store. Touch a book to open it.



NOTE: Touch and hold a book to access the options menu to allow you to go to last page read, go to the beginning, or go to a particular location of the book.

- 2 Touch the left or right page edge or flick to turn the page.
- 3 Touch the center of the page to view the status and current location on the book.



NOTE: You can scroll the location slider bar to advance to other pages in the book.

- 4 Touch and hold a word to bring up the dictionary definition, add a note, highlight, or search the word in Book, Wikipedia, or Google.
- 5 Touch the lower right corner of the page to lock the screen orientation.
- 6 Touch ☰ to customize viewing options, bookmark a page, go to a specific page, share the book, search a word in the book, or return to the Kindle Home screen.

To view archived books

On the Kindle Home screen, touch ☰ → **Archived Items**.

To access Kindle Store

On the Kindle Home screen, touch ☰ → **Kindle Store**.

To sort books

- 1 On the Kindle Home screen, touch ☰ → **Sort By**.
- 2 On the Sort By menu, touch to sort books by **Title**, **Author**, or **Most Recent**.

To sync books

On the Kindle Home screen, touch ☰ → **Sync**.

To delete books





- 1 On the Kindle Home screen, touch  → **More** → **Remove Items**.
- 2 Select the check box of the book that you want to delete.
- 3 Touch **Remove** to delete the book.

To customize the Kindle Home screen

- 1 On the Kindle Home screen, touch  → **More** → **View**.
- 2 On the View menu, touch one of the following options:
 - **List**: To display books in a list with book icons, title, and author.
 - **Grid**: To display books in thumbnail mode.

To search books

You can search for books in your collection by title or author.

- 1 On the Kindle Home screen, touch  → **More** → **Search**.
- 2 To search by typing:
 - a Type the book title or author you want to find in the search box.
 - b Touch the  key on the Android keyboard, the  key on the OpenWnn/Flick support keyboard, or the search icon  on the search box.

To search by voice:

- a Touch .
- b Say the book title or author.



NOTE: As you enter information, matching items appear below the search box. You can touch a matching title or author to open the book.

To send feedback about Amazon Kindle

- 1 On the Kindle Home screen, touch  → **More** → **Send Feedback**.
- 2 Type your comments in the text field.

3 Touch **Send** to send the feedback.

To manage settings

- 1 On the Kindle Home screen, touch **☰** → **More** → **Settings**.
- 2 The Settings menu provide the following options:

Deregister this device	Remove registration of your smartphone from your Amazon account.
Device Name	The name assigned by Amazon Kindle to your smartphone.
Volume Buttons Control	Select the check box to use the volume buttons to turn pages.

To view help or other info





On the Kindle Home screen, touch **☰** → **More** → **Help** or **Info**.

Amazon MP3

Amazon MP3 allows you to purchase MP3 music online and play music on your smartphone using Amazon Cloud Player.

 **NOTE:** To download music files, you must have an Amazon account and your payment settings are configured. It is recommended to use your computer and visit Amazon's website (www.amazon.co.uk/sign-in) to complete the account setup.

To open Amazon MP3

- 1 Touch  →  → **Amazon MP3** .
- 2 On the Amazon MP3 home screen, touch . Music files are grouped in **Playlists**, **Artists**, **Albums**, and **Songs** tabs.
- 3 Touch a tab to display the desired category.

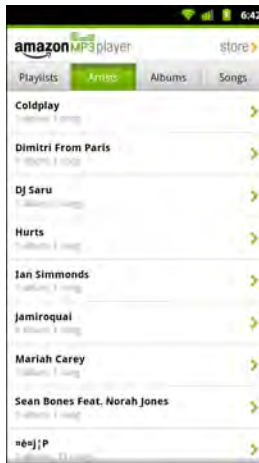

To select a song

- 1 Touch an album or category to view the list within it.
- 2 Inside a category, flick until you find the music you want to play.
- 3 Touch a music file to open the Amazon MP3 playback screen and play the music.

To control music playback

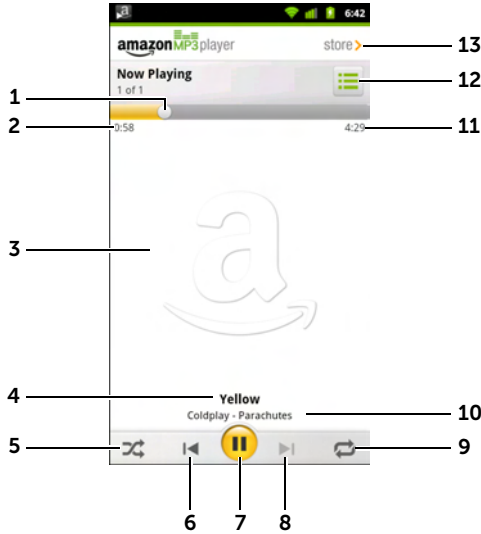

-
- 1
 - Touch the playback control button to jump to any part of the song.
 - Drag and scroll the playback control button forward to fast-forward the song.
 - Drag and scroll the playback control button backward to rewind the song.



 - 2 The current playback time.

 - 3 The album's cover image if available.

 - 4 The name of the song being played.

 - 5 Touch to turn the shuffle mode on and off.

 - 6
 - If the song has played for more than two seconds, touch to jump to the beginning of the song.
 - If the song has played for less than two seconds, touch to play the previous song.
-

-
- 7 Touch  to pause playback, touch  to resume playback.

 - 8 Touch to play the next song.

 - 9 Touch to cycle through the repeat modes.



 - 10 The name of the artist and album.

 - 11 The duration of the song.

 - 12 Touch to go to the Now Playing list.

 - 13 Touch to open Amazon store.

To open Amazon store

- 1 Touch  or touch  → **Home** → .
- 2 The Amazon store screen opens. Songs are grouped by categories. Flick until you find the music you want to play.



-
- 1 Type the song or album name you want to search here.

 - 2 To sort songs or albums according to categories, touch a category: **Bestsellers**, **New Releases**, and **Browse by Genre**.

 - 3 The Amazon store displays popular albums here for direct access.

 - 4 Touch to buy the album or songs from the album.

5 Touch to search for the album or song typed in the search box.

6 Touch to return to the song list screen.

To download a song or album

- 1 Scroll and browse listed songs or albums.
- 2 Touch the song or album you want to download.
- 3 To playback a song before downloading, touch the song name.
- 4 To download a song or album, touch the price button, and then touch .
- 5 Sign in to Amazon MP3 Store using your Amazon account. If you do not have an Amazon account, visit www.amazon.co.uk/sign-in and follow the instructions on the screen to create an account and set up your payment method.
- 6 Select **I have read and agree to the Amazon MP2 Store Terms of Use**.
- 7 Touch **Sign in**.





NOTE: To complete your purchase, a valid payment method must be associated with your Amazon account.

Facebook

Facebook is a social networking site that allows you to chat, post comments, upload photos and videos, and view your friends' status.



To login to Facebook

- 1 Touch  →  → **Facebook** .
- 2 Type your e-mail address and password.
- 3 Touch **Login**.



Napster

Napster is an on-demand jukebox that allows you to listen to songs on your smartphone without purchasing, downloading, or syncing music files.

To register to Napster

- 1 Touch  →  → **Napster** .
- 2 Type your e-mail address and password.
- 3 Touch **Register for Napster**.
- 4 On the Welcome screen, touch **Start Here**. The Napster website opens.
- 5 Touch **Sign In/Sign Up**.
- 6 Touch **Sign Up**.
- 7 Type your e-mail address.
- 8 Touch **Next**.
- 9 Napster will suggest a member name for you. If you do not want the suggested name, type the desired name in the **Member Name** text field.
- 10 Type your password.
- 11 Touch **Next**.
- 12 Your member name and password are displayed on the screen. Touch **Return to Home** to return to the previous screen.

To open Napster

- 1 Touch  →  → **Napster** .
- 2 Type your member name and password.
- 3 Touch **Sign In**.

4 Touch **Explore**.

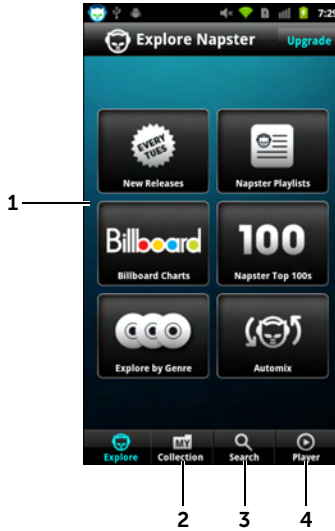

-
- 1 Touch to view song list according to category.
 - 2 Touch to view your playlist, top songs, recommended songs, and history of songs you have played.
 - 3 Touch to search for songs in Napster.
 - 4 Touch to open the Napster player. The screen opens with the last played song.
-

To play songs

- 1 On the **Explore** or **Collection** screen, touch a category to view the song list.
- 2 Scroll and browse listed songs.
- 3 Touch a song to play it.
- 4 On the playback screen, touch the center of the screen to display the playback controls.



To search for songs

- 1 Touch the **Search** tab.
- 2 Type the song, album, or artist's name on the **Search Napster** box.
- 3 Touch **Artists**, **Albums**, or **Songs** tab to filter your search.
- 4 Touch a matching item to view the album or artist information or play the song.

To manage settings

On the Napster screen, touch  → **Settings**.

To close Napster

- Touch  → **Sign out** to sign out of Napster. You will be required to sign in with your member name and password the next time you open Napster.
- Touch  → **Quit** to close Napster.

ooVoo

ooVoo provides group video chats, text messaging, and conference calls.





To open ooVoo

- 1 Touch  →  → **ooVoo** .

 **NOTE:** You need an ooVoo account to use ooVoo on your smartphone. If you do not have an ooVoo account, touch **Create account** on the bottom of the screen. Enter the necessary information, and then touch **Create**.



- 2 Type your ooVoo ID and password.
- 3 Touch **Sign in**.

To add contacts

- 1 Touch  →  → **ooVoo** .
- 2 On the Contacts screen, touch  → **Add contact**.

- 3 Type your friend's ooVoo ID, name, or e-mail address.
- 4 Touch .
- 5 Matching ooVoo users appear on the screen. Touch a match to view the user information.
- 6 Touch Add to add the user to your contacts list.

To call with video

- 1 Touch  →  → ooVoo .
- 2 On the Contacts screen, touch a contact.
- 3 Touch **Start a video call**.

 **NOTE:** Video call is available only if the contact you want to call is online. Otherwise, you can only send the contact instant messages.



-
- 1 Displays the video image of the other party you are talking to.



 - 2 Touch to switch between the front and the rear camera.

 - 3 Touch to add another call.

 - 4 Touch to end the call.

 - 5 Touch to mute or unmute the microphone

To call by voice

- 1 Touch  →  → ooVoo .
- 2 On the Contacts screen, touch a contact.
- 3 Touch **Start a voice call**.

 **NOTE:** Voice call is available only if the contact you want to call is online. Otherwise, you can only send the contact instant messages.

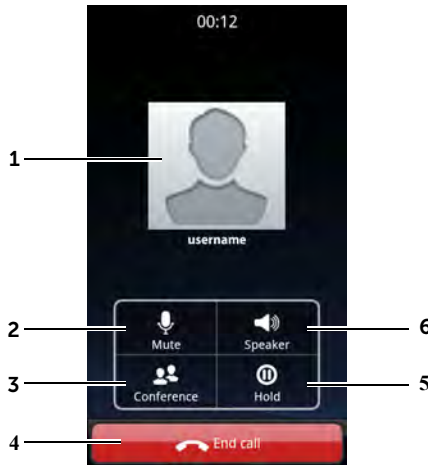

-
- 1 Displays the contact information of the person you are talking to.
 - 2 Touch to mute or unmute the microphone
 - 3 Touch to add another call.
 - 4 Touch to end the call.
 - 5 Touch to place the current call on hold.
 - 6 Touch to enable or disable the speakerphone.
-

To answer a call

When a contact calls you either by voice or video, the caller's name appears on the screen. Touch **Answer** to answer the call or **Reject** to reject the call.

Quickoffice

Quickoffice allows you to open or save Quickword documents, Quicksheets, Quickpoint, and Quickpdf files on your smartphone's microSD card or to a cloud storage.

To open Quickoffice

- 1 Touch  →  → **Quickoffice** .

 **NOTE:** When using Quickoffice for the first time, you will be asked to register your software to receive product updates and important notifications. Type your e-mail address and then click **Register now**. Follow the instructions on the screen to complete the registration. Or, touch **Register Later** to skip the registration process.

- 2 The Quickoffice Home screen opens.



-
- 1 Touch to create Quickword documents.

 - 2 Touch to create Quickpoint documents.

 - 3 Touch to search for files on the smartphone's microSD card.





 - 4 Touch to browse for files on the smartphone's microSD card or a cloud storage.

 - 5 Touch to check software updates.







 - 6 Touch to open the Quickoffice website.

-
- 7 Touch to view Quickoffice's user guide and FAQs on the web.
 - 8 Touch to add remote accounts, such as Google Docs, Dropbox, MobileMe, and others, where you can save your documents.
-
- 9 Touch to view QuickPDF documents.
-
- 10 Touch to create Quicksheet documents.
-



To add a remote account

- 1 Touch  →  → **Quickoffice** .
- 2 Touch .
- 3 Touch your remote account server.
- 4 Type the e-mail address or member ID and password.
- 5 Touch **OK**.

To create Quickoffice documents

- 1 Touch  →  → **Quickoffice** .
- 2 Touch the type of Quick office document you want to create.
- 3 Touch **Create New Document**.
- 4 Touch the desired document version.
- 5 Type the contents of your document.
- 6 Touch  to customize fonts, search text, add image, and other document options.
- 7 Touch  →  → **Save**.
- 8 Type the desired filename on the **Save as** text field.
- 9 Touch **SD card** to save the file on the microSD card or a remote account (if available) to save it to cloud storage.
- 10 Touch **Save**.



To open documents

- 1 Touch  →  → **Quickoffice** .
- 2 Touch the type of Quick office you want to open.
- 3 Touch **SD card** or a remote account (if available) to browse for the file you want to open.
- 4 Scroll and browse for the file.
- 5 Touch the file to open it.

TuneIn Radio

TuneIn Radio allows you to listen to radio stations or podcasts over the Internet.

To open TuneIn Radio

- 1 Touch  →  → **TuneIn Radio** .
- 2 Touch **Browse** tabs to view station or show categories.
- 3 Touch a category and browse for the desired radio station or show.
- 4 Touch a radio station or show to start tuning.



-
- 1 The radio station or show currently playing.

 - 2 Touch to add the station or show to My Presets.

 - 3 Touch to share the station or show on **Facebook, Twitter, or Email**.

 - 4 Touch to stop tuning.

 - 5 Touch to report a problem, view recommended stations or shows similar to the current one, see the complete schedule, set alarm or sleep timer.

 - 6 Touch to search for a radio station or show.

Twitter

Twitter allows you to share tweets right on your smartphone.

Touch  →  → **Twitter**  .

5 Applications

Camera

Your smartphone has a 8.0 megapixel camera with auto-focus feature that allows you to capture and share high-quality pictures and videos.

To launch the camera in picture mode

To launch the camera, do one of the following:

- Touch the Launcher button  → **Camera** 

Camera controls

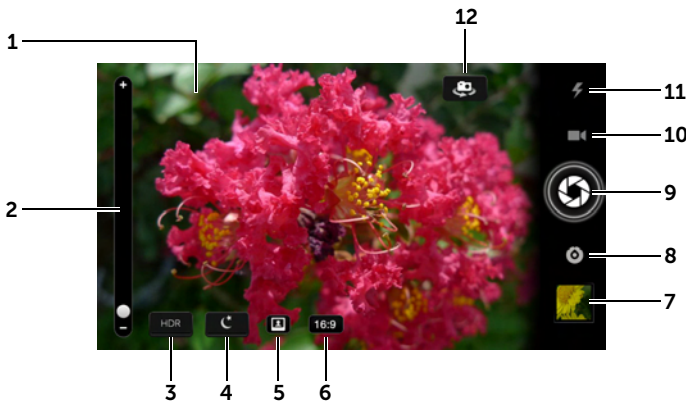

-
- 1 Viewfinder screen
 - 2 Touch "+" to zoom in or "-" to zoom out the camera focus. Or, drag the slider to adjust the zoom.
 - 3 Touch to turn high dynamic range (HDR) function on or off.
 - 4 Touch to turn night mode on or off.
 - 5 Touch to toggle between auto-focus mode and auto exposure bracketing (AEB) mode. With AEB mode, three pictures with different settings are captured with one touch of the shutter button.
-

-
- 6 Touch to toggle the aspect ratio between 16:9 and 4:3.
-
- 7 Touch the thumbnail view of the last taken picture to view and manage the picture.
-
- 8 Touch to select the type of picture to capture:
- **Normal:** Capture standard pictures.
 - **Panorama:** Capture a panoramic picture of up to five shots that are stitched together.
 - 1 Focus on the left-most or right-most edge of the object in the viewfinder screen.
 - 2 Touch the on-screen shutter button and release to capture the left-most or right-most edge of the picture. The preview bar displays the captured shot.



Preview bar

- 3 Drag the phone to the left or to the right to capture the next shot. As you drag the phone, the camera automatically captures the connecting shot.
 - 4 Repeat step 3 to continue connecting more shots. You can connect up to five shots.
 - 5 To complete the picture before reaching the five maximum shots, touch the on-screen shutter button to save the panoramic picture.
-

-
- 9
- On-screen shutter button.
 - To capture a picture:
 - 1 Focus on the object in the viewfinder screen.
 - 2 To start the auto focus mode, half-press and hold the camera button, or touch and hold the on-screen shutter button.
 - 3 Touch the on-screen shutter button and release to capture the picture.

NOTE: To achieve optimal focus such as for taking a close shot, half-press and hold the camera button to use the auto-focus mode. Then without releasing the camera button, press it again to capture the picture.
-
- 10 Touch to toggle between camera mode for capturing pictures, and the camcorder mode for capturing videos.
-
- 11 Touch the thumbnail view of the last taken picture to view and manage the picture.
-
- 12 Touch to turn the flash on or off.
-
- 13 Touch to toggle between using the front camera or the rear camera to capture pictures and videos.
-



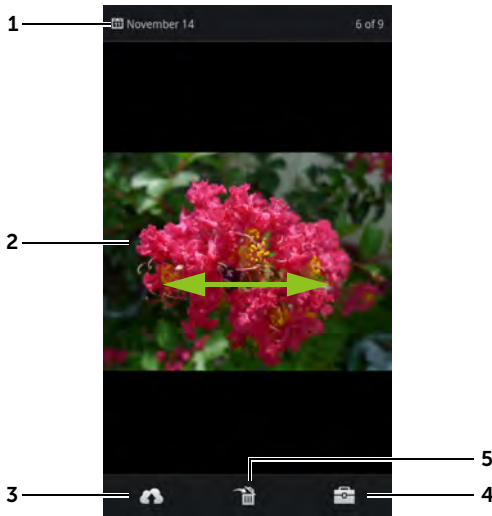

To manage pictures



-
- 1 Displays the date when the picture was taken, the current file and the total number of files

 - 2
 - Flick horizontally to view the previous or next picture.
 - Double-touch the screen to zoom in or zoom out the image.

 - 3 **Share:** Touch to select a way to share the picture.
 - Select **Picasa**, **Twitter**, or **Facebook** to upload the picture to Picasa, Twitter, or Facebook to allow your friends see it.
 - Select **Bluetooth** to send the picture to another paired Bluetooth device, or print the picture using a paired Bluetooth printer.
 - Send the picture using **Messaging**, **Gmail**, or **Email**.
 - Select **SyncUp** to save the picture on Dell SyncUp cloud storage so you can access it anywhere. For more information about Dell SyncUp, see "Dell SyncUp" on page 125.

 - 4 Touch to view more actions that you can do with your picture.
 - Touch  to set the picture as a contact's visual caller ID, or the wallpaper of the Home screen.
 - Touch  to drag and move the frame to crop the desired portion of the picture.
 - Touch  to rotate the picture 90 degrees counterclockwise.
 - Touch  to view detailed information about the picture.

 - 5 Touch to delete the current file.
-

To start the camcorder mode

Touch the Launcher button  → **Camera** , and then touch  to switch from camera mode to camcorder mode .

Camcorder controls



-
- 1 Viewfinder screen.
 - 2 Touch the thumbnail view of the last captured video to play and manage the video.
 - 3 To start or stop recording, touch this on-screen video recording button or press the camera button.
 - 4 Touch to toggle between the camera mode for capturing pictures, and the camcorder mode for capturing videos.
 - 5 Touch to turn the LED light on or off.
 - 6 Touch to toggle between using the front camera or the rear camera to capture videos.
-

To manage videos



-
- 1 Flick horizontally to view the previous or next video.

 - 2 Touch to play the video.

 - 3 Touch to select a way to share the video.
 - Select **Facebook**, **Twitter**, or **Picassa** to upload the video to the Facebook, Twitter, or Picassa website, where people can view the posted video. To upload videos, you must first sign in to your Facebook, Twitter, or Picassa account.
 - Select **Bluetooth** to send the video to another paired Bluetooth device.
 - Select **SyncUp** to save the video on Dell SyncUp cloud storage so you can access it anywhere. For more information about Dell SyncUp, see "Dell SyncUp" on page 125.
 - Send the video using **Messaging**, **Gmail**, or **Email**.

 - 4 Touch to delete the video from your smartphone.

 - 5 Touch to view detailed information about the video.

 - 6 Displays the date when the video was captured, the current file and total number of files.
-

Copying Files to and from the Phone Memory Cards

The files on your smartphone are stored on the internal phone memory. To exchange pictures, videos, music, and other files between your smartphone and a computer, use the memory cards as USB drives by connecting the smartphone to a computer with the included USB cable.

To set the phone memory cards as a USB drive

- 1 Connect one of the USB cable to the micro-USB connector on your smartphone and the other end to an available USB connector on your computer.
- 2 The USB notification icon  appears on the status bar's notification area.
- 3 Drag down the status bar, and from the Notifications panel that opens, touch **USB connected**.
- 4 Touch **Turn on USB storage** → **OK**, if you want to copy files between your computer and the memory cards.
- 5 Open the **My Computer** window on your computer to locate two removable drives. One drive maps to the internal phone memory card and the other to the microSD card installed on your smartphone. Then copy the desired files such as music or pictures from another drive/folder to the removable drive(s), or vice versa.



To turn off USB storage

The smartphone will not recognize the memory cards when the memory cards are used as USB drives. You will not be able to use the smartphone's applications that involve saving or retrieving files on the internal phone memory card or the microSD card, such as camera or music playback. You need to turn off USB storage for the smartphone to recognize the internal phone memory card and the microSD card when the smartphone is connected to a computer.

To turn off the USB storage function:

- 1 Drag down the status bar to open the Notifications panel.
- 2 Touch **Turn off USB storage**.

To remove the microSD card

- 1 Touch the Home button  → Menu button  → **Storage**.
- 2 On the External SD card section, touch Unmount SD card. The  icon appears on the status bar indicating that the microSD card is safe to be removed.
- 3 Lift to open the micro-SIM and microSD card cover.
- 4 Using a fingertip, push the microSD card to eject it from the slot.
- 5 Slide the microSD card out from the slot.



Bluetooth

Bluetooth is a short-range wireless communications technology that lets your smartphone connect over a wireless network to other Bluetooth-enabled devices.

Bluetooth on your smartphone operates in three different modes:



On	Bluetooth is turned on. Your smartphone is enabled to detect Bluetooth devices within range, but will not be found by them.
Discoverable	Bluetooth is turned on, and other Bluetooth devices can detect your smartphone.
Off	Bluetooth is turned off. Your smartphone is unable to send and receive data using Bluetooth.

To turn on Bluetooth and make the smartphone discoverable

- 1 Touch the Home button  → Menu button  → **Settings** → **Wireless & networks**.
- 2 Select the **Bluetooth** check box to turn on Bluetooth. The Bluetooth icon  appears in the status bar.

- 3 Touch **Bluetooth settings**, then select the **Discoverable** check box to make the smartphone recognizable by other nearby Bluetooth devices.

To pair and connect a Bluetooth device

- 1 Touch the Home button  → Menu button  → **Settings** → **Wireless & networks** → **Bluetooth settings**.
- 2 Touch and select the **Bluetooth** check box. Your smartphone starts to scan for Bluetooth devices within range and then displays all detected devices in the **Bluetooth devices** section.



NOTE: To detect more devices, touch **Scan for devices**.

- 3 To initiate a connection with a device, touch the name of the device.
- 4 You may be prompted to enter a password to authenticate. Enter the same password on both devices, or enter the password provided by the device manufacturer. Ensure that you read the documentation of the pairing device to check if it requires a default password.
- 5 When the pairing is successful, **Paired, but not connected** is displayed under the paired device.



NOTE: The message indicating successful pairing may vary depending on the type of the paired device. For example, if the paired device is a Bluetooth headset, the **Connected to phone audio** or **Connected to phone and media audio** message will be displayed and the Bluetooth connected icon  appears in the status bar.





NOTE: To make and receive calls or listen to music using a Bluetooth headset, pair the headset to your smartphone.





NOTE: Pairing is a one-time process. Once your smartphone successfully pairs with another device, your smartphone recognizes that device without the need to re-enter the password.



To end a Bluetooth connection

- 1 Touch the Home button  → Menu button  → **Settings** → **Wireless & networks** → **Bluetooth settings**.
- 2 Touch and hold the name of a connected device.
- 3 Touch **Disconnect** on the pop-up menu that appears.



To terminate a pairing partnership

- 1 Touch the Home button  → Menu button  → **Settings** → **Wireless & networks** → **Bluetooth settings**.
- 2 Touch and hold the name of a paired device.
- 3 Touch **Unpair** or **Disconnect & unpair** if a device is still connected, on the pop-up menu that appears to erase all pairing information with that device. You need to enter the password again if you want to restore a Bluetooth connection to that device.

To change your smartphone's Bluetooth name

- 1 Ensure that you have turned on Bluetooth on your smartphone (The  icon in the status bar indicates that Bluetooth is enabled).
- 2 Touch the Home button  → Menu button  → **Settings** → **Wireless & networks** → **Bluetooth settings** → **Device name**.
- 3 Enter a name to identify the smartphone when you connect using Bluetooth.
- 4 Touch **OK**.

Photos and Videos

To view and manage the pictures and videos stored on your smartphone, touch the Launcher button  → **Gallery** .





The Gallery application displays not only the pictures and videos stored on your microSD card, but also those uploaded to the Picasa web album of your Gmail account which you signed in with on your smartphone.

To share or delete albums

All pictures and videos are grouped in separate albums as overlapping thumbnails, according to their dates, sources, or folders in which they are stored. For example, pictures captured using the smartphone's camera are grouped as **Camera**, and downloaded pictures are grouped as **download**.

- 1 Touch and hold an album until the check box  appears.
- 2 Touch more albums to select them if you want to do the same task for those albums.
 - To post the selected album to YouTube, Picasa, SyncUp or to send it using Bluetooth, Messaging or Gmail, etc., touch **Share**.
 - To delete the album, touch **Delete**.

To browse picture and video thumbnails

- 1 Touch an album to display the thumbnails of all pictures and videos inside.
- 2 To browse the thumbnails:
 - Touch or drag    to display all the thumbnails in grid view, or group them by date as overlapping thumbnails.
 - When the thumbnails are displayed in grid view, drag  or touch the arrows on it to move thumbnails horizontally, until the desired thumbnail is located.

- 3 To select a thumbnail, touch and hold it until  appears; touch more thumbnails as you need.
 - To post a selected picture or video to YouTube, Picasa, Twitter, Facebook, SyncUp or to send it using Bluetooth, Messaging or Gmail, etc., touch **Share**.
 - To delete a selected picture or video, touch **Delete**.
 - To set a picture as the Home screen wallpaper, touch **More**→ **Set as**→ **Wallpaper**.
 - To set a picture as a contact's icon, touch **More**→ **Set as**→ **Contact icon**.

To manage pictures

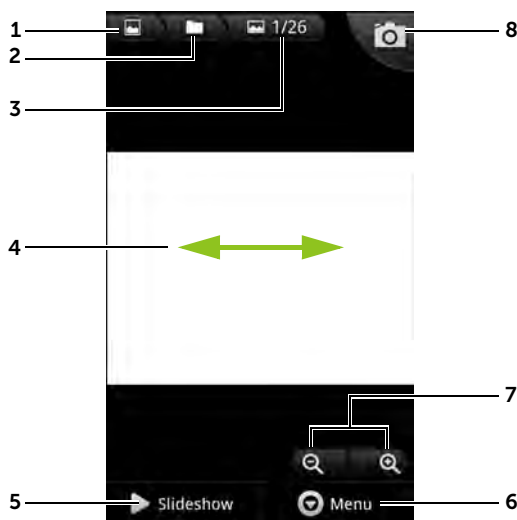

-
- 1 Touch to return to the Gallery main page.

 - 2 Touch to return to the album the current picture belongs to.

 - 3 Display current/total number of pictures.

 - 4 Flick horizontally to view the previous or next picture.

 - 5 Touch to run a slideshow of the pictures stored in the same album.

6 Touch to view more actions you can do with the picture.

- **Share:** Touch to select a way to share the picture.
 - Select **Picasa**, **Twitter**, or **Facebook** to upload the picture to Picasa, Twitter, or Facebook to allow your friends see it.
 - Select **Bluetooth** to send the picture to another paired Bluetooth device, or print the picture using a paired Bluetooth printer.
 - Send the picture using **Messaging**, **Gmail**, or **Email**.
 - Select **SyncUp** to save the picture on Dell SyncUp cloud storage so you can access it anywhere. For more information about Dell SyncUp, see "Dell SyncUp" on page 125.
- **Delete:** Touch to delete the picture from your smartphone.
- **More:**



- **Details:** Touch to view detailed information about the picture.
- **Set as:** Touch to set the picture as a contact's visual caller ID, or the wallpaper of the Home screen. Drag and move the frame to crop the desired portion as the wall paper.
- **Crop:** Touch to drag and move the frame to crop the desired portion of the picture.
- **Rotate Left:** Touch to rotate the picture 90 degrees counterclockwise.
- **Rotate Right:** Touch to rotate the picture 90 degrees clockwise.

7 Touch  to zoom-in or  to zoom-out the picture.

NOTE: You can also tap twice anywhere inside the picture frame to toggle between the zoom-in and zoom-out states. After a picture is zoomed in, you can flick the screen to see the desired portion of the picture.



8 Touch to open the camera application.

To display a full picture

Touch a desired picture thumbnail to display the picture in full screen.

- Flick the picture to view the next or previous picture.
- To see the picture viewing controls, touch anywhere on the picture.
- To zoom-in or zoom-out on the picture, you can:
 - Touch .
 - Pinch the picture with two fingers, then move the fingers apart to enlarge the picture, or bring them closer together to reduce the picture.
 - To zoom-in or zoom-out on a particular area of the picture, tap that area twice.
 - When a picture view is being enlarged, flick or drag the enlarged picture across the screen until the required area appears.

To play a video

- 1 Touch a video thumbnail to start playback of the video.
- 2 To control playback, use these controls below the viewing screen:
 - Touch the  button to pause and the  button to resume playback.
 - Touch or drag the blue playback progress bar to rewind or fast-forward the video.

Music

To open Music

Touch the Launcher button  → **Music** .

The Music library screen appears and displays the music files grouped in the **Artists**, **Albums**, **Songs**, and **Playlists** tabs. You can touch a tab to display the desired category.

All music files available on your smartphone are grouped into one of the following categories: **Artists**, **Albums**, **Songs**, and **Playlists**.

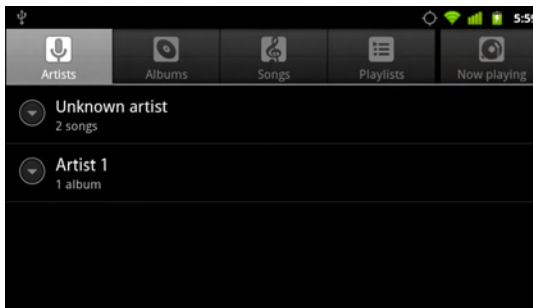



NOTE: If you rotate your smartphone to landscape format, an additional **Now playing** tab appears.

To select a song

- 1 Touch an album or category to view the list within it.
- 2 Inside a category, flick the list until you find the music you want to play. For instance, to select music by artist:
 - a Touch **Artists**. A list of artists appears in alphabetical order.
 - b Flick the list and touch the name of an artist. A list displays the songs by the artist according to the album name.
 - c Touch a music file to open the music playback screen and play the music.

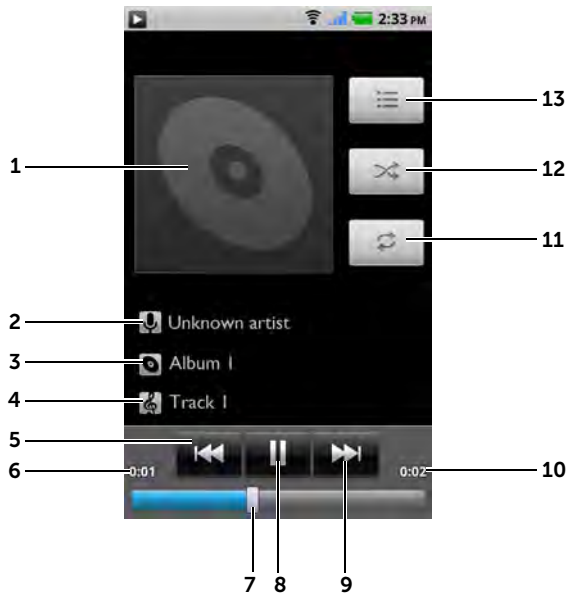
To control music playback



-
- 1** The album's cover image if available.
-
- 2** The name of the artist.
-
- 3** The name of the album.
-
- 4** The name of the song being played.
-
- 5**
- If the song has played for more than two seconds, touch to jump to the beginning of the song.
 - If the song has played for less than two seconds, touch to play the previous song.
-
- 6** The current playback time.
-
- 7**
- Touch the playback control bar to jump to any part of the song.
 - Drag and scroll the playback control bar forward to fast-forward the song.
 - Drag and scroll the playback control bar backward to rewind the song.
-
- 8** Touch  to pause playback; touch  to resume playback.
-

-
- 9 Touch to play the next song.



 - 10 The duration of the song.

 - 11 Touch to cycle through the repeat modes.

 - 12 Touch to turn the shuffle mode on and off.

 - 13 Go to the Now playing list.
-

 **NOTE:** Press the volume up button or volume down button to adjust the playback volume.

 **NOTE:** On the Music screen, touch the Menu button  → **Shuffle all** to play all songs in your library in random order. The first randomly selected song starts to play.

To create a playlist

- 1 On the **Music** screen, touch the **Artists**, **Albums**, or **Songs** tab.
- 2 Flick the screen until you reach the artist, album, or song that you want to add to the playlist.
- 3 Touch and hold the artist, album, or song that you want to add in the playlist. A pop-up menu appears.
- 4 Touch **Add to playlist**.
- 5 In the **Add to playlist** window, touch **New**.

 **NOTE:** If you want to add the artist, album, or song to the current playlist, touch **Current playlist** in the **Add to playlist** options menu.

- 6 Enter the name for your new playlist in the text field and then touch **Save**.

Calendar

Use the calendar to schedule and manage your events, meetings, and appointments.

To open the calendar

Touch the Launcher button  → **Calendar** .

To set up an event

- 1 On any calendar view, touch the Menu button  → **More** → **New event** to open the **Event details** screen.
- 2 Type the event name using the on-screen keyboard.
- 3 If there is a time period for the event, touch and type the **From** and **To** date and time.
If the event is a special occasion such as a birthday or spans the whole day, set the **From** and **To** date, and then select the **All day** check box.
- 4 Type the event location and description.
- 5 If you have more than one calendar, you can choose the calendar to which to add the event.
- 6 Set the event reminder time in **Reminders**, then decide whether it is a recurring event in **Repetition**.
- 7 Touch **Done**.



NOTE: To quickly set up an event in day, week, or month view, touch and hold an empty time slot → **New event**. A new **Event details** screen appears with the selected time slot and date in the **From** and **To** fields.

To view the calendar

You can display the calendar in daily, weekly, monthly, or agenda view.

To change the calendar view, touch the Menu button  → **Day/Week/Month/Agenda/Today**.

While viewing the calendar you can:

- In day or week views, touch an event to open a quick view window of the event on the lower part of the screen.
- Touch the quick view window to view details about the event.
- Touch and hold an event to open a menu with options for viewing, editing, or deleting the event, or creating a new event.

To view and synchronize multiple calendars

If you have set up more than one account on your smartphone, you can view multiple calendars from the accounts on your smartphone. You can configure which calendars to synchronize to the smartphone, and which of those to show or hide on the smartphone in **Calendar**.

To set whether calendars are synchronized to the smartphone or visible:

- 1 In **Calendar**, touch the Menu button  → **More** → **Calendars**.

The **Calendars** screen displays all the calendars you have added or subscribed to for each account on your smartphone, organized by account. Touch the name of an account to show or hide its calendars on your smartphone. An icon to the right of each calendar indicates whether its events are synchronized to the smartphone and whether they are visible in **Calendar**.

- 2 Touch the icon next to a calendar to change whether it is synchronized to the smartphone and visible in **Calendar**.



Calendar events are synchronized to the smartphone and visible in **Calendar**.



Calendar events are synchronized to the smartphone but not visible in **Calendar**.



Calendar events are not synchronized to the smartphone.

- 3 Touch **OK**.

Event reminders

If you set a reminder for an event, the upcoming event icon  appears in the notifications area of the status bar at the time of the event.

To view, dismiss, or snooze a reminder

- 1 Touch the notification area of the status bar, to open the notification menu.
- 2 Touch the upcoming event name to display the event.



 **NOTE:** If you have other pending event reminders, these events will also appear on the screen.

- 3 Touch **Snooze all** to put off all event reminders for five minutes. Touch **Dismiss all** to turn off all event reminders.
Press ← to keep the reminders pending in the notification area of the status bar.

Alarm Clock



Your smartphone can work as an alarm clock. You can set as many alarms as you require.

To open the alarm clock

- 1 Touch the Launcher button  → **Clock** .
- 2 Touch .



To set an alarm

- 1 On the **Alarms** screen, touch **Add alarm**.
- 2 Set the alarm time as needed. The **Set alarm** menu appears with the following settings:

Turn on alarm	Turn on the alarm that you have set on the smartphone.
Time	Set the alarm time. Adjust the time by touching  or  , or touch the hour and minute fields to enter a time. Touch AM to change to PM or vice versa, then touch Set when done.
Repeat	Select the days you want the alarm to ring, then touch OK . NOTE: If you did not select any days for the alarm, Never appears to hint that your alarm will only go off once.
Ringtone	Select the alarm ringtone.

Vibrate	Select the check box if you want the smartphone to vibrate when the alarm goes off.
Label	Give the alarm a name for a special event.

3 Touch **Done** to save the alarm.

 **NOTE:** On the **Alarm Clock** screen you can also add a new alarm by touching the Menu button  → **Add alarm**.

To temporarily disable an alarm

On the **Alarms** screen, touch to clear the green bar that appears next to the alarm you want to disable.

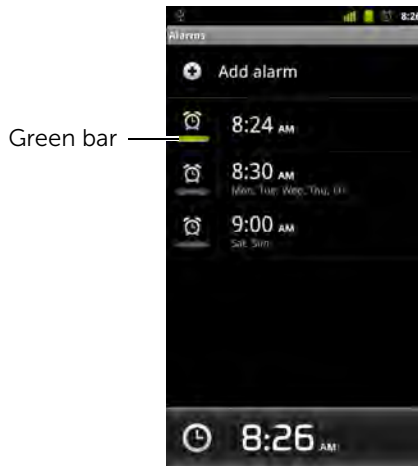

To delete an alarm

- 1 On the **Alarms** screen, touch the alarm time you want to delete.
- 2 On the **Set alarm** screen, touch **Delete**.

To silence all alarms

You can change the settings to choose if the alarm should ring when the smartphone is in Silent mode.

- 1 On the **Alarms** screen, touch the Menu button  → **Settings**.
- 2 Touch **Alarm in silent mode** to set the alarm to ring when the smartphone is in Silent mode.

FM Radio

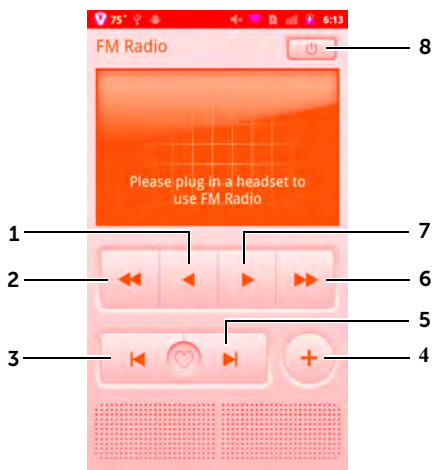

Touch the Launcher button  → **FM Radio** .

 **NOTE:** You must plug in the headset before using the FM Radio.



- 1 Touch to move down a frequency.
- 2 Touch to search for lower frequency.
- 3 Touch to move to the previous favorite channel.
- 4 Touch to add the channel to favorites.
- 5 Touch to move to the next favorite channel.
- 6 Touch to search for upper frequency.
- 7 Touch to move up a frequency.
- 8 Touch to turn radio on or off.







Calculator



- 1 Touch the Launcher button  → **Calculator** . The basic calculator panel opens.
- 2 Perform calculations by touching the corresponding buttons on the calculator panel; touch the **CLEAR** button to clear the displayed numbers or symbols.
- 3 To perform advanced calculations, flick the basic calculator panel away to the left and reveal the advanced panel, or touch the Menu button  → **Advanced panel**.

Sound Recorder

The sound recorder allows you to record sounds and play them. You can also set the recording as a ringtone for your smartphone.

 **NOTE:** Sound Recorder only supports recording in amr format.

- 1 Touch the Launcher button  → **Sound Recorder** .
- 2 Touch  to start recording.
- 3 Touch  to end recording.
- 4 Touch  to start playback of the recording; touch  to stop playback.
- 5 Touch **Use this recording** to save the recording on the internal microSD card.
- 6 To play back a sound recording again, touch the Launcher button

 → **Music**  → **Playlist** → **My recordings**, then select a recording to play. For information about **Music**, see "Music" on page 166.

Voice Dialer

Touch the Launcher button  → **Voice Dialer** .

The voice dialer allows you to make calls and run applications using voice commands on your smartphone. The voice dialer pop-up displays examples of voice commands that you can use.





To use a voice command to start an action

- 1 When Voice Dialer prompts you with voice command examples such as to call a contact, say an appropriate command to start an action. For example, if you want to call a contact named John, say "Call John".
- 2 Once your smartphone recognizes your command, it automatically calls the contact or number.

6 Customizing Your Dell Streak Pro GS01 Smartphone

You can customize your smartphone, using the options available in the **Settings** menu.

Change the Display Settings

- 1 Touch  →  → **Settings** → **Display**, or touch  →  → **Settings** → **Display**.
- 2 Touch the desired item under **Display settings**.
- 3 To enable a setting, touch the setting option to select the check box ; to disable a setting, touch the setting option to clear the check box.

Brightness

Manually adjust screen brightness.

- 1 Drag the brightness slider horizontally or touch the desired portion on the slider. The length of the highlighted bar on the slider determines the brightness of the screen.
- 2 Touch **OK** to confirm the adjustment.

NOTE: If **Automatic brightness** is enabled, the smartphone adjusts the screen brightness automatically based on the surrounding light conditions.

Auto-rotate screen

If enabled, the screen will switch the orientation to landscape or portrait as you rotate the smartphone.

Animation

Set the smartphone to play an animation when opening and closing screens.

Screen timeout

- Set how long the screen remains on after the last operation. Scroll the options and touch a preferred timeout period.
- The screen automatically turns off and locks itself based on the preset timeout duration.
- To turn on and unlock the screen, press the Power button and then flick the  icon to the right to unlock the screen if it is automatically locked.

NOTE: You must draw the unlock pattern if you have set up and enabled the screen lock pattern. For more information, see "Protect Your Smartphone Data With a Screen Unlock Pattern" on page 181.

Change Sound and Ringtone Settings

- 1 Touch the Home button  → Menu button  → **Settings** → **Sound**, or touch  →  → **Settings** → **Sound**.

Use the options under **Sound settings**, and then touch a desired option.

- 2 Flick the list to locate and touch a desired option.
- 3 To enable a setting, touch the setting option to select the check box ; to disable a setting, touch the setting option to clear the check box.

General settings

Silent mode

Silence all sounds except media and alarms.

Vibrate

Set the smartphone to vibrate based on the available settings.

Volume

- **Ringtone:** Adjust ringer volume for incoming calls and notifications.
 - **Media:** Adjust volume for music and video playback.
 - **Alarm:** Adjust volume for alarm ringtone.
 - 1 To adjust volume, drag the sliders horizontally or touch the desired portion of the slider to increase or decrease volume.
 - 2 If you want to set a different volume for notifications, touch **Use incoming call volume for notifications** to clear the check box; then adjust the **Notification** volume.
 - 3 Touch **OK** to confirm the adjustment.
-

Incoming calls settings

Phone ringtone Select the desired ringtone for incoming calls.

Notifications settings

Notification ringtone Select the desired ringtone for notifications.

Feedback settings



Audible touch tones Plays a tone as you dial using the on-screen dialpad.





Audible selection Plays a tone as you touch the screen to select items.

Screen lock sounds Plays a tone when the screen is locked and unlocked.





Haptic feedback The smartphone vibrates when you touch some buttons on the screen in certain circumstances.

Manually Set the Date, Time and Time Zone

- 1 Touch  →  → **Settings** → **Date & time**.
- 2 Touch the desired option.
- 3 Flick the list to locate and touch the desired item.
- 4 To enable a setting, touch the setting option to select the check box ; to disable a setting, touch the setting option to clear the check box.

Select time zone	Allows you to set the date and time automatically based on the server settings.
Set date	<ol style="list-style-type: none">1 Touch or touch and hold  or  to adjust the month, day and year; you can also touch the month, day or year to type a date using the on-screen keyboard.2 Touch Set to confirm the date.
Select time zone	Select a city or region that represents the time zone for your smartphone. Touch  to sort the time zone list alphabetically or by time zone.
Set time	<ol style="list-style-type: none">1 Touch or touch and hold  or  to adjust the hour and minute; you can also touch the hour or minute to type a time using the on-screen keyboard.2 Touch the AM/PM button if the 12-hour format is in use.3 Touch Set to confirm the time.
Use 24-hour format	Clear this check box to display the time in 12-hour format.
Select date format	Select a format used for displaying the date.

Set the Language

- 1 Touch  →  → **Settings** → **Language & keyboard** → **Select language**, or touch  →  → **Settings** → **Language & keyboard** → **Select language**.
- 2 Select a language of your choice from the Locale list that appears.

7 Protecting Your Dell Streak Pro GS01 Smartphone

Protect Your Smartphone Data With a Screen Unlock Pattern

You can protect your smartphone data against unauthorized access by locking the touch screen with a screen unlock pattern. Once the unlock pattern is enabled and the screen is locked, you need to draw the correct unlock pattern to unlock the screen.





After you fail to draw the correct unlock pattern on the screen for five consecutive times, you will be asked to wait for 30 seconds before you can try again. If you no longer remember your screen unlock pattern, follow these steps to unlock your screen:

- 1 Touch **Forgot pattern**.
- 2 When prompted, sign on to the Google website using your Google account name and password.
- 3 Draw a new screen unlock pattern as described in "To create a screen unlock pattern" on page 181.



NOTE: If you are unable to obtain a new unlock pattern following the above steps, visit support.dell.com.

To create a screen unlock pattern



- 1 Touch  →  → **Settings** → **Location & security** → **Set up screen lock** → **Pattern**, or touch  →  → **Settings** → **Location & security** → **Set up screen lock** → **Pattern**.





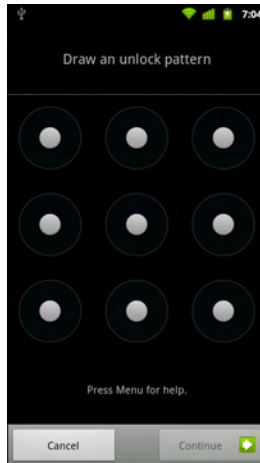

NOTE: To watch an animated example of how to draw a pattern, touch the Menu button . When you are ready to draw your own pattern, touch **OK**.

- 2 Drag your finger to draw an unlock pattern by connecting at least four dots in a vertical, horizontal and/or diagonal direction. Take your finger off the screen when a pattern is drawn.







-  **NOTE:** Touch and drag your finger on the screen to create the pattern.
- 3 The smartphone records the pattern if it is correctly drawn. Touch **Continue**.
 - 4 Draw the pattern again as prompted, and then touch **Confirm**.
-  **NOTE:** To change your unlock screen pattern, you need to draw the old pattern and perform steps 2 to 4 to create a new pattern.

To enable or disable the screen unlock pattern and change related settings

- 1 Touch  →  → **Settings** → **Location & security** → **Change screen lock**, or touch  →  → **Settings** → **Location & security** → **Change screen lock**.
- 2 To enable a setting, touch the setting option to select the check box ; to disable a setting, touch the setting option to clear the check box.





Change screen lock	<ul style="list-style-type: none">• Select None to disable screen unlock security.• Select Pattern to enable screen unlock security by drawing an unlock pattern.• Select PIN to enable screen unlock security by entering a PIN code.• Select Password to enable screen unlock security by entering a password.
Use visible pattern	Clear the Use visible pattern check box if you do not want the lines of the unlock pattern to display on the screen when you draw it.
Use tactile feedback	Clear this option if you do not want the smartphone to give you tactile feedback when drawing the unlock pattern.

Protect Your Smartphone Data With a PIN

- 1 Touch  →  → **Settings** → **Location & security** → **Set up screen lock** → **PIN**, or touch  →  → **Settings** → **Location & security** → **Set up screen lock** → **PIN**.
- 2 In the **Choose your PIN** screen, type a PIN in the text field. Your PIN must have a minimum of 4 characters.
- 3 Touch **Continue** to proceed.
- 4 Enter the PIN code again to confirm.
- 5 Touch **OK**.

To unlock your screen using the PIN, type the PIN and touch **OK**.

Protect Your Smartphone Data With a Password

- 1 Touch  →  → **Settings** → **Location & security** → **Set up screen lock** → **Password**, or touch  →  → **Settings** → **Location & security** → **Set up screen lock** → **Password**.
- 2 In the **Choose your password** screen, type a password in the text field. Your password must have a minimum of 4 characters, and must include a letter.
- 3 Touch **Continue** to proceed.
- 4 Enter the password again to confirm.
- 5 Touch **OK**.

To unlock your screen using the password, type the password and touch **OK**.





Protect Your Micro-SIM Card With the SIM Lock Password

You can protect your micro-SIM card against unauthorized use with a personal identification number (PIN). After a PIN is enabled to lock your SIM, you will need to enter the PIN each time you turn on the smartphone in order to unlock your SIM.





 **NOTE:** The micro-SIM card will be permanently locked if you enter an incorrect PIN in three consecutive attempts. You must then enter the Personal Unblocking Key (PUK) to unlock the micro-SIM card. Contact your service provider to obtain the PUK.

 **NOTE:** You can make emergency calls without unlocking the micro-SIM.

To enable the micro-SIM card PIN



- 1 Touch  →  → **Settings** → **Location & security** → **Set up SIM/RUIM card lock** → **Lock SIM/RUIM Card**, or touch  →  → **Settings** → **Location & security** → **Set up SIM/RUIM card lock** → **Lock SIM/RUIM Card**.
- 2 Type your micro-SIM card PIN using the on-screen keyboard, and then touch **OK**.

To change the micro-SIM card PIN

- 1 Touch  →  → **Settings** → **Location & security** → **Set up SIM/RUIM card lock** → **Change SIM/RUIM PIN**, or touch  →  → **Settings** → **Location & security** → **Set up SIM/RUIM card lock** → **Change SIM/RUIM PIN**.
- 2 Type the old micro-SIM card PIN using the on-screen keyboard, and then touch **OK**.
- 3 Type the new micro-SIM card PIN, and then touch **OK**.
- 4 Type the new micro-SIM card PIN again, and then touch **OK**.

8 Troubleshooting

Problem	Possible causes	Possible solutions
Call-related problems		
SIM card error	SIM card malfunction or damage.	Take the SIM card to your service provider for testing.
	The SIM card may be inserted improperly.	Insert the SIM card properly, see "Getting Your Smartphone Ready for Use" on page 7.
	The SIM card's metal contacts may have dirt or dust.	Use a soft, dry cloth to clean the SIM card's metal contacts.
Poor reception	The network signal may be too weak at your current location. For example, network signals cannot reach effectively near tall buildings or in the basement.	Move to a location where the network signal can be received properly.
	The network may be busy at present. For example, during peak network traffic, the network may not be able to handle additional calls.	Try calling again after waiting for a short duration.
	You may be too far away from a base station for your service provider.	You can request a service area map from your service provider.

Problem	Possible causes	Possible solutions
You cannot make outgoing calls	The SIM card may not be installed.	Install a valid SIM card in your smartphone.
	Poor signal.	Move to an open space, or if you are inside a building, move closer to a window.
	Your smartphone is in Airplane mode with no wireless connectivity.	Press and hold the Power button and then touch the Airplane mode option to disable it.
	You have enabled Fixed Dialing Numbers.	Touch the Home button  → Menu button  → Settings → Call settings → Call Feature Settings → Fixed Dialling Numbers . Disable Fixed Dialing Numbers (FDN) .
You cannot answer incoming calls	Poor signal.	Move to an open space, or if you are inside a building, move closer to a window.
	Your smartphone is in Airplane mode with no wireless connectivity.	Press and hold the Power button and then touch the Airplane mode option to disable it.
Unable to add contacts to the smartphone	Memory for storing contacts is already full.	Delete unnecessary contact information from the smartphone.
Echo or noise	Poor network trunk quality from your service provider, or poor local telephone line quality.	End the call and dial again. You may be switched to a better-quality network trunk or phone line.
Noises during a call	You may be near a strong electromagnetic source such as a TV, microwave oven, and so on during a call.	Move to another location to reduce the interference effects.

Problem	Possible causes	Possible solutions
You cannot enable certain call features	Your service provider does not support these features, or you have not subscribed for services that provide these features.	Contact your service provider.
PIN Code is blocked	You have entered an incorrect PIN code in three consecutive attempts.	Contact your service provider. If the service provider provides the SIM card's PUK code, use the PUK code to unlock the SIM card.
System problems		
Battery does not charge	The battery or battery charger is damaged.	Contact the dealer.
	The smartphone's temperature is below 0°C or higher than 45°C.	Try charging the phone at temperatures ranging between 0°C and 45°C.
	Poor contact between the battery and charger.	Check to see if you have connected the USB cable and charging plug correctly.
Unable to turn the smartphone on.	The battery is fully discharged.	Charge the smartphone.
	The smartphone system is corrupted.	Reset the smartphone or start emergency software recovery. For instructions, see page 191.
	Battery contacts are not clean.	Seek your dealer's help to clean the contacts.

Problem	Possible causes	Possible solutions
Standby time is reduced.	The standby time is affected by your service provider's system configuration.	If you are located in an area where the network signal is weak, temporarily turn off your smartphone.
	The battery is depleted. In high-temperature environments, battery life will be shortened.	Use a new battery.
	If you are not able to connect to the network, the smartphone will continue to send out signals as it attempts to locate a base station. Doing this consumes battery power and consequently shortens standby time.	Move to a location where the network is accessible, or temporarily turn off your smartphone.
Messaging problems		
Unable to send or receive text messages.	Your smartphone is in Airplane mode with no wireless connectivity.	Press and hold the Power button and then touch the Airplane mode option to disable it.
	The signal strength is not strong enough.	Try moving to a different location for better signal reception.

Problem	Possible causes	Possible solutions
Unable to send or receive multimedia messages.	Your smartphone is in Airplane mode with no wireless connectivity.	Press and hold the Power button and then touch the Airplane mode option to disable it.
	No MMS service is available.	Subscribe to the MMS service from your network service provider.
	Your MMS settings are not configured properly.	Check your network connection, and confirm with your network service provider if your MMS settings are configured correctly.
	Not enough space left on your smartphone memory.	Check if there is enough space on your smartphone memory. Delete data that you do not require to free space if necessary.
Unable to send or receive e-mail.	The Internet connection or the e-mail setting is not configured properly.	Check your network connection, and confirm with your e-mail service provider if your e-mail setting has been configured correctly.
Internet problems		
Unable to connect to the network.	Invalid SIM card.	Contact your service provider.
	You are not within the network's service area.	Check the service area with your service provider.
	Poor signal.	Move to an open space or if you are inside a building, move closer to a window.
Media problems		
Windows Media Player on my computer cannot play the sounds of the video captured using the smartphone.	The smartphone records video sounds in amr format. Windows media player does not support the amr format.	Play the video using a video player with the amr decoder, such as QuickTime.

If your smartphone does not turn on due to corrupt system files, you can either reset your smartphone or start emergency software recovery.

Reset your smartphone to the default state



CAUTION: The following steps will restore your smartphone to the default state and erase all data and downloaded applications stored on it. Ensure that you back up all the required data before you reset the smartphone.

- 1 Press and hold the Power button and then touch the **Power off** option→ **OK** on the screen to turn off the smartphone.
- 2 Press and hold the Power button and the volume down button simultaneously until the smartphone displays **Fastboot** on the upper left corner of the screen.
- 3 Release the buttons and wait for the smartphone to restart.

Start emergency software recovery

- 1 Remove the microSD card from the smartphone.
- 2 Connect a microSD card adapter to your computer and insert your smartphone's microSD card in the adapter.
- 3 On your computer, go to **support.dell.com** and follow the instructions to download the software upgrade package to the microSD card.
NOTE: Check if the downloaded file is named as update.pkg. If not, rename the file as update.pkg.
- 4 Disconnect the microSD card adapter from your computer, and insert the microSD card in your smartphone.
- 5 Follow steps 1 to 3 in "Reset your smartphone to the default state" on page 191 to turn on the configuration screen.
- 6 Press the volume buttons to move the highlight bar to the **SW upgrade from update.pkg** option.
- 7 Press the Camera button to confirm and start emergency software recovery.
- 8 Wait for the smartphone to load files and restart.



NOTE: For service and contact information, visit: **www.dell.com** or Dell's other official websites in your country/region.

Starting Your Smartphone in the Safe Mode

If you find your smartphone unusable because of an application you installed, try to start your smartphone in Safe mode. In Safe mode, all 3rd-party applications are disabled and you can remove any problematic applications to continue using your smartphone normally.

To start your smartphone in Safe mode:

- 1 Turn off your smartphone.
- 2 Press and hold the Power button to turn on your smartphone.
- 3 While the operating system is starting up, the white DELL logo appears twice.

When you see the white DELL logo for the second time, touch and hold the Menu button  until "Safe mode" appears at the bottom of the screen.



NOTE: To exit Safe mode, turn off your smartphone and turn it on again.

Index

A

- Airplane Mode, 75
- Alarm Clock, 171
- Amazon Kindle, 134
- Amazon MP3, 138
- Android Market, 120
- Applications
 - Definition, 22
 - Erase data, 69
 - Navigate, 41
 - Recently used, 42
 - Shortcuts, 42

B

- Back cover
 - Remove, 7
- Battery
 - Charge, 8
- Bluetooth, 159
- Button
 - Volume up/down, 14-15

C

- Calculator, 174
- Calendar, 168
- Calling, 43

Camera, 152

Charging, 8

Connection

- Mobile networks, 71
- To a computer, 158
- Wi-Fi, 73

Contacts, 51

- Add, 51
- View, 52

Controls, 11

- Touch screen, 16

D

- Data connection, 71
- Date, 179
- Dell Backup & Restore, 125
- Dell SyncUp, 125
- Disable all connections, 75
- Display settings, 176

E

- E-mail, 83
- Emergency software recovery, 191
- Erase all data, 70

F

Factory reset, 70

FM Radio, 173

G

Gmail, 86

Google

Applications, 85, 133

Google Account

Setup, 86

Google Books, 85

Google Maps, 95

Google Search, 67

Google Talk, 90

H

Home Screen

Customize, 33

K

Keyboard, 61

L

Language, 180

M

Maps, 95

Messaging, 55

microSD

Format, 69

Set as USB drive, 158

Turn off USB storage, 158

Mobile networks, 71

Music, 166

Create a playlist, 168

Playback, 167

N

Napster, 142

O

On-Screen Keyboard, 61

P

Photos & Videos, 162

PIN

Change, 185

Enable, 185

Pop-Up menu, 60

Q

Quickoffice, 147

R

Recorder, 174

Ringtone, 177

S

Safe Mode, 192

Screen

Orientation, 22

Turn off/on, 10

Screen Unlock Pattern, 181

Create, 181

Enable/disable, 182

Search, 67

Settings

Date and time, 179

Display, 176

Language, 180

Sound and ringtone, 177

Shortcuts, 42

Add, 33

Definition, 22

Smartphone

Overview, 11

Protect, 181

Reset, 70

Safe Mode, 192

Settings, 69

Turn off, 10

Turn on, 9

Software

Recovery, 191

Sound, 177

Status bar, 38

Icons, 40

Synchronize Google Data, 123

T

Text Messages

Compose

MMS, 56

SMS, 55

Receive, 58

Time, 179

Time zone, 179

Touch screen, 16

Troubleshooting, 186

TuneIn Radio, 150

Twitter, 151

V

Voice Control, 175

Voice Search, 68

W

Weather

AccuWeather, 133

Web

Bookmarks, 81

Browse, 76

Connection, 71

Widgets

Add, 35
Definition, 22
Google Search, 67

Wi-Fi, 73

Y

YouTube, 117