

User's Guide

Dell B1260dn

BASIC

IMAGINE THE POSSIBILITIES

This guide provides information concerning installation, basic operation and troubleshooting on windows.

ADVANCED

This guide provides information about installation, advanced configuration, operation and troubleshooting on various OS environments.

Some features may not be available depending on models or countries.

BASIC



1. Introduction

Key benefits	4
Features by models	6
Useful to know	7
About this user's guide	8
Safety information	9
Machine overview	14
Control panel overview	16
Turning on the machine	17
Installing the driver locally	18
Reinstalling the driver	20



2. Learning the Basic Usage

Printing a test page	22
Media and tray	23
Basic printing	33



3. Maintenance

Ordering supplies and accessories	38
-----------------------------------	----

Available supplies	39
Storing the toner cartridge	40
Redistributing toner	42
Replacing the toner cartridge	43
Cleaning the machine	44
Tips for moving & storing your machine	47



4. Troubleshooting

Tips for avoiding paper jams	49
Clearing paper jams	50
Understanding the status LED	55



5. Appendix

Specifications	58
Dell technical support policy	65
Contacting Dell	66
Warranty and return policy	67
Copyright	68



1. Introduction

This chapter provides information you need to know before using the machine.

- **Key benefits** 4
- **Features by models** 6
- **Useful to know** 7
- **About this user's guide** 8
- **Safety information** 9
- **Machine overview** 14
- **Control panel overview** 16
- **Turning on the machine** 17
- **Installing the driver locally** 18
- **Reinstalling the driver** 20

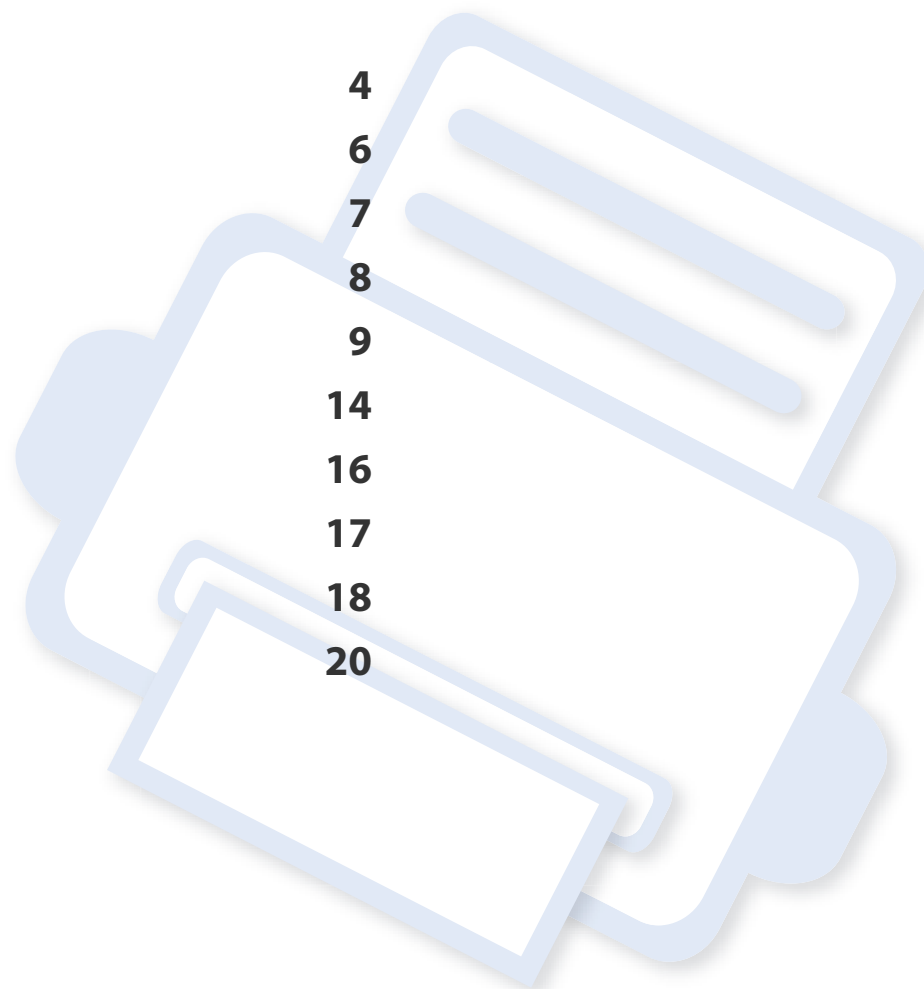

Key benefits

Environmentally friendly



- To save toner and paper, this machine supports the Eco feature.
- To save paper, you can print multiple pages on a single sheet of paper (see "Using advanced print features" on page 109).
- To save paper, you can print on both sides of the paper (double-sided printing) (see "Using advanced print features" on page 109).
- To save electricity, this machine automatically conserves electricity by substantially reducing power consumption when not in use.

Print with excellent quality and speed



- You can print with a resolution of up to 1,200 x 1,200 dpi effective output.
- Fast, on-demand printing.
 - For single-side printing, 28 ppm (A4) or 29 ppm (Letter).
 - For duplex printing, 14 ppm (A4) or 14 ppm (Letter).

Convenience



- You can print on the go from your smartphone or computer using Google Cloud Print™ enabled apps (see "Google Cloud Print™" on page 90).
- Dell Printer Manager and Printer Status Monitor are a program that monitors and informs you of the machine's status and allows you to customize the machine's settings (see "Using Dell Printer Manager" on page 97).
- You can access Dell Support at www.dell.com or support.dell.com. Select your region on the WELCOME TO DELL SUPPORT page, and fill in the requested details to access help tools and information.

Wide range of functionality and application support



- Supports various paper sizes (see "Print media specifications" on page 59).
- Print watermark: You can customize your documents with words, such as "Confidential" (see "Using advanced print features" on page 109).

Key benefits

- Print posters: The text and pictures of each page of your document are magnified and printed across the multiple sheets of paper and can then be taped together to form a poster (see "Using advanced print features" on page 109).
- You can print in various operating systems (see "System requirements" on page 61).
- Your machine is equipped with a USB interface and/or a network interface.

Features by models

Some features and optional goods may not be available depending on model or country.

Operating System

Operating System	B1260dn
Windows	•
Macintosh	•
Linux	•
Unix	•

(●: Included, Blank: Not available)

Software

Software	B1260dn
PCL6 printer driver ^a	•
SPL printer driver ^a	•
XPS printer driver	•
Dell Printer Manager	•
Embedded Web Service	•

a. Depending on the operating system you use, the installed printer driver may differ.

(●: Included, Blank: Not available)

Variety feature

Features	B1260dn
Hi-Speed USB 2.0	•
Network Interface Ethernet 10/100 Base TX wired LAN	•
IPv6	•
Google Cloud Print™	•
Eco printing	•
Double-sided printing	•

(●: Included, Blank: Not available)

Useful to know



Where can I download the machine's driver?

- Visit **www.support.dell.com** to download the latest machine's driver, and install it on your system.



Where can I purchase accessories or supplies?

- Inquire at a Dell distributor or your retailer.
- Visit **www.support.dell.com**. Select your country/region to view product service information.



The status LED flashes or remains constantly on.

- Turn the product off and on again.
- Check the meanings of LED indications in this manual and troubleshoot accordingly (see "Understanding the status LED" on page 55).



A paper jam has occurred.

- Open and close the front door.
- Check the instructions on removing jammed paper in this manual and troubleshoot accordingly (see "Clearing paper jams" on page 50).



Printouts are blurry.

- The toner level might be low or uneven. Shake the toner cartridge.
- Try a different print resolution setting.
- Replace the toner cartridge.



The machine does not print.

- Open the print queue list and remove the document from the list (see "Canceling a print job" on page 33).
- Remove the driver and install it again (see "Installing the driver locally" on page 18).
- Select your machine as your default machine in your Windows.

About this user's guide

This user's guide provides information for your basic understanding of the machine as well as detailed steps to explain machine usage.



- Read the safety information before using the machine.
- If you have a problem using the machine, refer to the troubleshooting chapter.
- Terms used in this user's guide are explained in the glossary chapter.
- All illustrations in this user's guide may differ from your machine depending on its options or model you purchased.
- The screenshots in this user's guide may differ from your machine depending on the machine's firmware/driver version.
- The procedures in this user's guide are mainly based on Windows 7.

Conventions

Some terms in this guide are used interchangeably, as below:

- Document is synonymous with original.
- Paper is synonymous with media, or print media.
- Machine refers to printer or MFP.

General icons



Icon	Text	Description
	Caution	Gives users information to protect the machine from possible mechanical damage or malfunction.
	Note	Provides additional information or detailed specification of the machine function and feature.

Safety information

These warnings and precautions are included to prevent injury to you and others, and to prevent any potential damage to your machine. Be sure to read and understand all of these instructions before using the machine. After reading this section, keep it in a safe place for future reference.

Important safety symbols

Explanation of all icons and signs used in this chapter

	Warning	Hazards or unsafe practices that may result in severe personal injury or death.
	Caution	Hazards or unsafe practices that may result in minor personal injury or property damage.
		Do not attempt.

Operating environment

Warning



Do not use if the power cord is damaged or if the electrical outlet is not grounded.

This could result in electric shock or fire.



Do not place anything on top of the machine (water, small metal or heavy objects, candles, lit cigarettes, etc.).

This could result in electric shock or fire.

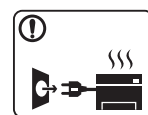

- If the machine gets overheated, it releases smoke, makes strange noises, or generates an odd odor, immediately turn off the power switch and unplug the machine.

- The user should be able to access the power outlet in case of emergencies that might require the user to pull the plug out.

This could result in electric shock or fire.



Do not bend, or place heavy objects on the power cord.

Stepping on or allowing the power cord to be crushed by a heavy object could result in electric shock or fire.







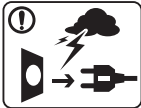

Do not remove the plug by pulling on the cord; do not handle the plug with wet hands.

This could result in electric shock or fire.







Safety information

Caution



	<p>During an electrical storm or for a period of non-operation, remove the power plug from the electrical outlet.</p> <p>This could result in electric shock or fire.</p>
	<p>Be careful, the paper output area is hot.</p> <p>Burns could occur.</p>
	<p>If the machine has been dropped, or if the cabinet appears damaged, unplug the machine from all interface connections and request assistance from qualified service personnel.</p> <p>Otherwise, this could result in electric shock or fire.</p>
	<p>If the machine does not operate properly after these instructions have been followed, unplug the machine from all interface connections and request assistance from qualified service personnel.</p> <p>Otherwise, this could result in electric shock or fire.</p>
	<p>If the plug does not easily enter the electrical outlet, do not attempt to force it in.</p> <p>Call an electrician to change the electrical outlet, or this could result in electric shock.</p>
	<p>Do not allow pets to chew on the AC power, telephone or PC interface cords.</p> <p>This could result in electric shock or fire and/or injury to your pet.</p>

Operating method

Caution

	<p>Do not forcefully pull the paper out during printing.</p> <p>It can cause damage to the machine.</p>
	<p>Be careful not to put your hand between the machine and paper tray.</p> <p>You may get injured.</p>
	<p>Be care when replacing paper or removing jammed paper.</p> <p>New paper has sharp edges and can cause painful cuts.</p>
	<p>When printing large quantities, the bottom part of the paper output area may get hot. Do not allow children to touch.</p> <p>Burns can occur.</p>
	<p>When removing jammed paper, do not use tweezers or sharp metal objects.</p> <p>It can damage the machine.</p>
	<p>Do not allow too many papers to stack up in the paper output tray.</p> <p>It can damage the machine.</p>

Safety information



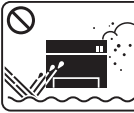

	Do not block or push objects into the ventilation opening. This could result in elevated component temperatures which can cause damage or fire.
	Use of controls or adjustments or performance of procedures other than those specified herein may result in hazardous radiation exposure.
	This machine's power reception device is the power cord. To switch off the power supply, remove the power cord from the electrical outlet.

Installation / Moving





Warning

	Do not place the machine in an area with dust, humidity, or water leaks. This could result in electric shock or fire.
--	--

Caution

	Before moving the machine, turn the power off and disconnect all cords. The information below are only suggestions based on the units weight. If you have a medical condition that prevents you from lifting, do not lift the machine. Ask for help, and always use the appropriate amount of people to lift the device safely. Then lift the machine: <ul style="list-style-type: none">• If the machine weighs under 20 kg (44.09 lbs), lift with 1 person.• If the machine weighs 20 kg (44.09 lbs) - 40kg (88.18 lbs), lift with 2 people.• If the machine weighs more than 40 kg (88.18 lbs), lift with 4 or more people. The machine could fall, causing injury or machine damage.
	Do not place the machine on an unstable surface. The machine could fall, causing injury or machine damage.
	Use only No.26 AWG ^a or larger, telephone line cord, if necessary. Otherwise, it can cause damage to the machine.
	Make sure you plug the power cord into a grounded electrical outlet. Otherwise, this could result in electric shock or fire.









Safety information

	<p>Use the power cord supplied with your machine for safe operation. If you are using a cord which is longer than 2 meters (6 feet) with a 110V machine, then the gauge should be 16 AWG or larger.</p> <p>Otherwise, it can cause damage to the machine, and could result in electric shock or fire.</p>
	<p>Do not put a cover over the machine or place it in an airtight location, such as a closet.</p> <p>If the machine is not well-ventilated, this could result in fire.</p>
	<p>Do not overload wall outlets and extension cords.</p> <p>This can diminish performance, and could result in electric shock or fire.</p>
	<p>The machine should be connected to the power level which is specified on the label.</p> <p>If you are unsure and want to check the power level you are using, contact the electrical utility company.</p>

a. AWG: American Wire Gauge

Maintenance / Checking

Caution

 	<p>Unplug this product from the wall outlet before cleaning the inside of the machine. Do not clean the machine with benzene, paint thinner or alcohol; do not spray water directly into the machine.</p> <p>This could result in electric shock or fire.</p>
 	<p>When you are working inside the machine replacing supplies or cleaning the inside, do not operate the machine.</p> <p>You could get injured.</p>
 	<p>Keep cleaning supplies away from children.</p> <p>Children could get hurt.</p>
 	<p>Do not disassemble, repair or rebuild the machine by yourself.</p> <p>It can damage the machine. Call a certified technician when the machine needs repairing.</p>
	<p>To clean and operate the machine, strictly follow the user's guide provided with the machine.</p> <p>Otherwise, you could damage the machine.</p>

Safety information



Keep the power cable and the contact surface of the plug clean from dust or water.

Otherwise, this could result in electric shock or fire.



- Do not remove any covers or guards that are fastened with screws.
- Fuser units should only be repaired by a certified service technician. Repair by non-certified technicians could result in fire or electric shock.
- The machine should only be repaired by a Dell service technician.



When storing supplies such as toner cartridges, keep them away from children.

Toner dust can be dangerous if inhaled or ingested.



Using recycled supplies, such as toner, can cause damage to the machine.

In case of damage due to the use of recycled supplies, a service fee will be charged.



When toner gets on your clothing, do not use hot water to wash it.

Hot water sets toner into fabric. Use cold water.



When changing the toner cartridge or removing jammed paper, be careful not to let toner dust touch your body or clothes.

Toner dust can be dangerous if inhaled or ingested.

Supply usage



Caution



Do not disassemble the toner cartridge.

Toner dust can be dangerous if inhaled or ingested.



Do not burn any of the supplies such as toner cartridge or fuser unit.

This could cause an explosion or uncontrollable fire.

Machine overview

Accessories



Power cord



Software CD^a

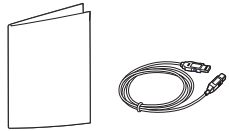

Misc. accessories^b



Quick installation guide

a. The software CD contains the printer drivers, user's guide, and software applications.

b. Miscellaneous accessories included with your machine may vary by country of purchase and specific model.

Machine overview

Front view



- This illustration may differ from your machine depending on its model.
- Some features and optional goods may not be available depending on model or country.

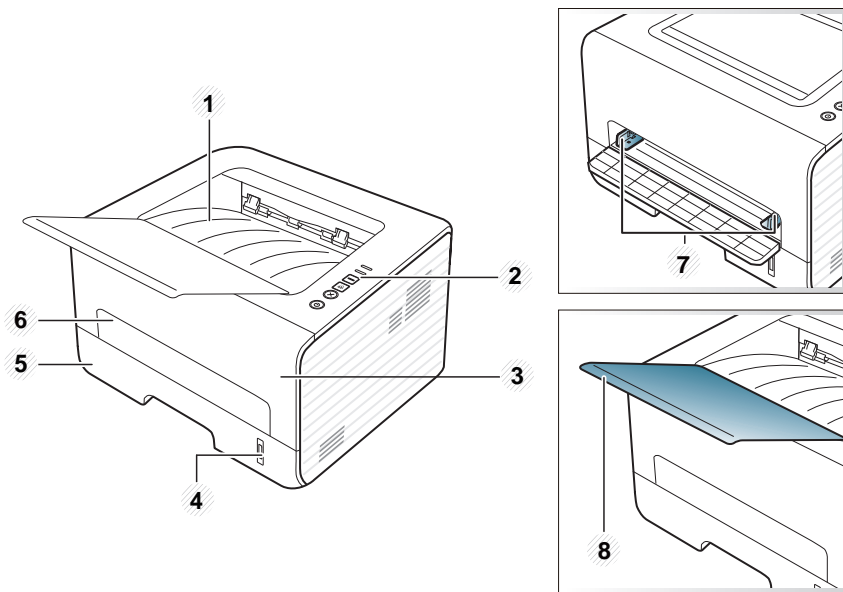

1	Output tray	5	Tray 1
2	Control panel	6	Manual feeder
3	Front cover	7	Paper width guides on a manual feeder
4	Paper level indicator	8	Output support

Rear view



- This illustration may differ from your machine depending on its model.
- Some features and optional goods may not be available depending on model or country.

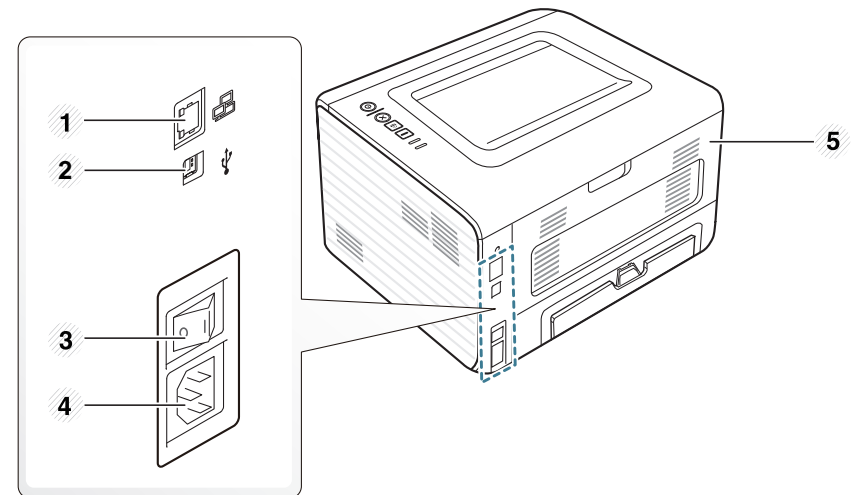



1	Network port	4	Power receptacle
2	USB port	5	Rear cover
3	Power-switch		



Control panel overview

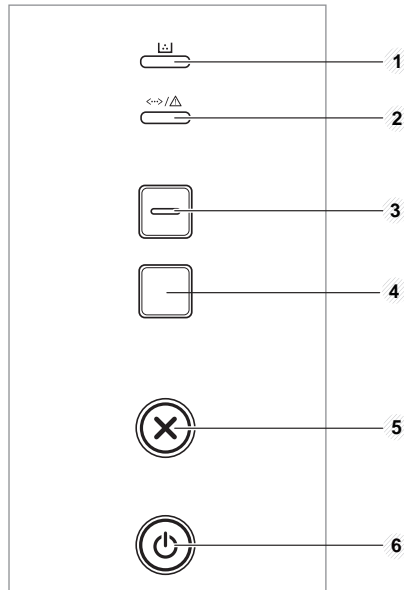

This control panel may differ from your machine depending on its model. There are various types of control panels.



1	Toner LED	Shows the status of the toner (see "Status LED" on page 55).
2	 (Status LED)	Shows the status of your machine (see "Status LED" on page 55).
3	 Eco	Enters eco mode to reduce toner consumption and paper usage (see "Eco options" on page 36).

4	 Info	<p>Prints a information page.</p> <ul style="list-style-type: none"> • Prints configuration reports/ network configuration reports <ul style="list-style-type: none"> - Press and let go. • Prints supplies info report / error report <ul style="list-style-type: none"> - Press and hold this button for about 2 seconds and release. • Prints a test page <ul style="list-style-type: none"> - Press and hold this button for about 4 seconds until the status LED blinks slowly, and release.
5	 (Cancel)	Cancels the current job.
6	 (Power)	You can turn the power on/off or wake the machine up from the power save mode with this button.

Turning on the machine

- 1 Connect the machine to the electricity supply first.

Press the power key or turn the switch on if the machine has a power switch.

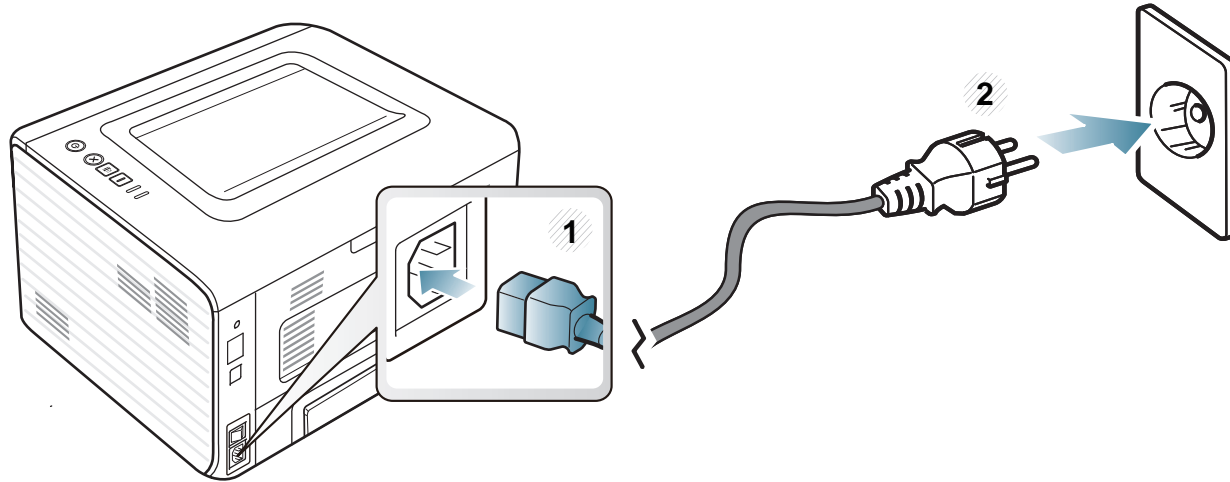

Installing the driver locally

A locally connected machine is a machine directly attached to your computer using the cable. If your machine is attached to a network, skip the following steps below and go on to installing a network connected machine's driver (see "Installing driver over the network" on page 81).



- If you are a Macintosh, Linux, or Unix OS user, refer to the "Software installation" on page 71.
- The installation window in this User's Guide may differ depending on the machine and interface in use.
- Selecting **Custom Installation** allows you to choose which programs to install.
- Only use a USB cable no longer than 3 meters (118 inches).

Windows

- 1 Make sure that the machine is connected to your computer and powered on.



If the "**Found New Hardware Wizard**" appears during the installation procedure, click **Cancel** to close the window.

- 2 Insert the supplied software CD into your CD-ROM drive.

The software CD should automatically run and an installation window will appear.

If the installation window does not appear, click **Start > All programs > Accessories > Run**.

X:\Setup.exe replacing "X" with the letter, which represents your CD-ROM drive and click **OK**.

- 3 Select **Next**.

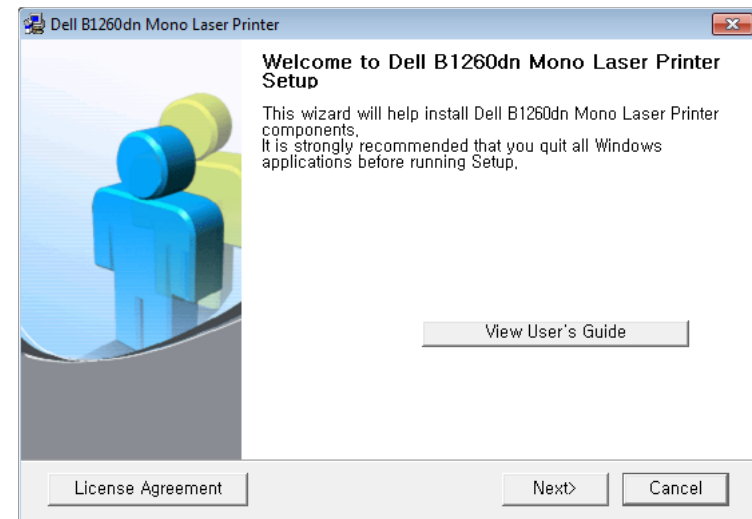

Installing the driver locally

- 4 Select **Connect to the computer using USB Cable**. Click **Next**.

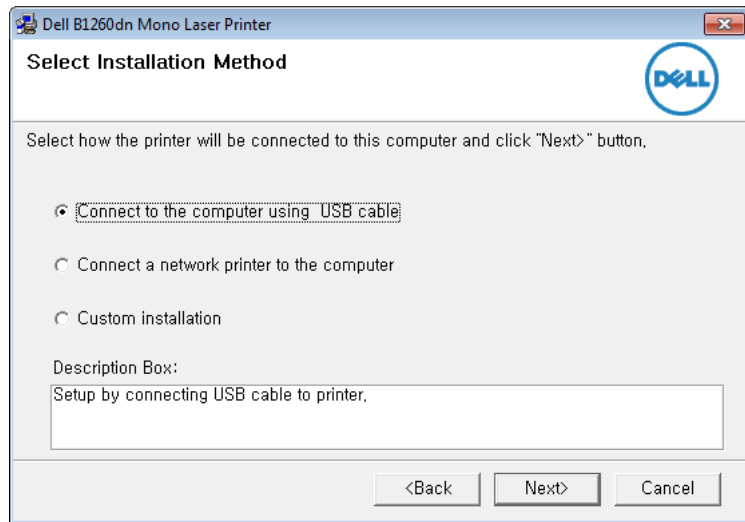

- 5 Follow the instructions in the installation window.

Reinstalling the driver

If the printer driver does not work properly, follow the steps below to reinstall the driver.

Windows

- 1 Make sure that the machine is connected to your computer and powered on.
- 2 From the **Start** menu, select **Programs** or **All Programs** > **Dell** > **Dell Printers** > **your printer driver name** > **Maintenance**.
- 3 Select **Repair** and click **Next**.
- 4 Follow the instructions in the installation window.
- 5 Insert the software CD into your CD-ROM drive and install the driver again (see "Installing the driver locally" on page 18).



2. Learning the Basic Usage

After installation is complete, you may want to set the machine's default settings. Refer to the next section if you would like to set or change values. This chapter provides information about the overall menu structure and the basic setup options.

- **Printing a test page** 22
- **Media and tray** 23
- **Basic printing** 33



Printing a test page

Print a test page to make sure that the machine is operating correctly.

To print a test page:

In ready mode, press and hold  (**Info**) button for about 4 seconds until the status LED blinks, and release.

Media and tray

This chapter provides information on how to load print media into your machine.



- Using print media that does not meet these specifications may cause problems or require repairs. Such repairs are not covered by Dell's warranty or service agreements.
- Make sure not to use the inkjet photo paper with this machine. It could cause damage to the machine.
- Using inflammable print media can cause a fire.
- Use designated print media (see "Print media specifications" on page 59).



The use of inflammable media or foreign materials left in the printer may lead to overheating of the unit and, in rare cases may cause a fire.

Tray overview

To change the size, you need to adjust the paper guides.

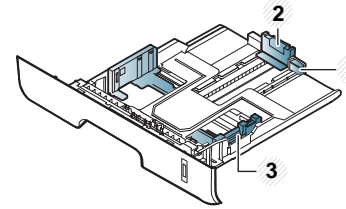

- 1 Tray extension guide
- 2 Paper length guide
- 3 Paper width guide



If you do not adjust the guide, it may cause paper registration, image skew, or jamming of the paper.



Paper quantity indicator shows the amount of paper in the tray.

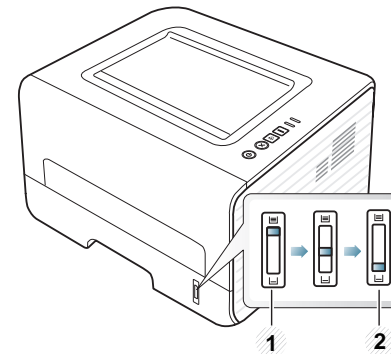

- 1 Full
- 2 Empty

Media and tray

Paper type available for duplex printing

Depending on the power voltage your machine uses, available paper types for duplex printing differs. Refer to the below table.

Power voltage	Available paper
110V	Letter, Legal, US Folio, Oficio
220V	A4

Media and tray

Loading paper in the tray



When printing using the tray, do not load paper on the manual feeder, it may cause a paper jam.

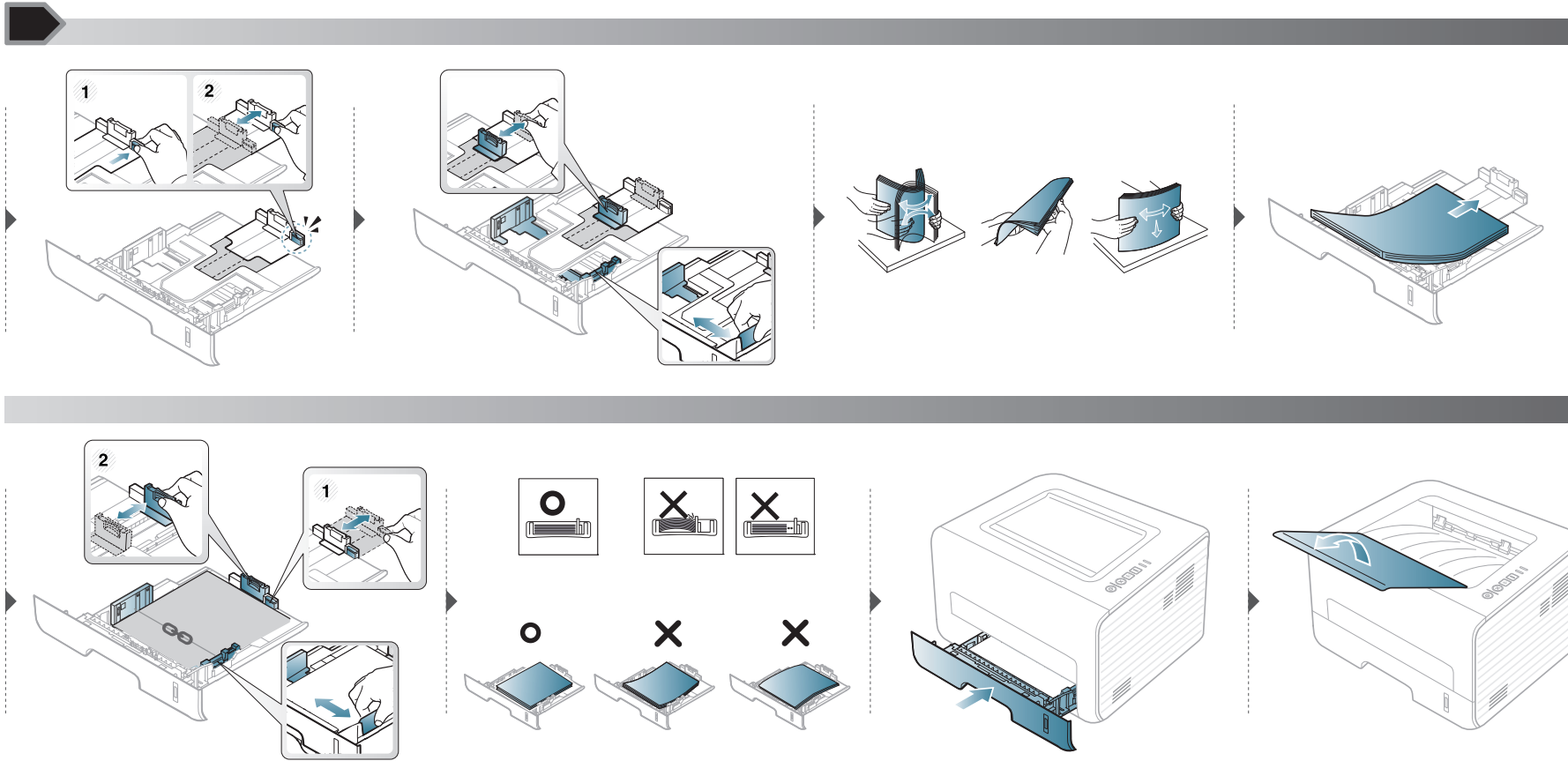

Media and tray

Loading in manual feeder

The manual feeder can hold special sizes and types of print material, such as postcards, note cards, and envelopes.



Tips on using the manual feeder

- Load only one type, size and weight of print media at time in the manual feeder.
- If you select **Manual Feeder** for the paper source in your software application, you need to press  (**Info**) button each time you print a page and load only one type, size and weight of print media at a time on the manual tray.
- To prevent paper jams, do not add paper while printing when there is still paper in the manual feeder.
- Print media should be loaded face up with the top edge going into the manual feeder first and be placed in the center of the tray.
- To ensure printing quality and to prevent paper jams, only load the available paper (see "Print media specifications" on page 59).
- Flatten any curl on postcards, envelopes, and labels before loading them into the manual feeder.
- When printing on special media, you must follow the loading guidelines (see "Printing on special media" on page 28).
- When papers overlap when printing using the manual feeder, open tray 1 and remove the overlapping papers then try printing again.
- When paper does not feed well while printing, push the paper in manually until it starts feeding automatically.
- When the machine is in a power save mode, the machine does not feed paper from the manual feeder. Wake up the machine by pressing the power button before using the manual feeder.

Media and tray

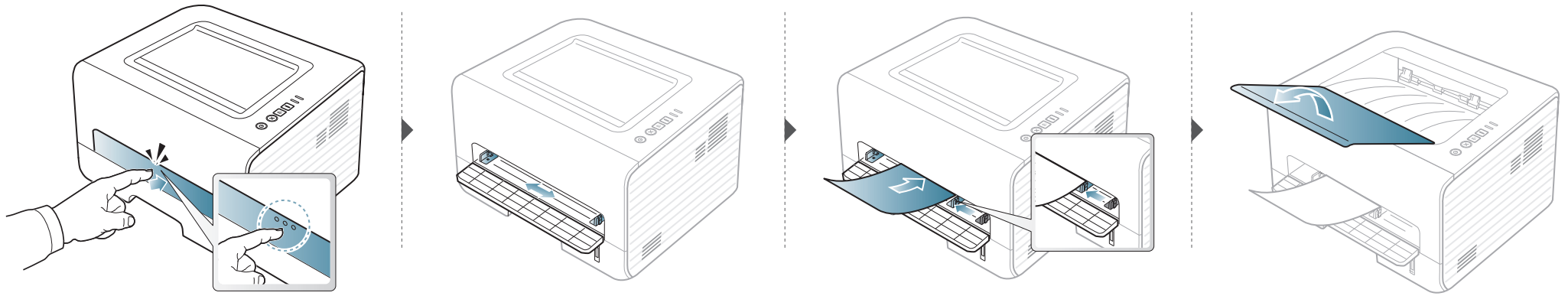

Media and tray

Printing on special media

The table below shows the special media usable in each tray.

The media types are shown in the **Printing Preferences**. To get the highest printing quality, select the proper media type from the **Printing Preferences** window > **Paper** tab > **Paper Type** (see "Opening printing preferences" on page 34).

For example, if you want to print on labels, select **Labels** for **Paper Type**.



- When using special media, we recommend you feed one sheet at a time (see "Print media specifications" on page 59).
- **Printing the special media (Face up)**
If special media are printed out with curl, wrinkles, crease, or black bold lines, open the rear cover and try printing again. Keep the rear cover opened during printing.

To see for paper weights for each sheet, refer to "Print media specifications" on page 59.

Types	Tray	Manual feeder
Plain	•	•
Thick	•	•
Thicker		•

Types	Tray	Manual feeder
Thin	•	•
Bond	•	•
Color		•
CardStock	•	•
Labels		•
Transparency		•
Envelope		•
Thick Envelope		•
Preprinted		•
Cotton		•
Recycled	•	•
Archive	•	•

(•: Supported)

Envelope

Printing successfully on envelopes depends upon the quality of the envelopes.

Media and tray

To print an envelope, place it as shown in the following figure.

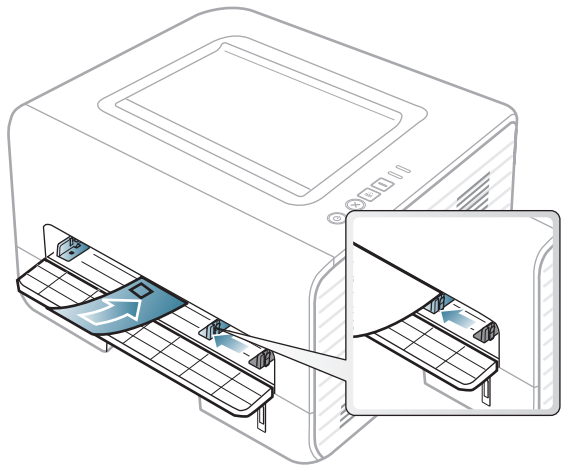

If envelopes are printed out with wrinkles, crease, or black bold lines, open the rear cover and try printing again. Keep the rear cover opened during printing.

If you select **Envelope** from the **Printing Preferences** window, but the printed images get easily erased, select **Thick Envelope** and try printing again.

However, this might cause some noise when printing.

- When selecting envelopes, consider the following factors:
 - **Weight:** should not exceed 90 g/m² otherwise; jams may occur.
 - **Construction:** should lie flat with less than 6 mm curl and should not contain air.
 - **Condition:** should not be wrinkled, nicked, nor damaged.
 - **Temperature:** should resist the heat and pressure of the machine during operation.
- Use only well-constructed envelopes with sharp and well-creased folds.

- Do not use stamped envelopes.
- Do not use envelopes with clasps, snaps, windows, coated lining, self-adhesive seals, or other synthetic materials.
- Do not use damaged or poorly made envelopes.
- Be sure the seam at both ends of the envelope extends all the way to the corner of the envelope.

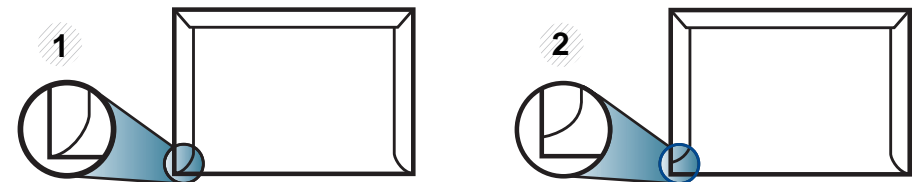

- 1 Acceptable
- 2 Unacceptable

- Envelopes with a peel-off adhesive strip or with more than one flap that folds over to seal must use adhesives compatible with the machine's fusing temperature for 0.1 second (about 170°C (338 °F)). The extra flaps and strips might cause wrinkling, creasing, or jams, and may even damage the fuser.
- For the best print quality, position margins no closer than 15 mm from the edges of the envelope.
- Avoid printing over the area where the envelope's seams meet.

Media and tray

Transparency

To avoid damaging the machine, use only transparencies designed for use in laser printers.

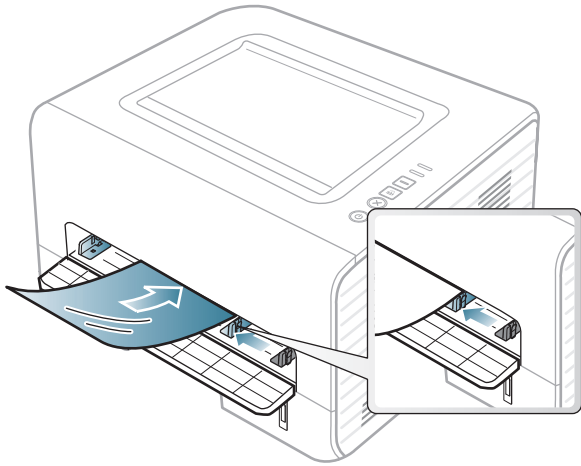

- Must withstand the machine's fusing temperature.
- Place them on a flat surface after removing them from the machine.
- Do not leave unused transparencies in the paper tray for long. Dust and dirt may accumulate on them, resulting in spotty printing.
- To avoid smudging caused by fingerprints, handle them carefully.
- To avoid fading, do not expose printed transparencies to prolonged sunlight.
- Ensure that transparencies are not wrinkled, curled, or have any torn edges.
- Do not use transparencies that separate from the backing sheet.

- To prevent transparencies from sticking to each other, do not let the printed sheets stack up as they are being printed out.
- Recommended media: Transparency for a color laser printer by Xerox, such as 3R 91331(A4), 3R 2780 (Letter)

Labels

To avoid damaging the machine, use only labels designed for use in laser printers.

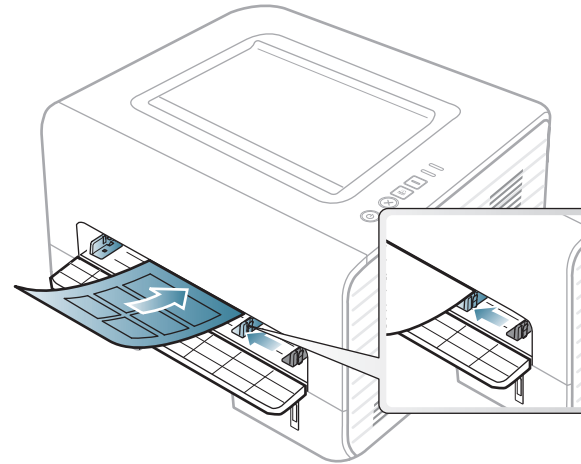

- When selecting labels, consider the following factors:
 - **Adhesives:** Should be stable at your machine's fusing temperature. Check your machine's specifications to view the fusing temperature (about 170°C (338°F)).
 - **Arrangement:** Only use labels with no exposed backing between them. Labels can peel off sheets that have spaces between the labels, causing serious jams.

Media and tray

- **Curl:** Must lie flat with no more than 13 mm of curl in any direction.
- **Condition:** Do not use labels with wrinkles, bubbles, or other indications of separation.
- Make sure that there is no exposed adhesive material between labels. Exposed areas can cause labels to peel off during printing, which can cause paper jams. Exposed adhesive can also cause damage to machine components.
- Do not run a sheet of labels through the machine more than once. The adhesive backing is designed for only a single pass through the machine.
- Do not use labels that are separating from the backing sheet or are wrinkled, bubbled, or otherwise damaged.

Card stock/ Custom-sized paper

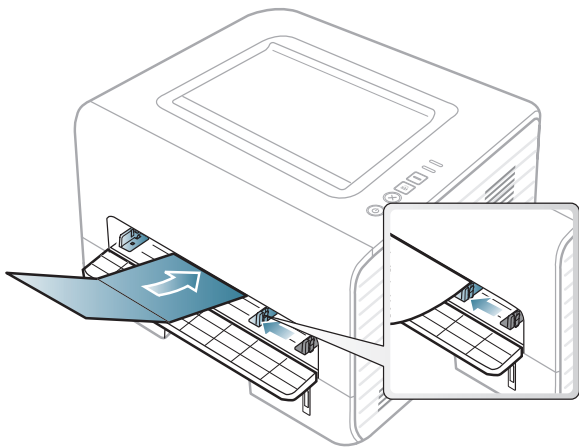

- In the software application, set margins at least 6.4 mm (0.25 inches) away from the edges of the material.

Preprinted paper

When loading preprinted paper, the printed side should be facing up with an uncurled edge at the front. If you experience problems with paper feeding, turn the paper around. Note that print quality is not guaranteed.

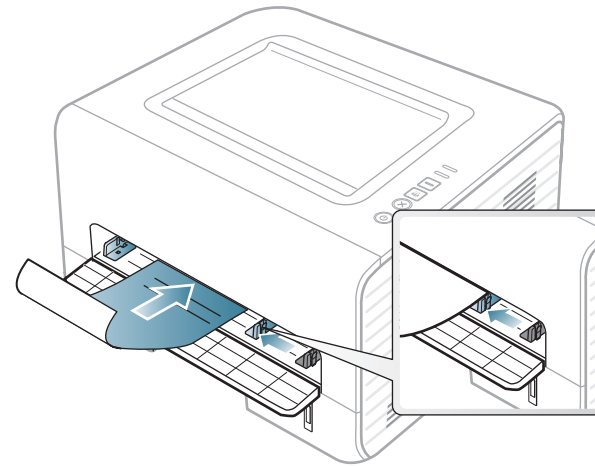

- Must be printed with heat-resistant ink that will not melt, vaporize, or release hazardous emissions when subjected to the machine's fusing temperature for 0.1 second (about 170°C (338°F)).
- Preprinted paper ink must be non-flammable and should not adversely affect machine rollers.
- Before you load preprinted paper, verify that the ink on the paper is dry. During the fusing process, wet ink can come off preprinted paper, reducing print quality.

Media and tray

Setting the paper size and type

After loading paper in the paper tray, set the paper size and type.

Open the **Printing Preferences** (see "Opening printing preferences" on page 34) and set the paper size and type in the **Paper** tab.



If you want to use special-sized paper such as billing paper, select **Custom** in the **Paper** tab in the **Printing Preferences** (see "Opening printing preferences" on page 34).

Using the output support



The surface of the output tray may become hot if you print a large number of pages at once. Make sure that you do not allow children near it.

Open the output support before printing. The printed pages stack on the output support, and the output support will help the printed pages to align. The printer sends printouts to the output tray by default.

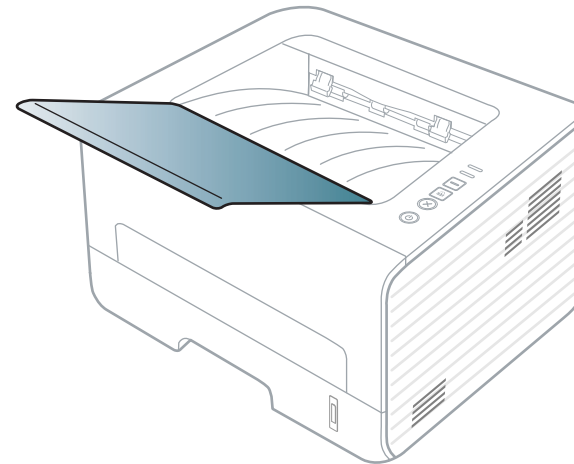

Basic printing

Printing



If you are a Macintosh, Linux, or Unix OS user, refer to the "Macintosh printing" on page 115 or "Linux printing" on page 117 or "Unix printing" on page 119.

The following **Printing Preferences** window is for Notepad in Windows 7.

- 1 Open the document you want to print.
- 2 Select **Print** from the **File** menu.
- 3 Select your machine from the **Select Printer** list.

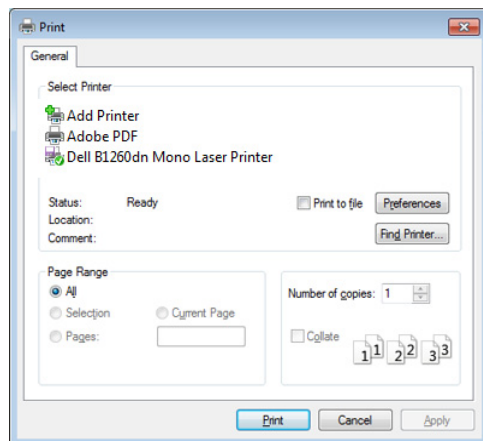

- 4 The basic print settings including the number of copies and print range are selected within the **Print** window.





To take advantage of the advanced printing features, click **Properties** or **Preferences** from the **Print** window (see "Opening printing preferences" on page 34).

- 5 To start the print job, click **OK** or **Print** in the **Print** window.

Canceling a print job





If the print job is waiting in the print queue or print spooler, cancel the job as follows:

- You can access this window by simply double-clicking the machine icon () in the Windows task bar.
- You can also cancel the current job by pressing  (**Cancel**) on the control panel.

Basic printing

Opening printing preferences



- The **Printing Preferences** window that appears in this user's guide may differ depending on the machine in use. However, the composition of the **Printing Preferences** window is similar.
- When you select an option in **Printing Preferences**, you may see a warning mark  or . An  mark means you can select that certain option but it is not recommended, and an  mark means you cannot select that option due to the machine's setting or environment.

- 1 Open the document you want to print.
- 2 Select **Print** from the file menu.
- 3 Select your machine from the **Select Printer**.

4 Click **Properties** or **Preferences**.

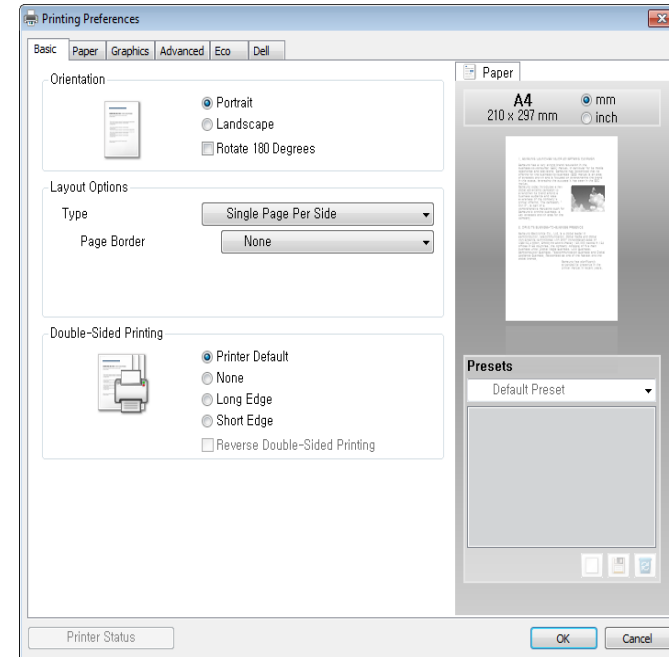

You can check the machine's current status using the **Printer Status** button (see "Using Dell Printer Status" on page 99).

Using a favorite setting

The **Favorites** option, which is visible on each preferences tab except for the **Dell** tab, allows you to save the current preferences for future use.

To save a **Favorites** item, follow these steps:

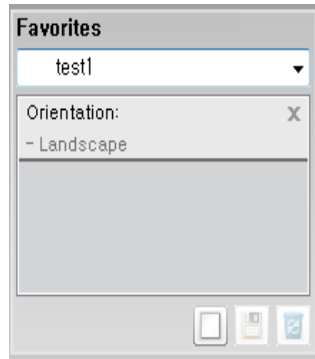

Basic printing

- 1 Change the settings as needed on each tab.
- 2 Enter a name for the item in the **Favorites** input box.



- 3 Click (**Add**). When you save **Favorites**, all current driver settings are saved.



Select more options and click  (**Update**), settings will be added to the Presets you made. To use a saved setting, select it from the **Favorites** drop-down list. The machine is now set to print according to the settings you have selected. To delete saved settings, select it from the **Favorites** drop-down list and click  (**Delete**).

You can also restore the printer driver's default settings by selecting **Default Favorites** from the **Favorites** drop-down list.

Using help

Click the option you want to know on the **Printing Preferences** window and press **F1** on your keyboard.

Eco printing

The **Eco** function cuts toner consumption and paper usage. The **Eco** function allows you to save print resources and lead you to eco-friendly printing.

If you press the **Eco** button from the control panel, eco mode is enabled. The default setting of Eco mode is **Double-sided printing (Long Edge)**, **Multiple Pages per Side (2)**, **Skip blank pages**, and **Toner Save**.



Depending on the printer driver you use, **Skip blank pages** may not work properly.

Basic printing

Setting eco mode on the control panel



- The settings set from the machine's driver override the settings on the control panel.
- If you set the eco mode on with a password from the Embedded Web Service (**Settings** tab > **Machine Settings** > **System** > **Eco** > **Settings**), the **Onforce** message appears. You have to enter the password to change the eco mode status.

- 1 Press  (**Eco**) button on the control panel.
When the LED on the button lights up, the Eco mode is enabled.

Setting eco mode on the driver

Open the Eco tab to set eco mode. When you see the eco image (), that means the eco mode is currently enabled.

Eco options

- **Printer Default:** Follows the settings set from the machine's control panel.
- **None:** Disables eco mode.
- **Eco Printing:** Enables eco mode. Activate the various eco items you want to use.

Result simulator

Result Simulator shows the results of reduced emission of carbon dioxide, used electricity, and the amount of saved paper in accordance with the settings you selected.

- The results are calculated on the basis that the total number of printed paper is one hundred without a blank page when the eco mode is disabled.
- Refer to the calculation coefficient about CO₂, energy, and paper from **IEA**, the index of Ministry of Internal Affairs and Communication of Japan and www.remanufacturing.org.uk. Each model has a different index.
- The power consumption in printing mode refers to the average printing power consumption of this machine.
- The actual saved or reduced amount may differ depending on the operating system used, computing performance, application software, connection method, media type, media size, job complexity, etc.



3. Maintenance

This chapter provides information about purchasing supplies, accessories and maintenance parts available for your machine.

- **Ordering supplies and accessories** 38
- **Available supplies** 39
- **Storing the toner cartridge** 40
- **Redistributing toner** 42
- **Replacing the toner cartridge** 43
- **Cleaning the machine** 44
- **Tips for moving & storing your machine** 47

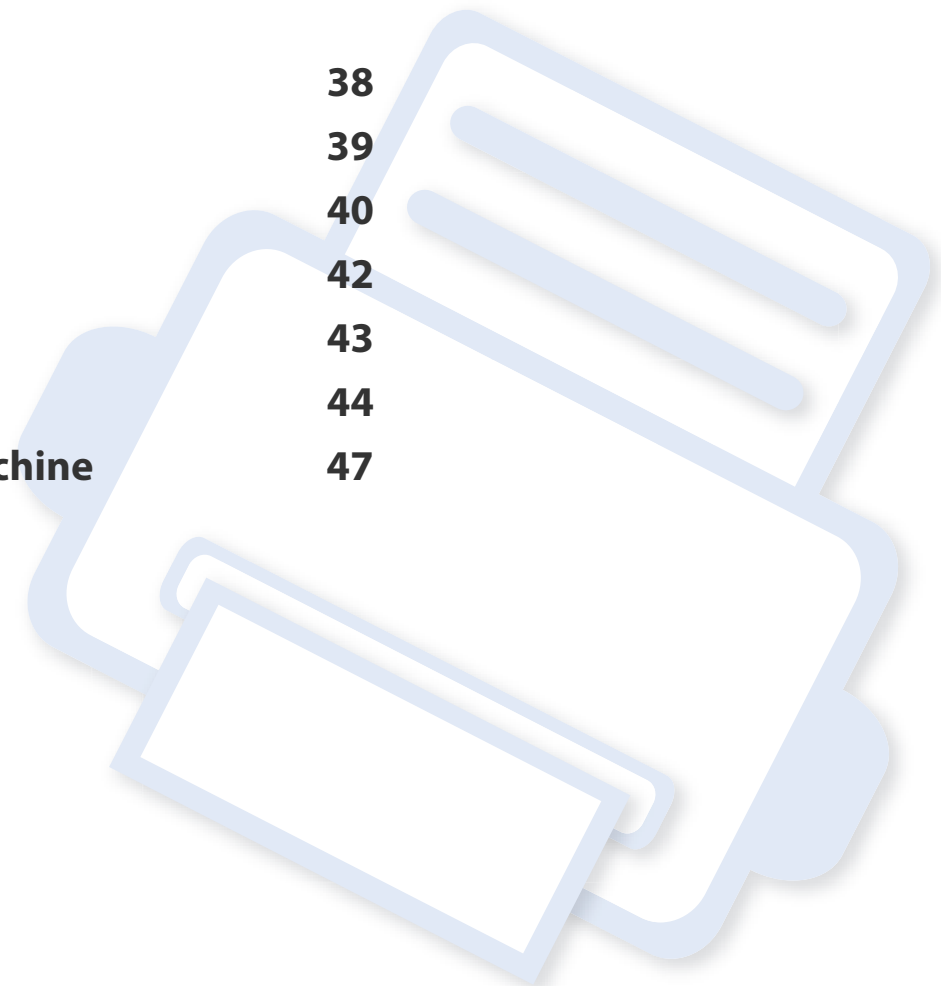

Ordering supplies and accessories



Available accessories may differ from country to country. Contact your sales representatives to obtain the list of available supplies, and maintenance parts.

To order Dell-authorized supplies and accessories visit www.dell.com/supplies, or contact your local Dell dealer or the retailer where you purchased your machine. You can also visit www.dell.com or support.dell.com, select your country/region, and obtain information on calling for service.

Available supplies

When supplies reach the end of their life spans, you can order the following types of supplies for your machine:

Type	Average yield ^a	Part name
Standard yield toner cartridge	Approx. 1,500 pages	<ul style="list-style-type: none">• G9W85 (All countries except China)
High yield toner cartridge	Approx. 2,500 pages	<ul style="list-style-type: none">• DRYXV (All countries except China)• 10G0D (For China only)

a. Declared yield value in accordance with ISO/IEC 19752.



Depending on the options, percentage of image area, and job mode used, the toner cartridge's lifespan may differ.



When purchasing new toner cartridges or other supplies, these must be purchased in the same country as the machine you are using. Otherwise, new toner cartridges or other supplies will be incompatible with your machine due to different configurations of toner cartridges and other supplies according to the specific country conditions.



Dell does not recommend using non-genuine Dell toner cartridge such as refilled or remanufactured toner. Dell cannot guarantee non-genuine Dell toner cartridge's quality. Service or repair required as a result of using non-genuine Dell toner cartridges will not be covered under the machine's warranty.

Storing the toner cartridge

Toner cartridges contain components that are sensitive to light, temperature and humidity. Dell suggests users follow these recommendations to ensure optimal performance, highest quality, and longest life from your new Dell toner cartridge.

Store this cartridge in the same environment in which the printer will be used. This should be in controlled temperature and humidity conditions. The toner cartridge should remain in its original and unopened package until installation – if original packaging is not available, cover the top opening of the cartridge with paper and store in a dark cabinet.

Opening the cartridge package prior to use dramatically shortens its useful shelf and operating life. Do not store on the floor. If the toner cartridge is removed from the printer, follow the instructions below to store the toner cartridge properly.

- Store the cartridge inside the protective bag from the original package.
- Store lying flat (not standing on end) with the same side facing up as if it were installed in the machine.
- Do not store consumables in any of the following conditions:
 - Temperature greater than 40°C (104°F).
 - Humidity range less than 20% and greater than 80%.
 - An environment with extreme changes in humidity or temperature.
 - Direct sunlight or room light.
 - Dusty places.
 - A car for a long period of time.
 - An environment where corrosive gases are present.

- An environment with salty air.

Handling instructions

- Do not touch the surface of the photoconductive drum in the cartridge.
- Do not expose the cartridge to unnecessary vibrations or shock.
- Never manually rotate the drum, especially in the reverse direction; this can cause internal damage and toner spillage.

Toner cartridge usage

Dell Inc. does not recommend or approve the use of non-Dell brand toner cartridges in your printer including generic, store brand, refilled, or remanufactured toner cartridges.



Dell's printer warranty does not cover damage to the machine caused by the use of a refilled, remanufactured, or non-Dell brand toner cartridges.

Storing the toner cartridge

Estimated cartridge life

Estimated cartridge life the life of the toner cartridge (or imaging unit) yield depends on the amount of toner that print jobs require. The actual print yield may vary depending on the print density of the pages you print on, operating environment, percentage of image area, printing interval, media type and/or media size. For example, if you print a lot of graphics, the consumption of the toner is higher and you may need to change the cartridge more often.

Redistributing toner

When the toner cartridge is near the end of its life:

- White streaks or light printing occurs and/or density variation side to side.
- The **Toner** LED blinks yellow.

If this happens, you can temporarily improve print quality by redistributing the remaining toner in the cartridge. In some cases, white streaks or light printing will still occur even after you have redistributed the toner.



- Before opening the front cover, close the output support first.
- If toner gets on your clothing, wipe it off with a dry cloth and wash clothing in cold water. Hot water sets toner into fabric.

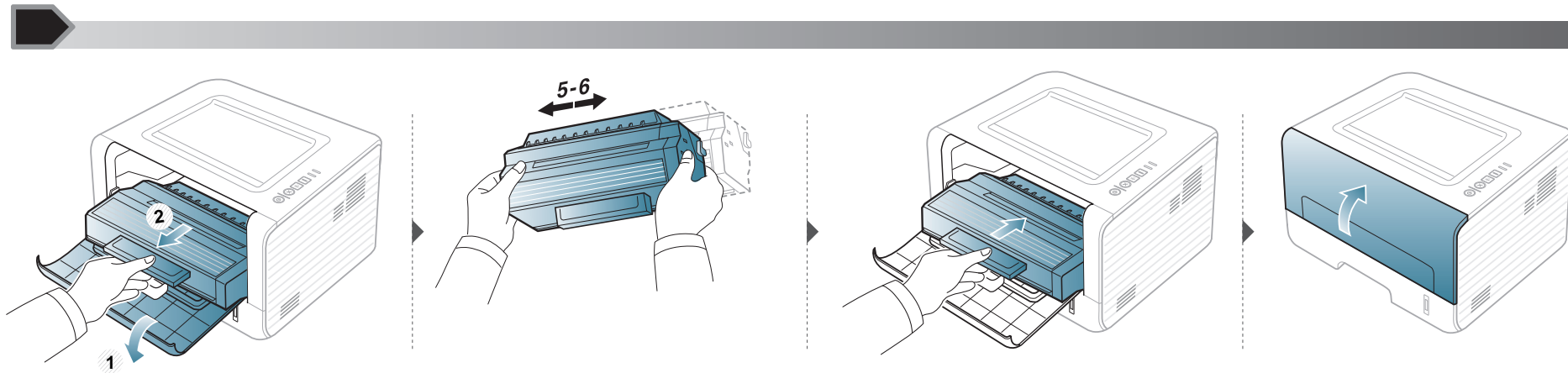

Replacing the toner cartridge



- Before opening the front cover, close the output support first.
- Do not use sharp objects such as a knife or scissors to open the toner cartridge package. They might scratch the drum of the cartridge.
- If toner gets on your clothing, wipe it off with a dry cloth and wash clothing in cold water. Hot water sets toner into fabric.
- Shake the toner cartridge thoroughly, it will increase the initial print quality.
- Do not touch the green underside of the toner cartridge. Use the handle on the cartridge to avoid touching this area.

When a toner cartridge has reached the end of life, the machine will stop printing.

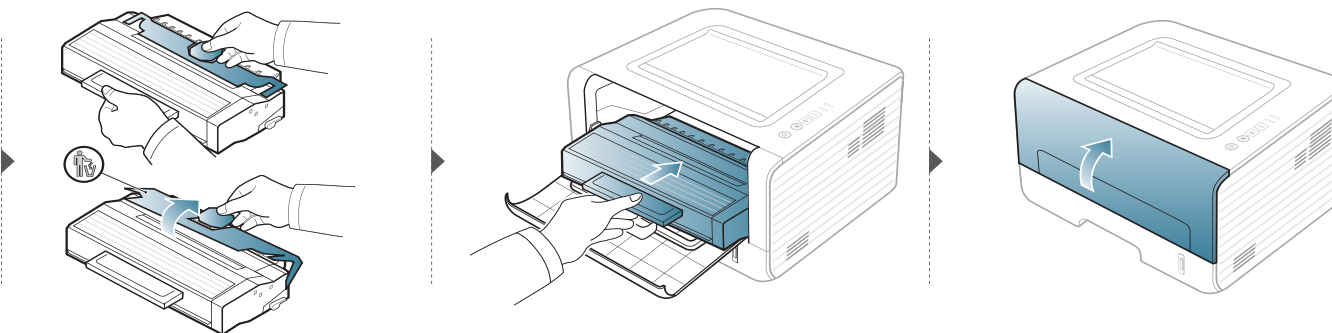
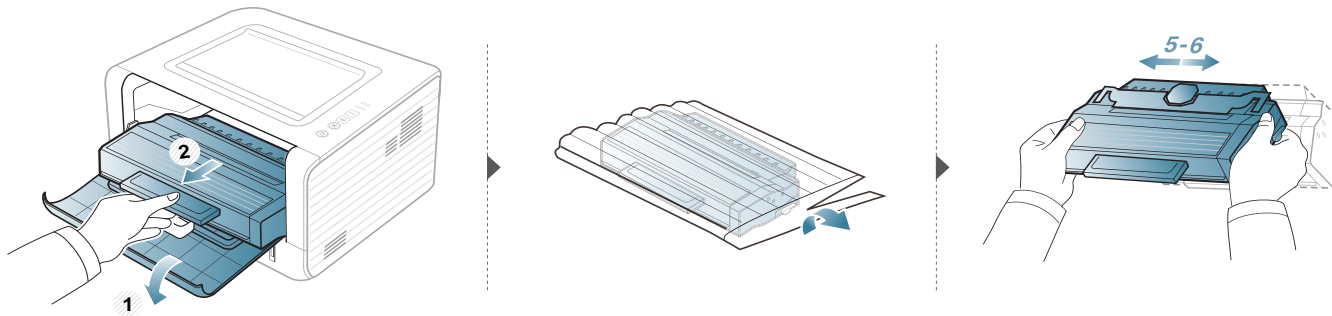

Cleaning the machine

If printing quality problems occur or if you use your machine in a dusty environment, you need to clean your machine regularly to keep it in the best printing condition and use your machine longer.



- Cleaning the cabinet of the machine with cleaning materials containing large amounts of alcohol, solvents, or other strong substances can discolor or distort the cabinet.
- If your machine or the surrounding area is contaminated with toner, we recommend you use a cloth or tissue dampened with water to clean it. If you use a vacuum cleaner, toner blows in the air and might be harmful to you.
- During the printing process, paper, toner, and dust particles can accumulate inside the machine. This buildup can cause print quality problems, such as toner specks or smearing. Cleaning the inside of the machine clears and reduces these problems.

Cleaning the outside

Clean the machine cabinet with a soft, lint-free cloth. Dampen the cloth slightly with water, but be careful not to let any water drip onto or into the machine.

Cleaning the inside

During the printing process, paper, toner, and dust particles can accumulate inside the machine. This buildup can cause print quality problems, such as toner specks or smearing. Cleaning the inside of the machine clears and reduces these problems.



- Use a dry lint-free cloth to clean the machine.
- If your machine has a power switch, turn the power switch off before cleaning the machine.
- Before opening the front cover, close the output support first.

Cleaning the machine



Use a dry lint free cloth when cleaning the inside of the machine, be careful not to damage the transfer roller or any other inside parts. Do not use solvents such as benzene or thinner. Printing quality problems can occur and cause damage to the machine.

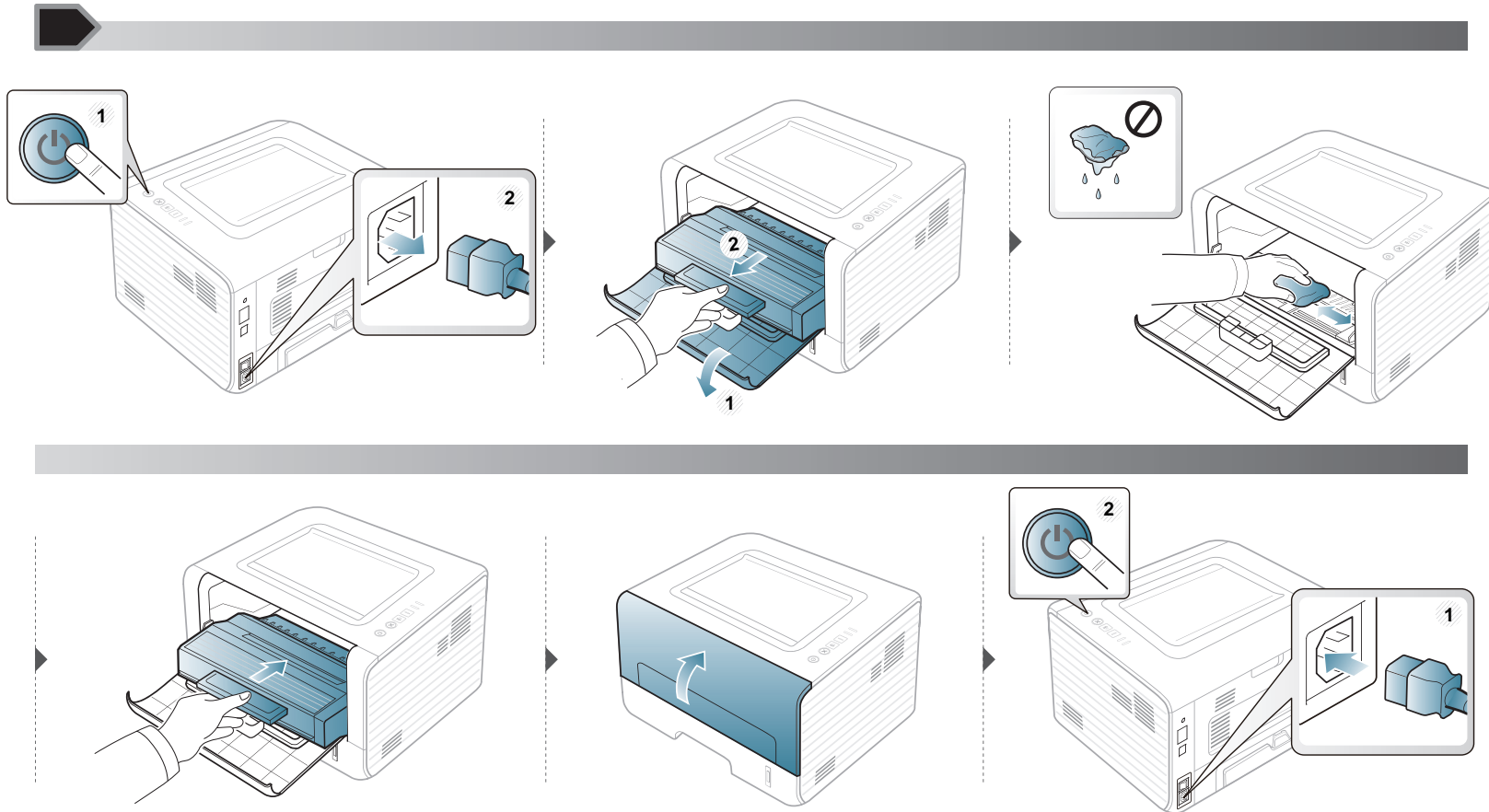

Cleaning the machine

Cleaning the pickup roller



- Use a dry lint-free cloth to clean the machine.
- If your machine has a power switch, turn the power switch off before cleaning the machine.

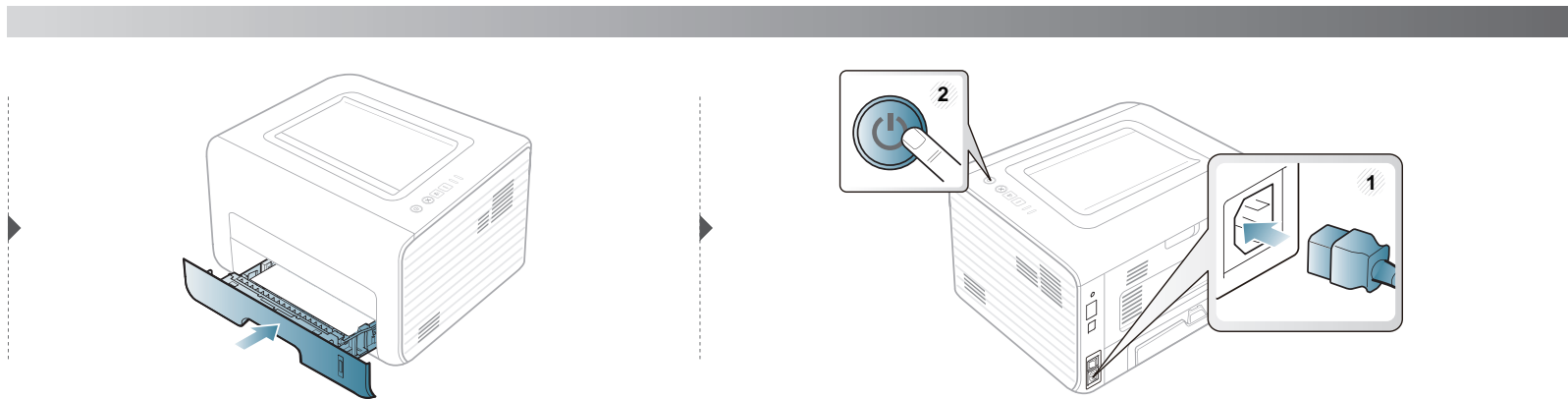
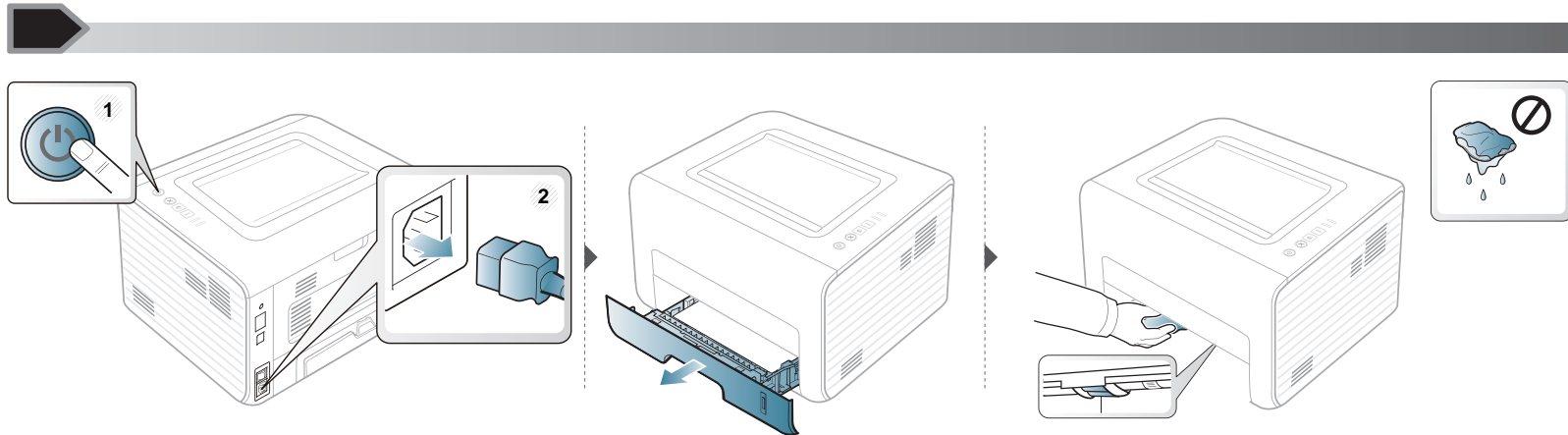

Tips for moving & storing your machine

- When moving the machine, do not tilt or turn it upside down. Otherwise, the inside of the machine may be contaminated by toner, which can cause damage to the machine or reduce print quality.
- When moving the machine, make sure at least two people are holding the machine securely.



4. Troubleshooting

This chapter gives helpful information for what to do if you encounter an error.

- **Tips for avoiding paper jams** 49
- **Clearing paper jams** 50
- **Understanding the status LED** 55



This chapter gives helpful information for what to do if you encounter an error.

If your machine has a display screen, check the message on the display screen first to solve the error. If you cannot find a solution to your problem in this chapter, refer to the **Troubleshooting** chapter in the Advanced User's Guide (see "Troubleshooting" on page 121). If you cannot find a solution in the User's Guide or the problem persists, call for service.

Tips for avoiding paper jams

By selecting the correct media types, most paper jams can be avoided. To avoid paper jams, refer to the following guidelines:

- Ensure that the adjustable guides are positioned correctly (see "Tray overview" on page 23).
- Do not overload the tray. Ensure that the paper level is below the paper capacity mark on the inside of the tray.
- Do not remove paper from the tray while your machine is printing.
- Flex, fan, and straighten paper before loading.
- Do not use creased, damp, or highly curled paper.
- Do not mix paper types in a tray.
- Use only recommended print media (see "Print media specifications" on page 59).

Clearing paper jams



To avoid tearing the paper, pull the jammed paper out slowly and gently.

In tray 1

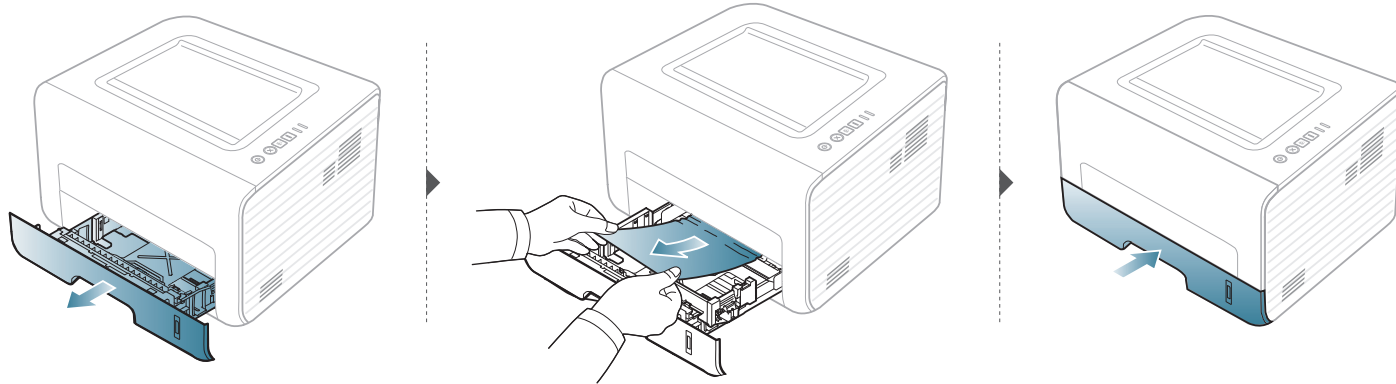

Clearing paper jams

In the manual feeder

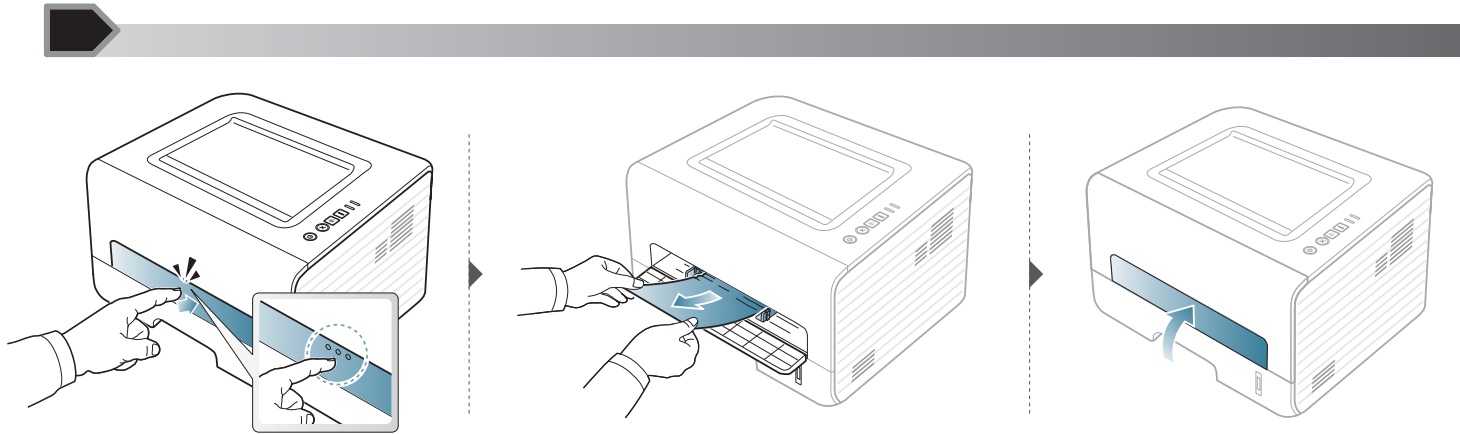

Clearing paper jams

Inside the machine



- The fuser area is hot. Take care when removing paper from the machine.
- Before opening the front cover, close the output support first.

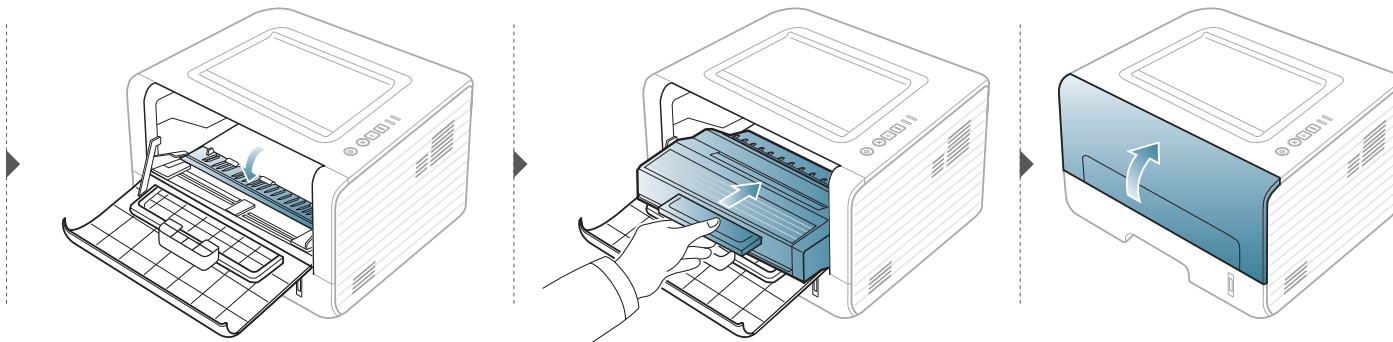
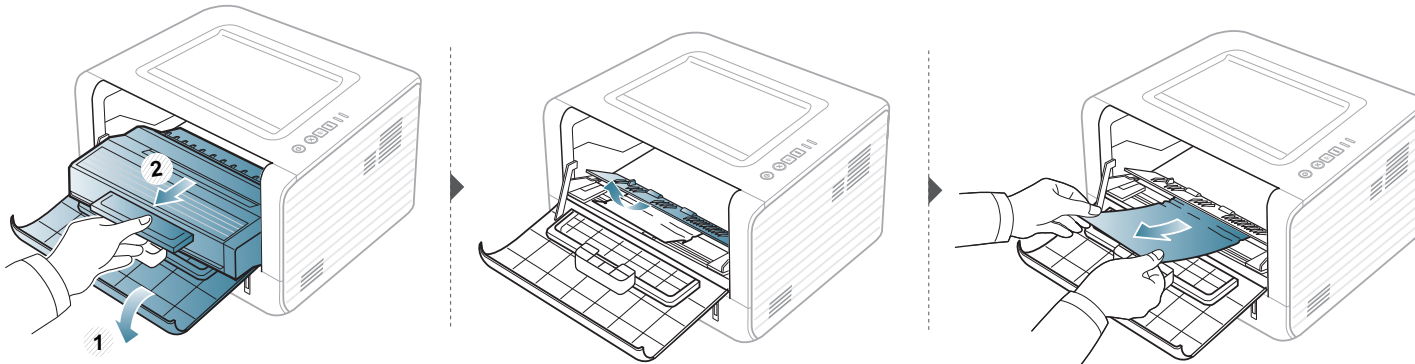

Clearing paper jams

In the exit area

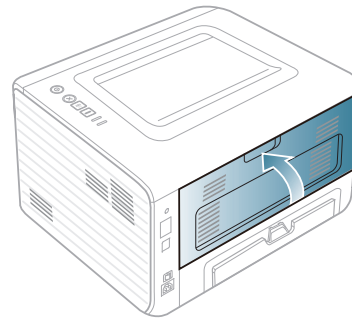
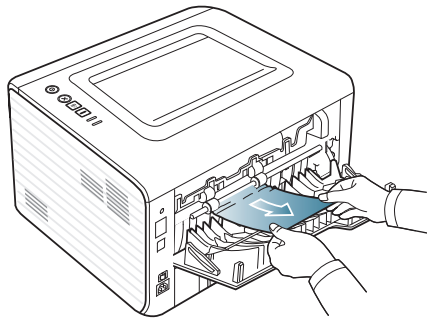
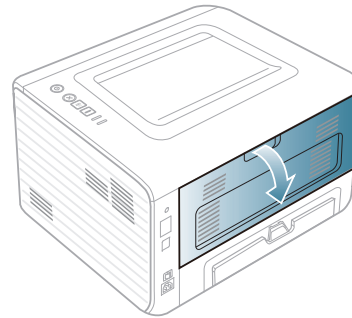
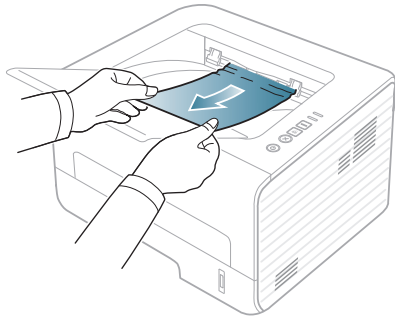

Clearing paper jams

In the duplex area

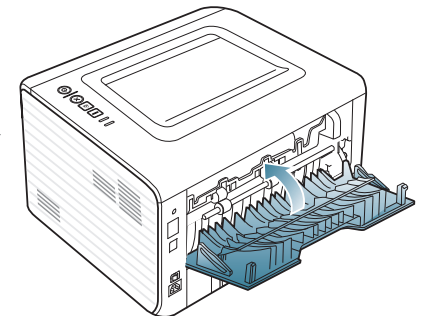
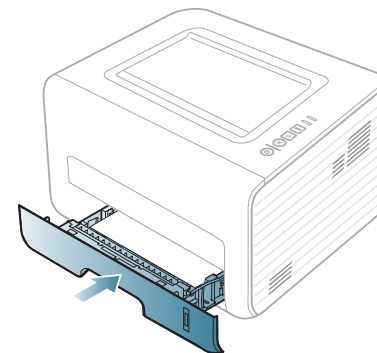
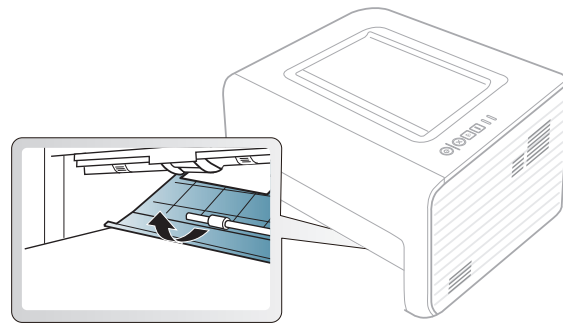
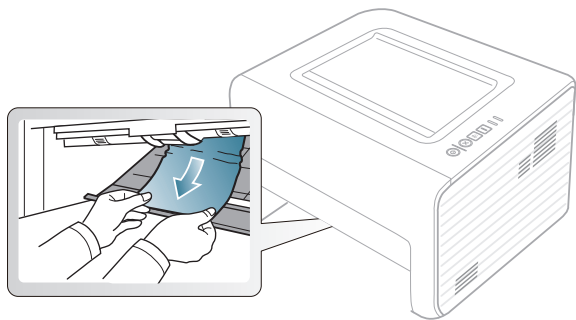
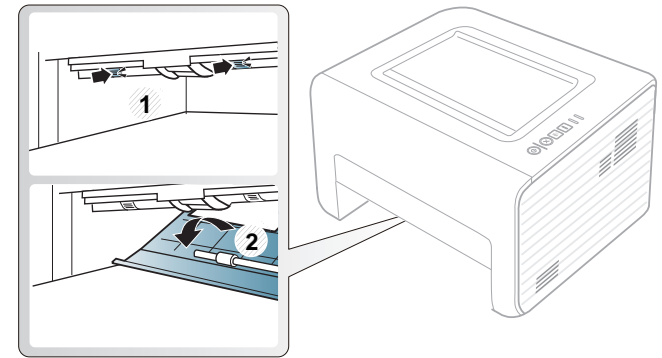
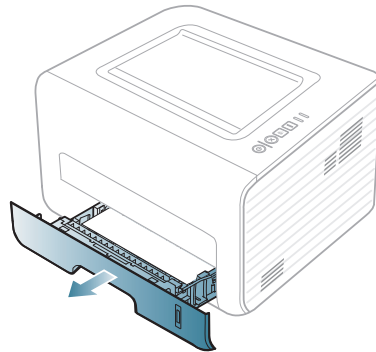
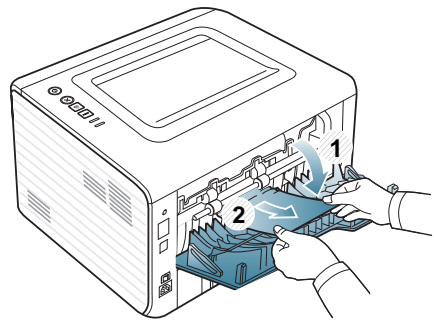

Understanding the status LED

The color of the LED indicates the machine's current status.





- Some LEDs may not be available depending on model or country.
- To resolve the error, look at the error message and its instructions from the troubleshooting part.
- You can also resolve the error with the guidelines from the Printer Status Monitor program window.
- If the problem persists, call a service representative.

Status LED

Status		Description	
 (Status LED)	Off	The machine is off-line.	
	Green	Blinking	<ul style="list-style-type: none">• When the backlight slowly blinks, the machine is receiving data from the computer.• When the backlight blinks rapidly, the machine is printing data.
		On	<ul style="list-style-type: none">• The machine is on-line and can be used.
	Red	Blinking	A minor error has occurred and the machine is waiting for the error to be cleared. When the problem is cleared, the machine resumes.
		On	<ul style="list-style-type: none">• The cover is opened. Close the cover.• There is no paper in the tray. Load paper in the tray ("Loading paper in the tray" on page 25).• The machine has stopped due to a major error.
	Orange	Blinking	Upgrading firmware.
		On	A paper jam has occurred (see "Clearing paper jams" on page 50).

Understanding the status LED

Toner LED/ Power LED

Status		Description	
 (Toner LED)	Orange	Blinking	Small amount of toner is left in the cartridge. The estimated cartridge life of toner is close. Prepare a new cartridge for replacement. You may temporarily increase the printing quality by redistributing the toner (see "Redistributing toner" on page 42).
		On	A toner cartridge has almost reached its estimated cartridge life ^a . It is recommended to replace the toner cartridge (see "Replacing the toner cartridge" on page 43).
		Off	All toner cartridges are at normal capacity.
 (Power LED)	Blue	On	The machine is in power save mode.
		Off	The machine is in ready mode or the machine's power is off.
Eco button	Green	On	Eco mode is on. Duplex, 2-up, toner save on, skip blank page feature will automatically be applied when printing (see "Eco printing" on page 35).
		Off	Eco mode is off.

a. Estimated cartridge life means the expected or estimated toner cartridge life, which indicates the average capacity of print-outs and is designed pursuant to ISO/IEC 19752. The number of pages may be affected by operating environment, printing interval, graphics, media type and media size. Some amount of toner may remain in the cartridge even when red LED is on and the printer stops printing.



5. Appendix

This chapter provides product specifications and information concerning applicable regulations.

- **Specifications** 58
- **Dell technical support policy** 65
- **Contacting Dell** 66
- **Warranty and return policy** 67
- **Copyright** 68

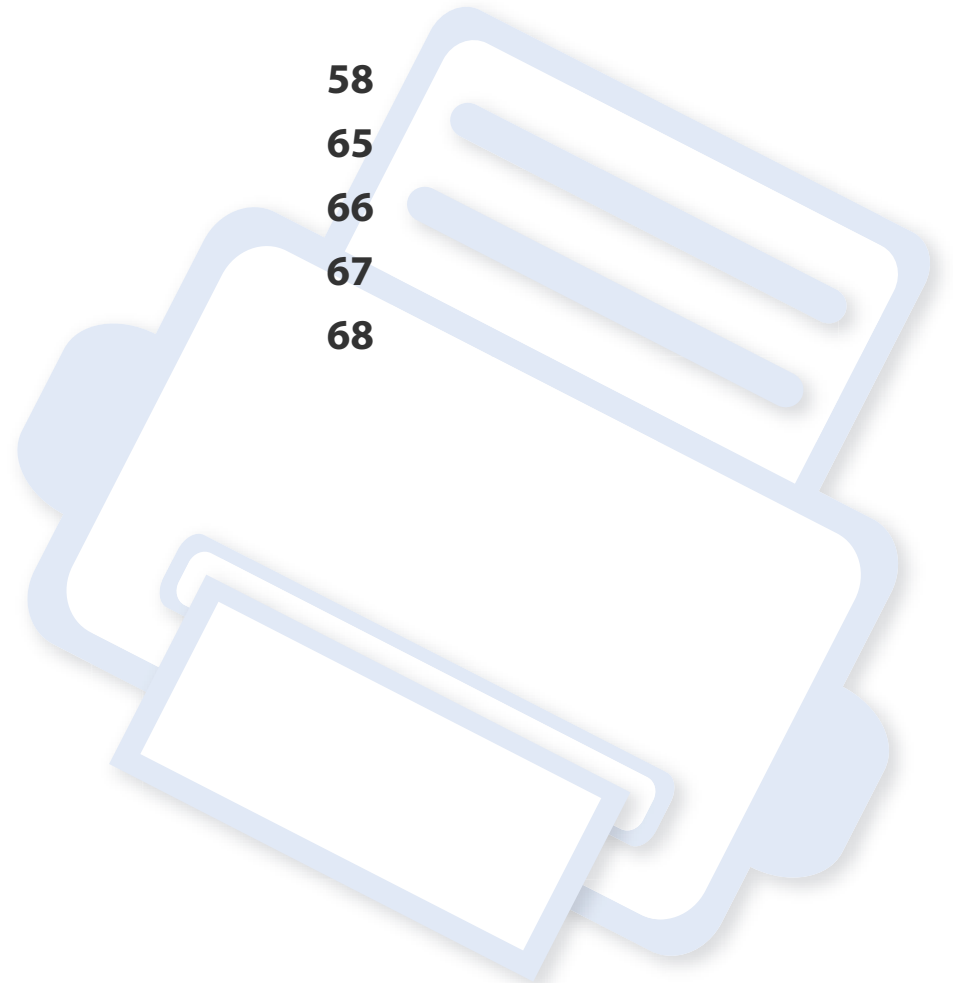

Specifications

General specifications



The specification values listed below are subject to change without notice. See www.dell.com or support.dell.com for possible changes in information.

Items		Description
Dimension	Width x Length x Height	348 x 338 x 197 mm (13.7 x 13.3 x 7.7 inches)
Weight	Machine with consumables	7.2 kg (15.87 lbs)
Noise Level^a	Ready mode	Less than 30 dB (A)
	Print mode	Less than 50 dB (A)
Temperature	Operation	10 to 32°C (50 to 90°F)
	Storage (packed)	-20 to 40°C (-4 to 104°F)
Humidity	Operation	20 to 80% RH
	Storage (packed)	10 to 90% RH
Power rating^b	110 volt models	AC 110 - 127 V
	220 volt models	AC 220 - 240 V
Power consumption	Average operating mode	Less than 400 W
	Ready mode	Less than 45 W
	Power save mode	Less than 1.3 W
	Power off mode	Less than 0.2 W
	Network Standby Mode (All Port Activation)	Less than 1.3 W

a. Sound Pressure Level, ISO 7779. Configuration tested: basic machine installation, A4 paper, simplex printing.

b. See the rating label on the machine for the correct voltage (V), frequency (hertz) and type of current (A) for your machine.

Specifications

Print media specifications

Type	Size	Dimensions	Print media weight/Capacity ^a	
			Tray	Manual feeder ^b
Plain paper	Letter	216 x 279 mm (8.5 x 11 inches)	70 to 90 g/m ² (19 to 24 lbs bond) • 250 sheets of 80 g/m ² (21 lbs bond)	70 to 90 g/m ² (19 to 24 lbs bond) • 1 sheet of 80 g/m ² (21 lbs bond)
	Legal	216 x 356 mm (8.5 x 14 inches)		
	US Folio	216 x 330 mm (8.5 x 13 inches)		
	A4	210 x 297 mm (8.27 x 11.69 inches)		
	Oficio	216 x 343 mm (8.5 x 13.5 inches)		
	JIS B5	182 x 257 mm (7.17 x 10.12 inches)		
	ISO B5	176 x 250 mm (6.93 x 9.84 inches)		
	Executive	184 x 267 mm (7.25 x 10.5 inches)		
	A5	148 x 210 mm (5.83 x 8.27 inches)		
	A6	105 x 148 mm (4.13 x 5.83 inches)		
Envelope	Envelope Monarch	98 x 191 mm (3.87 x 7.5 inches)	Not available in a tray.	60 to 220 g/m ² (16 to 59 lbs bond) • 1 sheet of 80 g/m ² (21 lbs bond)
	Envelope No. 10	105 x 241 mm (4.12 x 9.5 inches)		
	Envelope DL	110 x 220 mm (4.33 x 8.66 inches)		
	Envelope C5	162 x 229 mm (6.38 x 9.02 inches)		
	Envelope C6	114 x 162 mm (4.49 x 6.38 inches)		
Thick paper	Refer to the Plain paper section	Refer to the Plain paper section	91 to 105 g/m ² (24 to 28 lbs bond)	91 to 105 g/m ² (24 to 28 lbs bond)

Specifications

Type	Size	Dimensions	Print media weight/Capacity ^a	
			Tray	Manual feeder ^b
Thicker paper	Refer to the Plain paper section	Refer to the Plain paper section	Not available in a tray.	164 to 220 g/m ² (44 to 59 lbs bond)
Thin paper	Refer to the Plain paper section	Refer to the Plain paper section	60 to 70 g/m ² (16 to 19 lbs bond)	60 to 70 g/m ² (16 to 19 lbs bond)
Transparency	Letter, A4	Refer to the Plain paper section	Not available in a tray.	138 to 146 g/m ² (37 to 39 lbs bond)
Labels ^c	Letter, Legal, US Folio, A4, JIS B5, ISO B5, Executive, A5	Refer to the Plain paper section	Not available in a tray.	120 to 150 g/m ² (32 to 40 lbs bond)
Card stock	Letter, Legal, US Folio, A4, JIS B5, ISO B5, Executive, A5, Postcard 4x6	Refer to the Plain paper section	121 to 163 g/m ² (32 to 43 lbs bond)	121 to 163 g/m ² (32 to 43 lbs bond)
Bond paper	Refer to the Plain paper section	Refer to the Plain paper section	106 to 120 g/m ² (28 to 32 lbs bond)	106 to 120 g/m ² (28 to 32 lbs bond)
Minimum size (custom)		<ul style="list-style-type: none"> • Manual feeder: 76.2 x 127 mm (3 x 5 inches) • Tray 1: 105 x 148.5 mm (4.13 x 5.85 inches) 	60 to 163 g/m ² (16 to 43 lbs bond) ^{d, e}	
Maximum size (custom)		216 x 356 mm (8.5 x 14 inches)		

a. Maximum capacity may differ depending on media weight, thickness, and environmental conditions.

b. 1 sheet for manual feeder.

c. The smoothness of the labels used in this machine is 100 to 250 (sheffield). This means the numeric level of smoothness.

d. The paper types available in the manual feeder: Plan, Thick, Thicker, Thin, Cotton, Colored, Pre-printed, Recycled, Envelope, Transparency, Labels, Cardstock, Bond, Archive.

e. The paper types available in the tray: Plan, Thick, Thin, Recycled, Cardstock, Bond, Archive

Specifications

System requirements

Microsoft® Windows®

Operating system	Requirement (recommended)		
	CPU	RAM	free HDD space
Windows® 2000	Intel® Pentium® II 400 MHz (Pentium III 933 MHz)	64 MB (128 MB)	600 MB
Windows® XP	Intel® Pentium® III 933 MHz (Pentium IV 1 GHz)	128 MB (256 MB)	1.5 GB
Windows Server® 2003	Intel® Pentium® III 933 MHz (Pentium IV 1 GHz)	128 MB (512 MB)	1.25 GB to 2 GB
Windows Server® 2008	Intel® Pentium® IV 1 GHz (Pentium IV 2 GHz)	512 MB (2 GB)	10 GB
Windows Vista®	Intel® Pentium® IV 3 GHz	512 MB (1 GB)	15 GB
Windows® 7	Intel® Pentium® IV 1 GHz 32-bit or 64-bit processor or higher	1 GB (2 GB)	16 GB
	<ul style="list-style-type: none">• Support for DirectX® 9 graphics with 128 MB memory (to enable the Aero theme).• DVD-R/W Drive		
Windows Server® 2008 R2	Intel® Pentium® IV 1 GHz (x86) or 1.4 GHz (x64) processors (2 GHz or faster)	512 MB (2 GB)	10 GB

-  Internet Explorer 6.0 or higher is the minimum requirement for all Windows operating systems.
- Users who have administrator rights can install the software.
- Windows Terminal Services** is compatible with your machine.
- For Windows 2000, Services Pack 4 or higher is required.

Specifications

Macintosh

Operating system	Requirements (Recommended)		
	CPU	RAM	Free HDD space
Mac OS X 10.4	<ul style="list-style-type: none">• Intel® processors• PowerPC G4/ G5	<ul style="list-style-type: none">• 128 MB for a powerPC based Mac (512 MB)• 512 MB for an Intel-based Mac (1 GB)	1 GB
Mac OS X 10.5	<ul style="list-style-type: none">• Intel® processors• 867 MHz or faster Power PC G4/ G5	512 MB (1 GB)	1 GB
Mac OS X 10.6	<ul style="list-style-type: none">• Intel® processors	1 GB (2 GB)	1 GB
Mac OS X 10.7	<ul style="list-style-type: none">• Intel® processors	2 GB	4 GB

Specifications

Linux

Items	Requirements
Operating system	Fedora 5~13 (32/ 64 bit) OpenSuSE® 10.2, 10.3, 11.0, 11.1, 11.2 (32/64 bit) SuSE 10.0, 10.1 (32 bit) Ubuntu 6.06, 6.10, 7.04, 7.10, 8.04, 8.10, 9.04, 9.10, 10.04 (32/64 bit) Mandriva 2007, 2008, 2009, 2009.1, 2010 (32/64 bit) Debian 4.0, 5.0 (32/64 bit) Redhat® Enterprise Linux WS 4, 5 (32/64 bit) SuSE Linux Enterprise Desktop 10, 11 (32/64 bit)
CPU	Pentium IV 2.4GHz (Intel Core™2)
RAM	512 MB (1 GB)
Free HDD space	1 GB (2 GB)

Unix

Items	Requirements
Operating system	Sun Solaris 9, 10 (x86, SPARC) HP-UX 11.0, 11i v1, 11i v2, 11i v3 (PA-RISC, Itanium) IBM AIX 5.1, 5.2, 5.3, 5.4
Free HDD space	Up to 100 MB

Specifications

Network environment



Network and wireless models only (see "Features by models" on page 6).

You need to set up the network protocols on the machine to use it as your network machine. The following table shows the network environments supported by the machine.

Items	Specifications
Network interface	<ul style="list-style-type: none">• Ethernet 10/100 Base-TX Wired Lan
Network operating system	<ul style="list-style-type: none">• Windows 2000/Server 2003 /Server 2008/XP/Vista/7/Server 2008 R2• Various Linux OS• Mac OS X 10.4 ~ 10.7• Unix
Network protocols	<ul style="list-style-type: none">• TCP/IPv4• DHCP, BOOTP• DNS, WINS, Bonjour, SLP, UPnP• Standard TCP/IP Printing (RAW), LPR, IPP, WSD• SNMPv 1/2/3, HTTP• TCP/IPv6 (DHCP, DNS, RAW, LPR, SNMPv 1/2/3, HTTP)

Dell technical support policy

Technician-assisted technical support requires the cooperation and participation of the customer in the troubleshooting process and provides for restoration of the Operating System, application software, and hardware drivers to the original default configuration as shipped from Dell, as well as the verification of appropriate functionality of the printer and all Dell-installed hardware. In addition to this technician assisted technical support, online technical support is available at Dell Support. Additional technical support options may be available for purchase.

Dell provides limited technical support for the printer and any Dell-installed software and peripherals. Support for third-party software and peripherals is provided by the original manufacturer, including those purchased and/or installed through Software & Peripherals (DellWare), ReadyWare, and Custom Factory Integration (CFI/DellPlus).

Contacting Dell

You can access Dell Support at **support.dell.com**. Select your region on the WELCOME TO DELL SUPPORT page, and fill in the requested details to access help tools and information.

You can contact Dell electronically using the following addresses:

- World Wide Web
 - **www.dell.com/**
 - **www.dell.com/ap/** (Asian/Pacific countries only)
 - **www.dell.com/jp/** (Japan only)
 - **www.euro.dell.com** (Europe only)
 - **www.dell.com/la/** (Latin American and Caribbean countries)
 - **www.dell.ca** (Canada only)
- Anonymous file transfer protocol (FTP)
 - **ftp.dell.com**
Log in as user: anonymous, and use your email address as your password.
- Electronic Support Service
 - **mobile_support@us.dell.com**
 - **support@us.dell.com**
 - **la-techsupport@dell.com** (Latin America and Caribbean countries only)
 - **apsupport@dell.com** (Asian/Pacific countries only)
 - **support.jp.dell.com** (Japan only)

- **support.euro.dell.com** (Europe only)
- Electronic Quote Service
 - **apmarketing@dell.com** (Asian/Pacific countries only)
 - **sales_canada@dell.com** (Canada only)

Warranty and return policy

Dell Inc. ("Dell") manufactures its hardware products from parts and components that are new or equivalent to new in accordance with industry-standard practices. For information about the Dell warranty for your printer, refer to the *Product Information Guide*.

Copyright

Information in this document is subject to change without notice.

©2012 Dell Inc. All rights reserved.

Reproduction of these materials in any manner whatsoever without the written permission of Dell Inc. is strictly forbidden.

Trademarks used in this text: *Dell*, the *Dell* logo, and *Dell Toner Management System* are trademarks of Dell Inc.; *Microsoft*, *Windows*, *Windows Vista*, and *Windows Server* are registered trademarks of Microsoft Corporation in the United States and/or other countries; *Adobe* and *Acrobat Reader* are either registered trademarks or trademarks of Adobe Systems Incorporated in the United States and/or other countries.

iPad, iPhone, iPod touch, TrueType, Mac and Mac OS are trademarks of Apple Inc., registered in the U.S and other countries. AirPrint and the AirPrint logo are trademarks of Apple Inc.

Google, Picasa, Google Docs, Android and Gmail are either registered trademarks or trademarks of Google Inc.

Google Cloud Print is a trademark of Google Inc.

Other trademarks and trade names may be used in this document to refer to the entities claiming the marks and names of their products.

Dell Inc. disclaims any proprietary interest in trademarks and trade names other than its own.

Refer to the '**LICENSE.txt**' file in the provided CD-ROM for the open source license information.

REV. 3.00

User's Guide

Dell B1260dn

ADVANCED

IMAGINE THE POSSIBILITIES

This guide provides information about installation, advanced configuration, operation and troubleshooting on various OS environments.

Some features may not be available depending on model or country.

BASIC

This guide provides information concerning installation, basic operation and troubleshooting on windows.



1. Software installation

Installation for Macintosh	72
Reinstallation for Macintosh	73
Installation for Linux	74
Reinstallation for Linux	75



2. Using a network-connected machine

Useful network programs	77
Wired network setup	78
Installing driver over the network	81
IPv6 configuration	87
AirPrint	89
Google Cloud Print	90



3. Useful management tools

Using Firmware Update Utility	93
Using Dell Supplies Ordering Utility	94
Using Embedded Web Service	95

Using Dell Printer Manager	97
Using Dell Printer Status	99
Using the Linux Unified Driver Configurator	101



4. Special features

Altitude adjustment	106
Changing the default print settings	107
Setting your machine as a default machine	108
Using advanced print features	109
Macintosh printing	115
Linux printing	117
Unix printing	119



5. Troubleshooting

Paper feeding problems	122
Power and cable connecting problems	123
Printing problems	124
Printing quality problems	127
Operating system problems	134



1. Software installation

This chapter provides instructions for installing essential and helpful software for use in an environment where the machine is connected via a cable. A locally connected machine is a machine directly attached to your computer using the cable. If your machine is attached to a network, skip the following steps below and go on to installing a network connected machine's driver (see [Installing driver over the network](#)⁸¹).

- **Installation for Macintosh** **72**
- **Reinstallation for Macintosh** **73**
- **Installation for Linux** **74**
- **Reinstallation for Linux** **75**



- If you are a Windows OS user, refer to the Basic Guide for installing the machine's driver.
- Only use a USB cable no longer than 3 meter (118 inches).

Installation for Macintosh

- 1 Make sure that the machine is connected to your computer and powered on.
- 2 Insert the supplied software CD into your CD-ROM drive.
- 3 Double-click the CD-ROM icon that appears on your Macintosh desktop.
- 4 Double-click the **MAC_Installer** folder > **Installer OS X** icon.
- 5 Click **Continue**.
- 6 Read the license agreement and click **Continue**.
- 7 Click **Agree** to agree to the license agreement.
- 8 When the message that warns that all applications will close on your computer appears, click **Continue**.
- 9 Click **Continue** on the **User Options Pane**.
- 10 Click **Install**. All components necessary for machine operations will be installed.
If you click **Customize**, you can choose individual components to install.
- 11 Enter the password and click **OK**.
- 12 Installing software requires you to restart your computer. Click **Continue Installation**.
- 13 After the installation is finished, click **Close**.
- 14 Open the **Applications** folder > **Utilities** > **Print Setup Utility**.
 - For Mac OS X 10.5 -10.7, open the **Applications** folder > **System Preferences** and click **Print & Fax**.
- 15 Click **Add** on the **Printer List**.
 - For Mac OS X 10.5 -10.7, click the "+" folder icon; a display window will pop up.
- 16 Click **Default Browser** and find the USB connection.
 - For Mac OS X 10.5-10.7, click **Default** and find the USB connection.
- 17 For Mac OS X 10.4, if Auto Select does not work properly, select **Dell** in **Print Using** and your machine name in **Model**.
 - For Mac OS X 10.5-10.7, if Auto Select does not work properly, select **Select a driver to use...** and your machine name in **Print Using**.Your machine appears on the **Printer List**, and is set as the default machine.
- 18 Click **Add**.

Reinstallation for Macintosh

If the printer driver does not work properly, uninstall the driver and reinstall it.

- 1 Make sure that the machine is connected to your computer and powered on.
- 2 Insert the supplied software CD into your CD-ROM drive.
- 3 Double-click the CD-ROM icon that appears on your Macintosh desktop.
- 4 Double-click the **MAC_Installer** folder > **Uninstaller OS X** icon.
- 5 Enter the password and click **OK**.
- 6 When the uninstall is done, click **OK**.



If a machine has already been added, delete it from the **Print Setup Utility** or **Print & Fax**.

Installation for Linux

You need to download Linux software packages from the Dell website to install the printer software (<http://www.support.dell.com>).

Installing the Unified Linux Driver

- 1 Make sure that the machine is connected to your computer and powered on.
- 2 When the **Administrator Login** window appears, type "root" in the **Login** field and enter the system password.



You must log in as a super user (root) to install the machine software. If you are not a super user, ask your system administrator.

- 3 From the Dell website, download the Unified Linux Driver package to your computer.
- 4 Right-click the **Unified Linux Driver** package and extract the package.
- 5 Double click **cdroot > autorun**.
- 6 When the welcome screen appears, click **Next**.
- 7 When the installation is complete, click **Finish**.

The installation program added the Unified Driver Configurator desktop icon and the Unified Driver group to the system menu for your convenience. If you have any difficulties, consult the on-screen help that is available through your system menu or from the driver package Windows applications, such as **Unified Driver Configurator** or **Image Manager**.

Reinstallation for Linux

If the printer driver does not work properly, uninstall the driver and reinstall it.

- 1 Make sure that the machine is connected to your computer and powered on.
- 2 When the **Administrator Login** window appears, type "root" in the **Login** field and enter the system password.
You must log in as a super user (root) to uninstall the printer driver. If you are not a super user, ask your system administrator.
- 3 Click the icon at the bottom of the desktop. When the Terminal screen appears, type in the following.

```
[root@localhost root]#cd /opt/Dell/mfp/uninstall/  
[root@localhost uninstall]#./uninstall.sh
```
- 4 Click **Uninstall**.
- 5 Click **Next**.
- 6 Click **Finish**.



2. Using a network-connected machine

This chapter gives you step-by-step instructions for setting up a network connected machine and software.

- **Useful network programs** 77
- **Wired network setup** 78
- **Installing driver over the network** 81
- **IPv6 configuration** 87
- **AirPrint** 89
- **Google Cloud Print™** 90

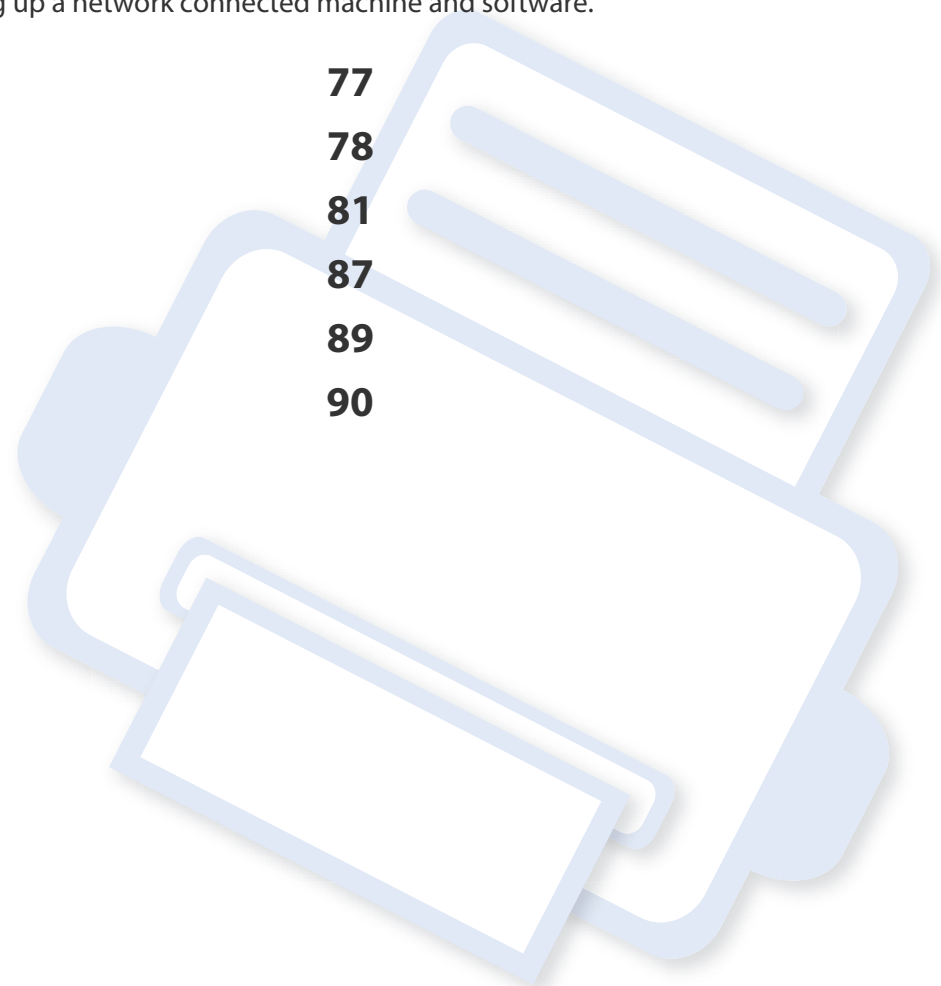

Useful network programs

There are several programs available to setup the network settings easily in a network environment. For the network administrator especially, managing several machines on the network is possible.



Before using the programs below, set the IP address first.

Embedded Web Service

The web server embedded on your network machine allows you to do the following tasks (see "Using Embedded Web Service" on page 88):

- Check the supplies information and status.
- Customize machine settings.
- Set the email notification option. When you set this option, the machine status (toner cartridge shortage or machine error) will be sent to a certain person's email automatically.
- Configure the network parameters necessary for the machine to connect to various network environments.

SetIP

This utility program allows you to select a network interface and manually configure the IP addresses for use with the TCP/IP protocol.

- See "IPv4 configuration using SetIP (Windows)" on page 78.
- See "IPv4 configuration using SetIP (Macintosh)" on page 79.
- See "IPv4 configuration using SetIP (Linux)" on page 80.



TCP/IPv6 is not supported by this program.

Wired network setup

You must set up the network protocols on your machine to use it on your network.

You can use network after connecting network cable to a corresponding port on your machine.

- For models that do not have the display screen on the control panel, use the Embedded Web Service or SetIP program.
 - See "Using Embedded Web Service" on page 95.
 - See "Setting IP address" on page 78.

Printing a network configuration report

You can print **Network Configuration Report** from the machine's control panel that will show the current machine's network settings. This will help you to set up a network.

Press the  (**Info**) button on the control panel.

Using this **Network Configuration Report**, you can find your machine's MAC address and IP address.

For example:

- MAC Address: 00:15:99:41:A2:78
- IP Address: 169.254.192.192

Setting IP address

First, you have to set up an IP address for network printing and managements. In most cases a new IP address will be automatically assigned by a DHCP (Dynamic Host Configuration Protocol) server located on the network.

IPv4 configuration using SetIP (Windows)

Before using the SetIP program, disable the computer firewall from **Control Panel > Security Center > Windows Firewall**.





The following instructions may differ for your model.

- 1 Install this program from the supplied CD-ROM by double-click **Application > SetIP > Setup.exe**.
- 2 Follow the instructions in the installation window.
- 3 Connect your machine to the network with a network cable.
- 4 Turn on the machine.
- 5 From the Windows **Start** menu, select **All Programs > Dell > Dell Printers > SetIP > SetIP**.

Wired network setup

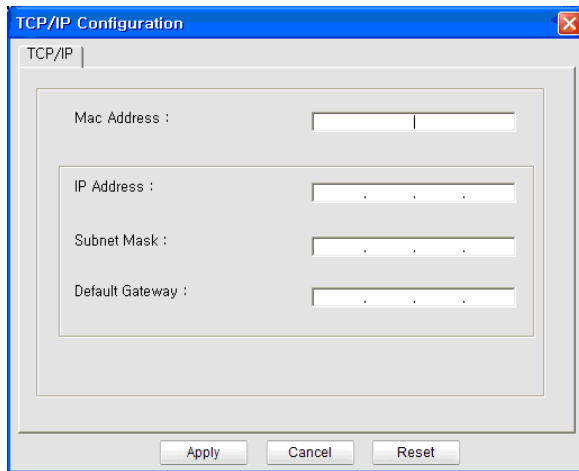
- 6 Click the  icon (third from left) in the SetIP window to open the TCP/IP configuration window.
- 7 Enter the machine's new information into the configuration window as follows. In a corporate intranet, you may need to have this information assigned by a network manager before proceeding.



-  Find the machine's MAC address from the **Network Configuration Report** (see "Printing a network configuration report" on page 78) and enter it without the colons. For example, 00:15:99:29:51:A8 becomes 0015992951A8.

- 8 Click **Apply**, and then click **OK**. The machine will automatically print the **Network Configuration Report**. Confirm that all the settings are correct.

IPv4 configuration using SetIP (Macintosh)

Before using the SetIP program, disable the computer firewall from **System Preferences > Security > Firewall**.



The following instructions may vary from your model.

- 1 Connect your machine to the network with a network cable.
- 2 Insert the Installation CD-ROM, and open the disk window, select **MAC_Installer > MAC_Printer > SetIP > SetIPApplet.html**.
- 3 Double-click the file and **Safari** will automatically open, then select **Trust**. The browser will open the **SetIPApplet.html** page that shows the printer's name and IP address information.
- 4 Click the  icon (third from left) in the SetIP window to open the TCP/IP configuration window.
- 5 Enter the machine's new information into the configuration window. In a corporate intranet, you may need to have this information assigned by a network manager before proceeding.

Wired network setup



Find the machine's MAC address from the **Network Configuration Report** (see "Printing a network configuration report" on page 78) and enter it without the colons. For example, 00:15:99:29:51:A8 becomes 0015992951A8.

6 Select **Apply**, then **OK**, and **OK** again.

7 Quit **Safari**.

IPv4 configuration using SetIP (Linux)

Before using the SetIP program, disable the computer firewall from **System Preferences** or **Administrator**.



The following instructions may vary from your model or operating systems.

1 Open `/opt/Dell/mfp/share/utils/`.

2 Double-click the **SetIPApplet.html** file.

3 Click to open the TCP/IP configuration window.

4 Enter the machine's new information into the configuration window. In a corporate intranet, you may need to have this information assigned by a network manager before proceeding.



Find the machine's MAC address from the **Network Configuration Report** (see "Printing a network configuration report" on page 78) and enter it without the colons. For example, 00:15:99:29:51:A8 becomes 0015992951A8.

5 The machine will automatically print the **Network Configuration Report**.

Installing driver over the network

Windows

- 1 Make sure that the machine is connected to the network and powered on. Also, your machine's IP address should have been set.

 If the "**Found New Hardware Wizard**" appears during the installation procedure, click **Cancel** to close the window.

- 2 Insert the supplied software CD into your CD-ROM drive.
The software CD should automatically run and an installation window will appear.

If the installation window does not appear, click **Start > All programs > Accessories > Run**.

X:**Setup.exe** replacing "X" with the letter, which represents your CD-ROM drive and click **OK**.

- 3 Select **Next**.

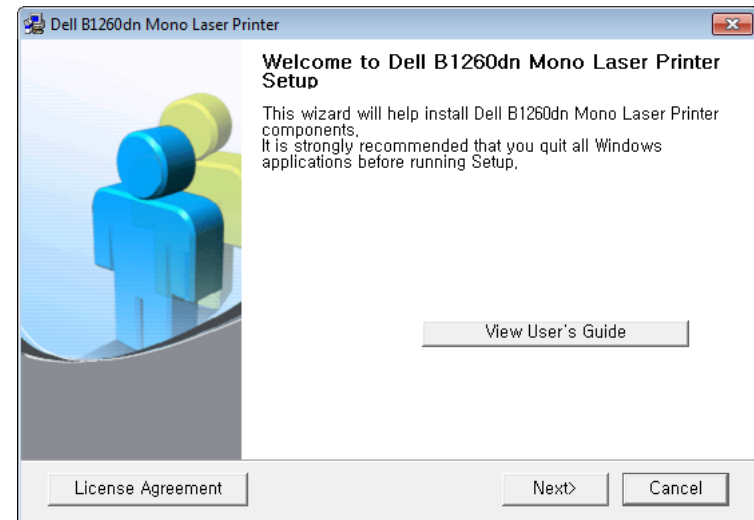

- 4 Select **Connect a network printer to the computer**. Click **Next**.

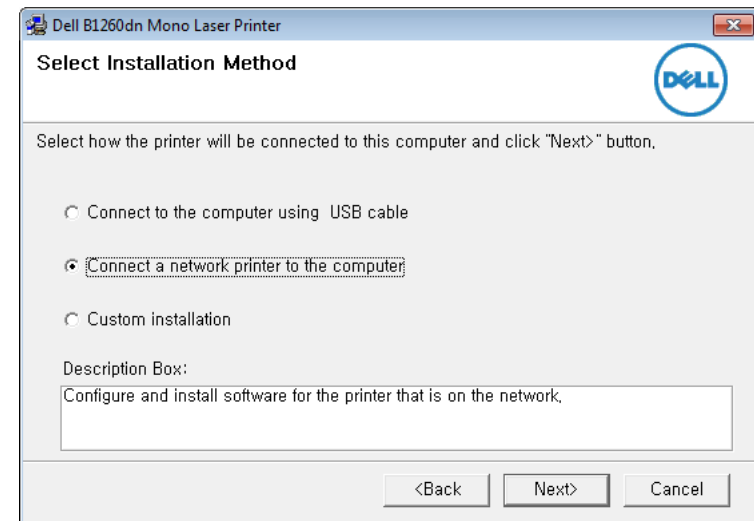

Installing driver over the network



- The **Custom installation** allows you to select the machine's connection and choose individual components to install. Follow the instructions on the window.

- 5 The searched machines will be shown on the screen. Select the one you wish to use and click **Next**.



If you cannot find your machine in network, turn off the firewall and click **Update**. For Windows operating system, **Start > Control Panel** and start windows firewall, and set this option unactivated. For other operating system, refer to its on-line guide.

- 6 Follow the instructions in the installation window.

Macintosh

- 1 Make sure that the machine is connected to your network and powered on.
- 2 Insert the supplied software CD into your CD-ROM drive.
- 3 Double-click the CD-ROM icon that appears on your Macintosh desktop.
- 4 Double-click the **MAC_Installer** folder > **Installer OS X** icon.

- 5 Click **Continue**.

- 6 Read the license agreement and click **Continue**.

- 7 Click **Agree** to agree to the license agreement.

- 8 When the message which warns that all applications will close on your computer appears, click **Continue**.

- 9 Click **Continue** on the **User Options Pane**.



If you have not set the IP address yet, click Set IP address and refer to "IPv4 configuration using SetIP (Macintosh)" on page 79.

- 10 Click **Install**. All components necessary for machine operations will be installed.

If you click **Customize**, you can choose individual components to install.

- 11 Enter the password and click **OK**.

- 12 Installing software requires you to restart your computer. Click **Continue Installation**.

- 13 After the installation is finished, click **Close**.

Installing driver over the network

14 Open the **Applications** folder > **Utilities** > **Print Setup Utility**.

- For Mac OS X 10.5-10.7, open the **Applications** folder > **System Preferences** and click **Print & Fax**.

15 Click **Add** on the **Printer List**.

- For Mac OS X 10.5-10.7, click the "+" icon. A display window will pop up.

16 For Mac OS X 10.4, click **IP Printer**.

- For Mac OS X 10.5-10.7, click **IP**.

17 Select **HP Jetdirect - Socket** in **Protocol**.



When printing a document containing many pages, printing performance may be enhanced by choosing **Socket** for **Printer Type** option.

18 Enter the machine's IP address in the **Address** input field.

19 Enter the queue name in the **Queue** input field. If you cannot determine the queue name for your machine server, try using the default queue first.

20 For Mac OS X 10.4, if Auto Select does not work properly, select **Dell** in **Print Using** and your machine name in **Model**.

- For Mac OS X 10.5-10.7, if Auto Select does not work properly, choose **Select Printer Software** and your machine name in **Print Using**.

21 Click **Add**.

Your machine appears in the **Printer List**, and is set as the default machine.

Linux

You need to download Linux software packages from the Dell website to install the printer software (www.dell.com or support.dell.com > find your product > Support or Downloads).



To install other software:

- See "Installing the Unified Linux Driver" on page 74.

Install the Linux driver and add network printer

1 Make sure that the machine is connected to your network and powered on. Also, your machine's IP address should have been set.

2 Download the Unified Linux Driver package from the Dell website.

Installing driver over the network

- 3 Extract the UnifiedLinuxDriver.tar.gz file and open the new directory.
- 4 Double-click the **Linux** folder > **install.sh** icon.
- 5 The Dell installer window opens. Click **Continue**.
- 6 The add printer wizard window opens. Click **Next**.
- 7 Select network printer and click **Search** button.
- 8 The machine's IP address and model name appears on list field.
- 9 Select your machine and click **Next**.
- 10 Input the printer description and **Next**.
- 11 After the machine is added, click **Finish**.
- 12 When installation is done, click **Finish**.

Add a network printer

- 1 Double-click the **Unified Driver Configurator**.
- 2 Click **Add Printer**.
- 3 The **Add printer wizard** window opens. Click **Next**.
- 4 Select **Network printer** and click the **Search** button.

- 5 The printer's IP address and model name appears on list field.
- 6 Select your machine and click **Next**.
- 7 Enter the printer description and click **Next**.
- 8 After the machine is added, click **Finish**.

UNIX



- Make sure your machine supports the UNIX operating system before installing the UNIX printer driver (see "Unix" on page 63).
- The commands are marked with "", when typing the commands, do not type "".

To use the UNIX printer driver, you have to install the UNIX printer driver package first, then setup the printer. You can download the UNIX printer driver package from the Dell website.

Installing the UNIX printer driver package

The installation procedure is common for all variants of UNIX OS mentioned.

Installing driver over the network

1 From the Dell website, download and unpack the UNIX Printer Driver package to your computer.

2 Acquire root privileges.

`"su -"`

3 Copy the appropriate driver archive to the target UNIX computer.



See administration guide of your UNIX OS for details.

4 Unpack the UNIX printer driver package.

For example, on IBM AIX, use the following commands.

`"gzip -d < enter the package name | tar xf -"`

5 Go to the unpacked directory.

6 Run the install script.

`"/install -i"`

install is the installer script file which is used to install or uninstall the UNIX Printer Driver package.

Use `"chmod 755 install"` command to give the permission to the installer script.

7 Execute the `"/install -c"` command to verify installation results.

8 Run `"installprinter"` from the command line. This will bring up the **Add Printer Wizard** window. Setup the printer in this window referring to the following procedures.



On some UNIX OS, for example on Solaris 10, just added printers may not be enabled and/or may not accept jobs. In this case run the following two commands on the root terminal:

`"accept <printer_name>"`

`"enable <printer_name>"`

Uninstalling the printer driver package



The utility should be used to delete the printer installed in the system.

a Run `"uninstallprinter"` command from the terminal.

It will open the **Uninstall Printer Wizard**.

The installed printers are listed in the drop-down list.

b Select the printer to be deleted.

c Click **Delete** to delete the printer from the system.

d Execute the `"/install -d"` command to uninstall the whole package.

e To verify removal results, execute the `"/install -c"` command.

To re-install it, use the command `"/install"` to reinstall the binaries.

Installing driver over the network

Setting up the printer

To add the printer to your UNIX system, run 'installprinter' from the command line. This will bring up the Add Printer Wizard window. Setup the printer in this window according to the following steps:

- 1 Type the name of the printer.
- 2 Select the appropriate printer model from the model list.
- 3 Enter any description corresponding to the type of the printer in the **Type** field. This is optional.
- 4 Specify any printer description in the **Description** field. This is optional.
- 5 Specify the printer location in the **Location** field.
- 6 Type the IP address or DNS name of the printer in the **Device** textbox for network-connected printers. On IBM AIX with **jetdirect Queue type**, only the DNS name is possible-numeric IP address is not allowed.
- 7 **Queue type** shows the connection as **lpd** or **jetdirect** in the corresponding list box. Additionally, **usb** type is available on Sun Solaris OS.
- 8 Select **Copies** to set the number of copies.
- 9 Check the **Collate** option to receive copies already sorted.
- 10 Check the **Reverse Order** option to receive copies in the reverse order.
- 11 Check the **Make Default** option to set this printer as default.
- 12 Click **OK** to add the printer.

IPv6 configuration



IPv6 is supported properly only in Windows Vista or higher.



If the IPv6 network seems to not be working, set all the network setting to the factory defaults and try again using **Clear Setting**.

In the IPv6 network environment, follow the next procedure to use the IPv6 address.

From the control panel

- 1 Connect your machine to the network with a network cable.
- 2 Turn on the machine.
- 3 Print a **Network Configuration Report** that will check IPv6 addresses (see "Printing a network configuration report" on page 78).
- 4 Select **Start > Control Panel > Printers and Faxes**.
- 5 Click **Add a printer** in the left pane of the **Printers and Faxes** windows.
- 6 Click **Add a local printer** in the **Add Printer** windows.

7

The **Add Printer Wizard** window appears. Follow the instructions in the window.



If the machine does not work in the network environment, activate IPv6. Refer to the next section followed by.

From the Embedded Web Service



For models that do not have the display screen on the control panel, you need to access **Embedded Web Service** first using the IPv4 address and follow the below procedure to use IPv6.

1

Access a web browser, such as Internet Explorer, from Windows. Enter the machine IP address (<http://xxx.xxx.xxx.xxx>) in the address field and press the Enter key or click **Go**.

2

If it's your first time logging into **Embedded Web Service** you need to log-in as an administrator. Type in the below default ID and password.

- **ID: admin**
- **Password: dell00000**

IPv6 configuration

- 3 When the **Embedded Web Service** window opens, move the mouse cursor over the **Settings** of the top menu bar and then click **Network Settings**.
- 4 Click **TCP/IPv6** on the left pane of the website.
- 5 Check the **IPv6 Protocol** check box to activate IPv6.
- 6 Check the **Manual Address** check box. Then, the **Address/Prefix** text box is activated.
- 7 Enter the rest of the address (e.g.,:3FFE:10:88:194::**AAAA**. "A" is the hexadecimal 0 through 9, A through F).
- 8 Choose the DHCPv6 configuration.
- 9 Click the **Apply** button.



Address must be enclosed in '[']' brackets.

Using Embedded Web Service

- 1 Start a web browser, such as Internet Explorer, that supports IPv6 addressing as a URL.
- 2 Select one of the IPv6 addresses (**Link-local Address, Stateless Address, Stateful Address, Manual Address**) from **Network Configuration Report** (see "Printing a network configuration report" on page 78).
- 3 Enter the IPv6 addresses (e.g.,: http://[FE80::215:99FF:FE66:7701]).

AirPrint



AirPrint allows you to wirelessly print directly from an iPhone, iPad, or iPod touch running iOS 4.2 or later.

Setting up AirPrint

Bonjour(mDNS) and IPP protocols are required on your machine to use the **AirPrint** feature. You can enable the **AirPrint** feature by one of the following methods.

- 1 Check whether the machine is connected to the network.
- 2 Start a web browser such as Internet Explorer, Safari, or Firefox and enter your machine's new IP address in the browser window.

For example,



- 3 Click **Login** in the upper right of the Embedded Web Service website.
- 4 Type in the **ID** and **Password**, then click **Login**. If it's your first time logging into Embedded Web Service, type in the below default ID and password.
 - **ID: admin**
 - **Password: dell00000**

- 5 When the **Embedded Web Service** window opens, click **Settings > Network Settings**.
- 6 Click **Raw TCP/IP, LPR, IPP or mDNS**.
You can enable the IPP protocol or mDNS protocol.

Printing via AirPrint

For example, the iPad manual provides these instructions:

- 1 Open your email, photo, web page, or document you want to print.
- 2 Touch the action icon ().
- 3 Select **your printer driver name** and option menu to set up.
- 4 Touch **Print** button. Print it out.



Cancelling print job: To cancel the printing job or view the print summary, click the print center icon () in multitasking area. You can click cancel in the print center.

Google Cloud Print™

Google Cloud Print™ is a service that allows you to print to a printer using your smart phone, tablet, or any other web-connected devices. Just register your Google account with the printer, and you are ready to use the Google Cloud Print™ service. You can print your document or email with Chrome OS, Chrome browser, or a Gmail™/ Google Docs™ application on your mobile device, so you don't need to install the printer driver on the mobile device. Refer to the Google website (<http://support.google.com/cloudprint>) for more information about Google Cloud Print™.

Registering your Google account to the printer



- Make sure the printer machine is turned on and connected to a wired or wireless network that has access to the Internet.
- You should create your Google account in the advance.

- 1 Open the Chrome browser.
- 2 Visit www.google.com.
- 3 Sign in to the Google website with your Gmail™ address.
- 4 Enter your printer's IP address in the address field and press the Enter key or click **Go**.

5 Click **Login** in the upper right corner of the **Embedded Web Service** website.

6 If it's your first time logging into **Embedded Web Service** you need to log-in as an administrator. Type in the below default **ID** and **Password**. We recommend you to change the default password for security reasons.

- **ID: admin**
- **Password: dell00000**



If the network environment is using a proxy server, you need to configure the proxy's IP and port number from **Settings > Network Settings > Google Cloud Print > Proxy Setting**. Contact your network service provider or network administrator for more information.

7 When the **Embedded Web Service** window opens, click **Settings > Network Settings > Google Cloud Print**.

8 Enter your printer's name and description.

9 Click **Register**.
The confirmation pop-up window appears.



If you set the browser to block pop-ups, the confirmation window will not appear. Allow the site to show pop-ups.

Google Cloud Print™

10 Click **Finish printer registration**.

11 Click **Manage your printers**.

Now your printer is registered with Google Cloud Print™ service.

Google Cloud Print™-ready devices will appear in the list.

Printing with Google Cloud Print™

The printing procedure varies depending on the application or the device you are using. You can see the application list that supports Google Cloud Print™ service.

To share your printer with your freinds, please refer to the following web site.
<http://support.google.com/chromeos/bin/answer.py?hl=en&answer=124106>



Make sure the printer is turned on and connected to a wired or wireless network that has access to the Internet.

Printing from an application on mobile device

The following steps are an example of using the Google Docs™ app from Android mobile phone.

1 Install the Cloud Print application on your mobile device.



If you do not have the application, download it from the application store such as Android Market or App Store.

2 Access the Google Docs™ application from your mobile device and tap on the  icon to select document.

3 Tap the option  button of the document that you want to print.

4 Tap the send  button.

5 Tap the Cloud Print  button.

6 Set the printing options if you want.

7 Tap **Click here to Print**.

Printing from the Chrome browser

The following steps are an example of using the Chrome browser.

- 1 Run Chrome.
- 2 Open the document or email that you want to print.
- 3 Click the wrench icon  in the browser's top right corner.
- 4 Click **Print**. A new tab for printing appears.
- 5 Select **Print with Google Cloud Print**.
- 6 Click the **Print** button.



3. Useful management tools

This chapter introduces management tools provided to help you make full use of your machine.

- **Using Firmware Update Utility** 93
- **Using Dell Supplies Ordering Utility** 94
- **Using Embedded Web Service** 95
- **Using Dell Printer Manager** 97
- **Using Dell Printer Status** 99
- **Using the Linux Unified Driver Configurator** 101

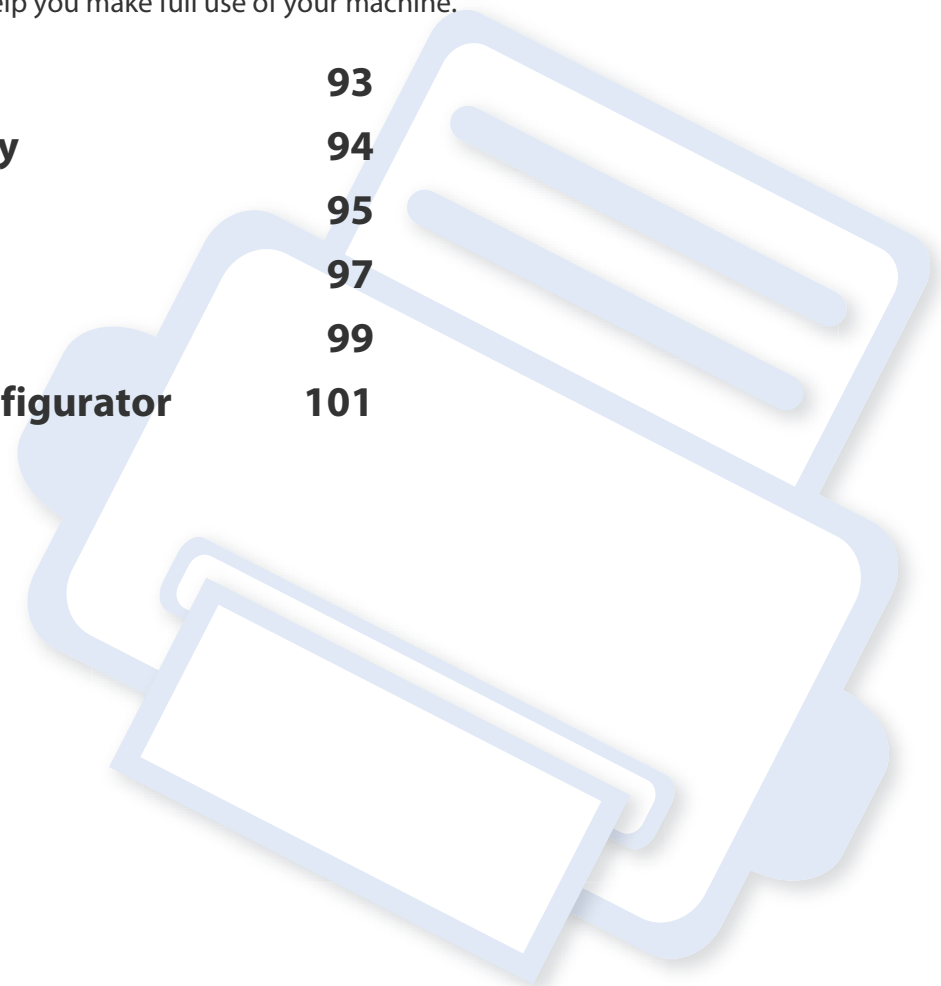

Using Firmware Update Utility

Firmware Update Utility allows you to maintain your machine by upgrading firmware.

5 Click **Update Firmware**.



Available for Windows OS users only.

- 1 From the **Start** menu, select **Programs** or **All Programs** > **Dell** > **Dell Printers** > **your printer driver name** > **Firmware Update Utility**.
- 2 Download the latest firmware. Click <http://www.support.dell.com>.
- 3 If your printer is connected with an USB cable, click **USB Connected Printer** or **Network Connected Printer**.

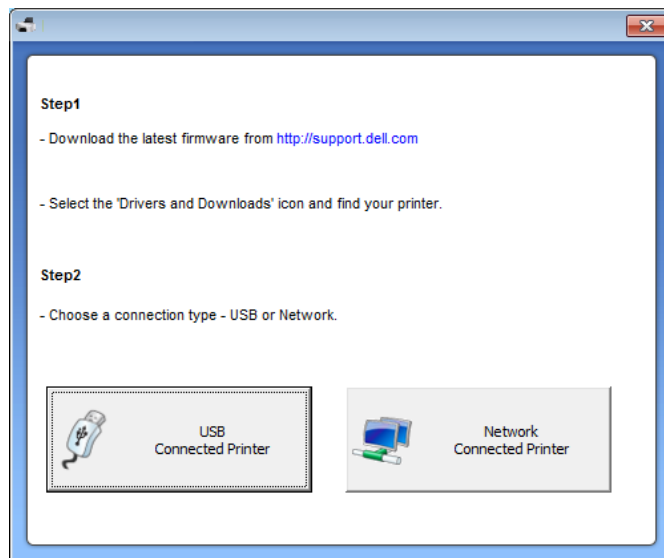

- 4 Click **Browse** and select the downloaded firmware file.

Using Dell Supplies Ordering Utility

To order replacement toner cartridges or supplies from Dell:



Available for Windows or Macintosh OS users only.

1 Double-click the **Dell Supplies Ordering Utility** icon on your desktop.



OR

From the **Start** menu, select **Programs** or **All Programs** > **Dell** > **Dell Printers** > **your printer driver name** > **Dell Supplies Ordering Utility**.



For Macintosh,

Open the **Applications** folder > **Dell** folder > **Dell Supplies Ordering Utility**.

2 The **Dell Supplies Ordering Utility** window opens.

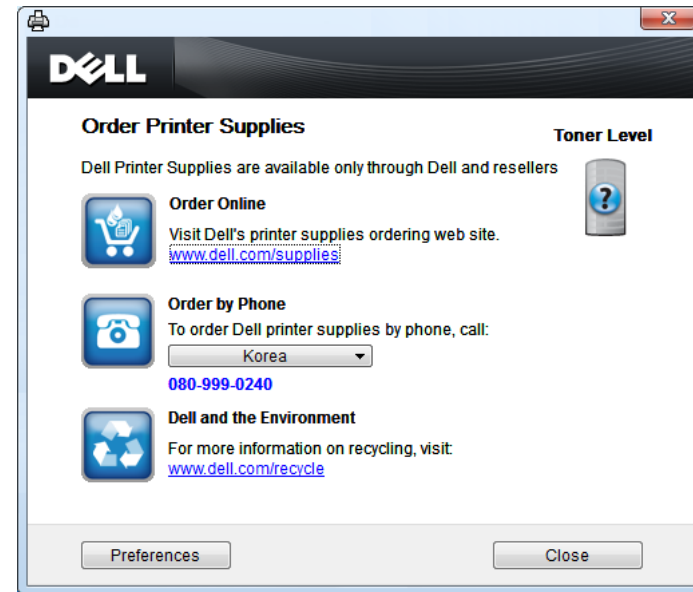

Using Embedded Web Service



- Internet Explorer 6.0 or higher is the minimum requirement for Embedded Web Service.
- Embedded Web Service explanation in this user's guide may differ from your machine depending on its options or models.
- Network model only.

Accessing Embedded Web Service

- 1 Access a web browser, such as Internet Explorer, from Windows.
Enter the machine IP address of your printer (<http://xxx.xxx.xxx.xxx>) in the address field and press the Enter key or click **Go**.
- 2 Your machine's embedded website opens.

Logging into Embedded Web Service

Before configuring options in Embedded Web Service, you need to log-in as an administrator. You can still use Embedded Web Service without logging in but you won't have access to **Settings** tab and **Security** tab.

- 1 Click **Login** on the upper right of the Embedded Web Service website.
- 2 Type in the **ID** and **Password** then click **Login**.
 - **ID: admin**
 - **Password: dell00000**

Embedded Web Service overview



Information

Settings

Security

Maintenance



Some tabs may not appear depending on your model.

Information tab

This tab gives you general information about your machine. You can check things, such as remaining amount of toner. You can also print reports, such as an error report.

- **Active Alerts:** Shows the alerts that have occurred in the machine and their severity.
- **Supplies:** Shows how many pages are printed and amount of toner left in the cartridge.

Using Embedded Web Service

- **Usage Counters:** Shows the usage count by print types: simplex and duplex.
- **Current Settings:** Shows the machine's and network's information.
- **Print information:** Prints reports such as system related reports and font reports.

Settings tab

This tab allows you to set configurations provided by your machine and network. You need to log-in as an administrator to view this tab.

- **Machine Settings** tab: Sets options provided by your machine.
- **Network Settings** tab: Shows options for the network environment. Sets options such as TCP/IP and network protocols.

Security tab

This tab allows you to set system and network security information. You need to log-in as an administrator to view this tab.

- **System Security:** Sets the system administrator's information and also enables or disables machine features.
- **Network Security:** IPv4/IPv6 filtering.

Maintenance tab

This tab allows you to maintain your machine by upgrading firmware and setting contact information for sending emails. You can also connect to Dell website or download drivers by selecting the **Link** menu.

- **Firmware Upgrade:** Upgrade your machine's firmware.
- **Contact Information:** Shows the contact information.
- **Link:** Shows links to useful sites where you can download or check information.

Using Dell Printer Manager

Dell Printer Manager is an application that combines Dell machine settings into one location. Dell Printer Manager combines device settings as well as printing environments, settings/actions and launching. All of these features provide a gateway to conveniently use your Dell machine. Dell Printer Manager provides two different user interfaces for the user to choose from: the basic user interface and the advanced user interface. Switching between the two interfaces is easy: just click  button.



- Available for Windows or Macintosh OS users only.
- For Windows, Internet Explorer 6.0 or higher is the minimum requirement for Dell Printer Manager.

Understanding Dell Printer Manager

To open the program:

For Windows,

Select **Start > Programs** or **All Programs > Dell > Dell Printers > Dell Printer Manager > Dell Printer Manager**.

For Macintosh,

Open the **Applications** folder > **Dell** folder > **Dell Printer Manager**.

The Dell Printer Manager interface is comprised of various basic sections as described in the table that follows:



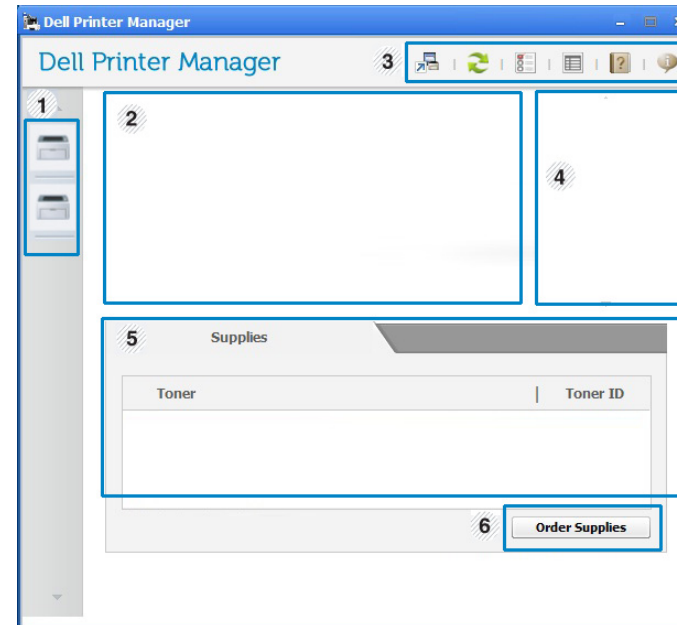

The screenshot may differ depending on operating system you are using.



1	Printer List	The printer list displays the installed printer icons on your computer.
2	Printer Information	This area gives you general information about your machine. You can check information, such as the machine's model name, IP address (or Port name), and machine status.  User's Guide button: View User's Guide.

Using Dell Printer Manager

3	Application information	Includes links for changing to the advanced settings, preference, help, and about.  The  button is used to change the user interface to the advanced settings user interface.
4	Quick links	Displays Quick links to machine specific functions. This section also includes links to applications in the advanced settings.  If you connect your machine to a network, the Embedded Web Service icon is enabled.
5	Contents Area	Displays information about the selected machine, remaining toner level, and paper. The information will vary based on the machine selected. Some machines do not have this feature.
6	Order Supplies	Click on the Order button from the supply ordering window. You can order replacement toner cartridge(s) from online.



Click the **Help** (?) button from the upper-right corner of the window and click on any option you want to know about.

Advanced settings user interface overview

The advanced user interface is intended to be used by the person responsible for managing the network and machines.

Device Settings

You can configure various machine settings such as machine setup, paper, layout, emulation, network, and print information.

Alert Settings (Windows only)

This menu includes settings related to error alerting.

- **Printer Alert:** Provides settings related to when alerts will be received.
- **Email Alert:** Provides options relating to receiving alerts via email.
- **History Alert:** Provides a history of device and toner related alerts.

Using Dell Printer Status

The Dell Printer Status displays the status of the printer that is connected to the local network. Printer Ready, Printer Offline, Error-Check Printer, and the toner level or Toner Low alerts will for your printer.



- Available for Windows users.
- The Dell Printer Status window and its contents shown in this user's guide may differ depending on the machine or operating system in use.
- Check the operating system(s) that are compatible with your machine (see "System requirements" on page 61).

Dell Printer Status overview

If an error occurs while operating, you can check the error from the Dell Printer Status. Dell Printer Status is installed automatically when you install the machine software.

For Windows,

From the **Start** menu, select **Programs** or **All Programs** > **Dell** > **Dell Printers** > **your printer driver name** > **Dell Printer Status**.

You can also launch Dell Printer Status manually. Go to the **Printing Preferences**, click the **Basic** tab > **Printer Status** button.

These icons appear on the Windows task bar:

Icon	Mean	Description
	Normal	The machine is in ready mode and experiencing no errors or warnings.
	Warning	The machine is in a state where an error might occur in the future. For example, it might be in toner low status, which may lead to toner empty status.
	Error	The machine has at least one error.

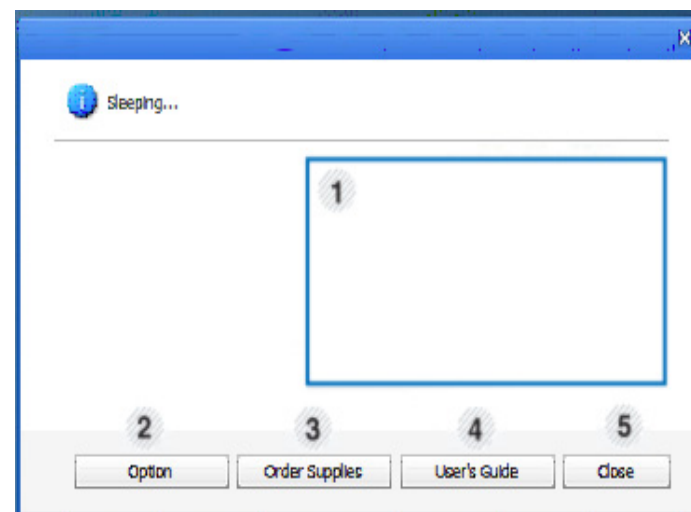

1	Toner Level	You can view the level of toner remaining in each toner cartridge. The machine and the number of toner cartridge(s) shown in the above window may differ depending on the machine in use. Some machines do not have this feature.
---	--------------------	---

Using Dell Printer Status

2	Option	You can set printing job alert related settings.
3	Order Supplies	You can order replacement toner cartridge(s) from online.
4	User's Guide	You can view the online User's Guide.
5	Close	Close the window.

Changing the Dell Printer Status Program Settings

Right-click the Dell Printer Status icon and select **Options**. Select the settings you want from the **Options** window.

Using the Linux Unified Driver Configurator

The Unified Driver Configurator is a tool primarily intended for configuring machine devices. You need to install Unified Linux Driver to use Unified Driver Configurator (see "Installation for Linux" on page 74).

After the driver is installed on your Linux system, the Unified Driver Configurator icon will automatically be created on your desktop.

Opening Unified Driver Configurator

- 1 Double-click the **Unified Driver Configurator** on the desktop. You can also click the **Startup** Menu icon and select **Dell Unified Driver > Unified Driver Configurator**.
- 2 Click each button on the left to switch to the corresponding configuration window.

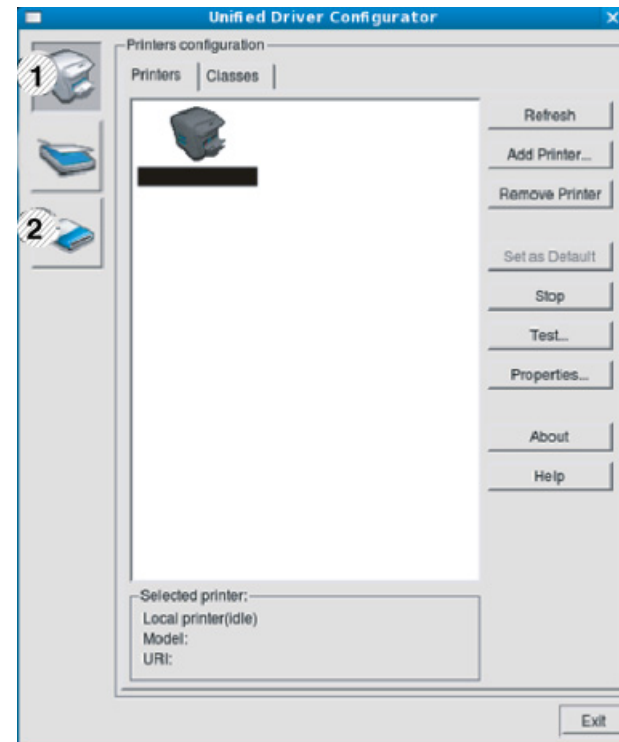

- 1 **Printer Configuration**
- 2 **Port Configuration**

Using the Linux Unified Driver Configurator



To use the on screen help, click **Help**.

- 3 After changing the configurations, click **Exit** to close the **Unified Driver Configurator**.

Printers configuration

Printers configuration has the two tabs: **Printers** and **Classes**.

Printers tab

View the current system's printer configuration by clicking on the machine icon button on the left side of the **Unified Driver Configurator** window.

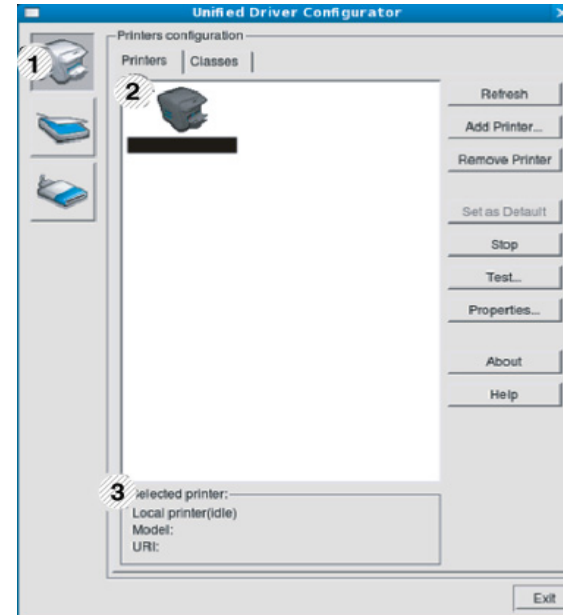

- | | |
|---|--|
| 1 | Switches to Printers configuration . |
| 2 | Shows all of the installed machines. |
| 3 | Shows the status, model name, and URI of your machine. |

The printer control buttons are, as follows:

- **Refresh:** Renews the available machines list.
- **Add Printer:** Allows you to add a new machines.

Using the Linux Unified Driver Configurator

- **Remove Printer:** Removes the selected machine.
- **Set as Default:** Sets the current selected machine as a default machine.
- **Stop/Start:** Stops/starts the machine.
- **Test:** Allows you to print a test page to ensure the machine is working properly.
- **Properties:** Allows you to view and change the printer's properties.

1	Shows all of the machine classes.
2	Shows the status of the class and the number of machines in the class.

- **Refresh:** Renews the classes list.
- **Add Class:** Allows you to add a new machine class.
- **Remove Class:** Removes the selected machine class.

Classes tab

The Classes tab shows a list of available machine classes.

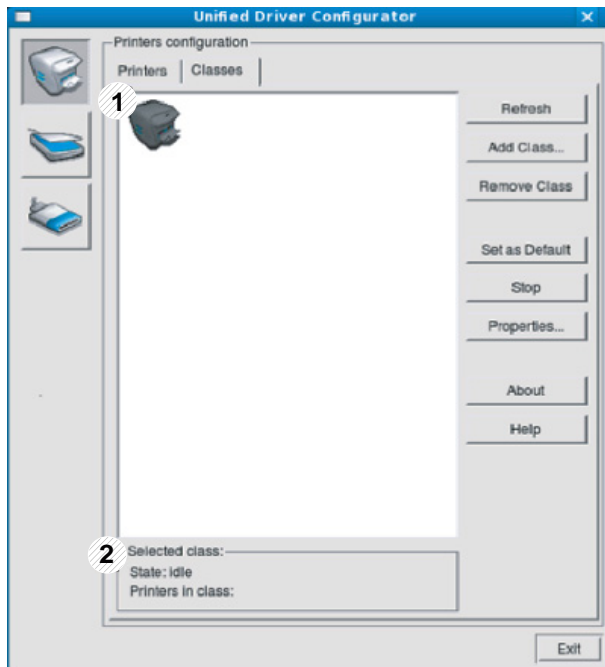

Using the Linux Unified Driver Configurator

Ports configuration

In this window, you can view the list of available ports, check the status of each port and release a port that is stalled in a busy state when its owner has terminated the job for any reason.

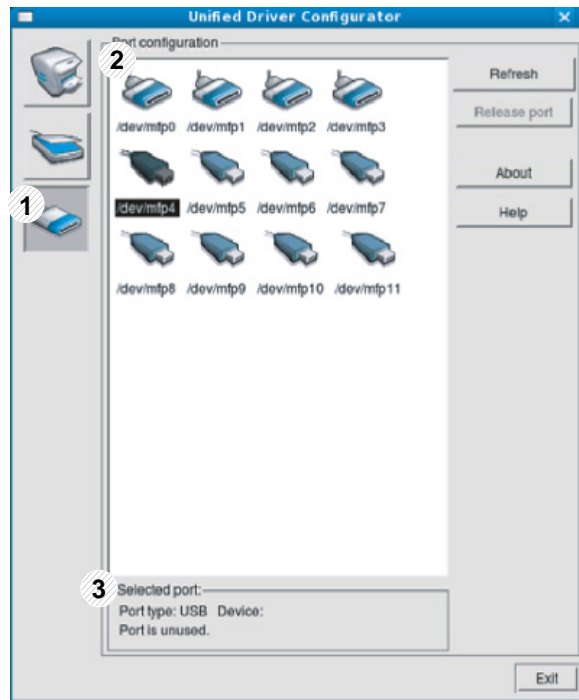

1	Switches to Ports configuration .
2	Shows all of the available ports.
3	Shows the port type, device connected to the port, and status.

- **Refresh:** Renews the available ports list.
- **Release port:** Releases the selected port.



4. Special features

This chapter explains special printing features.

- **Altitude adjustment** 106
- **Changing the default print settings** 107
- **Setting your machine as a default machine** 108
- **Using advanced print features** 109
- **Macintosh printing** 115
- **Linux printing** 117
- **Unix printing** 119





The procedures in this chapter are mainly based on Windows 7.

Altitude adjustment

Print quality is affected by atmospheric pressure, which is determined by the height of the machine above sea level. The following information will guide you on how to set your machine for the best print quality.

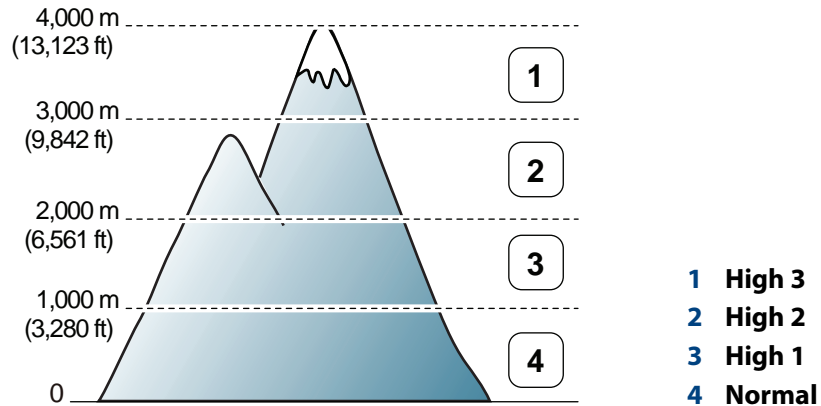
Before you set the altitude value, determine the altitude where you are.



- For Windows and Macintosh users, you set from **Dell Printer Manager** >  **(Switch to advanced mode)** > **Device Settings** (see "Advanced settings user interface overview" on page 98).



- If your machine is connected to the network, you can set the altitude via Embedded Web Service (see "Using Embedded Web Service" on page 95).

Changing the default print settings

- 1 Click the Windows **Start** menu.
- 2 For Windows Server 2000, select **Settings > Printers**.
 - For Windows XP/Server 2003, select **Printer and Faxes**.
 - For Windows Server 2008/Vista, select **Control Panel > Hardware and Sound > Printers**.
 - For Windows 7, select **Control Panel > Devices and Printers**.
 - For Windows Server 2008 R2, select **Control Panel > Hardware > Devices and Printers**.
- 3 Right-click on your machine.
- 4 For Windows XP/Server 2003/Server 2008/Vista, select **Printing Preferences**.
For Windows 7 or Windows Server 2008 R2, from context menus, select **Printing preferences**.
- 5 Change the settings on each tab.
- 6 Click **OK**.



If you want to change the settings for each print job, change it in **Printing Preferences**.



If **Printing preferences** has a ?, you can select other printer drivers connected to the selected printer.

Setting your machine as a default machine

- 1 Click the Windows **Start** menu.
- 2 For Windows Server 2000, select **Settings > Printers**.
 - For Windows XP/Server 2003, select **Printer and Faxes**.
 - For Windows Server 2008/Vista, select **Control Panel > Hardware and Sound > Printers**.
 - For Windows 7, select **Control Panel > Devices and Printers**.
 - For Windows Server 2008 R2, select **Control Panel > Hardware > Devices and Printers**.
- 3 Select your machine.
- 4 Right-click your machine and select **Set as Default Printer**.



For Windows 7 or Windows Server 2008 R2, if **Set as default printer** has a ?, you can select other printer drivers connected to the selected printer.

Using advanced print features



XPS printer driver: used to print XPS file format.

- The XPS printer driver can be installed only on Windows Vista OS or higher.
- You can install the XPS printer driver when you insert the software CD into your CD-ROM drive. When you install the Dell software, the XPS printer driver is automatically installed.

3

Type in the destination path and the file name, and then click **OK**.

For example, **c:\Temp\file name**.



If you type in only the file name, the file is automatically saved in **My Documents, Documents and Settings, or Users**. The saved folder may differ, depending on your operating system or the application you are using.

Printing to a file (PRN)

You will sometimes need to save the print data as a file.

1

Check the **Print to file** box in the **Print** window.

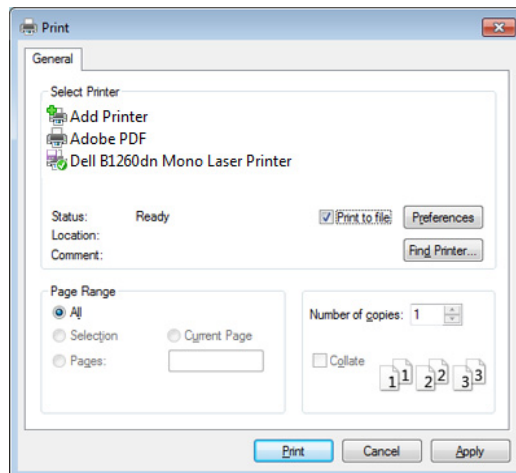

2

Click **Print**.

Understanding special printer features

You can use advanced printing features when using your machine.





To take advantage of the printer features provided by your printer driver, click **Properties** or **Preferences** in the application's **Print** window to change the print settings. The machine name, that appears in the printer properties window may differ depending on the machine in use.

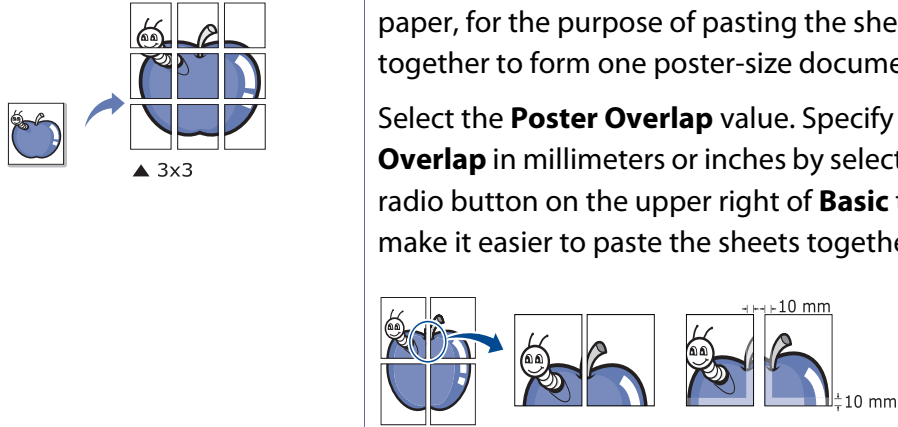

- Some menus may not appear on the display depending on options or models. If so, it is not applicable to your machine.
- Select the **Help** or click the  button from the window or press **F1** on your keyboard and click on any option you want to know about (see "Using help" on page 35).



Using advanced print features

Item	Description
<p data-bbox="49 288 383 323">Multiple Pages per Side</p> 	<p data-bbox="427 288 1059 491">Selects the number of pages to print on a single sheet of paper. To print more than one page per sheet, the pages will be reduced in size and arranged in the order you specify. You can print up to 16 pages on one sheet.</p>
<p data-bbox="49 571 264 606">Poster Printing</p> 	<p data-bbox="427 571 1048 727">Prints a single-page document onto 4 (Poster 2x2), 9 (Poster 3x3), or 16 (Poster 4x4) sheets of paper, for the purpose of pasting the sheets together to form one poster-size document.</p> <p data-bbox="427 751 1052 908">Select the Poster Overlap value. Specify Poster Overlap in millimeters or inches by selecting the radio button on the upper right of Basic tab to make it easier to paste the sheets together.</p>

Item	Description
<p data-bbox="1153 272 1406 308">Booklet Printing^a</p> 	<p data-bbox="1538 272 2168 429">Prints your document on both sides of a sheet of paper and arranges the pages so that the paper can be folded in half after printing to produce a booklet.</p> <p data-bbox="1538 453 2168 568">If you want to make a booklet, you need to print on Letter, Legal, A4, US Folio, or Oficio sized print media.</p> <div data-bbox="1547 619 2168 1088" style="border: 1px solid #ccc; padding: 10px; margin-top: 10px;"> <p data-bbox="1556 647 2130 850">  The Booklet Printing option is not available for all paper sizes. Select the available paper Size option under the Paper tab to see what paper sizes are available. </p> <p data-bbox="1637 879 2130 1042"> If you select an unavailable paper size, this option can be automatically canceled. Select only available paper (paper without  or  mark). </p> </div>

Using advanced print features

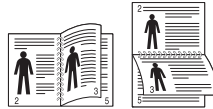
Item	Description
Double-sided Printing	<p>Print on both sides of a sheet of paper (duplex). Before printing, decide how you want your document oriented.</p> <div><ul style="list-style-type: none">You can use this feature with Letter, Legal, A4, US Folio or Oficio sized paperIf your machine does not have a duplex unit, you should complete the printing job manually. The machine prints every other page of the document first. After that, a message appears on your computer.We recommend not to print on both sides of the special media, such as labels, envelopes, or thick paper. It may cause a paper jam or damage the machine.</div>

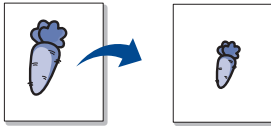

Item	Description
Double-sided Printing	<ul style="list-style-type: none">Printer Default: If you select this option, this feature is determined by the settings you have selected on the control panel of the machine. This option is available only when you use the PCL/XPS printer driver.None: Disables this feature.Long Edge: This option is the conventional layout used in bookbinding. Short Edge: This option is the conventional layout used in calendars. Reverse Double-Sided Printing: Check this option to reverse the print order when duplex printing.
Paper Options 	Changes the size of a document to appear larger or smaller on the printed page by entering in a percentage by which to enlarge or decrease the document.

Using advanced print features

Item	Description
Watermark 	<p>The watermark option allows you to print text over an existing document. For example, you use it when you want to have large gray letters reading “DRAFT” or “CONFIDENTIAL” printed diagonally across the first page or all pages of a document.</p>
Watermark (Creating a watermark)	<ol style="list-style-type: none"> To change the print settings from your software application, access Printing Preferences. Click the Advanced tab, select Edit from the Watermark drop-down list. The Edit Watermarks window appears. Enter a text message in the Watermark Message box. You can enter up to 256 characters. The message displays in the preview window.
Watermark (Editing a watermark)	<ol style="list-style-type: none"> To change the print settings from your software application, access Printing Preferences. Click the Advanced tab, select Edit from the Watermark drop-down list. The Edit Watermarks window appears. Select the watermark you want to edit from the Current Watermarks list and change the watermark message and options. Click Update to save the changes. Click OK or Print until you exit the Print window.

Item	Description
Watermark (Deleting a watermark)	<ol style="list-style-type: none"> To change the print settings from your software application, access Printing Preferences. Click the Advanced tab, select Edit from the Watermark drop-down list. The Edit Watermarks window appears. Select the watermark you want to delete from the Current Watermarks list and click Delete. Click OK or Print until you exit the Print window.

Using advanced print features

Item	Description
<p data-bbox="53 277 174 309">Overlay^a</p> 	<p data-bbox="430 272 1050 344">This option is available only when you use the SPL printer driver (see "Software" on page 6).</p> <p data-bbox="430 368 1050 483">An overlay is text and/or images stored in the computer hard disk drive (HDD) as a special file format that can be printed on any document.</p> <p data-bbox="430 496 1050 815">Overlays are often used to take the place of letterhead paper. Rather than using preprinted letterhead, you can create an overlay containing exactly the same information that is currently on your letterhead. To print a letter with your company's letterhead, you do not need to load preprinted letterhead paper in the machine: just print the letterhead overlay on your document.</p> <p data-bbox="430 839 1050 911">To use a page overlay, you must create a new page overlay containing your logo or image.</p> <div data-bbox="430 963 1059 1362"><ul data-bbox="533 994 1050 1310" style="list-style-type: none"><li data-bbox="533 994 1050 1142">• The overlay document size must be the same as the document you print with the overlay. Do not create an overlay with a watermark.<li data-bbox="533 1161 1050 1310">• The resolution of the overlay document must be the same as that of the document you will print with the overlay.</div>

Item	Description
<p data-bbox="1158 272 1458 400">Overlay (Creating a new page overlay)</p>	<ol data-bbox="1543 272 2163 919" style="list-style-type: none"><li data-bbox="1543 272 2163 344">a To save the document as an overlay, access Printing Preferences.<li data-bbox="1543 352 2163 467">b Click the Advanced tab, and select Edit from the Text drop-down list. Edit Overlay window appears.<li data-bbox="1543 475 2163 515">c In the Edit Overlay window, click Create.<li data-bbox="1543 523 2163 671">d In the Save As window, type a name up to eight characters in the File name box. Select the destination path, if necessary (The default is C:\Formover).<li data-bbox="1543 679 2163 751">e Click Save. The name appears on the Overlay List.<li data-bbox="1543 759 2163 919">f Click OK or Print until you exit the Print window. The file is not printed. Instead, it is stored on your computer hard disk drive.

Using advanced print features

Item	Description
Overlay (Using a page overlay)	<p>a Click the Advanced tab.</p> <p>b Select the desired overlay from the Text drop-down list.</p> <p>c If the overlay file you want does not appear in the Text drop-down list, select Edit... from the list and click Load. Select the overlay file you want to use.</p> <p>If you have stored the overlay file you want to use in an external source, you can also load the file when you access the Open window.</p> <p>After you select the file, click Open. The file appears in the Overlay List box and is available for printing. Select the overlay from the Overlay List box.</p> <p>d If necessary, check Confirm Page Overlay When Printing box. If this box is checked, a message window appears each time you submit a document for printing, asking you to confirm printing an overlay on your document.</p> <p>If this box is not checked and an overlay has been selected, the overlay automatically prints with your document.</p> <p>e Click OK or Print until you exit the Print window.</p>

Item	Description
Overlay (Deleting a page overlay)	<p>a In the Printing Preferences window, click the Advanced tab.</p> <p>b Select Edit in the Text drop down list.</p> <p>c Select the overlay you want to delete from the Overlay List box.</p> <p>d Click Delete.</p> <p>e When a confirming message window appears, click Yes.</p> <p>f Click OK or Print until you exit the Print window. You can delete page overlays that you no longer use.</p>

a. This option is not available when you use XPS driver.

Macintosh printing



Some features may not be available depending on models or options. It means that the features are not supported.

Printing a document

When you print with a Macintosh, you need to check the printer driver settings in each application you use. Follow the steps below to print from a Macintosh:

- 1 Open the document to print.
- 2 Open the **File** menu and click **Page Setup** (**Document Setup** in some applications).
- 3 Choose your paper size, orientation, scaling, other options, and make sure that your machine is selected. Click **OK**.
- 4 Open the **File** menu and click **Print**.
- 5 Choose the number of copies and indicate which pages to print.
- 6 Click **Print**.

Changing printer settings

You can use advanced printing features when using your machine.

Open an application and select **Print** from the **File** menu. The machine name, which appears in the printer properties window, may differ depending on the machine in use. Except for the name, the composition of the printer properties window is similar to the following.

Printing multiple pages on one sheet

You can print more than one page on a single sheet of paper. This feature provides a cost-effective way to print draft copies.

- 1 Open an application, and select **Print** from the **File** menu.
- 2 Select **Layout** from the drop-down list under **Orientation**. In the **Pages per Sheet** drop-down list, select the number of pages you want to print on one sheet of paper.
- 3 Select the other options to use.
- 4 Click **Print**.
The machine prints the selected number of pages to print on one sheet of paper.

Macintosh printing

Printing on both sides of the paper



Some features may not be available depending on models or options. It means that the features are not supported.

Before printing in the duplex mode, decide on which edge you will be binding your finished document. The binding options are, as follows:

- **Long-Edge Binding:** This option is the conventional layout used in book binding.
- **Short-Edge Binding:** This option is the type often used with calendars.

- 1 From your Macintosh application, select **Print** from the **File** menu.
- 2 Select **Layout** from the drop-down list under **Orientation**.
- 3 Select a binding orientation from the **Two-Sided** option.
- 4 Select the other options to use.
- 5 Click **Print** and the machine prints on both sides of the paper.



If you print more than 2 copies, the first copy and the second copy might print on the same sheet of paper. Avoid printing on both sides of paper when you are printing more than 1 copy.

Using help

Click the question mark on the bottom-left corner of the window and click on the topic you want to know about. A pop-up window appears with information about that option's feature, which is provided from the driver.

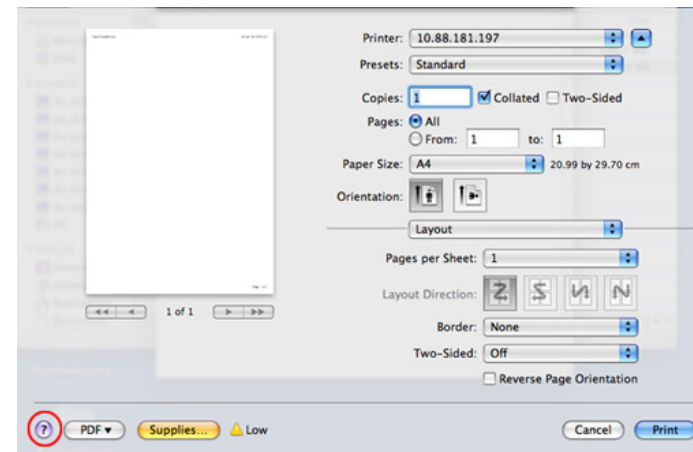

Linux printing



Some features may not be available depending on models or options. It means that the features are not supported.

Printing from applications

There are a lot of Linux applications that allow you to print using Common UNIX Printing System (CUPS). You can print on your machine from any such application.

- 1 Open an application, and select **Print** from the **File** menu
- 2 Select **Print** directly using `lpr`.
- 3 In the LPR GUI window, select the model name of your machine from the printer list and click **Properties**.

4 Change the print job properties using the following four tabs displayed at the top of the window.

- **General:** Changes the paper size, the paper type, and the orientation of the documents. It enables the duplex feature, adds start and end banners, and changes the number of pages per sheet.



Automatic/manual duplex printing may not be available depending on models. You can alternatively use the `lpr` printing system or other applications for odd-even printing.

- **Text:** Specifies the page margins and set the text options, such as spacing or columns.
- **Graphics:** Sets image options that are used when printing image files, such as color options, image size, or image position.
- **Advanced:** Sets the print resolution, paper source, and destination.

5 Click **Apply** to apply the changes and close the **Properties** window.

6 Click **OK** in the **LPR GUI** window to start printing.

7 The Printing window appears, allowing you to monitor the status of your print job.

To abort the current job, click **Cancel**.

Linux printing

Printing files

You can print many different types of files on your machine using the standard CUPS, directly from the command line interface. The CUPS lpr utility allows you to do that, but the driver's package replaces the standard lpr tool by a much more user-friendly LPR GUI program.

To print any document file:

- 1 Enter `lpr <file_name>` from the Linux shell command line and press Enter. The **LPR GUI** window appears.

When you type only `lpr` and press **Enter**, the **Select file(s) to print** window appears first. Just select any files you want to print and click **Open**.

- 2 In the **LPR GUI** window, select your machine from the list, and change the print job properties.
- 3 Click **OK** to start printing.

Configuring Printer Properties

Using the **Printer Properties** window provided by the **Printers configuration**, you can change the various properties for your machine as a printer.

- 1 Open the **Unified Driver Configurator**.
If necessary, switch to **Printers configuration**.
- 2 Select your machine on the available printers list and click **Properties**.
- 3 The **Printer Properties** window appears.
The following five tabs display at the top of the window:
 - **General:** Allows you to change the printer location and name. The name entered in this tab displays on the printer list in **Printers configuration**.
 - **Connection:** Allows you to view or select another port. If you change the machine port from USB to parallel or vice versa while in use, you must re-configure the machine port in this tab.
 - **Driver:** Allows you to view or select another machine driver. By clicking **Options**, you can set the default device options.
 - **Jobs:** Shows the list of print jobs. Click **Cancel job** to cancel the selected job and select the **Show completed jobs** check box to see previous jobs on the job list.
 - **Classes:** Shows the class that your machine is in. Click **Add to Class** to add your machine to a specific class or click **Remove from Class** to remove the machine from the selected class.
- 4 Click **OK** to apply the changes and close the **Printer Properties** window.

Unix printing



Some features may not be available depending on models or options. It means that the features are not supported.

Proceeding the print job

After installing the printer, choose any of the image, text, PS files to print.

- 1 Execute "**printui <file_name_to_print>**" command.
For example, if you are printing "**document1**"
printui document1
This will open the UNIX Printer Driver **Print Job Manager** in which the user can select various print options.
- 2 Select a printer that has been already added.
- 3 Select the printing options from the window such as **Page Selection**.
- 4 Select how many copies are needed in **Number of Copies**.



To take advantage of the printer features provided by your printer driver, press **Properties** (see "Changing printer settings" on page 115).

- 5 Press **OK** to start the print job.

Changing the machine settings

The UNIX printer driver **Print Job Manager** in which the user can select various print options in printer **Properties**.

The following hot keys may also be used: "H" for **Help**, "O" for **OK**, "A" for **Apply**, and "C" for **Cancel**.

General tab

- **Paper Size:** Set the paper size as A4, Letter, or other paper sizes, according to your requirements.
- **Paper Type:** Choose the type of the paper. Options available in the list box are **Printer Default**, **Plain**, and **Thick**.
- **Paper Source:** Select from which tray the paper is used. By default, it is **Auto Selection**.
- **Orientation:** Select the direction in which information is printed on a page.
- **Duplex:** Print on both sides of paper to save paper.



Automatic/manual duplex printing may not be available depending on models. You can alternatively use the lpr printing system or other applications for odd-even printing.

- **Multiple pages:** Print several pages on one side of the paper.

Unix printing

- **Page Border:** Choose any of the border styles (e.g., **Single-line hairline**, **Double-line hairline**)

Image tab

In this tab, you can change the brightness, resolution, or image position of your document.

Text tab

Set the character margin, line space, or the columns of the actual print output.

Margins tab

- **Use Margins:** Set the margins for the document. By default, margins are not enabled. The user can change the margin settings by changing the values in the respective fields. Set by default, these values depend on the page size selected.
- **Unit:** Change the units to points, inches, or centimeters.

Printer-Specific Settings tab

Select various options in the **JCL** and **General** frames to customize various settings. These options are specific to the printer and depend on the PPD file.



5. Troubleshooting

This chapter gives helpful information for what to do if you encounter an error.

- **Paper feeding problems** 122
- **Power and cable connecting problems** 123
- **Printing problems** 124
- **Printing quality problems** 127
- **Operating system problems** 134



Paper feeding problems

Condition	Suggested solutions
Paper jams during printing.	Clear the paper jam.
Paper sticks together.	<ul style="list-style-type: none">• Check the maximum paper capacity of the tray .• Make sure that you are using the correct type of paper.• Remove paper from the tray and flex or fan the paper.• Humid conditions may cause some paper to stick together.
Multiple sheets of paper do not feed.	Different types of paper may be stacked in the tray. Load paper of only one type, size, and weight.
Paper does not feed into the machine.	<ul style="list-style-type: none">• Remove any obstructions from inside the machine.• Paper has not been loaded correctly. Remove paper from the tray and reload it correctly.• There is too much paper in the tray. Remove excess paper from the tray.• The paper is too thick. Use only paper that meets the specifications required by the machine.
The paper keeps jamming.	<ul style="list-style-type: none">• There is too much paper in the tray. Remove excess paper from the tray. If you are printing on special materials, use the multi-purpose tray (or manual feeder).• An incorrect type of paper is being used. Use only paper that meets the specifications required by the machine.• There may be debris inside the machine. Open the front cover and remove any debris.
Transparencies stick together in the paper exit.	Use only transparencies specifically designed for laser printers. Remove each transparency as it exits from the machine.
Envelopes skew or fail to feed correctly.	Ensure that the paper guides are against both sides of the envelopes.

Power and cable connecting problems

Condition	Suggested solutions
The machine is not receiving power, or the connection cable between the computer and the machine is not connected properly.	<ul style="list-style-type: none"><li data-bbox="651 309 2197 341">• Connect the machine to the electricity supply first and press the  (Power) button on the control panel.<li data-bbox="651 379 2197 411">• Disconnect the machine's cable and reconnect it.

Printing problems

Condition	Possible cause	Suggested solutions
The machine does not print.	The machine is not receiving power.	Check the power cord connections. Check the power switch and the power source.
	The machine is not selected as the default machine.	Select your machine as your default machine in Windows.
	Check the machine for the following: <ul style="list-style-type: none">• The front cover is not closed. Close the front cover.• Paper is jammed. Clear the paper jam.• No paper is loaded. Load paper.• The toner cartridge is not installed. Install the toner cartridge.• Make sure the protect cover and sheets are removed from the toner cartridge. If a system error occurs, contact your service representative.	
	The connection cable between the computer and the machine is not connected properly.	Disconnect the machine cable and reconnect it.
	The connection cable between the computer and the machine is defective.	If possible, attach the cable to another computer that is working properly and print a job. You can also try using a different machine cable.
	The port setting is incorrect.	Check the Windows printer settings to make sure that the print job is sent to the correct port. If the computer has more than one port, make sure that the machine is attached to the correct one.
	The machine may be configured incorrectly.	Check the Printing Preferences to ensure that all of the print settings are correct.

Printing problems

Condition	Possible cause	Suggested solutions
The machine does not print.	The printer driver may be incorrectly installed.	Uninstall and reinstall the machine's driver.
	The machine is malfunctioning.	Check the display message on the control panel to see if the machine is indicating a system error. Contact a service representative.
	The document size is so big that the hard disk space of the computer is insufficient to access the print job.	Get more hard disk space and print the document again.
	The output tray is full.	Once the paper is removed from the output tray, the machine resumes printing.
The machine selects print materials from the wrong paper source.	The paper option that was selected in the Printing Preferences may be incorrect.	For many software applications, the paper source selection is found under the Paper tab within the Printing Preferences . Select the correct paper source. See the printer driver help screen.
A print job is extremely slow.	The job may be very complex.	Reduce the complexity of the page or try adjusting the print quality settings.
Half the page is blank.	The page orientation setting may be incorrect.	Change the page orientation in your application. See the printer driver help screen.
	The paper size and the paper size settings do not match.	Ensure that the paper size in the printer driver settings matches the paper in the tray. Or, ensure that the paper size in the printer driver settings matches the paper selection in the software application settings you use.
The machine prints, but the text is wrong, garbled, or incomplete.	The machine cable is loose or defective.	Disconnect the machine cable and reconnect. Try a print job that you have already printed successfully. If possible, attach the cable and the machine to another computer that you know works and try a print job. Finally, try a new machine cable.
	The wrong printer driver was selected.	Check the application's printer selection menu to ensure that your machine is selected.
	The software application is malfunctioning.	Try printing a job from another application.
	The operating system is malfunctioning.	Exit Windows and reboot the computer. Turn the machine off and back on again.

Printing problems

Condition	Possible cause	Suggested solutions
Pages print, but they are blank.	The toner cartridge is defective or out of toner.	Redistribute the toner, if necessary. If necessary, replace the toner cartridge.
	The file may have blank pages.	Check the file to ensure that it does not contain blank pages.
	Some parts, such as the controller or the board, may be defective.	Contact a service representative.
The machine does not print PDF files correctly. Some parts of graphics, text, or illustrations are missing.	Incompatibility between the PDF file and the Acrobat products.	Printing the PDF file as an image may enable the file to print. Turn on Print As Image from the Acrobat printing options. <div style="border: 1px solid #ccc; background-color: #f9f9f9; padding: 5px; margin-top: 10px;">  It will take longer to print when you print a PDF file as an image. </div>
The print quality of photos is not good. Images are not clear.	The resolution of the photo is very low.	Reduce the photo size. If you increase the photo size in the software application, the resolution will be reduced.
Before printing, the machine emits vapor near the output tray.	Using damp paper can cause vapor during printing.	This is not a problem. Just keep printing.
The machine does not print special-sized paper, such as billing paper.	Paper size and paper size setting do not match.	Set the correct paper size in the Custom in Paper tab in Printing Preferences .
The printed billing paper is curled.	The paper type setting does not match.	Change the printer option and try again. Go to Printing Preferences , click Paper tab, and set type to Thick .

Printing quality problems

If the inside of the machine is dirty or paper has been loaded improperly, there might be a reduction in print quality. See the table below to clear the problem.

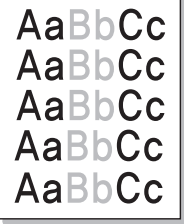
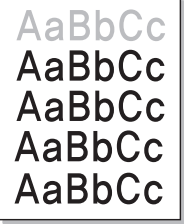
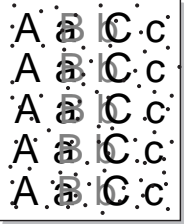
Condition	Suggested Solutions
<p>Light or faded print</p> 	<ul style="list-style-type: none">• If a vertical white streak or faded area appears on the page, the toner supply is low. Install a new toner cartridge.• The paper may not meet paper specifications; for example, the paper may be too moist or rough.• If the entire page is light, the tint is too low or the toner save mode is on. Adjust the print resolution and turn the toner save mode off. See the help screen of the printer driver.• A combination of faded or smeared defects may indicate that the toner cartridge needs cleaning. Clean the inside of your machine.• The surface of the LSU part inside the machine may be dirty. Clean the inside of your machine. If these steps do not correct the problem, contact a service representative.
<p>The top half of the paper is printed lighter than the rest of the paper</p> 	<p>The toner might not adhere properly to this type of paper.</p> <ul style="list-style-type: none">• Change the printer option and try again. Go to Printing Preferences, click the Paper tab, and set the paper type to Recycled.
<p>Toner specks</p> 	<ul style="list-style-type: none">• The paper may not meet specifications; for example, the paper may be too moist or rough.• The transfer roller may be dirty. Clean the inside of your machine.• The paper path may need cleaning. Contact a service representative.

Printing quality problems

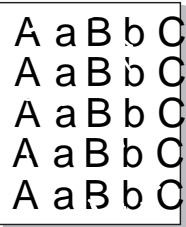
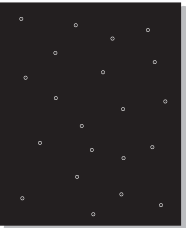
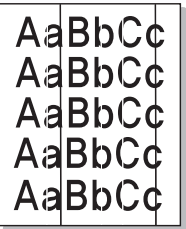
Condition	Suggested Solutions
<p>Dropouts</p> 	<p>If faded areas, generally rounded, occur randomly on the page:</p> <ul style="list-style-type: none">• A single sheet of paper may be defective. Try reprinting the job.• The moisture content of the paper is uneven or the paper has moist spots on its surface. Try a different brand of paper.• The paper lot is bad. The manufacturing processes can cause some areas to reject toner. Try a different kind or brand of paper.• Change the printer option and try again. Go to Printing Preferences, click the Paper tab, and set type to Thick or Thicker (see "Opening printing preferences" on page 34). <p>If these steps do not correct the problem, contact a service representative.</p>
<p>White Spots</p> 	<p>If white spots appear on the page:</p> <ul style="list-style-type: none">• The paper is too rough and a lot of dirt from paper falls to the inner components within the machine, so the transfer roller may be dirty. Clean the inside of your machine.• The paper path may need cleaning. Clean the inside of your machine. <p>If these steps do not correct the problem, contact a service representative.</p>
<p>Vertical lines</p> 	<p>If black vertical streaks appear on the page:</p> <ul style="list-style-type: none">• The surface (drum part) of the toner cartridge inside the machine has probably been scratched. Remove the toner cartridge and install a new one. <p>If white vertical streaks appear on the page:</p> <ul style="list-style-type: none">• The surface of the LSU part inside the machine may be dirty. Clean the inside of your machine. If these steps do not correct the problem, contact a service representative.

Printing quality problems

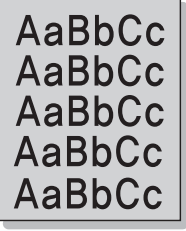
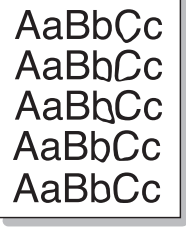
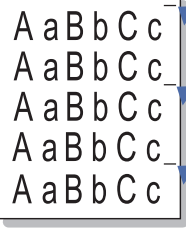
Condition	Suggested Solutions
<p>Black background</p> 	<p>If the amount of background shading becomes unacceptable:</p> <ul style="list-style-type: none">• Change to a lighter weight paper.• Check the environmental conditions: very dry conditions or a high level of humidity (higher than 80% RH) can increase the amount of background shading.• Remove the old toner cartridge and install a new one.• Thoroughly redistribute the toner (see "Redistributing toner" on page 42).
<p>Toner smear</p> 	<ul style="list-style-type: none">• Clean the inside of the machine.• Check the paper type and quality.• Remove the toner cartridge and install a new one.
<p>Vertical repetitive defects</p> 	<p>If marks repeatedly appear on the printed side of the page at even intervals:</p> <ul style="list-style-type: none">• The toner cartridge may be damaged. If you still have the same problem, remove the toner cartridge and, install a new one.• Parts of the machine may have toner on them. If the defects occur on the back of the page, the problem will likely correct itself after a few more pages.• The fusing assembly may be damaged. Contact a service representative.

Printing quality problems

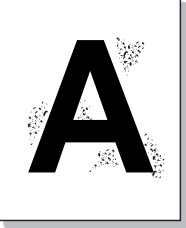
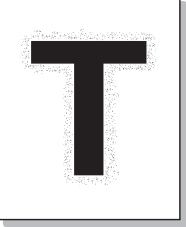
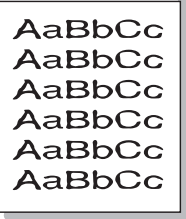
Condition	Suggested Solutions
<p data-bbox="51 261 322 293">Background scatter</p> 	<p data-bbox="506 261 1621 293">Background scatter results from bits of toner randomly distributed on the printed page.</p> <ul data-bbox="506 319 2190 708" style="list-style-type: none"><li data-bbox="506 319 2190 389">• The paper may be too damp. Try printing with a different batch of paper. Do not open packages of paper until necessary so that the paper does not absorb too much moisture.<li data-bbox="506 408 2190 523">• If background scatter occurs on an envelope, change the printing layout to avoid printing over areas that have overlapping seams on the reverse side. Printing on seams can cause problems. Or select Thick Envelope from the Printing Preferences window (see "Opening printing preferences" on page 34).<li data-bbox="506 542 2190 657">• If background scatter covers the entire surface area of a printed page, adjust the print resolution through your software application or in Printing Preferences. Ensure the correct paper type is selected. For example: If Thicker Paper is selected, but Plain Paper actually used, an overcharging can occur causing this copy quality problem.<li data-bbox="506 676 1370 708">• If you are using a new toner cartridge, redistribute the toner first.
<p data-bbox="51 740 479 810">Toner particles are around bold characters or pictures</p> 	<p data-bbox="506 740 1249 772">The toner might not adhere properly to this type of paper.</p> <ul data-bbox="506 798 2190 900" style="list-style-type: none"><li data-bbox="506 798 2190 900">• Change the printer option and try again. Go to Printing Preferences, click the Paper tab, and set the paper type to Recycled. Ensure the correct paper type is selected. For example: If Thicker Paper is selected, but Plain Paper actually used, an overcharging can occur causing this copy quality problem.
<p data-bbox="51 1117 353 1149">Misformed characters</p> 	<ul data-bbox="506 1117 2069 1149" style="list-style-type: none"><li data-bbox="506 1117 2069 1149">• If characters are improperly formed and producing hollow images, the paper stock may be too slick. Try different paper.

Printing quality problems

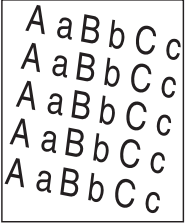
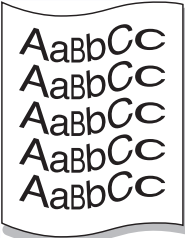
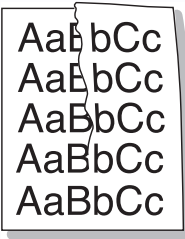
Condition	Suggested Solutions
<p data-bbox="49 261 203 293">Page skew</p> 	<ul data-bbox="506 261 1518 399" style="list-style-type: none">• Ensure that the paper is loaded properly.• Check the paper type and quality.• Ensure that the guides are not too tight or too loose against the paper stack.
<p data-bbox="49 600 226 632">Curl or wave</p> 	<ul data-bbox="506 600 1729 737" style="list-style-type: none">• Ensure that the paper is loaded properly.• Check the paper type and quality. Both high temperature and humidity can cause paper curl.• Turn the stack of paper over in the tray. Also try rotating the paper 180° in the tray.
<p data-bbox="49 948 315 979">Wrinkles or creases</p> 	<ul data-bbox="506 948 1599 1085" style="list-style-type: none">• Ensure that the paper is loaded properly.• Check the paper type and quality.• Turn the stack of paper over in the tray. Also try rotating the paper 180° in the tray.

Printing quality problems

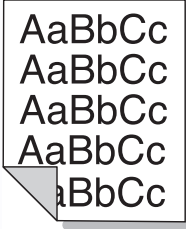
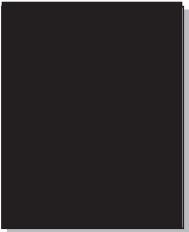
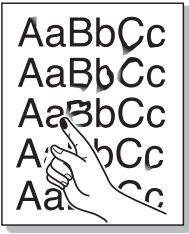
Condition	Suggested Solutions
<p data-bbox="49 261 412 293">Back of printouts are dirty</p> 	<ul data-bbox="504 261 1265 293" style="list-style-type: none">• Check for leaking toner. Clean the inside of the machine.
<p data-bbox="49 624 405 655">Solid color or black pages</p> 	<ul data-bbox="504 624 1666 762" style="list-style-type: none">• The toner cartridge may not be installed properly. Remove the cartridge and reinsert it.• The toner cartridge may be defective. Remove the toner cartridge and install a new one.• The machine may require repairing. Contact a service representative.
<p data-bbox="49 963 219 995">Loose toner</p> 	<ul data-bbox="504 963 1254 1102" style="list-style-type: none">• Clean the inside of the machine.• Check the paper type and quality.• Remove the toner cartridge and then, install a new one. <p data-bbox="504 1118 1637 1150">If the problem persists, the machine may require repair. Contact a service representative.</p>

Printing quality problems

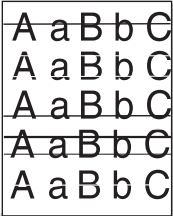
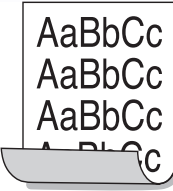
Condition	Suggested Solutions
<p data-bbox="53 261 248 288">Character voids</p> 	<p data-bbox="506 261 1469 288">Character voids are white areas within parts of characters that should be solid black:</p> <ul data-bbox="506 316 2186 451" style="list-style-type: none"><li data-bbox="506 316 2186 352">• If you are using transparencies, try another type of transparency. Because of the composition of transparencies, some character voids are normal.<li data-bbox="506 363 1621 400">• You may be printing on the wrong surface of the paper. Remove the paper and turn it around.<li data-bbox="506 411 1070 448">• The paper may not meet paper specifications.
<p data-bbox="53 568 275 595">Horizontal stripes</p> 	<p data-bbox="506 568 1122 595">If horizontally aligned black streaks or smears appear:</p> <ul data-bbox="506 624 1552 707" style="list-style-type: none"><li data-bbox="506 624 1552 660">• The toner cartridge may be installed improperly. Remove the cartridge and reinsert it.<li data-bbox="506 671 1552 707">• The toner cartridge may be defective. Remove the toner cartridge and install a new one. <p data-bbox="506 727 1559 754">If the problem persists, the machine may require repairing. Contact a service representative.</p>
<p data-bbox="53 887 107 914">Curl</p> 	<p data-bbox="506 887 1308 914">If the printed paper is curled or paper does not feed into the machine:</p> <ul data-bbox="506 943 1906 1026" style="list-style-type: none"><li data-bbox="506 943 1491 979">• Turn the stack of paper over in the tray. Also try rotating the paper 180° in the tray.<li data-bbox="506 991 1906 1026">• Change the printer's paper option and try again. Go to Printing Preferences, click the Paper tab, and set type to Thin.
<ul data-bbox="53 1182 479 1393" style="list-style-type: none"><li data-bbox="53 1182 479 1249">• An unknown image repetitively appears on a few sheets<li data-bbox="53 1270 237 1297">• Loose toner<li data-bbox="53 1326 450 1393">• Light print or contamination occurs	<p data-bbox="506 1182 1440 1209">Your machine is probably being used at an altitude of 1,000 m (3,281 ft) or above.</p> <p data-bbox="506 1233 2134 1305">The high altitude may affect the print quality, such as loose toner or light imaging. Change the altitude setting for your machine (See "Altitude adjustment" on page 106).</p>

Operating system problems

Common Windows problems

Condition	Suggested solutions
“File in Use” message appears during installation.	Exit all software applications. Remove all software from the startup group, then restart Windows. Reinstall the printer driver.
“General Protection Fault”, “Exception OE”, “Spool 32”, or “Illegal Operation” messages appear.	Close all other applications, reboot Windows and try printing again.
“Fail To Print”, “A printer timeout error occurred” message appear.	These messages may appear during printing. Just keep waiting until the machine finishes printing. If the message appears in ready mode or after printing has completed, check the connection and/or whether an error has occurred.



Refer to the Microsoft Windows 2000/XP/2003/Vista User's Guide that came with your computer for further information on Windows error messages.

Operating system problems

Common Macintosh problems

Condition	Suggested solutions
The machine does not print PDF files correctly. Some parts of graphics, text, or illustrations are missing.	<p>Printing the PDF file as an image may enable the file to print. Turn on Print As Image from the Acrobat printing options.</p> <p> It will take longer to print when you print a PDF file as an image.</p>
Some letters are not displayed normally during cover page printing.	<p>Mac OS cannot create the font while printing the cover page. The English alphabet and numbers are displayed normally on the cover page.</p>
When printing a document in Macintosh with Acrobat Reader 6.0 or higher, colors print incorrectly.	<p>Make sure that the resolution setting in your machine driver matches the one in Acrobat Reader.</p>



Refer to the Macintosh User's Guide that came with your computer for further information on Macintosh error messages.

Operating system problems

Common Linux problems

Condition	Suggested solutions
The machine does not print.	<ul style="list-style-type: none">• Check if the printer driver is installed in your system. Open Unified Driver Configurator and switch to the Printers tab in the Printers configuration window to look at the list of available machines. Make sure that your machine is displayed on the list. If not, open Add new printer wizard to set up your device.• Check if the machine is started. Open Printers configuration and select your machine from the printers list. Look at the description in the Selected printer pane. If its status contains Stopped, press the Start button. Normal operation of the machine should be restored. The “stopped” status might be activated when some problems in printing occur.• Check if your application has special print options such as “-oraw”. If “-oraw” is specified in the command line parameter, then remove it to print properly. For Gimp front-end, select “print” -> “Setup printer” and edit the command line parameter in the command item.
The machine does not print whole pages, and output is printed on half the page.	It is a known problem that occurs when a color machine is used on version 8.51 or earlier of Ghostscript, 64-bit Linux OS, and has been reported to bugs.ghostscript.com as Ghostscript Bug 688252. The problem is solved in AFPL Ghostscript v. 8.52 or above. Download the latest version of AFPL Ghostscript from http://sourceforge.net/projects/ghostscript/ and install it to solve this problem.
“Cannot open port device file” error message appears when printing a document.	Avoid changing print job parameters (e.g., via LPR GUI) while a print job is in progress. Known versions of CUPS server break the print job whenever print options are changed and then try to restart the job from the beginning. Since Unified Linux Driver locks the port while printing, the abrupt termination of the driver keeps the port locked and unavailable for subsequent print jobs. If this situation occurs, try to release the port by selecting Release port in the Port configuration window.



Refer to the Linux User’s Guide that came with your computer for further information on Linux error messages.



The following glossary helps you get familiar with the product by understanding the terminologies commonly used with printing as well as mentioned in this user's guide.

802.11

802.11 is a set of standards for wireless local area network (WLAN) communication, developed by the IEEE LAN/MAN Standards Committee (IEEE 802).

802.11b/g/n

802.11b/g/n can share same hardware and use the 2.4 GHz band. 802.11b supports bandwidth up to 11 Mbps, 802.11n supports bandwidth up to 150 Mbps. 802.11b/g/n devices may occasionally suffer interference from microwave ovens, cordless telephones, and Bluetooth devices.

Access point

Access Point or Wireless Access Point (AP or WAP) is a device that connects wireless communication devices together on wireless local area networks (WLAN), and acts as a central transmitter and receiver of WLAN radio signals.

ADF

An Automatic Document Feeder (ADF) is a scanning unit that will automatically feed an original sheet of paper so that the machine can scan some amount of the paper at once.

AppleTalk

AppleTalk is a proprietary suite of protocols developed by Apple, Inc for computer networking. It was included in the original Macintosh (1984) and is now deprecated by Apple in favor of TCP/IP networking.

BIT Depth

A computer graphics term describing the number of bits used to represent the color of a single pixel in a bitmapped image. Higher color depth gives a broader range of distinct colors. As the number of bits increases, the number of possible colors becomes impractically large for a color map. 1-bit color is commonly called as monochrome or black and white.

BMP

A bitmapped graphics format used internally by the Microsoft Windows graphics subsystem (GDI), and used commonly as a simple graphics file format on that platform.

BOOTP

Bootstrap Protocol. A network protocol used by a network client to obtain its IP address automatically. This is usually done in the bootstrap process of computers or operating systems running on them. The BOOTP servers assign the IP address from a pool of addresses to each client. BOOTP enables 'diskless workstation' computers to obtain an IP address prior to loading any advanced operating system.

CCD

Charge Coupled Device (CCD) is a hardware which enables the scan job. CCD Locking mechanism is also used to hold the CCD module to prevent any damage when you move the machine.

Collation

Collation is a process of printing a multiple-copy job in sets. When collation is selected, the device prints an entire set before printing additional copies.

Control Panel

A control panel is a flat, typically vertical, area where control or monitoring instruments are displayed. They are typically found in front of the machine.

Coverage

It is the printing term used for a toner usage measurement on printing. For example, 5% coverage means that an A4 sided paper has about 5% image or text on it. So, if the paper or original has complicated images or lots of text on it, the coverage will be higher and at the same time, a toner usage will be as much as the coverage.

CSV

Comma Separated Values (CSV). A type of file format, CSV is used to exchange data between disparate applications. The file format, as it is used in Microsoft Excel, has become a de facto standard throughout the industry, even among non-Microsoft platforms.

DADF

A Duplex Automatic Document Feeder (DADF) is a scanning unit that will automatically feed and turn over an original sheet of paper so that the machine can scan on both sides of the paper.

Default

The value or setting that is in effect when taking a printer out of its box state, reset, or initialized.

DHCP

A Dynamic Host Configuration Protocol (DHCP) is a client-server networking protocol. A DHCP server provides configuration parameters specific to the DHCP client host requesting, generally, information required by the client host to participate on an IP network. DHCP also provides a mechanism for allocation of IP addresses to client hosts.

DIMM

Dual Inline Memory Module (DIMM), a small circuit board that holds memory. DIMM stores all the data within the machine like printing data, received fax data.

DLNA

The Digital Living Network Alliance (DLNA) is a standard that allows devices on a home network to share information with each other across the network.

DNS

The Domain Name Server (DNS) is a system that stores information associated with domain names in a distributed database on networks, such as the Internet.

Dot Matrix Printer

A dot matrix printer refers to a type of computer printer with a print head that runs back and forth on the page and prints by impact, striking an ink-soaked cloth ribbon against the paper, much like a typewriter.

DPI

Dots Per Inch (DPI) is a measurement of resolution that is used for scanning and printing. Generally, higher DPI results in a higher resolution, more visible detail in the image, and a larger file size.

DRPD

Distinctive Ring Pattern Detection. Distinctive Ring is a telephone company service which enables a user to use a single telephone line to answer several different telephone numbers.

Duplex

A mechanism that will automatically turn over a sheet of paper so that the machine can print (or scan) on both sides of the paper. A printer equipped with a Duplex Unit can print on both sides of paper during one print cycle.

Duty Cycle

Duty cycle is the page quantity which does not affect printer performance for a month. Generally the printer has the lifespan limitation such as pages per year. The lifespan means the average capacity of print-outs, usually within the warranty period. For example, if the duty cycle is 48,000 pages per month assuming 20 working days, a printer limits 2,400 pages a day.

ECM

Error Correction Mode (ECM) is an optional transmission mode built into Class 1 fax machines or fax modems. It automatically detects and corrects errors in the fax transmission process that are sometimes caused by telephone line noise.

Emulation

Emulation is a technique of one machine obtaining the same results as another.

An emulator duplicates the functions of one system with a different system, so that the second system behaves like the first system. Emulation focuses on exact reproduction of external behavior, which is in contrast to simulation, which concerns an abstract model of the system being simulated, often considering its internal state.

Ethernet

Ethernet is a frame-based computer networking technology for local area networks (LANs). It defines wiring and signaling for the physical layer, and frame formats and protocols for the media access control (MAC)/data link layer of the OSI model.

Ethernet is mostly standardized as IEEE 802.3. It has become the most widespread LAN technology in use during the 1990s to the present.

EtherTalk

A suite of protocols developed by Apple Computer for computer networking. It was included in the original Macintosh (1984) and is now deprecated by Apple in favor of TCP/IP networking.

FDI

Foreign Device Interface (FDI) is a card installed inside the machine to allow a third party device such as a coin operated device or a card reader. Those devices allow the pay-for-print service on your machine.

FTP

A File Transfer Protocol (FTP) is a commonly used protocol for exchanging files over any network that supports the TCP/IP protocol (such as the Internet or an intranet).

Fuser Unit

The part of a laser printer that fuses the toner onto the print media. It consists of a heat roller and a pressure roller. After toner is transferred onto the paper, the fuser unit applies heat and pressure to ensure that the toner stays on the paper permanently, which is why paper is warm when it comes out of a laser printer.

Gateway

A connection between computer networks, or between a computer network and a telephone line. It is very popular, as it is a computer or a network that allows access to another computer or network.

Grayscale

A shades of gray that represent light and dark portions of an image when color images are converted to grayscale; colors are represented by various shades of gray.

Halftone

An image type that simulates grayscale by varying the number of dots. Highly colored areas consist of a large number of dots, while lighter areas consist of a smaller number of dots.

HDD

Hard Disk Drive (HDD), commonly referred to as a hard drive or hard disk, is a non-volatile storage device which stores digitally-encoded data on rapidly rotating platters with magnetic surfaces.

IEEE

The Institute of Electrical and Electronics Engineers (IEEE) is an international non-profit, professional organization for the advancement of technology related to electricity.

IEEE 1284

The 1284 parallel port standard was developed by the Institute of Electrical and Electronics Engineers (IEEE). The term "1284-B" refers to a specific connector type on the end of the parallel cable that attaches to the peripheral (for example, a printer).

Intranet

A private network that uses Internet Protocols, network connectivity, and possibly the public telecommunication system to securely share part of an organization's information or operations with its employees. Sometimes the term refers only to the most visible service, the internal website.

IP address

An Internet Protocol (IP) address is a unique number that devices use in order to identify and communicate with each other on a network utilizing the Internet Protocol standard.

IPM

The Images Per Minute (IPM) is a way of measuring the speed of a printer. An IPM rate indicates the number of single-sided sheets a printer can complete within one minute.

IPP

The Internet Printing Protocol (IPP) defines a standard protocol for printing as well as managing print jobs, media size, resolution, and so forth. IPP can be used locally or over the Internet to hundreds of printers, and also supports access control, authentication, and encryption, making it a much more capable and secure printing solution than older ones.

IPX/SPX

IPX/SPX stands for Internet Packet Exchange/Sequenced Packet Exchange. It is a networking protocol used by the Novell NetWare operating systems. IPX and SPX both provide connection services similar to TCP/IP, with the IPX protocol having similarities to IP, and SPX having similarities to TCP. IPX/SPX was primarily designed for local area networks (LANs), and is a very efficient protocol for this purpose (typically its performance exceeds that of TCP/IP on a LAN).

ISO

The International Organization for Standardization (ISO) is an international standard-setting body composed of representatives from national standards bodies. It produces world-wide industrial and commercial standards.

ITU-T

The International Telecommunication Union is an international organization established to standardize and regulate international radio and telecommunications. Its main tasks include standardization, allocation of the radio spectrum, and organizing interconnection arrangements between different countries to allow international phone calls. A -T out of ITU-T indicates telecommunication.

ITU-T No. 1 chart

Standardized test chart published by ITU-T for document facsimile transmissions.

JBIG

Joint Bi-level Image Experts Group (JBIG) is an image compression standard with no loss of accuracy or quality, which was designed for compression of binary images, particularly for faxes, but can also be used on other images.

JPEG

Joint Photographic Experts Group (JPEG) is a most commonly used standard method of lossy compression for photographic images. It is the format used for storing and transmitting photographs on the World Wide Web.

LDAP

The Lightweight Directory Access Protocol (LDAP) is a networking protocol for querying and modifying directory services running over TCP/IP.

LED

A Light-Emitting Diode (LED) is a semiconductor device that indicates the status of a machine.

MAC address

Media Access Control (MAC) address is a unique identifier associated with a network adapter. MAC address is a unique 48-bit identifier usually written as 12 hexadecimal characters grouped in pairs (e. g., 00-00-0c-34-11-4e). This address is usually hard-coded into a Network Interface Card (NIC) by its manufacturer, and used as an aid for routers trying to locate machines on large networks.

MFP

Multi Function Peripheral (MFP) is an office machine that includes the following functionality in one physical body, so as to have a printer, a copier, a fax, a scanner and etc.

MH

Modified Huffman (MH) is a compression method for decreasing the amount of data that needs to be transmitted between the fax machines to transfer the image recommended by ITU-T T.4. MH is a codebook-based run-length encoding scheme optimized to efficiently compress white space. As most faxes consist mostly of white space, this minimizes the transmission time of most faxes.

MMR

Modified Modified READ (MMR) is a compression method recommended by ITU-T T.6.

Modem

A device that modulates a carrier signal to encode digital information, and also demodulates such a carrier signal to decode transmitted information.

MR

Modified Read (MR) is a compression method recommended by ITU-T T.4. MR encodes the first scanned line using MH. The next line is compared to the first, the differences determined, and then the differences are encoded and transmitted.

NetWare

A network operating system developed by Novell, Inc. It initially used cooperative multitasking to run various services on a PC, and the network protocols were based on the archetypal Xerox XNS stack. Today NetWare supports TCP/IP as well as IPX/SPX.

OPC

Organic Photo Conductor (OPC) is a mechanism that makes a virtual image for print using a laser beam emitted from a laser printer, and it is usually green or rust colored and has a cylinder shape.

An imaging unit containing a drum slowly wears the drum surface by its usage in the printer, and it should be replaced appropriately since it gets worn from contact with the cartridge development brush, cleaning mechanism, and paper.

Glossary

Originals

The first example of something, such as a document, photograph or text, etc, which is copied, reproduced or translated to produce others, but which is not itself copied or derived from something else.

OSI

Open Systems Interconnection (OSI) is a model developed by the International Organization for Standardization (ISO) for communications. OSI offers a standard, modular approach to network design that divides the required set of complex functions into manageable, self-contained, functional layers. The layers are, from top to bottom, Application, Presentation, Session, Transport, Network, Data Link and Physical.

PABX

A private automatic branch exchange (PABX) is an automatic telephone switching system within a private enterprise.

PCL

Printer Command Language (PCL) is a Page Description Language (PDL) developed by HP as a printer protocol and has become an industry standard. Originally developed for early inkjet printers, PCL has been released in varying levels for thermal, dot matrix printer, and laser printers.

PDF

Portable Document Format (PDF) is a proprietary file format developed by Adobe Systems for representing two dimensional documents in a device independent and resolution independent format.

PostScript

PostScript (PS) is a page description language and programming language used primarily in the electronic and desktop publishing areas. - that is run in an interpreter to generate an image.

Printer Driver

A program used to send commands and transfer data from the computer to the printer.

Print Media

The media like paper, envelopes, labels, and transparencies which can be used in a printer, a scanner, a fax or, a copier.

PPM

Pages Per Minute (PPM) is a method of measurement for determining how fast a printer works, meaning the number of pages a printer can produce in one minute.

PRN file

An interface for a device driver, this allows software to interact with the device driver using standard input/output system calls, which simplifies many tasks.

Protocol

A convention or standard that controls or enables the connection, communication, and data transfer between two computing endpoints.

PS

See PostScript.

PSTN

The Public-Switched Telephone Network (PSTN) is the network of the world's public circuit-switched telephone networks which, on industrial premises, is usually routed through the switchboard.

RADIUS

Remote Authentication Dial In User Service (RADIUS) is a protocol for remote user authentication and accounting. RADIUS enables centralized management of authentication data such as usernames and passwords using an AAA (authentication, authorization, and accounting) concept to manage network access.

Resolution

The sharpness of an image, measured in Dots Per Inch (DPI). The higher the dpi, the greater the resolution.

SMB

Server Message Block (SMB) is a network protocol mainly applied to share files, printers, serial ports, and miscellaneous communications between nodes on a network. It also provides an authenticated Inter-process communication mechanism.

SMTP

Simple Mail Transfer Protocol (SMTP) is the standard for e-mail transmissions across the Internet. SMTP is a relatively simple, text-based protocol, where one or more recipients of a message are specified, and then the message text is transferred. It is a client-server protocol, where the client transmits an email message to the server.

SSID

Service Set Identifier (SSID) is a name of a wireless local area network (WLAN). All wireless devices in a WLAN use the same SSID in order to communicate with each other. The SSIDs are case-sensitive and have a maximum length of 32 characters.

Subnet Mask

The subnet mask is used in conjunction with the network address to determine which part of the address is the network address and which part is the host address.

TCP/IP

The Transmission Control Protocol (TCP) and the Internet Protocol (IP); the set of communications protocols that implement the protocol stack on which the Internet and most commercial networks run.

TCR

Transmission Confirmation Report (TCR) provides details of each transmission such as job status, transmission result and number of pages sent. This report can be set to print after each job or only after failed transmissions.

TIFF

Tagged Image File Format (TIFF) is a variable-resolution bitmapped image format. TIFF describes image data that typically come from scanners. TIFF images make use of tags, keywords defining the characteristics of the image that is included in the file. This flexible and platform-independent format can be used for pictures that have been made by various image processing applications.

Toner Cartridge

A kind of bottle or container used in a machine like a printer which contains toner. Toner is a powder used in laser printers and photocopiers, which forms the text and images on the printed paper. Toner can be fused by a combination of heat/pressure from the fuser, causing it to bind to the fibers in the paper.

TWAIN

An industry standard for scanners and software. By using a TWAIN-compliant scanner with a TWAIN-compliant program, a scan can be initiated from within the program. It is an image capture API for Microsoft Windows and Apple Macintosh operating systems.

UNC Path

Uniform Naming Convention (UNC) is a standard way to access network shares in Window NT and other Microsoft products. The format of a UNC path is:
`\\<servername>\<sharename>\<Additional directory>`

URL

Uniform Resource Locator (URL) is the global address of documents and resources on the Internet. The first part of the address indicates what protocol to use, the second part specifies the IP address or the domain name where the resource is located.

USB

Universal Serial Bus (USB) is a standard that was developed by the USB Implementers Forum, Inc., to connect computers and peripherals. Unlike the parallel port, USB is designed to concurrently connect a single computer USB port to multiple peripherals.

Watermark

A watermark is a recognizable image or pattern in paper that appears lighter when viewed by transmitted light. Watermarks were first introduced in Bologna, Italy in 1282; they have been used by papermakers to identify their product, and also on postage stamps, currency, and other government documents to discourage counterfeiting.

WEP

Wired Equivalent Privacy (WEP) is a security protocol specified in IEEE 802.11 to provide the same level of security as that of a wired LAN. WEP provides security by encrypting data over radio so that it is protected as it is transmitted from one end point to another.

WIA

Windows Imaging Architecture (WIA) is an imaging architecture that is originally introduced in Windows Me and Windows XP. A scan can be initiated from within these operating systems by using a WIA-compliant scanner.

WPA

Wi-Fi Protected Access (WPA) is a class of systems to secure wireless (Wi-Fi) computer networks, which was created to improve upon the security features of WEP.

WPA-PSK

WPA-PSK (WPA Pre-Shared Key) is special mode of WPA for small business or home users. A shared key, or password, is configured in the wireless access point (WAP) and any wireless laptop or desktop devices. WPA-PSK generates a unique key for each session between a wireless client and the associated WAP for more advanced security.

WPS

The Wi-Fi Protected Setup (WPS) is a standard for establishing a wireless home network. If your wireless access point supports WPS, you can configure the wireless network connection easily without a computer.

XPS

XML Paper Specification (XPS) is a specification for a Page Description Language (PDL) and a new document format, which has benefits for portable document and electronic document, developed by Microsoft. It is an XML-based specification, based on a new print path and a vector-based device-independent document format.

Index

A

AirPrint 89

C

cleaning
 inside 44
 outside 44
 pickup roller 46
cleaning a machine 44
control panel 16
convention 8

D

Dell Printer Status 99
Dell Supplies Ordering Utility 94
driver installation
 Unix 84

E

eco button 16
eco printing 35
embedded web service
 general information 95

F

favorites settings, for printing 34
features 4
 print media feature 59
Firmware Update Utility 93
front view 15

G

general icons 8
glossary 137
google cloud printing 90

J

jam
 clearing paper 50
 tips for avoiding paper jams 49

L

Linux
 common Linux problems 136
 driver installation for network connected 83
 driver installation for USB cable connected 74
 driver reinstallation for USB cable connected

75
printer properties 118
printing 117
 system requirements 63
 unified driver configurator 101
 using SetIP 80
loading
 paper in manual feeder/multi-purpose tray 26
 paper in the tray1 25
 special media 28
local
 driver installation 18
 driver reinstalling 20

M

Macintosh
 common Macintosh problems 135
 driver installation for network connected 82
 driver installation for USB cable connected 72
 driver reinstallation for USB cable connected 73
 printing 115
 system requirements 62

Index

using SetIP	79
manual feeder/multi-purpose tray	
tips on using	26
using special media	28

N

network	
driver installation	
Linux	83
Macintosh	82
UNIX	84
Windows	81
installing environment	64
introducing network programs	77
IPv6 configuration	87
SetIP program	78, 79, 80
N-up printing	
Macintosh	115

O

overlay printing	
create	113
delete	114
print	114

P

placing a machine	
adjusting the altitude	106
print media	
card stock	31
envelope	28
labels	30
output support	59
preprinted paper	31
special media	28
transparency	30
print resolution set	
Linux	117
printer preferences	
Linux	118
Printing	33
printing	
changing the default print settings	107
Linux	117
Macintosh	115
multiple pages on one sheet of paper	
Macintosh	115
printing a document	
Windows	33

printing on both sides of paper	
Macintosh	116
printing to a file	109
UNIX	119
printing a document	
Linux	117
Macintosh	115
UNIX	119
problems	
paper feeding problems	122
power problems	123
printing problems	124
printing quality problems	127

R

rear view	15
-----------	----

S

safety	
information	9
symbols	9
SetIP program	78
special print features	105
specifications	58

Index

print media	59
stop button	16
supplies	
available supplies	39
estimated toner cartridge life	41
ordering	39
replacing toner cartridge	43

T

toner cartridge	
estimated life	41
handling instructions	40
non-Dell and refilled	40
redistributing toner	42
replacing the cartridge	43
storing	40
tray	
adjusting the width and length	23
changing the tray size	23
loading paper in manual feeder/multi-purpose tray	26

U

understanding the status LED	55
------------------------------	----

UNIX	
driver installation for network connected	84
printing	119
Unix	
system requirements	63
USB cable	
driver installation	72, 74
driver reinstallation	73, 75
using help	35, 116

W

watermark	
create	112
delete	112
edit	112
Windows	
common Windows problems	134
driver installation for network connected	81
driver installation for USB cable connected	18, 20
system requirements	61
using SetIP	78