



Dell SCv3000 and SCv3020 Storage System Deployment Guide



Notes, Cautions, and Warnings

-  **NOTE:** A NOTE indicates important information that helps you make better use of your product.
-  **CAUTION:** A CAUTION indicates either potential damage to hardware or loss of data and tells you how to avoid the problem.
-  **WARNING:** A WARNING indicates a potential for property damage, personal injury, or death.

Contents

About This Guide.....	7
Revision History.....	7
Audience.....	7
Contacting Dell.....	7
Related Publications.....	7
1 About the SCv3000 and SCv3020 Storage System.....	9
Storage Center Hardware Components.....	9
SCv3000 and SCv3020 Storage System.....	9
Expansion Enclosures.....	9
Switches.....	9
Storage Center Communication.....	10
Front-End Connectivity.....	10
Back-End Connectivity.....	15
System Administration.....	15
Storage Center Replication.....	15
SCv3000 and SCv3020 Storage System Hardware.....	15
SCv3000 and SCv3020 Storage System Front-Panel View.....	15
SCv3000 and SCv3020 Storage System Back-Panel View.....	17
Expansion Enclosure Overview.....	21
2 Install the Storage Center Hardware.....	28
Unpacking Storage Center Equipment.....	28
Safety Precautions.....	28
Installation Safety Precautions.....	28
Electrical Safety Precautions.....	29
Electrostatic Discharge Precautions.....	29
General Safety Precautions.....	29
Prepare the Installation Environment.....	30
Install the Storage System in a Rack.....	30
3 Connect the Front-End Cabling.....	32
Types of Redundancy for Front-End Connections.....	32
Port Redundancy.....	32
Storage Controller Redundancy.....	32
Connecting to Host Servers with Fibre Channel HBAs.....	33
Fibre Channel Zoning.....	33
Cable the Storage System with 2-Port Fibre Channel IO Cards.....	34
Cable the Storage System with 4-Port Fibre Channel IO Cards.....	35
Labeling the Front-End Cables.....	35
Connecting to Host Servers with iSCSI HBAs or Network Adapters.....	37
Cable the Storage System with 2-Port iSCSI IO Cards.....	37
Cable the Storage System with 4-Port iSCSI IO Cards.....	38



Connect a Storage System to a Host Server Using an iSCSI Mezzanine Card.....	39
Labeling the Front-End Cables.....	40
Connecting to Host Servers with SAS HBAs.....	41
Cable the Storage System with 4-Port SAS HBAs to Host Servers with One SAS HBA per Server.....	41
Labeling the Front-End Cables.....	42
Attach Host Servers (Fibre Channel).....	43
Attach the Host Servers (iSCSI).....	44
Attach the Host Servers (SAS).....	44
Connect the Management Ports to the Management Network.....	45
Labeling the Ethernet Management Cables.....	45

4 Connect the Back-End Cabling.....47

Expansion Enclosure Cabling Guidelines.....	47
Back-End SAS Redundancy.....	47
Back-End Connections for an SCv3000 and SCv3020 Storage System With Expansion Enclosures.....	47
SCv3000 and SCv3020 and One SCv300 and SCv320 Expansion Enclosure.....	48
SCv3000 and SCv3020 and Two SCv300 and SCv320 Expansion Enclosures.....	49
SCv3000 and SCv3020 Storage System and One SCv360 Expansion Enclosure.....	49
SCv3000 and SCv3020 Storage System and Two SCv360 Expansion Enclosures.....	50
Label the Back-End Cables.....	51

5 Discover and Configure the Storage Center.....53

Connect Power Cables and Turn On the Storage System.....	53
Locate Your Service Tag.....	54
Record System Information.....	54
Supported Operating Systems for Storage Center Automated Setup	54
Install and Use the Dell Storage Manager.....	54
Discover and Select an Uninitialized Storage Center.....	55
Deploy the Storage Center Using the Direct Connect Method.....	55
Customer Installation Authorization.....	56
Set System Information.....	56
Set Administrator Information.....	56
Confirm the Storage Center Configuration.....	57
Initialize the Storage Center.....	57
Configure Key Management Server Settings.....	57
Create a Storage Type.....	57
Configure Ports.....	58
Configure Fibre Channel Ports.....	58
Configure iSCSI Ports.....	58
Configure SAS Ports.....	59
Configure Time Settings.....	59
Configure SMTP Server Settings.....	59
Using Dell SupportAssist.....	59
Enable SupportAssist	60
Update the Storage Center.....	61
Complete the Configuration and Continue With Setup.....	61



Modify iDRAC Interface Settings for a Storage System.....	61
Unconfigure Unused I/O Ports.....	62
6 Perform Post-Setup Tasks.....	63
Update Storage Center Using Dell Storage Manager.....	63
Check the Status of the Update.....	63
Change the Operation Mode of a Storage Center.....	63
Verify Connectivity and Failover.....	64
Create Test Volumes.....	64
Test Basic Connectivity.....	64
Test Storage Controller Failover.....	64
Test MPIO.....	65
Clean Up Test Volumes.....	65
Send Diagnostic Data Using Dell SupportAssist.....	65
7 Adding or Removing Expansion Enclosures.....	66
Adding Expansion Enclosures to a Storage System Deployed Without Expansion Enclosures.....	66
Install New SCv300 and SCv320 Expansion Enclosures in a Rack.....	66
Add the SCv300 and SCv320 Expansion Enclosures to the A-Side of the Chain.....	67
Add the SCv300 and SCv320 Expansion Enclosures to the B-Side of the Chain.....	68
Install New SCv360 Expansion Enclosures in a Rack.....	68
Add the SCv360 Expansion Enclosures to the A-Side of the Chain.....	69
Add an SCv360 Expansion Enclosure to the B-Side of the Chain.....	70
Adding a Single Expansion Enclosure to a Chain Currently in Service.....	72
Check the Drive Count.....	72
Add an SCv300 and SCv320 Expansion Enclosure to the A-Side of the Chain.....	72
Add an SCv300 and SCv320 Expansion Enclosure to the B-Side of the Chain.....	73
Add an SCv360 Expansion Enclosure to the A-Side of the Chain.....	75
Add an SCv360 Expansion Enclosure to the B-Side of the Chain.....	76
Removing an Expansion Enclosure from a Chain Currently in Service.....	77
Release the Drives in the Expansion Enclosure.....	78
Disconnect the SCv300 and SCv320 Expansion Enclosure from the A-Side of the Chain.....	78
Disconnect the SCv300 and SCv320 Expansion Enclosure from the B-Side of the Chain.....	79
Disconnect the SCv360 Expansion Enclosure from the A-Side of the Chain.....	81
Disconnect the SCv360 Expansion Enclosure from the B-Side of the Chain.....	82
8 Troubleshooting Storage Center Deployment.....	85
Troubleshooting Storage Controllers.....	85
Troubleshooting Hard Drives.....	85
Troubleshooting Expansion Enclosures.....	85
Troubleshooting With Lasso.....	86
Lasso Application.....	86
Lasso Documentation.....	86
Lasso Requirements.....	86
A Set Up a Local Host or VMware Host.....	87
Set Up a VMware ESXi Host from Initial Setup.....	87



Set Up a Local host from Initial Setup.....	87
Set Up Multiple VMware ESXi Hosts in a VMware vSphere Cluster.....	88
B Initialize the Storage Center Using the USB Serial Port.....	89
Install the USB Serial Port Driver	89
Establish a Terminal Session.....	89
Discover the Storage Center Using the Setup Utility Tool.....	90
C Worksheet to Record System Information.....	91
Storage Center Information.....	91
iSCSI Fault Domain Information.....	91
Additional Storage Center Information.....	92
Fibre Channel Zoning Information.....	92
D HBA Server Settings.....	94
Settings by HBA Manufacturer.....	94
Dell 12 Gb SAS HBAs.....	94
Cisco Fibre Channel HBAs.....	94
Emulex HBAs.....	94
QLogic HBAs.....	95
Settings by Server Operating System.....	95
Citrix XenServer.....	96
Microsoft Windows Server.....	96
Novell Netware	97
Red Hat Enterprise Linux.....	97
E iSCSI Settings.....	99
Flow Control Settings.....	99
Ethernet Flow Control.....	99
Switch Ports and Flow Control.....	99
Flow Control.....	99
Jumbo Frames and Flow Control.....	99
Other iSCSI Settings.....	100



About This Guide

This guide describes the features and technical specifications of the SCv3000 and SCv3020 storage system.

Revision History

Document Number: 680-136-001

Revision	Date	Description
A	October 2017	Initial release
B	November 2017	Corrections to SCv360 cabling

Audience

The information provided in this guide is intended for storage or network administrators and deployment personnel.

Contacting Dell

Dell provides several online and telephone-based support and service options. Availability varies by country and product, and some services might not be available in your area.

To contact Dell for sales, technical support, or customer service issues, go to www.dell.com/support.

- For customized support, type your system service tag on the support page and click **Submit**.
- For general support, browse the product list on the support page and select your product.

Related Publications

The following documentation provides additional information about the SCv3000 and SCv3020 storage system.

- *Dell SCv3000 and SCv3020 Storage System Getting Started Guide*
Provides information about an SCv3000 and SCv3020 storage system, such as installation instructions and technical specifications.
- *Dell SCv3000 and SCv3020 Storage System Owner's Manual*
Provides information about an SCv3000 and SCv3020 storage system, such as hardware features, replacing customer-replaceable components, and technical specifications.
- *Dell SCv3000 and SCv3020 Storage System Service Guide*
Provides information about SCv3000 and SCv3020 storage system hardware, system component replacement, and system troubleshooting.
- *Dell Storage Center Release Notes*
Provides information about new features and known and resolved issues for the Storage Center software.
- *Dell Storage Center Update Utility Administrator's Guide*
Describes how to use the Storage Center Update Utility to install Storage Center software updates. Updating Storage Center software using the Storage Center Update Utility is intended for use only by sites that cannot update Storage Center using standard methods.
- *Dell Storage Center Software Update Guide*
Describes how to update Storage Center software from an earlier version to the current version.
- *Dell Storage Center Command Utility Reference Guide*
Provides instructions for using the Storage Center Command Utility. The Command Utility provides a command-line interface (CLI) to enable management of Storage Center functionality on Windows, Linux, Solaris, and AIX platforms.



- *Dell Storage Center Command Set for Windows PowerShell*
Provides instructions for getting started with Windows PowerShell cmdlets and scripting objects that interact with the Storage Center using the PowerShell interactive shell, scripts, and PowerShell hosting applications. Help for individual cmdlets is available online.
- *Storage Manager Installation Guide*
Contains installation and setup information.
- *Storage Manager Administrator's Guide*
Contains in-depth feature configuration and usage information.
- *Dell Storage Manager Release Notes*
Provides information about Storage Manager releases, including new features and enhancements, open issues, and resolved issues.
- *Dell TechCenter*
Provides technical white papers, best practice guides, and frequently asked questions about Dell Storage products. Go to <http://en.community.dell.com/techcenter/storage/>.



About the SCv3000 and SCv3020 Storage System

The SCv3000 and SCv3020 storage system provides the central processing capabilities for the Storage Center Operating System (OS), application software, and management of RAID storage.

The SCv3000 and SCv3020 storage system holds the physical drives that provide storage for the Storage Center. If additional storage is needed, the SCv3000 and SCv3020 supports SCv300 and SCv320 and SCv360 expansion enclosures.

Storage Center Hardware Components

The Storage Center described in this document consists of an SCv3000 and SCv3020 storage system, expansion enclosures, and enterprise-class switches.

To allow for storage expansion, the SCv3000 and SCv3020 storage system supports multiple SCv300 and SCv320 and SCv360 expansion enclosures.

 **NOTE: The cabling between the storage system, switches, and host servers is referred to as front-end connectivity. The cabling between the storage system and expansion enclosures is referred to as back-end connectivity.**

SCv3000 and SCv3020 Storage System

The SCv3000 and SCv3020 storage systems contain two redundant power supply/cooling fan modules, and two storage controllers with multiple I/O ports. The I/O ports provide communication with host servers and expansion enclosures. The SCv3000 storage system contains up to 16 3.5-inch drives and the SCv3020 storage system contains up to 30 2.5-inch drives.

The SCv3000 Series Storage Center supports up to 222 drives per Storage Center system. This total includes the drives in the storage system chassis and the drives in the expansion enclosures. The SCv3000 and SCv3020 require a minimum of seven hard disk drives (HDDs) or four solid-state drives (SSDs) installed in the storage system chassis or an expansion enclosure.

Configuration	Number of Drives Supported
SCv3000 storage system with SCv300 or SCv320 expansion enclosure	208
SCv3000 storage system with SCv360 expansion enclosure	196
SCv3020 storage system with SCv300 or SCv320 expansion enclosure	222
SCv3020 storage system with SCv360 expansion enclosure	210

Expansion Enclosures

Expansion enclosures allow the data storage capabilities of the SCv3000 and SCv3020 storage system to be expanded beyond the 16 or 30 drives in the storage system chassis.

The SCv3000 and SCv3020 support up to 16 SCv300 expansion enclosures, up to eight SCv320 expansion enclosures, and up to two SCv360 expansion enclosures.

Switches

Dell offers enterprise-class switches as part of the total Storage Center solution.

The SCv3000 and SCv3020 storage system supports Fibre Channel (FC) and Ethernet switches, which provide robust connectivity to servers and allow for the use of redundant transport paths. Fibre Channel (FC) or Ethernet switches can provide connectivity to a



remote Storage Center to allow for replication of data. In addition, Ethernet switches provide connectivity to a management network to allow configuration, administration, and management of the Storage Center.

Storage Center Communication

A Storage Center uses multiple types of communication for both data transfer and administrative functions. Storage Center communication is classified into three types: front end, back end, and system administration.

Front-End Connectivity

Front-end connectivity provides I/O paths from servers to a storage system and replication paths from one Storage Center to another Storage Center. The SCv3000 and SCv3020 storage system provides the following types of front-end connectivity:

- Fibre Channel – Hosts, servers, or network-attached storage (NAS) appliances access storage by connecting to the storage system Fibre Channel ports through one or more Fibre Channel switches. Connecting host servers directly to the storage system, without using Fibre Channel switches, is not supported.
- iSCSI – Hosts, servers, or network-attached storage (NAS) appliances access storage by connecting to the storage system iSCSI ports through one or more Ethernet switches. Connecting host servers directly to the storage system, without using Ethernet switches, is not supported.
- SAS – Hosts or servers access storage by connecting directly to the storage system SAS ports.

When replication is licensed, the SCv3000 and SCv3020 can use the front-end Fibre Channel or iSCSI ports to replicate data to another Storage Center.

SCv3000 and SCv3020 Storage System With Fibre Channel Front-End Connectivity

A storage system with Fibre Channel front-end connectivity can communicate with the following components of a Storage Center system.

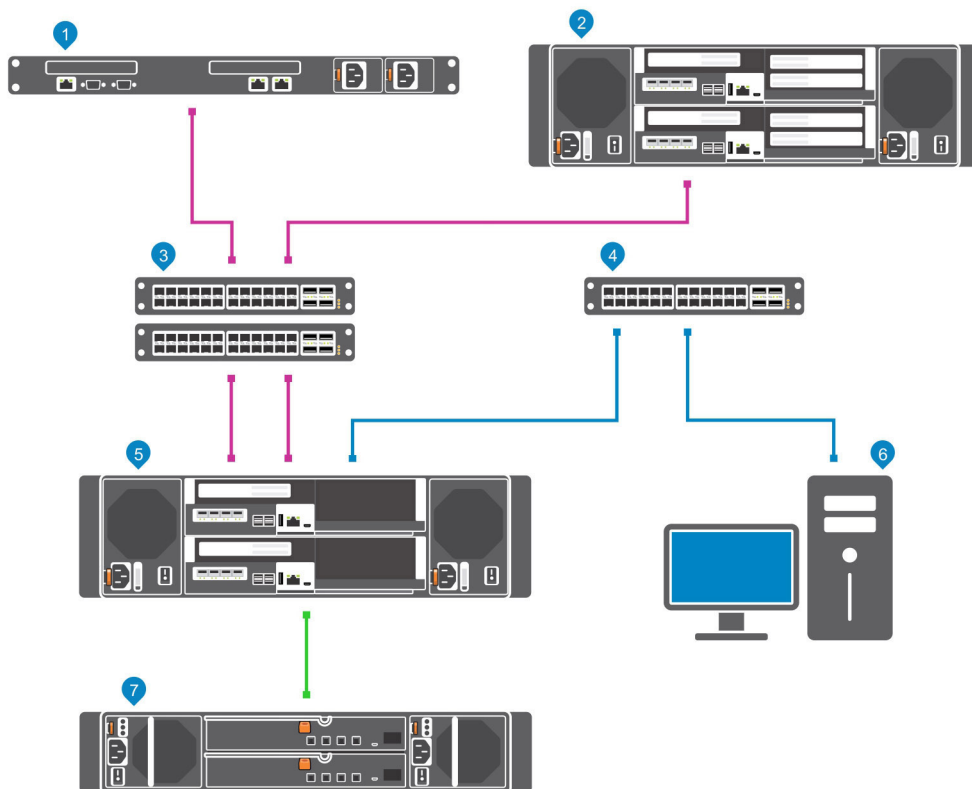

Figure 1. Storage System With Fibre Channel Front-End Connectivity

Item	Description	Speed	Communication Type
1	Server with Fibre Channel host bus adapters (HBAs)	8 Gbps or 16 Gbps	Front End
2	Remote Storage Center connected via Fibre Channel for replication	8 Gbps or 16 Gbps	Front End
3	Fibre Channel switch (A pair of Fibre Channel switches are recommended for optimal redundancy and connectivity)	8 Gbps or 16 Gbps	Front End
4	Ethernet switch for the management network	1 Gbps	System Administration
5	SCv3000 and SCv3020 with FC front-end connectivity	8 Gbps or 16 Gbps	Front End
6	Storage Manager (Installed on a computer connected to the storage system through the Ethernet switch)	Up to 1 Gbps	System Administration
7	SCv300 and SCv320 expansion enclosures	12 Gbps per channel	Back End

SCv3000 and SCv3020 Storage System With iSCSI Front-End Connectivity

A storage system with iSCSI front-end connectivity can communicate with the following components of a Storage Center system.

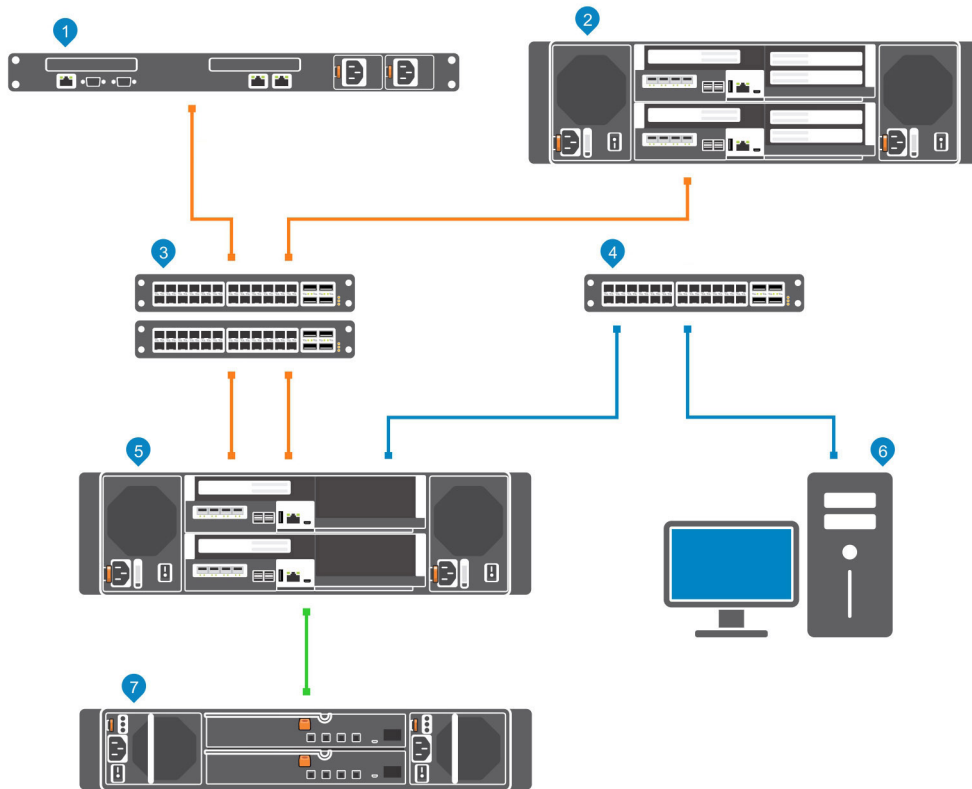

Figure 2. Storage System With iSCSI Front-End Connectivity

Item	Description	Speed	Communication Type
1	Server with Ethernet (iSCSI) ports or iSCSI host bus adapters (HBAs)	1 GbE or 10 GbE	Front End
2	Remote Storage Center connected via iSCSI for replication	1 GbE or 10 GbE	Front End
3	Ethernet switch (A pair of Ethernet switches is recommended for optimal redundancy and connectivity)	1 GbE or 10 GbE	Front End
4	Ethernet switch for the management network	1 Gbps	System Administration



Item	Description	Speed	Communication Type
5	SCv3000 and SCv3020 with iSCSI front-end connectivity	1 GbE or 10 GbE	Front End
6	Storage Manager (Installed on a computer connected to the storage system through the Ethernet switch)	Up to 1 Gbps	System Administration
7	SCv300 and SCv320 expansion enclosures	12 Gbps per channel	Back End

SCv3000 and SCv3020 Storage System With Front-End SAS Connectivity

The SCv3000 and SCv3020 storage system with front-end SAS connectivity can communicate with the following components of a Storage Center system.

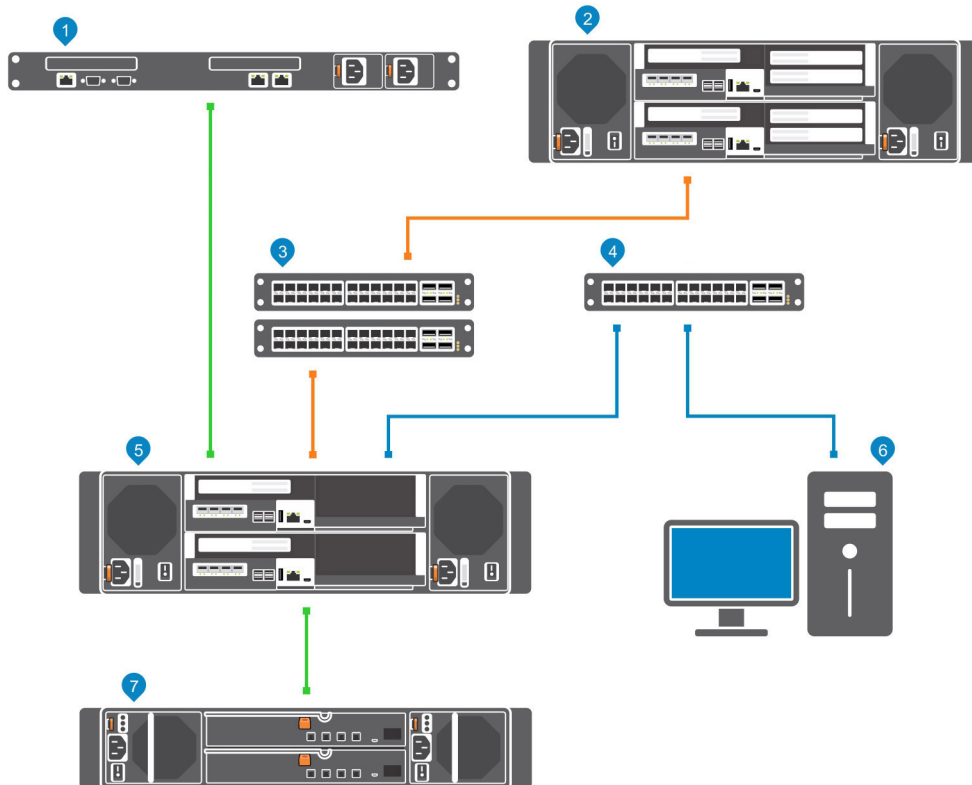

Figure 3. Storage System With Front-End SAS Connectivity

Item	Description	Speed	Communication Type
1	Server with SAS host bus adapters (HBAs)	12 Gbps per channel	Front End
2	Remote Storage Center connected via iSCSI for replication	1 GbE or 10 GbE	Front End
3	Ethernet switch (A pair of Ethernet switches is recommended for optimal redundancy and connectivity)	1 GbE or 10 GbE	Front End
4	Ethernet switch for the management network	Up to 1 GbE	System Administration
5	SCv3000 and SCv3020 with front-end SAS connectivity	12 Gbps per channel	Front End
6	Storage Manager (Installed on a computer connected to the storage system through the Ethernet switch)	Up to 1 Gbps	System Administration
7	SCv300 and SCv320 expansion enclosures	12 Gbps per channel	Back End

Using SFP+ Transceiver Modules

You can connect to the front-end port of a storage controller using a direct-attached SFP+ cable or an SFP+ transceiver module. An SCv3000 and SCv3020 storage system with 16 Gb Fibre Channel or 10 GbE iSCSI storage controllers uses short-range small-form-factor pluggable (SFP+) transceiver modules.

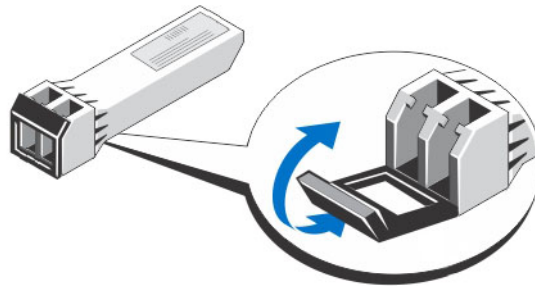

Figure 4. SFP+ Transceiver Module With a Bail Clasp Latch

The SFP+ transceiver modules are installed into the front-end ports of a storage controller.

Guidelines for Using SFP+ Transceiver Modules

Before installing SFP+ transceiver modules and fiber-optic cables, read the following guidelines.

⚠ CAUTION: When handling static-sensitive devices, take precautions to avoid damaging the product from static electricity.

- Use only Dell-supported SFP+ transceiver modules with the Storage Center. Other generic SFP+ transceiver modules are not supported and might not work with the Storage Center.
- The SFP+ transceiver module housing has an integral guide key that is designed to prevent you from inserting the transceiver module incorrectly.
- Use minimal pressure when inserting an SFP+ transceiver module into a Fibre Channel port. Forcing the SFP+ transceiver module into a port could damage the transceiver module or the port.
- The SFP+ transceiver module must be installed into a port before you connect the fiber-optic cable.
- The fiber-optic cable must be removed from the SFP+ transceiver module before you remove the transceiver module from the port.

Install an SFP+ Transceiver Module

Use the following procedure to install an SFP+ transceiver module into a storage controller.

About this task

Read the following cautions and information before installing an SFP+ transceiver module.

⚠ WARNING: To reduce the risk of injury from laser radiation or damage to the equipment, take the following precautions:

- Do not open any panels, operate controls, make adjustments, or perform procedures to a laser device other than those specified in this document.
- Do not stare into the laser beam.

⚠ CAUTION: Transceiver modules can be damaged by electrostatic discharge (ESD). To prevent ESD damage to the transceiver module, take the following precautions:

- Wear an antistatic discharge strap while handling transceiver modules.
- Place transceiver modules in antistatic packing material when transporting or storing them.

Steps

1. Position the transceiver module so that the key is oriented correctly to the port in the storage controller.



3. Grasp the bail clasp latch on the transceiver module and pull the latch out and down to eject the transceiver module from the socket.
4. Slide the transceiver module out of the port.

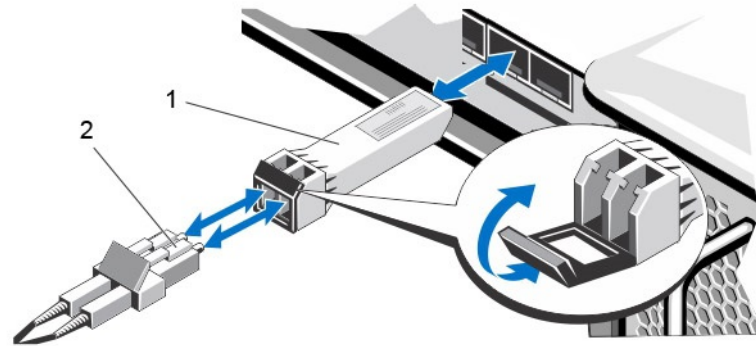

Figure 6. Remove the SFP+ Transceiver Module

1. SFP+ transceiver module

2. Fiber-optic cable connector

Back-End Connectivity

Back-end connectivity is strictly between the storage system and expansion enclosures.

The SCv3000 and SCv3020 storage system supports back-end connectivity to multiple SCv300, SCv320, and SCv360 expansion enclosures.

System Administration

To perform system administration, the Storage Center communicates with computers using the Ethernet management (MGMT) port on the storage controllers.

The Ethernet management port is used for Storage Center configuration, administration, and management.

Storage Center Replication

Storage Center sites can be collocated or remotely connected and data can be replicated between sites. Storage Center replication can duplicate volume data to another site in support of a disaster recovery plan or to provide local access to a remote data volume. Typically, data is replicated remotely as part of an overall disaster avoidance or recovery plan.

The SCv3000 and SCv3020 supports replication to other SCv3000/SCv3020, SC5020, SC7020, SC8000, SC9000, and SC4020 storage systems. However, a Storage Manager Data Collector must be used to replicate data between the storage systems. For more information about installing and managing the Data Collector, and setting up replications, see the *Storage Manager Administrator's Guide*.

SCv3000 and SCv3020 Storage System Hardware

The SCv3000 and SCv3020 storage system ships with Dell Enterprise Plus Value drives, two redundant power supply/cooling fan modules, and two redundant storage controllers.

Each storage controller contains the front-end, back-end, and management communication ports of the storage system.

SCv3000 and SCv3020 Storage System Front-Panel View

The front panel of the storage system contains power and status indicators, and a system identification button.

In addition, the hard drives are installed and removed through the front of the storage system chassis.



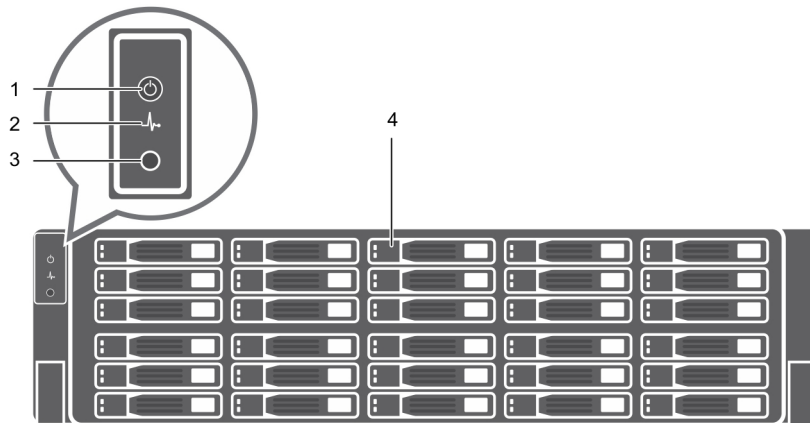

Figure 7. SCv3000 and SCv3020 Storage System Front-Panel View

Item	Name	Icon	Description
1	Power indicator		Lights when the storage system power is on <ul style="list-style-type: none"> Off – No power On steady green – At least one power supply is providing power to the storage system
2	Status indicator		Lights when the startup process for both storage controllers is complete with no faults detected. <p>NOTE: The startup process can take 5–10 minutes or more.</p> <ul style="list-style-type: none"> Off – One or both storage controllers are running startup routines, or a fault has been detected during startup On steady blue – Both storage controllers have completed the startup process and are in normal operation Blinking amber – Fault detected
3	Identification button		Blinking blue continuously – A user sent a command to the storage system to make the LED blink so that the user can identify the storage system in the rack. <ul style="list-style-type: none"> The identification LED blinks on the control panel of the chassis, to allow users to find the storage system when looking at the front of the rack. The identification LEDs on the storage controllers also blink, which allows users to find the storage system when looking at the back of the rack.
4	Hard drives	—	Can have up to 30 internal 2.5-inch SAS hard drives

SCv3000 and SCv3020 Storage System Drives

The SCv3000 and SCv3020 storage system supports Dell Enterprise Plus Value drives.

The drives in an SCv3000 storage system are installed horizontally. The drives in an SCv3020 storage system are installed vertically. The indicators on the drives provide status and activity information.



Figure 8. SCv300 and SCv320 Expansion Enclosure Drive Indicators

Item	Control/Feature	Indicator Code
1	Drive activity indicator	<ul style="list-style-type: none"> Blinking green – Drive has I/O activity Steady green – Drive is detected and has no faults
2	Drive status indicator	<ul style="list-style-type: none"> Steady green – Normal operation Blinking green – A command was sent by Dell Storage Manager to the drive to make the LED blink so that users can identify the drive in the rack. Blinking amber – Hardware or firmware fault

SCv3000 and SCv3020 Storage System Drive Numbering

The storage system holds up to 16 or 30 drives, which are numbered from left to right in rows starting from 0 at the top-left drive. Drive numbers increment from left to right, and then top to bottom such that the first row of drives is numbered from 0 to 4 from left to right, and the second row of drives is numbered from 5 to 9 from left to right.

Dell Storage Manager identifies drives as *XX-YY*, where *XX* is the number of the unit ID of the storage system and *YY* is the drive position inside the storage system.

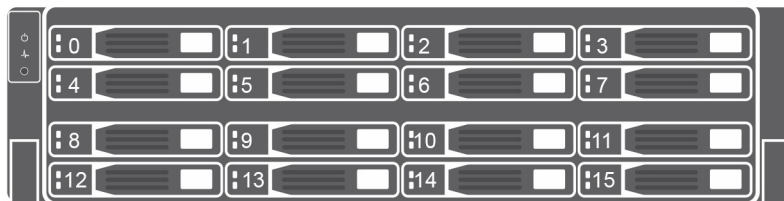

Figure 9. SCv3000 Storage System Drive Numbering

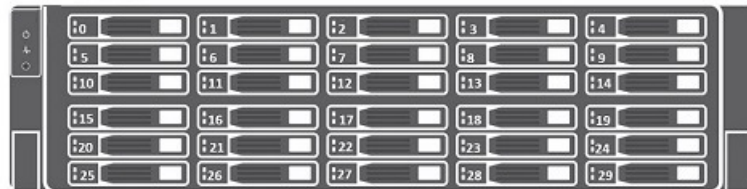

Figure 10. SCv3020 Storage System Drive Numbering

SCv3000 and SCv3020 Storage System Back-Panel View

The back panel of the storage system contains the storage controller indicators and power supply indicators.

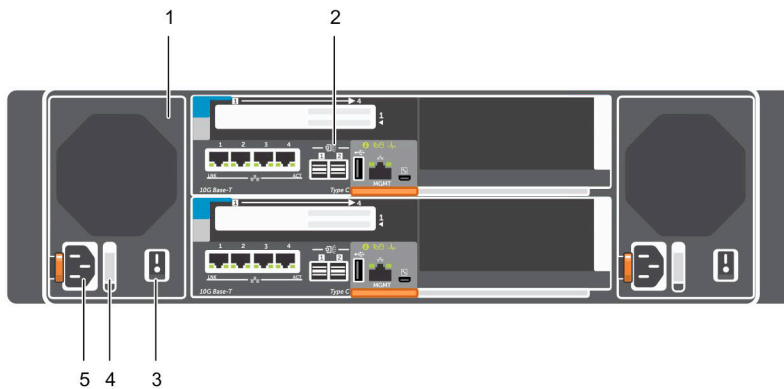



Figure 11. SCv3000 and SCv3020 Storage System Back-Panel View

Item	Name	Icon	Description
1	Power supply/cooling fan module (2)		Contains a 1485 W power supply and fans that provide cooling for the storage system, with AC input to the power supply of 200–240 V. In Dell Storage Manager, the power supply/cooling fan module on the left side of the back panel is Power Supply 1 and power supply/cooling fan module on the right side of the back panel is Power Supply 2.
2	Storage controller (2)	—	Each storage controller contains: <ul style="list-style-type: none"> • Optional 10 GbE iSCSI mezzanine card with four SFP+ ports or four RJ45 10GBASE-T ports • One expansion slot for a front-end I/O card: <ul style="list-style-type: none"> – Fibre Channel – iSCSI – SAS • SAS expansion ports – Two 12 Gbps SAS ports for back-end connectivity to expansion enclosures • USB port – Single USB 2.0 port • MGMT port – Embedded Ethernet port for system management • Serial port – Micro-USB serial port used for an alternative initial configuration and support-only functions
3	Power switch (2)	—	Controls power for the storage system. Each power supply/cooling fan module has one power switch.
4	Power supply/cooling fan module LED handle	—	The handle of the power supply/cooling fan module indicates the DC power status of the power supply and the fans. <ul style="list-style-type: none"> • Not lit – No power • Solid green – Power supply has valid power source and is operational • Blinking amber – Error condition in the power supply • Blinking green – Firmware is being updated. • Blinking green then off – Power supply mismatch
5	Power socket (2)	—	Accepts the following standard computer power cords: <ul style="list-style-type: none"> • IEC320-C13 for deployments worldwide • IEC60320-C19 for deployments in Japan

Power Supply and Cooling Fan Modules

The SCv3000 and SCv3020 storage system supports two hot-swappable power supply/cooling fan modules.

The cooling fans and the power supplies are integrated into the power supply/cooling fan module and cannot be replaced separately. If one power supply/cooling fan module fails, the second module continues to provide power to the storage system.

 **NOTE: When a power supply/cooling fan module fails, the cooling fan speed in the remaining module increases significantly to provide adequate cooling. The cooling fan speed decreases gradually when a new power supply/cooling fan module is installed.**

 **CAUTION: A single power supply/cooling fan module can be removed from a powered on storage system for no more than 90 seconds. If a power supply/cooling fan module is removed for longer than 90 seconds, the storage system might shut down automatically to prevent damage.**

SCv3000 and SCv3020 Storage Controller Features and Indicators

The SCv3000 and SCv3020 storage system includes two storage controllers in two interface slots.

SCv3000 and SCv3020 Storage Controller

The following figure shows the features and indicators on the storage controller.

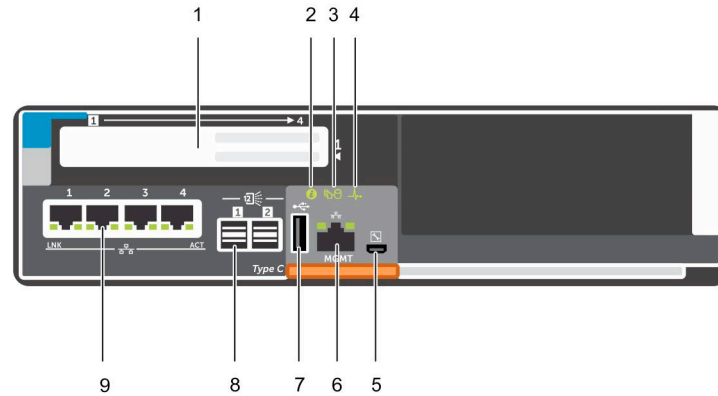









Figure 12. SCv3000 and SCv3020 Storage Controller

Item	Control/Feature	Icon	Description
1	I/O card slot		<p>Fibre Channel I/O card – Ports are numbered 1 to 4 from left to right</p> <ul style="list-style-type: none"> The LEDs on the 16 Gb Fibre Channel ports have the following meanings: <ul style="list-style-type: none"> All off – No power All on – Booting up Blinking amber – 4 Gbps activity Blinking green – 8 Gbps activity Blinking yellow – 16 Gbps activity Blinking amber and yellow – Beacon All blinking (simultaneous) – Firmware initialized All blinking (alternating) – Firmware fault The LEDs on the 32 Gb Fibre Channel ports have the following meanings: <ul style="list-style-type: none"> All off – No power All on – Booting up Blinking amber – 8 Gbps activity Blinking green – 16 Gbps activity Blinking yellow – 32 Gbps activity Blinking amber and yellow – Beacon All blinking (simultaneous) – Firmware initialized All blinking (alternating) – Firmware fault <p>iSCSI I/O card – Ports are numbered 1 to 4 from left to right</p> <p>NOTE: The iSCSI I/O card supports Data Center Bridging (DCB), but the mezzanine card does not support DCB.</p> <ul style="list-style-type: none"> The LEDs on the iSCSI ports have the following meanings: <ul style="list-style-type: none"> Off – No power Steady Amber – Link Blinking Green – Activity

Item	Control/Feature	Icon	Description
			SAS I/O card – Ports are numbered 1 to 4 from left to right The SAS ports on SAS I/O cards do not have LEDs.
2	Identification LED		Blinking blue continuously – A command was sent by Dell Storage Manager to the storage system to make the LED blink so that users can identify the storage system in the rack. The identification LED blinks on the control panel of the chassis, which allows users to find the storage system when looking at the front of the rack. The identification LEDs on the storage controllers also blink, which allows users to find the storage system when looking at the back of the rack.
3	Cache to Flash (C2F)		<ul style="list-style-type: none"> Off – Running normally Blinking green – Running on battery (shutting down)
4	Health status		<ul style="list-style-type: none"> Off – Unpowered Blinking amber <ul style="list-style-type: none"> Slow blinking amber (2s on, 1s off) – Controller hardware fault was detected. Use Dell Storage Manager to view specific details about the hardware fault. Fast blinking amber (4x per second) – Power good and the pre-operating system is booting Blinking green <ul style="list-style-type: none"> Slow blinking green (2s on, 1s off) – Operating system is booting Blinking green (1s on, 1s off) – System is in safe mode Fast blinking green (4x per second) – Firmware is updating Solid green – Running normal operation
5	Serial port (micro USB)		Used under the supervision of Dell Technical Support to troubleshoot and support systems.
6	MGMT port	—	Ethernet port used for storage system management and access to Dell Storage Manager. Two LEDs with the port indicate link status (left LED) and activity status (right LED): <ul style="list-style-type: none"> Link and activity indicators are off – Not connected to the network Link indicator is green – The NIC is connected to a valid network at its maximum port speed. Link indicator is amber – The NIC is connected to a valid network at less than its maximum port speed. Activity indicator is blinking green – Network data is being sent or received.
7	USB port		One USB 2.0 connector that is used for SupportAssist diagnostic files when the storage system is not connected to the Internet.
8	Mini-SAS (ports 1 and 2)		Back-end expansion ports 1 and 2. LEDs with the ports indicate connectivity information between the storage controller and the expansion enclosure: <ul style="list-style-type: none"> Steady green indicates the SAS connection is working properly. Steady yellow indicates the SAS connection is not working properly.
9	Mezzanine card		The iSCSI ports on the mezzanine card are either 10 GbE SFP+ ports or 1 GbE/10 GbE RJ45 ports. The LEDs on the iSCSI ports have the following meanings:

Item	Control/Feature	Icon	Description
			<ul style="list-style-type: none"> Off – No connectivity Steady green, left LED – Link (full speed) Steady amber, left LED – Link (degraded speed) Blinking green, right LED – Activity
			NOTE: The mezzanine card does not support DCB.

Expansion Enclosure Overview

Expansion enclosures allow the data storage capabilities of the SCv3000 and SCv3020 storage system to be expanded beyond the 30 internal drives in the storage system chassis.

- The SCv300 is a 2U expansion enclosure that supports up to 12 3.5-inch hard drives installed in a four-column, three-row configuration.
- The SCv320 is a 2U expansion enclosure that supports up to 24 2.5-inch hard drives installed vertically side by side.
- The SCv360 is a 4U expansion enclosure that supports up to 60 3.5-inch hard drives installed in a twelve-column, five-row configuration.

SCv300 and SCv320 Expansion Enclosure Front-Panel Features and Indicators

The front panel shows the expansion enclosure status and power supply status.

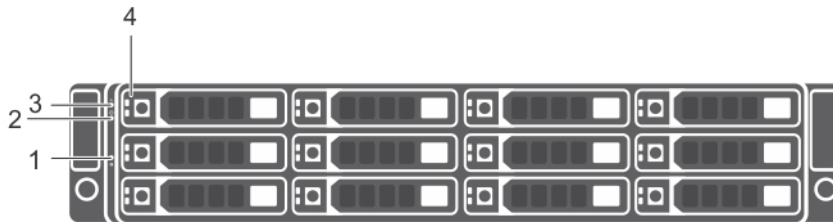

Figure 13. SCv300 Front-Panel Features and Indicators

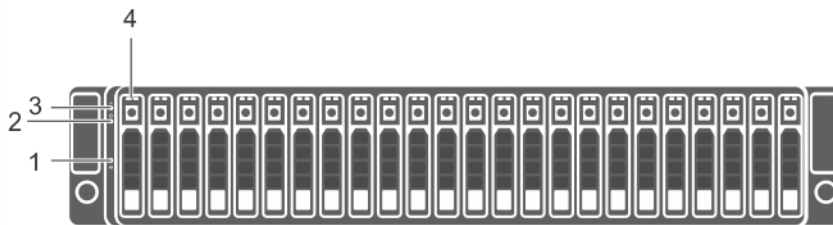





Figure 14. SCv320 Front-Panel Features and Indicators

Item	Name	Icon	Description
1	System identification button		The system identification button on the front control panel can be used to locate a particular expansion enclosure within a rack. When the button is pressed, the system status indicators on the control panel and the Enclosure Management Module (EMM) blink blue until the button is pressed again.
2	Power LED		The power LED lights when at least one power supply unit is supplying power to the expansion enclosure.
3	Expansion enclosure status LED		The expansion enclosure status LED lights when the expansion enclosure power is on.

Item	Name	Icon	Description
			<ul style="list-style-type: none"> • Solid blue during normal operation. • Blinks blue when a host server is identifying the expansion enclosure or when the system identification button is pressed. • Blinks amber or remains solid amber for a few seconds and then turns off when the EMMs are starting or resetting. • Blinks amber for an extended time when the expansion enclosure is in a warning state. • Remains solid amber when the expansion enclosure is in the fault state.
4	Hard disk drives		<ul style="list-style-type: none"> • SCv300 – Up to 12 3.5-inch SAS hot-swappable hard disk drives. • SCv320 – Up to 24 2.5-inch SAS hot-swappable hard disk drives.

SCv300 and SCv320 Expansion Enclosure Drives

Dell Enterprise Plus Value drives are the only drives that can be installed in SCv300 and SCv320 expansion enclosures. If a non-Dell Enterprise Plus Valuedrive is installed, the Storage Center prevents the drive from being managed.

The drives in an SCv300 expansion enclosure are installed horizontally.



Figure 15. SCv300 Expansion Enclosure Drive Indicators

The drives in an SCv320 expansion enclosure are installed vertically.



Figure 16. SCv320 Expansion Enclosure Drive Indicators

Item	Name	Indicator Code
1	Drive activity indicator	<ul style="list-style-type: none"> • Blinking green – Drive activity • Steady green – Drive is detected and has no faults
2	Drive status indicator	<ul style="list-style-type: none"> • Steady green – Normal operation • Blinking green (on 1 sec. / off 1 sec.) – Drive identification is enabled • Steady amber – Drive is safe to remove • Off – No power to the drive

SCv300 and SCv320 Expansion Enclosure Drive Numbering

The Storage Center identifies drives as *XX-YY*, where *XX* is the unit ID of the expansion enclosure that contains the drive, and *YY* is the drive position inside the expansion enclosure.

An SCv300 holds up to 12 drives, which are numbered from left to right in rows starting from 0.



Figure 17. SCv300 Drive Numbering

An SCv320 holds up to 24 drives, which are numbered from left to right starting from 0. A

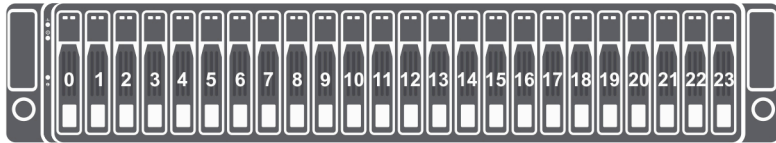

Figure 18. SCv320 Drive Numbering

SCv300 and SCv320 Expansion Enclosure Back-Panel Features and Indicators

The back panel provides controls to power up and reset the expansion enclosure, indicators to show the expansion enclosure status, and connections for back-end cabling.

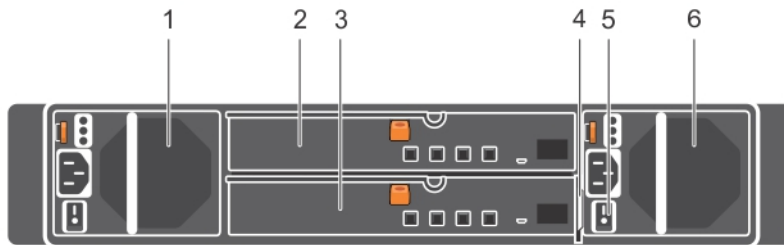

Figure 19. SCv300 and SCv320 Expansion Enclosure Back Panel Features and Indicators

Item	Name	Description
1	Power supply unit and cooling fan module (PS1)	600 W power supply
2	Enclosure management module (EMM 0)	The EMM provides a data path between the expansion enclosure and the storage controllers. The EMM also provides the management functions for the expansion enclosure.
3	Enclosure management module (EMM 1)	The EMM provides a data path between the expansion enclosure and the storage controllers. The EMM also provides the management functions for the expansion enclosure.
4	Information tag	A slide-out label panel that records system information such as the Service Tag
5	Power switches (2)	Controls power for the expansion enclosure. There is one switch for each power supply.
6	Power supply unit and cooling fan module (PS2)	600 W power supply

SCv300 and SCv320 Expansion Enclosure EMM Features and Indicators

The SCv300 and SCv320 expansion enclosure includes two enclosure management modules (EMMs) in two interface slots.

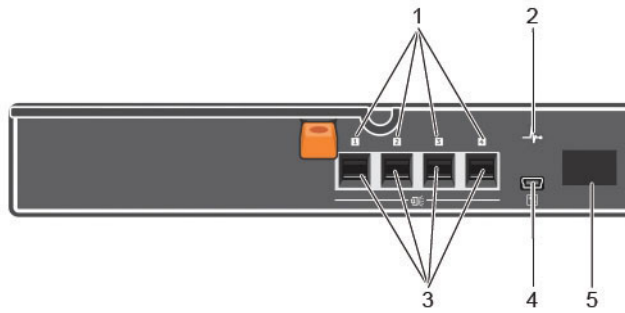

Figure 20. SCv300 and SCv320 Expansion Enclosure EMM Features and Indicators

Item	Name	Icon	Description
1	SAS port status (1-4)		<ul style="list-style-type: none"> Green – All the links to the port are connected Amber – One or more links are not connected Off – Expansion enclosure is not connected
2	EMM status indicator		<ul style="list-style-type: none"> On steady green – Normal operation Amber – Expansion enclosure did not boot or is not properly configured Blinking green – Automatic update in progress Blinking amber two times per sequence – Expansion enclosure is unable to communicate with other expansion enclosures Blinking amber (four times per sequence) – Firmware update failed Blinking amber (five times per sequence) – Firmware versions are different between the two EMMs
3	SAS ports 1-4 (Input or Output)		Provides SAS connections for cabling the storage controller to the next expansion enclosure in the chain. (single port, redundant, and multichain configuration).
4	USB Mini-B (serial debug port)		Not for customer use
5	Unit ID display		Displays the expansion enclosure ID

SCv360 Expansion Enclosure Front-Panel Features and Indicators

The SCv360 front panel shows the expansion enclosure status and power supply status.



Figure 21. SCv360 Front-Panel Features and Indicators

Item	Name	Description
1	Power LED	The power LED lights when at least one power supply unit is supplying power to the expansion enclosure.
2	Expansion enclosure status LED	<p>The expansion enclosure status LED indicates when the system is being identified or when the expansion enclosure is in the fault state.</p> <ul style="list-style-type: none"> Off during normal operation. Blinks blue when a host server is identifying the expansion enclosure or when the system identification button is pressed. Remains solid blue when the expansion enclosure is in the fault state.

SCv360 Expansion Enclosure Drives

Dell Enterprise Plus drives are the only drives that can be installed in SCv360 expansion enclosures. If a non-Dell Enterprise Plus drive is installed, the Storage Center prevents the drive from being managed.

The drives in an SCv360 expansion enclosure are installed horizontally.

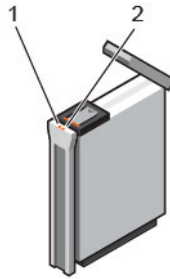

Figure 22. SCv360 Drive Indicators

Item	Name	Indicator Code
1	Drive activity indicator	<ul style="list-style-type: none"> Blinking blue – Drive activity Steady blue – Drive is detected and has no faults
2	Drive status indicator	<ul style="list-style-type: none"> Off – Normal operation Blinking amber (on 1 sec. / off 1 sec.) – Drive identification is enabled Steady amber – Drive has a fault

SCv360 Expansion Enclosure Drive Numbering

The Storage Center identifies drives as *XX-YY*, where *XX* is the unit ID of the expansion enclosure that contains the drive, and *YY* is the drive position inside the expansion enclosure.

An SCv360 holds up to 60 drives, which are numbered from left to right in rows starting from 0.

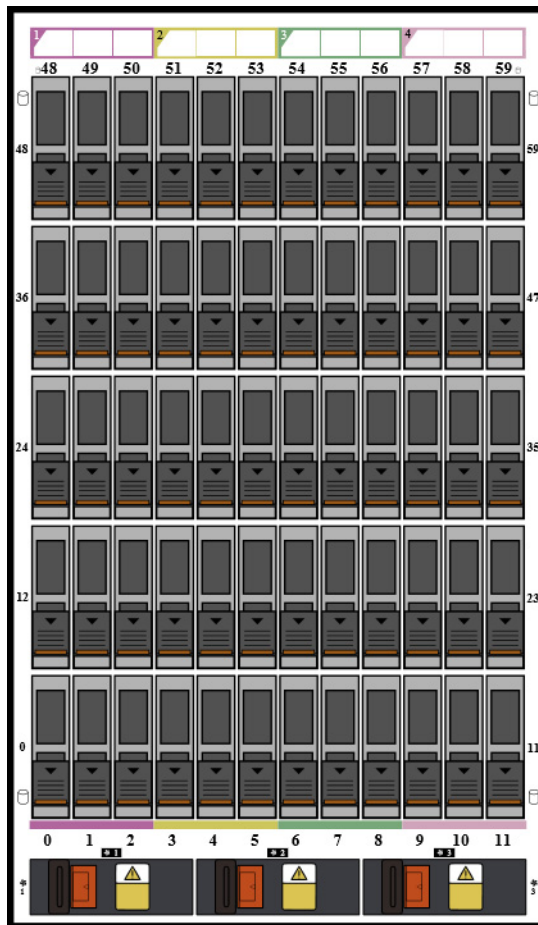

Figure 23. SCv360 Drive Numbering

SCv360 Expansion Enclosure Back Panel Features and Indicators

The SCv360 back panel provides controls to power up and reset the expansion enclosure, indicators to show the expansion enclosure status, and connections for back-end cabling.

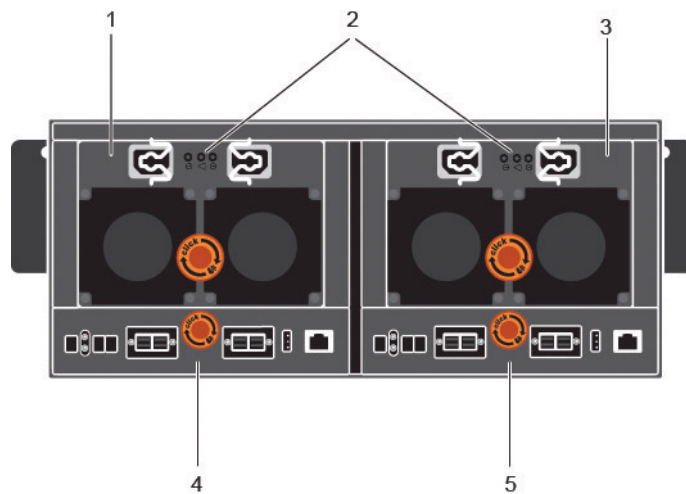

Figure 24. SCv360 Back Panel Features and Indicators

Item	Name	Description
1	Power supply unit and cooling fan module (PS1)	Contains redundant 900 W power supplies and fans that provide cooling for the expansion enclosure.
2	Power supply indicators <ul style="list-style-type: none"> AC power indicator for power supply 1 Power supply/cooling fan indicator AC power indicator for power supply 2 	AC power indicators: <ul style="list-style-type: none"> Green: Normal operation. The power supply module is supplying AC power to the expansion enclosure Off: Power switch is off, the power supply is not connected to AC power, or has a fault condition Flashing Green: AC power is applied but is out of spec. Power supply/cooling fan indicator: <ul style="list-style-type: none"> Amber: Power supply/cooling fan fault is detected Off: Normal operation
3	Power supply unit and cooling fan module (PS2)	Contains redundant 900 W power supplies and fans that provide cooling for the expansion enclosure.
4	Enclosure management module 1	EMMs provide the data path and management functions for the expansion enclosure.
5	Enclosure management module 2	EMMs provide the data path and management management functions for the expansion enclosure.

SCv360 Expansion Enclosure EMM Features and Indicators

The SCv360 includes two enclosure management modules (EMMs) in two interface slots.

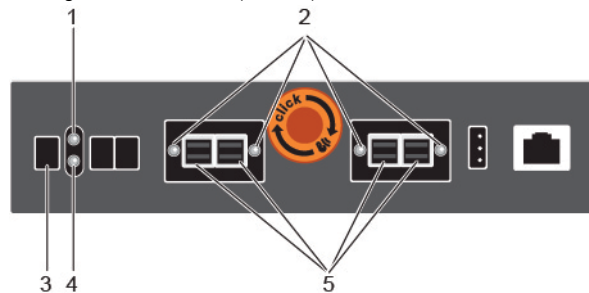

Figure 25. SCv360 EMM Features and Indicators

Item	Name	Description
1	EMM status indicator	<ul style="list-style-type: none"> Off – Normal operation Amber – fault has been detected Blinking amber two times per sequence – Expansion enclosure is unable to communicate with other expansion enclosures Blinking amber (four times per sequence) – Firmware update failed Blinking amber (five times per sequence) – Firmware versions are different between the two EMMs
2	SAS port status indicator	<ul style="list-style-type: none"> Blue – All the links to the port are connected Blinking blue – One or more links are not connected Off – Expansion enclosure is not connected
3	Unit ID display	Displays the expansion enclosure ID
4	EMM power indicator	<ul style="list-style-type: none"> Blue – Normal operation Off – Power is not connected
5	SAS ports 1–4 (Input or Output)	Provides SAS connections for cabling the storage controller to the next expansion enclosure in the chain (single port, redundant, and multichain configuration).

Install the Storage Center Hardware

This section describes how to unpack the Storage Center equipment, prepare for the installation, mount the equipment in a rack, and install the drives.

Unpacking Storage Center Equipment

Unpack the storage system and identify the items in your shipment.

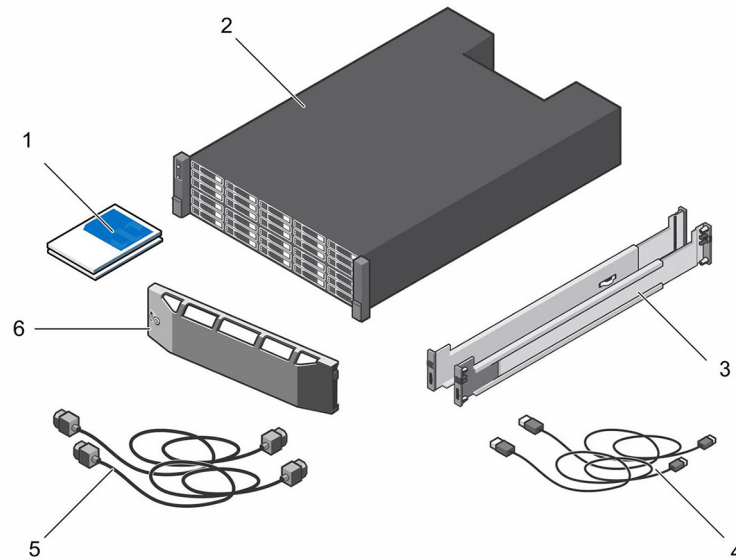

Figure 26. SCv3000 and SCv3020 Storage System Components

- | | |
|---------------------|-------------------|
| 1. Documentation | 2. Storage system |
| 3. Rack rails | 4. USB cables (2) |
| 5. Power cables (2) | 6. Front bezel |

Safety Precautions

Always follow these safety precautions to avoid injury and damage to Storage Center equipment.

If equipment described in this section is used in a manner not specified by Dell, the protection provided by the equipment could be impaired. For your safety and protection, observe the rules described in the following sections.

NOTE: See the safety and regulatory information that shipped with each Storage Center component. Warranty information is included within this document or as a separate document.

Installation Safety Precautions

Follow these safety precautions:

- Dell recommends that only individuals with rack-mounting experience install the storage system in a rack.
- Make sure the storage system is always fully grounded to prevent damage from electrostatic discharge.

- When handling the storage system hardware, use an electrostatic wrist guard (not included) or a similar form of protection.

The chassis must be mounted in a rack. The following safety requirements must be considered when the chassis is being mounted:

- The rack construction must be capable of supporting the total weight of the installed chassis. The design should incorporate stabilizing features suitable to prevent the rack from tipping or being pushed over during installation or in normal use.
- When loading a rack with chassis, fill from the bottom up; empty from the top down.
- To avoid danger of the rack toppling over, slide only one chassis out of the rack at a time.

Electrical Safety Precautions

Always follow electrical safety precautions to avoid injury and damage to Storage Center equipment.

 **WARNING: Disconnect power from the storage system when removing or installing components that are not hot-swappable. When disconnecting power, first power down the storage system using the Storage Manager and then unplug the power cords from all the power supplies in the storage system.**

- Provide a suitable power source with electrical overload protection. All Storage Center components must be grounded before applying power. Make sure that a safe electrical earth connection can be made to power supply cords. Check the grounding before applying power.
- The plugs on the power supply cords are used as the main disconnect device. Make sure that the socket outlets are located near the equipment and are easily accessible.
- Know the locations of the equipment power switches and the room's emergency power-off switch, disconnection switch, or electrical outlet.
- Do not work alone when working with high-voltage components.
- Use rubber mats specifically designed as electrical insulators.
- Do not remove covers from the power supply unit. Disconnect the power connection before removing a power supply from the storage system.
- Do not remove a faulty power supply unless you have a replacement model of the correct type ready for insertion. A faulty power supply must be replaced with a fully operational module power supply within 24 hours.
- Unplug the storage system chassis before you move it or if you think it has become damaged in any way. When powered by multiple AC sources, disconnect all power sources for complete isolation.

Electrostatic Discharge Precautions

Always follow electrostatic discharge (ESD) precautions to avoid injury and damage to Storage Center equipment.

Electrostatic discharge (ESD) is generated by two objects with different electrical charges coming into contact with each other. The resulting electrical discharge can damage electronic components and printed circuit boards. Follow these guidelines to protect your equipment from ESD:

- Dell recommends that you always use a static mat and static strap while working on components in the interior of the chassis.
- Observe all conventional ESD precautions when handling plug-in modules and components.
- Use a suitable ESD wrist or ankle strap.
- Avoid contact with backplane components and module connectors.
- Keep all components and printed circuit boards (PCBs) in their antistatic bags until ready for use.

General Safety Precautions

Always follow general safety precautions to avoid injury and damage to Storage Center equipment.

- Keep the area around the storage system chassis clean and free of clutter.
- Place any system components that have been removed away from the storage system chassis or on a table so that they are not in the way of other people.
- While working on the storage system chassis, do not wear loose clothing such as neckties and unbuttoned shirt sleeves. These items can come into contact with electrical circuits or be pulled into a cooling fan.
- Remove any jewelry or metal objects from your body. These items are excellent metal conductors that can create short circuits and harm you if they come into contact with printed circuit boards or areas where power is present.



- Do not lift the storage system chassis by the handles of the power supply units (PSUs). They are not designed to hold the weight of the entire chassis, and the chassis cover could become bent.
- Before moving the storage system chassis, remove the PSUs to minimize weight.
- Do not remove drives until you are ready to replace them.

NOTE: To ensure proper storage system cooling, hard drive blanks must be installed in any hard drive slot that is not occupied.

Prepare the Installation Environment

Make sure that the environment is ready for installing the Storage Center.

- **Rack Space** — The rack must have enough space to accommodate the storage system chassis, expansion enclosures, and switches.
- **Power** — Power must be available in the rack, and the power delivery system must meet the requirements of the Storage Center. AC input to the power supply is 200–240 V.
- **Connectivity** — The rack must be wired for connectivity to the management network and any networks that carry front-end I/O from the Storage Center to servers.

Install the Storage System in a Rack

Install the storage system and other Storage Center system components in a rack.

About this task

Mount the storage system and expansion enclosures in a manner that allows for expansion in the rack and prevents the rack from becoming top-heavy.

The SCv3000 and SCv3020 storage system ships with a ReadyRails II kit. The rails come in two different styles: tool-less and tooled. Follow the detailed installation instructions located in the rail kit box for your particular style of rails.

NOTE: Dell recommends using two people to install the rails, one at the front of the rack and one at the back.

Steps

1. Position the left and right rail end pieces labeled FRONT facing inward.
2. Align each end piece with the top and bottom holes of the appropriate U space.

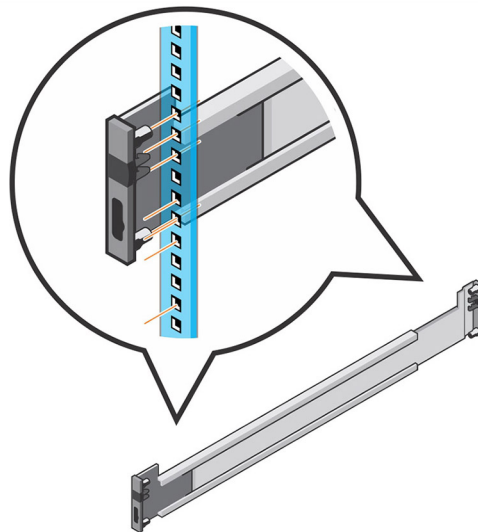

Figure 27. Attach the Rails to the Rack

3. Engage the back end of the rail until it fully seats and the latch locks into place.

4. Engage the front end of the rail until it fully seats and the latch locks into place.
5. Align the system with the rails and slide the storage system into the rack.

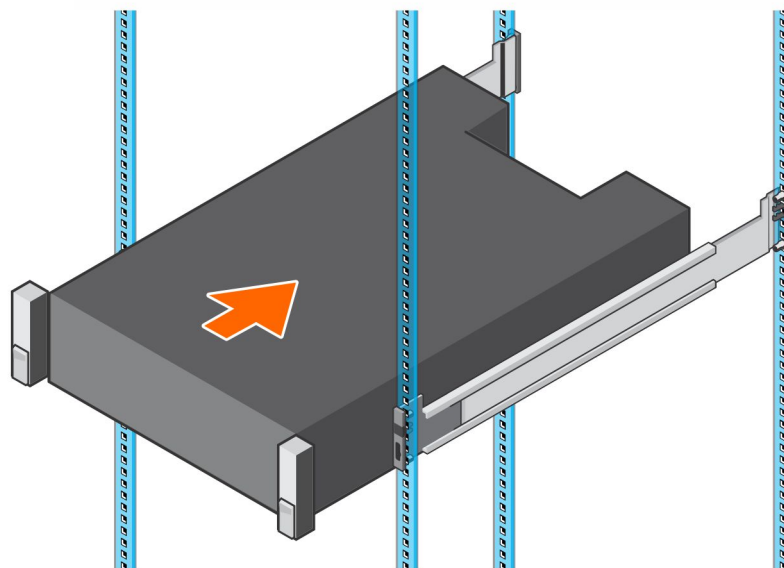

Figure 28. Slide the Storage System Onto the Rails

6. Lift the latches on each side of the front panel and tighten the screws to the rack.

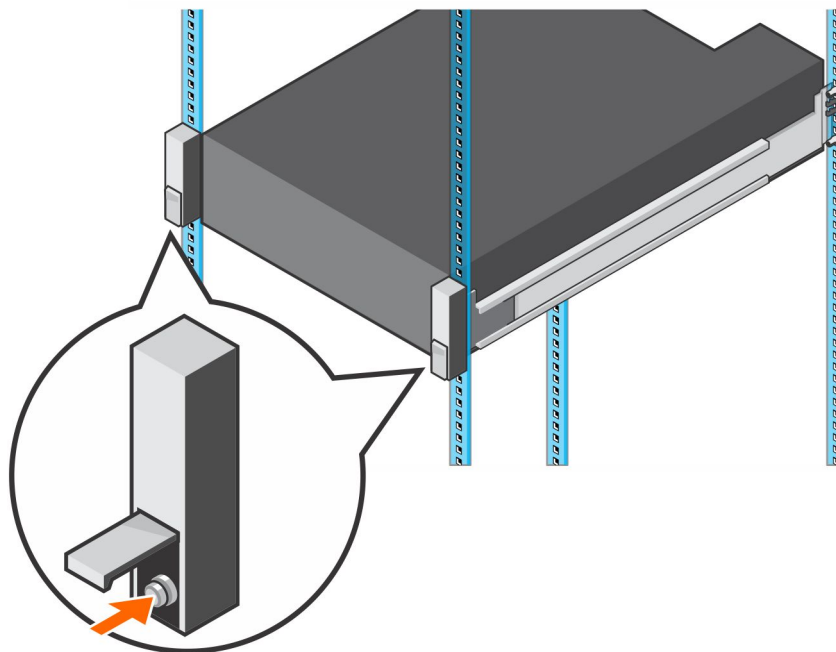

Figure 29. Tighten the Screws

If the Storage Center system includes expansion enclosures, mount the expansion enclosures in the rack. See the instructions included with the expansion enclosure for detailed steps.

Connect the Front-End Cabling

Front-end cabling refers to the connections between the storage system and external devices such as host servers or another Storage Center.

Dell recommends connecting the storage system to host servers using the most redundant option available. In addition, make sure that the speed of the HBAs in the storage controller match the speed of the host server.

Types of Redundancy for Front-End Connections

Front-end redundancy is achieved by eliminating single points of failure that could cause a server to lose connectivity to the Storage Center.

Depending on how the Storage Center is cabled and configured, the following types of redundancy are available.

Port Redundancy

If a port becomes unavailable because it is disconnected or a hardware failure has occurred, the port moves over to another port in the same fault domain.

Storage Controller Redundancy

To allow for storage controller redundancy, a front-end port on each storage controller must be connected to the same switch or server.

If a storage controller becomes unavailable, the front-end ports on the offline storage controller move over to the ports (in the same fault domain) on the available storage controller.

Multipath I/O (MPIO)

MPIO allows a server to use multiple paths for I/O if they are available.

MPIO software offers redundancy at the path level. MPIO typically operates in a round-robin manner by sending packets first down one path and then the other. If a path becomes unavailable, MPIO software continues to send packets down the functioning path.

 **NOTE: MPIO is operating-system specific, and it loads as a driver on the server or it is part of the server operating system.**

MPIO Behavior

The server must have at least two FC or iSCSI ports to use MPIO.

When MPIO is configured, a server can send I/O to multiple ports on the same storage controller.

MPIO Configuration Instructions for Host Servers

If a Dell Storage Manager wizard is used to configure host server access to the Storage Center, the Dell Storage Manager attempts to automatically configure MPIO with best practices.

 **NOTE: Compare the host server settings applied by the Dell Storage Manager wizard against the latest Dell Storage Center Best Practices documents (listed in the following table) on the Dell TechCenter site (<http://en.community.dell.com/techcenter/storage/>).**

Table 1. MPIO Configuration Documents

Operating System	Document with MPIO Instructions
Linux	<ul style="list-style-type: none">• <i>Dell Storage Center with Red Hat Enterprise Linux (RHEL) 6x Best Practices</i>• <i>Dell Storage Center with Red Hat Enterprise Linux (RHEL) 7x Best Practices</i>• <i>Dell Compellent Best Practices: Storage Center with SUSE Linux Enterprise Server 11</i>
VMware vSphere	<ul style="list-style-type: none">• <i>Dell Storage Center Best Practices with VMware vSphere 5.x</i>• <i>Dell Storage Center Best Practices with VMware vSphere 6.x</i>
Windows Server 2008, 2008 R2, 2012, and 2012 R2	<i>Dell Storage Center: Microsoft Multipath IO Best Practices</i>

Connecting to Host Servers with Fibre Channel HBAs

A storage system with Fibre Channel front-end ports connects to one or more FC switches, which connect to one or more host servers with Fibre Channel HBAs.

Fibre Channel Zoning

When using Fibre Channel for front-end connectivity, zones must be established to ensure that storage is visible to the servers. Use the zoning concepts discussed in this section to plan the front-end connectivity before starting to cable the storage system.

Dell recommends creating zones using a single initiator host port and multiple Storage Center ports.

WWN Zoning Guidelines

When WWN zoning is configured, a device may reside on any port, or change physical ports and still be visible, because the switch is seeking a WWN.

List of guidelines for WWN zoning.

- Include all Storage Center virtual World Wide Port Names (WWPNs) in a single zone.
- Include all Storage Center physical World Wide Port Names (WWPNs) in a single zone.
- For each host server HBA port, create a zone that includes the HBA port WWPN and multiple Storage Center virtual WWPNs on the same switch.
- For Fibre Channel replication from Storage Center system A to Storage Center system B:
 - Include all Storage Center physical WWPNs from system A and system B in a single zone.
 - Include all Storage Center physical WWPNs of system A and the virtual WWPNs of system B on the particular fabric.
 - Include all Storage Center physical WWPNs of system B and the virtual WWPNs of system A on the particular fabric.

 **NOTE: Some ports may not be used or dedicated for replication, however ports that are used must be in these zones.**

Fibre Channel Replication

Storage Center System A (Virtual Port Mode) to Storage Center System B (Virtual Port Mode)

- Include all Storage Center physical WWPNs from system A and system B in a single zone.
- Include all Storage Center physical WWPNs of system A and the virtual WWPNs of system B on the particular fabric.
- Include all Storage Center physical WWPNs of system B and the virtual WWPNs of system A on the particular fabric.

 **NOTE: Some ports may not be used or dedicated for replication, however ports that are used must be in these zones.**

Cable the Storage System with 2-Port Fibre Channel IO Cards

Connect the Fibre Channel ports on the storage controllers to host servers with Fibre Channel HBAs. The Fibre Channel ports of the storage controllers connect to the host servers through the Fibre Channel switches in the SAN.

About this task

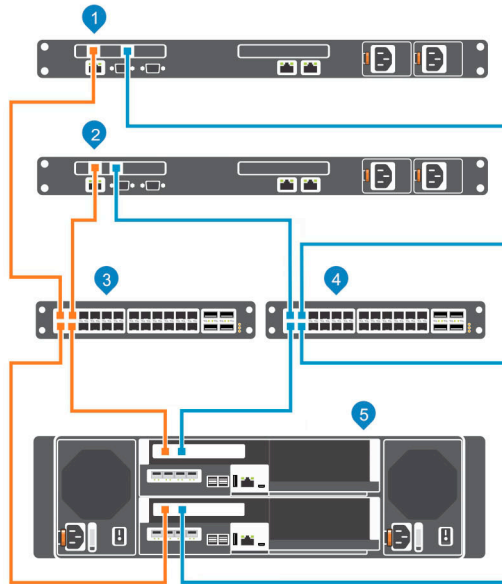

Figure 30. Connect the Storage System to Host Servers with Fibre Channel HBAs

- | | |
|--|--|
| 1. Host server | 2. Host server |
| 3. Fibre Channel switch 1 (member of fault domain 1) | 4. Fibre Channel switch 2 (member of fault domain 2) |
| 5. SCv3000 and SCv3020 storage system | |

Steps

1. Connect each host server to both Fibre Channel fabrics.
2. Connect Storage Center fault domain 1 (shown in orange) to fabric 1.
 - Connect port 1 of the Fibre Channel HBA in the top storage controller to switch 1.
 - Connect port 1 of the Fibre Channel HBA in the bottom storage controller to switch 1.
3. Connect Storage Center fault domain 2 (shown in blue) to fabric 2.
 - Connect port 2 of the Fibre Channel HBA in the top storage controller to switch 2.
 - Connect port 2 of the Fibre Channel HBA in the bottom storage controller to switch 2.

Cable the Storage System with 4-Port Fibre Channel IO Cards

Connect the Fibre Channel ports on the storage controllers to host servers with Fibre Channel HBAs. The Fibre Channel ports of the storage controllers connect to the host servers through the Fibre Channel switches in the SAN.

About this task

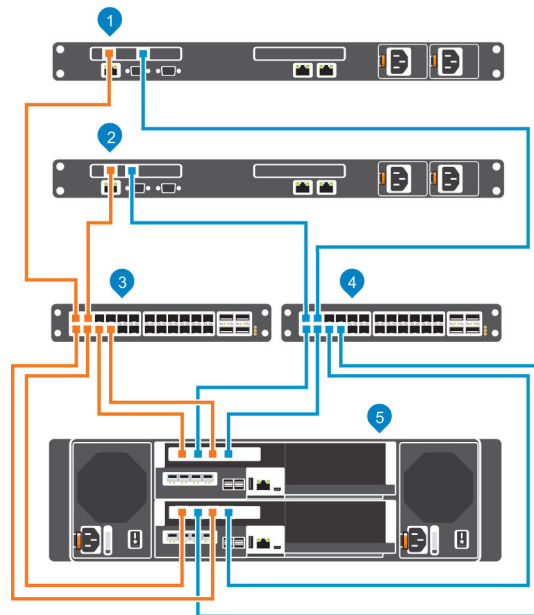

Figure 31. Connect the Storage System to Fibre Channel Host Servers

- | | |
|--|--|
| 1. Host server | 2. Host server |
| 3. Fibre Channel switch 1 (member of fault domain 1) | 4. Fibre Channel switch 2 (member of fault domain 2) |
| 5. SCv3000 and SCv3020 storage system | |

Steps

1. Connect each host server to both Fibre Channel fabrics.
2. Connect fault domain 1 (shown in orange) to fabric 1.
 - Connect port 1 of the Fibre Channel HBA in the top storage controller to switch 1.
 - Connect port 3 of the Fibre Channel HBA in the top storage controller to switch 1.
 - Connect port 1 of the Fibre Channel HBA in the bottom storage controller to switch 1.
 - Connect port 3 of the Fibre Channel HBA in the bottom storage controller to switch 1.
3. Connect fault domain 2 (shown in blue) to fabric 2.
 - Connect port 2 of the Fibre Channel HBA in the top storage controller to switch 2.
 - Connect port 4 of the Fibre Channel HBA in the top storage controller to switch 2.
 - Connect port 2 of the Fibre Channel HBA in the bottom storage controller to switch 2.
 - Connect port 4 of the Fibre Channel HBA in the bottom storage controller to switch 2.

Labeling the Front-End Cables

Label the front-end cables to indicate the storage controller and port to which they are connected.

Prerequisite

Locate the front-end cable labels that shipped with the storage system.

About this task

Apply cable labels to both ends of each cable that connects a storage controller to a front-end fabric or network, or directly to host servers.



Steps

1. Starting with the top edge of the label, attach the label to the cable near the connector.

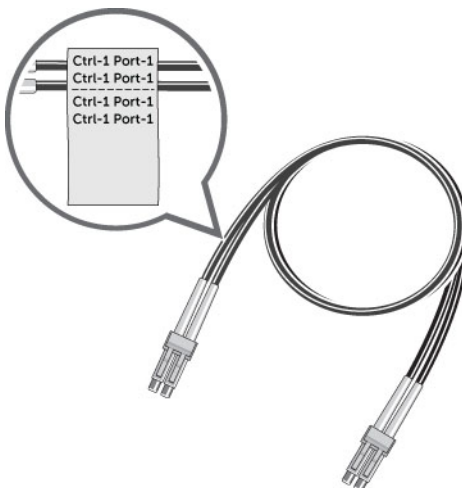

Figure 32. Attach Label to Cable

2. Wrap the label around the cable until it fully encircles the cable. The bottom of each label is clear so that it does not obscure the text.



Figure 33. Wrap Label Around Cable

3. Apply a matching label to the other end of the cable.

Connecting to Host Servers with iSCSI HBAs or Network Adapters

A storage system with iSCSI front-end ports connects to one or more Ethernet switches, which connect to one or more host servers with iSCSI HBAs or network adapters.

Cable the Storage System with 2-Port iSCSI IO Cards

Connect the iSCSI ports on the storage controllers to host servers with iSCSI HBAs. The iSCSI ports of the storage controllers connect to the host servers through the Ethernet switches in the SAN.

About this task

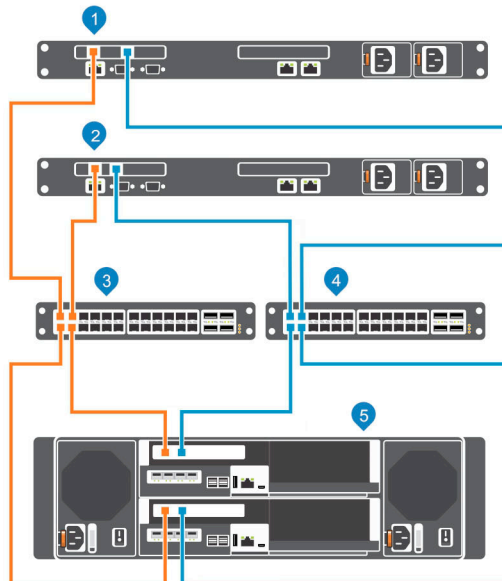

Figure 34. Connect the Storage System to Host Servers with iSCSI HBAs

- | | |
|---------------------------------------|---------------------------------------|
| 1. Host server | 2. Host server |
| 3. Ethernet switch 1 (fault domain 1) | 4. Ethernet switch 2 (fault domain 2) |
| 5. SCv3000 and SCv3020 storage system | |

Steps

1. Connect each host server to both iSCSI networks.
2. Connect fault domain 1 (shown in orange) to iSCSI network 1.
 - Connect port 1 of the iSCSI HBA in the top storage controller to switch 1.
 - Connect port 1 of the iSCSI HBA in the bottom storage controller to switch 1.
3. Connect iSCSI fault domain 2 (shown in blue) to iSCSI network 2.
 - Connect port 2 of the iSCSI HBA in the top storage controller to switch 2.
 - Connect port 2 of the iSCSI HBA in the bottom storage controller to switch 2.

Cable the Storage System with 4-Port iSCSI IO Cards

Connect the iSCSI ports on the storage controllers to host servers with iSCSI HBAs. The iSCSI ports of the storage controllers connect to the host servers through the Ethernet switches in the SAN.

About this task

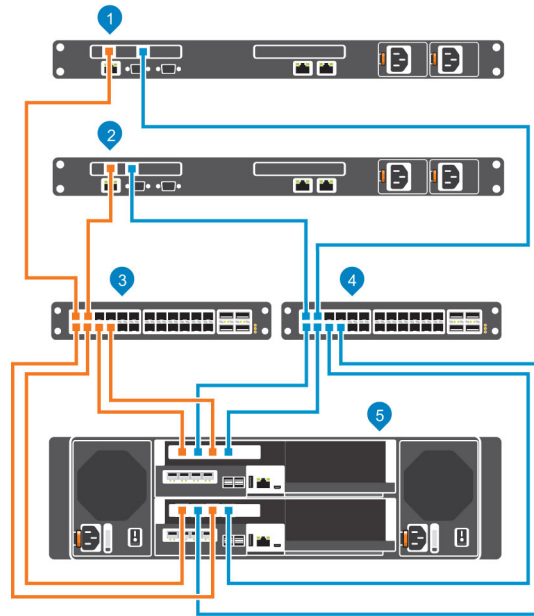

Figure 35. Connect the Storage System to Host Servers with iSCSI HBAs

- | | |
|---|---|
| 1. Host server | 2. Host server |
| 3. Ethernet switch 1 (member of fault domain 1) | 4. Ethernet switch 2 (member of fault domain 2) |
| 5. SCv3000 and SCv3020 storage system | |

Steps

1. Connect each host server to both iSCSI networks.
2. Connect fault domain 1 (shown in orange) to iSCSI network 1.
 - Connect port 1 of the iSCSI HBA in the top storage controller to switch 1.
 - Connect port 3 of the iSCSI HBA in the top storage controller to switch 1.
 - Connect port 1 of the iSCSI HBA in the bottom storage controller to switch 1.
 - Connect port 3 of the iSCSI HBA in the bottom storage controller to switch 1.
3. Connect iSCSI fault domain 2 (shown in blue) to iSCSI network 2.
 - Connect port 2 of the iSCSI HBA in the top storage controller to switch 2.
 - Connect port 4 of the iSCSI HBA in the top storage controller to switch 2.
 - Connect port 2 of the iSCSI HBA in the bottom storage controller to switch 2.
 - Connect port 4 of the iSCSI HBA in the bottom storage controller to switch 2.

Connect a Storage System to a Host Server Using an iSCSI Mezzanine Card

When connecting to multiple front-end protocols, you can use a mezzanine card to connect to iSCSI hosts. The iSCSI ports on the mezzanine card connect to the iSCSI host servers through the Ethernet switches in the SAN. The mezzanine card is only used when the HBA card slot in the storage controller is already populated with an HBA.

About this task

 **NOTE:** The ports on the mezzanine cards are numbered 1 to 4 from left to right.

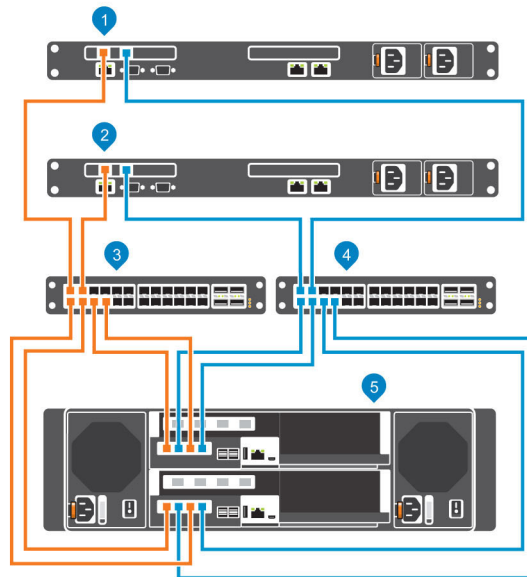



Figure 36. Connect iSCSI Ports to Host Servers with iSCSI HBAs

- | | |
|---|---|
| 1. Host server | 2. Host server |
| 3. Ethernet switch 1 (member of fault domain 1) | 4. Ethernet switch 2 (member of fault domain 2) |
| 5. SCv3000 and SCv3020 storage system | |

 **NOTE:** The mezzanine card is only used when the HBA card slot in the storage controller is already populated with an HBA. Cabling for the initial HBA card is not shown in the diagram above.

To connect the iSCSI host server to iSCSI networks:

Steps

1. Connect each iSCSI host server to both iSCSI networks.
2. Connect fault domain 1 (shown in orange) to iSCSI network 1.
 - Connect port 1 of the mezzanine card in the top storage controller to switch 1.
 - Connect port 3 of the mezzanine card in the top storage controller to switch 1.
 - Connect port 1 of the mezzanine card in the bottom storage controller to switch 1.
 - Connect port 3 of the mezzanine card in the bottom storage controller to switch 1.
3. Connect block access fault domain 2 (shown in blue) to iSCSI network 2.
 - Connect port 2 in the mezzanine card in the top storage controller to switch 2.
 - Connect port 4 in the mezzanine card in the top storage controller to switch 2.
 - Connect port 2 in the mezzanine card in the bottom storage controller to switch 2.
 - Connect port 4 in the mezzanine card in the bottom storage controller to switch 2.

Labeling the Front-End Cables

Label the front-end cables to indicate the storage controller and port to which they are connected.

Prerequisite

Locate the pre-made front-end cable labels that shipped with the storage system.

About this task

Apply cable labels to both ends of each cable that connects a storage controller to a front-end fabric or network, or directly to host servers.

Steps

1. Starting with the top edge of the label, attach the label to the cable near the connector.



Figure 37. Attach Label to Cable

2. Wrap the label around the cable until it fully encircles the cable. The bottom of each label is clear so that it does not obscure the text



Figure 38. Wrap Label Around Cable

3. Apply a matching label to the other end of the cable.

Connecting to Host Servers with SAS HBAs

An SCv3000 and SCv3020 storage system with front-end SAS ports connects directly to host servers with SAS HBAs.

Cable the Storage System with 4-Port SAS HBAs to Host Servers with One SAS HBA per Server

A storage system with four front-end SAS ports on each storage controller can connect to up to four host servers, if each host server has one SAS HBA with two ports.

About this task

This configuration includes four fault domains spread across both storage controllers. The storage controllers are connected to each host server using two SAS connections.

If a storage controller becomes unavailable, all of the standby paths on the other storage controller become active.

Steps

1. Connect fault domain 1 (shown in orange) to host server 1.
 - a. Connect a SAS cable from storage controller 1: port 1 to the SAS HBA on host server 1.
 - b. Connect a SAS cable from storage controller 2: port 1 to the SAS HBA on host server 1.
2. Connect fault domain 2 (shown in blue) to host server 2.
 - a. Connect a SAS cable from storage controller 1: port 2 to the SAS HBA on host server 2.
 - b. Connect a SAS cable from storage controller 2: port 2 to the SAS HBA on host server 2.
3. Connect fault domain 3 (shown in gray) to host server 3.
 - a. Connect a SAS cable from storage controller 1: port 3 to the SAS HBA on host server 3.
 - b. Connect a SAS cable from storage controller 2: port 3 to the SAS HBA on host server 3.
4. Connect fault domain 4 (shown in red) to host server 4.
 - a. Connect a SAS cable from storage controller 1: port 4 to the SAS HBA on host server 4.
 - b. Connect a SAS cable from storage controller 2: port 4 to the SAS HBA on host server 4.



Example

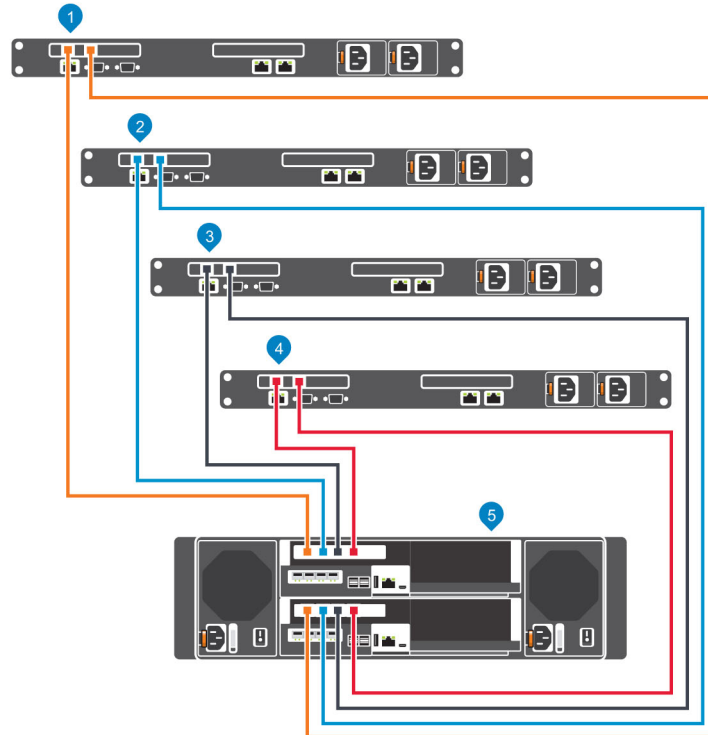

Figure 39. Storage System with Two 4-Port SAS Storage Controllers Connected to Four Host Servers with One SAS HBA per Server

Next step

Install or enable MPIO on the host servers.

 **NOTE:** For the latest best practices, see the Dell Storage Center Best Practices document on the Dell TechCenter site (<http://en.community.dell.com/techcenter/storage/>).

Labeling the Front-End Cables

Label the front-end cables to indicate the storage controller and port to which they are connected.

Prerequisite

Locate the pre-made front-end cable labels that shipped with the storage system.

About this task

Apply cable labels to both ends of each cable that connects a storage controller to a front-end fabric or network, or directly to host servers.

Steps

1. Starting with the top edge of the label, attach the label to the cable near the connector.

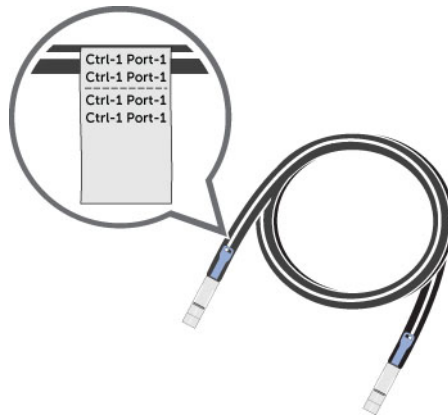

Figure 40. Attach Label to Cable

2. Wrap the label around the cable until it fully encircles the cable. The bottom of each label is clear so that it does not obscure the text.



Figure 41. Wrap Label Around Cable

3. Apply a matching label to the other end of the cable.

Attach Host Servers (Fibre Channel)

Install the Fibre Channel host bus adapters (HBAs), install the drivers, and make sure that the latest supported firmware is installed.

About this task

- Contact your solution provider for a list of supported Fibre Channel HBAs.
- Refer to the *Dell Storage Compatibility Matrix* for a list of supported Fibre Channel HBAs.

Steps





1. Install Fibre Channel HBAs in the host servers.

 **NOTE: Do not install Fibre Channel HBAs from different vendors in the same server.**

2. Install supported drivers for the HBAs and make sure that the HBAs have the latest supported firmware.
3. Use the Fibre Channel cabling diagrams to cable the host servers to the switches. Connecting host servers directly to the storage system without using Fibre Channel switches is not supported.

Attach the Host Servers (iSCSI)

Install the iSCSI host bus adapters (HBAs) or iSCSI network adapters, install the drivers, and make sure that the latest supported firmware is installed.

- Contact your solution provider for a list of supported iSCSI HBAs.
- Refer to the *Dell Storage Compatibility Matrix* for a list of supported HBAs.
- If the host server is a Windows or Linux host:
 - a. Install the iSCSI HBAs or network adapters dedicated for iSCSI traffic in the host servers.
 -  **NOTE: Do not install iSCSI HBAs or network adapters from different vendors in the same server.**
 - b. Install supported drivers for the HBAs or network adapters and make sure that the HBAs or network adapter have the latest supported firmware.
 - c. Use the host operating system to assign IP addresses for each iSCSI port. The IP addresses must match the subnets for each fault domain.
 -  **CAUTION: Correctly assign IP addresses to the HBAs or network adapters. Assigning IP addresses to the wrong ports can cause connectivity issues.**
 -  **NOTE: If using jumbo frames, they must be enabled and configured on all devices in the data path, adapter ports, switches, and storage system.**
 - d. Use the iSCSI cabling diagrams to cable the host servers to the switches. Connecting host servers directly to the storage system without using Ethernet switches is not supported.
- If the host server is a vSphere host:
 - a. Install the iSCSI HBAs or network adapters dedicated for iSCSI traffic in the host servers.
 - b. Install supported drivers for the HBAs or network adapters and make sure that the HBAs or network adapter have the latest supported firmware.
 - c. If the host uses network adapters for iSCSI traffic, create a VMkernel port for each network adapter (1 VMkernel per vSwitch).
 - d. Use the host operating system to assign IP addresses for each iSCSI port. The IP addresses must match the subnets for each fault domain.
 -  **CAUTION: Correctly assign IP addresses to the HBAs or network adapters. Assigning IP addresses to the wrong ports can cause connectivity issues.**
 -  **NOTE: If using jumbo frames, they must be enabled and configured on all devices in the data path, adapter ports, switches, and storage system.**
 - e. If the host uses network adapters for iSCSI traffic, add the VMkernel ports to the iSCSI software initiator.
 - f. Use the iSCSI cabling diagrams to cable the host servers to the switches. Connecting host servers directly to the storage system without using Ethernet switches is not supported.

Attach the Host Servers (SAS)

On each host server, install the SAS host bus adapters (HBAs), install the drivers, and make sure that the latest supported firmware is installed.

About this task

-  **NOTE: Refer to the *Dell Storage Compatibility Matrix* for a list of supported SAS HBAs.**

Steps

1. Install the SAS HBAs in the host servers.
 -  **NOTE: Do not install SAS HBAs from different vendors in the same server.**
2. Install supported drivers for the HBAs and make sure that the HBAs have the latest supported firmware installed.
3. Use the SAS cabling diagram to cable the host servers directly to the storage system.

 **NOTE:** If deploying vSphere hosts, configure only one host at a time.

Connect the Management Ports to the Management Network

Connect the management port on each storage controller to the management network.

About this task

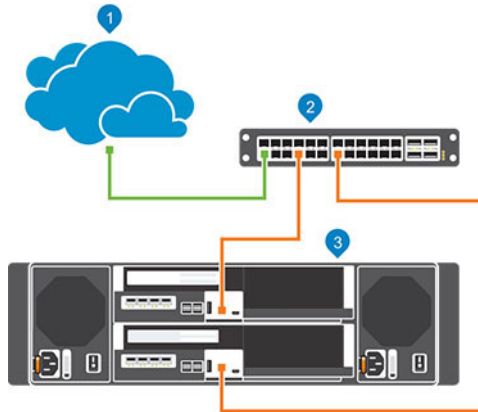

Figure 42. Connect the Management Ports to the Management Network

1. Management network
2. Ethernet switch
3. SCv3000 and SCv3020 storage system

Steps

1. Connect the Ethernet switch to the management network.
2. Connect the management ports to the Ethernet switch.
 - Connect the management port on the top storage controller to the Ethernet switch.
 - Connect the management port on the bottom storage controller to the Ethernet switch.

Labeling the Ethernet Management Cables

Label the Ethernet management cables that connect each storage controller to an Ethernet switch.

Prerequisite

Locate the Ethernet management cable labels that shipped with the SCv3000 and SCv3020 storage system.

About this task

Apply cable labels to both ends of each Ethernet management cable.

Steps

1. Starting with the top edge of the label, attach the label to the cable near the connector.



Figure 43. Attach Label to Cable

2. Wrap the label around the cable until it fully encircles the cable. The bottom of each label is clear so that it does not obscure the text.



Figure 44. Wrap Label Around Cable

3. Apply a matching label to the other end of the cable.

Connect the Back-End Cabling

Back-end cabling refers to the connections between the storage system and expansion enclosures.

An SCv3000 and SCv3020 storage system can be deployed with or without expansion enclosures.

 **NOTE: When expansion enclosures are not used, there is no need to interconnect the SAS port of a storage controller.**

Expansion Enclosure Cabling Guidelines

The connection between a storage system and expansion enclosures is referred to as a SAS chain. A SAS chain is made up of two paths, which are referred to as the A side and B side. Each side of the SAS chain starts at a SAS port on one storage controller and ends at a SAS port the other storage controller.

You can connect multiple SCv300 and SCv320 expansion enclosures to an SCv3000 and SCv3020 by cabling the expansion enclosures in series.

Back-End SAS Redundancy

Use redundant SAS cabling to make sure that an unavailable I/O port or storage controller does not cause a Storage Center outage. If an I/O port or storage controller becomes unavailable, the Storage Center I/O continues on the redundant path.

Back-End Connections for an SCv3000 and SCv3020 Storage System With Expansion Enclosures

The SCv3000 and SCv3020 supports up to 16 SCv300 expansion enclosures, up to eight SCv320 expansion enclosures, and up to three SCv360 expansion enclosures per SAS chain.

The following sections show common cabling between the SCv3000 and SCv3020 and expansion enclosures. Locate the scenario that most closely matches the Storage Center that you are configuring and follow the instructions, modifying them as necessary.

SCv3000 and SCv3020 and One SCv300 and SCv320 Expansion Enclosure

This figure shows an SCv3000 and SCv3020 storage system cabled to one SCv300 and SCv320 expansion enclosure.

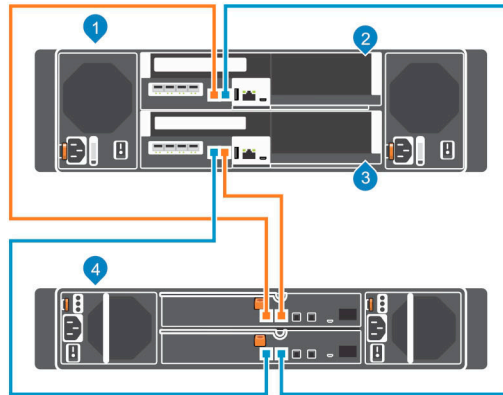

Figure 45. SCv3000 and SCv3020 and One SCv300 and SCv320 Expansion Enclosure

- | | |
|-------------------------|-------------------------|
| 1. Storage system | 2. Storage controller 1 |
| 3. Storage controller 2 | 4. Expansion enclosure |

The following table describes the back-end SAS connections from an SCv3000 and SCv3020 storage system to one SCv300 and SCv320 expansion enclosure.

Table 2. SCv3000 and SCv3020 Connected to One SCv300 and SCv320 Expansion Enclosure

Path	Connections
Chain 1: Side A (orange)	<ol style="list-style-type: none"> Storage controller 1: port 1 to the expansion enclosure: top EMM, port 1 Expansion enclosure: top EMM, port 2 to storage controller 2: port 2
Chain 1: Side B (blue)	<ol style="list-style-type: none"> Storage controller 2: port 1 to the expansion enclosure: bottom EMM, port 1 Expansion enclosure: bottom EMM, port 2 to storage controller 1: port 2

SCv3000 and SCv3020 and Two SCv300 and SCv320 Expansion Enclosures

This figure shows an SCv3000 and SCv3020 storage system cabled to two SCv300 and SCv320 expansion enclosures.

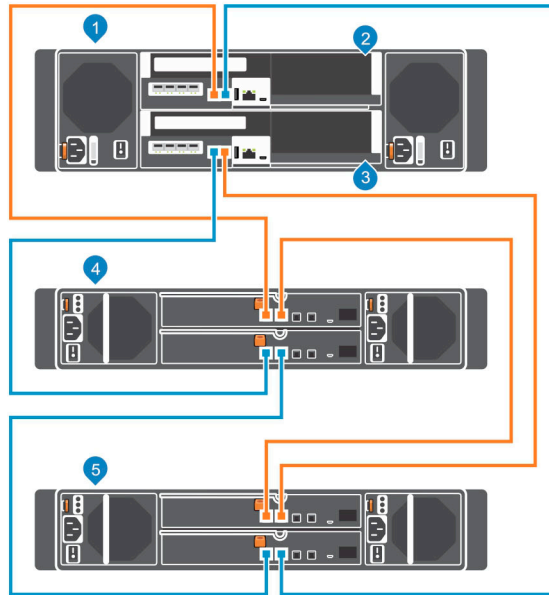

Figure 46. SCv3000 and SCv3020 and Two SCv300 and SCv320 Expansion Enclosures

- | | |
|--------------------------|--------------------------|
| 1. Storage system | 2. Storage controller 1 |
| 3. Storage controller 2 | 4. Expansion enclosure 1 |
| 5. Expansion enclosure 2 | |

The following table describes the back-end SAS connections from an SCv3000 and SCv3020 storage system to two SCv300 and SCv320 expansion enclosures.

Table 3. SCv3000 and SCv3020 Connected to Two SCv300 and SCv320 Expansion Enclosures

Path	Connections
Chain 1: Side A (orange)	<ol style="list-style-type: none"> Storage controller 1: port 1 to expansion enclosure 1: top EMM, port 1 Expansion enclosure 1: top EMM, port 2 to expansion enclosure 2: top EMM, port 1 Expansion enclosure 2: top EMM, port 2 to storage controller 2: port 2
Chain 1: Side B (blue)	<ol style="list-style-type: none"> Storage controller 2: port 1 to expansion enclosure 1: bottom EMM, port 1 Expansion enclosure 1: bottom EMM, port 2 to expansion enclosure 2: bottom EMM, port 1 Expansion enclosure 2: bottom EMM, port 2 to storage controller 1: port 2

SCv3000 and SCv3020 Storage System and One SCv360 Expansion Enclosure

This figure shows an SCv3000 and SCv3020 storage system cabled to one SCv360 expansion enclosure.

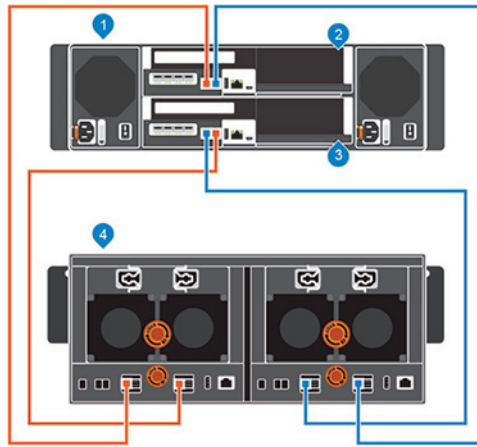

Figure 47. SCv3000 and SCv3020 and One SCv360 Expansion Enclosure

- | | |
|-------------------------|-------------------------|
| 1. Storage system | 2. Storage controller 1 |
| 3. Storage controller 2 | 4. Expansion enclosure |

The following table describes the back-end SAS connections from an SCv3000 and SCv3020 storage system to one SCv360 expansion enclosure

Table 4. SCv3000 and SCv3020 and One SCv360 Expansion Enclosure

Path	Connections
Chain 1: Side A (orange)	<ol style="list-style-type: none"> Storage controller 1: port 1 to the expansion enclosure: left EMM, port 1 Expansion enclosure: left EMM, port 3 to storage controller 2: port 2
Chain 1: Side B (blue)	<ol style="list-style-type: none"> Storage controller 2: port 1 to the expansion enclosure: right EMM, port 1 Expansion enclosure: right EMM, port 3 to storage controller 1: port 2

SCv3000 and SCv3020 Storage System and Two SCv360 Expansion Enclosures

This figure shows an SCv3000 and SCv3020 storage system cabled to two SCv360 expansion enclosures.

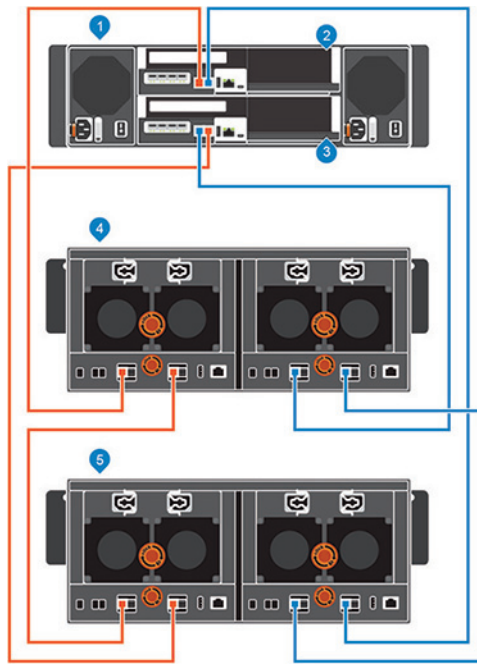

Figure 48. SCv3000 and SCv3020 and Two SCv360 Expansion Enclosures

- | | |
|--------------------------|--------------------------|
| 1. Storage system | 2. Storage controller 1 |
| 3. Storage controller 2 | 4. Expansion enclosure 1 |
| 5. Expansion enclosure 2 | |

The following table describes the back-end SAS connections from an SCv3000 and SCv3020 storage system to two SCv360 expansion enclosures.

Table 5. SCv3000 and SCv3020 and Two SCv360 Expansion Enclosures

Path	Connections
Chain 1: Side A (orange)	<ol style="list-style-type: none"> Storage controller 1: port 1 to expansion enclosure 1: left EMM, port 1 Expansion enclosure 1: left EMM, port 3 to expansion enclosure 2: left EMM, port 1 Expansion enclosure 2: left EMM, port 3 to storage controller 2: port 2
Chain 1: Side B (blue)	<ol style="list-style-type: none"> Storage controller 2: port 1 to expansion enclosure 1: right EMM, port 1 Expansion enclosure 1: right EMM, port 3 to expansion enclosure 2: right EMM, port 1 Expansion enclosure 2: right EMM, port 3 to storage controller 1: port 2

Label the Back-End Cables

Label the back-end cables that interconnect the storage controllers or label the back-end cables that connect the storage system to the expansion enclosures.

Prerequisite

Locate the cable labels provided with the expansion enclosures.

About this task

Apply cable labels to both ends of each SAS cable to indicate the chain number and side (A or B).

Steps

- Starting with the top edge of the label, attach the label to the cable near the connector.



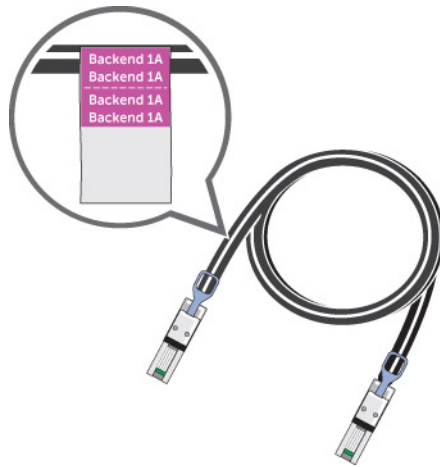

Figure 49. Attach Label to Cable

2. Wrap the label around the cable until it fully encircles the cable. The bottom of each label is clear so that it does not obscure the text.

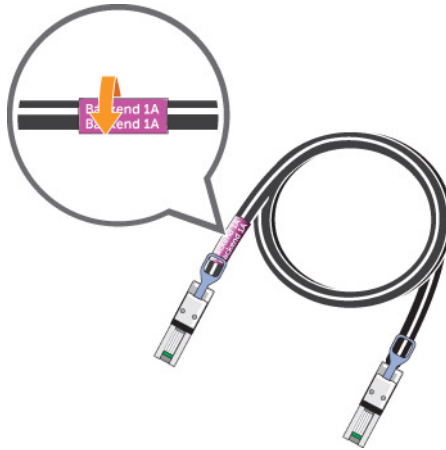

Figure 50. Wrap Label Around Cable

3. Apply a matching label to the other end of the cable.

Discover and Configure the Storage Center

The Discover and Configure Uninitialized Storage Centers wizard sets up a Storage Center to make it ready for volume creation. Use the Dell Storage Manager to discover and configure the Storage Center. After configuring a Storage Center, you can set up a localhost or VMware vSphere host using the host setup wizards.

The storage system hardware must be installed and cabled before the Storage Center can be configured.

Connect Power Cables and Turn On the Storage System

Connect power cables to the storage system components and turn on the hardware.

About this task

- If the storage system is installed without expansion enclosures, connect power cables to the storage system chassis and turn on the storage system.
- If the storage system is installed with expansion enclosures, connect power cables to the expansion enclosure chassis. Make sure you power on each expansion enclosure before turning on the storage system.

NOTE: When powering on expansion enclosures with spinning hard drives, wait approximately three minutes for the drives to spin up before powering on the storage system.

Steps

1. Make sure that the power switches are in the OFF position before connecting the power cables.
2. Connect the power cables securely to both power supply/cooling fan modules in the storage system chassis.

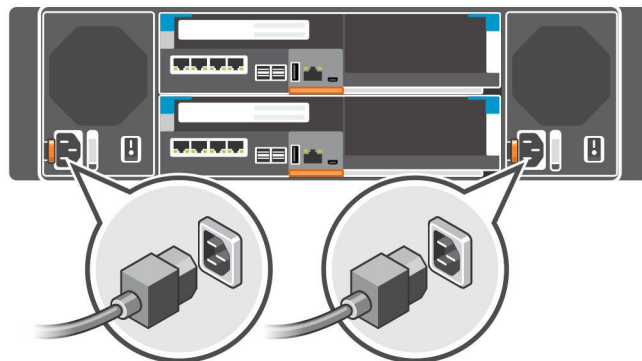

Figure 51. Connect the Power Cables

3. Connect the power cables plugged into the left power supply to one power distribution unit (PDU).
4. Connect the power cables plugged into the right power supply to a second power distribution unit (PDU).
5. Turn on the storage system by pressing the power switches on both power supply/cooling fan modules to the ON position.



Figure 52. Turn On the Storage System

CAUTION: Do not power off the storage system until it can be discovered with Storage Manager. During the initial power up, the storage system might take up to twenty minutes to boot completely.

NOTE:

- If the LEDs on a storage controller do not turn on, the storage controller might not be fully seated in the storage system chassis. If this issue occurs, press both power buttons to turn off the storage system. Reseat the storage controller, and then press both power buttons again to turn on the storage system.
- If the power supply units do not power on, confirm that the power source is 200 to 240 volts (V). The 200 to 240 V power supply units do not display any LED indications if they are plugged into a 110 V outlet.

Locate Your Service Tag

Your storage system is identified by a unique service tag and Express Service Code.

The Service Tag and Express Service Code are found on the front of the system by pulling out the information tag. Alternatively, the information might be on a sticker on the back of the storage system chassis. This information is used by Dell to route support calls to the appropriate personnel. This information is used by the manufacturer to route support calls to the appropriate personnel.

NOTE: The Quick Resource Locator (QRL) code on the information tag is unique to your system. Scan the QRL to get immediate access to your system information using your smart phone or tablet.

Record System Information

Use the worksheet found in the appendix of this guide to record the information you will need to install the SCv3000 and SCv3020 storage system.

Supported Operating Systems for Storage Center Automated Setup

Setting up a Storage Center using the Discover and Configure Uninitialized Storage Centers wizard and the host setup wizards requires 64-bit versions of the following operating systems:

- Red Hat Enterprise Linux 6 or later
- SUSE Linux Enterprise 12 or later
- Windows Server 2008 R2 or later

Install and Use the Dell Storage Manager

You must start the Dell Storage Manager as an Administrator to run the Discover and Configure Uninitialized Storage Centers wizard.

1. Install the Dell Storage Manager on a host server.



To discover and configure a Storage Center, the software must be installed on a host server that is on the same subnet as the storage system.

2. To start the software on a Windows computer, right-click on the Dell Storage Manager shortcut and select **Run as administrator**. To start the software on a Linux computer, execute the command `./Client` from the `var/lib/dell/bin` directory.
3. Click **Discover and Configure Uninitialized Storage Centers**. The **Discover and Configure Uninitialized Storage Centers** wizard appears.

Discover and Select an Uninitialized Storage Center

The first page of the Discover and Configure Uninitialized Storage Centers wizard provides a list of prerequisite actions and information required before setting up a Storage Center.

Prerequisites

- The host server, on which the Storage Manager software is installed, must be on the same subnet or VLAN as the Storage Center.
- Temporarily disable any firewall on the host server that is running the Storage Manager.
- Layer 2 multicast must be allowed on the network.
- Make sure that IGMP snooping is disabled on the switch ports connected to the Storage Center.

Steps

1. Make sure that you have the required information that is listed on the first page of the wizard. This information is needed to configure the Storage Center.
2. Click **Next**. The **Select a Storage Center to Initialize** page appears and lists the uninitialized Storage Centers discovered by the wizard.



NOTE: If the wizard does not discover the Storage Center that you want to initialize, perform one of the following actions:

- Make sure that the Storage Center hardware is physically attached to all necessary networks.
 - Click **Rediscover**.
 - Click **Troubleshoot Storage Center Hardware Issue** to learn more about reasons why the Storage Center is not discoverable.
 - Follow the steps in *Deploy the Storage Center Using the Direct Connect Method*.
3. Select the Storage Center to initialize.
 4. (Optional) Click **Enable Storage Center Indicator** to turn on the indicator light for the selected Storage Center. You can use the indicator to verify that you have selected the correct Storage Center.
 5. Click **Next**.
 6. If the Storage Center is partially configured, the Storage Center login pane appears. Enter the management IPv4 address and the Admin password for the Storage Center, then click **Next** to continue.

Deploy the Storage Center Using the Direct Connect Method

Use the direct connect method to manually deploy the Storage Center when it is not discoverable.

1. Use an Ethernet cable to connect the computer running the Dell Storage Manager to the management port of the top controller.
2. Cable the bottom controller to the management network switch.
3. Click **Discover and Configure Uninitialized Storage Centers**. The **Discover and Configure Uninitialized Storage Centers** wizard opens.
4. Fill out the information the initial configuration pages and stop when the **Confirm Configuration** page is displayed.
5. At this point, recable the management port of the top controller to the management network.
6. Connect the computer to the same subnet or VLAN as the Storage Center.
 - a. Click **Next**.
 - b. If the cable is not properly connected or the host cannot access the controller, an **Error setting up connection** message is displayed. Correct the connection, and click **OK**.



- c. If the deployment wizard is closed, click **Discover and Configure Uninitialized Storage Centers** to relaunch the deployment wizard.
- d. Type Admin in the **User Name** field, type the password entered on the **Set Administrator Information** page in the **Password** field, and click **Next**.

Customer Installation Authorization

Authorize the installation of the storage system.

1. Type your name in the **Approving Customer Name** field.
2. Type your title in the **Approving Customer Title** field.
3. Click **OK**.

Set System Information

Use the **Set System Information** page to provide Storage Center and storage controller configuration information. This information is needed when connecting to the Storage Center using Storage Manager.

1. Type a descriptive name for the Storage Center in the **Storage Center Name** field.
2. Type the system management IPv4 address for the Storage Center in the **Virtual Management IPv4 Address** field.
The virtual management IPv4 address is the IP address used to manage the Storage Center. The virtual management IPv4 address is different than the storage controller management IPv4 addresses.
3. Type the management IPv4 address for the top storage controller in the **Top Controller Management IPv4 Address** field.
4. Type the management IPv4 address for the bottom storage controller in the **Bottom Controller Management IPv4 Address** field.

 **NOTE: The storage controller management IPv4 addresses and virtual management IPv4 address must be within the same subnet.**

5. Type the subnet mask of the management network in the **Subnet Mask** field.
6. Type the gateway address of the management network in the **Gateway IPv4 Address** field.
7. Type the domain name of the management network in the **Domain Name** field.
8. Type the DNS server addresses of the management network in the **DNS Server** and **Secondary DNS Server** fields.
9. Click **Next**.

The **Set Administrator Information** page opens.

Set Administrator Information

Use the Set Administrator Information page to set a new password and an email address for the Admin user.

1. Type a new password for the default Storage Center administrator user in the **New Admin Password** and **Confirm Password** fields.
2. Type the email address of the default Storage Center administrator user in the **Admin Email Address** field.
3. Click **Next**.
 - For a storage system with Fibre Channel ports, the **Confirm Configuration** page opens.
 - For a storage system with iSCSI ports, the **Configure iSCSI Fault Tolerance** page opens.
 - For a storage system with front-end SAS ports, the **Confirm Configuration** page opens.
4. Verify the information and click **Apply Configuration**. After you click **Apply Configuration**, you will not be able to change the information until after the Storage Center is fully configured.

Confirm the Storage Center Configuration

Make sure that the configuration information shown on the Confirm Configuration page is correct before continuing.

1. Verify that the Storage Center settings are correct.
2. If the configuration information is correct, click **Apply Configuration**.
If the configuration information is incorrect, click **Back** and provide the correct information.

 **NOTE: After you click the Apply Configuration button, the configuration cannot be changed until after the Storage Center is fully configured.**

Initialize the Storage Center

The Storage Center sets up the storage system using the information provided on the previous pages.

1. The Storage Center performs system setup tasks. The **Initialize Storage Center** page displays the status of these tasks.
To learn more about the initialization process, click **More information about Initialization**.
 - If one or more of the system setup tasks fails, click **Troubleshoot Initialization Error** to learn how to resolve the issue.
 - If the Configuring Disks task fails, click **View Disks** to see the status of the drives detected by the Storage Center.
 - If any of the Storage Center front-end ports are down, the **Storage Center Front-End Ports Down** dialog box opens. Select the ports that are not connected to the storage network, then click **OK**.
2. When all of the Storage Center setup tasks are complete, click **Next**.

Configure Key Management Server Settings

The Key Management Server Settings page opens if the Storage Center is licensed for SEDs. Use this page to specify the key management server network settings and select the SSL certificate files.

1. Specify the network settings for the key management server.
2. If the key management server is configured to verify client certificates against credentials, type the user name and password of the certificates.
3. Select the key manager server certificate files.
4. Click **Next**.

Create a Storage Type

Select the datapage size and redundancy level for the Storage Center.

1. Select a datapage size.
 - **Standard (2 MB Datapage Size)**: Default datapage size, this selection is appropriate for most applications.
 - **High Performance (512 KB Datapage Size)**: Appropriate for applications with high performance needs, or in environments in which snapshots are taken frequently under heavy IO. Selecting this size increases overhead and reduces the maximum available space in the Storage Type. Flash Optimized storage types use 512 KB by default.
 - **High Density (4 MB Datapage Size)**: Appropriate for systems that use a large amount of disk space and take snapshots infrequently.
2. Modify the redundancy for each tier as needed.
 - For single-redundant RAID levels, select **Redundant**.
 - For dual-redundant RAID levels, select **Dual Redundant**.
3. To have the system attempt to keep existing drives on the same redundancy level when adding new drives, select the **Attempt to maintain redundancy when adding or removing disks** check box.
4. Click **Next**.



Configure Ports

Set up Fibre Channel, iSCSI and SAS ports.

1. Select the check box of each type of port you want to configure. You must select at least one type to continue.

 **NOTE: If a port type is grayed out, no ports of that type have been detected.**

2. Click **Next**.

Configure Fibre Channel Ports

For a Storage Center with Fibre Channel front-end ports, the Review Fault Domains page displays information about the fault domains that were created by the Storage Center.

Prerequisite

One port from each controller within the same fault domain must be cabled.

 **NOTE: If the Storage Center is not cabled correctly to create fault domains, the Cable Ports page opens and explains the issue. Click Refresh after cabling more ports.**

Steps

1. Review the fault domains that have been created.
2. (Optional) Click **Copy to clipboard** to copy the fault domain information.
3. (Optional) Review the information on the **Zoning**, **Hardware**, and **Cabling Diagram** tabs.

 **NOTE: The ports must already be zoned.**

4. Click **Next**.

Configure iSCSI Ports

For a Storage Center with iSCSI front-end ports, enter network information for the fault domains and ports.

Prerequisite

One port from each controller within the same fault domain must be cabled.

 **NOTE: If the Storage Center is not cabled correctly to create fault domains, the Cable Ports page opens and explains the issue. Click Refresh after cabling more ports.**

Steps

1. On the **Set IPv4 Addresses for iSCSI Fault Domain 1** page, enter network information for the fault domain and its ports.

 **NOTE: Make sure that all the IP addresses for iSCSI Fault Domain 1 are in the same subnet.**

2. Click **Next**.

3. On the **Set IPv4 Addresses for iSCSI Fault Domain 2** page, enter network information for the fault domain and its ports. Then click **Next**.

 **NOTE: Make sure that all the IP addresses for iSCSI Fault Domain 2 are in the same subnet.**

4. Click **Next**.
5. Review the fault domain information.
6. (Optional) Click **Copy to clipboard** to copy the fault domain information.
7. (Optional) Review the information on the **Hardware** and **Cabling Diagram** tabs.
8. Click **Next**.

Configure SAS Ports

For a Storage Center with SAS front-end ports, the Review Fault Domains page displays information about the fault domains that were created by the Storage Center.

Prerequisites

- One port from each controller within the same fault domain must be cabled.
- The ports for each fault domain must be cabled to the same server.

 **NOTE: If the Storage Center is not cabled correctly to create fault domains, the Cable Ports page opens and explains the issue. Click Refresh after cabling more ports.**

Steps

1. Review the fault domains that have been created.
2. (Optional) Click **Copy to clipboard** to copy the fault domain information.
3. (Optional) Review the information on the **Hardware** and **Cabling Diagram** tabs.
4. Click **Next**.

Configure Time Settings

Configure an NTP server to set the time automatically, or set the time and date manually.

1. From the **Region** and **Time Zone** drop-down menus, select the region and time zone used to set the time.
2. Select **Use NTP Server** and type the host name or IP address of the NTP server, or select **Set Current Time** and set the time and date manually.
3. Click **Next**.

Configure SMTP Server Settings

Enable SMTP email to receive information from the Storage Center about errors, warnings, and events.

1. Select **Enable SMTP Email**.
2. Configure the SMTP server settings.
 - a. In the **Recipient Email Address** field, type the email address where the information will be sent.
 - b. In the **SMTP Mail Server** field, type the IP address or fully qualified domain name of the SMTP email server. Click **Test Server** to verify connectivity to the SMTP server.
 - c. (Optional) In the **Backup SMTP Server** field, type the IP address or fully qualified domain name of a backup SMTP email server. Click **Test Server** to verify connectivity to the SMTP server.
 - d. If the SMTP server requires emails to contain a MAIL FROM address, specify an email address in the **Sender Email Address** field.
 - e. (Optional) In the **Common Subject Line** field, type a subject line to use for all emails sent by the Storage Center.
 - f. If the SMTP server requires clients to authenticate before sending email, select the **Use Authorized Login (AUTH LOGIN)** checkbox, then type a user name and password in the **Login ID** and **Password** fields.
3. Click **Next**.

Using Dell SupportAssist

As an integral part of Dell's ability to provide best-of-class support for your Enterprise-class products, Dell SupportAssist proactively provides the information required to diagnose support issues, enabling the most efficient support possible and reducing the effort required by you.

A few key benefits of SupportAssist are:

- Enables proactive service requests and real-time troubleshooting



- Supports automatic case creation based on event alerting
- Enables ProSupport Plus and optimizes service delivery
- Provides automatic health checks
- Enables remote Storage Center updates

Dell strongly recommends enabling comprehensive support service at time of incident and proactive service with SupportAssist.

Enable SupportAssist

The SupportAssist Data Collection and Storage page displays the text of the SupportAssist data agreement and allows you to accept or opt out of using SupportAssist.

1. To allow SupportAssist to collect diagnostic data and send this information to Dell Technical Support, select **By checking this box you accept the above terms**.
2. Click **Next**.
3. If you did not select **By checking this box you accept the above terms**, the **SupportAssist Recommended** pane opens.
 - Click **No** to return to the **SupportAssist Data Collection and Storage** page and accept the agreement.
 - Click **Yes** to opt out of using SupportAssist and proceed to the **Update Storage Center** page.

Review the SupportAssist Data Collection and Storage Agreement

The **SupportAssist Data Collection and Storage** page displays the text of the SupportAssist data agreement and allows you to accept or opt out of using SupportAssist.

1. To allow SupportAssist to collect diagnostic data and send this information to Dell Technical Support, select **By checking this box you accept the above terms**.
2. Click **Next**.
3. If you did not select **By checking this box you accept the above terms**, the **SupportAssist Recommended** pane opens.
 - Click **No** to return to the **SupportAssist Data Collection and Storage** page and accept the agreement.
 - Click **Yes** to opt out of using SupportAssist and proceed to the **Update Storage Center** page.
4. If the Support data agreement is not accepted, the Storage Center cannot check for updates. To proceed without checking for updates, click **Next**.

You will have to use the Storage Center Update Utility to update the Storage Center software before continuing. See the *Dell Storage Center Update Utility Administrator's Guide* or contact Dell Technical Support for detailed instructions about using the Storage Center Update Utility.

Provide Contact Information

Enter contact information for technical support to use when sending support-related communications from SupportAssist.

1. Specify the contact information.
2. To receive SupportAssist email messages, select **Yes, I would like to receive emails from SupportAssist when issues arise, including hardware failure notifications**.
3. Select the preferred contact method, language, and available times.
4. Type a shipping address where replacement Storage Center components can be sent.
5. Click **Next**.



Update the Storage Center

The Storage Center attempts to contact the SupportAssist Update Server to check for updates. If you are not using SupportAssist, you must use the Storage Center Update Utility to update the Storage Center software before continuing.

NOTE:

- If no update is available, the **Storage Center Up to Date** page opens. Click **Next**.
- If an update is available, the current and available versions are listed.
- If you cannot update Storage Center using standard methods (or example, you have no Internet access) use the Storage Center Update Utility to install Storage Center software updates. See the *Storage Center Update Utility Administrator's Guide* or contact Dell Technical Support for instructions on how to proceed.
- If the site uses a web proxy to access Internet, configure the proxy settings:
 - a. In the **Setup SupportAssist Proxy Settings** dialog box, select **Enabled**.
 - b. Specify the proxy settings.
 - c. Click **OK**.

Complete the Configuration and Continue With Setup

The Storage Center is now configured. The **Configuration Complete** page provides links to a Dell Storage Manager tutorial and wizards to perform the next setup tasks.

About this task

Configure iDRAC, configure a VMware host, or create volumes to complete setup tasks.

Steps

1. (Optional) Click one of the **Next Steps** to configure a localhost, configure a VMware host, configure iDRAC, or create a volume. When you have completed the step, you are returned to the **Configuration Complete** page.
2. Click **Finish**. When the wizard is complete, continue to step 3.
3. If no expansion enclosures are attached to the storage system, unconfigure the four backend ports.

Modify iDRAC Interface Settings for a Storage System

The iDRAC interface provides functions to help deploy, update, monitor and maintain the storage system.

About this task

Configure the iDRAC so it can be used to perform out-of-band system management.

Steps

1. When you reach the **Configuration Complete** page, scroll down to **Advanced Steps**.
2. Click **Modify BMC Settings**. The **Edit BMC Settings** dialog box opens.
3. Select how to assigned an IP Address to the iDRAC from the **Configure** via drop-down menu.
 - To specify a static IP address for the iDRAC, select **Static**.
 - To allow a DHCP server to assign an IP address to the iDRAC, select **DHCP**.
4. If you selected to specify a static IP address, specify the iDRAC IP address for the bottom storage controller and the top storage controller.
 - a. In the **BMC IP Address** field, type an IP address for the iDRAC.
 - b. In the **BMC Net Mask** field, type the network mask.
 - c. In the **BMC Gateway IP Address** field, type the default route for the iDRAC.
5. Click **OK**.
6. Log in to the iDRAC and configure the iDRAC password. You will be prompted to change the iDRAC password when you log in. The default password is root/calvin.

 **NOTE: Any hardware errors reported in the iDRAC can be ignored. Storage Manager is the official interface to check hardware status.**



Unconfigure Unused I/O Ports

Unconfigure a port when it is down and will not be used.

Prerequisites

- The Storage Center must be a SCv3000 and SCv3020 storage system.
- The I/O port must be down.

Steps

1. Click the **Storage** view.
2. In the **Storage** pane, select a Storage Center.
3. Click the **Hardware** tab.
4. In the **Hardware** tab navigation pane, expand **Controllers** → *storage controller* → **IO Ports**.
5. Right-click on the down I/O port and select **Unconfigure Port**. The Storage Manager unconfigures the port.



Perform Post-Setup Tasks

Perform connectivity and failover tests to make sure that the Storage Center deployment was successful.

 **NOTE: Before testing failover, use Storage Manager to place the storage system in Maintenance mode. When you are finished, use Storage Manager to place the storage system back into normal operational mode.**

Update Storage Center Using Dell Storage Manager

Use this procedure to update the Storage Center using Dell Storage Manager.

1. Click **Storage** and select a Storage Center.
2. In the Summary tab, select **Actions** → **System** → **Check for Updates**.
3. Click **Install** to update to the latest version.
4. If the update fails, click **Retry Update** to try to update again.
 - a. The **Setup SupportAssist Proxy Settings** dialog box opens if the Storage Center cannot connect to the Dell SupportAssist Update Server. If the site does not have direct access to the Internet but uses a web proxy, configure the proxy settings:
 - Select **Enabled**
 - Specify the proxy settings.
 - Click **OK**. The Storage Center attempts to contact the SupportAssist Update Server to check for updates.
5. When the update is complete, click **Next**.

Check the Status of the Update

Return to Dell Storage Manager to determine whether the update has completed.

About this task

 **NOTE: The update process should take between 60 and 90 minutes to complete. During the update, Dell Storage Manager might disconnect from the Storage Center. You will be able to reconnect to the Storage Center after the update completes.**

Steps

1. Click **Storage**, and select a **Storage Center**.
2. In the **Summary** tab, select **Actions** → **System** → **Check for Updates**.

Change the Operation Mode of a Storage Center

Change the operation mode of a Storage Center before performing maintenance or installing software updates so that you can isolate alerts from those events.

About this task

 **NOTE: Do not change the mode of the Storage Center from Pre-production mode until setup and testing is complete.**

Steps

1. In the **Summary** tab, click **Edit Settings**. The **Edit Storage Center Settings** dialog box opens.
2. Click the **General** tab.
3. In the **Operation Mode** field select **Maintenance**. Selecting Maintenance isolates alerts from those that would occur during normal operation.



4. Click **OK**.

Verify Connectivity and Failover

This section describes how to verify that the Storage Center is set up properly and performs failover correctly.

The process includes creating test volumes, copying data to verify connectivity, and shutting down a storage controller to verify failover and MPIO functionality.

Create Test Volumes

Connect a server to the Storage Center, create one or more test volumes, and map them to the server to prepare for connectivity and failover testing.

Prerequisite

 **NOTE: The localhost must have network connection to both the iSCSI connection and Data Collector host IP.**

Steps

1. Configure a localhost to access the Storage Center using the **Set up localhost on Storage Center** wizard.
 - a. In the Storage view, select a Storage Center.
 - b. Click the Storage tab, then click **Servers** → **Create Server from Localhost**.
2. Connect to the Storage Center using the Dell Storage Manager.
3. Create two small test volumes (TestVol1 and TestVol2) on the server.
4. Map TestVol1 to storage controller 1 and TestVol2 to storage controller 2.
5. Partition and format the test volumes on the server.

Test Basic Connectivity

Verify basic connectivity by copying data to the test volumes.

1. Connect to the server to which the volumes are mapped.
2. Create a folder on the TestVol1 volume, copy at least 2 GB of data to the folder, and verify that the data copied successfully.
3. Create a folder on the TestVol2 volume, copy at least 2 GB of data to the folder, and verify that the data copied successfully.

Test Storage Controller Failover

Test the Storage Center to make sure that a storage controller failover does not interrupt I/O.

About this task

 **NOTE: Before restarting a storage controller, use Storage Manager to change the operation mode to Maintenance mode. When you are finished, use Storage Manager to place the storage system back into normal operational mode.**

Steps

1. Connect to the server, create a Test folder on the server, and copy at least 2 GB of data into it.
2. Restart storage controller 1 while copying data to verify that the failover event does not interrupt I/O.
 - a. Copy the Test folder to the TestVol1 volume.
 - b. During the copy process, restart the storage controller (through which TestVol1 is mapped) by selecting it from the **Hardware** tab and clicking **Shutdown/Restart Controller**.
 - c. Verify that the copy process continues while the storage controller restarts.
 - d. Wait several minutes and verify that the storage controller has finished restarting.
3. Restart storage controller 2 while copying data to verify that the failover event does not interrupt I/O.
 - a. Copy the Test folder to the TestVol2 volume.
 - b. During the copy process, restart the storage controller (through which TestVol2 is mapped) by selecting it from the **Hardware** tab and clicking **Shutdown/Restart Controller**.
 - c. Verify that the copy process continues while the storage controller restarts.
 - d. Wait several minutes and verify that the storage controller has finished restarting.

Test MPIO

Perform the following tests for a Storage Center with Fibre Channel or iSCSI front-end connectivity if the network environment and servers are configured for MPIO.

1. Create a Test folder on the server and copy at least 2 GB of data into it.
2. Make sure that the server is configured to use load-balancing MPIO (round-robin).
3. Manually disconnect a path while copying data to TestVol1 to verify that MPIO is functioning correctly.
 - a. Copy the Test folder to the TestVol1 volume.
 - b. During the copy process, disconnect one of the paths and verify that the copy process continues.
 - c. Reconnect the path.
4. Repeat the previous steps as necessary to test additional paths.
5. Restart the storage controller that contains the active path while I/O is being transferred and verify that the I/O process continues.
6. If the front-end connectivity of the Storage Center is Fibre Channel or iSCSI and the Storage Center is not in a production environment, restart the switch that contains the active path while I/O is being transferred, and verify that the I/O process continues.

Clean Up Test Volumes

After testing is complete, delete the volumes used for testing.

About this task

 **NOTE:** During deployment, a Storage Type is created for each tier that defines the Redundancy Level. If you delete all test volumes, the Storage Type for each tier reverts to the default redundancy level. Creating new volumes will then require setting Storage Types to the desired redundancy level manually. It is recommended that before deleting any test volumes, you create at least one volume in each Storage Type required by the customer. If all volumes are deleted before creating new volumes, you will need to manually update the redundancy levels for each Storage Type.

Steps

1. Use the Dell Storage Manager to connect to the Storage Center.
2. Click the **Storage** tab.
3. From the **Storage** tab navigation pane, select the **Volumes** node.
4. Create new volumes for the customer in each tier as required by their application.
5. Select the test volumes to delete.
6. Right-click on the selected volumes and select **Delete**. The **Delete** dialog box opens.
7. Click **OK**.

Send Diagnostic Data Using Dell SupportAssist

After replacing components, use Dell SupportAssist to send diagnostic data to Dell Technical Support.

1. Use Dell Storage Manager to connect to the Storage Center.
2. In the **Summary** tab, click **Send SupportAssist Information Now**, which is located under **SupportAssist Actions** in the **Status** pane.

The **Send SupportAssist Information Now** dialog box opens.
3. Select **Storage Center Configuration** and **Detailed Logs**.
4. Click **OK**.



Adding or Removing Expansion Enclosures

This section describes how to add an expansion enclosure to a storage system and how to remove an expansion enclosure from a storage system.

Adding Expansion Enclosures to a Storage System Deployed Without Expansion Enclosures

Install the expansion enclosures in a rack, but do not connect the expansion enclosures to the storage system.

For more information, see the *Dell SCv300 and SCv320 Expansion Enclosure Getting Started Guide* or the *Dell SCv360 Expansion Enclosure Getting Started Guide*.

NOTE: To preserve the integrity of the existing data, use caution when adding expansion enclosures to a storage system.

Install New SCv300 and SCv320 Expansion Enclosures in a Rack

Prerequisite

Install the expansion enclosures in a rack, but do not connect the expansion enclosures to the storage system. For more information, see the *Dell SCv300 and SCv320 Expansion Enclosure Getting Started Guide*

Steps

1. Cable the expansion enclosures together to form a chain.
 - a. Connect a SAS cable from expansion enclosure 1: top, port 2 to expansion enclosure 2: top, port 1.
 - b. Connect a SAS cable from expansion enclosure 1: bottom, port 2 to expansion enclosure 2: bottom, port 1.
 - c. Repeat the previous steps to connect additional expansion enclosures to the chain.

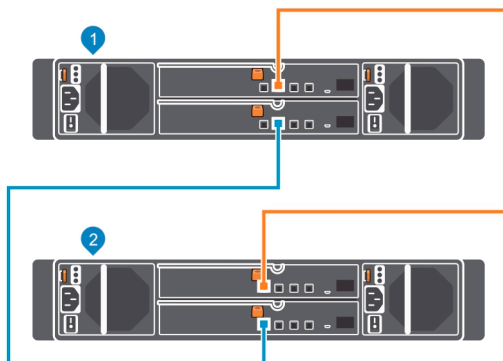

Figure 53. Cable the Expansion Enclosures Together

1. Expansion enclosure 1
2. Expansion enclosure 2
2. Connect to the Storage Center using the Dell Storage Manager.
3. Check the drive count of the Storage Center system before adding the expansion enclosure. Make sure the number of drives installed plus the drives in the new expansion enclosure does not exceed 500 drives.
 - a. Select the **Storage** tab.
 - b. In the **Storage** tab navigation pane, select the **Disks** node.
 - c. On the **Disks** tab, record the number of drives that are accessible by the Storage Center.

Compare this value to the number of drives accessible by the Storage Center after adding expansion enclosures to the storage system.

4. Click the **Hardware** tab and select the **Enclosures** node in the Hardware tab navigation pane.
5. Click **Add Enclosure**. The **Add New Enclosure** wizard starts.
 - a. Click **Next** to validate the existing cabling.
 - b. Select the expansion enclosure type and click **Next**.
 - c. If the drives are not installed, install the drives in the expansion enclosures.
 - d. Turn on the expansion enclosure. When the drives spin up, make sure that the front panel and power status LEDs show normal operation.
 - e. Click **Next**.
 - f. Add the expansion enclosure to the A-side chain. Click **Next** to validate the cabling.
 - g. Add the expansion enclosure to the B-side chain. Click **Next** to validate the cabling.
 - h. Click **Finish**.
6. To manually manage new unassigned drives:
 - a. Click the **Storage** tab.
 - b. In the **Storage** tab navigation pane, select the **Disks** node.
 - c. Click **Manage Unassigned Disks**. The **Manage Unassigned Disks** dialog box opens.
 - d. From the **Disk Folder** drop-down menu, select the drive folder for the unassigned drives.
 - e. Select **Perform RAID rebalance immediately**.
 - f. Click **OK**.
7. Label the back-end cables.

Add the SCv300 and SCv320 Expansion Enclosures to the A-Side of the Chain

Connect the expansion enclosures to one side of the chain at a time to maintain drive availability.

1. Cable the expansion enclosures to the A-side of the chain.
 - a. Connect a SAS cable from storage controller 1: port 1 to the first expansion enclosure in the chain, top EMM, port 1.
 - b. Connect a SAS cable from storage controller 2: port 2 to the last expansion enclosure in the chain, top EMM, port 2.

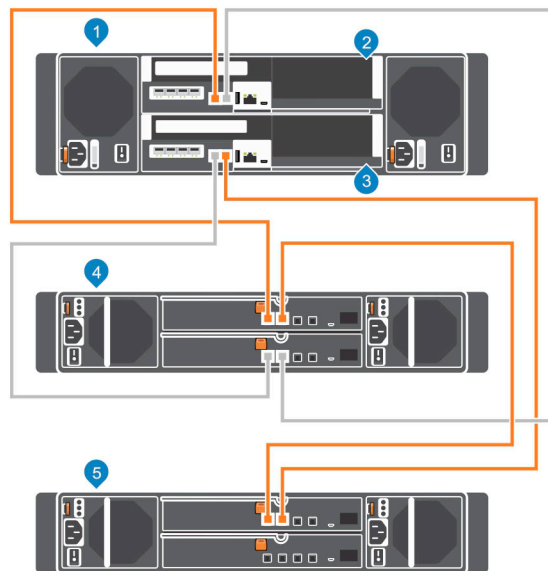

Figure 54. Connect the A-Side Cables to the Expansion Enclosures

- | | |
|-------------------------|--------------------------|
| 1. Storage system | 2. Storage controller 1 |
| 3. Storage controller 2 | 4. Expansion enclosure 1 |



5. Expansion enclosure 2

2. Label the back-end cables.

Add the SCv300 and SCv320 Expansion Enclosures to the B-Side of the Chain

Connect the expansion enclosures to one side of the chain at a time to maintain drive availability.

1. Cable the expansion enclosures to the B-side of the chain.
 - a. Connect a SAS cable from storage controller 1: port 2 to expansion enclosure 2: bottom EMM, port 2.
 - b. Connect a SAS cable from storage controller 2: port 1 to expansion enclosure 1: bottom EMM, port 1.

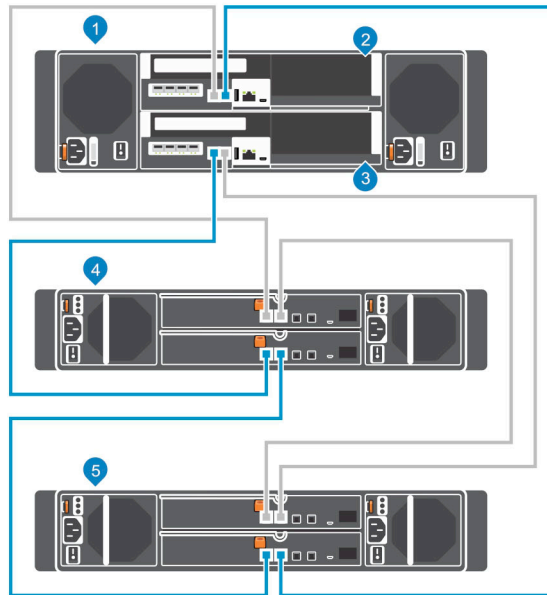

Figure 55. Connect the B-Side Cables to the Expansion Enclosures

1. Storage system
2. Storage controller 1
3. Storage controller 2
4. Expansion enclosure 1
5. Expansion enclosure 2

2. Label the back-end cables.

Install New SCv360 Expansion Enclosures in a Rack

Install the expansion enclosures in a rack, but do not connect the expansion enclosures to the storage system. For more information, see the *Dell SCv360 Expansion Enclosure Getting Started Guide*

About this task

Steps

1. Cable the expansion enclosures together to form a chain.
 - a. Connect a SAS cable from expansion enclosure 1: left, port 2 to expansion enclosure 2: left, port 1.
 - b. Connect a SAS cable from expansion enclosure 1: right, port 2 to expansion enclosure 2: right, port 1.
 - c. Repeat the previous steps to connect additional expansion enclosures to the chain.

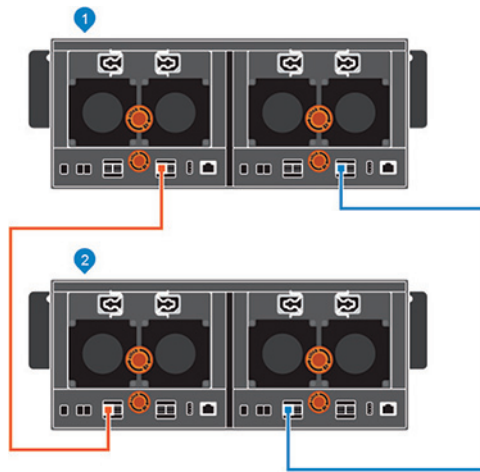

Figure 56. Cable the Expansion Enclosures Together

1. Expansion enclosure 1
2. Expansion enclosure 2

2. Connect to the Storage Center using the Dell Storage Manager.
3. Check the drive count of the Storage Center system before adding the expansion enclosure. Make sure the number of drives installed plus the drives in the new expansion enclosure does not exceed 500 drives.
 - a. Select the **Storage** tab.
 - b. In the **Storage** tab navigation pane, select the **Disks** node.
 - c. On the **Disks** tab, record the number of drives that are accessible by the Storage Center.
Compare this value to the number of drives accessible by the Storage Center after adding expansion enclosures to the storage system.
4. Click the **Hardware** tab and select the **Enclosures** node in the Hardware tab navigation pane.
5. Click **Add Enclosure**. The **Add New Enclosure** wizard starts.
 - a. Click **Next** to validate the existing cabling.
 - b. Select the expansion enclosure type and click **Next**.
 - c. If the drives are not installed, install the drives in the expansion enclosures.
 - d. Turn on the expansion enclosure. When the drives spin up, make sure that the front panel and power status LEDs show normal operation.
 - e. Click **Next**.
 - f. Add the expansion enclosure to the A-side chain. Click **Next** to validate the cabling.
 - g. Add the expansion enclosure to the B-side chain. Click **Next** to validate the cabling.
 - h. Click **Finish**.
6. To manually manage new unassigned drives:
 - a. Click the **Storage** tab.
 - b. In the **Storage** tab navigation pane, select the **Disks** node.
 - c. Click **Manage Unassigned Disks**. The **Manage Unassigned Disks** dialog box opens.
 - d. From the **Disk Folder** drop-down menu, select the drive folder for the unassigned drives.
 - e. Select **Perform RAID rebalance immediately**.
 - f. Click **OK**.
7. Label the back-end cables.

Add the SCv360 Expansion Enclosures to the A-Side of the Chain

Connect the expansion enclosures to one side of the chain at a time to maintain drive availability.

1. Cable the expansion enclosures to the A-side of the chain.
 - a. Connect a SAS cable from storage controller 1: port 1 to the first expansion enclosure in the chain, left EMM, port 1.
 - b. Connect a SAS cable from storage controller 2: port 2 to the last expansion enclosure in the chain, left EMM, port 2.



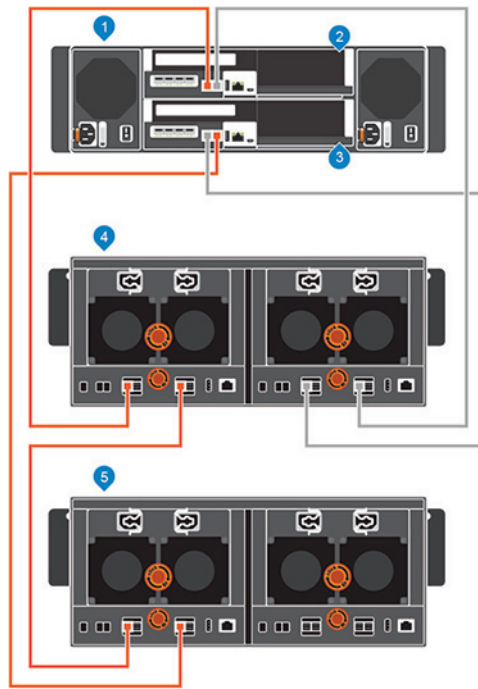

Figure 57. Connect the A-Side Cables to the Expansion Enclosures

- | | |
|--------------------------|--------------------------|
| 1. Storage system | 2. Storage controller 1 |
| 3. Storage controller 2 | 4. Expansion enclosure 1 |
| 5. Expansion enclosure 2 | |

2. Label the back-end cables.

Add an SCv360 Expansion Enclosure to the B-Side of the Chain

Connect the expansion enclosure to one side of the chain at a time to maintain drive availability.

1. Disconnect the B-side cable (shown in blue) from the expansion enclosure: right EMM, port 2. The A-side cables continue to carry I/O while the B-side is disconnected.

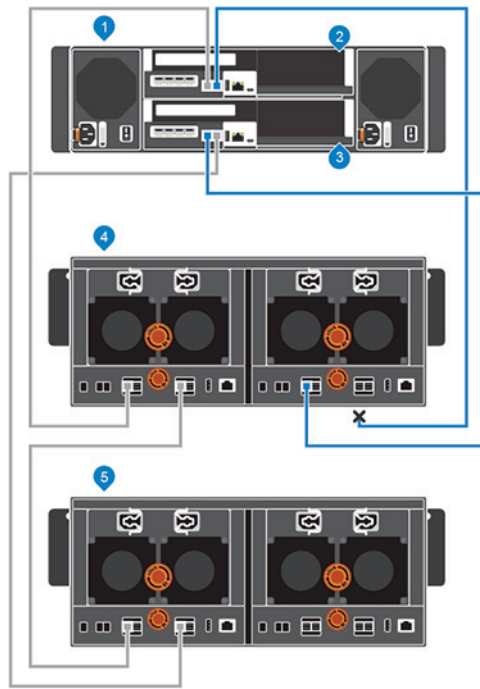

Figure 58. Disconnect B-Side Cable from the Existing Expansion Enclosure

- | | |
|--------------------------------|--------------------------|
| 1. Storage system | 2. Storage controller 1 |
| 3. Storage controller 2 | 4. Expansion enclosure 1 |
| 5. New expansion enclosure (2) | |
2. Use a new SAS cable to connect expansion enclosure 1: right EMM, port 2 to the new expansion enclosure (2): right EMM, port 1.
 3. Connect the B-side cable that was disconnected in step 1 to the new expansion enclosure (2): right EMM, port 2.

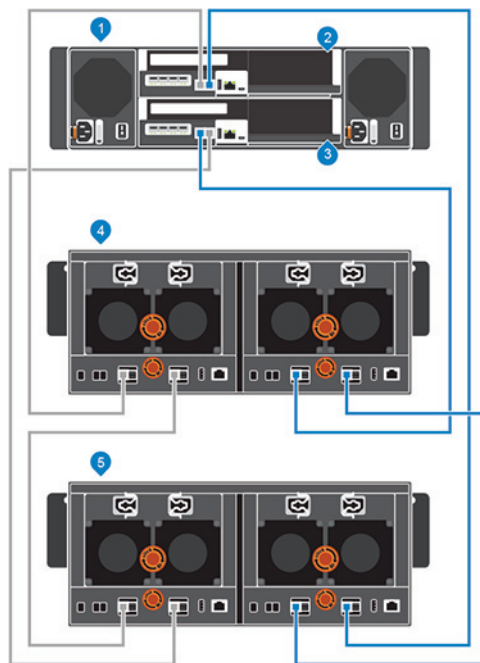

Figure 59. Connect B-Side Cables to the New Expansion Enclosure

- | | |
|-------------------|-------------------------|
| 1. Storage system | 2. Storage controller 1 |
|-------------------|-------------------------|



3. Storage controller 2
4. Expansion enclosure 1
5. New expansion enclosure (2)

Adding a Single Expansion Enclosure to a Chain Currently in Service

To preserve the integrity of the existing data, use caution when adding an expansion enclosure to a live Storage Center system.

Prerequisites

Install the expansion enclosure in a rack, but do not connect the expansion enclosure to the storage system. For more information, see the *Dell SCv300 and SCv320 Expansion Enclosure Getting Started Guide* or the *Dell SCv360 Expansion Enclosure Getting Started Guide*.

To add an expansion enclosure to an existing chain, connect the expansion enclosure to the end of the chain.

Steps

1. Connect to the Storage Center using the Dell Storage Manager.
2. Check the drive count of the Storage Center system before adding the expansion enclosure.
3. Click the **Hardware** tab and select **Enclosures** in the Hardware tab navigation pane.
4. Click **Add Enclosure**. The **Add New Enclosure** wizard starts.
 - a. Confirm the details of your current installation and click **Next** to validate the existing cabling.
 - b. Turn on the expansion enclosure. When the drives spin up, make sure that the front panel and power status LEDs show normal operation.
 - c. Click **Next**.
 - d. Add the expansion enclosure to the A-side chain. Click **Next** to validate the cabling.
 - e. Add the expansion enclosure to the B-side chain. Click **Next** to validate the cabling.
 - f. Click **Finish**.
5. To manually manage new unassigned drives:
 - a. Click the **Storage** tab.
 - b. In the **Storage** tab navigation pane, select the **Disks** node.
 - c. Click **Manage Unassigned Disks**. The **Manage Unassigned Disks** dialog box opens.
 - d. From the **Disk Folder** drop-down menu, select the drive folder for the unassigned drives.
 - e. Select **Perform RAID rebalance immediately**.
 - f. Click **OK**.
6. Label the new back-end cables.

Check the Drive Count

Use the Dell Storage Manager to determine the number of drives that are currently accessible to the Storage Center.

1. Connect to the Storage Center using the Dell Storage Manager.
2. Select the **Storage** tab.
3. In the **Storage** tab navigation pane, select the **Disks** node.
4. On the **Disks** tab, record the number of drives that are accessible by the Storage Center.

Compare this value to the number of drives accessible by the Storage Center after adding an expansion enclosure to the storage system.

Add an SCv300 and SCv320 Expansion Enclosure to the A-Side of the Chain

Connect the expansion enclosure to one side of the chain at a time to maintain drive availability.

1. Turn on the expansion enclosure being added. When the drives spin up, make sure that the front panel and power status LEDs show normal operation.
2. Disconnect the A-side cable (shown in orange) from the expansion enclosure: top EMM, port 2. The B-side cables continue to carry I/O while the A-side is disconnected.



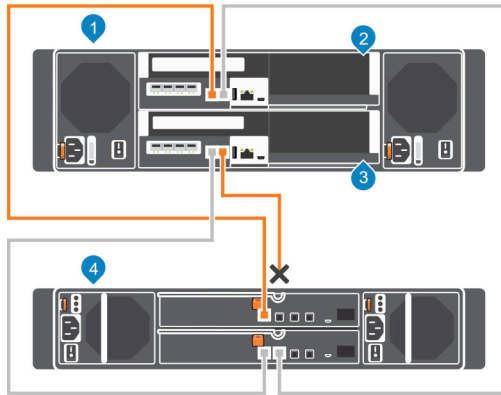

Figure 60. Disconnect A-Side Cable from the Existing Expansion Enclosure

1. Storage system
 2. Storage controller 1
 3. Storage controller 2
 4. Expansion enclosure 1
3. Use a new SAS cable to connect expansion enclosure 1: top EMM, port 2 to the new expansion enclosure (2): top EMM, port 1.
 4. Connect the A-side cable that was disconnected in step 2 to the new expansion enclosure (2): top EMM, port 2.

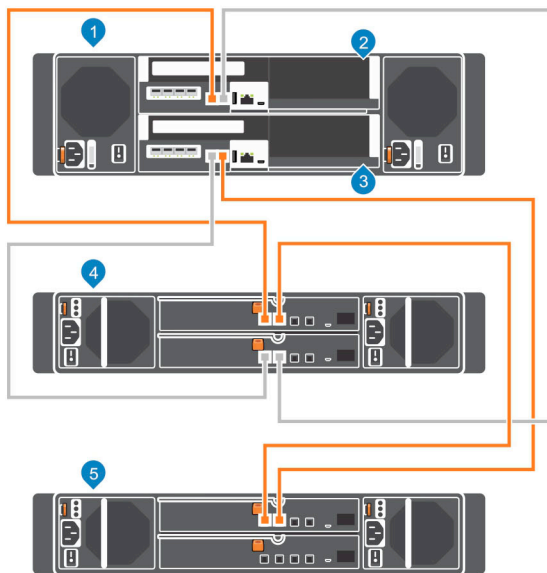

Figure 61. Connect A-Side Cables to the New Expansion Enclosure

1. Storage system
 2. Storage controller 1
 3. Storage controller 2
 4. Expansion enclosure 1
 5. New expansion enclosure (2)
5. Label the back-end cables.

Add an SCv300 and SCv320 Expansion Enclosure to the B-Side of the Chain

Connect the expansion enclosure to one side of the chain at a time to maintain drive availability.

1. Disconnect the B-side cable (shown in blue) from the expansion enclosure: bottom EMM, port B. The A-side cables continue to carry I/O while the B-side is disconnected.



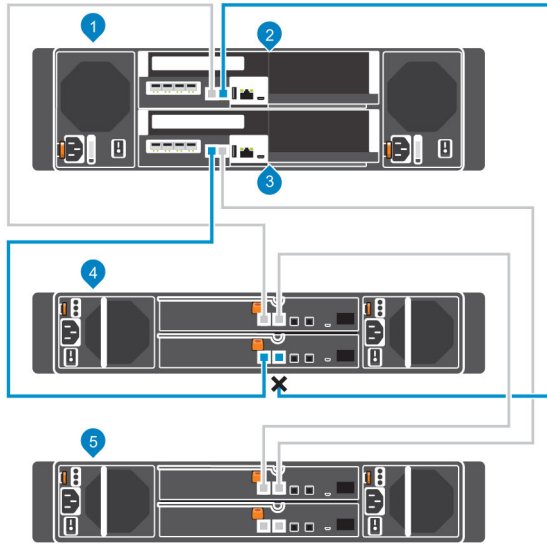

Figure 62. Disconnect B-Side Cable from the Existing Expansion Enclosure

- | | |
|--------------------------------|--------------------------|
| 1. Storage system | 2. Storage controller 1 |
| 3. Storage controller 2 | 4. Expansion enclosure 1 |
| 5. New expansion enclosure (2) | |
2. Use a new SAS cable to connect expansion enclosure 1: bottom EMM, port 2 to the new expansion enclosure (2): bottom EMM, port 1.
 3. Connect the B-side cable that was disconnected in step 1 to the new expansion enclosure (2): bottom EMM, port 2.

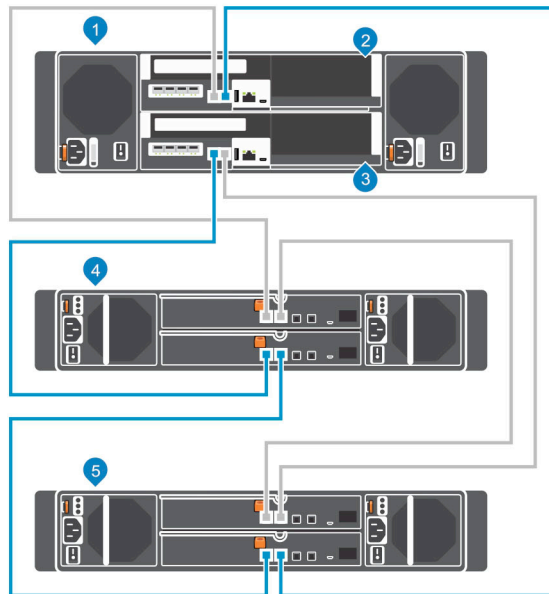

Figure 63. Connect B-Side Cables to the New Expansion Enclosure

- | | |
|--------------------------------|--------------------------|
| 1. Storage system | 2. Storage controller 1 |
| 3. Storage controller 2 | 4. Expansion enclosure 1 |
| 5. New expansion enclosure (2) | |



Add an SCv360 Expansion Enclosure to the A-Side of the Chain

Connect the expansion enclosure to one side of the chain at a time to maintain drive availability.

1. Turn on the expansion enclosure being added. When the drives spin up, make sure that the front panel and power status LEDs show normal operation.
2. Disconnect the A-side cable (shown in orange) from the expansion enclosure: left EMM, port 2. The B-side cables continue to carry I/O while the A-side is disconnected.

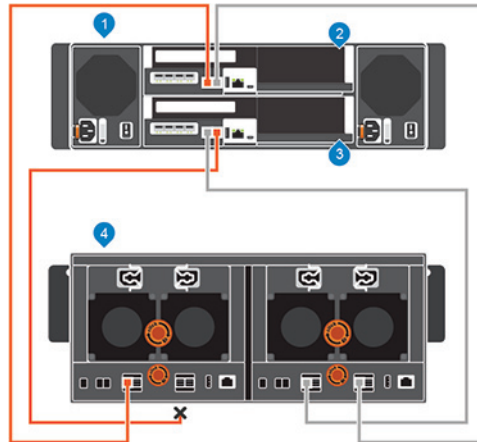

Figure 64. Disconnect A-Side Cable from the Existing Expansion Enclosure

- | | |
|-------------------------|--------------------------|
| 1. Storage system | 2. Storage controller 1 |
| 3. Storage controller 2 | 4. Expansion enclosure 1 |
3. Use a new SAS cable to connect expansion enclosure 1: left EMM, port 2 to the new expansion enclosure (2): left EMM, port 1.
 4. Connect the A-side cable that was disconnected in step 2 to the new expansion enclosure (2): left EMM, port 2.

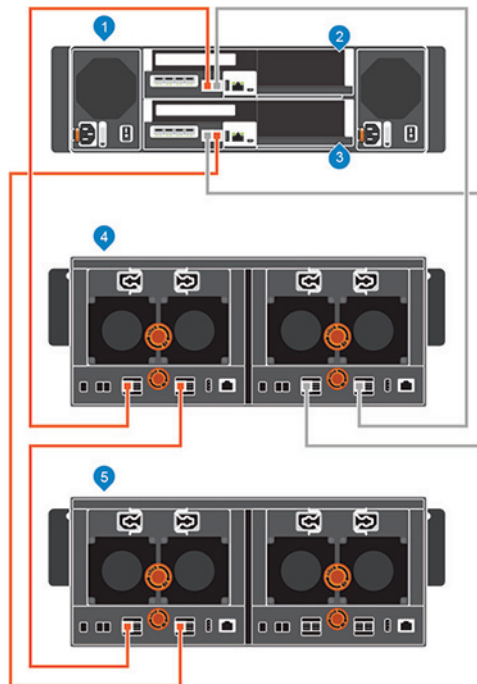

Figure 65. Connect A-Side Cables to the New Expansion Enclosure

- | | |
|-------------------|-------------------------|
| 1. Storage system | 2. Storage controller 1 |
|-------------------|-------------------------|



- 3. Storage controller 2
- 5. New expansion enclosure (2)

4. Expansion enclosure 1

5. Label the back-end cables.

Add an SCv360 Expansion Enclosure to the B-Side of the Chain

Connect the expansion enclosure to one side of the chain at a time to maintain drive availability.

1. Disconnect the B-side cable (shown in blue) from the expansion enclosure: right EMM, port 2. The A-side cables continue to carry I/O while the B-side is disconnected.

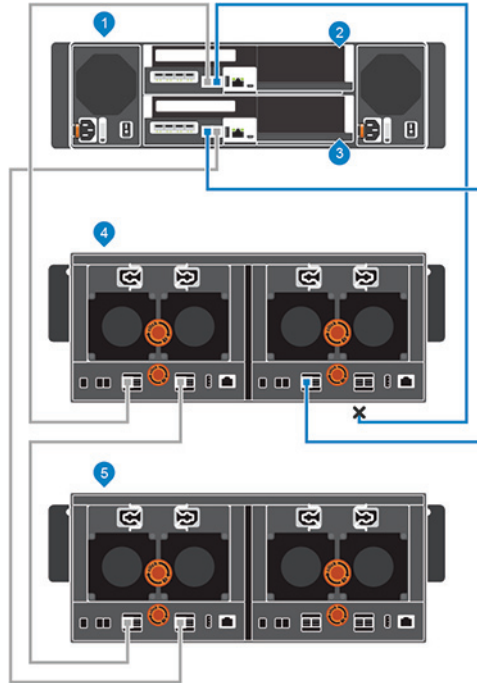

Figure 66. Disconnect B-Side Cable from the Existing Expansion Enclosure

- 1. Storage system
- 3. Storage controller 2
- 5. New expansion enclosure (2)

2. Storage controller 1
4. Expansion enclosure 1

2. Use a new SAS cable to connect expansion enclosure 1: right EMM, port 2 to the new expansion enclosure (2): right EMM, port 1.
3. Connect the B-side cable that was disconnected in step 1 to the new expansion enclosure (2): right EMM, port 2.



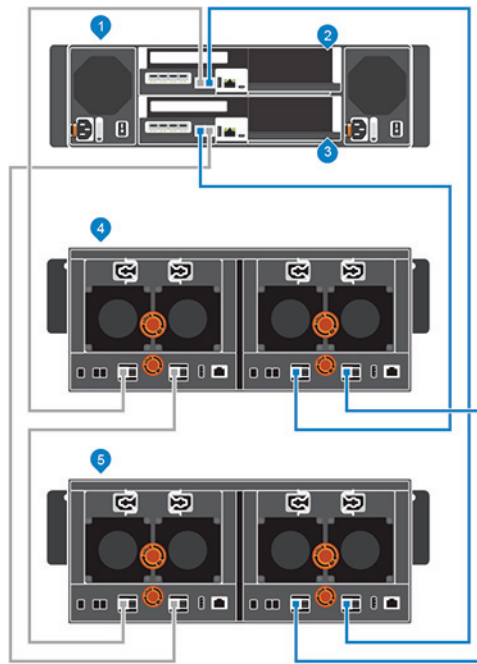

Figure 67. Connect B-Side Cables to the New Expansion Enclosure

- | | |
|--------------------------------|--------------------------|
| 1. Storage system | 2. Storage controller 1 |
| 3. Storage controller 2 | 4. Expansion enclosure 1 |
| 5. New expansion enclosure (2) | |

Removing an Expansion Enclosure from a Chain Currently in Service

To remove an expansion enclosure, you disconnect the expansion enclosure from one side of the chain at a time.

About this task

During this process, one side of the chain is disconnected. The Storage Center directs all I/O to the other side of the chain, which remains connected.

CAUTION: Make sure that your data is backed up before removing an expansion enclosure.

Before physically removing an expansion enclosure, make sure that none of the drives in the expansion enclosure are managed by the Storage Center software.

Steps

1. Connect to the Storage Center using the Dell Storage Manager.
2. Use the Dell Storage Manager to release the drives in the expansion enclosure.
3. Select the expansion enclosure to remove and click **Remove Enclosure**. The **Remove Enclosure** wizard starts.
4. Confirm the details of your current installation and click **Next** to validate the cabling.
5. Locate the expansion enclosure in the rack. Click **Next**.
6. Disconnect the A-side chain.
 - a. Disconnect the A-side cables that connect the expansion enclosure to the storage system. Click **Next**.
 - b. Reconnect the A-side cables to exclude the expansion enclosure from the chain. Click **Next** to validate the cabling.
7. Disconnect the B-side chain.
 - a. Disconnect the B-side cables that connect the expansion enclosure to the storage system. Click **Next**.
 - b. Reconnect the B-side cables to exclude the expansion enclosure from the chain. Click **Next** to validate the cabling.
8. Click **Finish**.



Release the Drives in the Expansion Enclosure

Use the Dell Storage Manager to release the drives in an expansion enclosure before removing the expansion enclosure.

About this task

Because releasing drives causes all of the data to move off the drives, this procedure might take some time.

 **NOTE: Do not release drives unless the remaining drives have enough free space for the restriped data.**

Steps

1. Connect to the Storage Center using the Dell Storage Manager.
2. Click the **Hardware** tab.
3. In the **Hardware** tab navigation pane, expand the expansion enclosure to remove.
4. Select the **Disks** node.
5. Select all of the drives in the expansion enclosure.
6. Right-click on the selected drives and select **Release Disk**. The **Release Disk** dialog box opens.
7. Select **Perform RAID rebalance immediately**.
8. Click **OK**.

When all of the drives in the expansion enclosure are in the **Unassigned** drive folder, the expansion enclosure is safe to remove.

Disconnect the SCv300 and SCv320 Expansion Enclosure from the A-Side of the Chain

Disconnect the A-side cables from the expansion enclosure that you want to remove.

1. Disconnect the A-side cable (shown in orange) from expansion enclosure 1: top EMM, port 1. The B-side cables continue to carry I/O while the A-side is disconnected.
2. Remove the A-side cable between expansion enclosure 1: top EMM, port 2 and expansion enclosure 2: top EMM, port 1.

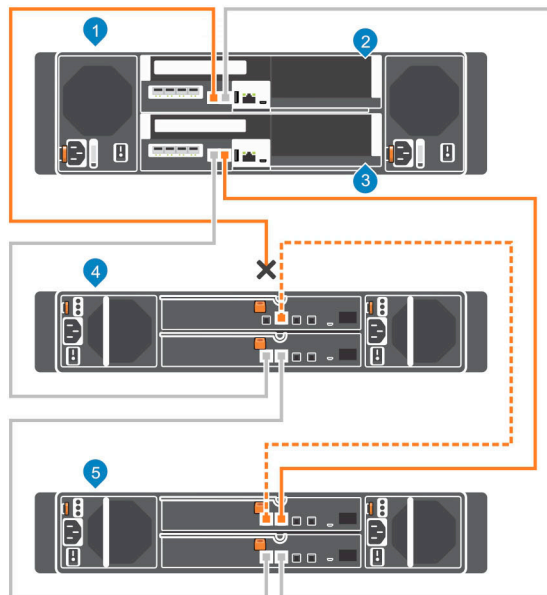

Figure 68. Disconnecting the A-Side Cables from the Expansion Enclosure

- | | |
|-------------------------|--------------------------|
| 1. Storage system | 2. Storage controller 1 |
| 3. Storage controller 2 | 4. Expansion enclosure 1 |
| | 5. Expansion enclosure 2 |

5. Expansion enclosure 2

3. Connect the A-side cable to expansion enclosure 2: top EMM, port 1.

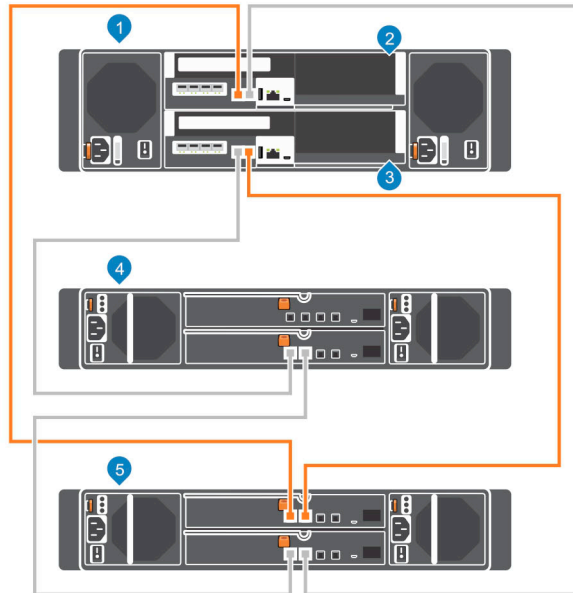

Figure 69. Reconnecting the A-Side Cable to the Remaining Expansion Enclosure

- | | |
|--------------------------|--------------------------|
| 1. Storage system | 2. Storage controller 1 |
| 3. Storage controller 2 | 4. Expansion enclosure 1 |
| 5. Expansion enclosure 2 | |

Disconnect the SCv300 and SCv320 Expansion Enclosure from the B-Side of the Chain

Disconnect the B-side cables from the expansion enclosure that you want to remove.

1. Disconnect the B-side cable (shown in blue) from expansion enclosure 1: bottom EMM, port 1. The A-side cables continue to carry I/O while the B-side is disconnected.
2. Remove the B-side cable between expansion enclosure 1: bottom EMM, port 2 and expansion enclosure 2: bottom EMM, port 1.

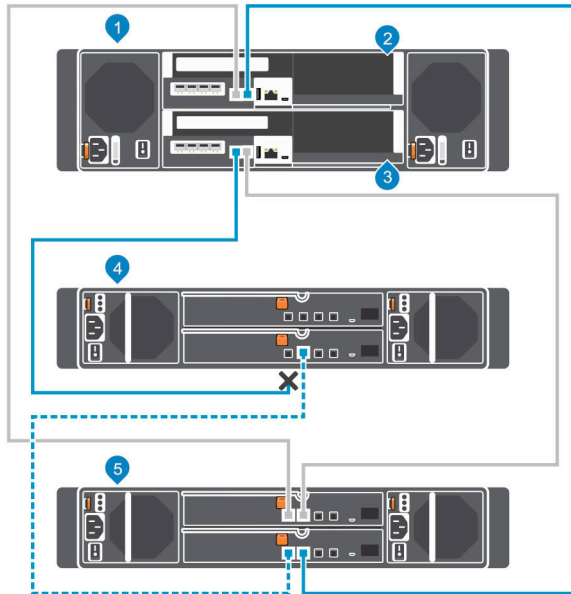

Figure 70. Disconnecting the B-Side Cables from the Expansion Enclosure

- | | |
|--------------------------|--------------------------|
| 1. Storage system | 2. Storage controller 1 |
| 3. Storage controller 2 | 4. Expansion enclosure 1 |
| 5. Expansion enclosure 2 | |

3. Connect the B-side cable to expansion enclosure 2: bottom EMM, port 1. The expansion enclosure is now disconnected and can be removed.

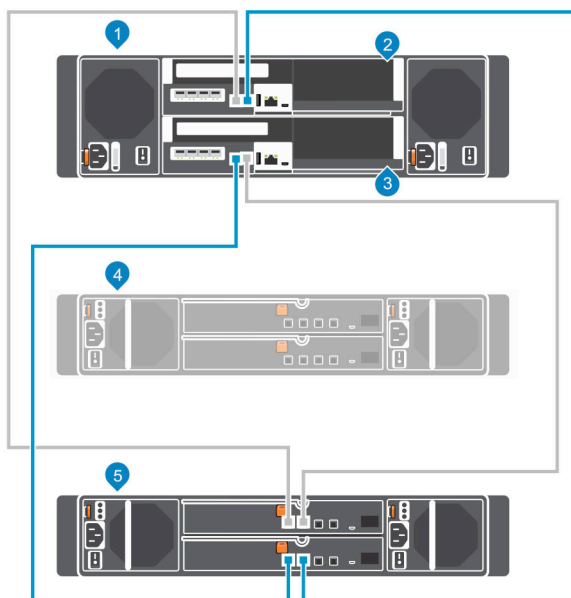

Figure 71. Reconnecting the B-Side Cable to the Remaining Expansion Enclosure

- | | |
|-------------------------|-------------------------------------|
| 1. Storage system | 2. Storage controller 1 |
| 3. Storage controller 2 | 4. Disconnected expansion enclosure |



5. Expansion enclosure 1

Disconnect the SCv360 Expansion Enclosure from the A-Side of the Chain

Disconnect the A-side cables from the expansion enclosure that you want to remove.

1. Disconnect the A-side cable (shown in orange) from expansion enclosure 1: left EMM, port 1. The B-side cables continue to carry I/O while the A-side is disconnected.
2. Remove the A-side cable between expansion enclosure 1: left EMM, port 2 and expansion enclosure 2: left EMM, port 1.

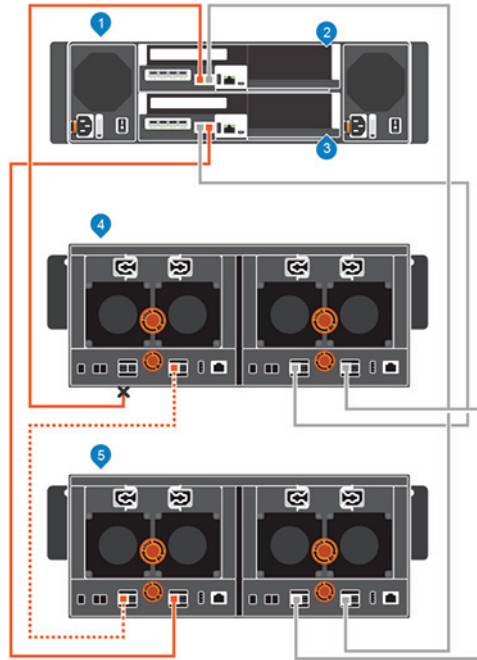

Figure 72. Disconnecting the A-Side Cables from the Expansion Enclosure

- | | |
|--------------------------|--------------------------|
| 1. Storage system | 2. Storage controller 1 |
| 3. Storage controller 2 | 4. Expansion enclosure 1 |
| 5. Expansion enclosure 2 | |
3. Connect the A-side cable to expansion enclosure: left EMM, port 1.

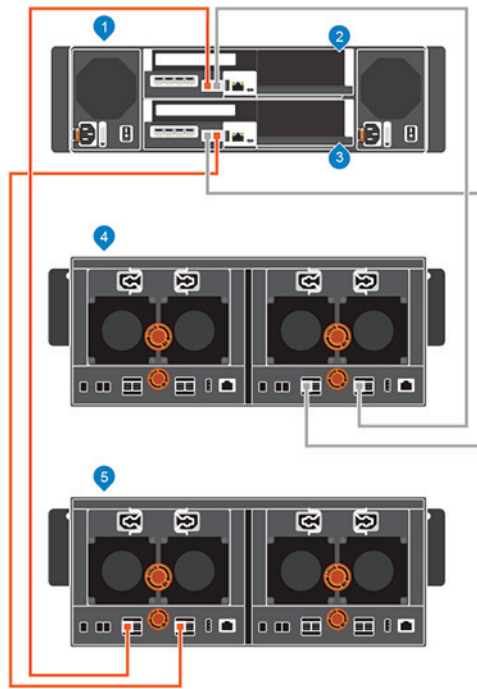

Figure 73. Reconnecting the A-Side Cable to the Remaining Expansion Enclosure

- | | |
|--------------------------|--------------------------|
| 1. Storage system | 2. Storage controller 1 |
| 3. Storage controller 2 | 4. Expansion enclosure 1 |
| 5. Expansion enclosure 2 | |

Disconnect the SCv360 Expansion Enclosure from the B-Side of the Chain

Disconnect the B-side cables from the expansion enclosure that you want to remove.

1. Disconnect the B-side cable (shown in blue) from expansion enclosure 1: right EMM, port 1. The A-side cables continue to carry I/O while the B-side is disconnected.
2. Remove the B-side cable between expansion enclosure 1: right EMM, port 2 and expansion enclosure 2: right EMM, port 1.

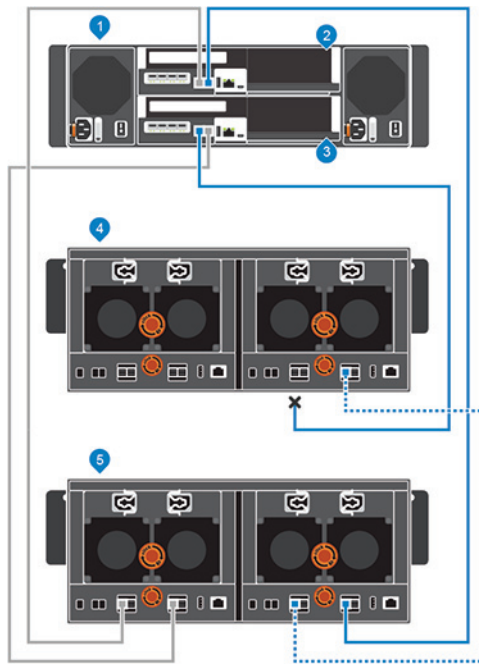

Figure 74. Disconnecting the B-Side Cables from the Expansion Enclosure

- | | |
|-------------------------|-------------------------|
| 1. Storage system | 2. Storage controller 1 |
| 3. Storage controller 2 | 4. Expansion enclosure |
3. Connect the B-side cable to expansion enclosure 2: right EMM, port 1.
The expansion enclosure is now disconnected and can be removed.

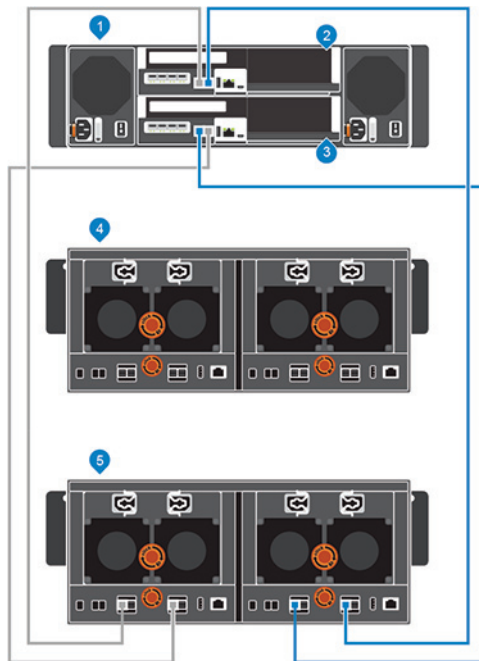

Figure 75. Reconnecting the B-Side Cable to the Remaining Expansion Enclosure

- | | |
|-------------------------|--------------------------|
| 1. Storage system | 2. Storage controller 1 |
| 3. Storage controller 2 | 4. Expansion enclosure 1 |



5. Expansion enclosure 2



Troubleshooting Storage Center Deployment

This section contains troubleshooting steps for common Storage Center deployment issues.

Troubleshooting Storage Controllers

To troubleshoot storage controllers:

1. Check the status of the storage controller using the Dell Storage Manager.
2. Check the position of the storage controllers.
3. Check the pins and reseat the storage controller.
 - a. Remove the storage controller.
 - b. Verify that the pins on the storage system backplane and the storage controller are not bent.
 - c. Reinstall the storage controller.
4. Determine the status of the storage controller link status indicators. If the indicators are not green, check the cables.
 - a. Shut down the storage controller.
 - b. Reseat the cables on the storage controller.
 - c. Restart the storage controller.
 - d. Recheck the link status indicators. If the link status indicators are not green, replace the cables.

Troubleshooting Hard Drives

To troubleshoot hard drives:

1. Check the status of the hard drive using the Dell Storage Manager.
2. Determine the status of the hard drive indicators.
 - If the hard drive status indicator blinks amber ON for two seconds and OFF for one second, the hard drive has failed.
 - If the hard drive status indicator is not lit, proceed to the next step.
3. Check the connectors and reseat the hard drive.



CAUTION: Perform this step only on unmanaged drives or after you confirm that the particular drive contains no user data. The Fault LED alone is not an indication that you can safely remove the drive.

- a. Remove the hard drive.
- b. Check the hard drive and the backplane to ensure that the connectors are not damaged.
- c. Reinstall the hard drive. Make sure the hard drive makes contact with the backplane.

Troubleshooting Expansion Enclosures

To troubleshoot expansion enclosures:

1. Check the status of the expansion enclosure using the Dell Storage Manager.
2. If an expansion enclosure and/or drives are missing from the Dell Storage Manager, you might need to check for and install Storage Center updates to use the expansion enclosure and/or drives.
3. If an expansion enclosure firmware update fails, check the back-end cabling and ensure that redundant connections are used.



Troubleshooting With Lasso

Lasso is a Dell application used to collect diagnostic information from one central location for a SAN environment. You can gather information from storage arrays, attached hosts, and switches to accurately analyze the storage area network.

Lasso Application

Download the Lasso application from this link: <http://www.dell.com/supporttcontents/US/en/04/category/product-support/self-support-knowledgebase/enterprise-resource-center/enterprise-tools>

Lasso Documentation

Download the *Lasso User's Guide* and *Release Notes* from this link: dell.com/support/home/us/en/19/product-support/product/dell-lass0-v4.7.2/manuals

Lasso Requirements

Before installing Lasso, make sure that the following prerequisites are met:

- User account has Administrator privileges
- System has one of the following Windows (32-bit or 64-bit) operating systems:
 - Windows 7, 8, 8.1, 10
 - Windows Server 2008, 2012, 2012 R2

NOTE: Windows Server Core is not supported.

- IP connectivity to all defined devices
- Java 1.6 or later
- Microsoft .NET Framework 2.0 or later is required on Windows hosts. The Microsoft .NET 2.0 Framework can be downloaded from this link: [Microsoft.NET 2.0 download](#)

For Lasso to successfully collect data from the SCv3000 and SCv3020, the following conditions must be met:

- SupportAssist is configured with Dell Storage Manager and has been tested.
- Port 443 is available.
- The server on which Lasso is installed is not:
 - A virtual center server
 - An SCVMM server
 - An IIS server and does not have the IIS Microsoft service running
 - Actively browsing to an https://site.
 - If the Dell Storage Manager Data Collector is installed and running, close the application. All these applications use port 443 and will cause a conflict with your collection.

The following credentials are required for collecting diagnostic information from the Storage Center:

- SCOS
 - SCOS management IP
 - SCOS Administrator user and password

Set Up a Local Host or VMware Host

After configuring a Storage Center, you can set up block-level storage for a local host running the Dell Storage Manager, VMware ESXi host, or multiple VMware ESXi hosts in a vSphere cluster.

Set Up a VMware ESXi Host from Initial Setup

Configure a VMware ESXi host to access block-level storage on the Storage Center.

Prerequisites

- Client must be running on a system with a 64-bit operating system.
- The Dell Storage Manager must be run by a Dell Storage Manager user with the Administrator privilege.
- On a Storage Center with Fibre Channel I/O ports, configure Fibre Channel zoning before starting this procedure.

Steps

1. On the **Configuration Complete** page of the **Discover and Configure Storage Center** wizard, click **Configure VMware vSpheres to access a Storage Center**.
The **Set up VMware Host on Storage Center** wizard opens.
2. Type the vCenter or ESXi IP address or host name, user name, and password. Then click **Next**.
 - If the Storage Center has iSCSI ports and the host is not connected to any interface, the **Log into Storage Center via iSCSI** page opens. Select the target fault domains, and then click **Log In**.
 - In all other cases, the **Verify vSpheres Information** page opens. Proceed to the next step.
3. Select an available port, and then click **Create Server**.
The server definition is created on the Storage Center.
4. The **Host Setup Successful** page displays the best practices that were set by the wizard and best practices that were not set. Make a note of any best practices that were not set by the wizard. It is recommended that these updates be applied manually before starting I/O to the Storage Center.
5. (Optional) Select **Create a Volume for this host** to create a volume after finishing host setup.
6. Click **Finish**.

Set Up a Local host from Initial Setup

Configure the local host from Initial Setup to access block-level storage on the Storage Center.

Prerequisites

- Client must be running on a system with a 64-bit operating system.
- The Dell Storage Manager must be run by a Dell Storage Manager user with the Administrator privilege.
- On a Storage Center with Fibre Channel I/O ports, configure Fibre Channel zoning before starting this procedure.

Steps

1. On the **Configuration Complete** page of the **Discover and Configure Storage Center** wizard, click **Set up block level storage for this host**.
The **Set up localhost for Storage Center** wizard opens.
 - If the Storage Center has iSCSI ports and the host is not connected to any interface, the **Log into Storage Center via iSCSI** page opens. Select the target fault domains, and then click **Log In**.
 - In all other cases, the **Verify localhost Information** page opens. Proceed to the next step.
2. On the **Verify localhost Information** page, verify that the information is correct. Then click **Create Server**.
The server definition is created on the Storage Center for the connected and partially connected initiators.



3. The **Host Setup Successful** page displays the best practices that were set by the wizard and best practices that were not set. Make a note of any best practices that were not set. It is recommended that these updates be applied manually before starting I/O to the Storage Center.
4. (Optional) Select **Create a Volume for this host** to create a volume after finishing host setup.
5. Click **Finish**.

Set Up Multiple VMware ESXi Hosts in a VMware vSphere Cluster

Configure multiple VMware ESXi hosts that are part of the vSphere cluster from initial setup to access block-level storage on the Storage Center.

Prerequisites

- Client must be running on a system with a 64-bit operating system.
- The Dell Storage Manager must be run by a Dell Storage Manager user with the Administrator privilege.
- On a Storage Center with Fibre Channel I/O ports, configure Fibre Channel zoning before starting this procedure.

Steps

1. On the **Configuration Complete** page of the **Discover and Configure Storage Center** wizard, click **Configure VMware vSphere to access a Storage Center**.
The **Set up VMware Host on Storage Center** wizard opens.
2. Type the vCenter IP address or host name, user name, and password. Then click **Next**.
 - If the Storage Center has iSCSI ports and the host is not connected to any interface, the **Log into Storage Center via iSCSI** page opens. Select the hosts and target fault domains, and then click **Log In**.
 - In all other cases, the **Verify vSpheres Information** page appears. Proceed to the next step.
3. Select an available port, and then click **Create Servers**.
The server definition is created on the Storage Center for each of the connected or partially connected hosts.
4. The **Host Setup Successful** page displays the best practices that were set by the wizard and best practices that were not set. Make a note of any best practices that were not set. It is recommended that these updates be applied manually before starting I/O to the Storage Center.
5. (Optional) Select **Create a Volume for this host** to create a volume after finishing host setup.
6. Click **Finish**.



Initialize the Storage Center Using the USB Serial Port

If the Discover and Configure Storage Center wizard does not discover the Storage Center that you want to initialize, use the serial port on a storage controller to find it.

Install the USB Serial Port Driver

Use this procedure to install a serial port driver that gives you access to the console ports on the storage system.

About this task

Install the serial port driver as a standard Windows driver.

The serial port for the SCv3000 and SCv3020 storage controller is an FT4232 USB device, which has four console ports. Only two ports are used when working with SCv3000 and SCv3020 storage systems:

- The first port is used to communicate with the Storage Center software.
- The second port is used to communicate with the Integrated Dell Remote Access Controller (iDRAC).

 **NOTE: Depending on the computer you are using, the port numbers might not always be 1 for the Storage Center software and 2 for the iDRAC. Communication with the Storage Center software always occurs over the port with the lower number.**

Steps

1. Use the micro-USB serial port cable to connect a Windows computer to the micro-USB connector on the top storage controller.
2. Wait for the Windows computer to identify the USB serial port.
3. Install the serial port driver.
 - If the Windows operating system opens a hardware wizard, follow the instructions to install the USB serial port driver.
 - If a hardware wizard does not open:
 1. Log in to the Dell Digital Locker at www.dell.com/support/licensing, and download the FTDI D2XX driver .zip file.
 2. Extract the content of the FTDI D2XX driver .zip file to a folder on the computer.
 3. Start the Device Manager.
 4. Find the hardware in the Device Manager.
 5. Right click on the hardware, select **Update Driver Software**, and browse to folder where driver files were extracted.
 6. Select the folder with the driver files, and click **Next**.
4. Reboot the computer.
5. Verify that the driver was successfully installed:
 - Check for the drivers manually:
 - Start **Device Manager**. The four COM ports appear in the list of devices.
 - Note the number of the first COM port. This number is the port used to connect to the Storage Center software.
 - If you cannot install the USB serial port driver, contact Dell Technical Support.

Establish a Terminal Session

Use this procedure to establish a terminal session with the Storage Center software on the top storage controller.

Prerequisites

Install the serial port driver that enables you to work with SCv3000 and SCv3020 storage systems ports.



- Port 1 is used to communicate with the Storage Center software.
- Port 2 is used to communicate with the iDRAC.

Steps

1. Make sure the micro-USB serial port cable is connected to the computer and the micro-USB connector on the top storage controller.
2. Open a terminal emulator program on the computer.
3. To facilitate troubleshooting, enable logging in the terminal emulator.
4. Configure the serial connection in the terminal emulator as shown in the following table.

Table 6. Serial Connection Settings

Setting	Value
Connection Type	Serial
Serial Line	COM1
Baud Rate (Speed)	115200
Data Bits	8
Stop Bits	1
Parity	None
Flow Control	XON/XOFF
Column Mode	132
Line Wrapping	Off

5. Press **Enter** several times to initiate the connection.
The terminal echoes back to indicate that connectivity is established.

Discover the Storage Center Using the Setup Utility Tool

Use the Setup Utility tool to discover the Storage Center.

1. Log in to the top storage controller.

- The login is `__setup__`

 **NOTE: The login contains two underscore characters before the word setup and two underscore characters after the word setup.**

- The password is `StorageCenterSetup`

The Setup Utility tool discovers the uninitialized Storage Center.

2. Type `Y` and press **Enter** to continue.
3. Type the system information, controller information, and user information in the prompts that are displayed.
4. After entering the information about the storage system, review the information. At the prompt **Do you wish to continue with this configuration?**, press **Enter**.

Configuration of the Storage Center begins, and messages appear to show the progress of the configuration.

5. After the configuration successfully completes, open the Dell Storage Manager and connect to the Storage Center using the management address.

The Discover and Configure Uninitialized Storage Center wizard opens to the **Create Storage Type** page.

 **NOTE: If you cannot discover the Storage Center using the Setup Utility tool, contact Dell Technical Support.**

Worksheet to Record System Information

Use the following worksheet to record the information that is needed to install the SCv3000 and SCv3020 storage system.

Storage Center Information

Gather and record the following information about the Storage Center network and the administrator user.

Table 7. Storage Center Network

Service Tag	_____
Management IPv4 address (Storage Center management address)	____.____.____.____
Top Controller IPv4 address (Controller 1 MGMT port)	____.____.____.____
Bottom Controller IPv4 address (Controller 2 MGMT port)	____.____.____.____
Subnet mask	____.____.____.____
Gateway IPv4 address	____.____.____.____
Domain name	_____
DNS server address	____.____.____.____
Secondary DNS server address	____.____.____.____

Table 8. Storage Center Administrator

Password for the default Storage Center Admin user	_____
Email address of the default Storage Center Admin user	_____

iSCSI Fault Domain Information

For a storage system with iSCSI front-end ports, gather and record network information for the iSCSI fault domains. This information is needed to complete the **Discover and Configure Uninitialized Storage Centers** wizard.

 **NOTE: For a storage system deployed with two Ethernet switches, Dell recommends setting up each fault domain on separate subnets.**

Table 9. iSCSI Fault Domain 1

Target IPv4 address	____.____.____.____
Subnet mask	____.____.____.____
Gateway IPv4 address	____.____.____.____
IPv4 address for storage controller module 1: port 1	____.____.____.____
IPv4 address for storage controller module 2: port 1	____.____.____.____
(Four port HBA only) IPv4 address for storage controller module 1: port 3	____.____.____.____
(Four port HBA only) IPv4 address for storage controller module 2: port 3	____.____.____.____



Table 10. iSCSI Fault Domain 2

Target IPv4 address	_____ . _____ . _____ . _____
Subnet mask	_____ . _____ . _____ . _____
Gateway IPv4 address	_____ . _____ . _____ . _____
IPv4 address for storage controller module 1: port 2	_____ . _____ . _____ . _____
IPv4 address for storage controller module 2: port 2	_____ . _____ . _____ . _____
(4-port HBA only) IPv4 address for storage controller module 1: port 4	_____ . _____ . _____ . _____
(4-port HBA only) IPv4 address for storage controller module 2: port 4	_____ . _____ . _____ . _____

Additional Storage Center Information

The Network Time Protocol (NTP) and Simple Mail Transfer Protocol (SMTP) server information is optional. The proxy server information is also optional, but it may be required to complete the **Discover and Configure Uninitialized Storage Centers** wizard.

Table 11. NTP, SMTP, and Proxy Servers

NTP server IPv4 address	_____ . _____ . _____ . _____
SMTP server IPv4 address	_____ . _____ . _____ . _____
Backup SMTP server IPv4 address	_____ . _____ . _____ . _____
SMTP server login ID	_____
SMTP server password	_____
Proxy server IPv4 address	_____ . _____ . _____ . _____

Fibre Channel Zoning Information

For a storage system with Fibre Channel front-end ports, record the physical and virtual WWNs of the Fibre Channel ports in Fault Domain 1 and Fault Domain 2. This information is displayed on the **Review Front-End** page of the **Discover and Configure Uninitialized Storage Centers** wizard. Use this information to configure zoning on each Fibre Channel switch.

Table 12. Physical WWNs in Fault Domain 1

Physical WWN of storage controller 1: port 1	_____
Physical WWN of storage controller 2: port 1	_____
(4-port HBA only) Physical WWN of storage controller 1: port 3	_____
(4-port HBA only) Physical WWN of storage controller 2: port 3	_____

Table 13. Virtual WWNs in Fault Domain 1

Virtual WWN of storage controller 1: port 1	_____
Virtual WWN of storage controller 2: port 1	_____
(4-port HBA only) Virtual WWN of storage controller 1: port 3	_____
(4-port HBA only) Virtual WWN of storage controller 2: port 3	_____



Table 14. Physical WWNs in Fault Domain 2

Physical WWN of storage controller 1: port 2	-----
Physical WWN of storage controller 2: port 2	-----
(4-port HBA only) Physical WWN of storage controller 1: port 4	-----
(4-port HBA only) Physical WWN of storage controller 2: port 4	-----

Table 15. Virtual WWNs in Fault Domain 2

Virtual WWN of storage controller 1: port 2	-----
Virtual WWN of storage controller 2: port 2	-----
(4-port HBA only) Virtual WWN of storage controller 1: port 4	-----
(4-port HBA only) Virtual WWN of storage controller 2: port 4	-----



HBA Server Settings

This appendix provides recommended HBA card settings that provide the most effective communication between the server and the Storage Center.

Settings by HBA Manufacturer

Storage Center has been tested to work with servers using Dell, Cisco, Emulex, and Qlogic HBAs.

 **NOTE: Cisco, Emulex, and Qlogic HBAs require additional configuration to improve the connection speeds between the server and the Storage Center. For more information regarding the compatibility of an HBA, see the [Dell Storage Compatibility Matrix](#).**

Dell 12 Gb SAS HBAs

Dell 12 Gb SAS HBAs are fully compatible with Storage Center and do not require further configuration.

Cisco Fibre Channel HBAs

Cisco manufactures Fibre Channel HBAs that are compatible with Storage Centers.

 **NOTE: For more information regarding the compatibility of a Cisco Fibre Channel HBA, see the [Dell Storage Compatibility Matrix](#).**

Configure a Cisco Fibre Channel HBA with the following settings:

Field	Setting
FCP Error Recovery	Disabled (default)
Flogi Retries	60
Flogi Timeout	4000 (default)
Plogi Retries	60
Plogi Timeout	20000 (default)
Port Down Timeout	10000 (default)
Port Down IO Retry	60 (default)
Link Down Timeout	30000 (default)

Emulex HBAs

Emulex manufactures HBAs for iSCSI and Fibre Channel connections that are compatible with Storage Centers.

 **NOTE: For more information regarding the compatibility of an HBA, see the [Dell Storage Compatibility Matrix](#). For more information about Emulex, see www.emulex.com.**

Configure Emulex HBA Settings

Configure Emulex HBA settings to enable the HBA to communicate more effectively with the Storage Center. Configure Emulex HBA settings with the Emulex HBAnywhere utility or the Emulex LightPulse BIOS. After configuring the settings based on the manufacturer of the HBA, configure the settings that apply to the operating system running on the server.

Configure an Emulex HBA to match the following settings:

Table 16. Emulex HBA Settings

Field	Setting
NodeTimeOut	60
QueueDepth	254
Topology	1

QLogic HBAs

QLogic manufactures HBAs that are compatible with Storage Centers.

 **NOTE:** For more information regarding the compatibility of an HBAs, see the [Dell Storage Compatibility Matrix](#). For more information about QLogic, see www.qlogic.com

Configure QLogic HBA Settings

Configure QLogic HBA settings to enable the HBA to communicate more effectively with the Storage Center. The following settings can be configured on any of the compatible QLogic HBAs from the QLogic Fast!UTIL BIOS or the QLogic SANsurfer. After configuring the settings based on the manufacturer of the HBA, configure the settings that apply to the operating system running on the server.

QLogic Fibre Channel HBAs

Configure a QLogic Fibre Channel HBA to match the following settings:

Table 17. Fibre Channel HBA Settings

Field	Settings
Connection options	1 for point-to-point only
Login retry count	60 attempts
Port down retry count	60 attempts
Link down timeout	30 seconds
Execution Throttle	256

QLogic iSCSI HBAs

Configure a QLogic iSCSI HBA to match the following settings:

Table 18. iSCSI HBA Settings

Field	Settings
ARP Redirect	Enabled

Settings by Server Operating System

To ensure effective communication with the Storage Center, configure the HBA settings from the server operating system. The following server operating systems can be configured to provide more effective communication with Storage Center.

- [Citrix XenServer](#)
- [Microsoft Windows Server](#)
- [Novell Netware](#)
- [Red Hat Enterprise Linux](#)



Citrix XenServer

Configure the server HBA settings for the Citrix XenServer to ensure that the server performs a proper storage system failover when working with Storage Center.

 **NOTE: If the server is configured in a high-availability cluster, contact Citrix for best practices for setting high-availability timeout values.**

Versions 5.x to 6.2

For Citrix XenServer versions 5.x through 6.2, to ensure that XenServer volumes will persist after a Storage Center controller failover, apply the following timeout values. These settings are located in the `mpathHBA` file located in the `/opt/xensource/sm/` directory. When finished, save the file and reboot the server.

Table 19. Citrix XenServer HBA Settings for Versions 5.x to 6.2

Field	Setting
DEFAULT_TIMEOUT	60
MPATH_TIMEOUT	60

Version 6.5

For Citrix XenServer version 6.5 and later, the multipath configuration file has been relocated. To ensure that XenServer volumes will persist after a Storage Center controller failover, apply the following timeout value. This setting is located in the `defaults` section of the `multipath.conf` configuration file located in the `/etc` directory. When finished, save the file and reboot the server.

The following code provides an example:

```
defaults {
user_friendly_names no
replace_wwid_whitespace yes
dev_loss_tmo 30
}
```

 **NOTE: The default value for the `dev_loss_tmo` timeout setting is 30. However, Dell recommends that the default is set to 60.**

Table 20. Citrix XenServer HBA Settings for Version 6.5 and Later

Field	Setting
dev_loss_tmo	60

Microsoft Windows Server

Double-check that the timeout value for a Microsoft Windows Server is set to 60 seconds.

Make sure that the **TimeoutValue** is set to 60 in the following Registry Editor location.

HKEY_LOCAL_MACHINE\SYSTEM\CurrentControlSet\Services\Disk

 **NOTE: It is recommended that the latest service pack be installed prior to installing the clustering service.**

Microsoft MPIO Settings

The following settings are recommended for Microsoft Windows Servers with MPIO installed.

Recommended MPIO Registry Settings

Configure the MPIO registry settings in the following registry location:

HKEY_LOCAL_MACHINE\SYSTEM\CurrentControlSet\services\mpio\Parameters

Table 21. MPIO Registry Settings

Field	Setting
PDORemovePeriod	120
PathRecoveryInterval	25
UseCustomPathRecoveryInterval	1

Recommended iSCSI Initiator Settings

Configure the iSCSI initiator settings in the following registry location:

HKEY_LOCAL_MACHINE\SYSTEM\CurrentControlSet\Control\Class\{4D36E97B-E325-11CE-BFC1-08002BE10318}\<Instance Number>\Parameters

Table 22. iSCSI Initiator Settings

Field	Setting
MaxRequestHoldTime	90
LinkDownTime	35
EnableNOPOut	1

Novell Netware

Servers running Novell Netware require that the portdown value be reconfigured to allow enough time for the storage systems to fail over.

To the end of the Fibre Channel driver load line of `nwserver/startup.ncf` add :

```
/LUNS /ALLPATHS /ALLPORTS /PORTDOWN=60
```

Red Hat Enterprise Linux

Timeout values determine the time a server waits before destroying a connection after losing connectivity. With a single-path configuration that value should be set to 60 seconds to allow the WWN of the failed port to transfer to a port on the other storage system. With a multipath configuration the timeout value should be set to 5 seconds because the ports will fail over immediately. Configure the timeout values as shown below based on the manufacturer of the HBA card and the path configuration.

Version 5.x

Configure these timeout values for servers running RHEL version 5.x. The settings vary based on the manufacturer of the HBA card. Add one of these settings to the end of the file `/etc/modprobe.conf` based on the manufacturer of the HBA card.

Qlogic HBA Settings**Path Configuration Timeout Setting**

Single Path `options qla2xxx qlport_down_retry=60`

Multipath `options qla2xxx qlport_down_retry=5`

Emulex HBA Settings**Path Configuration Timeout Setting**

Single Path `options lpfc lpfc_devloss_tmo=60`

Multipath `options lpfc lpfc_devloss_tmo=5`



Version 6.x

Changing HBA settings in RHEL version 6.x requires the creation of a new configuration file that contains the settings in the table below.

For Qlogic HBA cards, create a configuration file in **/etc/modprobe.d/** named **qla2xxx.conf** that contains one of the following parameters.

Qlogic HBA Settings

Path Configuration	Timeout Setting
--------------------	-----------------

Single Path	<code>options qla2xxx qlport_down_retry=60</code>
--------------------	---

Multipath	<code>options qla2xxx qlport_down_retry=5</code>
------------------	--

For Emulex HBA cards, create a configuration file in **/etc/modprobe.d/** named **lpfc.conf** that contains one of the following parameters.

Emulex HBA Settings

Path Configuration	Timeout Setting
--------------------	-----------------

Single Path	<code>options lpfc lpfc_devloss_tmo=60</code>
--------------------	---

Multipath	<code>options lpfc lpfc_devloss_tmo=5</code>
------------------	--



iSCSI Settings

This appendix lists recommended and required settings when using iSCSI cards.

Flow Control Settings

This section provides information about flow control and the recommended flow control settings.

Ethernet Flow Control

802.3x flow control is a mechanism for temporarily pausing data transmission when a NIC, an HBA port, or a switch port is transmitting data faster than its target port can accept the data.

Ethernet flow control allows a switch port to stop network traffic between two nodes by sending a PAUSE frame to another switch port or edge device. The PAUSE frame temporarily pauses transmission until the port is again able to service requests.

Switch Ports and Flow Control

Recommendations for using Ethernet Flow Control depends on the switch port hardware.

- Ethernet Flow Control should be set to ON for switch ports connected to Storage Center storage system card ports.
- Switch port settings for server NICs and other switch ports in the switch network should be set to ON.

Flow Control

Dell recommends the following settings as best practice when enabling flow control:

- A minimum of receive (RX) flow control should be enabled for all switch interfaces used by servers or storage systems for iSCSI traffic.
- Symmetric flow control should be enabled for all server interfaces used for iSCSI traffic. Storage Center automatically enables this feature.

 **NOTE:** To find best practices for iSCSI SAN switch configuration, go to the [Switch Configuration Guides](#) wiki page.

Jumbo Frames and Flow Control

Some switches have limited buffer sizes and can support either jumbo frames or flow control, but cannot support both at the same time. If you must choose between the two features, Dell recommends choosing flow control.

 **NOTE:** All the switches listed in the [Dell Storage Compatibility Matrix](#) support both jumbo frames and flow control at the same time.

However, if you use jumbo frames, be aware of the following:

- To simplify troubleshooting initial deployments, make sure that all servers, switches, and storage are fully operational before enabling jumbo frames.
- All devices connected through iSCSI must support 9K jumbo frames or larger.
- All devices used to connect iSCSI devices must support 9K jumbo frames. Every switch, router, WAN accelerator, and any other network device that handles iSCSI traffic must support 9K jumbo frames. If you are not sure that every device in your iSCSI network supports 9K jumbo frames, then do **not** turn on jumbo frames.
- Devices on both sides (server and SAN) must have jumbo frames enabled. It is recommended that any change to the jumbo frames enabled/disabled setting is conducted during a maintenance window.

- If MTU frame is not set correctly on the data paths, then devices cannot communicate. Packets that are larger than MTU size are discarded and do not reach the destination.
- QLogic 4010 series cards do not support jumbo frames.

Perform the following steps in Dell Storage Manager to display the model number of an iSCSI I/O card:

1. Use the Dell Storage Manager to connect to the Storage Center.
2. Click the **Hardware** tab.
3. From the **Hardware** tab navigation pane, click the **Controllers** node.
4. In the right pane, click the **IO Ports** tab.
5. In the **iSCSI** area of the **IO Ports** tab, the **Description** column displays the model numbers of the iSCSI I/O cards.

Other iSCSI Settings

The following tables lists Dell recommended iSCSI settings and best practices.

Table 23. Recommended iSCSI HBA Settings

Setting	iSCSI Best Practice
Full Duplex	<ul style="list-style-type: none"> · Use auto-negotiate for all interfaces that negotiate at full-duplex and at the maximum speed of the connected port (1 GbE or 10 GbE). · If a switch cannot correctly auto-negotiate at full-duplex or at the maximum speed of the connection, it should be hard set at full-duplex and at the maximum speed of the connected port (1 GbE or 10 GbE).
MTU	Verify the optimal MTU setting for replications. The default is 1500 but sometimes WAN circuits or VPNs create additional overhead that can cause packet fragmentation. This fragmentation may result in iSCSI replication failure and/or suboptimal performance. Adjust the MTU setting using the Dell Storage Manager.
Switch	<ul style="list-style-type: none"> · Configure switch interfaces that connect directly to servers or storage systems to forward using PortFast or Edgeport. Go to the Switch Configuration Guides wiki page and refer to the guide for the current switch. · Ensure that any switches used for iSCSI are of a non-blocking design. · When deciding which switches to use, remember that you are running iSCSI traffic over the switch. Use only quality, managed, enterprise-class networking equipment. It is not recommended to use SBHO (small business/home office) class equipment outside of lab/test environments. Check the Dell Storage Compatibility Matrix to ensure it has been fully tested to work in a SAN.
VLAN	<ul style="list-style-type: none"> · To find best practices for a VLAN, go to the Switch Configuration Guides wiki page and refer to the guide for the current switch. · Maintain two separate VLANs when using multipathed iSCSI. · Disable unicast storm control on every switch that handles iSCSI traffic. · Disable multicast at the switch level for all iSCSI VLANs. Set multicast storm control to enabled (if available) when multicast cannot be disabled.

