



Dell SCv3000 and SCv3020 Storage System Owner's Manual



Notes, Cautions, and Warnings

-  **NOTE:** A NOTE indicates important information that helps you make better use of your product.
-  **CAUTION:** A CAUTION indicates either potential damage to hardware or loss of data and tells you how to avoid the problem.
-  **WARNING:** A WARNING indicates a potential for property damage, personal injury, or death.

Contents

About This Manual.....	4
Revision History.....	4
Audience.....	4
Contacting Dell.....	4
1 SCv3000 and SCv3020 Storage System Hardware.....	5
SCv3000 and SCv3020 Storage System Front-Panel View.....	5
SCv3000 and SCv3020 Storage System Back-Panel View.....	6
SCv3000 and SCv3020 Storage System Drives.....	7
SCv3000 and SCv3020 Storage System Drive Numbering.....	7
SCv3000 and SCv3020 Storage Controller Features and Indicators	8
SCv3000 and SCv3020 Storage Controller.....	8
2 Replacing SCv3000 and SCv3020 Storage System Components.....	11
Safety Precautions.....	11
Installation Safety Precautions.....	11
Electrical Safety Precautions.....	11
Electrostatic Discharge Precautions.....	12
General Safety Precautions.....	12
Pre-Replacement Procedures.....	12
Send Diagnostic Data Using Dell SupportAssist.....	12
Change the Operation Mode of the Storage Center to Maintenance.....	12
Shut Down the Storage System and Expansion Enclosures.....	13
Bezel.....	13
Remove the Front Bezel.....	13
Install the Front Bezel.....	14
Hard Drives	14
Identify the Failed Drive.....	14
Remove the Failed Drive.....	14
Install the Replacement Drive.....	15
Rack Rails.....	15
Remove the Rack Rails.....	15
Install the Rack Rails.....	16
Power Supply and Cooling Fan Modules.....	17
Identify the Failed Power Supply.....	17
Identify the Failed Cooling Fan.....	18
Replace a Power Supply and Cooling Fan Module.....	18
3 SCv3000 and SCv3020 Storage System Technical Specifications.....	20
Technical Specifications.....	20



About This Manual

This manual describes the features and technical specifications of an SCv3000 and SCv3020 storage system.

Revision History

Document Number: 680-137-001

Revision	Date	Description
A	October 2017	Initial release

Audience

The information provided in this manual is intended for use by Dell end users.

Contacting Dell

Dell provides several online and telephone-based support and service options. Availability varies by country and product, and some services might not be available in your area.

To contact Dell for sales, technical support, or customer service issues, go to www.dell.com/support.

- For customized support, type your system service tag on the support page and click **Submit**.
- For general support, browse the product list on the support page and select your product.



SCv3000 and SCv3020 Storage System Hardware

The SCv3000 and SCv3020 storage system ships with Dell Enterprise Value drives, two redundant power supply/cooling fan modules, and two redundant storage controllers.

Each storage controller contains the front-end, back-end, and management communication ports of the storage system.

SCv3000 and SCv3020 Storage System Front-Panel View

The front panel of the storage system contains power and status indicators, and a system identification button.

In addition, the hard drives are installed and removed through the front of the storage system chassis.

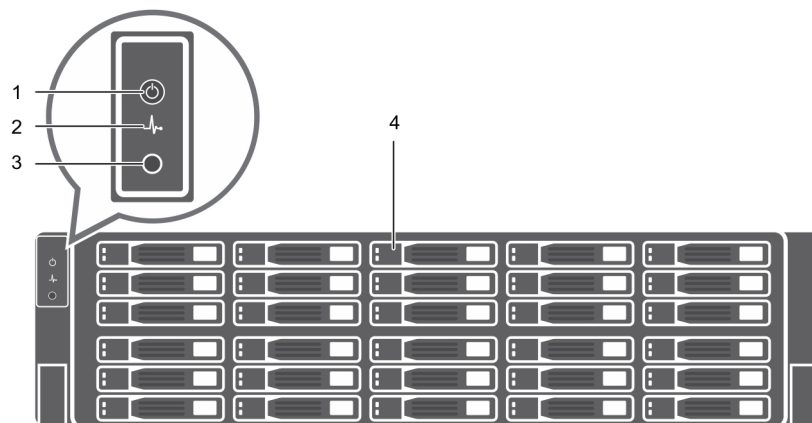





Figure 1. SCv3000 and SCv3020 Storage System Front-Panel View

Item	Name	Icon	Description
1	Power indicator		Lights when the storage system power is on <ul style="list-style-type: none"> Off – No power On steady green – At least one power supply is providing power to the storage system
2	Status indicator		Lights when the startup process for both storage controllers is complete with no faults detected. <p>NOTE: The startup process can take 5–10 minutes or more.</p> <ul style="list-style-type: none"> Off – One or both storage controllers are running startup routines, or a fault has been detected during startup On steady blue – Both storage controllers have completed the startup process and are in normal operation Blinking amber – Fault detected
3	Identification button		Blinking blue continuously – A user sent a command to the storage system to make the LED blink so that the user can identify the storage system in the rack.

Item	Name	Icon	Description
			<ul style="list-style-type: none"> The identification LED blinks on the control panel of the chassis, to allow users to find the storage system when looking at the front of the rack. The identification LEDs on the storage controllers also blink, which allows users to find the storage system when looking at the back of the rack.
4	Hard drives	—	Can have up to 30 internal 2.5-inch SAS hard drives

SCv3000 and SCv3020 Storage System Back-Panel View

The back panel of the storage system contains the storage controller indicators and power supply indicators.

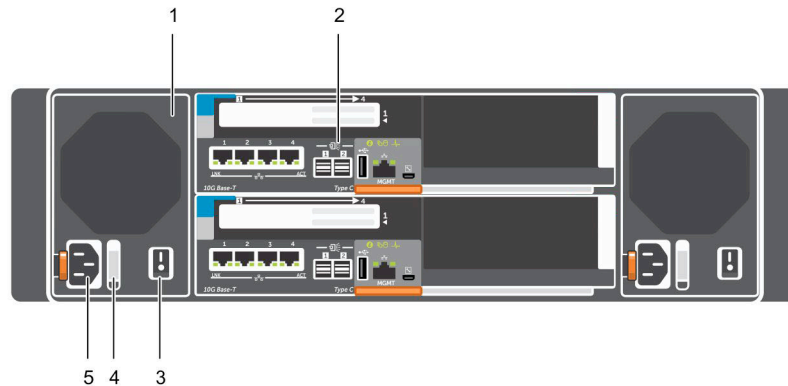

Figure 2. SCv3000 and SCv3020 Storage System Back-Panel View

Item	Name	Icon	Description
1	Power supply/cooling fan module (2)		Contains a 1485 W power supply and fans that provide cooling for the storage system, with AC input to the power supply of 200–240 V. In Dell Storage Manager, the power supply/cooling fan module on the left side of the back panel is Power Supply 1 and power supply/cooling fan module on the right side of the back panel is Power Supply 2.
2	Storage controller (2)	—	<p>Each storage controller contains:</p> <ul style="list-style-type: none"> Optional 10 GbE iSCSI mezzanine card with four SFP+ ports or four RJ45 10GBASE-T ports One expansion slot for a front-end I/O card: <ul style="list-style-type: none"> Fibre Channel iSCSI SAS SAS expansion ports – Two 12 Gbps SAS ports for back-end connectivity to expansion enclosures USB port – Single USB 2.0 port MGMT port – Embedded Ethernet port for system management Serial port – Micro-USB serial port used for an alternative initial configuration and support-only functions
3	Power switch (2)	—	Controls power for the storage system. Each power supply/cooling fan module has one power switch.
4	Power supply/cooling fan module LED handle	—	<p>The handle of the power supply/cooling fan module indicates the DC power status of the power supply and the fans.</p> <ul style="list-style-type: none"> Not lit – No power Solid green – Power supply has valid power source and is operational Blinking amber – Error condition in the power supply Blinking green – Firmware is being updated.

Item	Name	Icon	Description
			<ul style="list-style-type: none"> Blinking green then off – Power supply mismatch
5	Power socket (2)	—	Accepts the following standard computer power cords: <ul style="list-style-type: none"> IEC320-C13 for deployments worldwide IEC60320-C19 for deployments in Japan

SCv3000 and SCv3020 Storage System Drives

The SCv3000 and SCv3020 storage system supports Dell Enterprise Plus Value drives.

The drives in an SCv3000 storage system are installed horizontally. The drives in an SCv3020 storage system are installed vertically. The indicators on the drives provide status and activity information.



Figure 3. SCv300 and SCv320 Expansion Enclosure Drive Indicators

Item	Control/Feature	Indicator Code
1	Drive activity indicator	<ul style="list-style-type: none"> Blinking green – Drive has I/O activity Steady green – Drive is detected and has no faults
2	Drive status indicator	<ul style="list-style-type: none"> Steady green – Normal operation Blinking green – A command was sent by Dell Storage Manager to the drive to make the LED blink so that users can identify the drive in the rack. Blinking amber – Hardware or firmware fault

SCv3000 and SCv3020 Storage System Drive Numbering

The storage system holds up to 16 or 30 drives, which are numbered from left to right in rows starting from 0 at the top-left drive. Drive numbers increment from left to right, and then top to bottom such that the first row of drives is numbered from 0 to 4 from left to right, and the second row of drives is numbered from 5 to 9 from left to right.

Dell Storage Manager identifies drives as *XX-YY*, where *XX* is the number of the unit ID of the storage system and *YY* is the drive position inside the storage system.



Figure 4. SCv3000 Storage System Drive Numbering

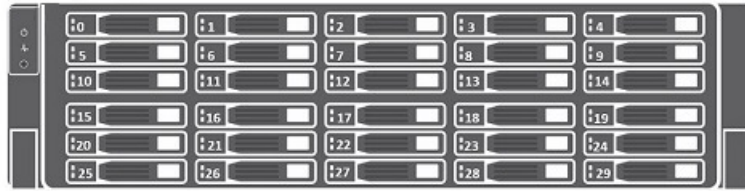

Figure 5. SCv3020 Storage System Drive Numbering

SCv3000 and SCv3020 Storage Controller Features and Indicators

The SCv3000 and SCv3020 storage system includes two storage controllers in two interface slots.

SCv3000 and SCv3020 Storage Controller

The following figure shows the features and indicators on the storage controller.

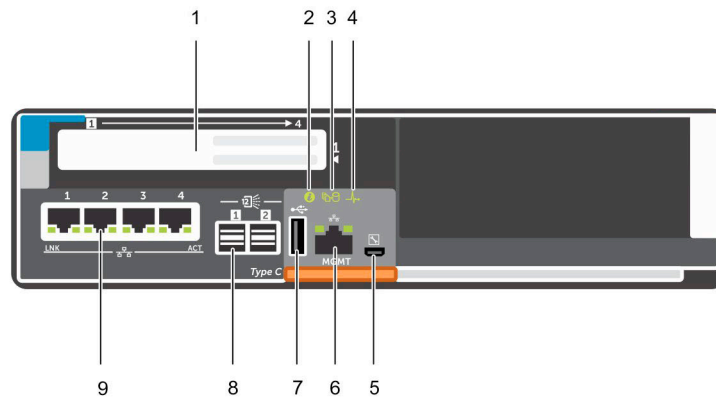











Figure 6. SCv3000 and SCv3020 Storage Controller

Item	Control/Feature	Icon	Description
1	I/O card slot		<p>Fibre Channel I/O card – Ports are numbered 1 to 4 from left to right</p> <ul style="list-style-type: none"> The LEDs on the 16 Gb Fibre Channel ports have the following meanings: <ul style="list-style-type: none"> All off – No power All on – Booting up Blinking amber – 4 Gbps activity Blinking green – 8 Gbps activity Blinking yellow – 16 Gbps activity Blinking amber and yellow – Beacon All blinking (simultaneous) – Firmware initialized All blinking (alternating) – Firmware fault The LEDs on the 32 Gb Fibre Channel ports have the following meanings: <ul style="list-style-type: none"> All off – No power All on – Booting up Blinking amber – 8 Gbps activity Blinking green – 16 Gbps activity Blinking yellow – 32 Gbps activity Blinking amber and yellow – Beacon All blinking (simultaneous) – Firmware initialized All blinking (alternating) – Firmware fault



Item	Control/Feature	Icon	Description
			iSCSI I/O card – Ports are numbered 1 to 4 from left to right
			NOTE: The iSCSI I/O card supports Data Center Bridging (DCB), but the mezzanine card does not support DCB.
			<ul style="list-style-type: none"> The LEDs on the iSCSI ports have the following meanings: <ul style="list-style-type: none"> Off – No power Steady Amber – Link Blinking Green – Activity
			SAS I/O card – Ports are numbered 1 to 4 from left to right
			The SAS ports on SAS I/O cards do not have LEDs.
2	Identification LED		<p>Blinking blue continuously – A command was sent by Dell Storage Manager to the storage system to make the LED blink so that users can identify the storage system in the rack.</p> <p>The identification LED blinks on the control panel of the chassis, which allows users to find the storage system when looking at the front of the rack.</p> <p>The identification LEDs on the storage controllers also blink, which allows users to find the storage system when looking at the back of the rack.</p>
3	Cache to Flash (C2F)		<ul style="list-style-type: none"> Off – Running normally Blinking green – Running on battery (shutting down)
4	Health status		<ul style="list-style-type: none"> Off – Unpowered Blinking amber <ul style="list-style-type: none"> Slow blinking amber (2s on, 1s off) – Controller hardware fault was detected. Use Dell Storage Manager to view specific details about the hardware fault. Fast blinking amber (4x per second) – Power good and the pre-operating system is booting Blinking green <ul style="list-style-type: none"> Slow blinking green (2s on, 1s off) – Operating system is booting Blinking green (1s on, 1s off) – System is in safe mode Fast blinking green (4x per second) – Firmware is updating Solid green – Running normal operation
5	Serial port (micro USB)		Used under the supervision of Dell Technical Support to troubleshoot and support systems.
6	MGMT port	—	<p>Ethernet port used for storage system management and access to Dell Storage Manager.</p> <p>Two LEDs with the port indicate link status (left LED) and activity status (right LED):</p> <ul style="list-style-type: none"> Link and activity indicators are off – Not connected to the network Link indicator is green – The NIC is connected to a valid network at its maximum port speed. Link indicator is amber – The NIC is connected to a valid network at less than its maximum port speed. Activity indicator is blinking green – Network data is being sent or received.
7	USB port		One USB 2.0 connector that is used for SupportAssist diagnostic files when the storage system is not connected to the Internet.

Item	Control/Feature	Icon	Description
8	Mini-SAS (ports 1 and 2)		<p>Back-end expansion ports 1 and 2. LEDs with the ports indicate connectivity information between the storage controller and the expansion enclosure:</p> <ul style="list-style-type: none"> · Steady green indicates the SAS connection is working properly. · Steady yellow indicates the SAS connection is not working properly.
9	Mezzanine card		<p>The iSCSI ports on the mezzanine card are either 10 GbE SFP+ ports or 1 GbE/10 GbE RJ45 ports.</p> <p>The LEDs on the iSCSI ports have the following meanings:</p> <ul style="list-style-type: none"> · Off – No connectivity · Steady green, left LED – Link (full speed) · Steady amber, left LED – Link (degraded speed) · Blinking green, right LED – Activity <p> NOTE: The mezzanine card does not support DCB.</p>

Replacing SCv3000 and SCv3020 Storage System Components

This chapter describes how to remove and install components of the SCv3000 and SCv3020 storage system. This information assumes that you have received the replacement component and are ready to install it.

Safety Precautions

Always follow these safety precautions to avoid injury and damage to Storage Center equipment.

If equipment described in this guide is used in a manner not specified by Dell, the protection provided by the equipment could be impaired. For your safety and protection, observe the rules described in the following sections.

 **NOTE: See the safety and regulatory information that shipped with each Storage Center component. Warranty information is included as a separate document.**

Installation Safety Precautions

Follow these safety precautions when installing an SCv3000 and SCv3020 storage system:

- Dell recommends that only individuals with rack-mounting experience install an SCv3000 and SCv3020 storage system in a rack.
- When installing multiple expansion enclosures in a rack, fill the rack from the bottom up and empty the rack from the top down.
- The rack construction must support the total weight of the installed expansion enclosures. The design should incorporate stabilizing features suitable to prevent the rack from tipping or being pushed over during installation or in normal use.
- To prevent the rack from tipping, slide only one storage system out of the rack at a time.
- Make sure that the storage system is always fully grounded to prevent damage from electrostatic discharge.
- When handling the storage system components, use an electrostatic wrist guard or a similar form of protection.

Electrical Safety Precautions

Always follow electrical safety precautions to avoid injury and damage to Storage Center equipment.

- Provide a suitable power source with electrical overload protection. All Storage Center components must be grounded before applying power. Make sure that a safe electrical earth connection can be made to power supply cords. Check the grounding before applying power.
- The plugs on the power supply cords are used as the main disconnect device. Make sure that the socket outlets are located near the equipment and are easily accessible.
- Know the locations of the equipment power switches and the room's emergency power-off switch, disconnection switch, or electrical outlet.
- Do not work alone when working with high-voltage components.
- Use rubber mats specifically designed as electrical insulators.
- Do not remove covers from the power supply unit. Disconnect the power connection before removing a power supply from the storage system.
- Do not remove a faulty power supply unless you have a replacement model of the correct type ready for insertion.
- Unplug the storage system chassis before you move it or if you think it has become damaged in any way. When powered by multiple AC sources, disconnect all power sources for complete isolation.



Electrostatic Discharge Precautions

Always follow electrostatic discharge (ESD) precautions to avoid injury and damage to Storage Center equipment.

Electrostatic discharge (ESD) is generated by two objects with different electrical charges coming into contact with each other. The resulting electrical discharge can damage electronic components and printed circuit boards. Follow these guidelines to protect your equipment from ESD:

- Dell recommends that you always use a static mat and static strap while working on components in the interior of the chassis.
- Observe all conventional ESD precautions when handling plug-in modules and components.
- Use a suitable ESD wrist or ankle strap.
- Avoid contact with backplane components and module connectors.
- Keep all components and printed circuit boards (PCBs) in their antistatic bags until ready for use.

General Safety Precautions

Always follow general safety precautions to avoid injury and damage to Storage Center equipment.

- Keep the area around the storage system chassis clean and free of clutter.
- Place any system components that have been removed away from the storage system chassis or on a table so that they are not in the way of other people.
- While working on the storage system chassis, do not wear loose clothing such as neckties and unbuttoned shirt sleeves. These items can come into contact with electrical circuits or be pulled into a cooling fan.
- Remove any jewelry or metal objects from your body. These items are excellent metal conductors that can create short circuits and harm you if they come into contact with printed circuit boards or areas where power is present.
- Do not lift the storage system chassis by the handles of the power supply units (PSUs). They are not designed to hold the weight of the entire chassis, and the chassis cover could become bent.
- Before moving the storage system chassis, remove the PSUs to minimize weight.
- Do not remove drives until you are ready to replace them.

 **NOTE: To ensure proper storage system cooling, hard drive blanks must be installed in any hard drive slot that is not occupied.**

Pre-Replacement Procedures

Send Diagnostic Data Using Dell SupportAssist

Before replacing components, use Dell SupportAssist to send diagnostic data to Dell Technical Support.

1. Use Dell Storage Manager to connect to the Storage Center.
2. In the **Summary** tab, click **Send SupportAssist Information Now**, which is located under **SupportAssist Actions** in the **Status** pane.
The **Send SupportAssist Information Now** dialog box opens.
3. Select **Storage Center Configuration** and **Detailed Logs**.
4. Click **OK**.

Change the Operation Mode of the Storage Center to Maintenance

Change the operation mode of the Storage Center to Maintenance before replacing components.

1. Use Dell Storage Manager to connect to the Storage Center.
2. In the **Summary** tab, click **Edit Settings**. The **Edit Storage Center Settings** dialog box opens.
3. Click the **General** tab.
4. In the **Operation Mode** field select **Maintenance**. Selecting **Maintenance** isolates alerts from those that would occur during normal operation.

5. Click **OK**.

Shut Down the Storage System and Expansion Enclosures

If the replacement component is not hot-swappable, use the Dell Storage Manager to shut down the storage system and expansion enclosures. Shutting down the storage system and expansion enclosures results in a system outage, so plan to perform these procedures during a maintenance window.

Prerequisites

Before shutting down the storage system and expansion enclosures, perform the following tasks:

1. Identify the part to replace.
2. Locate the replacement part.
3. Make sure that you have the tools required to replace the part.

Steps

1. From the Actions menu, select **System** → **Shutdown/Restart**. The **Shutdown/Restart** dialog box appears.
2. From the **What should the Storage Center do?** drop-down menu, select **Shut Down**.

Bezel

The front bezel is a cover for the front panel of the SCv3000 and SCv3020 storage system.

Remove the Front Bezel

Before you remove or install hard drives in the storage system, remove the front bezel.

1. Use the system key to unlock the keylock at the left end of the bezel.
2. Lift the release latch next to the keylock.
3. Rotate the left end of the bezel away from the front panel.
4. Unhook the right end of the bezel and pull the bezel away from the storage system.

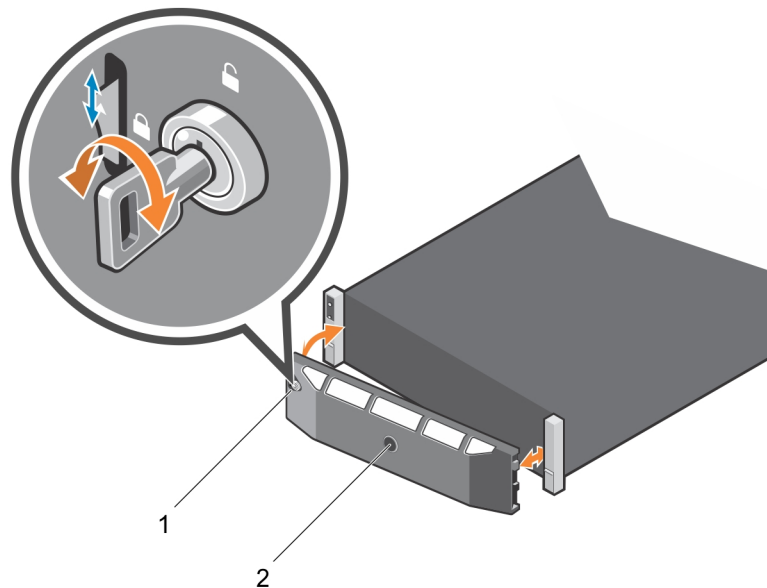

Figure 7. Installing and Removing the Bezel

1. Keylock

2. Front bezel



Install the Front Bezel

To secure the storage system, install the front bezel.

1. Hook the right end of the replacement bezel onto the front panel of the storage system.
2. Insert the left end of the bezel into the securing slot until the release latch locks into place.
3. Secure the bezel with the keylock.

Hard Drives

The SCv3000 and SCv3020 storage system supports hot-swappable hard drives.

A minimum of 4 SSDs or 7 drives must be installed in the chassis or in an expansion enclosure. The SCv3000 and SCv3020 storage system supports a maximum of 16 or 30 drives installed in the chassis. The drives are installed from left to right, and then top to bottom. The first row of drives are numbered from 0–4 from left to right, the second row of drives are numbered from 5–9 from left to right, and so on.

Dell Storage Manager identifies drives as *XX-YY*, where *XX* is the number of the unit ID of the storage system and *YY* is the drive position inside the storage system.

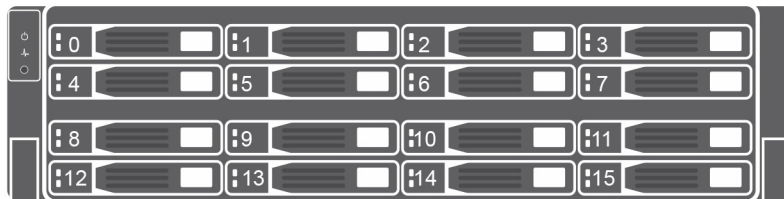

Figure 8. SCv3000 Storage System Drive Numbering

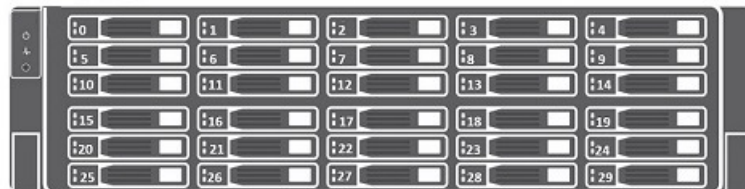

Figure 9. SCv3020 Storage System Drive Numbering

Identify the Failed Drive

To determine which drive failed, use Dell Storage Manager.

1. Click the **Hardware** tab.
2. In the **Hardware** tab navigation pane, select the **Enclosures** node.
3. Click the **Disks** tab.
4. Find the drive with the status of **Down**.
5. Record the location of the drive from the **Name** column.

Remove the Failed Drive

Use this procedure to remove a failed drive from the SCv3000 and SCv3020 storage system.

Prerequisites

- Before removing the drive, make sure that the following alert is displayed in the **Alerts** tab of Dell Storage Manager:
Drive # is ready to be removed., where # is the drive position in the storage system.

- Use Dell Storage Manager to edit the Storage Center settings and set the operation mode of the Storage Center to Maintenance mode.

Steps

1. Remove the front bezel from the storage system.
2. Locate the failed hard drive in the storage system.
3. Press the release button to open the hard drive carrier release handle.
4. Slide the hard drive carrier out of the hard drive slot.

Install the Replacement Drive

Use this procedure to install a drive in the SCv3000 and SCv3020 storage system.

Steps

1. Open the release handle on the drive carrier and insert the hard drive carrier into the open drive slot.
2. Slide the drive into the slot until the drive carrier contacts the midplane.
3. Close the drive carrier handle to lock the drive in place.
4. Continue to push firmly until you hear a click and the drive carrier handle fully engages.
5. Clear the drive swap status from the **Hardware** tab in Dell Storage Manager.

For instructions, see the *Storage Manager Administrator's Guide*.

Next steps

1. Install the front bezel on the storage system.
2. Use Dell Storage Manager to edit the Storage Center settings and set the operation mode of the Storage Center to Normal mode.
3. Use Dell Storage Manager to send SupportAssist information to Dell Technical Support.

Rack Rails

Rack rails are used to install the storage controller into a rack.

Remove the Rack Rails

Prerequisites

1. Use SupportAssist to send diagnostic data to Dell Technical Support.
2. Shut down the storage system using the Dell Storage Manager.

About this task



NOTE: Replacing rack rails must be performed during a scheduled maintenance window when the Storage Center system is unavailable to the network.

Steps

1. Make sure all the cables are labeled.
2. Disconnect all of the cables from the storage system.
3. Loosen the screws in the chassis ears that secure the chassis to the rack.



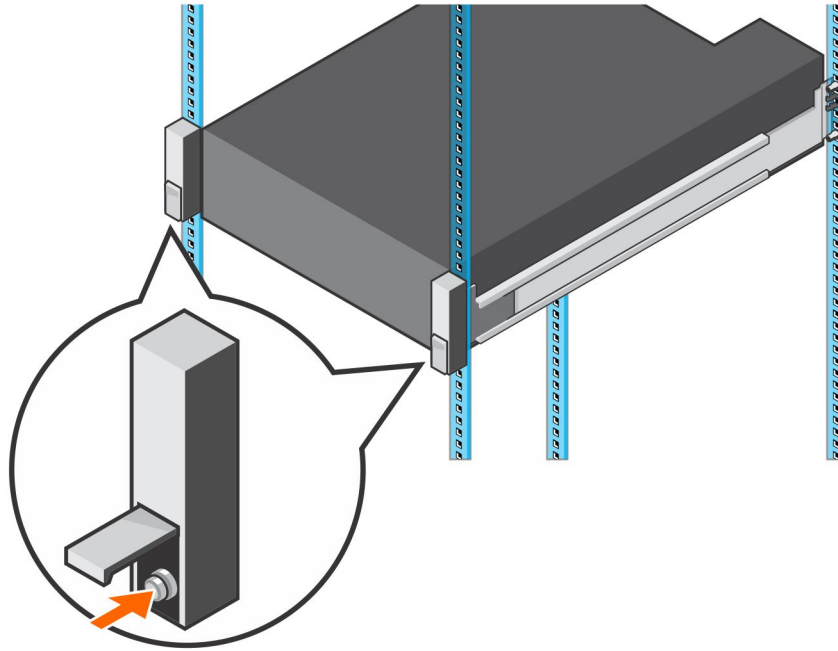

Figure 10. Loosen the Screws

4. Remove the storage system from the rack.
5. Remove the rack rails from the rack.

Install the Rack Rails

Perform the following steps to install rack rails for an SCv3000 and SCv3020 storage system.

Steps

1. Install the replacement rack rails in the rack.
2. Install the storage system in the rack.
3. Tighten the screws in the chassis ears that secure the chassis to the rack.

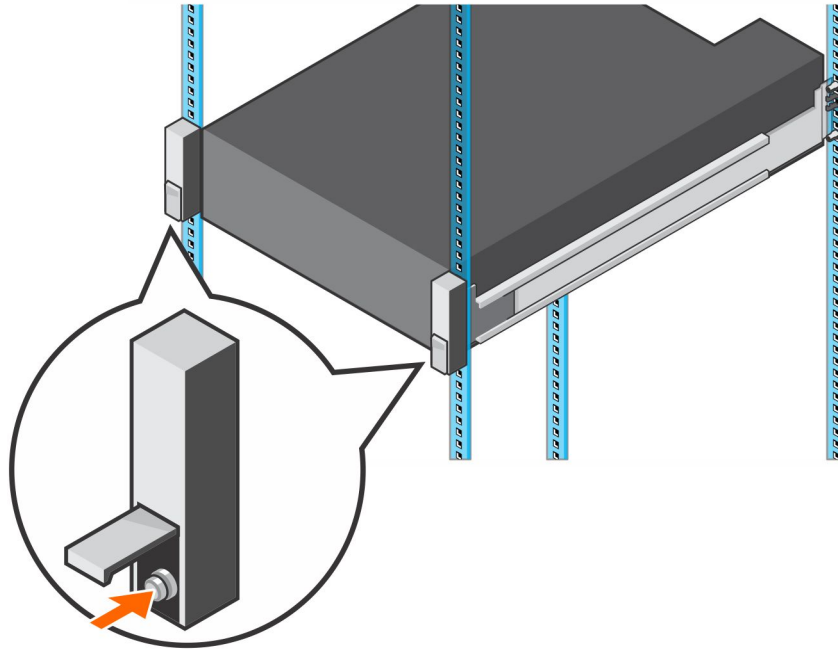

Figure 11. Tighten the Screws

4. Reconnect the cables to the storage system.
5. Start up the storage system.

Next step

Use SupportAssist to send diagnostic data to Dell Technical Support.

Power Supply and Cooling Fan Modules

The SCv3000 and SCv3020 storage system supports two hot-swappable power supply/cooling fan modules.

The cooling fans that cool the storage system and the power supplies are integrated into the power supply/cooling fan module and cannot be replaced separately. If one power supply/cooling fan module fails, the second module continues to provide power to the storage system.

NOTE: When a power supply/cooling fan module fails, the cooling fan speed in the remaining module increases significantly to provide adequate cooling. The cooling fan speed decreases gradually when a new power supply/cooling fan module is installed.

CAUTION: A single power supply/cooling fan module can be removed from a powered-on storage system for no more than 90 seconds. If a power supply/cooling fan module is removed for longer than 90 seconds, the storage system might shut down automatically to prevent damage.

Identify the Failed Power Supply

To determine which power supply failed, use Dell Storage Manager.

1. Click the **Hardware** tab.
2. In the **Hardware** tab navigation pane, click **Power Supply**.
3. Find the power supply with a status of **Down**.
4. Record the location of the failed power supply.



Identify the Failed Cooling Fan

To determine which cooling fan failed, use Dell Storage Manager.

1. Click the **Hardware** tab.
2. Click the **Fan Sensor** node.
3. Find the fan with a status of **Down**.
4. Record the location of the power supply in which the fan has failed.

Replace a Power Supply and Cooling Fan Module

Use this procedure to replace failed a power supply/cooling fan module.

Prerequisites

1. Use Dell Storage Manager to send SupportAssist information to Dell Technical Support.
2. Use Dell Storage Manager to edit the Storage Center settings and set the operation mode of the Storage Center to Maintenance mode.

About this task

You can replace power supply/cooling fan modules one at a time without shutting down the storage system.

Steps

1. Press the power switch on the power supply/cooling fan module to turn it off.
To prevent the module from overheating, replace it within 3 minutes.
2. Remove the hook-and-loop strap that secures the power cable to the LED handle and disconnect the power cable from the power supply/cooling fan module.



Figure 12. Removing the Hook and Loop Strap from the Power Cable

3. Push the release tab on the power supply/cooling fan module to the right and use the handle to slide the module out of the chassis.

△ CAUTION: The power supply/cooling fan modules are heavy. To avoid injury, use both hands while removing the module.

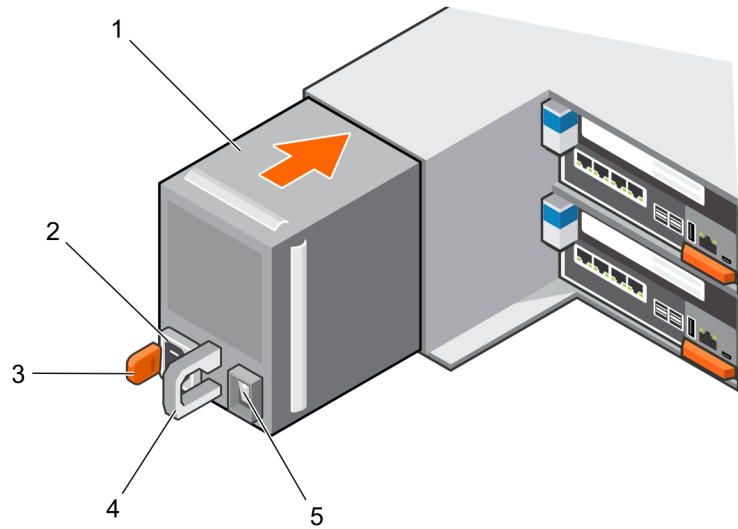

Figure 13. Removing a Power Supply/Cooling Fan Module

- | | |
|------------------------------------|---|
| 1. Power supply/cooling fan module | 2. Power socket |
| 3. Release tab | 4. Power supply/cooling fan module LED handle |
| 5. Power switch | |

4. Slide the replacement power supply/cooling fan module into the chassis until it is fully seated and the release tab clicks into place.
5. Connect the power cable to the power supply/cooling fan module and make sure the cable is plugged into a power outlet.
6. Secure the power cable using the hook-and-loop strap.
7. Press the power switch on the power supply/cooling fan module to turn it on.

NOTE: Allow several seconds for the storage system to recognize the power supply/cooling fan module and determine its status. When the power supply/cooling fan module is functioning properly, the AC power status indicator turns green and the power supply/cooling fan status indicator is off.

8. In Dell Storage Manager, make sure that the replacement power supply is recognized and shows as up and running.

Next step

1. Use Dell Storage Manager to edit the Storage Center settings and set the operation mode of the Storage Center to Normal mode.
2. Use Dell Storage Manager to send SupportAssist information to Dell Technical Support.

SCv3000 and SCv3020 Storage System Technical Specifications

This appendix contains the technical specifications for the SCv3000 and SCv3020 storage system.

Technical Specifications

The technical specifications of the SCv3000 and SCv3020 storage systems are displayed in the following tables.

Drives	
SAS hard drives	<p>SCv3000 Up to 16 3.5-in. hot-swappable hard drives (12 Gb SAS)</p> <p>SCv3020 Up to 30 2.5-in. SAS hot-swappable hard drives (12 Gb SAS)</p>
Storage Controllers	
Storage controllers	<p>Up to two hot-swappable storage controllers with one I/O card slot and one optional mezzanine card per storage controller.</p> <p>Each storage controller has an internal battery backup unit. Write cache is mirrored between the two storage controllers. If a power failure occurs, the battery backup unit provides power to the storage controller so that the write cache can be saved to an SSD within the storage controller.</p>
Storage Connectivity	
Configurations	<p>SCv3000 Supports a total of 150 drives and up to 120 drives on a single SAS chain.</p> <p>SCv3020 Supports a total of 150 drives and up to 134 drives on a single SAS chain.</p>
Redundant Array of Independent Disks (RAID)	
Controller	Two hot-swappable storage controllers
Management	RAID management using the Dell Storage Manager
Back-Panel Ports Connectors (per Storage Controller)	
Fibre Channel, iSCSI, or SAS front-end connectors	Connection to a Fiber Channel fabric, iSCSI network, or a direct connection to servers with SAS HBAs
Ethernet connectors	MGMT – 1 Gbps embedded Ethernet port used for Storage Center management
SAS back-end connectors	12 Gb SAS ports for connections to expansion enclosures
	 NOTE: SAS connectors are SFF-8644 compliant.
Serial connector (micro USB)	Used for initial configuration and support-only functions

LED Indicators

Front panel	<ul style="list-style-type: none">• One dual-color LED indicator for system status• One single-color LED indicator for power status• Identification button with a single-color LED
Hard drive carrier	<ul style="list-style-type: none">• One single-color activity LED• One dual-color LED status indicator per drive
Storage controller	<ul style="list-style-type: none">• Two single-color LEDs per Ethernet port indicating activity and link speed• One dual-color LED per SAS connector indicating port activity and status• One single-color LED indicating status• One single-color LED indicating system faults• One single-color LED for system identification
Power supply/cooling fan	One dual-color LED handle indicating power supply and cooling fan status

Power Supply Units (PSU)

AC power supply (per power supply)	PSU Type 1	PSU Type 2 (Japan Only)	PSU Type 3
Maximum output power	1485 W	1485 W	1378 W
Maximum input power	1688 W	1707 W	1584 W
Maximum input current	8.8 A	17.5 A	16 A
Maximum inrush current	55 A for 10 ms or less	55 A for 10 ms or less	55 A for 10 ms or less
Nominal input voltage operating range	200–240 VAC	100–240 VAC	100–240 VAC
Nominal input frequency	50/60 Hz	50/60 Hz	50/60 Hz
Thermal output/heat dissipation	693 BTU per hour	757 BTU per hour	703 BTU per hour

Available Hard Drive Power (Per Slot)

Supported hard drive power consumption (continuous)	Up to 1.2 A at +5 V Up to 0.5 A at +12 V
---	---

Physical

Height	13.34 cm (5.25 in.)
Width	44.50 cm (17.5 in.)
Depth	SCv3000 81.91 cm (32.25 in.) SCv3020 78.27 cm (31 in.)
Approximate weight (maximum configuration)	SCv3000 45 kg SCv3020 43 kg
Approximate weight without drives	32.5 kg (72 lb)



Environmental

For additional information about environmental measurements for specific storage system configurations, see dell.com/environmental_datasheets.

Temperature

Operating	10°C (50°F) to 35°C (95°F) with a maximum temperature gradation of 20°C/hour (36°F/hour) Operating above 35°C could result in data loss
Storage	–40° to 65°C (–40° to 149°F) at a maximum altitude of 12,000 m (39,370 ft)

Relative humidity

Operating	10% to 80% (noncondensing) with 29°C (84.2°F) maximum dew point
Storage	5% to 95% (noncondensing) with 33°C (91°F) maximum dew point

Maximum vibration

Operating	0.21 G at 5–500 Hz for 15 min
Storage	1.04 G at 2–200 Hz for 15 min

Maximum shock

Operating	31 G +/- 5% with pulse duration of 2.6 ms +/- 10% (equivalent to 20 in./sec [51 cm/sec])
Storage	71 G +/- 5% with pulse duration of 2 ms +/- 10% (equivalent to 35 in./sec [89 cm/sec])

Altitude

Operating	3,048 m (10,000 ft) ≤35°C (95°F) Maximum Rating – Maximum temperature is reduced by 1°C/300 m (1°F/547 ft) above 950 m (3,117 ft)
Storage	12,000 m (39,370 ft)

Airborne Contaminant Level

Class	G1 or lower as defined by ISA-S71.04-1985
-------	---

