

# IMPORTANT SAFEGUARDS

- Use this appliance only as described in this instruction manual.

As with all electrical equipment, whilst the instructions aim to cover as many eventualities as possible, caution and common sense should be applied when operating and installing this appliance.

- This appliance is designed for home air conditioning and must not be used for other purposes.
- It is dangerous to modify or alter the characteristics of the appliance in any way.
- The appliance must be installed in conformity with national legislation regulating electrical equipment and installations.
- If the appliance requires repair, contact a Service Centre authorised by the manufacturer only.  
Repairs carried out by unauthorised personnel may be dangerous.
- This appliance must be used exclusively by adults.

The appliance is not intended for use by persons (including children) with reduced physical, sensory or mental capabilities, or lack of experience and knowledge, unless they have been given supervision or instruction concerning use of the appliance by a person responsible for their safety.

Children should be supervised to ensure that they do not play with the appliance.

- The appliance must be connected to an efficient earth system.  
Have your electrical circuit checked by a qualified electrician.
- Do not use extension cables.
- Before cleaning or maintenance, always unplug the appliance from the mains socket.
- Never unplug the appliance by pulling on the power cable.
- Do not install the appliance in rooms containing gas, oil or sulphur. Do not install near sources of heat. .
- Keep the appliance at least 50 cm away from flammable substances (alcohol etc) or pressurised containers (eg aerosol cans).
- Do not rest heavy or hot objects on top of the appliance.

- Clean the air filter at least once a week.
- Avoid using heating appliances near the air conditioner.
- Always transport the appliance upright or resting on one side.

Before moving the appliance, empty the internal circuit completely of water.

After moving the appliance, wait at least 1 hour before starting it

- When putting the appliance away, do not cover with plastic bags.
- The materials used for packaging can be recycled.

You are therefore recommended to dispose of them in special differentiated waste collection containers.

- At the end of its working life, consign the appliance to a specialist collection centre.
- If the power cable is damaged, it must be replaced by the manufacturer or an authorised technical service centre in order to avoid all risk.

*Check the type of refrigerant gas used by your appliance on the rating plate.*

## **Specific warnings for appliances with R410A refrigerant gas**

R410A refrigerant gas conforms to EC regulations on the environment.

Avoid perforating the refrigerant circuit of the appliance.

### **ENVIRONMENTAL INFORMATION:**

This unit contains fluorinated greenhouse gases covered by the Kyoto Protocol.

Maintenance and disposal must be carried out by qualified personnel only (R410A, GWP=1975).

## **Specific warnings for appliances with R290 refrigerant gas**

- Read the warnings carefully.
- When defrosting or cleaning, use only the implements recommended by the manufacturer.
- The appliance must be placed in a room without continuously operating sources of ignition (for example: open flames, an operating gas appliance or an operating electric heater).
- Do not pierce or burn.

- Refrigerant gas may be odourless.
- The appliance must be installed, used and stored in a room with a surface area greater than 15 m<sup>2</sup>.
- This appliance contains about 300 g of R290 refrigerant gas.
- R290 refrigerant gas complies with European environmental directives.  
Do not perforate any of the components in the refrigerant circuit.
- If the appliance is installed, used or stored in an unventilated room, the room must be such as to prevent stagnation of possible leaks of refrigerant gas as there could be a danger of fire or explosion hazard should the refrigerant come into contact with electric heaters, stoves or other sources of ignition.
- The appliance must be stored in such a way as to prevent mechanical faults.
- Persons working on a refrigerant circuit must have the relative authorisation issued by an accredited body certifying their competence to handle refrigerants in compliance with a standard assessment recognised by sector associations.
- All repairs must be carried out in accordance with the manufacturer's recommendations. Maintenance and repairs requiring the assistance of other qualified personnel must be carried out under the supervision of specialists in the use of inflammable refrigerants.

**Important information for correct disposal of the product in accordance with EC Directive 2002/96/EC.**



At the end of its working life, the product must not be disposed of as urban waste.

It must be taken to a special local authority differentiated waste collection centre or to a dealer providing this service.

Disposing of a household appliance separately avoids possible negative consequences for the environment and health deriving from inappropriate disposal and enables the constituent materials to be recovered to obtain significant savings in energy and resources. As a reminder of the need to dispose of household appliances separately, the product is marked with a crossed-out wheeled dustbin.

## **ELECTRICAL CONNECTIONS**

Before plugging the appliance into the mains socket, check that:

- the mains power supply corresponds to the value indicated on the rating plate on the back of the appliance;
  - the power socket and electrical circuit are adequate for the appliance.
  - the mains socket matches the plug. If this is not the case, have the plug replaced;
  - the mains socket is adequately earthed.
- Failure to follow these important safety instructions absolves the manufacturer of all liability.

## **WHAT IS THE WATER-AIR PINGUINO**

During the summer, you feel comfortable at a temperature of between 24 and 27° C with a relative humidity of about 50%.

An air conditioner removes excess moisture and heat from the room where it is located.

Compared with wall mounted models, portable air conditioners have the advantage that they can be moved from one room to another in the home or be transported from one building to another. Hot air from the room is passed through a coil cooled by refrigerant gas. Excess heat and moisture are removed before the air is re-emitted into the room.

In single unit models, a small part of this air is used to cool the refrigerant gas and then, when hot and damp, is discharged outside.

In exclusive De'longhi water-air models, the heat is removed from the room through the cooling effect of the water which is obviously much greater than air.

This gives this air conditioner unbeatable cooling efficiency.

## DESCRIPTION

- A** Air outlet grille
- B** Control panel with advanced LCD display
- C** Handle
- D** Grille
- E** Castors
- F** Air intake grille with dust filter
- G** Condensate drain connector
- H** Power cable
- I** Pull out tank
- J** Tank door
- K** Air exhaust hose
- L** Remote control
- M** Air exhaust hose housing
- N** Window outlet
- O** Silver ion filter (certain models only)
- P** Electrostatic filter (certain models only)
- Q** Sucker
- R** Castor locks
- S** Flange with cap
- T** Adjustable bar
- U** Water drain hose + cap
- V** Indicator paper

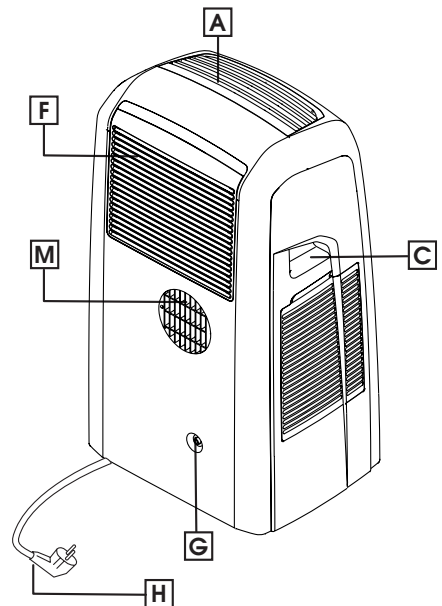
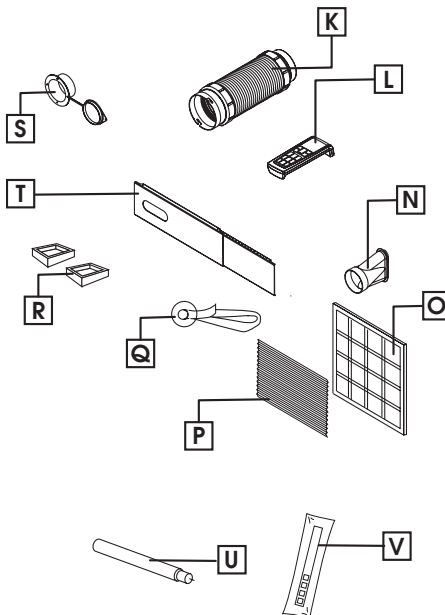
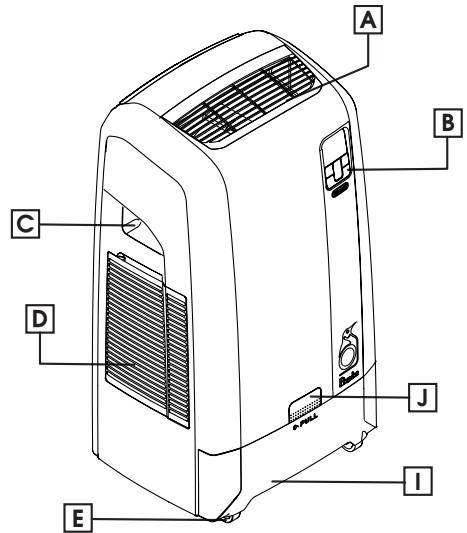

## PREPARING FOR USE

The instructions below will enable you to prepare your air conditioner for operation as efficiently as possible.

Before use, make sure the air intake and outlet grilles are unobstructed.

### Air-conditioning without installation

Just a few simple steps and your comfort is ensured with your appliance:

- Fit the air exhaust hose in the housing at the back of the appliance (fig. 1).

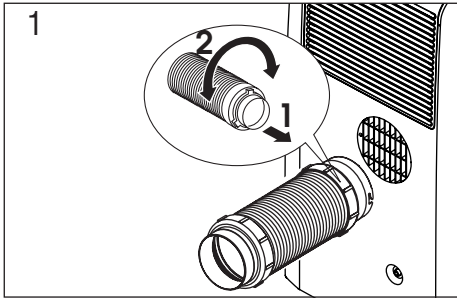

- Fit the window outlet (N) to the end of the hose (K).
- Place the air conditioner near a window or French window.
- Adjust the length of the hose to reach the window.
- Make sure the air exhaust hose is unobstructed.
- Open the window or French window slightly and position the outlet (fig. 2).

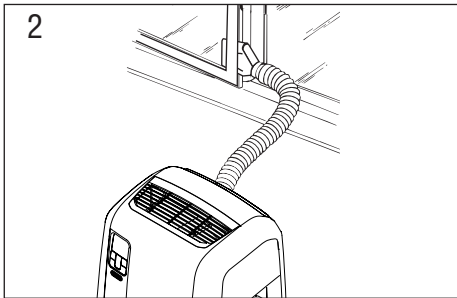

- If you have a double window, use the sucker (Q) provided to hold the two parts of the window together (fig. 3).

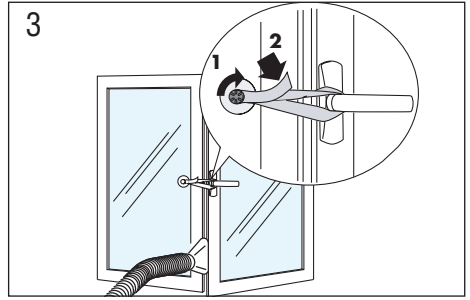

You can also use the “adjustable bar” accessory (T).

- Fit the window outlet in the housing in the bar (fig. 4)

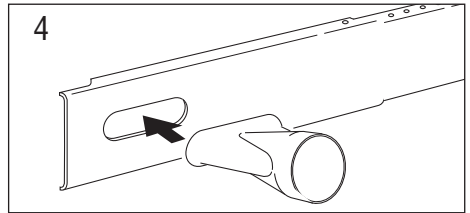

- Position the bar on the window sill and adjust until it fits in the guides of the blind (the length can be blocked with the pin provided), then lower the blind (fig. 5).

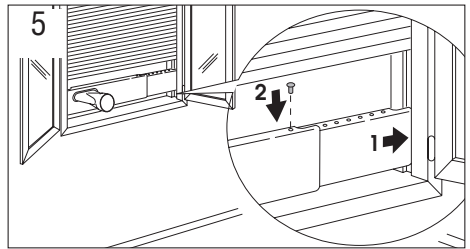

- Fit the air hose to the end of the window outlet.
- Place the air conditioner near a window or French window and connect the end of the hose (fig. 7).
- Remove the cap at the back of the appliance (G) and replace with the drain hose plus cap (U) as shown in figure 6.

This enables the condensate to be drained more easily at the end of the season.

See the section: “END OF SEASON OPERATIONS”.

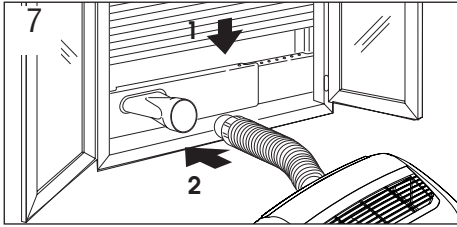
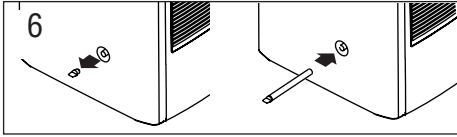

**i** Keep the air hose as short and free of curves as possible to avoid bottlenecks.

### Air-conditioning with installation

If required, your appliance can be installed semi-permanently (Fig. 8).

Proceed as follows:

- Drill a 134 mm dia. hole in an outside wall or through a window pane, respecting the heights shown in fig. 9.

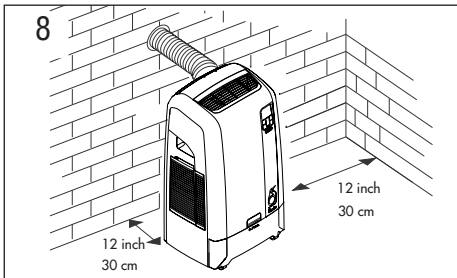

- Fit the flange accessory (S) provided in the hole following the indications in figs. 10, 11 and 12.

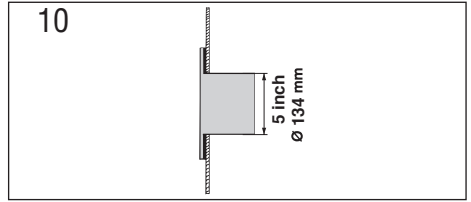
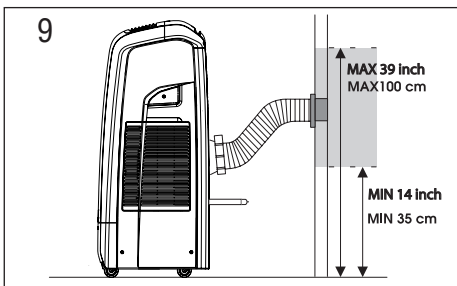

in the window pane

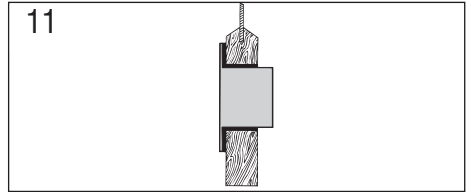

in the wooden kickboard of a French window

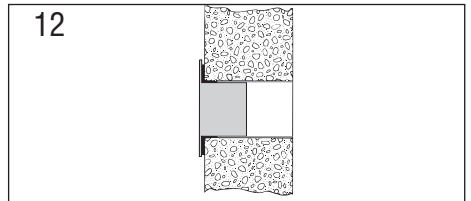

in the wall: you are recommended to insulate the section of wall using suitable insulation.

- Fit the air exhaust hose (K) in the housing at the back of the appliance (fig. 1).
- Fit the end of the hose to the flange (S). When the hose is not fitted, the hole can be closed with the flange cap.
- Remove the cap at the back of the appliance (G) and replace with the drain hose plus cap (U) as shown in figure 6. This enables the condensate to be drained more easily at the end of the season. See the section: "END OF SEASON OPERATIONS".

**i** Keep the air hose as short and free of curves as possible to avoid bottlenecks.

**i** When installing the air conditioner semi-permanently, you should leave a door slightly open, as little as 1 cm, to guarantee correct ventilation.

## PREPARING FOR OPERATION IN WATER MODE

Once the appliance has been installed, it is ready for use.

However, its efficiency can be enhanced by operating it in the exclusive De'longhi water mode.

The water in the tank increases the cooling power of your Pinguino and at the same time reduces noise levels and electrical consumption.

Compared to air, water reduces the temperature of the cooling circuit much more efficiently, before being given off from the air exhaust hose in the form of vapour.

Remember that:

- You must always use salt-free clean mains water.
- The length of time the water in the tank lasts depends greatly on environmental conditions such as temperature, humidity, insulation, the exposure of the room, the number of people present, etc.

Indicatively it lasts about six hours.

The BOOST function (see page 30) shortens the operating time to about 4 hours, but the cooling power and efficiency are increased.

- When the water in the tank runs out, the light  comes on and operation of the appliance switches automatically to air-air. At the same time, the quantity of air given out from the rear hose increases.

 **The appliance is fitted with a resin limescale filter enabling normal tap water to be used.**

**The impregnated resins reduce water hardness and therefore prolong the working life of the appliance.**



 **“CF” is displayed when the limescale filter needs replacing. The efficacy of the filter depends on water hardness. It should, however, be replaced every five years.**

### Setting water hardness

Measure water hardness using the indicator paper provided.

- Remove the indicator paper from its pack (V).

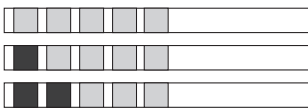
- Immerse the paper completely in a glass of water for one second.
- Remove the paper from the water and shake lightly. After about a minute, 1, 2, 3, 4 or 5 red squares appear, depending on the hardness of the water. The appliance can be set to three different water hardness levels soft (H1), medium (H2) and hard (H3). Determine the hardness of the water you will be using by comparing the red squares on the indicator paper with the table below.

Kind of water used	Levels
<b>0 - 19°F soft</b> 	<b>H1</b>
<b>20 - 36 °F Medium</b> 	<b>H2</b>
<b>&gt; 36 °F Hard</b> 	<b>H3</b>

To set water hardness, proceed as follows:

1. Set the appliance to stand-by.
2. Hold the **FAN** button on the control panel down for 10 seconds. The appliance emits a beep and **H1, H2 or H3** is displayed.
3. Use the + or - buttons to set the hardness level according to the table below. Wait a few seconds for the setting to be memorised. The appliance emits another beep and goes back to stand-by.

 **The machine is set by default for medium hardness (H2).**

### Filling the tank

The water tank is located at the bottom of the appliance. Remove the tank by inserting the hand through the door above the word “PULL” (fig. 13) and pulling the tank out as far as it will go. Remove the cap and use a container (bottle, jug, watering can) to pour in the water (fig. 14/15). You can see when the tank is full through the fil-

ling hole. It holds a maximum of 10 litres.

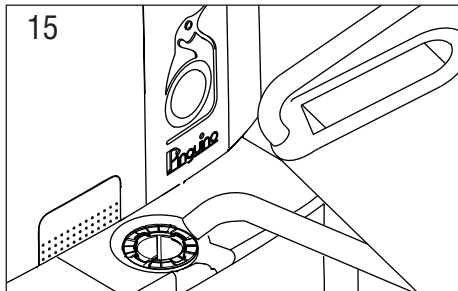
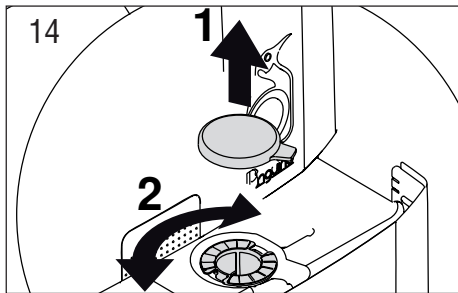
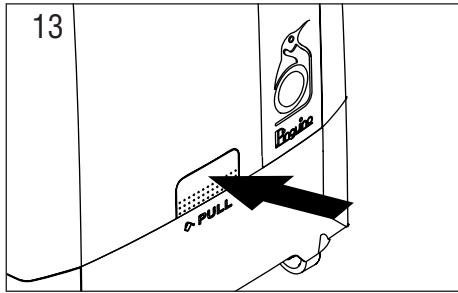

Replace the cap correctly and close the tank, pushing it in as far as it will go. The tank hole has a mesh filter to prevent the introduction of foreign matter. If necessary, this filter can be unscrewed and removed for cleaning under running water.

- The tank does not have to be full to use the water function, but the length of time the appliance will operate in water mode will be shorter.
- Do not fill above the level of the hole to avoid the water overflowing. The tank has no overflow prevention system.

## Replacing the limescale filter

Turn the appliance off and unplug from the mains.

Make sure there is no water in the appliance by emptying the tank and internal tray as described in the section: "End of season operations".

Lay the appliance on its back as shown in figure 17. Rest it on a towel or piece of cardboard to avoid scratches or damage. Remove the filter cover by unscrewing the four screws (fig. 17).

Remove the filter delicately and loosen the two ties, making sure the two hoses connecting the filter do not slip inside the appliance. Fit the new filter, following the same procedure in reverse (fig. 16/15). The pawl on the filter (see figure) indicates the correct direction. The pawl must always be towards the inside of the appliance and point "A" must be facing upwards.

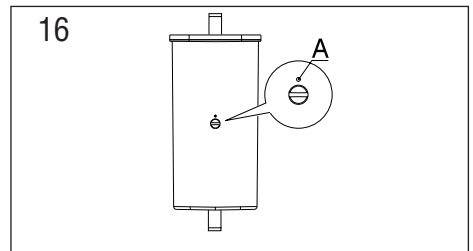

**i** Water may leak out while replacing the limescale filter. You should therefore perform the operation in a suitable location.

**i** After replacing the filter, wait at least an hour before starting the machine again.

**i** When the filter has been replaced, turn the alarm off by pressing the ON/STAND-BY button (15) for 10 seconds. The appliance emits a beep.

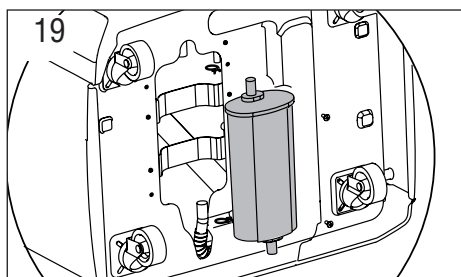
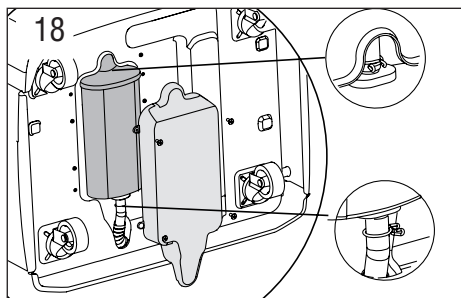
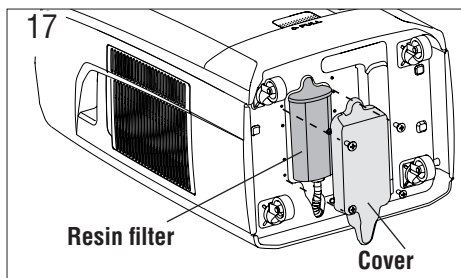

## DESCRIPTION OF THE CONTROL PANEL WITH ADVANCED LCD DISPLAY

- 1 Air conditioning symbol
- 2 Dehumidifying symbol
- 3 Fan symbol
- 4 SMART symbol
- 5 BOOST symbol
- 6 SLEEP symbol
- 7 Alarm symbol
- 8 Temperature indicator
- 9 "No water" symbol
- 10 Timer symbol
- 11 Speed indicator
- 12 AUTOFAN indicator
- 13 FAN button
- 14 Increase (+) and decrease (-) temperature

button

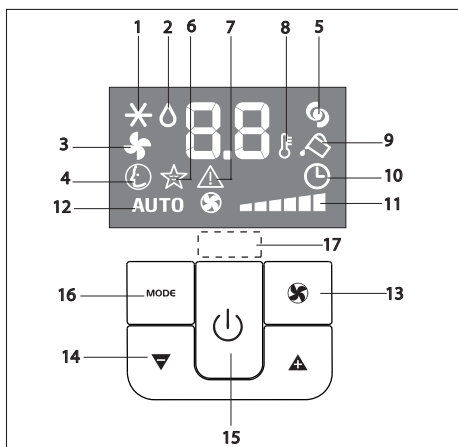

- 15 ON/Standby button
- 16 MODE button (selects the modes)
- 17 Signal receiver



## OPERATING FROM THE CONTROL PANEL

The control panel enables you to manage all the main functions of the appliance. To fully exploit its potential, you must use the remote control unit.

### Turning the appliance on

- Plug into the mains socket.  
Two lines appear on the display indicating that the appliance is in standby (fig. 20).
- Press the  button until the appliance comes on. The last function active when it was turned off will appear.
- Never turn the air conditioner off by unplugging from the mains. Always press the  button, then wait for a few minutes before unplugging. This allows the appliance to perform a cycle of checks to verify operation.

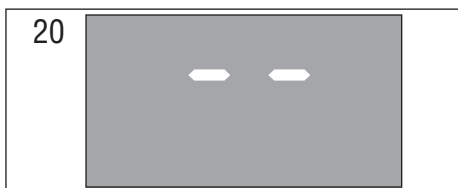





## **Air conditioning mode (fig. 21)**

Ideal for hot muggy weather when you need to cool and dehumidify the room.

To set this mode correctly:

- Press the **MODE** button a number of times until the air-conditioning symbol appears.
- Select the target temperature by pressing the  or  button until the corresponding value is displayed.
- Select the required fan speed by pressing the  button.

Four speeds are available:

 **Maximum speed:** to achieve the target temperature as rapidly as possible

 **Medium speed:** reduces noise levels but still maintains a good level of comfort

 **Low speed:** for silent operation

**AUTO**  **AUTOFAN:** the appliance automatically selects the most suitable fan speed in relation to the temperature set on the digital display.

*The most suitable temperature for the room during the summer varies from 24 to 27°C.*

*You are recommended, however, not to set a temperature much below the outdoor temperature.*

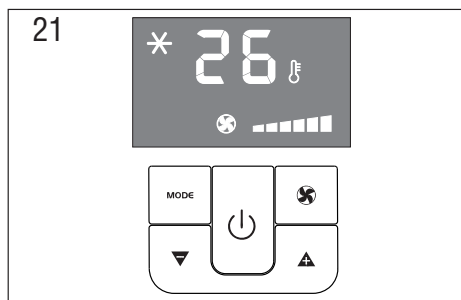

## **Dehumidifying mode (fig. 22)**

Ideal to reduce room humidity (spring and autumn, damp rooms, rainy periods, etc).

In dehumidifying mode, the appliance should be prepared in the same way as for air conditioning, with the air exhaust hose attached to enable the moisture to be discharged outside.

To set this mode correctly:

- Press the **MODE** button a number of times until the dehumidifying symbol appears.

 *In this mode, fan speed is selected automatically by the appliance and cannot be set manually.*

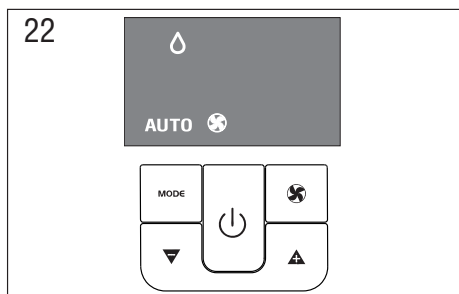

## **Fan mode (fig. 23)**

When using the appliance in this mode, the air hose does not need to be attached.

To set this mode correctly:

- Press the **MODE** button a number of times until the fan symbol appears.
- Select the required fan speed by pressing the  button.

Three speeds are available:

 **High speed:** for maximum fan power

 **Medium speed:** reduces noise levels but still maintains a good level of comfort.

 **Minimum speed:** for silent operation

*In this mode, AUTO speed cannot be selected.*

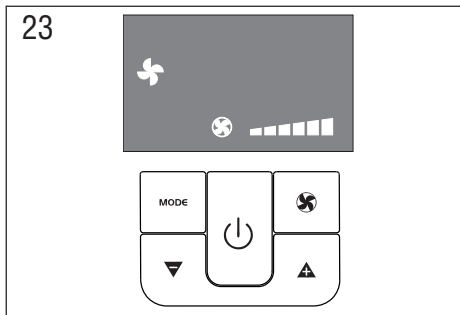

### **Modalità SMART (fig. 24)**

SMART mode tries to recreate ideal comfort conditions in the room. The appliance automatically establishes whether to operate in air conditioning, fan or stand-by mode depending on the environmental conditions detected.

To set this mode:

- Press the **MODE** button a number of times until the **SMART** symbol appears.
- Choose the required fan speed.

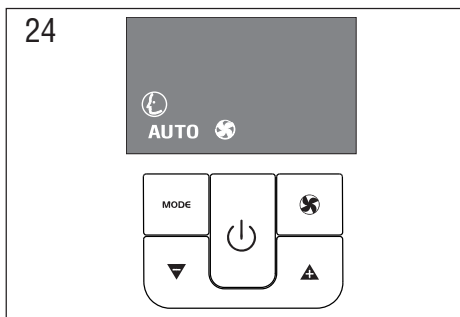

### **DESCRIPTION OF THE REMOTE CONTROL**

- 1 Air conditioning symbol
- 2 Dehumidifying symbol
- 3 Fan symbol
- 4 SMART symbol
- 5 Selected temperature scale indicator
- 6 Signal transmission
- 7 BOOST symbol
- 8 SLEEP symbol
- 9 AUTOFAN indicator
- 10 Fan speed indicator

- 11 TIMER ON symbol
- 12 Timer OFF symbol
- 13 Clock
- 14 ON/Standby button
- 15 FAN button
- 16 Increase (+) and decrease (-) temperature button
- 17 MODE button (selects the modes)
- 18 Reset button (resets the appliance to the original settings)
- 19 OK button
- 20 Timer OFF button
- 21 °C or °F selection button
- 22 SLEEP button
- 23 BOOST button
- 24 Timer ON button

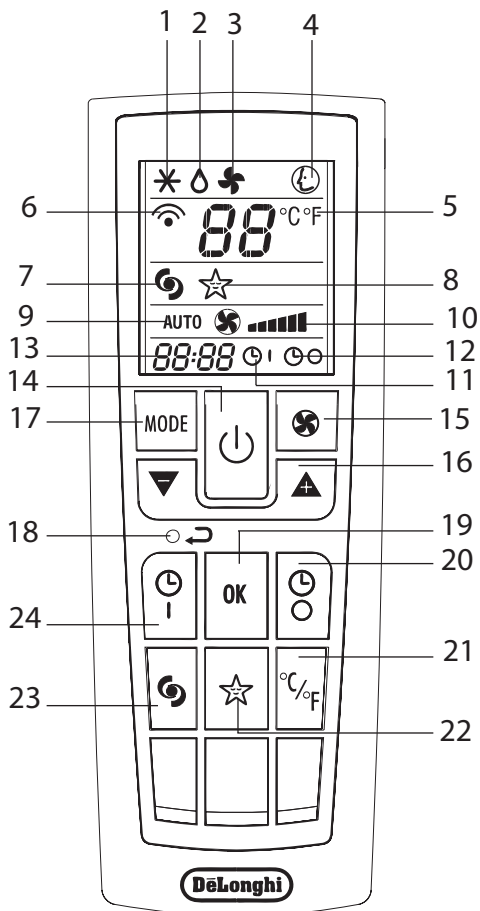

## USING THE REMOTE CONTROL

- Point the remote control at the receiver on the appliance. The remote control must be no more than 7 metres away from the appliance (without obstacles between the remote control and the receiver).
- The remote control must be handled with extreme care. Do not drop it or expose it to direct sunlight or sources of heat.

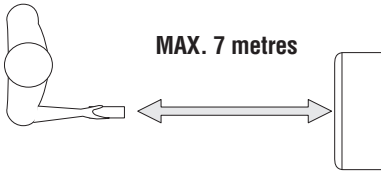

## Inserting or replacing the batteries

- Remove the cover on the rear of the remote control (fig. 25);
- Insert two R03 “AAA” 1.5V batteries in the correct position (see instructions inside the battery compartment);
- Replace the cover.

**i** If the remote control unit is replaced or disposed of, the batteries must be removed and discarded in accordance with current legislation as they are harmful to the environment.

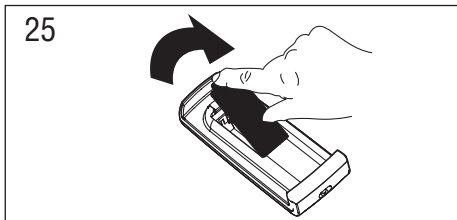

## Setting the time

After having inserted the batteries, the clock on the display flashes until the time is set. Proceed as follows.

- Press the ▲ or ▼ button until the correct time is reached.  
Hold the button down to run rapidly through first the minutes, then the tens of minutes.
- Once the correct time has been reached, re-

lease the button and press the **OK** button to confirm.

- To cancel the settings programmed on the remote control and restore the original settings, press the  button lightly with the point of a pencil or pen.

## USING THE REMOTE CONTROL UNIT

The first part of the controls on the remote control are the same as those on the control panel of the appliance (fig. 26).

You should therefore refer to the instructions in the chapter OPERATING FROM THE CONTROL PANEL to

- turn the appliance on or off and
- select the operating mode (air conditioning, dehumidifying, fan or Smart) and the fan speed.
- set the required temperature.

The following section describes the additional functions corresponding to the controls on the bottom part of the remote control.

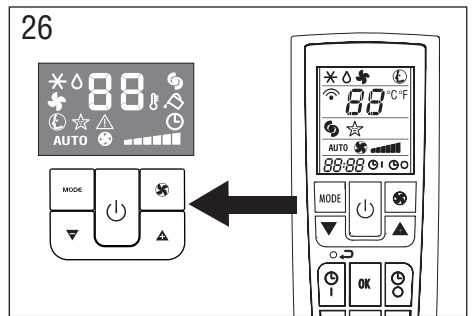



### BOOST function (fig. 27)

Ideal for the summer to cool rooms rapidly. Activate by simply pressing the  button. The appliance operates in air conditioning mode at maximum fan speed and maximum power. While this function is selected, it is not possible to set the temperature or change fan speed.

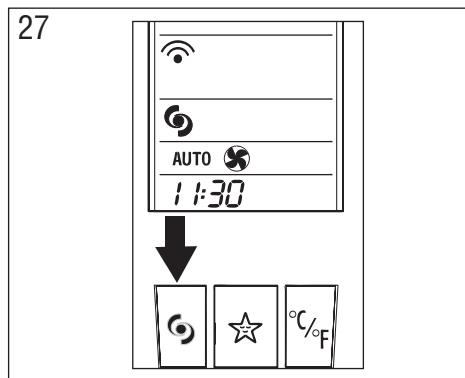

**i** When the BOOST function is active, the water lasts less time than in air conditioning mode. On the other hand, the cooling power and efficiency of the appliance are higher.

### Selecting the temperature scale (fig. 28)

Press the  button to switch the temperature display from °C to °F and vice versa.

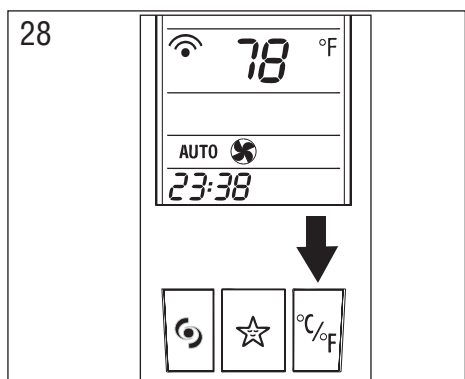

### Sleep function (fig. 29)

This function is useful for the night as it gradually reduces operation of the appliance, turning it off after 8 hours.

To set this function correctly:

- Select the operating mode (air conditioning, dehumidifying, smart) as described above.
- Press the  button.

The appliance operates in the previously selected mode with the lowest possible fan speed.

Fan speed is always at minimum, while room temperature and humidity vary gradually to ensure the most comfortable conditions.

During air conditioning, the temperature increases by 1°C after 60 minutes and a further 1°C after 2 hours.



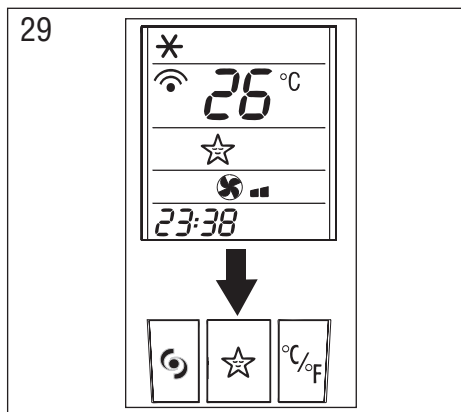



In dehumidifying mode, the dehumidifying power of the appliance is partially reduced every hour for the first two hours.









## PROGRAMMING THE TIMER

The timer can be programmed to start and stop the appliance when required.



### Programming start up

- Press the  button.  
The start-up time and symbol  flash on the remote control display (fig. 30).
- Press the  or  buttons to set the time you want the appliance to start up.
- When that time is reached, press the OK button to confirm (fig. 31). The symbol  remains displayed on the remote control and the  symbol is displayed on the appliance to indicate that the timer is active.

### Programming shutdown

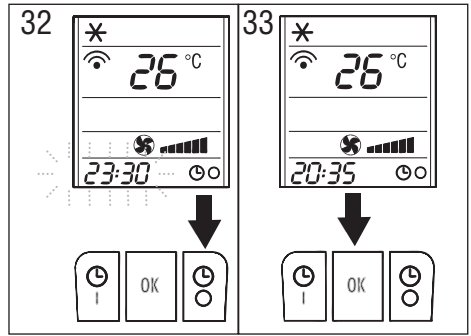
- Press the  OFF button. The shutdown time and symbol  flash on the remote control display (fig. 32).
- Press the  or  buttons to set the time you want the appliance to shut down.
- When that time is reached, press the OK button to confirm (fig. 33). The symbol  remains displayed on the remote control and the  symbol is displayed on the appliance to indicate that the timer is active.





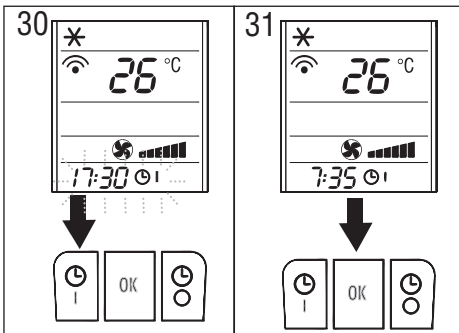

If you need to disable the timer on or off programme in advance, press the  or  button respectively twice.



## SELF-DIAGNOSIS

The appliance has a self diagnosis system to identify a number of malfunctions.  
Error messages are displayed on the appliance display.

IF ... IS DISPLAYED,	...WHAT SHOULD I DO?
 <p><b>Low Temperature</b> (frost prevention)</p>	<p>The appliance is fitted with a frost protection device to avoid excessive formation of ice. The appliance starts up again automatically when the defrosting process is completed.</p>
 <p><b>High Level</b> (internal tray full)</p>	<p>Empty the internal safety tank following the instructions in the section "End of season operations". If it reoccurs, contact your local authorised customer services.</p>
 <p><b>Change filter</b></p>	<p>When this message is displayed, the water filter needs replacing as described in the section: "Replacing the limescale filter".</p>

IF ... IS DISPLAYED,	...WHAT SHOULD I DO?
 <p><b>Probe Failure</b> (sensor damaged)</p>	<p>If this is displayed, contact your local authorised service centre.</p>
 <p><b>Failure1</b></p>	<p>When the F1 alarm is active, the appliance continues functioning normally in air-air mode. To reset the alarm, unplug the appliance then plug in again. If the alarm reoccurs frequently, contact customer services.</p>

## TIPS FOR CORRECT USE

To get the best from your air conditioner, follow these recommendations:

- close the windows and doors in the room to be air conditioned (fig. 34).

When installing the air conditioner semi-permanently, you should leave a door slightly open (as little as 1 cm) to guarantee correct ventilation.

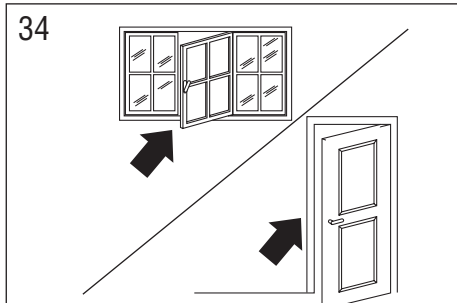

close doors and windows

- Protect the room from direct exposure to the sun by partially closing curtains and/or blinds to make the appliance much more economical to run (fig. 35);

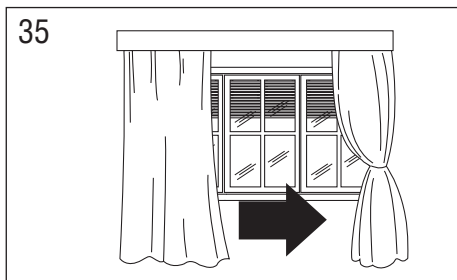

close curtains

- never rest objects of any kind on the air conditioner;
- do not obstruct the air intake and outlet (fig. 36). Leave both grilles free;
- make sure there are no heat sources in the room;
- never use the appliance in very damp rooms (laundries for example);
- never use the appliance outdoors;

36

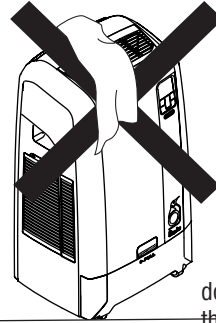

do not cover  
the appliance

- make sure the air conditioner is standing on a level surface.  
If necessary, place the castor locks under the front wheels.

## AIR PURIFYING FILTERS

This appliance is fitted with two dust filters to maintain efficiency.

One is at the back near the intake grille, the other is at the side (fig. 37-38).

37

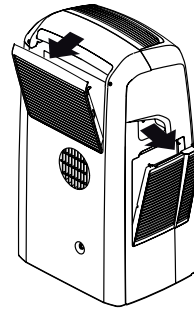

38

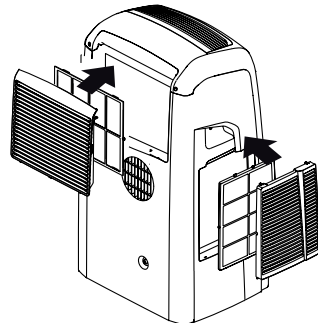

Certain models have a silver ion dust filter and an additional electrostatic filter in the grill at the back

### Silver ion filter

This dust filter is treated with silver ions which not just retain dust particles, but also have an efficient antibacterial action. It also greatly reduces concentrations of irritants such as pollen and spores.

### Electrostatic filter

The electrostatic filter retains the finest dust particles, thus enhancing the filtering capacity of the appliance.

### Fitting the filters to the grille

The appliance can be used with just the dust filters already inserted in the grille.

To use the two supplementary filters (if provided with your model), remove them from the packaging and attach them to the dust filter, inserting them under the special clips (fig. 39).

If you decide not to use it, keep it sealed in the packaging.

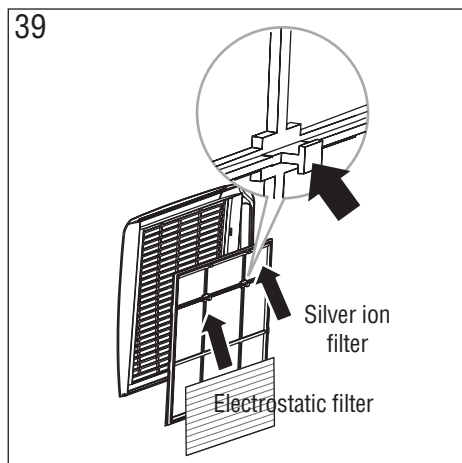

## CLEANING

Before cleaning or maintenance, turn the appliance off by pressing the  button on the control panel or remote control, wait for a few seconds then unplug from the mains socket.

### Cleaning the cabinet

You should clean the appliance with a slightly damp cloth then dry with a dry cloth.

- Do not wash the air conditioner with water. It could be dangerous.
- Do not use petrol, alcohol or solvents to clean the appliance.  
Do not spray insecticide liquids or similar.

### Cleaning the air filters

To keep your air conditioner working efficiently, you should clean the dust filters every week of operation.

### Cleaning the dust filters supplied with all models

Each filter is housed in the intake grille.

To clean the filters, proceed as follows

- Remove the intake grille by pulling it outwards (fig. 37).
- Remove the dust filter by detaching it from the grille (Fig. 38).
- Use a vacuum cleaner to remove the dust collected on the filter.

If it is very dirty, immerse in warm water and rinse a number of times.

- After washing, leave the filter to dry completely.
- To replace, put the filters back in the intake grille then attach the intake grille to the appliance.



## Cleaning of the silver ion filter and of the electrostatic filter (certain models only)

To clean the silver ion dust filter, the electrostatic filter must be temporarily removed.

To clean the filters, use a vacuum cleaner at medium power.

The silver ion filter can be washed with lukewarm water. Leave to dry completely and replace.

The electrostatic filter is not washable but it should be replaced at least once every two seasons.

The electrostatic filter can be bought from shops selling De'longhi accessories or authorised service centres.

## START OF SEASON OPERATIONS

Make sure the power cable and plug are undamaged and the earth system is efficient. Follow the installation instructions precisely.

## END OF SEASON OPERATIONS

Before putting the appliance away or moving it to another location, empty any water left in the tanks.

### Emptying the tank

Pull out the tank as described in the section: "FILLING THE TANK". Unhook the drain hose on the left of the tank (fig. 40-41) and place the end in a recipient. Remove the cap and drain off the water left in the tank.

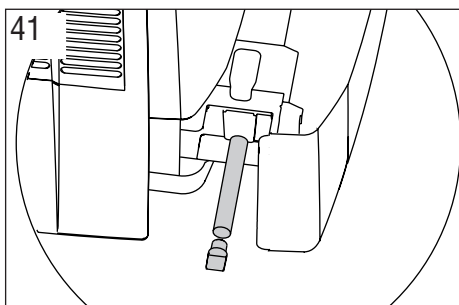
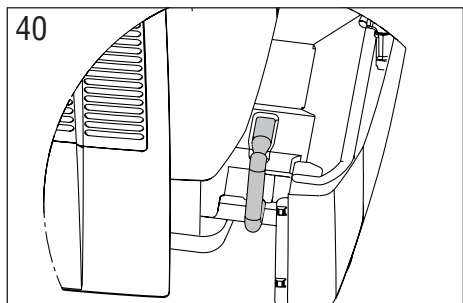

### Emptying the internal tank

To facilitate this operation, at the start of the season, replace the spout cap (G) with the drain hose + cap (U).

Place a recipient (such as a jug or bottle) near the spout on the back of the appliance (fig. 40). Remove the cap and run off any water left.

When completely empty, replace the cap.

**IMPORTANT:** the tank could contain as much as 2 litres of water.

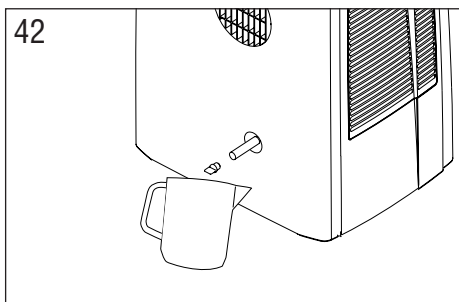

- After performing the 2 operations described above, operate the appliance in fan only mode for about half an hour. This dries any water remaining inside the appliance.
- Turn the appliance off and unplug from the mains.
- Remove the air exhaust hose and condensate drain hose.
- Clean the dust filters.
- Cover the appliance to avoid dust.

## **TECHNICAL CHARACTERISTICS:** \_\_\_\_\_

Power supply voltage      see rating plate

Maximum absorbed power  
in air conditioning      “

Refrigerant      “

Cooling capacity      “

### **Limit conditions**

Room temperature for air conditioning  $21 \pm 35^{\circ}\text{C}$

## **GUARANTEE** \_\_\_\_\_

The terms of the guarantee and technical assistance are given in the documentation accompanying your appliance.

## TROUBLESHOOTING

PROBLEM	CAUSE	SOLUTION
The air conditioner does not come on	<ul style="list-style-type: none"> <li>there is no current</li> <li>it is not plugged into the mains</li> <li>the internal safety device has tripped</li> </ul>	<ul style="list-style-type: none"> <li>wait</li> <li>plug into the mains</li> <li>call the Service Centre</li> </ul>
The air conditioner works for a short time only	<ul style="list-style-type: none"> <li>there are bends or kinks in the air exhaust hose</li> <li>something is preventing the air from being discharged</li> </ul>	<ul style="list-style-type: none"> <li>position the air hose correctly, keeping it as short and free of curves as possible to avoid bottlenecks.</li> <li>check and remove any obstacles obstructing air discharge</li> </ul>
The air conditioner works, but does not cool the room	<ul style="list-style-type: none"> <li>windows, doors and/or curtains open</li> <li>there are heat sources in the room (oven, hairdryer, etc)</li> <li>the air exhaust hose is detached from the appliance</li> <li>dust filters clogged</li> <li>the technical specification of the appliance is not adequate for the room in which it is located.</li> </ul>	<ul style="list-style-type: none"> <li>close doors, windows and curtains, bearing in mind the "TIPS FOR CORRECT USE" given above</li> <li>eliminate the heat sources</li> <li>fit the air exhaust hose in the housing at the back of the appliance (fig. 1).</li> <li>clean or replace the filters as described above</li> </ul>
During operation, there is an unpleasant smell in the room	<ul style="list-style-type: none"> <li>dust filter and (when present) electrostatic filter clogged</li> </ul>	<ul style="list-style-type: none"> <li>clean the filters as described above</li> </ul>
The air conditioner does not operate for about three minutes after restarting it	<ul style="list-style-type: none"> <li>the internal compressor safety device prevents the appliance from being restarted until three minutes have elapsed since it was last turned off.</li> </ul>	<ul style="list-style-type: none"> <li>wait. This delay is part of normal operation.</li> </ul>
The symbol  and one of the following messages <i>LT / HL / CF / PF / FI</i> appears on the appliance display:	<ul style="list-style-type: none"> <li>The appliance has a self diagnosis system to identify a number of malfunctions.</li> </ul>	<ul style="list-style-type: none"> <li>See the SELF-DIAGNOSIS chapter.</li> </ul>