

A HIGH SEARCHING COLOR DISPLAY MONITOR  
WITH SPECIAL CONTROLS

# Diamond Scan 50/50M

MODEL SD5904C / SD5904CM  
USER'S GUIDE

7D0-10000

1000-10000  
1000-10000

To help you locate the serial  
number of your display monitor, the  
company will  
SERIAL No.   
If you are unable to find the serial  
number of your monitor,

## CAUTION

The power cord provided with this monitor is designed for safety and must be plugged into a properly grounded outlet to avoid possible electrical shock.

Do not remove the safety capset as this can expose you to very high voltages and other hazards.

### ANMERKUNG:

Dieses Monitor soll für die Anforderungen der deutschen Ergonomie-Norm ZH11/510/10-60 bei 70 oder 75 Hz verwendet werden für beiden folgenden Timing:

Auflösung	Videoeingang	Hz(Hz)	Hz(Hz)	Interface	Non-Interlace
640x480	Analog (RGB, 0,7Vrms)	31,5	60,0		Non-Interlaced

Aus ergonomischen Gründen (z. B. bei niedrigem Kontrast) wird empfohlen, die Grundfarbe Blau nicht auf dunklerem Untergrund zu verwenden (schlechte Erkennbarkeit, Augenbelastung bei zu geringem Zeichenkontrast).

Bei hellem Hintergrund empfehlen wir aus ergonomischen Gründen nur Videofrequenzen größer oder gleich 70 Hz zu verwenden.

Zur Trennung vom Netz ist der Netzstecker aus der Steckdose zu ziehen, welche sich in der Nähe des Gerätes befinden muß und leicht zugänglich sein soll.

Das Gerät stellt sich automatisch auf die zutreffende Nennspannung ein.

### Trademark

IBM, PC, PC/2, PS/2, Personal System/2 are registered trademarks of International Business Machines Corp.

Apple Macintosh is a registered trademark of Apple Computer, Inc.

Quadra is a trademark of Apple Computer, Inc.

© 1998 Apple Computer, Inc. Alle Rechte vorbehalten.

### RADIO INTERFERENCE REGULATIONS STATEMENT FOR U.S.A.

This equipment has been tested and found to comply with the limits for a Class B digital device, pursuant to Part 15 of the FCC Rules. These limits are designed to provide reasonable protection against harmful interference in a residential installation. This equipment generates, uses and can radiate radio frequency energy and, if not installed and used in accordance with the instructions, may cause harmful interference to radio communications. However, there is no guarantee that interference will not occur in a particular installation. If this equipment does cause harmful interference to radio or television reception, which can be determined by turning the equipment off and on, the user is encouraged to try to correct the interference by one or more of the following measures:

- Reorient or relocate the receiving antenna.
- Increase the separation between the equipment and receiver.
- Connect the equipment into an outlet on a circuit different from that to which the receiver is connected.
- Consult the dealer or an experienced radio/TV technician for help.

NO USER SERVICEABLE PARTS INSIDE. DO NOT ATTEMPT TO REPAIR THIS EQUIPMENT. IF MODIFIED, YOUR AUTHORITY TO OPERATE THIS EQUIPMENT MIGHT BE VOIDED BY FCC.

### WARNING!

This product is not designed for use in life support devices and Mitsubishi Electric Corporation makes no representations to the contrary. Life support devices are those devices which are used to measure, diagnose, or evaluate the tissue, systems or functions of the human body; or other devices employed to support or sustain life or good health.

### MANUFACTURER DECLARATION FOR CE-MARKING:

We, Mitsubishi Electric Corp., declare under our sole responsibility, that this product is in conformity with the following standards:

EN60950  
EN55022 Class B  
EN50082-1  
EN61000-3-2

following the provisions of:

73/23/EEC Low Voltage Directive  
89/336/EEC EMC Directive

As an Energy Star Partner, Mitsubishi Electric Corporation has determined that this product meets the Energy Star guidelines for energy efficiency.

## CONTENTS

1. INTRODUCTION .....	4
1.1 Features .....	4
1.2 Preset Timing and Internal Preset Memory Capability .....	5
1.3 Power Management Function .....	6
1.4 Location Considerations .....	6
1.5 Cleaning Your Monitor .....	7
1.6 Unpacking .....	7
1.7 Tilt/Swivel Base .....	8
2. CONNECTING THE MONITOR .....	9
2.1 AC Power Connection .....	9
2.2 Signal Cable Connection .....	9
2.2.1 Connecting to Any IBM VGA Compatible System .....	9
2.2.2 Connecting to An Apple Macintosh Series Computer .....	10
2.3 Quick Operation Chart .....	11
3. USER CONTROLS .....	12
3.1 Control Names .....	12
4. FUNCTION CONTROLS .....	13
5. TROUBLESHOOTING .....	18
6. SPECIFICATIONS .....	19
7. APPENDIX .....	20
7.1 Monitor Signal Cable Pin Assignment .....	20
7.2 Connector for Macintosh family of Computer (640 x 480) .....	21

---

Note: This manual is designed for use with Diamond Scan 50/50M color display monitor.

---

# INTRODUCTION

Congratulations on your purchase of Mitsubishi's new 1024M high resolution color monitor. Mitsubishi's new 1024M monitor is a product with years of research and development. We sincerely thank you for your purchase and we welcome to Mitsubishi!

## 1.1 Features

- The 1024M has 1024M and 2048M (from 15.8" Dia.) and Viewable Image
- The 1024M has a professional level monitor chip with over analog RGB (Red, Green, Blue) that has a maximum of 16.7M, and VESA VGA, XGA, SVGA, XGA-2 and Apple Macintosh family. It provides resolution and color graphics with most PC compatible EISA and VESA panel. Monitor third party color video cards and on board video.
- 1024M comes with a 4-speaker (optional)
  - (Optional) 1024M with Speaker
- The wide aperture design is compatible to most monitor types to support video cards of different products of the monitor with the
- The 1024M has a built-in microprocessor, a real-time clock, an internal microprocessor, for a complete system. It has a frequency between 30kHz and 70kHz and vertical scan frequency between 50Hz and 60Hz. The microprocessor based built-in system allows the monitor to recognize and to be compatible with the production of a fixed frequency monitor.
- The 1024M has a built-in memory for pre-programmed screen display standards and a wide range of factory additional user adjustment parameters.
- The 1024M has a 25" contrast, a wide angle, anti-reflexive (AR) coating enhances the crisp images.
- The 1024M has a built-in digital display up to 1024 x 1024 resolution, making it suitable for high resolution work.
- The 1024M has a built-in digital display, it is able to display an unlimited palette of colors (high resolution) and a built-in digital display for needs.
- The 1024M has a built-in digital display (DPM) and Energy Star power consumption. The 1024M has a built-in digital display, it is able to be connected to a system using a built-in digital display (DPM) and Energy Star power consumption.
- The 1024M has a built-in digital display, it is able to be connected to a system using a built-in digital display (DPM) and Energy Star power consumption.
- The 1024M has a built-in digital display, it is able to be connected to a system using a built-in digital display (DPM) and Energy Star power consumption.

## 1.2 Preset Timing and Internal Preset Memory Capability

To minimize the need for adjustment, eight (8) popular display standards, shown below, have been preset into the monitor. If any of these display standards are detected, the picture size, centering and geometry is automatically adjusted. All of the presets may be overwritten by adjusting the user controls (refer to chapter 4). The new display information must differ from any of the existing display standards by at least 2kHz horizontal scan frequency, or 10Hz vertical scan frequency, or the sync signal polarities must be different.

The eight (8) presets are designated as factory presets may be restored by reset mode of adjusting the user controls.

ENGLISH

No	Resolution	Horizontal Fh (kHz)	Vertical Fv (Hz)	Polarity	
				H	V
1	VGA 640dot x 480 line	31.469	59.941	-	-
2	VGA 640dot x 400 line	31.469	70.080	-	+
3	SVGA 800dot x 600 line	45.875	75.000	+	+
4	1024dot x 768 line	60.023	75.029	+	+
5	1024dot x 768 line	56.754	70.413	-	-
6	Macintosh 640dot x 480 line	35.001	66.667	-	-
7	Macintosh 832dot x 624 line	49.717	74.530	-	-
8	640dot x 480 line	37.500	75.000	-	-

### 1.5 Cleaning Your Monitor

When cleaning your monitor, please follow these guidelines:

- Always unplug the monitor before cleaning.
- Wipe the screen and cabinet front and sides with a soft cloth.
- If the screen requires more than dusting, apply a household window cleaner to a soft cloth to clean the monitor screen.

#### **CAUTION**

*Do not use benzene, thinner or any volatile substance to clean the unit as the finish may be permanently marked. Never leave the monitor in contact with rubber or vinyl for an extended period.*

### 1.6 Unpacking

After you unpack your color monitor you should have all of the items indicated in Figure 1 as listed below. Save the original box and packing materials in case you have to ship or transport your monitor.

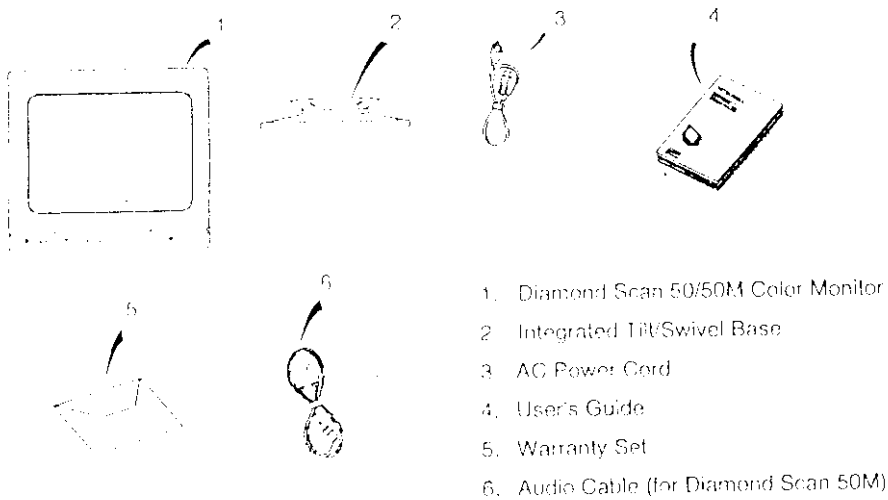

Figure 1.

## 1.7 Tilt/Swivel Base

The monitor comes with a tilt/swivel base. This enables you to position the monitor to the best angle and tilt for maximum viewing comfort.

### Tilt/Swivel base assembly

1. To place the tilt/swivel base, gently lay the monitor on its side or top, and align the tabs on the tops of the base into the grooves in the underside of the monitor.
2. Push the base toward the front of the monitor until it clicks into place in front of the six plastic prongs.

### Screen Position Adjustment

Adjust the tilt and rotation of the monitor by placing your hands at opposite sides of the case, as shown in Figure 2. You can adjust the monitor 90 degrees right or left, 15 degrees up or 5 degrees down, as shown below.

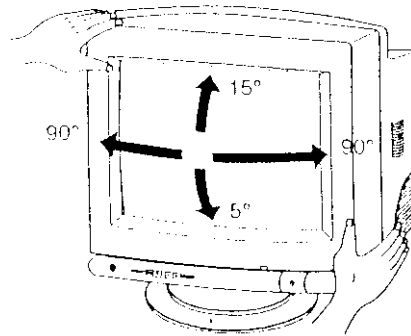
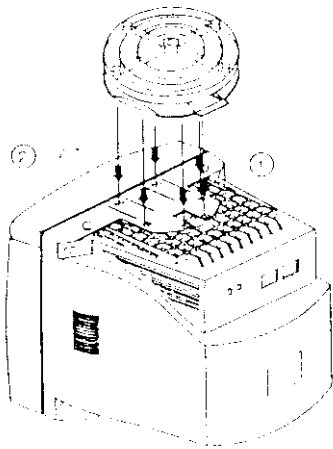

Figure 2.

### CAUTION

*Reorientation of the monitor while its power is on will affect screen color purity. Observation of partial color change is normal as the monitor is being magnetized by the earth's magnetic field. This is a common phenomenon. In this case, just activate the manual degauss function in OSD control, the screen should have good purity.*

*Do not remove the TILT/SWIVEL base from your monitor. Removing the tilt/swivel base causes the internal temperature to rise and monitor will not rest properly or may slide off your desktop.*



# 2

## CONNECTING THE MONITOR

ENGLISH

### 2.1 AC Power Cord Connection

One end of the AC power cord is to be connected to the back of the monitor. The other end is plugged into a properly grounded three-prong AC outlet. The monitor's autosensing power supply can automatically detect 100-120V AC or 200-240V AC and 50 or 60Hz.

### 2.2 Signal Cable Connection

The attached video signal cable provides a mini D-SUB 15P connector for the VGA compatible analog RGB outputs on your PC. The RGB signal may be derived from an IBM® PC/286 or any other Apple Macintosh™ built-in video or most third party color cards can be interfaced by using the Mitsubishi Apple adapter available from your dealer.

#### 2.2.1 Connecting to Any IBM VGA Compatible System

1. Power off both the monitor and the PC.
2. Connect the monitor signal cable to the 15-pin connector on the graphic card (see Figure 3).
3. Power on the PC then the monitor.
4. After using the system, power off the monitor, then the PC.

#### **CAUTION**

The power supply of this monitor remains active even when the power switch is off. Therefore, the power socket should be readily accessible in case of an emergency or to disconnect the monitor completely.

Alors qu'il ne soit éteint, l'alimentation de ce moniteur reste toujours alimentée. La prise secteur devrait être facilement accessible en cas d'urgence ou pour débrancher le moniteur complètement du secteur.

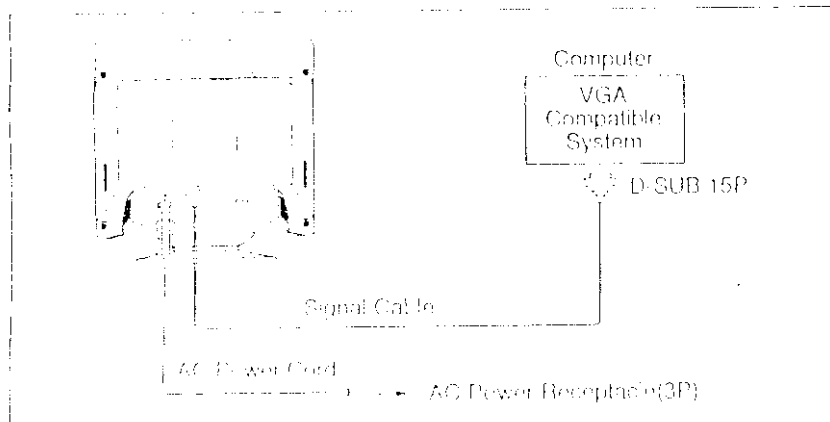

Figure 3.

### 2.2.2 Connecting to An Apple Macintosh Series Computer

Figure 4 shows the connection of the SD 2 connector when using an APPLE Macintosh® computer (in a 640 x 480 application only).

1. Power off the monitor and the Apple Macintosh computer.
2. Connect the 15-pin (DB-15P) of the SD 2 adapter to the straight 15-pin connector on the Macintosh® video port (rear of the CPU) or on the video board.
3. Connect the sub-miniature 15-pin (D SUB 15P) of the connector to the monitor signal cable.
4. Power on the Macintosh then the monitor.
5. After using the system, power off the monitor, then the Macintosh.

**CAUTION**

The power supply of the monitor remains active even when the power switch is off. Therefore, the power socket should be readily accessible in case of an emergency or to disconnect the monitor completely.

Même si le moniteur est débranché, il reste toujours alimenté. La prise secteur devrait ainsi être facilement accessible en cas d'urgence ou pour débrancher le moniteur complètement du secteur.

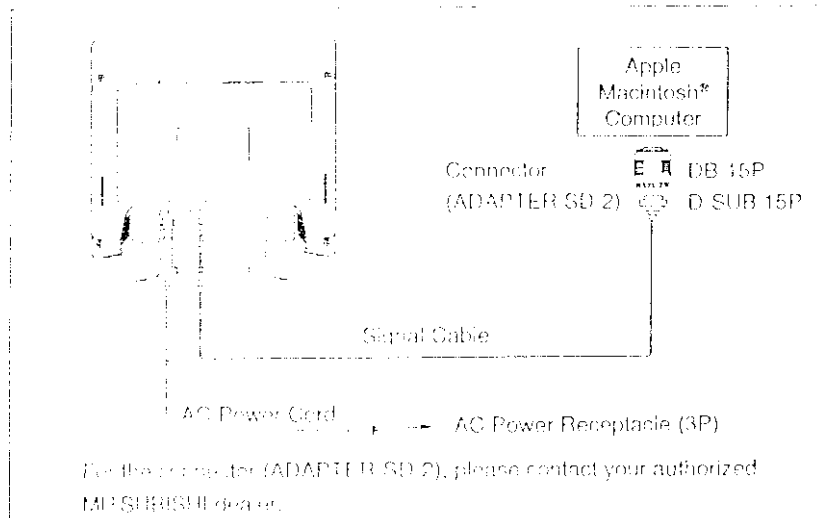

Figure 4.

ENGLISH

### 2.3 Quick Operation Chart

To summarize the steps in connecting your computer and adapter with Diamond Scan 5030M color monitor and setting the necessary controls and switches, refer to the chart below.

Connect the power cord to the color monitor and the signal cable between the monitor and the graphics adapter.

See 2.1 AC Power Connection  
2.2 Signal Cable Connection

Turn on the computer.

Turn on the color monitor.

Set the controls and switches.

See 3. USER CONTROLS  
4. FUNCTION CONTROLS

If a problem appears,

See 5. TROUBLESHOOTING

If the problem persists,

Call your authorized MITSUBISHI Product Support at 1-800-344-6352.

OK

GOOD

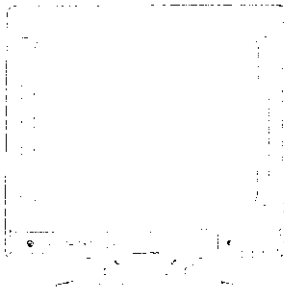

# 3

## USER CONTROLS

See Figure 5 for the location of the following user controls and indicators. Each control is identified by number and is described individually.

**FRONT**

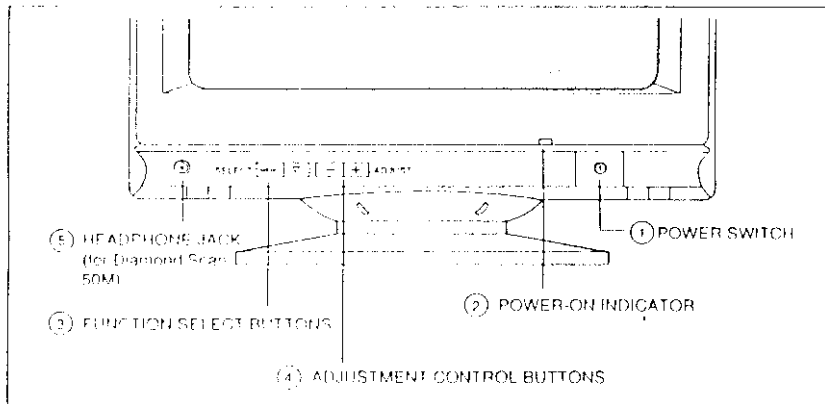
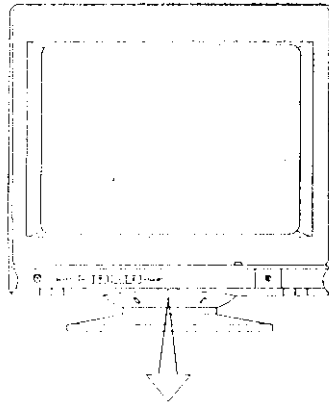

Figure 5

### 3.1 Control Names

- ① **POWER SWITCH:** A push-on / push-off switch for AC power
- ② **POWER-ON INDICATOR:** This indicator illuminates when AC power is on.
- ③ **FUNCTION SELECT BUTTONS:** Push the menu (**[MENU]**) or down (**[↓]**) buttons and select the adjustment item for the desired adjustment.
- ④ **ADJUSTMENT CONTROL BUTTONS:** Push the increase (**[↑]**) or decrease (**[↓]**) buttons for the desired adjustment. All adjustments are memorised automatically when OSD menu is off.
- ⑤ **HEADPHONE JACK (for Diamond Scan 50M)**

# 4

## FUNCTION CONTROLS

Refer to Figure 5 for the location of monitor function controls and see the indicators superimposed on display screen.

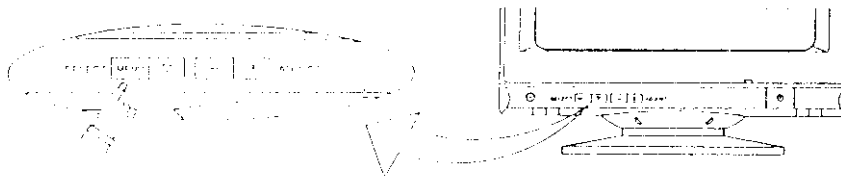

Press the (M) button to activate the control functions in the main menu as stated below.

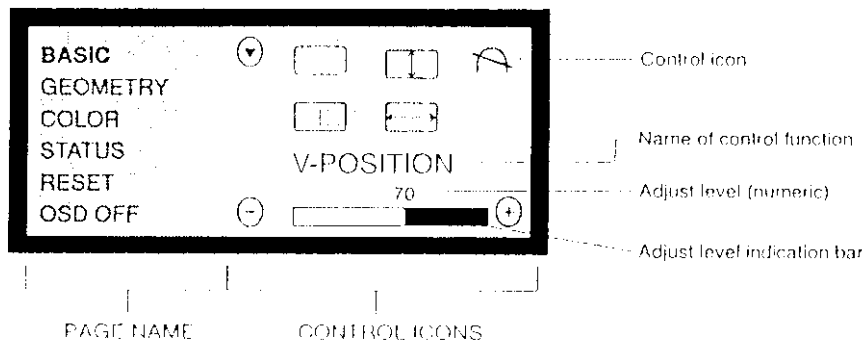

The active PAGE NAME is indicated in red and active CONTROL ICON is indicated by superimposed yellow block.

Press the (M) button to select the page of control functions and press (V) button to select the control icon within the page selected.

NOTE: If left untouched for approx. 30 seconds, the Main Menu OSD screen will disappear.

While the main menu is not superimposed on the display screen, press (E) or (F) adjust button to activate the sub-menu which consist of Contrast and Brightness control icon as shown below.

Each Control icon can be selected by pressing (V) button under SUB-MENU.

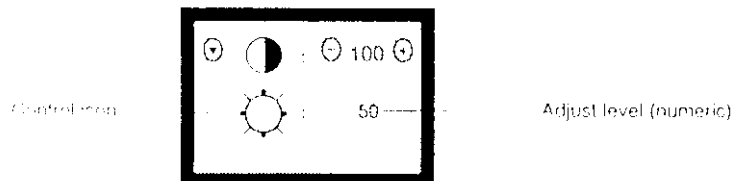

NOTE: If left untouched for approx. 5 seconds, the Sub Menu OSD screen will disappear.

Page 1: Basic Function Control (BASIC)

ENGLISH

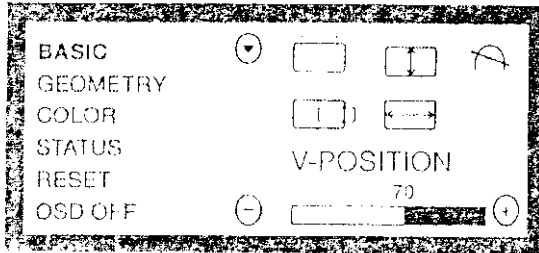

Each time the OSD button is pressed "V-Position / H-Position / V-Size / H-Size / Degauss" item.

• V-Position Control [ ]

Press the **OSD** Button

- ◀ To move the image upwards,
- ▶ To move the image downwards.

• H-Position Control [ ]

Press the **OSD** Button

- ◀ To move the image to the right,
- ▶ To move the image to the left.

• V-Size Control [ ]

Press the **OSD** Button

- ◀ To enlarge the height of the image
- ▶ To reduce the height of the image

• H-Size Control [ ]

Press the **OSD** Button

- ◀ To enlarge the width of the image,
- ▶ To reduce the width of the image.

• Degauss Control [ ]

Press the **OSD** Button to activate manual degauss function.

Page 2: Geometry Function Control (GEOMETRY)

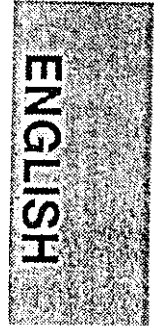
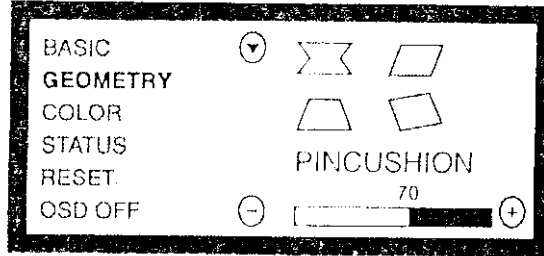

Push the  $\blacktriangledown$  button to select "Pincushion / Trapezoid / Parallelogram / Rotation" item.

• Pincushion Control  $\curvearrowright$   $\curvearrowleft$

Press the  $\blacktriangle$  Button

- $\curvearrowright$  To bow outwards at the center of the image.
- $\curvearrowleft$  To bow inwards at the center of the image.

• Trapezoid Control  $\nabla$   $\Delta$

Press the  $\blacktriangle$  Button

- $\nabla$  To expand the top width of the image and reduce the bottom width of the image.
- $\Delta$  To reduce the top width of the image and expand the bottom width of the image.

• Parallelogram  $\nabla$   $\Delta$

Press the  $\blacktriangle$  Button

- $\nabla$  To move the top of the image to right and the bottom of the image to left.
- $\Delta$  To move the top of the image to left and the bottom of the image to right.

• Rotation  $\curvearrowright$   $\curvearrowleft$

Press the  $\blacktriangle$  Button

- $\curvearrowright$  To rotate the image in clockwise.
- $\curvearrowleft$  To rotate the image in counter-clockwise.

Page 3: COLOR

Color temperature 9300K or 6500K, which are preset by factory, can be selected by pressing (F4) or (F3) button.

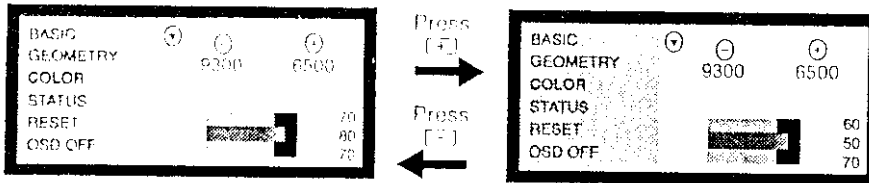

The R, G, B level of each color temperature can be changed by pressing (F7) to select the color and press (F1) to increase the level, or press (F2) to decrease the level.

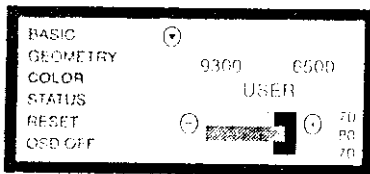

**NOTE:** Once the color level is changed, a "USER" will be shown to indicate that the levels are no longer the factory preset level.

Page 4: STATUS

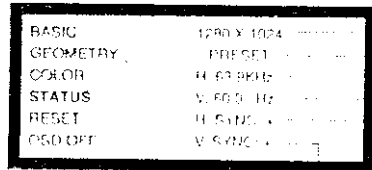

- RESOLUTION (Not showing when the timing is a user timing)
- PRESET: To indicate the factory preset timing
- USER: To indicate the user timing
- Horizontal scanning frequency
- Vertical scanning frequency
- Horizontal signal polarity
- Vertical signal polarity

Page 5: RESET

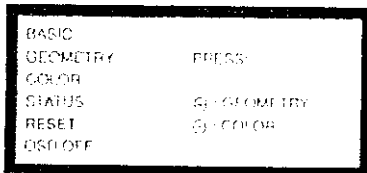

Press (F1), the monitor will reset the geometry of the image. (Only for Factory Preset Timing).

Press (F2), the monitor will reset the color of the image.



Page 6: OSD OFF

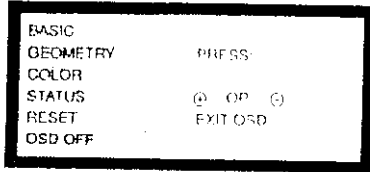

- Press ( [ ] ) or ( [ ] ) Button to exit OSD.
- Press ( [MENU] ) and ( [ ] ) Button together for quick OSD OFF.

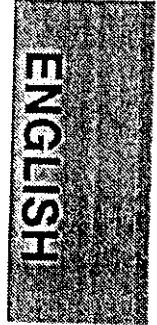

B) SUB-MENU

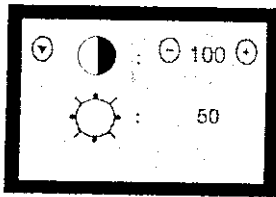

Contrast / Brightness Control

Push ( [ ] ) Button to select Contrast / Brightness item.

Press the [ ] Button

- [ ] To increase Contrast / Brightness level.
- [ ] To decrease Contrast / Brightness level.

C) Volume Control (for Diamond Scan 50M)

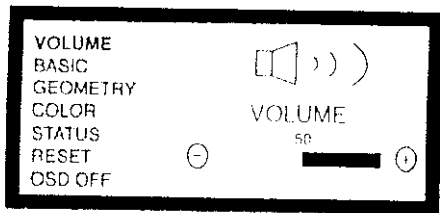

Press the [ ] Button

- [ ] To increase volume level.
- [ ] To decrease volume level.

# 5

## TROUBLESHOOTING

ENGLISH

Before calling MITSUBISHI ELECTRIC, please check that the items below are properly connected or set.

In case of using a non-standard signal, please check the pin assignments and the signal timing of your adapter with the specification outlined in chapter 6 and 7.

PROBLEM		ITEMS TO CHECK	LOCATION
No picture	LED On-Green	<ul style="list-style-type: none"> <li>Contrast and brightness controls.</li> </ul>	<ul style="list-style-type: none"> <li>Front (Adjust to the maximum brightness and contrast by using OSD)</li> </ul>
	LED Off	<ul style="list-style-type: none"> <li>Power switch.</li> <li>AC power cord disconnected.</li> </ul>	<ul style="list-style-type: none"> <li>Front</li> <li>Rear</li> </ul>
	LED On-Amber	<ul style="list-style-type: none"> <li>Signal cable disconnected.</li> <li>Computer power switch.</li> <li>Power management function is active.</li> </ul>	<ul style="list-style-type: none"> <li>Rear</li> <li>Computer</li> <li>Check the power management function. (see P6)</li> </ul>
Abnormal picture	Unstable picture	<ul style="list-style-type: none"> <li>Input signal frequency range is disagreement.</li> <li>CGA MODE is not available.</li> <li>MDA MODE is not available.</li> <li>EGA MODE is not available.</li> </ul>	<ul style="list-style-type: none"> <li>Check the specification of graphics adapter and monitor</li> </ul>
	Display is missing, center shifts, or too small or too large of a display size	<ul style="list-style-type: none"> <li>Activate the reset function in OSD for a standard signal.</li> <li>Adjust H-Size, V-Size, H-Position and V-Position with non-standard signals.</li> </ul>	<ul style="list-style-type: none"> <li>Front (OSD)</li> <li>Front (OSD)</li> </ul>
No sound (for Diamond Scan 50M)	Speaker no sound and headphone no sound	<ul style="list-style-type: none"> <li>The volume setting in OSD control.</li> <li>The volume setting under PC Windows or Mac OS, make sure that the "mute" function is disabled.</li> <li>Audio Cable connection.</li> </ul>	<ul style="list-style-type: none"> <li>Front (OSD)</li> <li>Computer</li> <li>Rear (RCA Jack)</li> </ul>
	Speaker OK but headphone no sound	<ul style="list-style-type: none"> <li>Headphone jack connection with the headphone plug.</li> </ul>	<ul style="list-style-type: none"> <li>Front (Headphone Jack)</li> </ul>

If the problem persists, call MITSUBISHI Product Support at 1-800-344-6352.

# 6

## SPECIFICATIONS

	Spot Mask	15 (13.8" Diagonal Viewable Image), Shadow mask
	Case	In-line, Mini neck
	Deflection angle	90°
	Fluorophors	Red, Green, Blue (medium short persistence)
	Dot pitch	0.28mm
	Face plate	Anti-Reflective and Anti-static coating
	Transmission	Approx. 57%
INPUT SIGNAL	Video	C/V/pulping RGB
	Sync	Separated H, V Sync, or Composite sync
LINE RATE	Input Connector	3-50P 15P
	Input Impedance	75Ω (video)
SCANNING	Horizontal	30 - 70kHz
FREQUENCY	Vertical	50 - 100Hz
RESOLUTION (H/V)	Compatible with systems up to	1280dot x 1024line (Max. Non Interlaced)
WARM-UP TIME		30 minutes to reach optimum performance level
PHYSICS		100g <sub>max</sub> , standard full white video signal
VIDEO BANDWIDTH		95MHz ± 3dB (typ.)
BLANKING TIME	Horizontal	3.0 μsec (typ.)
	Vertical	0.6 μsec (typ.)
DISPLAY SIZE	240mm x 200mm (typ.)	ratio 4:3, e.g. 1024dot x 768line
COLOR	1 - 6500K, 2 - 6500K	
POWER SOURCE	AC100-120V, 20-240V (10% - 60/60Hz)	10W (Diamond Scan 50) / 85W (Diamond Scan 50M)
OPERATING	Temperature	0 - 35°C
ENVIRONMENT	Humidity	10 - 80%RH (without condensation)
	Altitude	0 - 3000m
GAHMET	125.00mm x 118.71mm x 118.71mm	
WEIGHT	14.5kg (Diamond Scan 50) / 115.0kg (Diamond Scan 50M)	
REL. SWITCH	Life Span	50,000
BASE	Panel Angle	100°
	Safety	UL1950 (II), CSA C22.2 NO.950 (c UL), EN60950 (TUV-GS)
REGULATIONS	EMC	FCC-B, DOC-B, EN 55022-B, EN55024-1, EN61000-3-2, VCCI-2
	China	GB18801.1, GB18801.2, GB4780
	Japan	UL Marking, IEC/IEK Spec.903299/94, JIS C619 (TUV-GS), MPH II, TCO-95, ROHS 11.0 (TUV-ERGO)
		International Energy Star Program
APPEND	1/2 x 2, 5pin	Diamond Scan 50M

ENGLISH

# 7

## APPENDIX

### 7.1 Monitor Signal Cable Pin Assignment

ENGLISH

(Male)

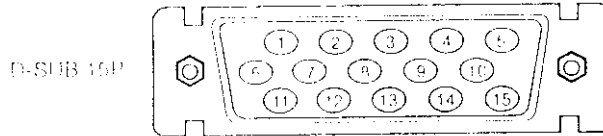

#### PIN ASSIGNMENTS

SIGNAL PIN ASSIGNMENT	SEPARATE	COMPOSITE
	SYNC	SYNC
1	*RED	*RED
2	*GREEN	*GREEN
3	*BLUE	*BLUE
4	GROUND	GROUND
5	GROUND	GROUND
6	RED GROUND	RED GROUND
7	GREEN GROUND	GREEN GROUND
8	BLUE GROUND	BLUE GROUND
9	NC	NC
10	SYNC GROUND	SYNC GROUND
11	GROUND	GROUND
12	SDA	SDA
13	HORIZONTAL SYNC	H/V SYNC
14	VERTICAL SYNC	
15	SCL	SCL

\* ..... 0.7Vpp (VIDEO)

SDA ..... SERIAL DATA

SCL ..... SERIAL CLOCK

7.2 Connector for Macintosh® family of Computer (640 x 480).....Available from your dealer

ENGLISH

Model : ADAPTER SD-2  
PIN ASSIGNMENT  
Approx 28mm

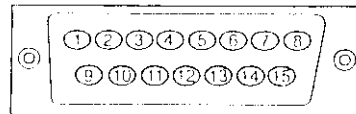
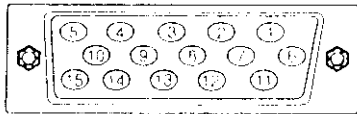
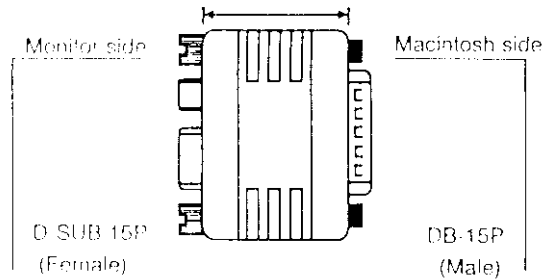

SIGNAL PIN ASSIGNMENT	ANALOG
1	RED
2	GREEN
3	BLUE
4	NC
5	GROUND
6	RED GROUND
7	GREEN GROUND
8	BLUE GROUND
9	NC
10	GROUND
11	NC
12	NC
13	H(HV composite) Sync.
14	NC
15	NC

SIGNAL PIN ASSIGNMENT	ANALOG
1	RED GROUND
2	RED
3	Composite Sync
4	GROUND
5	GREEN
6	GREEN GROUND
7	NC
8	NC
9	BLUE
10	NC
11	Composite Sync GROUND
12	NC
13	BLUE GROUND
14	NC
15	NC

NC ..... NO CONNECTION



SD5904C/SD5904CM

 MITSUBISHI ELECTRIC CORPORATION

C871031A30  
Delta's P/N

