

TABLE OF CONTENTS

- Introduction..... 3
- How to Read This Manual 4
 - Symbols.....4
 - Disclaimer.....4
 - Notes.....4
- Checking the Contents of the Product..... 5
- On-screen Operating Instructions..... 6
 - Reading the HTML Manual on the CD-ROM..... 6
 - Installing and Opening the HTML Manual..... 6
- 1. Safety Information**

- Safety During Operation.....9
- Safety Precautions to Be Followed..... 10
 - Handling the Interactive Kit..... 10
 - About the Batteries..... 10
- 2. Information for This Machine**

- Laws and Regulations..... 13
 - CE Marking Traceability Information (For EU Countries Only)..... 13
 - Notice to Users in EEA Countries..... 13
 - Overseas Affiliates and Noise Emission Information..... 14
 - User Information on Electrical and Electronic Equipment..... 14
 - Note for the Battery and/or Accumulator Symbol (For EU countries only)..... 15
 - FCC Rules and IC Rules..... 15
 - Notes to USA Users of FCC Requirements..... 16
 - Notes to users in the state of California (Notes to Users in USA)..... 17
 - Notes to Canadian Users of ICES -003 Conformance..... 17
- 3. Setting Up the Product**

- Preparing to Use This Product..... 19
- Setting Up the Projector..... 21
- Enabling Interactive Mode..... 23
- Registering the Computer USB Adapter..... 25
 - Operating Environment of the Computer Using the Computer USB adapter..... 25
 - Registering the Computer USB Adapter into the Projector..... 25
- Enabling the Projector to Recognize the Electronic Pen..... 29

4. Using the Product

Using the Electronic Pen.....	33
Part Names and Functions.....	33
Holding the Electronic Pen.....	34
How to Use the Electronic Pen.....	35
Installing a Rechargeable Battery into the Electronic Pen.....	37
Recharging the Electronic Pen.....	38
Using the Software.....	40
Operating Environment of the Computer Using the Software.....	40
Installing the Software on a Computer.....	40
Uninstalling the Software from the Computer.....	41

5. Troubleshooting

When the Projected Screen Cannot Be Operated.....	43
---	----

6. Appendix

Trademarks.....	45
-----------------	----

Introduction

This manual contains detailed instructions and notes on the operation and use of this machine. For your safety and benefit, read this manual carefully before using the machine. Keep this manual in a handy place for quick reference.

How to Read This Manual

Symbols

This manual uses the following symbols:



Indicates points to pay attention to when using the machine.



Indicates supplementary explanations of the machine's functions, and instructions on resolving user errors.



Indicates the names of keys on the machine's display or control panels.



Indicates instructions stored in a file on a provided CD-ROM.

Disclaimer

To the maximum extent permitted by applicable laws, in no event will the manufacturer be liable for any damages whatsoever arising out of failures of this machine, losses of the registered data, or the use of this product and operation manuals provided with it.

Make sure that you always copy or have backups of the data registered in this machine. Documents or data might be erased due to your operational errors or malfunctions of the machine.

In no event will the manufacturer be responsible for any documents created by you using this machine or any results from the data executed by you.

Notes



Contents of this manual are subject to change without prior notice.

Some illustrations in this manual might be slightly different from the machine.

The manufacturer shall not be responsible for any damage or expense that might result from the use of parts other than genuine parts from the manufacturer with your office products.

Checking the Contents of the Product

The following accessories are packaged with the product. Make sure all of these accessories are included.

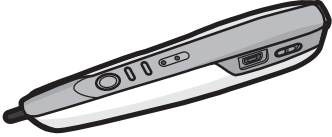
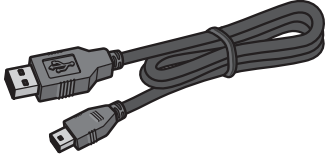
Accessories	Usage
<p>Projector Adapter</p>  <p>CWD001</p>	<p>Attach this adapter to the projector.</p> <p>For details about how to do this, see page 21 "Setting Up the Projector".</p>
<p>Computer USB Adapter</p>  <p>CWD002</p>	<p>Attach this adapter to a computer connected to the projector.</p> <p>For details about how to attach the computer USB adapter, see page 25 "Registering the Computer USB Adapter".</p>
<p>Electronic Pen</p>  <p>CWD003</p>	<p>Use this pen to manipulate and perform operations on the computer screen projected by the projector.</p> <p>The electronic pen is only to be used with this product. Do not use this pen with any other products. Likewise, do not use any other pens with this product.</p> <p>For details about how to do this, see page 33 "Using the Electronic Pen".</p>
<p>Electronic Pen Charge Cable</p>  <p>CWD004</p>	<p>Connect this cable to the USB port of the electronic pen to charge the pen.</p> <p>For details about how to do this, see page 38 "Recharging the Electronic Pen".</p>

- AAA Ni-MH rechargeable batteries × 2
- CD-ROM
- Read This First (This Manual)
- Other documents

On-screen Operating Instructions

This chapter describes the on-screen operating instructions of this machine. The on-screen operating instructions are included in the supplied CD-ROM.

The operating instructions of this machine are provided in the following formats:

- Printed manual
- HTML manual

Reading the HTML Manual on the CD-ROM

This section describes how to read the HTML manual on the supplied CD-ROM.

1. **Insert the CD-ROM in the CD-ROM drive of your computer.**
2. **Select a language, and then click [OK].**
3. **Click [Read HTML manual].**
The browser opens.
4. **Click the title of manual you want to read.**

Note

- Recommended browsers:
 - Internet Explorer 6 or later
 - Firefox 3.5 or later
 - Safari 4.0 or later
- If JavaScript is disabled or unavailable in your browser, you will not be able to search or use certain buttons in the HTML documentation.

Installing and Opening the HTML Manual

This section describes how to install and open the HTML manual on your computer.

For your convenience, we recommend you install this manual on your computer.

1. **Insert the CD-ROM in the CD-ROM drive of your computer.**
2. **Select a language, and then click [OK].**
3. **Click [Install manual].**
4. **Install the HTML manuals by following the on-screen instructions.**
5. **When the installation is complete, click [Finish].**
6. **Click [Exit].**

7. Open the HTML manual that you installed.

To open the manual from an icon, double-click the icon on the desktop. To open the manuals from the [Start] menu, point to [All Programs], and then click [Product Name].

8. Click the title of the manual you want to read.

Note

- You need administrator permissions to install the manuals. Log in as an Administrators group member.
- The system requirements for installing the manuals are as follows:
 - Operating system: Windows XP / Windows Vista / Windows 7, Windows Server 2003 / 2003 R2 / 2008 / 2008 R2
 - Minimum display resolution: 800 × 600 pixels
- If you cannot install a manual, copy the "MANUAL_HTML" folder to your computer's hard drive, and then run "setup.exe".
- To delete an installed manual, on the [Start] menu, point to [All Programs], click [Product Name], and then uninstall the data.
- Depending on the settings made during installation, menu folder names may differ.



1. Safety Information

This chapter describes the safety precautions.

Safety During Operation

1

In this manual, the following important symbols are used:

WARNING

Indicates a potentially hazardous situation which, if instructions are not followed, could result in death or serious injury.

CAUTION

Indicates a potentially hazardous situation which, if instructions are not followed, may result in minor or moderate injury or damage to property.

Safety Precautions to Be Followed

This section explains safety precautions that should always be followed when using this machine.

1

Handling the Interactive Kit

WARNING

- Do not remove any covers or screws other than those explicitly mentioned in this manual. Inside this machine are high voltage components that are an electric shock hazard. Contact your sales or service representative if any of the machine's internal components require maintenance, adjustment, or repair.
- Do not attempt to disassemble or modify this machine. Doing so risks burns and electric shock.

WARNING

- Do not remove any covers or screws other than those explicitly mentioned in this manual. Inside this machine are high voltage components that are an electric shock hazard and laser components that could cause blindness. Contact your sales or service representative if any of the machine's internal components require maintenance, adjustment, or repair.
- Do not attempt to disassemble or modify this machine. Doing so risks burns and electric shock. Note again that exposure to the laser components inside this machine risks blindness.

CAUTION

- Keep projector adapter or computer USB adapter out of reach of children. If a child accidentally swallows a projector adapter or computer USB adapter, consult a doctor immediately.

About the Batteries

This section explains things that you should follow in regard to the batteries.

⚠ WARNING

- For safe operation, follow the warnings below regarding the batteries used in the pen. If you use the batteries incorrectly, it may result in fire or injury due to batteries leaking or exploding.
 - Do not use batteries other than the ones specified.
 - Correctly insert batteries according to the polarity (+ / -).
 - Do not charge non-rechargeable batteries.
 - Do not heat or throw the batteries into fire or water.
 - Do not connect the positive and negative terminals on a battery with a wire.
 - Remove the batteries from the remote control that are past their suggested use period or that are depleted.
 - Remove the batteries when they will not be used for extended periods.
 - Keep the batteries out of the reach of children. Children may swallow or choke on the batteries. If this happens, contact a doctor immediately.

⚠ WARNING

- What to do if a battery has leaked
 - If leakage from a battery adheres to your skin, rinse it with water immediately, and then contact a doctor.
 - Wipe off the leakage with tissue paper while being careful not to touch it.
 - Soak the tissue paper that you used in water, and then throw it away as burnable trash.

⚠ CAUTION

- Danger of explosion if battery is incorrectly replaced.
- Replace only with the same or equivalent type recommended by the manufacturer. Dispose of used battery (AAA Ni-MH rechargeable batteries) according to the manufacturer's instructions.

2. Information for This Machine

This chapter describes laws and regulations related to this machine.

Laws and Regulations

2

CE Marking Traceability Information (For EU Countries Only)

Manufacturer:

Ricoh Co., Ltd.

3-6 Nakamagome 1-chome, Ohta-ku, Tokyo. 143-8555, Japan

Importer:

Ricoh Europe PLC

20 Triton Street, London. NW1 3BF, United Kingdom

Notice to Users in EEA Countries

For users of electronic pen/PC USB adapte/



Declaration of Conformity

Notice to Users in EEA Countries

This product complies with the essential requirements and provisions of Directive 1999/5/EC of the European Parliament and of the Council of 9 March 1999 on radio equipment and telecommunications terminal equipment and the mutual recognition of their conformity.

The CE Declaration of Conformity is available on the Internet at

URL: http://www.ricoh.co.jp/fax/ce_doc/

Deutsch



Konformitätserklärung

Hinweis für Anwender in den EWG-Ländern:

Dieses Produkt erfüllt die wesentlichen Anforderungen und Bestimmungen der Richtlinie 1999/5/EG des Europäischen Parlaments und des Rates vom 9. März 1999 über Funkanlagen und Telekommunikationsendeinrichtungen und die gegenseitige Anerkennung ihrer Konformität.

Die CE-Konformitätserklärung ist im Internet unter folgender URL verfügbar: http://www.ricoh.co.jp/fax/ce_doc/.

Overseas Affiliates and Noise Emission Information

In accordance with TUV "GS Symbol" requirements, details of the EU office or representative company are given below.

Overseas Affiliates

Ricoh Europe PLC
20 Triton Street, London. NW1 3BF, United Kingdom

Noise Emission

Maschinenlärminformations-Verordnung 3. GPSGV:
Der höchste Schalldruckpegel beträgt 70 dB(A) oder weniger gemäss EN ISO 7779

User Information on Electrical and Electronic Equipment

Users in the countries where this symbol shown in this section has been specified in national law on collection and treatment of E-waste

Our Products contain high quality components and are designed to facilitate recycling.
Our products or product packaging are marked with the symbol below.



The symbol indicates that the product must not be treated as municipal waste. It must be disposed of separately via the appropriate return and collection systems available. By following these instructions you ensure that this product is treated correctly and help to reduce potential impacts on the environment and human health, which could otherwise result from inappropriate handling. Recycling of products helps to conserve natural resources and protect the environment.

For more detailed information on collection and recycling systems for this product, please contact the shop where you purchased it, your local dealer or sales/service representatives.

All Other Users

If you wish to discard this product, please contact your local authorities, the shop where you bought this product, your local dealer or sales/service representatives.

2

For Turkey only

EEE Yönetmeliğine Uygundur.
Bu sistem sarf malzemeleri ve yedek parçaları da dahil olmak üzere EEE Yönetmeliğine Uygundur.

Note for the Battery and/or Accumulator Symbol (For EU countries only)



In accordance with the Battery Directive 2006/66/EC Article 20 Information for end-users Annex II, the above symbol is printed on batteries and accumulators.

This symbol means that in the European Union, used batteries and accumulators should be disposed of separately from your household waste.

In the EU, there are separate collection systems for not only used electrical and electronic products but also batteries and accumulators.

Please dispose of them correctly at your local community waste collection/recycling centre.

FCC Rules and IC Rules

Warning:

For user of electronic pen/PC USB adapte

This device complies with Part 15 of FCC Rules and Industry Canada licence-exempt RSS standard(s). Operation is subject to the following two conditions:

- (1) this device may not cause interference, and
- (2) this device must accept any interference, including interference that may cause undesired operation of this device.

Le présent appareil est conforme aux la partie 15 des règles de la FCC et CNR d'Industrie Canada applicables aux appareils radio exempts de licence.

L'exploitation est autorisée aux deux conditions suivantes :

- (1) l'appareil ne doit pas produire de brouillage, et
- (2) l'utilisateur de l'appareil doit accepter tout brouillage radioélectrique subi, même si le brouillage est susceptible d'en compromettre le fonctionnement.

This equipment complies with FCC/IC radiation exposure limits set forth for an uncontrolled environment and meets the FCC radio frequency (RF) Exposure Guidelines in Supplement C to OET65 and RSS-102 of the IC radio frequency (RF) Exposure rules. This equipment has very low levels of RF energy that are deemed to comply without testing of specific absorption ratio (SAR).

Cet équipement est conforme aux limites d'exposition aux rayonnements énoncées pour un environnement non contrôlé et respecte les règles les radioélectriques (RF) de la FCC lignes directrices d'exposition dans le Supplément C à OET65 et d'exposition aux fréquences radioélectriques (RF) CNR-102 de l'IC. Cet équipement émet une énergie RF très faible qui est considérée conforme sans évaluation du débit d'absorption spécifique (DAS).

FCC CAUTION

Changes or modifications not expressly approved by the party responsible for compliance could void the user's authority to operate the equipment.

Properly shielded and grounded cables and connectors must be used for connection to host computers and / or peripherals in order to meet FCC emission limits.

This transmitter must not be co-located or operated in conjunction with any other antenna or transmitter.

Notes to USA Users of FCC Requirements

Declaration of Conformity

This device complies with Part 15 of the FCC Rules.

Operation is subject to the following two conditions:

- (1) This device may not cause harmful interference, and
- (2) this device must accept any interference received, including interference that may cause undesired operation.

Responsible party: Ricoh Americas Corporation

Address: 5 Dedrick Place, West Caldwell, NJ 07006

Telephone number: 973-882-2000

Product Name:

- Electronic pen
- PC USB adapte

Model Number:

Note:

This equipment has been tested and found to comply with the limits for a Class B digital device, pursuant to Part 15 of the FCC Rules. These limits are designed to provide reasonable protection against harmful interference in a residential installation. This equipment generates, uses and can radiate radio frequency energy and, if not installed and used in accordance with the instructions, may cause harmful interference to radio communications. However, there is no guarantee that interference will not occur in a particular installation. If this equipment does cause harmful interference to radio or television reception, which can be determined by turning the equipment off and on, the user is encouraged to try to correct the interference by one or more of the following measures:

- Reorient or relocate the receiving antenna.
- Increase the separation between the equipment and receiver.
- Connect the equipment into an outlet on a circuit different from that to which the receiver is connected.
- Consult the dealer or an experienced radio /TV technician for help.

Caution:

Changes or modifications not expressly approved by the party responsible for compliance could void the user's authority to operate the equipment.

Using the shield cable

Properly shielded and grounded cables and connectors must be used for connections to a host computer (and/or peripheral) in order to meet FCC emission limits.

Installing the ferrite core

Ferrite core must be used for RF interference suppression.

Notes to users in the state of California (Notes to Users in USA)

Perchlorate Material - special handling may apply, See www.dtsc.ca.gov/hazardouswaste/perchlorate

Notes to Canadian Users of ICES -003 Conformance**Notes to users in Canada**

This Class B digital apparatus complies with Canadian ICES-003.

Remarques à l'attention des utilisateurs canadiens

Cet appareil numérique de la classe B est conforme à la norme NMB-003 du Canada.

3. Setting Up the Product

This chapter explains how to set up the product for use in Interactive Mode.

Preparing to Use This Product

The product consists of an electronic pen, projector adapter, and PC USB adapter. The product allows you to operate a PC connected to the projector directly on the projection screen.

To operate the computer display on the screen, you need to connect devices using a wireless connection. Make the settings by following the steps below.

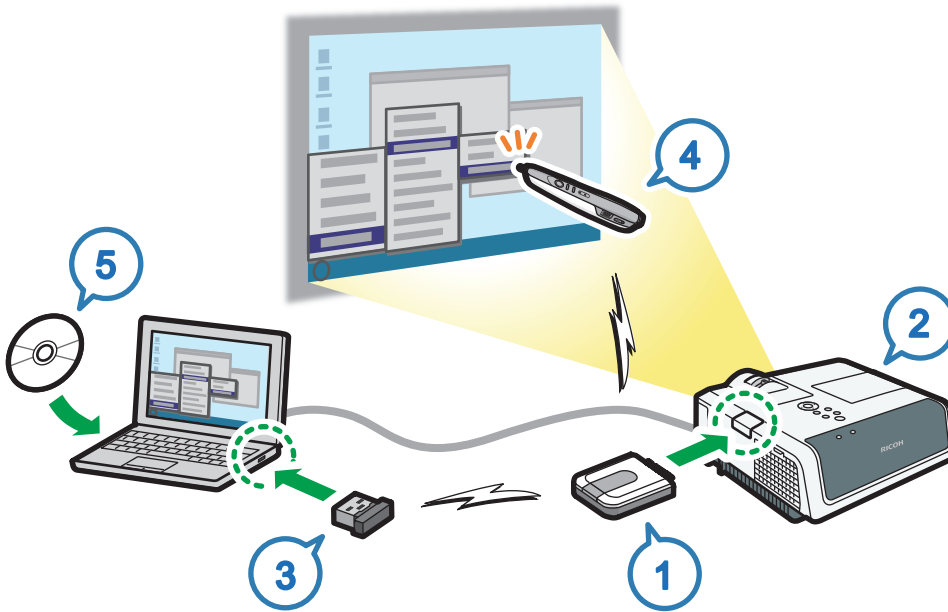

CWD031

Step	Setting Contents	Reference
1	Install the projector adapter into the projector.	page 21 "Setting Up the Projector"
2	Set Interactive Mode to [On].	page 23 "Enabling Interactive Mode"
3	Register the projector USB adapter to the projector.	page 25 "Registering the Computer USB Adapter"

Step	Setting Contents	Reference
4	Enable the projector to recognize the electronic pen.	page 29 "Enabling the Projector to Recognize the Electronic Pen"
5	Install the Software on a Computer.	page 40 "Using the Software"

Setting Up the Projector

★ Important

- If the projector is hung from the ceiling, please contact a sales representative or one of our agents before starting the installation work.

This section explains how to attach the projector adapter to the projector.

By installing the projector adapter into the projector, you can enable Interactive Mode.

⚠ CAUTION

- Keep projector adapter out of reach of children. If a child accidentally swallows a projector adapter, consult a doctor immediately.

3

1. Check the projector to make sure that the power supply is OFF.

If you attach the projector adapter while the projector power is on, Interactive Mode may not work correctly. For details about how to turn the projector off, see the manual included with the projector.

2. Slide the projector cover to remove it.

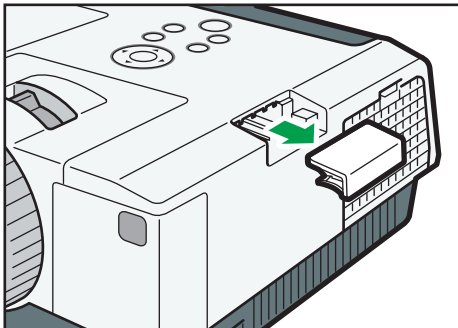

CWD005

3. Attach the projector adapter to the projector.

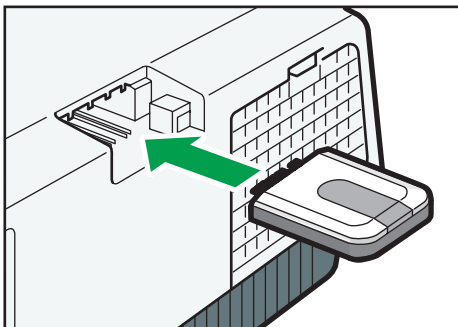

CWD006

4. Re-attach the projector cover.

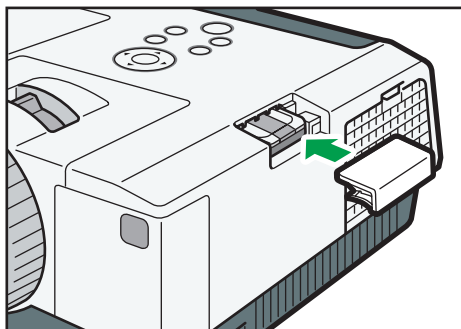

CWD007

Enabling Interactive Mode

This section explains how to set the projector in Interactive Mode.

In Interactive Mode, the projector can recognize the electronic pen and the computer USB adapter.

1. Turn on the projector to project the screen.

To turn on the projector or project the screen, see the operating instructions provided with the projector.

2. On the projector remote control, press the [Menu] button.

3. Using the [▲] and [▼] buttons, select [Default Settings 1] on the menu, and then press the [▶] button.

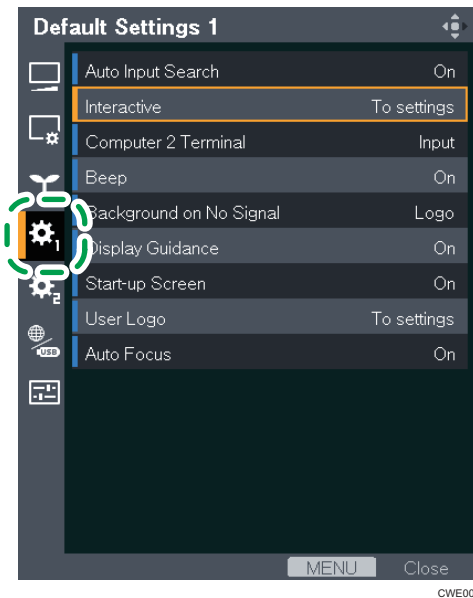

4. Using the [▲] and [▼] buttons, select [Interactive], and then press the [Enter] button.

You cannot select [Interactive] if the projector adapter is not installed into the projector. To install the projector adapter, see page 21 "Setting Up the Projector".

5. Check that [Interactive Mode] has been selected and press the [Enter] button.

6. Using the [↵] button, select [On], and then press the [Enter] button.

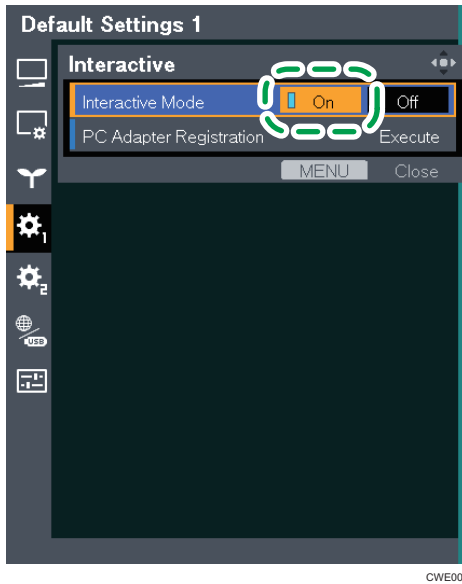

To go on to register a computer USB adapter, see page 25 "Registering the Computer USB Adapter".

7. Press the [Menu] button twice to close the menu screen.

Note

- You can also operate the menu screen of the projector from the projector's control panel.
- Some icons may not appear on the menu screen of the projector, depending on the projector model used.

Registering the Computer USB Adapter

This section explains how to register a computer USB adapter into the projector.

To use the computer USB adapter in Interactive Mode, the adapter must be registered to the projector. Once the computer USB adapter is registered to the projector, there is no need to register it again. You can use the computer USB adapter with any computer that is connected to the projector.

The procedure for registering the computer USB adapter to the projector is described below.

Operating Environment of the Computer Using the Computer USB adapter

3

The following operating environment is required to use the product.

Item	Specification
Operating System	<ul style="list-style-type: none"> Windows XP Windows 7
USB port	<ul style="list-style-type: none"> USB Type A Do not use a USB hub.

Registering the Computer USB Adapter into the Projector

To register a computer USB adapter, connect the projector to the computer, and then insert the adapter into the computer. Have a computer USB adapter at hand, ready for installation.

CAUTION

- Keep computer USB adapter out of reach of children. If a child accidentally swallows a computer USB adapter, consult a doctor immediately.

1. Turn on the projector to project the screen.

To turn on the projector or project the screen, see the operating instructions provided with the projector.

2. Connect the computer to the projector using RGB cables or an HDMI cable.

You cannot use the Interactive function if another type of cable is used for the connection. For the connection procedure, see the operating instructions provided with the projector.

3. Project the computer screen on the projector screen.

For the projecting procedure, see the operating instructions provided with the projector.

4. On the projector remote control, press the [Menu] button.

- Using the [▲] and [▼] buttons, select [Default Settings 1] on the menu, and then press the [▶] button.

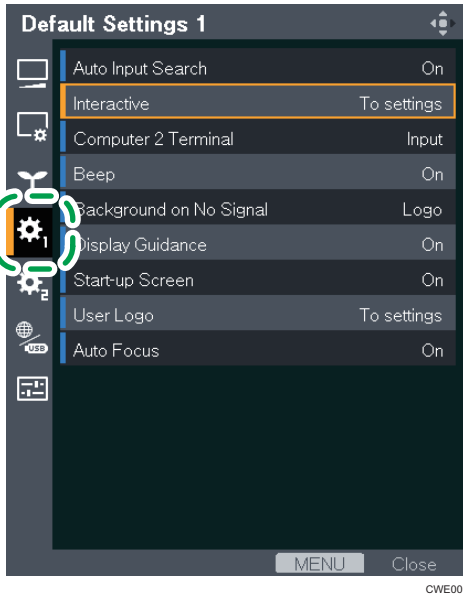

3

- Using the [▲] and [▼] buttons, select [Interactive], and then press the [Enter] button.

You cannot select [Interactive] if the projector adapter is not installed into the projector. To install the projector adapter, see page 21 "Setting Up the Projector".

- Check that [Interactive Mode] is set to [On].

For the setting procedure, see page 23 "Enabling Interactive Mode".

- Have a computer USB adapter at hand.



The projector takes about 15 seconds to find the computer USB adapter. Have a computer USB adapter at hand, ready for installation.

- Using the [▲] and [▼] buttons, select [PC Adapter Registration] and press the [Enter] button.

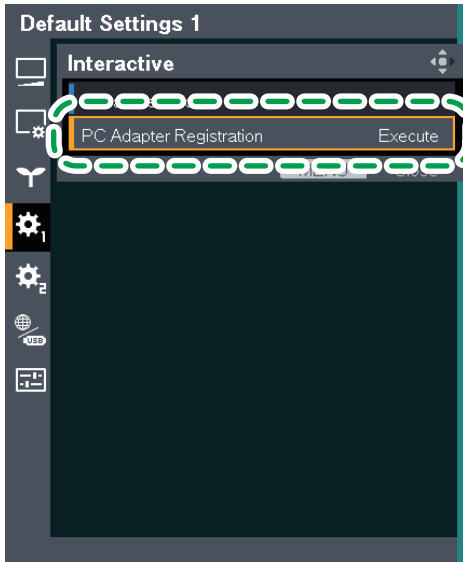

CWE003

- Check the message and press the [Enter] button.

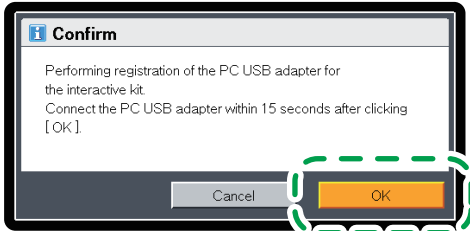

CWE004

- Install the computer USB adapter into the computer.

Upon being installed, the computer USB adapter flickers twice every 0.5 seconds.

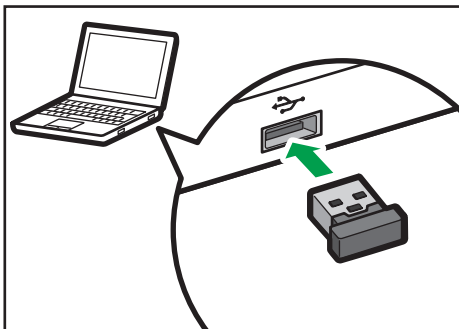

CWD013

If registration succeeds

The following message appears.

- "Registration has completed."

On being registered, the computer USB adapter flickers every two seconds.

Press the [Enter] button to close the message.

If registration fails

The following message appears.

- "Failed to register. Do you want to retry?"

Registration fails unless the computer USB adapter is installed into the computer while the projector is searching for the computer USB adapter.

If there are any obstacles between the projector and computer, the attempt to perform registration will fail.

To retry registration, select [OK] and press the [Enter] button. Then, take out the computer USB adapter from the computer and restart the procedure from Step 10.

12. Press the [Menu] button twice to close the menu screen.

Note

- You can also operate the menu screen of the projector from the projector's control panel.
- Some icons may not appear on the menu screen of the projector, depending on the projector model used.

Enabling the Projector to Recognize the Electronic Pen

This section explains how to have the projector recognize the electronic pen.

Once the projector recognizes the electronic pen, you can directly operate the computer display on the screen.

- 1. Turn on the projector to project the screen.**

To turn on the projector or project the screen, see the operating instructions provided with the projector.

- 2. Connect the computer to the projector using RGB cables or an HDMI cable.**

You cannot use the Interactive function if another type of cable is used for the connection. For the connection procedure, see the operating instructions provided with the projector.

- 3. Project the computer screen on the projector screen.**

For the projecting procedure, see the operating instructions provided with the projector.

- 4. Install the computer USB adapter into the computer.**

Upon being installed, the computer USB adapter flickers twice every 0.5 seconds.

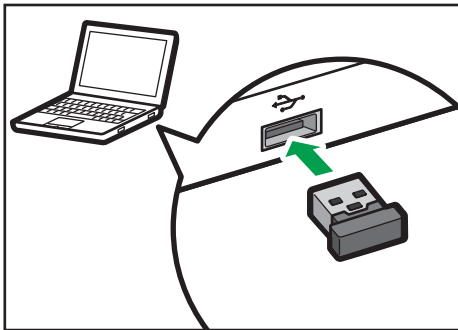

CWD013

When the registered computer USB adapter is installed into the projector, the adapter flickers once every 0.5 seconds. Then, when the computer USB adapter is connected to the projector, the adapter flickers once every two seconds. If the adapter flickers twice every 0.5 seconds, you need to register it on the projector.

To make registration, see page 25 "Registering the Computer USB Adapter".

5. Turn the power switch of the electronic pen to ON.

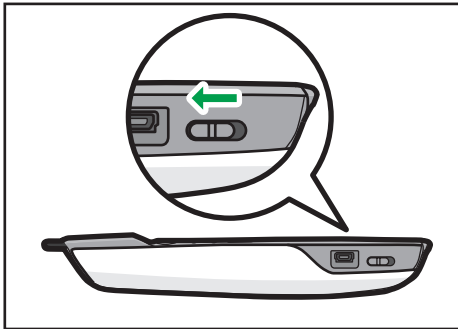

CWD011

Turn ON the power switch found on the electronic pen; the communication indicator on the electronic pen will then flicker.

If the communication indicator fails to flicker, check the electronic pen to make sure that a rechargeable battery is installed in the electronic pen. If a battery is installed, then recharge it. For about the electronic pen, see page 33 "Using the Electronic Pen".

6. Point the pen nib toward the projected screen.

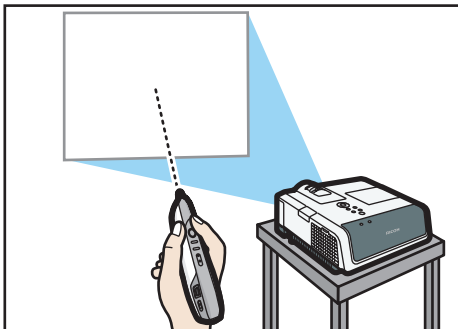

CWD051

If registration succeeds

The projected computer screen pointer moves according to the movements of the electronic pen.

- While a search is being made for the position of the electronic pen, the communication indicator on the electronic pen lights up in red.
- When the position of the electronic pen is received, the computer USB adapter lights up in green.

If registration fails

Potential causes are as follows:

- Check how you are holding the electronic pen. If you are holding the top or the bottom of the pen, the projector is unable to recognize the electronic pen correctly. To hold the electronic pen correctly, see page 34 "Holding the Electronic Pen".

- Check whether the pen tip is pointing at a shadow. If the pen tip is pointing at a shadow or if it is not pointing at the screen, then the projector is unable to recognize the electronic pen correctly. To operate the electronic pen correctly, see page 35 "How to Use the Electronic Pen".
- If the electronic pen is not recognized correctly after the direction of the pen is corrected or even when you hold the electronic pen correctly, check the procedure from Step 1 by referring to page 43 "When the Projected Screen Cannot Be Operated".

4. Using the Product

This chapter explains how to use this product.

Using the Electronic Pen

This section introduces the names of the parts of the electronic pen and explains how to charge it.

After you finish setting up the product, insert the computer USB adapter into the computer. After the computer recognizes the electronic pen, you can use it to perform operations on the projected screen. For details about the electronic pen, see page 29 "Enabling the Projector to Recognize the Electronic Pen".

Communication between the electronic pen, the projector adapter, and the computer USB adapter is conducted wirelessly. Do not block the area between the electronic pen, projector, and PC. In addition, do not use wireless devices near this product. Otherwise, the position of the electronic pen will not be recognized correctly.

Part Names and Functions

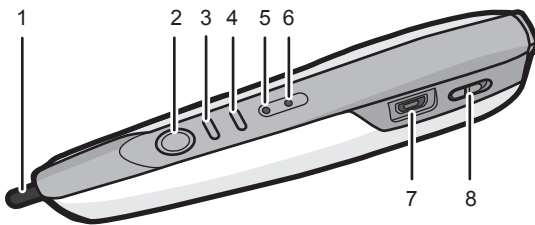

CWD008

1. Pen nib switch

Used to write, draw, and select operations on the projected screen. This switch is functionally equivalent to the left button of a computer mouse.

2. Left button

Similar to the left button of a computer mouse.

3. Right button

Similar to the right button of a computer mouse.

4. Point adjustment button

Used to adjust the point position of the pen tip when the pen is held in a different way. The standard position of the point is the center of the pen, and it moves each time this button is pressed. The order in which the point moves is as follows: up, down, and to the center.

5. Battery Indicator

Indicates the battery status of the electronic pen.

The battery indicator keeps lighting while charging and goes off when the charge is completed.

6. Communication indicator

Indicates the communication status of the electronic pen.

This indicator flickers in red until the projector recognizes the electronic pen.

When the projector recognizes the electronic pen, the indicator lights up in green or flickers rapidly.

7. USB connector

Used to connect the charge cable. See page 38 "Recharging the Electronic Pen".

8. Power switch

Switches the power of the electronic pen between ON and OFF.

Holding the Electronic Pen

4

Hold the middle of the electronic pen. If the nib or bottom of the electronic pen is held, the position of the electronic pen will not be recognized correctly.

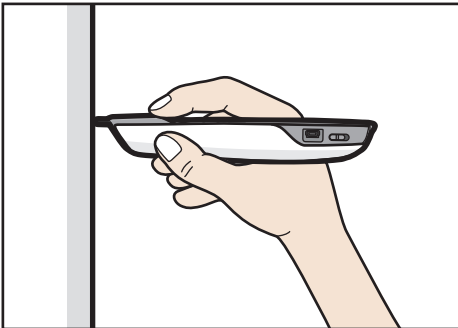

To align the point position of the electronic pen with the pen nib switch, and not the center of the pen, use the point adjustment button to move the point position up.

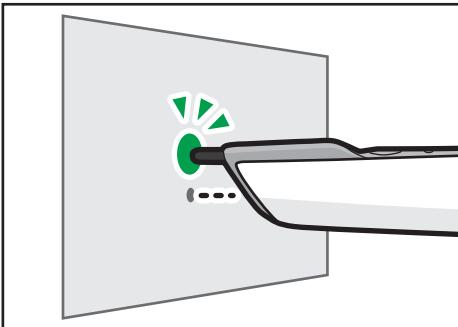

When the pen tip is pointed toward the screen projected by the projector in Interactive Mode, the electronic pen is recognized and the pointer on the projected PC screen can be operated with the electronic pen. See page 29 "Enabling the Projector to Recognize the Electronic Pen".

How to Use the Electronic Pen

You can operate the PC projection screen by touching it with the pen tip—you can select an icon or menu, or write and draw. You may also touch the pen tip twice on the same position of the screen, much like the double-click of a mouse.

★ Important

- Operate the electronic pen so that the pen tip does not point toward a shadowed area.

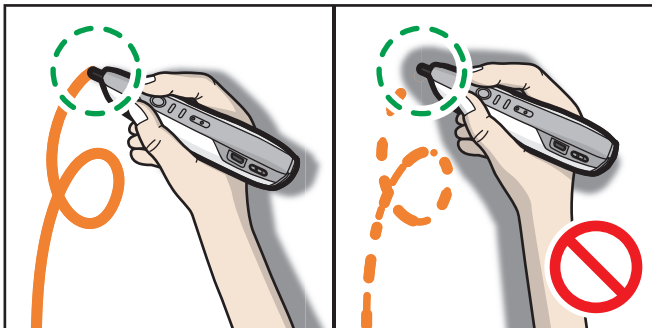

CWD014

When the projector is hanging from the ceiling, hold the electronic pen upside down to eliminate the shadow that appears on the screen.

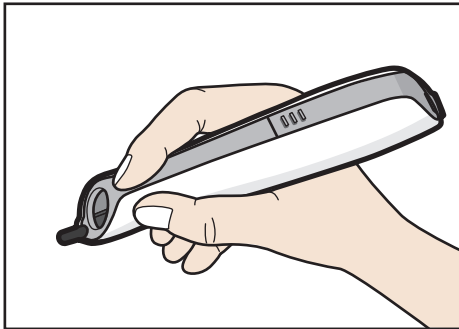

CWD024

To align the point position with the pen nib switch while holding the electronic pen upside down, use the point adjustment button to move the point position down.

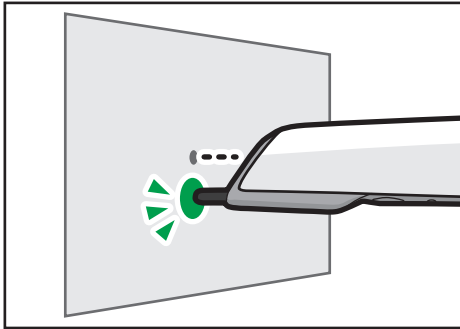

CWD032

Operating the Electronic Pen Remotely

4

You can also operate the screen remotely. When standing away from the screen, use the mouse button on the electronic pen.

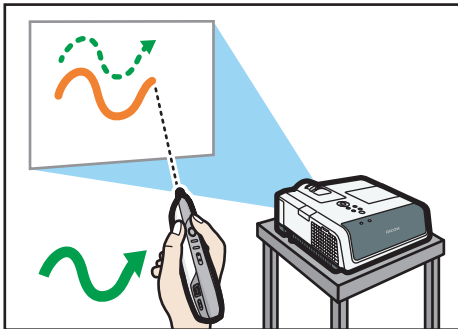

CWD017

↓ Note

- The electronic pen can only be used while the projector is in Interactive Mode. For details about how to configure the projector, see page 19 "Setting Up the Product".

Installing a Rechargeable Battery into the Electronic Pen

⚠ WARNING

- For safe operation, follow the warnings below regarding the batteries used in the pen. If you use the batteries incorrectly, it may result in fire or injury due to batteries leaking or exploding.
 - Do not use batteries other than the ones specified.
 - Correctly insert batteries according to the polarity (+ / -).
 - Do not charge non-rechargeable batteries.
 - Do not heat or throw the batteries into fire or water.
 - Do not connect the positive and negative terminals on a battery with a wire.
 - Remove the batteries from the remote control that are past their suggested use period or that are depleted.
 - Remove the batteries when they will not be used for extended periods.
 - Keep the batteries out of the reach of children. Children may swallow or choke on the batteries. If this happens, contact a doctor immediately.

⚠ WARNING

- What to do if a battery has leaked
 - If leakage from a battery adheres to your skin, rinse it with water immediately, and then contact a doctor.
 - Wipe off the leakage with tissue paper while being careful not to touch it.
 - Soak the tissue paper that you used in water, and then throw it away as burnable trash.

1. Check the electronic pen to make sure that the power is OFF.

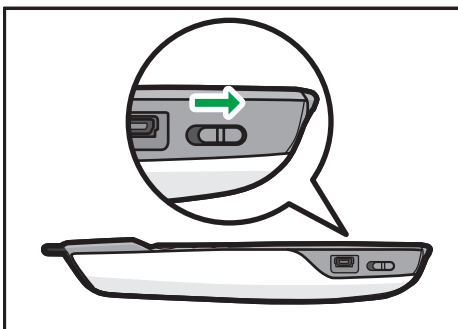

CWD029

2. Slide the battery cover to remove it.

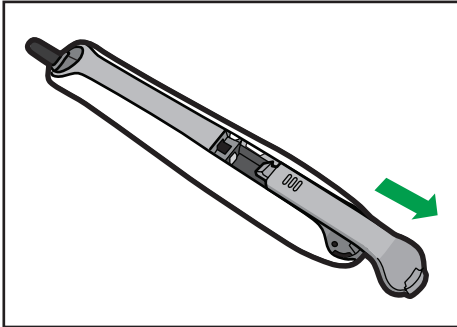

CWD025

3. Install a battery.

Check that the battery has been installed in the right direction.

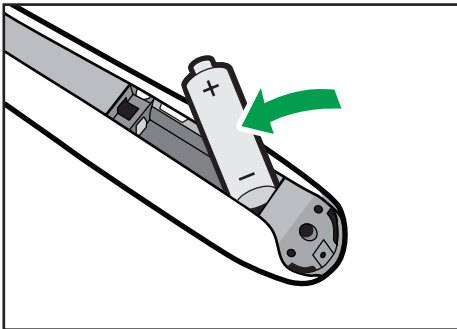

CWD026

4. Re-install the battery cover.

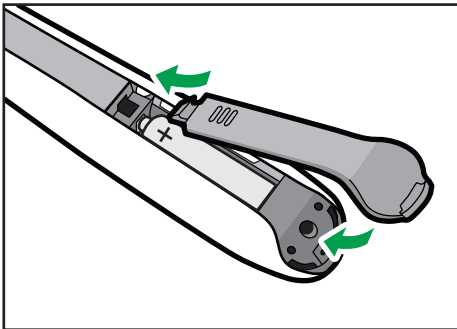

CWD027

Recharging the Electronic Pen

Insert an electronic pen charging cable into a USB port on the computer and connect the electronic pen.

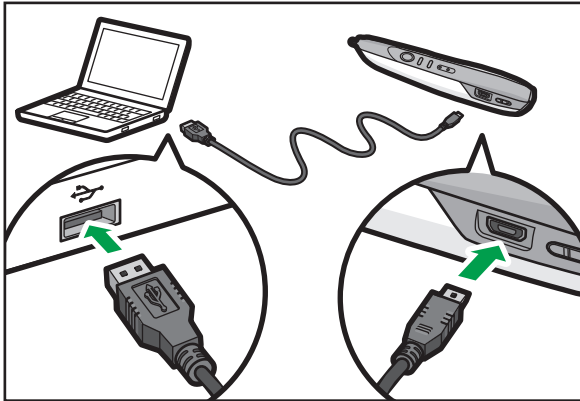

The battery indicator keeps lighting while charging and goes off when the charge is completed.

Using the Software

Ricoh Interactive Tool (hereafter the "Software") is the dedicated software for this product. It allows you to write and draw on a projection screen. When you use the Software, install it on a computer. For details about how to use the Software, see Operating Instructions .

Operating Environment of the Computer Using the Software

The following operating environment is required to use the Software. Please check before installation.

Item	Specification
CPU	<ul style="list-style-type: none"> Intel® Core™2 Duo 2 GHz or more (Minimum: Intel Core Solo U1300)
Memory	<ul style="list-style-type: none"> Windows 7 (32 bit): 1 GB or more Windows 7 (64 bit): 2 GB or more Windows XP: 1 GB or more (Minimum: 512 MB)
HDD	<ul style="list-style-type: none"> 2GB or more free space
Operating System	<ul style="list-style-type: none"> Windows 7 SP1 or later (32 bit / 64 bit) Home Premium / Professional / Ultimate / Enterprise Japanese, English Windows XP SP 3 or later (32 bit) Home / Professional Japanese, English

Installing the Software on a Computer

Important

- To install the Software on a computer, log on as a user with administrator privileges.

1. Insert the product CD-ROM into the computer.

If the auto-play screen appears, install or run the Software.

If the user account control screen appears, perform one of the following steps:

- If you have administrator privileges, permit changes to the computer.

- If you are a standard user, enter the administrator account password and click [Yes].
2. Click the application you want to install.
 3. Specify the language you want to use during the installation process, and then click [OK].
 4. If .NET Framework 4 is not installed on your computer, click [Install].
If .NET Framework 4 has already been installed, the message [Install] does not appear. Proceed to the next step.
 5. Click [Next.]
 6. Select "I accept the terms of the Software License Agreement.", and then click [Next].
If you do not agree, you will be unable to continue the installation process.
 7. Specify the installation folder, and then click [Next].
 8. Click [Install].
 9. Click [Close].

Uninstalling the Software from the Computer

This section explains how to uninstall the Software, using Windows 7 as an example.

The procedure may differ slightly depending on the OS you are using, but the basic steps are the same.

1. Click [Start], and then select [Uninstall a program] in [Control Panel].
2. Select the application, and then click [Uninstall / Change].
3. Select [Uninstall], and then click [Next].
4. Click [Close].

5. Troubleshooting

This chapter explains what action to do when the projected screen cannot be operated.

When the Projected Screen Cannot Be Operated

If the projected screen cannot be operated after the projector is started, follow the steps below in the specified order to troubleshoot the problem.

Step	Check item	Solutions
1	Check the projector to make sure that power is supplied to it.	If the projector is not supplied with power, check the power cord for connection and turn on the power. To connect the cord and turn on the power correctly, see the operating instructions provided with the projector.
2	Check to see whether the projector is in Interactive Mode.	If Interactive Mode is set to [Off], switch it to "On". For details about how to check whether the projector is in Interactive Mode, as well as how to specify the mode, see page 23 "Enabling Interactive Mode". If the projector adapter is not installed into the projector, the Interactive Mode settings are inoperable. Install the projector adapter. To install it correctly, see page 21 "Setting Up the Projector".
3	Check to see whether the computer USB adapter is connected to in the computer.	If the computer USB connector is not connected, connect it to one of the USB ports on the computer.
4	Check to see whether the computer USB adapter inserted in the computer is registered to the projector.	When registered, the computer USB adapter flickers once every 0.5 seconds. Then, when the projector and the computer USB adapter are recognized, the adapter flickers once every two seconds. If the adapter flickers twice every 0.5 seconds, the projector needs registering. To register it correctly, see page 25 "Registering the Computer USB Adapter".

Step	Check item	Solutions
5	Check that the computer is connected to the projector using RGB cables or an HDMI cable.	The Interactive function becomes inoperable if anything other than RGB cables or an HDMI cable is used. To connect these correctly, see the operating instructions provided with the projector.
6	Check that the computer screen is projected on the projector screen.	The electronic pen is not recognized unless the computer screen is projected. To project the screen correctly, see the operating instructions provided with the projector.
7	Check to see whether the power switch of the electronic pen is set to "ON".	If the power switch of the electronic pen is set to "OFF", turn it to "ON". For details about the location of the power switch of the electronic pen, see page 33 "Using the Electronic Pen".
8	Check to see whether the battery of the electronic pen is out of charge.	When the power switch on the electronic pen is turned ON, the communication indicator on the electronic pen flickers. If the indicator fails to flicker, check that a rechargeable battery is installed in the electronic pen. If a rechargeable battery is installed, recharge it. For details about the pen, see page 33 "Using the Electronic Pen".
9	Point the electronic pen nib toward the projected screen and check to see whether the electronic pen is recognized by the projector.	If the electronic pen is recognized correctly, the pointer on the projection screen will move in unison with the movement of the electronic pen. For details about how to make the projector recognize the electronic pen, see page 29 "Enabling the Projector to Recognize the Electronic Pen".

Note

- If you experience a problem with the actual projector, such as a problem starting the projector or projecting computer screens, see the manual included with the projector.
- If you are unable to resolve problem, contact your service provider.

6. Appendix

Trademarks

Firefox[®] is a registered trademark of the Mozilla Foundation.

Safari is trademarks of Apple Inc., registered in the United States and other countries.

Intel and Core are trademarks of Intel Corporation in the U.S. and/or other countries.

Microsoft[®], Windows[®] and Internet Explorer[®] are either registered trademarks or trademarks of Microsoft Corporation in the United States and/or other countries.

The proper name of Internet Explorer 6 is Microsoft[®] Internet Explorer[®] 6.

The proper names of the Windows operating systems are as follows:

- The product names of Windows XP are as follows:
 - Microsoft[®] Windows[®] XP Professional
 - Microsoft[®] Windows[®] XP Home Edition
- The product names of Windows 7 are as follows:
 - Microsoft[®] Windows[®] 7 Ultimate
 - Microsoft[®] Windows[®] 7 Professional
 - Microsoft[®] Windows[®] 7 Home Premium
 - Microsoft[®] Windows[®] 7 Enterprise
- The product names of Windows Server 2003 are as follows:
 - Microsoft[®] Windows Server[®] 2003 Standard Edition
 - Microsoft[®] Windows Server[®] 2003 Enterprise Edition
- The product names of Windows Server 2003 R2 are as follows:
 - Microsoft[®] Windows Server[®] 2003 R2 Standard Edition
 - Microsoft[®] Windows Server[®] 2003 R2 Enterprise Edition
- The product names of Windows Server 2008 are as follows:
 - Microsoft[®] Windows Server[®] 2008 Standard
 - Microsoft[®] Windows Server[®] 2008 Enterprise

Other product names used herein are for identification purposes only and might be trademarks of their respective companies. We disclaim any and all rights to those marks.

MEMO

MEMO

MEMO