

## **Copyright**

This publication, including all photographs, illustrations and software, is protected under international copyright laws, with all rights reserved. Neither this manual, nor any of the material contained herein, may be reproduced without written consent of the author.

© Copyright 2012

## **Disclaimer**

The information in this document is subject to change without notice. The manufacturer makes no representations or warranties with respect to the contents hereof and specifically disclaims any implied warranties of merchantability or fitness for any particular purpose. The manufacturer reserves the right to revise this publication and to make changes from time to time in the content hereof without obligation of the manufacturer to notify any person of such revision or changes.

## **Important Safety Information**

**Important:**

*It is strongly recommended that you read this section carefully before using the device. These safety and usage instructions will ensure that you enjoy many years of safe use. Keep this manual for future reference.*

### **Symbols Used**

Warning symbols are used on the device and in this manual to alert you of hazardous situations.

The following styles are used in this manual to alert you to important information.

**Note:**

*Provides additional information on the topic at hand.*

**Important:**

*Provides additional information that should not be overlooked.*

**Caution:**

*Alerts you to situations that may damage the device.*

**Warning:**

*Alerts you to situations that may damage the device, create a hazardous environment, or cause personal injury.*

### **General Safety Information**

- Do not open the device case. Aside from the battery, there are no user-serviceable parts in the device. For servicing, contact qualified service personnel.
- Follow all warnings and cautions in this manual and on the device case.
- Avoid using the system near water.

### **Power Safety**

- Only use the supplied cabling.
- Remove the battery when storing or not in use for a prolonged period.

### **Symbol Explanations**



**DISPOSAL:** Do not use household or municipal waste collection services for disposal of electrical and electronic equipment. EU countries require the use of separate recycling collection services.

## About this manual

This manual is intended for end users and describes how to install and operate the device. Wherever possible, relevant information—such as an illustration and its description—has been kept on one page. This printer-friendly format is both for your convenience and to help save paper, thereby protecting the environment. It is suggested that you only print sections that are relevant to your needs.

**Table of Contents**

**INTRODUCTION..... 1**

    INTRODUCTION ..... 1

    PARTS LIST ..... 2

    POINTRACER VIEWS ..... 3

**GETTING STARTED ..... 4**

    INSTALLING BATTERY ..... 4

    CHARGING BATTERY ..... 5

    POWERING ON YOUR DEVICE..... 5

**INSTALLATION..... 6**

    HARDWARE INSTALLATION ..... 6

*Connecting Hardware*..... 6

*Configuring Your Projector*..... 7

*Pairing Your Device* ..... 9

    DRIVER INSTALLATION..... 10

*System Requirements* ..... 10

*Installing Drivers*..... 10

*Confirming Installation*..... 10

**USING THE POINTRACER..... 11**

    OPERATING RANGE ..... 11

*Adjusting the Display*..... 11

    HOW TO HOLD THE INTERACTIVE PEN..... 12

*Pen Position*..... 12

*Remote Control Position*..... 13

    OPERATING THE POINTRACER ..... 13

**TROUBLESHOOTING ..... 14**

**REGULATORY COMPLIANCE ..... 15**

    FEDERAL COMMUNICATIONS COMMISSION INTERFERENCE STATEMENT ..... 15

    LABELING REQUIREMENTS ..... 15

    RF EXPOSURE WARNING ..... 15

# INTRODUCTION

## Introduction

The interactive pen enables you to turn any wall into an interactive area. The device connects wirelessly to your projector. Easy to install and setup, the PointRacer interactive pen is the affordable solution to help you engage and excite your audience with interactive presentations. With off-surface interactivity of up to 9m (29.5 feet), audience members can participate by writing on the projected area from their seats simply by using the PointRacer.

Interactive projection on virtually any surface — including dry-eraser boards, projector screens or even walls.

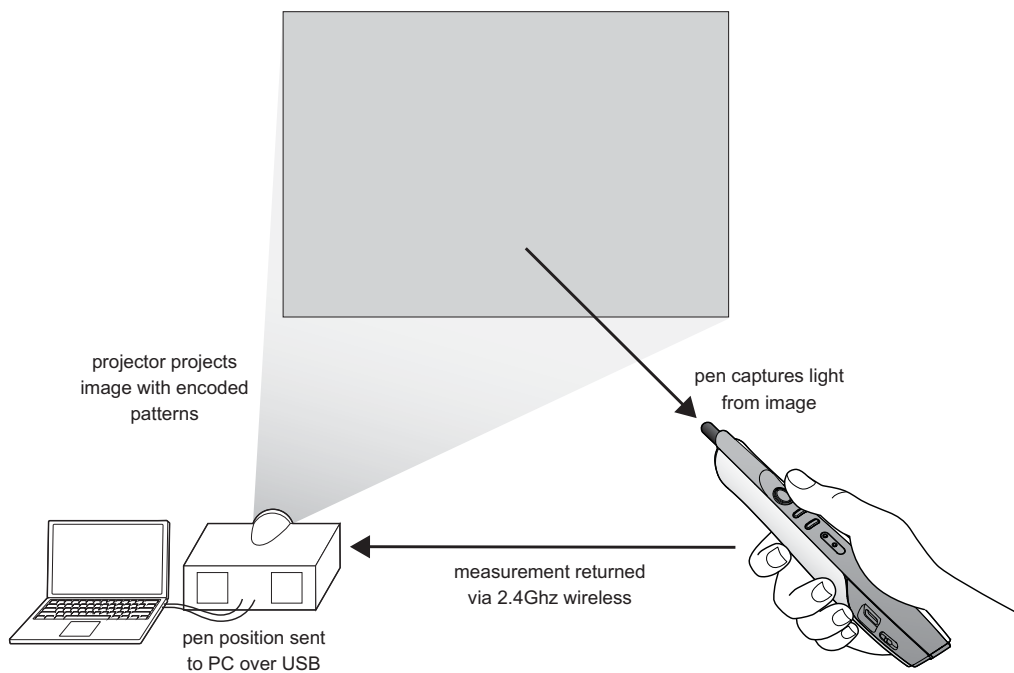

## Parts List

Carefully unpack the device and check that the following items are included:

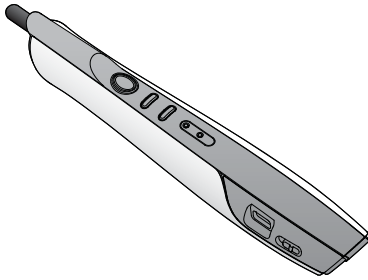

*DELTA POINTRACER*



*RECHARGEABLE BATTERY*

Contact your dealer immediately if any items are missing, appear damaged, or if the unit does not work. It is recommended that you keep the original packing material should you ever need to return the equipment for warranty service.

## PointRacer Views

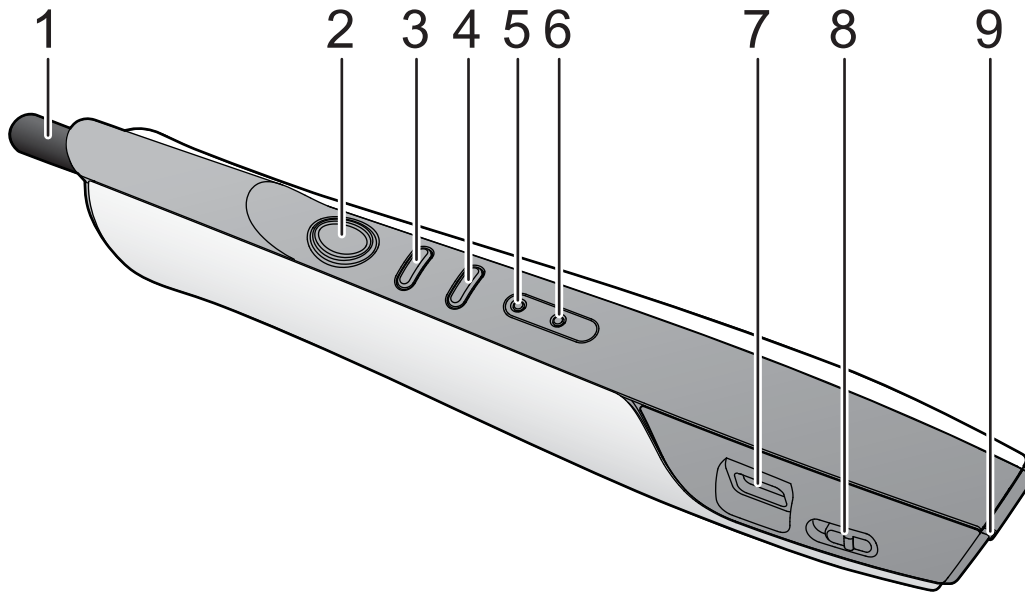

ITEM	LABEL	DESCRIPTION	
1.	PointRacer tip	Apply pressure to simulate a primary mouse button click.	
2.	Left button	Press to simulate a primary mouse button click.	
3.	Right button	Press to simulate a secondary mouse button click.	
4.	Pairing button	Press to pair with a projector.	
5.	Battery LED	Green	Charge the battery.
6.	Link LED	Green	Signal detection.
		Red	Data transmission.
7.	Mini USB socket	Connect a mini USB cable to charge rechargeable battery. <b>Note:</b> Only use rechargeable battery for USB charging function.	
8.	Power on switch	Turn the PointRacer on or off.	
9.	Battery holder	Insert battery to power the device.	

## GETTING STARTED

### Installing Battery

Turn the PointRacer off before proceeding.

1. Slide the battery compartment cover in the direction of the arrow to remove it.

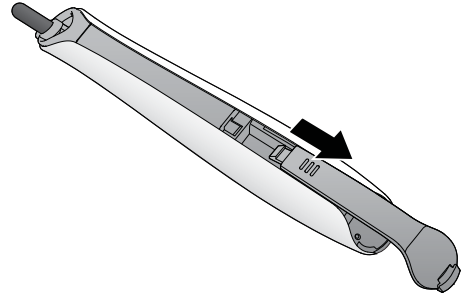

2. Install battery making sure they are positioned correctly, positive (+) to positive (+) and negative (-) to negative (-).

- AAA rechargeable battery

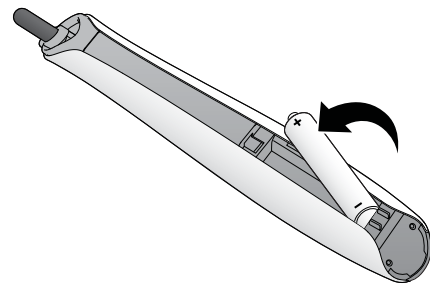

3. Replace the cover.

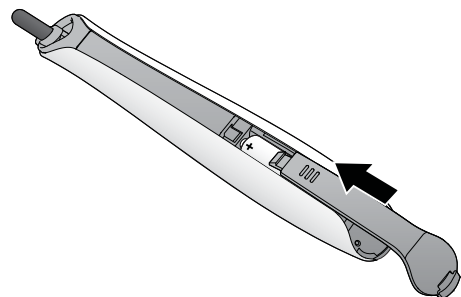

**Notes:**

1. Make sure to install the battery correctly, following the symbols showing the correct positive (+) and negative (-) polarity.
2. If not using the device for a long period of time, remove the battery to avoid damage or draining.



## Charging Battery

1. Connect a mini USB to your PointRacer
2. Connect the other end to a USB port.

**Important:**

*The PointRacer charges when the USB charging source is on and awake.*

**Caution:**

*Only use rechargeable battery to avoid damage.*

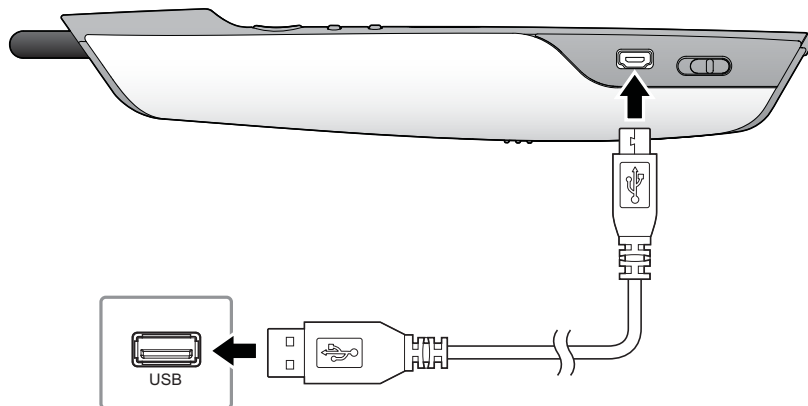

First time use requires a minimum of 3.5 hours for full charge.

## Powering On Your Device

Slide the power switch to turn on the PointRacer.

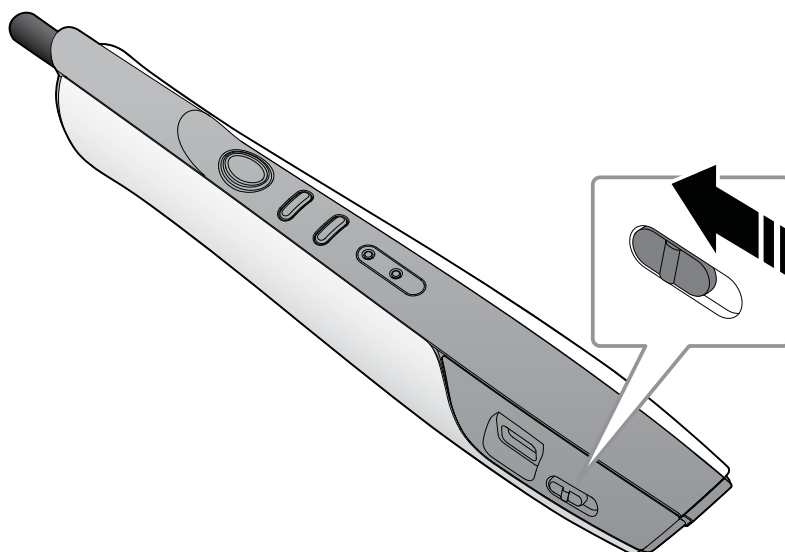

The computer identifies the PointRacer as a separate touch device. The installation process is completed in two stages:

- *First connect hardware*
- *Then install drivers*

Both stages require configuration of the hardware and software.

**Important:**

*You must install the driver for correct interactive functionality.*

## Hardware Installation

### Connecting Hardware

Interactive function requires connecting your projector to a computer.

Important: Do not connect or disconnect cables while your computer or projector is powered on. This can damage your device.

1. Turn off your devices.
2. Set up your projector. See your projector's User Manual.
3. Connect a media cable (HDMI / DVI / RGB) from the projector to the computer.
4. Connect a USB cable from the projector to the computer.

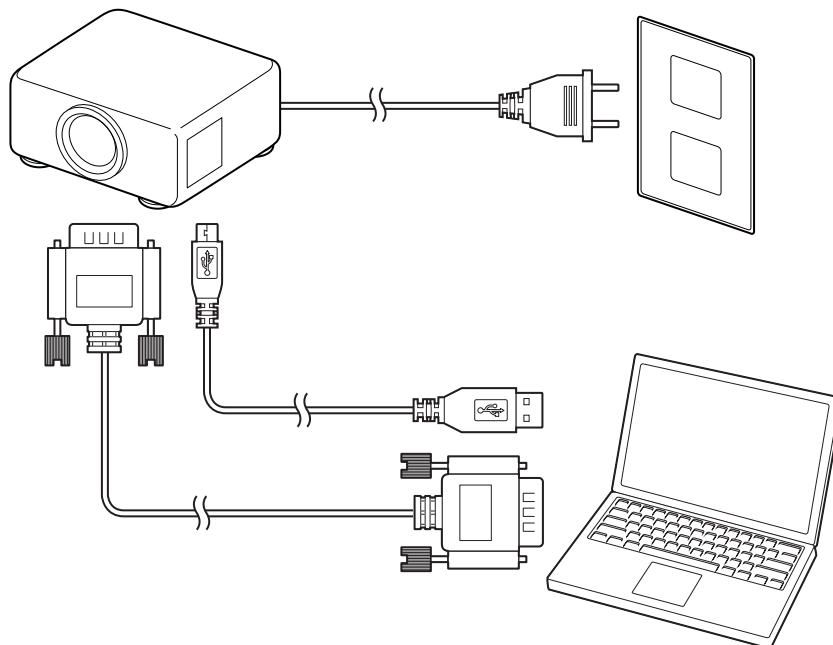

The hardware is connected. The PointRacer function must be enabled on your projector.

## Configuring Your Projector

After connecting the hardware, the PointRacer function must be enabled on your projector to allow for device pairing.

To enable PointRacer:

1. Turn on your projector.
2. Press **MENU** to display the **OSD** menu.
3. Press **◀▶** to **Installation I**.
4. Press **▲▼** to select **Advanced**.
5. Press **↵** (Enter) / **▶** to enter the **Advanced** sub menu.

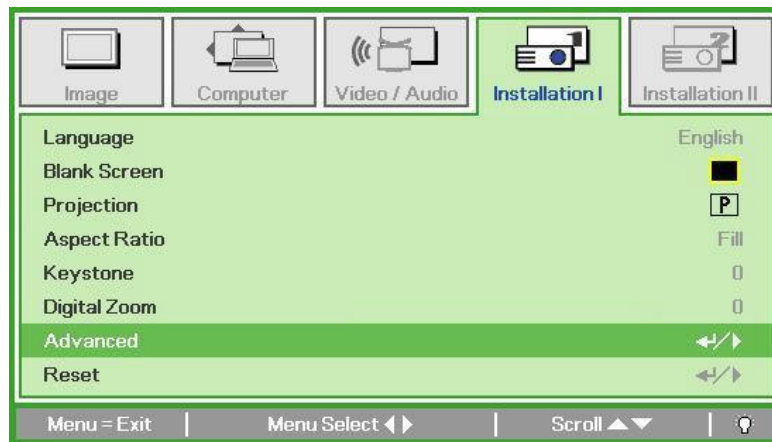

6. Press **▲▼** to move to **PointRacer** and press **↵** (Enter) / **▶** to enter.

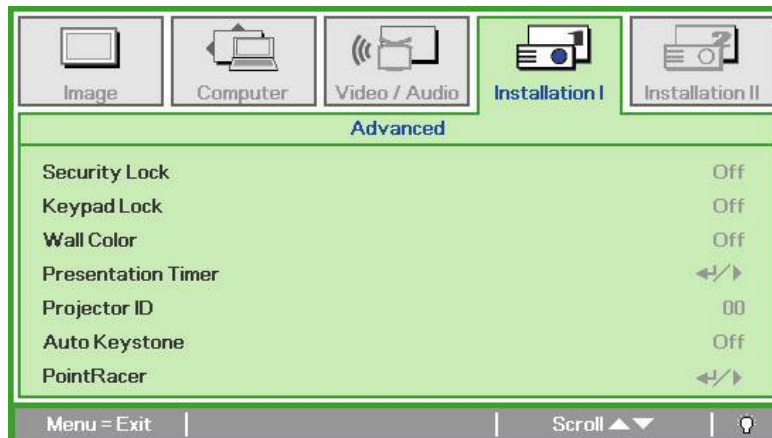

7. Press ◀▶ to turn On / Off **PointRacer**.

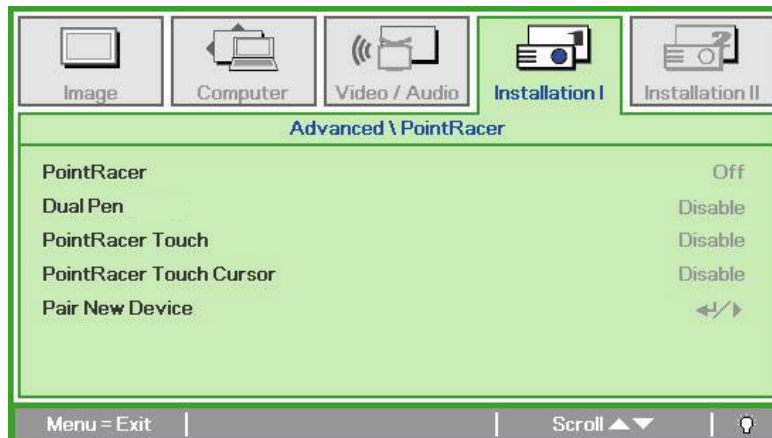

ITEM	DESCRIPTION
PointRacer	Press the cursor ◀▶ button to enable PointRacer.
Dual Pen	Press the cursor ◀▶ button to enable dual pen.
PointRacer Touch	Press the cursor ◀▶ button to enable touch function.
PointRacer Touch Cursor	Press the cursor ◀▶ button to display cursor on screen.
Pair New Device	Press ◀ (Enter) / ▶ to pair new pan.

**Note:**  
**PointRacer Touch** function is only supported on Windows 7 and later operating systems.

## Pairing Your Device

In this section, the PointRacer interactive pen is paired with the projector. The PointRacer function must first be enabled on the projector.

1. Turn on the **PointRacer**.
  - The Link LED blinks [green] and the interactive pen starts to search for a matching projector.
  - If a link is found the Link LED starts to blink and displays a solid red light when the connection is established.
2. Turn on the projector.
3. On the projector, navigate to **Installation I > Advanced > PointRacer**, press ▲ ▼ to **Pair New Device** and press ◀ (Enter) / ▶ to begin the process.

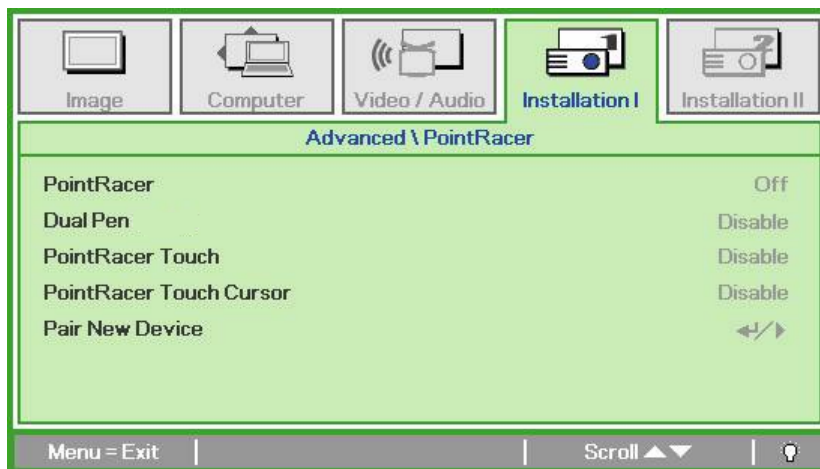

4. Press **Pair Matching** button for at least 3 seconds.

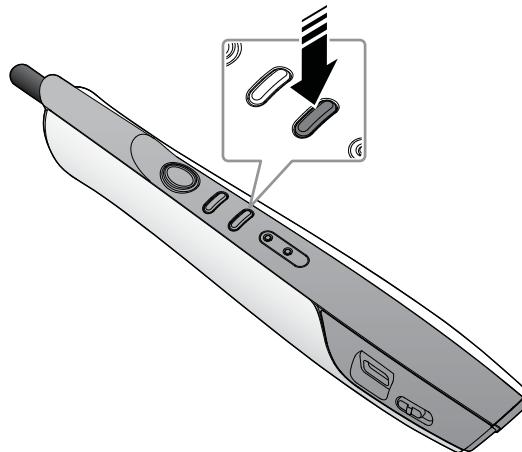

The PointRacer is paired with your projector.

**Note:**

1. First time use of a PointRacer device requires pairing to a projector.
2. PointRacer device retains settings for the last paired projector. To use with a different projector, you must pair the PointRacer to the new projector.

## Driver Installation

### System Requirements

Make sure your system meets the following minimum requirements:

- Windows 7 operating system
- DVI/VGA or HDMI connector

### Installing Drivers

1. Open a web browser and enter <http://www.microsoft.com/download/en/details.aspx?id=17368>.
2. Select the [touch-pack-web.exe] and press **CONTINUE**.
3. Once the file is downloaded, run the file to install.
4. Follow the on-screen prompts to finish installation.

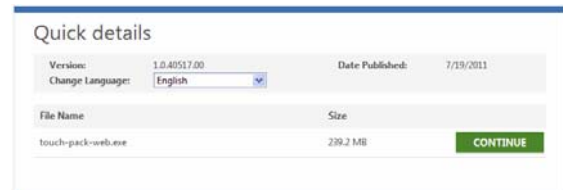

### Confirming Installation

Once hardware connection and the drivers are installed, you can confirm a successful installation by using the following information.

The projector, target computer, and PointRacer must be connected at this point. In addition, the PointRacer function must be enabled on the projector before proceeding.

1. Turn on your computer and boot up the operating system.
2. Navigate to **Control Panel > System Security > System**.
3. Under the System menu, Pen and Touch setting displays the available inputs.

Correct installation: Displays Touch Input Available

Incorrect installation: Displays No Pen or Touch Input is Available

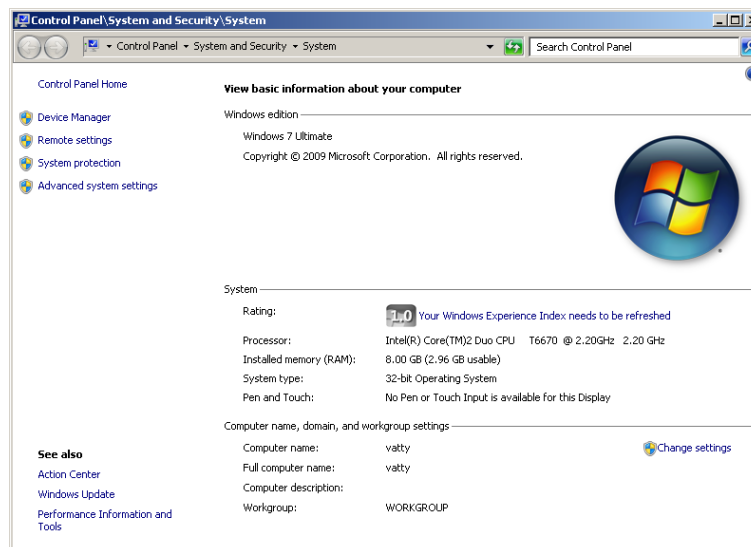

## **USING THE POINTRACER**

### **Operating Range**

The PointRacer uses scanning technology to detect the distance and projected image area. The scanning angle and distance are illustrated in the following figure.

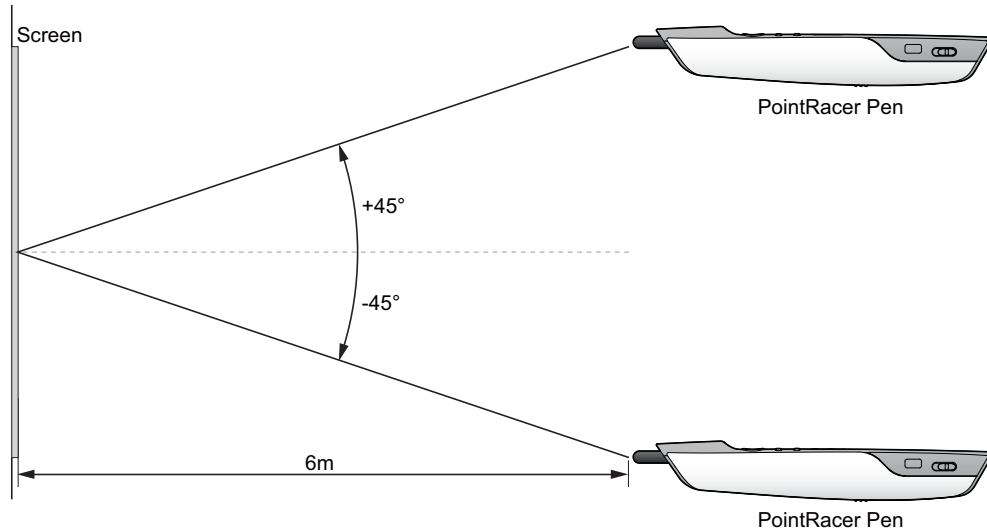

For best results, point the interactive pen directly at the screen without line of sight interference.

### *Adjusting the Display*

On-screen interference is caused when the image is blocked and shadows are created in the projected image. The PointRacer function requires direct scanning of the image. To avoid interference, adjust the projected image as suggested in the following.

## How to Hold the Interactive Pen

Hold the PointRacer in the similar way as you hold a pen/pencil or a remote control.

### Pen Position

You can control the screen functions by pushing the PointRacer tip to the screen. Alternatively, you can hold the tip with your finger instead of pushing the tip to the screen.

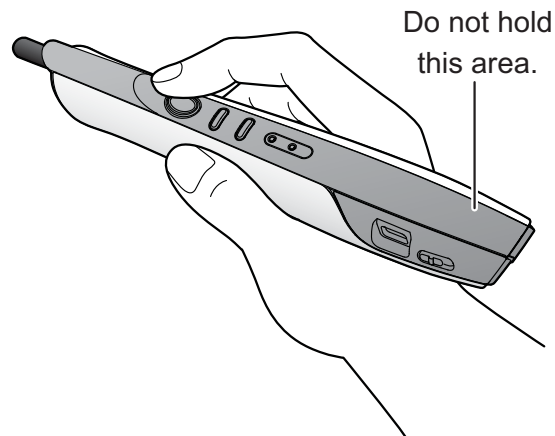

**Important:**

*Push the PointRacer tip diagonally to the screen. To avoid interference, do not push the tip vertically to the screen.*

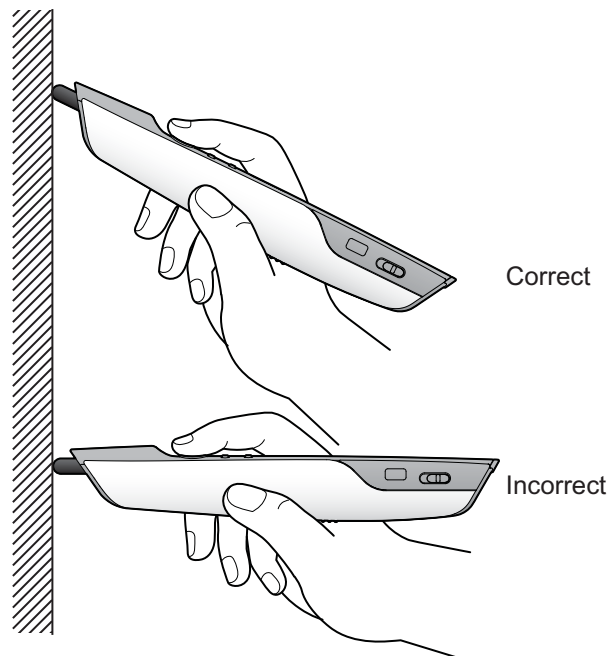



### Remote Control Position

You can control the screen functions by holding the PointRacer as a remote control to the screen.

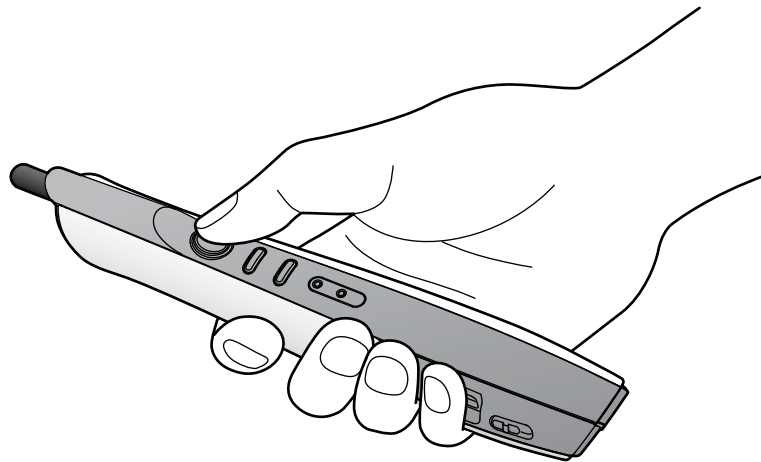

**Important:**

*The PointRacer does not function if the sensor tip is in a shadow or if pointing to a shadow.*

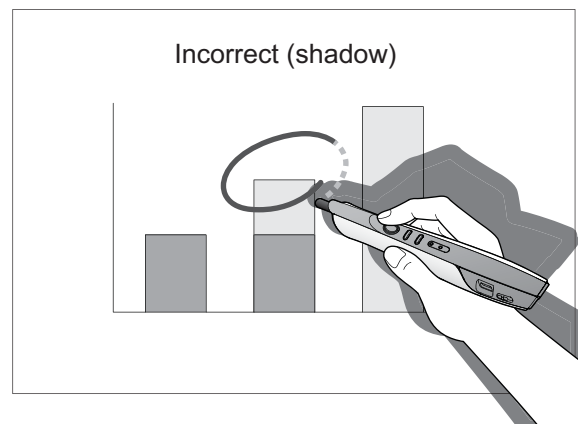
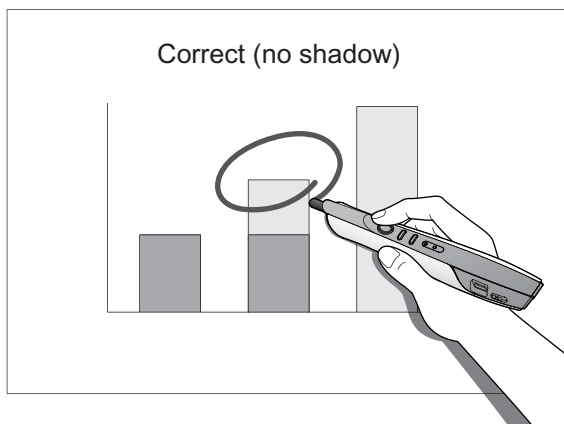

### Operating the PointRacer

You can operate the PointRacer by using the information as provided in the following table

BUTTON	DESCRIPTION
Tip	Hold the tip to simulate the left button of a mouse. Use this button to perform a left click operation.
Left Button	Hold this button to simulate the left button of a mouse. Use this button to perform a left click operation.
Right Button	Hold this button to simulate the right button of a mouse. Use this button to perform a right click operation.
Pairing Button	Hold this button down for at least 3 second to enter pairing mode. <b>Note:</b> To cancel pairing, switch off the PointRacer.

## **TROUBLESHOOTING**

<b>PROBLEM</b>	<b>SOLUTION</b>
The device does not work at all or sporadically.	<ul style="list-style-type: none"><li>• Direct the PointRacer towards the display screen.</li><li>• Ensure the path between the PointRacer and the display screen.</li><li>• Pair the PointRacer and the device again.</li><li>• Check the battery polarity.</li><li>• Replace battery and recharge again.</li></ul>
Click function does not work	Make sure to hold the buttons firmly while performing an operation.
Mouse pointer does not function smoothly or is restricted to an area.	<ul style="list-style-type: none"><li>• Make sure the device is not blocked by a shadow or pointing directly into a shadow.</li><li>• Make sure the projected image is not blocked, and there is no line-of-sight interference.</li></ul>

## **REGULATORY COMPLIANCE**

### **FEDERAL COMMUNICATIONS COMMISSION INTERFERENCE STATEMENT**

This equipment has been tested and found to comply with the limits for a Class B digital device, pursuant to part 15 of the FCC Rules. These limits are designed to provide reasonable protection against harmful interference in a residential installation. This equipment generates, uses and can radiate radio frequency energy and, if not installed and used in accordance with the instructions, may cause harmful interference to radio communications. However, there is no guarantee that interference will not occur in a particular installation. If this equipment does cause harmful interference to radio or television reception, which can be determined by turning the equipment off and on, the user is encouraged to try to correct the interference by one or more of the following measures:

- *Reorient or relocate the receiving antenna.*
- *Increase the separation between the equipment and receiver.*
- *Connect the equipment into an outlet on a circuit different from that to which the receiver is connected.*
- *Consult the dealer or an experienced radio/ TV technician for help.*

**CAUTION:**

*Any changes or modifications not expressly approved by the grantee of this device could void the user's authority to operate the equipment.*

### **Labeling requirements**

This device complies with Part 15 of the FCC Rules. Operation is subject to the following two conditions: (1) this device may not cause harmful interference, and (2) this device must accept any interference received, including interference that may cause undesired operation.

### **RF exposure warning**

The equipment complies with FCC RF exposure limits set forth for an uncontrolled environment.

The equipment must not be co-located or operating in conjunction with any other antenna or transmitter.