

Wireless Access Point

Cirrus™ AT-WA7400

Installation Guide

Copyright © 2005 Allied Telesyn, Inc.

All rights reserved. No part of this publication may be reproduced without prior written permission from Allied Telesyn, Inc.

Ethernet is a registered trademark of Xerox Corporation. All other product names, company names, logos or other designations mentioned herein are trademarks or registered trademarks of their respective owners.

Allied Telesyn, Inc. reserves the right to make changes in specifications and other information contained in this document without prior written notice. The information provided herein is subject to change without notice. In no event shall Allied Telesyn, Inc. be liable for any incidental, special, indirect, or consequential damages whatsoever, including but not limited to lost profits, arising out of or related to this manual or the information contained herein, even if Allied Telesyn, Inc. has been advised of, known, or should have known, the possibility of such damages.

Electrical Safety and Emissions Standards

Standards: This product meets the following standards.

U.S. Federal Communications Commission

Declaration of Conformity

Manufacturer Name: **Allied Telesyn, Inc.**
Declares that the product: **Wireless Access Point**
Model Numbers: **AT-WA7400**

This product complies with FCC Part 15B, Class B Limits:

This device complies with part 15 of the FCC Rules. Operation is subject to the following two conditions: (1) This device must not cause harmful interference, and (2) this device must accept any interference received, including interference that may cause undesired operation.

Radiated Energy

Note: This equipment has been tested and found to comply with the limits for a Class B digital device pursuant to Part 15 of FCC Rules. These limits are designed to provide reasonable protection against harmful interference in a residential installation. This equipment generates, uses and can radiate radio frequency energy and, if not installed and used in accordance with instructions, may cause harmful interference to radio or television reception, which can be determined by turning the equipment off and on. The user is encouraged to try to correct the interference by one or more of the following measures:

- Reorient or relocate the receiving antenna.
- Increase the separation between the equipment and the receiver.
- Connect the equipment into an outlet on a circuit different from that to which the receiver is connected.
- Consult the dealer or an experienced radio/TV technician for help.

Changes and modifications not expressly approved by the manufacturer or registrant of this equipment can void your authority to operate this equipment under Federal Communications Commission rules.

Industry Canada

This Class B digital apparatus meets all requirements of the Canadian Interference-Causing Equipment Regulations.

Cet appareil numérique de la classe B respecte toutes les exigences du Règlement sur le matériel brouilleur du Canada.

RFI Emissions	FCC Class B, EN55022 Class B, CTICK, CE
Immunity	EN55024
Electrical Safety	EN60950 (TUV), UL 60950 (CUL _{US})

Translated Safety Statements

Important: When you see the , go to the Allied Telesyn website www.alliedtelesyn.com for the translated safety statement in your language.

Contents

Electrical Safety and Emissions Standards	3
Translated Safety Statements	5
Preface	13
Safety Symbols Used in this Guide	14
Where to Find Web-based Guides	15
Contacting Allied Telesyn	16
Online Support	16
Email and Telephone Support.....	16
Returning Products.....	16
Sales or Corporate Information	16
Management Software Updates.....	16
Chapter 1: Overview	19
Features	20
Front and Back Panels	21
LEDs.....	22
Chapter 2: Installation	25
Reviewing Safety Precautions.....	26
Installation Guidelines	28
Microwave Ovens.....	28
Cordless Telephones	29
Other Access Points.....	29
Unpacking the Access Point.....	30
Installing the Antennas	31
Using the Access Point on a Desktop	33
Mounting an Access Point on a Wall.....	34
Mounting the Access Point on a Metal Surface.....	36
Connecting the Access Point to the LAN	37
Powering On the Access Point.....	38
Starting a Management Session	40

Contents

Warranty Registration.....	45
Chapter 3: Troubleshooting	47
Appendix A: Technical Specifications	49
Physical Specifications.....	49
Environmental Specifications	49
Power Specifications.....	49
Safety and Electromagnetic Emissions Certifications	49

Figures

Figure 1: AT-WA7400 Wireless Access Point	21
Figure 2: Front and Back Panels	21
Figure 3: Location of the Antenna Connectors	31
Figure 4: Attaching the Antennas	31
Figure 5: Attaching the Rubber Feet	33
Figure 6: Aligning the Access Point for Mounting on the Wall.....	35
Figure 7: Attaching the Magnets	36
Figure 8: Attaching the LAN Cable	37
Figure 9: Connecting the Power Adapter	38
Figure 10: PoE Connection	39
Figure 11: CD Main Menu	40
Figure 12: KickStart Welcome Dialog Box	41
Figure 13: KickStart Search Results Dialog Box	42
Figure 14: Administration Dialog Box	43
Figure 15: Login Dialog Box	43
Figure 16: Basic Settings Page	44

Figures

Tables

Table 1. Safety Symbols	14
Table 2. System LEDs	22
Table 3. LAN LEDs	22
Table 4. Wireless LEDs	23

Preface



This guide contains instructions on how to install the Cirrus™ AT-WA7400 Wireless Access Point. This preface contains the following sections:

- ❑ “Safety Symbols Used in this Guide” on page 14
- ❑ “Where to Find Web-based Guides” on page 15
- ❑ “Contacting Allied Telesyn” on page 16

Safety Symbols Used in this Guide

This document uses the safety symbols defined in Table 1.

Table 1. Safety Symbols

Symbol	Meaning	Description
	Caution	Performing or omitting a specific action may result in equipment damage or loss of data.
	Warning	Performing or omitting a specific action may result in electrical shock.

Where to Find Web-based Guides

The installation and user guides for all Allied Telesyn products are available in portable document format (PDF) on our web site at **www.alliedtelesyn.com**. You can view the documents online or download them onto a local workstation or server.

Contacting Allied Telesyn

This section provides Allied Telesyn contact information for technical support as well as sales and corporate information.

Online Support

You can request technical support online by accessing the Allied Telesyn Knowledge Base: **<http://kb.alliedtelesyn.com>**. You can use the Knowledge Base to submit questions to our technical support staff and review answers to previously asked questions.

Email and Telephone Support

For Technical Support via email or telephone, refer to the Support & Services section of the Allied Telesyn web site:
www.alliedtelesyn.com.

Returning Products

Products for return or repair must first be assigned a return materials authorization (RMA) number. A product sent to Allied Telesyn without an RMA number will be returned to the sender at the sender's expense.

To obtain an RMA number, contact Allied Telesyn Technical Support through our web site: **www.alliedtelesyn.com**.

Sales or Corporate Information

You can contact Allied Telesyn for sales or corporate information through our web site: www.alliedtelesyn.com. To find the contact information for your country, select Contact Us -> Worldwide Contacts.

Management Software Updates

New releases of management software for our managed products are available from either of the following Internet sites:

- Allied Telesyn web site: **www.alliedtelesyn.com**
- Allied Telesyn FTP server: **<ftp://ftp.alliedtelesyn.com>**

If you prefer to download new software from the Allied Telesyn FTP server from your workstation's command prompt, you will need FTP client software and you must log in to the server. Enter "anonymous" for the user name and your email address for the password.

Chapter 1

Overview

The Cirrus™ AT-WA7400 Wireless Access Point is a wireless communications hub for devices on your network. It provides continuous, high-speed access between your wireless and Ethernet devices. You administer the AT-WA7400 Wireless Access Point using the AT-WA7400 management software.

This chapter contains the following sections:

- ❑ “Features” on page 20
- ❑ “Front and Back Panels” on page 21
- ❑ “LEDs” on page 22

Features

The features of the AT-WA7400 Wireless Access Point include:

- High performance 108 Mbps (802.11g - 802.11a with upgrade) data rate
- Security support via 802.11i (WPA2), WPA-PSK, TKIP, AES, IEEE 802.1x, and EAP/802.1
- Multiple BSSID and Virtual LAN (VLANs)
- Inhibit SSID broadcast and Ignore SSID scan
- MAC Access Control for wireless interface
- Load balancing
- 802.11e (WMM only)
- Wireless Distribution System (WDS) for Wireless Bridge Mode supported
- AP clustering
- Rogue AP detection
- Transmit power control/limiting
- Power over Ethernet (PoE) capable
- Two radios and two antennas (to activate the second radio, a firmware upgrade is required)
- One 10/100 Fast Ethernet port with auto-negotiation, and auto MDI/MDIX, back pressure, and flow control

Front and Back Panels

Figure 1 shows the AT-WA7400 Wireless Access Point.



Figure 1. AT-WA7400 Wireless Access Point

Figure 2 shows the front and back panels of the wireless access point.

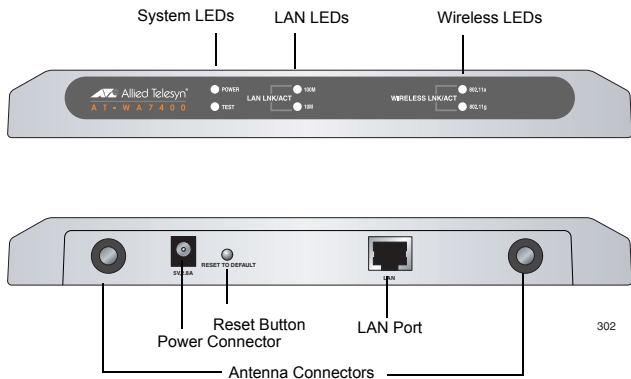

Figure 2. Front and Back Panels

LEDs

The system LEDs on the AT-WA7400 Wireless Access Point are described in Table 2.

Table 2. System LEDs

LED	State	Description
Power	Off	The access point is not receiving power.
	Green	The access point is receiving power.
Test	Off	No system maintenance in progress.
	Amber	System startup or maintenance in progress.

The LAN LEDs are described in Table 3.

Table 3. LAN LEDs

LED	State	Description
LNK/ACT (100M)	On	The access point is operating at 100 Mbps.
	Off	The access point is not operating at 100 Mbps.
	Blinking	The access point is sending or receiving data at 100 Mbps.
LNK/ACT (10 M)	On	The access point is operating at 10 Mbps.
	Off	The access point is not operating at 10 Mbps.

Table 3. LAN LEDs (Continued)

LED	State	Description
	Blinking	The access point is sending or receiving data at 10 Mbps.

The Wireless LEDs are described in Table 4.

Table 4. Wireless LEDs

LED	State	Description
LNK/ACT (WLAN a)	Off	No link is detected.
	Green	An 802.11a WLAN link has been made.
	Blinking Green	Network activity is occurring.
LNK/ACT (WLAN g)	Off	No link is detected.
	Green	An 802.11g WLAN link has been made.
	Blinking Green	Network activity is occurring.

Chapter 2

Installation

This chapter contains the following sections:

- ❑ “Reviewing Safety Precautions” on page 26
- ❑ “Installation Guidelines” on page 28
- ❑ “Unpacking the Access Point” on page 30
- ❑ “Installing the Antennas” on page 31
- ❑ “Using the Access Point on a Desktop” on page 33
- ❑ “Mounting an Access Point on a Wall” on page 34
- ❑ “Mounting the Access Point on a Metal Surface” on page 36
- ❑ “Powering On the Access Point” on page 38
- ❑ “Starting a Management Session” on page 40
- ❑ “Warranty Registration” on page 45

Reviewing Safety Precautions

Please review the following safety precautions before you begin to install the AT-WA7400 Wireless Access Point.

Note

When you see the , go to the Allied Telesyn web site for translated safety statements.





Warning: To prevent electric shock, do not remove the cover. No user-serviceable parts inside. This unit contains hazardous voltages and should only be opened by a trained and qualified technician. To avoid the possibility of electric shock, disconnect electric power to the product before connecting or disconnecting the LAN cables. 





Warning: Do not work on equipment or cables during periods of lightning activity. 



Warning: Power cord is used as a disconnection device. To de-energize equipment, disconnect the power cord. 

Pluggable Equipment. The socket outlet shall be installed near the equipment and shall be easily accessible. 

Warning: Operating Temperature. This product is designed for a maximum ambient temperature of 40° degrees C. 

All Countries: Install product in accordance with local and National Electrical Codes. 



Caution: Do not install in direct sunlight, or a damp or dusty place. 18

Installation Guidelines

Allied Telesyn recommends that you have an Allied Telesyn-certified RF specialist conduct a site survey to determine the ideal locations for all your Allied Telesyn wireless network devices. To conduct a proper site survey, you need to have special equipment and training.

The following general practices should be followed in any installation:

- Locate access points centrally within areas requiring coverage.
- Overlap access point radio coverage areas to avoid coverage holes.
- Position the access point so that its LEDs are visible. The LEDs are useful for troubleshooting.
- Install wired LAN cabling within node limit and cable length limitations.
- Use an uninterruptible power supply (UPS) when AC power is not reliable.

Proper antenna placement can help improve range. For information about antenna options, contact your local Allied Telesyn representative.

When determining ideal locations for the access points, be aware that you may see network performance degradation from microwave ovens, cordless telephones, and other access points. For more information, see the next sections.

Note

Microwave ovens, cordless telephones, and other access points do not degrade the network performance of the 802.11a radio.

Microwave Ovens

Microwave ovens operate in the same frequency band as 802.11g and 802.11b radios; therefore, if you use a microwave oven within range of your wireless network, you may notice network performance degradation. Both your microwave oven and your wireless network will continue to function, but you may want to consider relocating your

microwave oven out of range of your access point.

Cordless Telephones

If you have an 802.11g or 802.11b radio in your access point, the radio may experience interference from some cordless telephones. For optimal performance, consider operating cordless telephones out of range of your access points.

Other Access Points

Access points that are configured for the same frequency and that are in the same radio coverage area may interfere with each other and decrease throughput. You can reduce the chance of interference by configuring access points at least five channels apart, such as channels 1, 6, and 11.

Unpacking the Access Point

To unpack the AT-WA7400 Wireless Access Point, perform the following procedure:

1. Remove all components from the shipping package.

Note

Store the packing material in a safe location. You must use the original shipping material if you need to return the unit to Allied Telesyn.

2. Place the access point on a secure, level surface.
3. Ensure that the following hardware components are included in your access point package. If any item is missing or damaged, contact your Allied Telesyn sales representative for assistance.
 - One AT-WA7400 Wireless Access Point
 - Two antennas
 - One wall mount kit containing two wall anchors and two screws
 - One AC adapter
 - One RJ45 management cable
 - Four rubber feet
 - One magnet kit containing four magnets and four screws
 - One documentation CD with KickStart utility
 - This installation guide
 - Warranty card

Installing the Antennas

To install the antennas, perform the following procedure:

1. Remove the antennas from their package.
2. Locate the antenna connectors in the back of the AT-WA7400 Wireless Access Point, as shown in Figure 3.

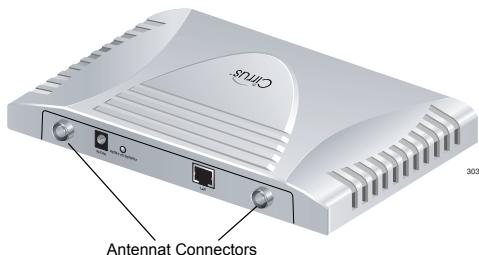

Figure 3. Location of the Antenna Connectors

3. Screw one antenna into each antenna connector, as shown in Figure 4.



Figure 4. Attaching the Antennas

You can point the antennas in the direction that provides the best signal strength.

Using the Access Point on a Desktop

You can place the AT-WA7400 Wireless Access Point on a desktop or other flat surface.

To place the AT-WA7400 Wireless Access Point on a desktop, perform the following procedure:

1. Turn the access point over so that the top is resting on a flat surface.
2. Attach the four rubber feet to the bottom of the access point as shown in Figure 5.

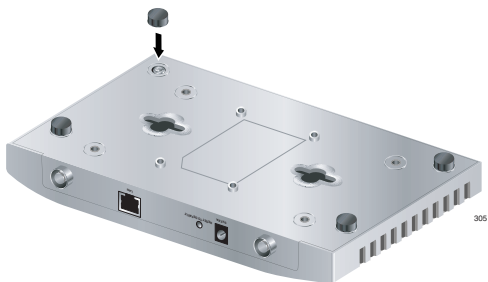

Figure 5. Attaching the Rubber Feet

3. Turn the access point over and place it on a flat, secure surface such as a desk or table, leaving ample space around the unit for ventilation.

Mounting an Access Point on a Wall

To mount the AT-WA7400 Wireless Access Point on a wall, perform the following procedure:

1. Select a wall location and mark two hole locations for the anchors 98.425 mm (3.875 in.) apart.
2. At the two marked hole locations, pre-drill for the drywall anchors.
3. Install the anchors and drive the screws into the anchors leaving approximately 4.76 mm (.1875 in.) exposed.

- Align the keyholds on the back with the screw heads, as shown in Figure 6.

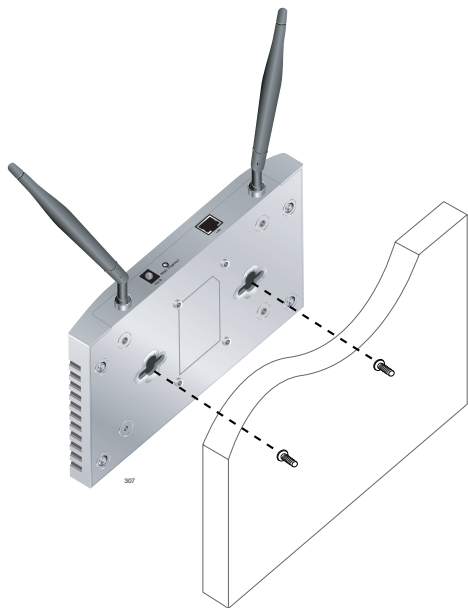

Figure 6. Aligning the Access Point for Mounting on the Wall

- Place the keyhole slots on the bottom of the access point over the screw heads.
- Slide the access point down onto the screw heads so that the access point is securely mounted on the wall.

You can install the access point either horizontally or vertically.

Connecting the Access Point to the LAN

To connect the AT-WA7400 Wireless Access Point to the LAN, perform the following procedure:

1. Locate the RJ45 cable in the box.
2. Connect one end of the cable to the LAN.
3. Connect the other end of the cable to the LAN port on the back of the access point, as shown in Figure 8.



Figure 8. Attaching the LAN Cable

Powering On the Access Point

To power on the access point, perform the following procedure:

1. Do one of the following:



Warning: Do not work on equipment or cables during periods of lightning activity. *4*



Warning: Power cord is used as a disconnection device. To de-energize equipment, disconnect the power cord. *5*

- a. Plug the power cord on the adapter into the power connector on the back panel, as shown in Figure 9, and plug the power adapter into a wall outlet.



Figure 9. Connecting the Power Adapter

- b.

- c. Plug a LAN cable from a unit that supports PoE into the LAN port, as shown in Figure 10. No other power connection is required.



Figure 10. PoE Connection

2. Verify that the POWER LED is green. If the LED is off, refer to Chapter 3, "Troubleshooting" on page 47.

The access point is now powered on and ready for network operation.

Starting a Management Session

To start a management session on the AT-WA7400 Wireless Access Point, perform the following procedure:

1. Do one of the following to create an Ethernet connection between the access point and your computer:
 - Connect one end of an Ethernet cable to the LAN port on the access point and the other end to the same hub where your PC is connected.
 - Connect one end of an Ethernet cable to the LAN port on the access point and the other end of the cable to the Ethernet port on the your PC.
2. Insert the **AT-WA7400 Wireless Access Point** CD into the CD-ROM drive on your computer.

The CD starts up and displays a menu, as shown in Figure 11.

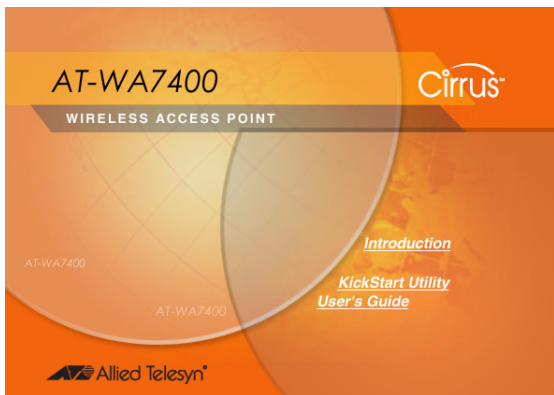

Figure 11. CD Main Menu

3. Click **KickStart Utility**.

The Kickstart Welcome dialog box is displayed, as shown in Figure 12.

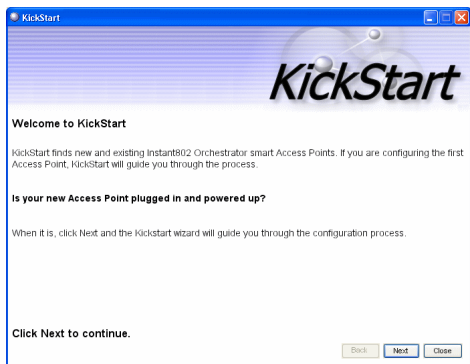

Figure 12. KickStart Welcome Dialog Box

4. Click **Next** to search for access points.

Wait for the search to complete, or until KickStart has found your new access points, as shown in Figure 13..

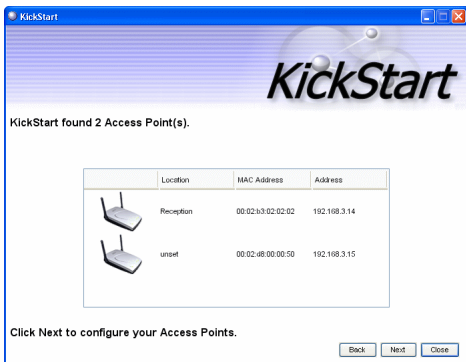

Figure 13. KickStart Search Results Dialog Box

Note

The KickStart utility only finds other AT-WA7400 Wireless Access Points.

If KickStart does not find the AT-WA7400 Wireless Access Point you just installed, an informational window is displayed with troubleshooting information about your LAN and power connections.

5. Review the list of access points that KickStart found, as shown in the example in Figure 13.

The access points are listed with their location, MAC address, and IP address.

6. Verify the MAC address shown with the hardware label on your AT-WA7400 Wireless Access Point(s).

7. Click **Next**.

The Administration dialog box opens, as shown in Figure 14.

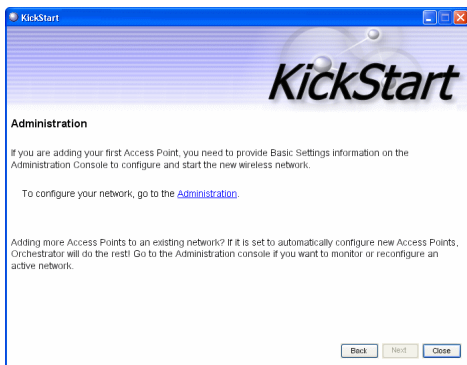

Figure 14. Administration Dialog Box

8. Click **Administration**.

You are prompted for a user name and password, as shown in Figure 15.



Figure 15. Login Dialog Box

The default user name is “manager” and the default password is “friend.”

9. Enter the user name and password and click **OK**.

The Basic Settings page opens, as shown in Figure 16.

BASIC SETTINGS

Provide basic settings

CLUSTER

- Access Point
- User Management
- Sessions
- Channel Management
- Wireless Neighborhood

STATUS

- Interfaces
- Events
- Transmit / Receive Statistics
- Client Associations
- Neighboring Access Points

ADVANCED

- Ethernet (Wired) Settings
- Wireless Settings
- Security
- Guest Login
- Radio
- MAC Filtering
- Load Balancing
- Quality of Service
- Wireless Distribution System
- Time Protocol
- Basic Configuration
- Upgrade
- Backup/Restore

Review Description of this Access Point ...

These fields show information specific to this access point.

IP Address: 10.10.103.214
 MAC Address: 00-90-27-1d-40-90
 Firmware Version: dkaehn
 Location: not set

Provide Network Settings ...

These settings apply to this access point. The same settings will apply to new access points joining the cluster if the policy for adding new access points is set to "configure automatically".

Current Password:
 New Password:
 Confirm New Password:
 Network Name (SSID): Internal-Isidor@02-Network

Set Configuration Policy for New Access Points ...

If you choose "configure automatically" as the policy for adding new access points, new access points will join the cluster when they are powered up and inherit the settings specified on this page. (If you choose to ignore new access points, you must configure them manually.)

New Access Points: are configured automatically

Settings ...

Click "update" to save the new settings.

Clustered

1 Access Point

4 User Accounts

?

For a typical access point which is a member of a cluster, provide the minimal set of configuration information needed to set up the access point and start wireless networking as described in the numbered steps on this page.

For a standalone access point the Basic Settings page indicates only that the current mode is standalone and provides a button for adding the access point to a cluster (group). If you click on any of the Cluster tabs for an AP in standalone mode you will be redirected to this Basic Settings page because Cluster settings do not apply to standalone APs.

Caution: If you do not have a DHCP server on the internal network and do not plan to use one, the first thing you must do after bringing up the access point is change the Connection Type from DHCP to Static IP.

To change the Connection Type, go to the **Ethernet (Wired) Settings** tab.

[More...](#)

Figure 16. Basic Settings Page

Refer to the *AT-WA7400 Management Software User's Guide* for information about how to configure the basic settings.

Warranty Registration

After installing your access point, you can register your product by completing the enclosed warranty card and sending it to Allied Telesyn,'

Chapter 3

Troubleshooting

If the AT-WA7400 Wireless Access Point is not operating correctly, do one of the following:

- ❑ Press the Reset to Default button once to reboot the access point. You can also reset the access point through the AT-S77 management software. See Chapter 20, “Maintenance and Monitoring” in the *AT-WA7400 Management Software User’s Guide*.
- ❑ Hold in the Reset to Default button for more than five seconds to restore the factory default settings. You can also restore the factory default settings through the AT-S77 management software. See Chapter 20, “Maintenance and Monitoring” in the *AT-WA7400 Management Software User’s Guide*.

Appendix A

Technical Specifications

Physical Specifications

Dimensions:	176.34 mm x 103.62 mm x 23.20 mm (W x D x H) (6.94 in. x 4.07 in. x .91 in.)
Weight:	250 g (8.81 oz.)

Environmental Specifications

Operating Temperature:	0 to 85°C
Storage Temperature:	-20 to 70°C
Operating Humidity:	10 to 90% noncondensing
Storage Humidity:	10 to 95% noncondensing
Operating Altitude Range:	3,000 m

Power Specifications

Input Supply Voltage:	Power over Ethernet or 5 VDC/2.8 A DC adapter
Power Consumption:	5.75 W (max.)

Safety and Electromagnetic Emissions Certifications

EMI/RFI:	EN 55022/CISPR 22 Class B; FCC Part 15 Class B, FCC Part 15B, 15C, and 15E; EN 301 893; EN 300 328; EN 301 489 Transmitter EMC
----------	--

Appendix A: Technical Specifications

Immunity:	Canada IC; CE Mark; CE Marked, compliant with RTT&E, EMC, LVD Directives; C-Tick
Electrical Safety:	UL 1950/C22.2#950 IEC; TUV; EN 60950; EN 60593-IP53

Federal Communication Commission Interference Statement

This equipment has been tested and found to comply with the limits for a Class B digital device, pursuant to Part 15 of the FCC Rules. These limits are designed to provide reasonable protection against harmful interference in a residential installation. This equipment generates, uses and can radiate radio frequency energy and, if not installed and used in accordance with the instructions, may cause harmful interference to radio communications. However, there is no guarantee that interference will not occur in a particular installation. If this equipment does cause harmful interference to radio or television reception, which can be determined by turning the equipment off and on, the user is encouraged to try to correct the interference by one of the following measures:

- Reorient or relocate the receiving antenna.
- Increase the separation between the equipment and receiver.
- Connect the equipment into an outlet on a circuit different from that to which the receiver is connected.
- Consult the dealer or an experienced radio/TV technician for help.

This device complies with Part 15 of the FCC Rules. Operation is subject to the following two conditions: (1) This device may not cause harmful interference, and (2) this device must accept any interference received, including interference that may cause undesired operation.

FCC Caution: Any changes or modifications not expressly approved by the party responsible for compliance could void the user's authority to operate this equipment.

IMPORTANT NOTE: FCC Radiation Exposure Statement:

This equipment complies with FCC radiation exposure limits set forth for an uncontrolled environment. This equipment should be installed and operated with minimum distance 20cm between the radiator & your body. To maintain compliance with FCC RF exposure compliance requirements, please avoid direct contact to the transmitting antenna during transmitting.

If this device is going to be operated in 5.15 ~ 5.25GHz frequency range, then it is restricted in indoor environment only.

This transmitter must not be co-located or operating in conjunction with any other antenna or transmitter.

Delta Networks, Inc. declares that the AT-WA7400 (FCC ID: PD5WA7400) is limited in CH1-CH11 by specified firmware controlled in the USA.

Canada-Industry Canada(IC)

Operation is subject to the following two conditions: 1) this device may not cause interference and 2) this device must accept any interference, including interference that may cause undesired operation of the device.

This device has been designed to operate with an antenna having a maximum gain of 2.8 dBi. Antenna having a higher gain is strictly prohibited per regulations of Industry Canada. The required antenna impedance is 50 ohms.