

UNISAW® 10" Right Tilting Arbor Saw (Models 34-801, 34-806, 34-814, 36-812)

INSTRUCTION MANUAL



PART NO. 422-04-651-0064 - 06-20-05
Copyright © 2005 Delta Machinery

 **DELTA® INDUSTRIAL**

To learn more about DELTA MACHINERY
visit our website at: www.deltamachinery.com.

For Parts, Service, Warranty or other Assistance,

please call **1-800-223-7278** (In Canada call **1-800-463-3582**).



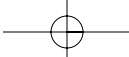

TABLE OF CONTENTS

IMPORTANT SAFETY INSTRUCTIONS2
SAFETY GUIDELINES3
GENERAL SAFETY RULES4
ADDITIONAL SPECIFIC SAFETY RULES5
FUNCTIONAL DESCRIPTION6
CARTON CONTENTS6
ASSEMBLY8
OPERATION15
TROUBLESHOOTING25
MAINTENANCE25
SERVICE26
ACCESSORIES26
WARRANTY27
SERVICE CENTER LOCATIONSback cover

IMPORTANT SAFETY INSTRUCTIONS

▲ WARNING Read and understand all warnings and operating instructions before using any tool or equipment. When using tools or equipment, basic safety precautions should always be followed to reduce the risk of personal injury. Improper operation, maintenance or modification of tools or equipment could result in serious injury and property damage. There are certain applications for which tools and equipment are designed. Delta Machinery strongly recommends that this product NOT be modified and/or used for any application other than for which it was designed.

If you have any questions relative to its application DO NOT use the product until you have written Delta Machinery and we have advised you.

Online contact form at www.deltamachinery.com

Postal Mail: Technical Service Manager
Delta Machinery
4825 Highway 45 North
Jackson, TN 38305
(IN CANADA: 125 Mural St. Suite 300, Richmond Hill, ON, L4B 1M4)

Information regarding the safe and proper operation of this tool is available from the following sources:

Power Tool Institute
1300 Sumner Avenue, Cleveland, OH 44115-2851
www.powertoolinstitute.org

National Safety Council
1121 Spring Lake Drive, Itasca, IL 60143-3201

American National Standards Institute, 25 West 43rd Street, 4 floor, New York, NY 10036 www.ansi.org
ANSI 01.1 Safety Requirements for Woodworking Machines, and

the U.S. Department of Labor regulations www.osha.gov

SAVE THESE INSTRUCTIONS!

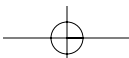

SAFETY GUIDELINES - DEFINITIONS

It is important for you to read and understand this manual. The information it contains relates to protecting YOUR SAFETY and PREVENTING PROBLEMS. The symbols below are used to help you recognize this information.



▲ DANGER Indicates an imminently hazardous situation which, if not avoided, will result in death or serious injury.

▲ WARNING Indicates a potentially hazardous situation which, if not avoided, could result in death or serious injury.

▲ CAUTION Indicates a potentially hazardous situation which, if not avoided, may result in minor or moderate injury.

CAUTION Used without the safety alert symbol indicates potentially hazardous situation which, if not avoided, may result in property damage.

CALIFORNIA PROPOSITION 65

▲ WARNING **SOME DUST CREATED BY POWER SANDING, SAWING, GRINDING, DRILLING, AND OTHER CONSTRUCTION ACTIVITIES** contains chemicals known to cause cancer, birth defects or other reproductive harm.

Some examples of these chemicals are:

- lead from lead-based paints,
- crystalline silica from bricks and cement and other masonry products, and
- arsenic and chromium from chemically-treated lumber.

Your risk from these exposures varies, depending on how often you do this type of work. To reduce your exposure to these chemicals: work in a well ventilated area, and work with approved safety equipment, always wear **NIOSH/OSHA** approved, properly fitting face mask or respirator when using such tools.

GENERAL SAFETY RULES



▲ WARNING READ AND UNDERSTAND ALL WARNINGS AND OPERATING INSTRUCTIONS BEFORE USING THIS EQUIPMENT. Failure to follow all instructions listed below, may result in electric shock, fire, and/or serious personal injury or property damage.

IMPORTANT SAFETY INSTRUCTIONS

1. **FOR YOUR OWN SAFETY, READ THE INSTRUCTION MANUAL BEFORE OPERATING THE MACHINE.** Learning the machine's application, limitations, and specific hazards will greatly minimize the possibility of accidents and injury.
2. **WEAR EYE AND HEARING PROTECTION. ALWAYS USE SAFETY GLASSES.** Everyday eyeglasses are NOT safety glasses. USE CERTIFIED SAFETY EQUIPMENT. Eye protection equipment should comply with ANSI Z87.1 standards. Hearing equipment should comply with ANSI S3.19 standards.
3. **WEAR PROPER APPAREL.** Do not wear loose clothing, gloves, neckties, rings, bracelets, or other jewelry which may get caught in moving parts. Nonslip footwear is recommended. Wear protective hair covering to contain long hair.
4. **DO NOT USE THE MACHINE IN A DANGEROUS ENVIRONMENT.** The use of power tools in damp or wet locations or in rain can cause shock or electrocution. Keep your work area well-lit to prevent tripping or placing arms, hands, and fingers in danger.
5. **MAINTAIN ALL TOOLS AND MACHINES IN PEAK CONDITION.** Keep tools sharp and clean for best and safest performance. Follow instructions for lubricating and changing accessories. Poorly maintained tools and machines can further damage the tool or machine and/or cause injury.
6. **CHECK FOR DAMAGED PARTS.** Before using the machine, check for any damaged parts. Check for alignment of moving parts, binding of moving parts, breakage of parts, and any other conditions that may affect its operation. A guard or any other part that is damaged **should be properly repaired or replaced.** Damaged parts can cause further damage to the machine and/or injury.
7. **KEEP THE WORK AREA CLEAN.** Cluttered areas and benches invite accidents.
8. **KEEP CHILDREN AND VISITORS AWAY.** Your shop is a potentially dangerous environment. Children and visitors can be injured.
9. **REDUCE THE RISK OF UNINTENTIONAL STARTING.** Make sure that the switch is in the "OFF" position before plugging in the power cord. In the event of a power failure, move the switch to the "OFF" position. An accidental start-up can cause injury.
10. **USE THE GUARDS.** Check to see that all guards are in place, secured, and working correctly to reduce the risk of injury.
11. **REMOVE ADJUSTING KEYS AND WRENCHES BEFORE STARTING THE MACHINE.** Tools, scrap pieces, and other debris can be thrown at high speed, causing injury.
12. **USE THE RIGHT MACHINE.** Don't force a machine or an attachment to do a job for which it was not designed. Damage to the machine and/or injury may result.
13. **USE RECOMMENDED ACCESSORIES.** The use of accessories and attachments not recommended by Delta may cause damage to the machine or injury to the user.
14. **USE THE PROPER EXTENSION CORD.** Make sure your extension cord is in good condition. When using an extension cord, be sure to use one heavy enough to carry the current your product will draw. An undersized cord will cause a drop in line voltage, resulting in loss of power and overheating. See the Extension Cord Chart for the correct size depending on the cord length and nameplate ampere rating. If in doubt, use the next heavier gauge. The smaller the gauge number, the heavier the cord.
15. **SECURE THE WORKPIECE.** Use clamps or a vise to hold the workpiece when practical. Loss of control of a workpiece can cause injury.
16. **FEED THE WORKPIECE AGAINST THE DIRECTION OF THE ROTATION OF THE BLADE, CUTTER, OR ABRASIVE SURFACE.** Feeding it from the other direction will cause the workpiece to be thrown out at high speed.
17. **DON'T FORCE THE WORKPIECE ON THE MACHINE.** Damage to the machine and/or injury may result.
18. **DON'T OVERREACH.** Loss of balance can make you fall into a working machine, causing injury.
19. **NEVER STAND ON THE MACHINE.** Injury could occur if the tool tips, or if you accidentally contact the cutting tool.
20. **NEVER LEAVE THE MACHINE RUNNING UNATTENDED. TURN THE POWER OFF.** Don't leave the machine until it comes to a complete stop. A child or visitor could be injured.
21. **TURN THE MACHINE "OFF", AND DISCONNECT THE MACHINE FROM THE POWER SOURCE** before installing or removing accessories, before adjusting or changing set-ups, or when making repairs. An accidental start-up can cause injury.
22. **MAKE YOUR WORKSHOP CHILDPROOF WITH PADLOCKS, MASTER SWITCHES, OR BY REMOVING STARTER KEYS.** The accidental start-up of a machine by a child or visitor could cause injury.
23. **STAY ALERT, WATCH WHAT YOU ARE DOING, AND USE COMMON SENSE. DO NOT USE THE MACHINE WHEN YOU ARE TIRED OR UNDER THE INFLUENCE OF DRUGS, ALCOHOL, OR MEDICATION.** A moment of inattention while operating power tools may result in injury.
24. **▲ WARNING** USE OF THIS TOOL CAN GENERATE AND DISBURSE DUST OR OTHER AIRBORNE PARTICLES, INCLUDING WOOD DUST, CRYSTALLINE SILICA DUST AND ASBESTOS DUST. Direct particles away from face and body. Always operate tool in well ventilated area and provide for proper dust removal. Use dust collection system wherever possible. Exposure to the dust may cause serious and permanent respiratory or other injury, including silicosis (a serious lung disease), cancer, and death. Avoid breathing the dust, and avoid prolonged contact with dust. Allowing dust to get into your mouth or eyes, or lay on your skin may promote absorption of harmful material. Always use properly fitting NIOSH/OSHA approved respiratory protection appropriate for the dust exposure, and wash exposed areas with soap and water.

ADDITIONAL SPECIFIC SAFETY RULES

▲ WARNING FAILURE TO FOLLOW THESE RULES MAY RESULT IN SERIOUS INJURY.

1. **DO NOT OPERATE THIS MACHINE** until it is assembled and installed according to the instructions.
2. **OBTAIN ADVICE FROM YOUR SUPERVISOR, instructor, or another qualified person** if you are not familiar with the operation of this machine.
3. **FOLLOW ALL WIRING CODES** and recommended electrical connections.
4. **USE THE GUARDS WHENEVER POSSIBLE.** Check to see that they are in place, secured, and working correctly.
5. **KICKBACK IS THE NATURAL TENDENCY OF THE WORKPIECE TO BE THROWN BACK AT THE OPERATOR** when the workpiece initially contacts the blade or if the workpiece pinches the blade. Kickback is dangerous and can result in serious injury.
AVOID KICKBACK by:
 - A. keeping blade sharp and free of rust and pitch.
 - B. keeping rip fence parallel to the saw blade.
 - C. using saw blade guard and spreader for every possible operation, including all through sawing.
 - D. pushing the workpiece past the saw blade prior to release.
 - E. never ripping a workpiece that is twisted or warped, or does not have a straight edge to guide along the fence.
 - F. using featherboards when the anti-kickback device cannot be used.
 - G. never sawing a large workpiece that cannot be controlled.
 - H. never using the fence as a guide when crosscutting.
 - I. never sawing a workpiece with loose knots or other flaws.
6. **ALWAYS USE GUARDS, SPLITTER, AND ANTI-KICKBACK FINGERS** whenever possible.
7. **REMOVE CUT-OFF PIECES AND SCRAPS** from the table before starting the saw. The vibration of the machine may cause them to move into the saw blade and be thrown out. After cutting, turn the machine off. After the blade has **come to a complete stop, remove all debris.**
8. **NEVER START THE MACHINE** with the workpiece against the blade.
9. **NEVER** run the workpiece between the fence and a moulding cutterhead.
10. **CUTTING THE WORKPIECE WITHOUT THE USE OF A FENCE OR MITER GAUGE IS KNOWN AS "FREEHAND" CUTTING. NEVER** perform "free-hand" operations. Use either the fence or miter gauge to position and guide the workpiece.
11. **HOLD THE WORKPIECE FIRMLY** against the miter gauge or fence.
12. **CUTTING COMPLETELY THROUGH THE WORKPIECE IS KNOWN AS "THROUGH-SAWING".** Ripping and cross-cutting are through-sawing operations. Cutting with the grain (or down the length of the workpiece) is ripping. Cutting across the grain (or across the workpiece) is cross-cutting. Use a fence or fence system for ripping. **DO NOT** use a fence or fence system for cross-cutting. Instead, use a miter gauge. **USE PUSH STICK(S)** for ripping a narrow workpiece.
13. **AVOID AWKWARD OPERATIONS AND HAND POSITIONS** where a sudden slip could cause a hand to move into the blade.
14. **KEEP ARMS, HANDS, AND FINGERS** away from the blade.
15. **NEVER** have any part of your body in line with the path of the saw blade.
16. **NEVER REACH AROUND** or over the saw blade.
17. **NEVER** attempt to free a stalled saw blade without first turning the machine "OFF".
18. **PROPERLY SUPPORT LONG OR WIDE** workpieces.
19. **NEVER PERFORM LAYOUT,** assembly or set-up work on the table/work area when the machine is running.
20. **TURN THE MACHINE "OFF" AND DISCONNECT THE MACHINE** from the power source before installing or removing accessories, before adjusting or changing set-ups, or when making repairs.
21. **TURN THE MACHINE "OFF",** disconnect the machine from the power source, and clean the table/work area before leaving the machine. **LOCK THE SWITCH IN THE "OFF" POSITION** to prevent unauthorized use.
22. **ADDITIONAL INFORMATION** regarding the safe and proper operation of power tools (i.e. a safety video) is available from the Power Tool Institute, 1300 Sumner Avenue, Cleveland, OH 44115-2851 (www.powertoolinstitute.com). Information is also available from the National Safety Council, 1121 Spring Lake Drive, Itasca, IL 60143-3201. Please refer to the American National Standards Institute ANSI O1.1 Safety Requirements for Woodworking Machines and the U.S. Department of Labor OSHA 1910.213 Regulations.

SAVE THESE INSTRUCTIONS.
Refer to them often
and use them to instruct others.

POWER CONNECTIONS

A separate electrical circuit should be used for your machines. This circuit should not be less than #12 wire and should be protected with a 20 Amp time lag fuse. Before connecting the machine to the power line, make sure the switch is in the "OFF" position and be sure that the electric current is of the same characteristics as indicated on the machine. All line connections should make good contact. Running on low voltage will damage the machine.

⚠ DANGER DO NOT EXPOSE THE MACHINE TO RAIN OR OPERATE THE MACHINE IN DAMP LOCATIONS.

MOTOR SPECIFICATIONS

Your machine is wired for 230 Volt, 60 HZ alternating current. Before connecting the machine to the power source, make sure the switch is in the "OFF" position.

GROUNDING INSTRUCTIONS

⚠ DANGER THIS MACHINE MUST BE GROUNDED WHILE IN USE TO PROTECT THE OPERATOR FROM ELECTRIC SHOCK.

Permanently connected machines:

If the machine is intended to be permanently connected, all wiring must be done by a qualified electrician and conform to the National Electric Code and all local codes and ordinances.

* **THREE PHASE OPERATION:** Three phase machines are not supplied with a power cord and must be permanently connected to a building's electrical system. Extension cords can't be used with a three phase machine.

* **LVC MAGNETIC MOTOR CONTROL:** If you purchased a machine that has a Low Voltage Magnetic Motor Control System, refer to its instruction manual for installation guidance.

FUNCTIONAL DESCRIPTION

FOREWORD

The Delta Unisaw is a 10" right tilting arbor saw. The Delta Unisaw features set the standards in the table saw industry.

NOTICE: The photo on the manual cover illustrates the current production model. All other illustrations contained in the manual are representative only and may not depict the actual labeling or accessories included. These are intended to illustrate technique only.

CARTON CONTENTS

1. Unisaw
2. Switch (shown with a LVC switch)



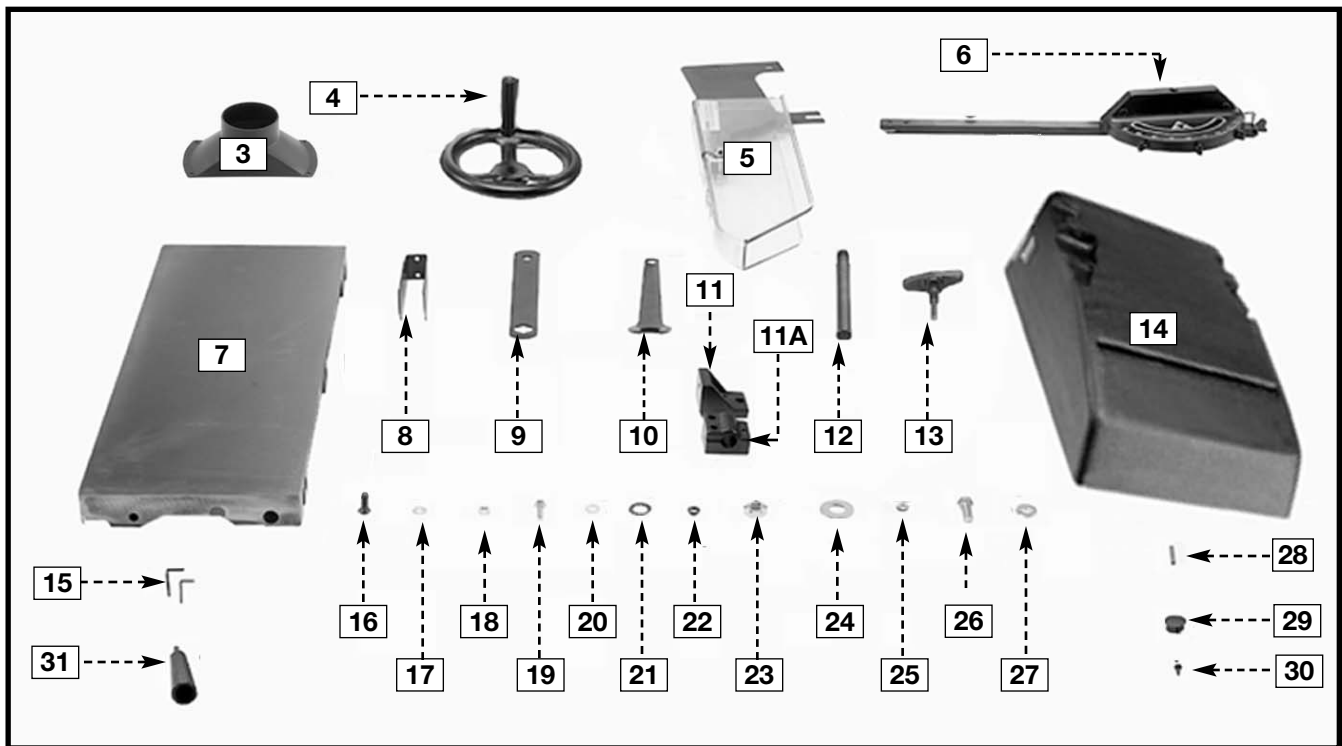

- | | | | |
|------|--|-----|---|
| 3. | DUST CHUTE ADAPTER | 17. | 5/16" FLAT WASHER FOR MOUNTING SWITCH (FOR MAGNETIC STARTER ONLY) |
| 4. | HANDWHEEL | 18. | 5/16-18 HEX NUT FOR MOUNTING SWITCH (FOR MAGNETIC STARTER ONLY) |
| 5. | BLADE GUARD AND SPLITTER BRACKET | 19. | 5/16-18 X 1" HEX HEAD CAP SCREWS (4) |
| 6. | MITER GAUGE | 20. | 5/16" L.D. FLAT WASHERS (2) |
| 7. | EXTENSION WING | 21. | 5/8" INTERNAL TOOTH WASHER |
| 8. | HANGERS FOR RIP FENCE (2) | 22. | 5/16" L.D. LOCKWASHERS (3) |
| 9. | CLOSED-END ARBOR WRENCH | 23. | 5/8-18 JAM NUT |
| 10. | OPEN-END ARBOR WRENCH | 24. | FIBER WASHER (FOR HANDWHEEL) |
| 11. | UPPER BRACKET FOR SPLITTER | 25. | FLAT WASHER FOR MITER GAUGE HANDLE |
| 11A. | LOWER BRACKET FOR SUPPORT ROD | 26. | 7/16-20X1¼" HEX HEAD BOLT (3) |
| 12. | SUPPORT ROD | 27. | 7/16" FLAT WASHER (3) |
| 13. | LOCKNOB | 28. | KEY (FOR HANDWHEEL) |
| 14. | MOTOR COVER | 29. | CAP FOR MITER GAUGE HANDLE |
| 15. | 1/8" AND 5/64" HEX WRENCHES | 30. | #10 X 1/2" HEX WASHER HEAD BOLT (8) |
| 16. | 5/16-18X1" FLAT HEAD SCREW FOR MOUNTING SWITCH (FOR MAGNETIC STARTER ONLY) | 31. | HANDLE FOR MITER GAUGE |
| | | 32. | CABLE TIE (NOT SHOWN) |

UNPACKING AND CLEANING

Carefully unpack the machine and all loose items from the shipping container(s). Remove the protective coating from all unpainted surfaces. This coating may be removed with a soft cloth moistened with kerosene (do not use acetone, gasoline or lacquer thinner for this purpose). After cleaning, cover the unpainted surfaces with a good quality household floor paste wax.

ASSEMBLY

ASSEMBLY TOOLS REQUIRED

1/8" Hex Wrench (Supplied)	5/16" Wrench
5/64" Hex Wrench (Supplied)	7/16" Wrench
1/2" Wrench	Flat-Head Screwdriver

ASSEMBLY TIME ESTIMATE

Assembly for this machine takes approximately 1 hour.

⚠ WARNING For your own safety, do not connect the machine to the power source until the machine is completely assembled and you read and understand the entire instruction manual.

INSTALLING THE BLADE TILTING HANDWHEEL

1. Install the fiber washer (A) Fig. 3 on the shaft (B). Install the key (C) into the shaft keyway.
2. Place the handwheel (D) on the shaft (B) Fig. 3. Align the groove (E) in the handwheel with the key (C).
3. Push the handwheel snugly against the fiber washer and tighten the set screw.
4. Thread the lockknob (F) Fig. 4 into the shaft (B). Hand-tighten lock knob.

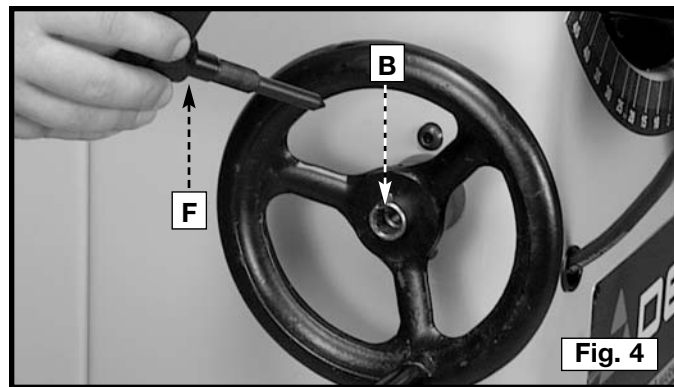
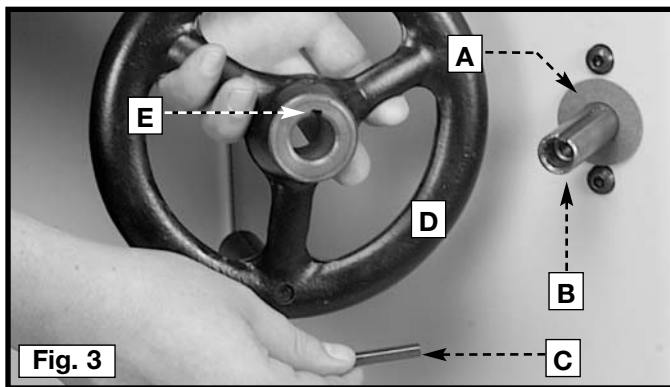

ATTACHING THE EXTENSION WING

NOTE FOR MAGNETIC STARTER BOX: Do not install the front screw and washer when you attach the left extension wing. You will install those when you attach the "ON/OFF" switch.

NOTE FOR LVC STARTER BOX: If your Unisaw was shipped with an LVC starter box, remove the LVC "ON/OFF" switch from the left side of the Unisaw. Save the hardware to attach the "ON/OFF" switch to the left extension wing in the section "ATTACHING THE LVC ON/OFF SWITCH."

Attach the extension wing (A) Fig. 5 to the left side of the saw table using three 7/16"-20x1¹/₄" hex head bolts (B) and 7/16" flat washers.

NOTE: Make sure that the front edge of the wing is flush with the front edge of the table.

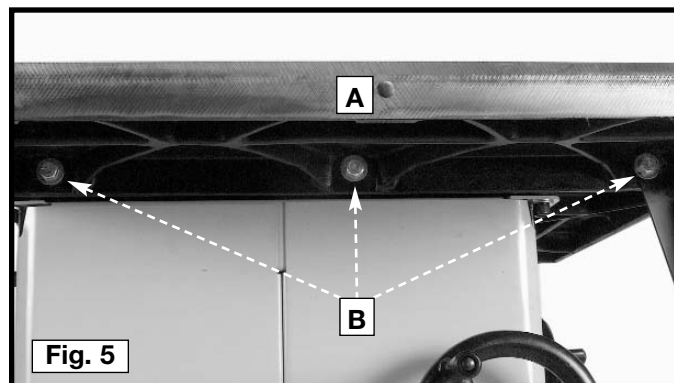

Use a straight edge (C) Fig. 6 to be sure that the extension wing (A) and the saw table (D) are even with each other before tightening the screws (B) Fig. 5.

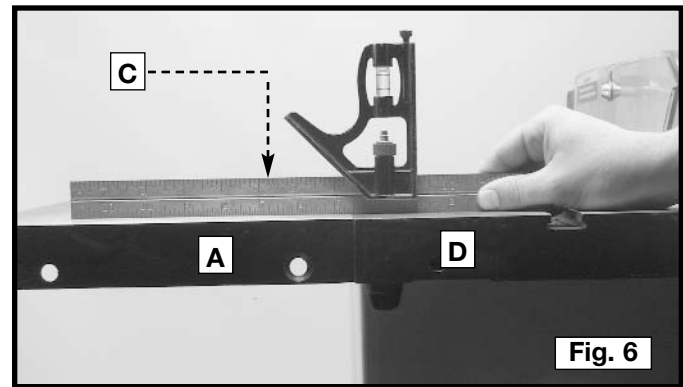

ATTACHING THE LVC STARTER BOX TO THE CABINET

If your saw has magnetic push button electrical controls, the starter box is already wired to the switch and motor. However, you will need to mount the starter box to the saw cabinet.

1. Place a 1/4" lockwasher, then a 1/4" flat washer on a 1/4-20x1/2" hex head bolt. Insert the bolt through one of the holes (B) Fig. 7 on the inside of the saw cabinet and into the matching tapped hole (C) Fig. 7 in the starter. Tighten just enough to hold the starter.
2. Repeat for the remaining 2 holes.
3. Tighten all three bolts securely.

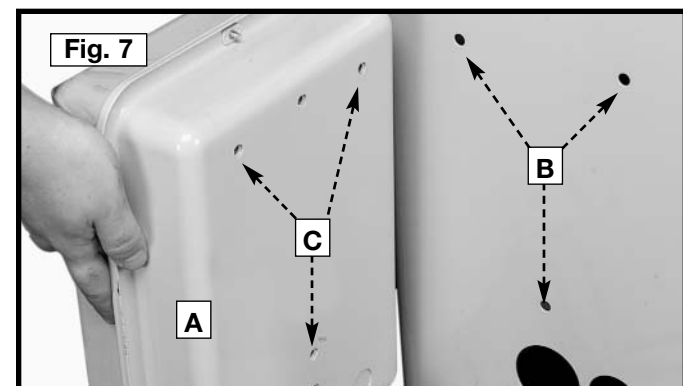

ATTACHING THE LVC ON/OFF SWITCH

1. Locate the LVC switch (A) Fig. 8 and the hardware that was removed in the section "ATTACHING THE EXTENSION WING."
2. Use the hardware to mount the switch bracket (C) Fig. 9 to the inside of the table through the hole (D) on the left front edge of the extension wing.

NOTE: If you have a GPE switch see "ATTACHING THE GPE ON/OFF Switch" instructions.

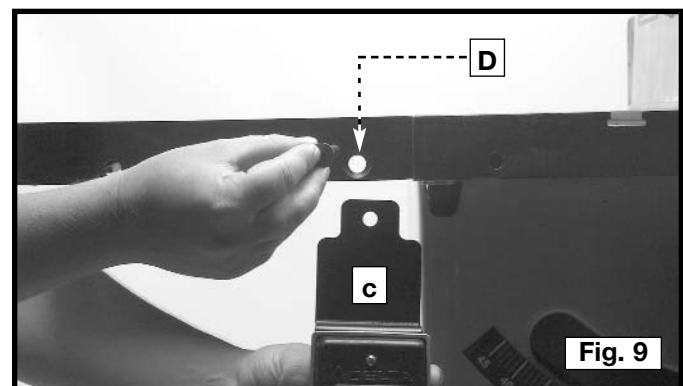
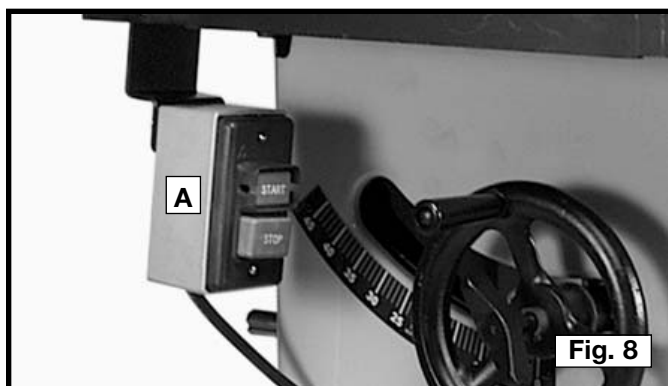

ATTACHING THE MAGNETIC STARTER ON/OFF SWITCH

1. The Magnetic Starter on/off switch (A) Fig. 9 comes attached to a mounting bracket on the right side of the machine. Remove it.
2. Insert a 5/16-18x1" flat head screw (D) with a 5/16" flat washer (E) through the hole (G) in the front lip of the extension table and through the switch bracket (A). Use a 5/16-18 hex nut to loosely attach the switch and switch bracket (A) Fig. 10 to the inside front lip of extension table. with (F) through hole (G).
3. Attach the side of switch bracket (A) Fig. 11 to the inside of the extension table using the 7/16-20x1-1/4" screw (C) and 7/16" flat washer.
4. Tighten all hardware securely.

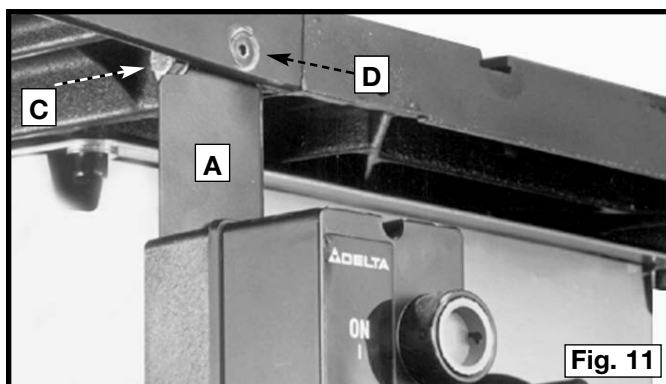
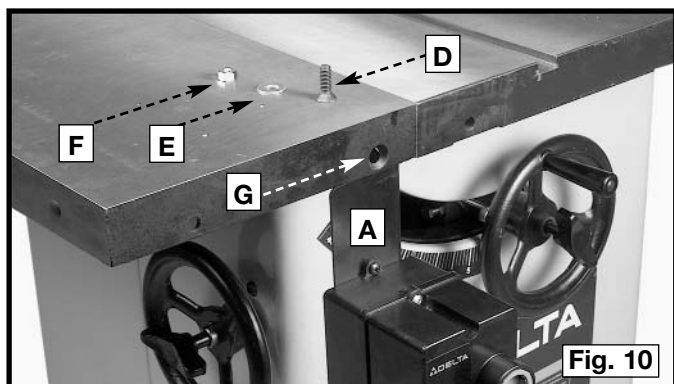
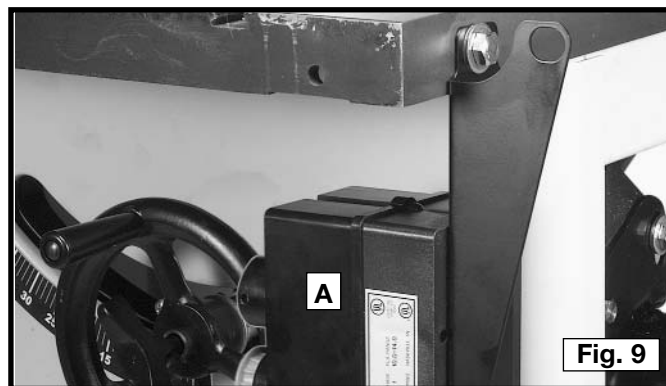

ATTACHING THE BLADE GUARD AND SPLITTER ASSEMBLY

⚠ WARNING DISCONNECT THE MACHINE FROM THE POWER SOURCE!

1. Remove the table insert Fig. 12. Raise the saw arbor by turning the height adjusting handle on the front of the saw counter-clockwise as far as it will go. Then turn the angle-adjusting handle on the front of the saw clockwise as far as it will go. Remove the saw blade from the machine by following the instructions in section "CHANGING THE SAW BLADE".
2. The inside splitter mounting bracket (A) Fig. 13 comes attached to the inside of the saw and was aligned with the inside blade flange (B) at the factory.

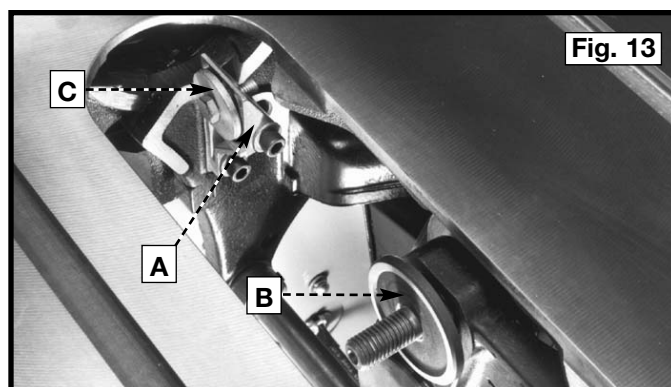
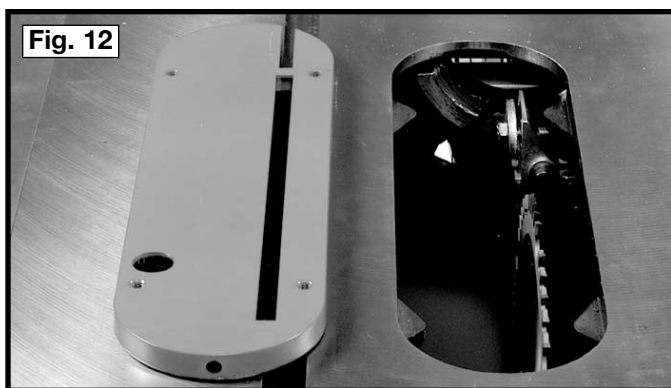

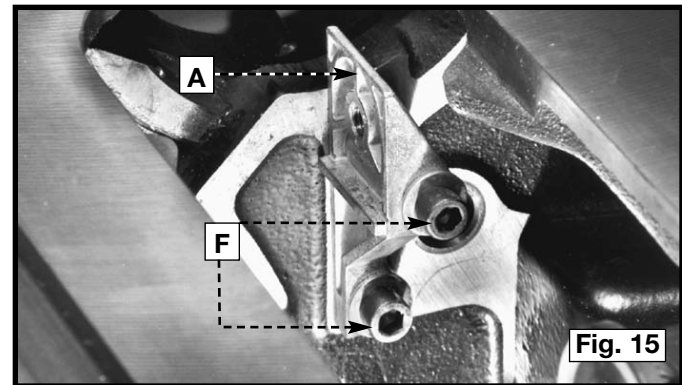
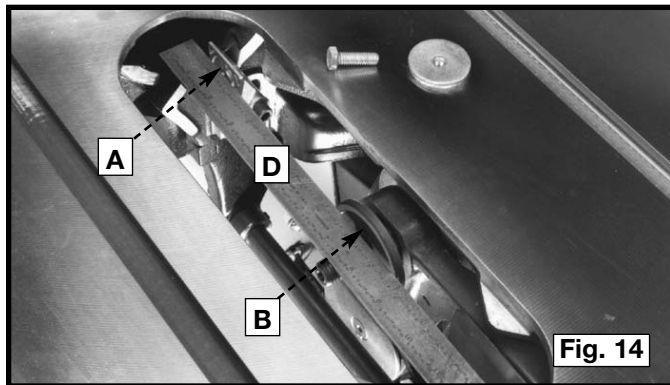

3. To check the alignment, remove the screw and fastener plate (C) Fig. 13. Use a straight edge (D) Fig. 14 to see if the splitter bracket (A) is aligned with the inside blade flange (B). Check both the top and bottom of bracket (A) with the top and bottom of flange (B).
4. To adjust, loosen the two screws (F) Fig. 15, and adjust splitter bracket (A) until it is aligned with the inside blade flange (B) Fig. 15. Tighten the two screws (F). Loosely install the screw and fastener plate (C), that were removed in **STEP 3**.
5. Insert the threaded end of the support rod (G) Fig. 16, through the slot in the rear of the saw and into the hole in the rear trunnion (H). Fasten the support rod (G) to the trunnion with a star washer and hex nut (J) Fig. 17.

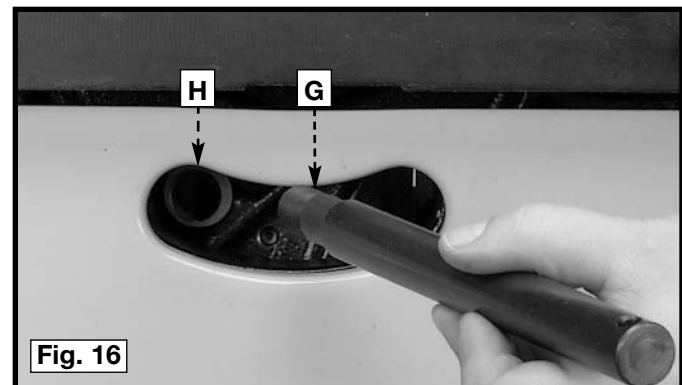

NOTE: Thread a nut (J) Fig. 17, on the threads of the support rod (G) as much as possible by hand.

6. Use a wrench to hold the hex nut (J) Fig. 17, insert a small screwdriver (K) through the hole in the end of the rod (G) Fig. 18, and tighten the rod (G) Fig. 18.
7. Attach the lower bracket (L) Fig. 19 the to rod (G). Loosely tighten with two 5/16-18x1" hex head bolts(S) and 5/16" lockwashers from underneath the bracket (L).

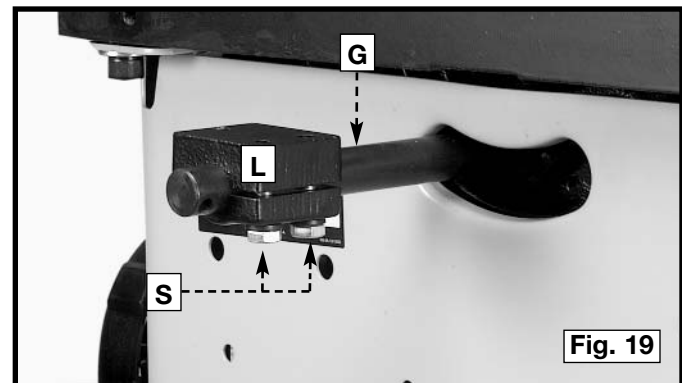
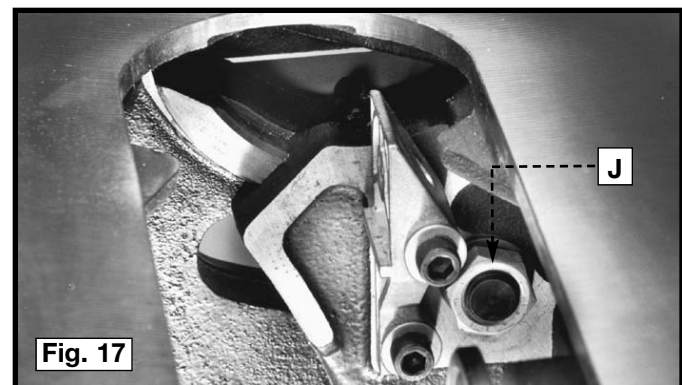

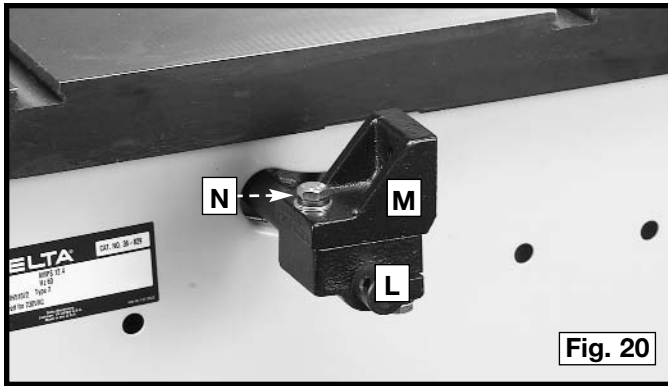

Fig. 20

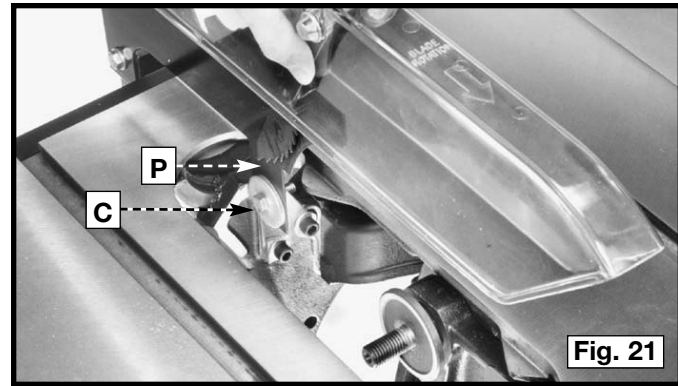

Fig. 21

8. Use a 5/16-18x1" hex head bolt (N) with 5/16" lockwasher and 5/16" flat washer to attach the upper splitter bracket (M) Fig. 20 to the lower bracket (L) . **NOTE:** Hand tighten only.
9. Insert the front end of splitter (P) Fig. 21, inside the splitter mounting bracket, behind the splitter fastener plate and the screw (C). Push the splitter down as far as possible, making certain that the bottom edge of splitter (P) is parallel with the table surface. Tighten the screw (C). Fasten splitter and blade guard assembly (P) Fig. 22 to the bracket (M) using a 5/16-18x1" hex head bolt (V) and 5/16" flat washer.

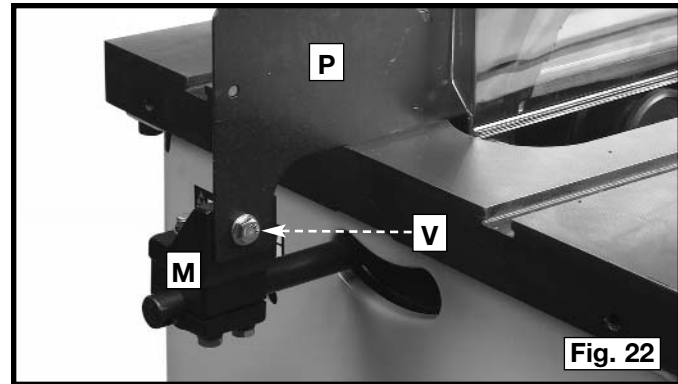

Fig. 22

IMPORTANT: The splitter (P) Fig. 23, features a notch (W) cut into the top edge. Raise the front of the clear blade guard (P) Fig. 23, until the rear edge of the guard slips into notch (W) of the splitter. This notch enables the blade guard to stay in the raised position and makes changing blades easier.

11. Install the saw blade, making certain the teeth are pointing down at the front of the saw table (Fig. 24). Install the outside blade flange and arbor nut (X). With open-end wrench (Y) on the flats of the arbor to keep it from turning, tighten arbor nut by turning box-end wrench (Z) counter-clockwise.

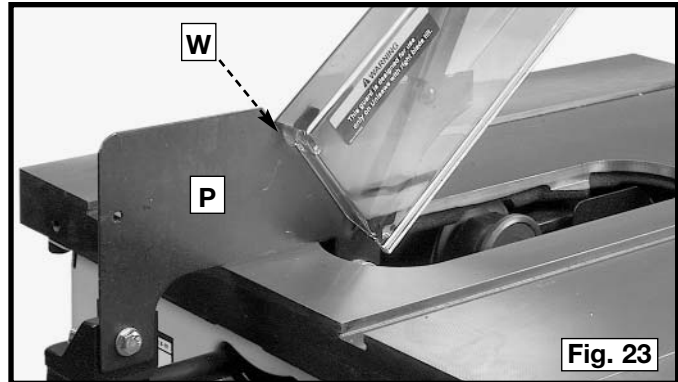

Fig. 23

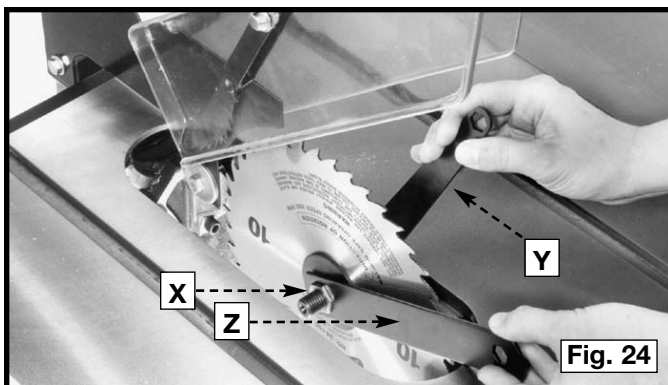

Fig. 24

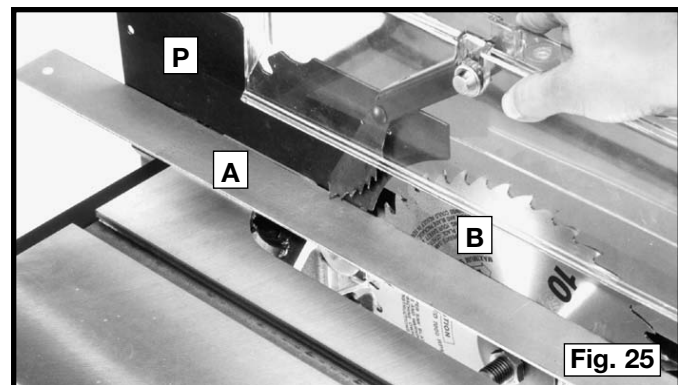
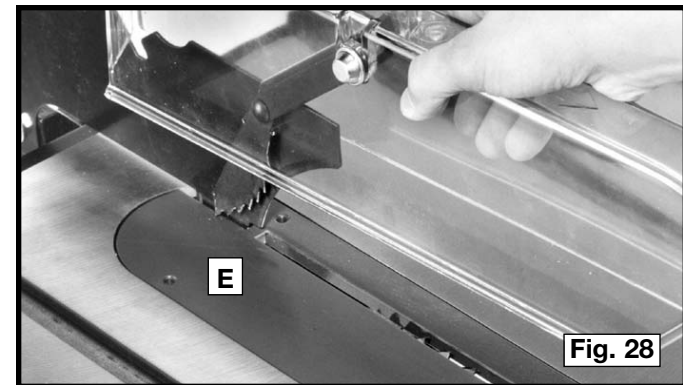
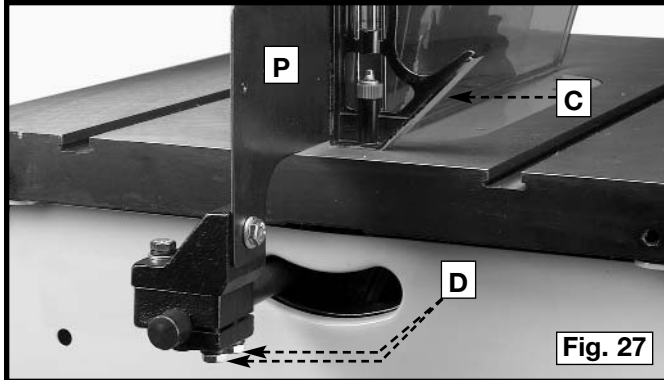
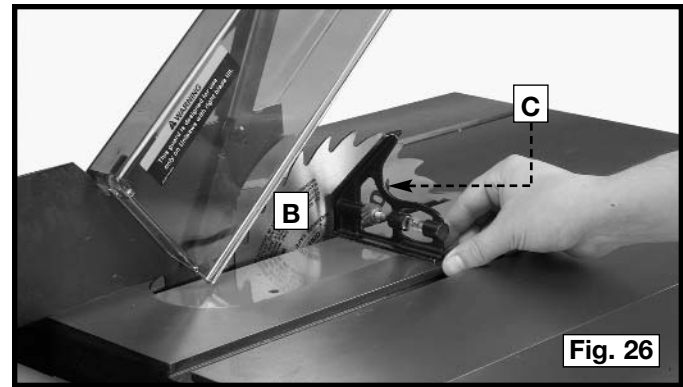

Fig. 25

- Use a straight edge (A) Fig. 25 to make certain that the splitter (P) is aligned with the saw blade (B). Use a square (C) Figs. 27 and 28 to make certain that the saw blade (B) Fig. 26 and splitter (P) Fig. 27 are 90° to the table surface. Tighten all splitter mounting hardware (D) Fig. 27 and re-check the alignment.
- Hold the clear blade guard (X) Fig. and lower the saw blade. Attach the table insert (E) Fig. 30 into the opening on the saw table.



FASTENING THE MOTOR CORD TO THE SAW FRAME

- Raise the saw arbor by turning the height adjusting handle on the front of the saw counter-clockwise as far as it will go. Then turn the angle adjusting handle on the front of the saw clockwise as far as it will go.
- Fasten motor cord (A) Fig. 29 to the saw frame cross member (B), using the cable tie (C) supplied with the saw.

CAUTION: Before tightening the cable tie, make certain that the electrical cord (A) is free of any interference from the motor or saw blade in all positions.

- After the cable tie is tightened, cut off the excess tail (C) Fig. 29.

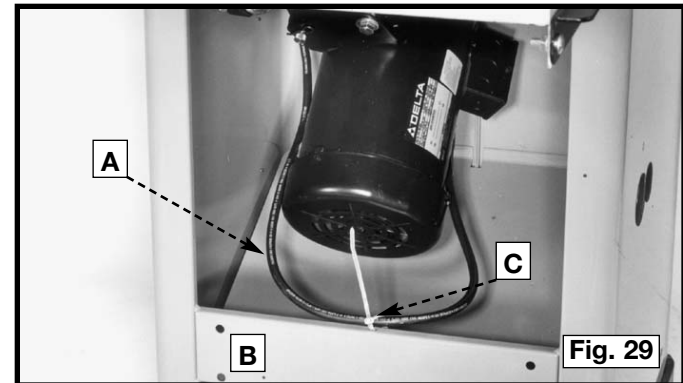

ATTACHING MOTOR COVER

NOTE: If you have an “LVC” (Starter Box) version Unisaw, you will have to attach two bottom spring clips to the motor cover. The spring clips come attached to the “GPE version Unisaw.”

- Attach the two motor cover clips to the motor cover. Align the hole in the motor cover clip with the hole in the motor cover. Place a 13/64 flat washer on a 10-32 x 1/2" screw (A) Fig. 30. Insert the screw through the hole in the motor cover clip and thread the screw (A) into the tapped hole in the motor cover.

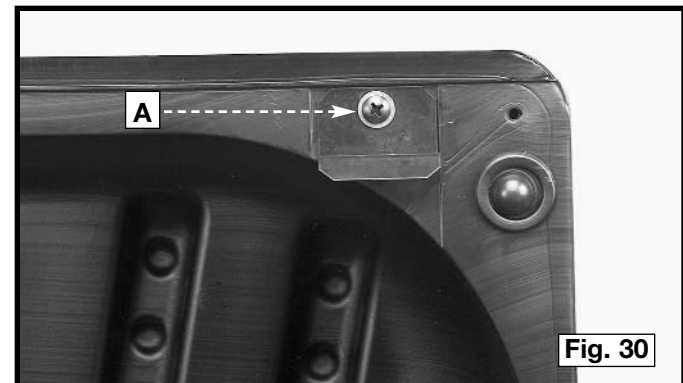

- Place the motor cover (A) in the opening of the Unisaw (Fig. 31). Place the rear motor cover clips inside the motor opening and push the front of the motor cover until all 4 motor cover clips are engaged with the motor cover opening in the Unisaw.

NOTE: To remove the motor cover, depress both sides of the cover and pull outward.



MITER GAUGE HOLDER AND WRENCH HOLDER

You can store the miter gauge and arbor wrenches in the slots (A) Fig. 32 provided in the motor cover.

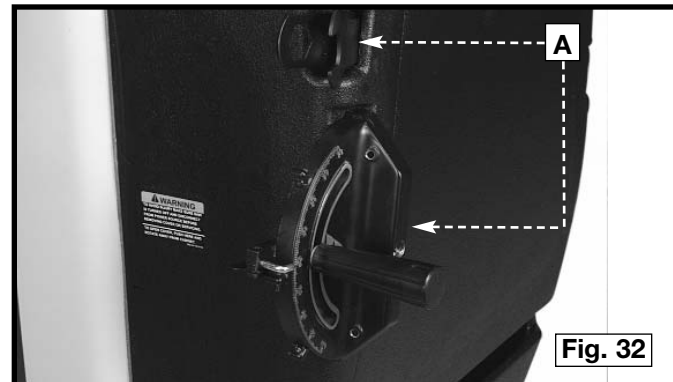

ATTACHING THE RIP FENCE HOLDER BRACKETS

Use four #10 x 1/2" sheet metal screws to attach the rip fence holder brackets (A) and (B) Fig. 33 to the four holes located in the left hand side of the saw cabinet.

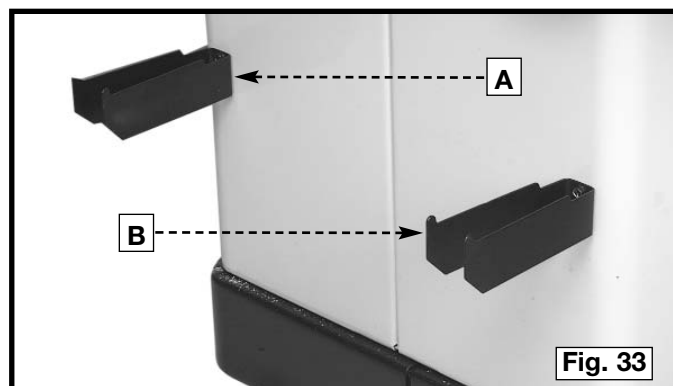

ATTACHING THE DUST CHUTE ADAPTER

The Unisaw is supplied with a dust chute adapter to connect a 4" diameter dust collector hose to the machine. Align the four holes in the adapter (A) Fig. 34 with the four holes in the back of the saw cabinet (B). Attach the dust chute adapter with four #10 x 1/2" sheet metal screws.

NOTE: Do not mount the dust chute adapter unless you use a dust collection system with the saw. Without the system, a dust chute adapter will restrict the gravity feed opening for saw dust removal.

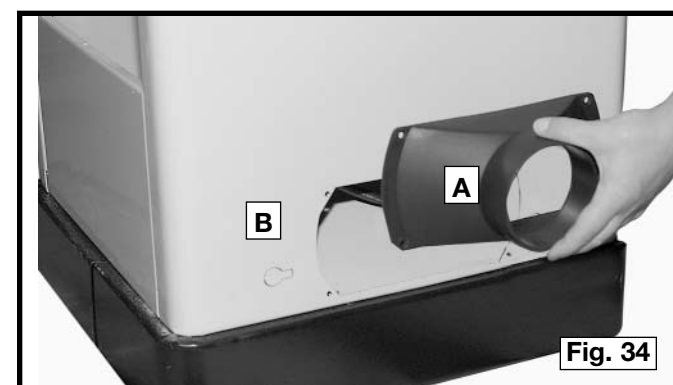

OPERATION

OPERATIONAL CONTROLS AND ADJUSTMENTS

STARTING AND STOPPING THE MACHINE

1. The on/off switch (A) Fig. 35 is located on the front of the machine. To turn the machine "ON", depress the "ON" switch.
2. To turn the machine "OFF", depress the "OFF" switch.

▲WARNING Make sure that the switch is in the "OFF" position before plugging in the power cord. In the event of a power failure, move the switch to the "OFF" position. An accidental start-up can cause injury.

LOCKING THE SWITCH IN THE "OFF" POSITION

IMPORTANT: When the machine is not in use, the switch should be locked in the "OFF" position to prevent unauthorized use, using a padlock (A) Fig. 36 with a 3/16" diameter shackle.

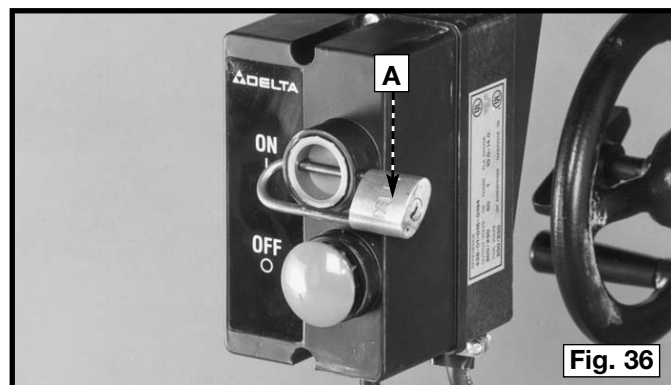
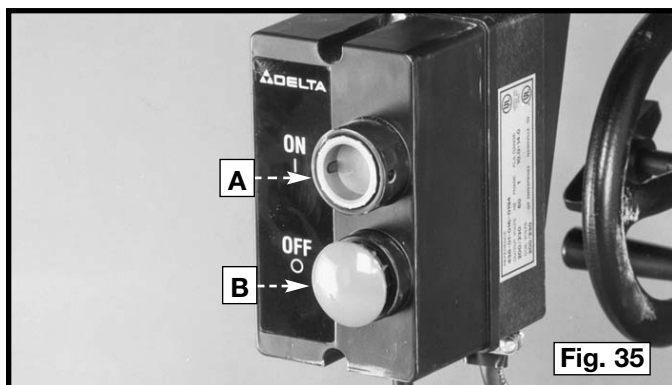

OVERLOAD PROTECTION

Your saw is supplied with overload protection. If the motor shuts off or fails to start due to overloading (cutting stock too fast, using a dull blade, using the saw beyond its capacity, etc.) or low voltage, let the motor cool three to five minutes. The overload will automatically reset itself and the machine can then be started again by pressing the "ON" button.

IMPORTANT: If the motor continually shuts off due to overloading, contact a qualified electrician.

RAISING AND LOWERING THE BLADE

Raise or lower the saw blade with the front handwheel (A) Fig. 41. With the exception of hollow ground blades, raise the blade 1/8" to 1/4" above the top surface of the workpiece. Raise hollow ground blades the maximum amount to provide greater clearance. To raise the saw blade, loosen the lock knob (B) Fig. 37, and turn the handwheel (A) clockwise. To lower the saw blade, turn handwheel (A) counter-clockwise.

You can lock the saw blade at any height by turning the lock knob (B) Fig. 37 clockwise. Due to the wedge action of this locking device, only a small amount of force is required to lock the blade height adjustment securely. Added force merely puts unnecessary strain on the locking device. Limit stops for raising or lowering are permanently built into the mechanism and need no further adjustment.

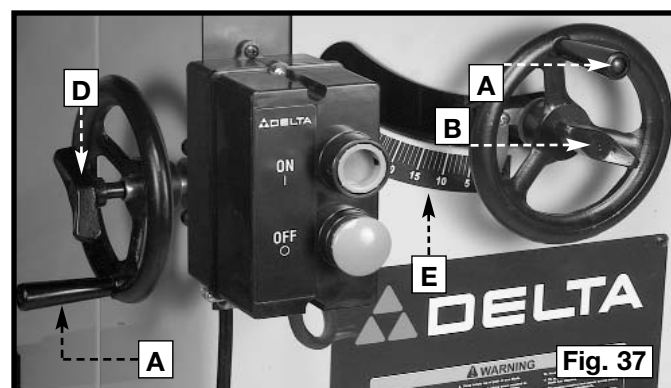

TILTING THE BLADE

The blade tilting mechanism allows the blade to be tilted up to 45° to the right.

To tilt the saw blade to the desired angle, loosen the lock knob (D) Fig. 37, and turn the handwheel (C). A pointer indicates the angle of tilt on scale (E), which is marked in one-degree increments. To lock the saw blade, tighten the lock knob (D).

IMPORTANT: Always lock the blade in position before starting the saw.

ADJUSTING 90° AND 45° DEGREE POSITIVE STOPS

Positive stops are provided to quickly and accurately position the blade at 90° and 45° to the table. To check and adjust the positive stops:

⚠ WARNING DISCONNECT MACHINE FROM POWER SOURCE!

1. Raise the saw blade to its highest position.
2. Set the blade at 90° to the table by turning the blade tilting handwheel counterclockwise as far as it will go.
3. Use a combination square to see if the blade is at 90° to the table surface.
4. If the blade is not at 90° to the table, turn the blade tilting handwheel counter-clockwise. Loosen the locknut (A) Fig. 38, and tighten or loosen adjusting screw (B) until head of screw (B) contacts casting on front trunnion when the blade is at 90° degrees to the table. Then tighten locknut (A).
5. Check to see if the tilt indicator pointer points to the zero mark on the scale. Adjust if necessary.
6. Turn the blade tilting handwheel clockwise as far as it will go and use a combination square to see if the blade is at 45° to the table.
7. If the blade is not at 45° to the table, turn the blade tilting handwheel clockwise until the adjusting screw (D) Fig. 43, and locknut (C) are in view in the opening in the front of the saw cabinet. Loosen the locknut (C) and tighten or loosen the adjusting screw (D) until the head of the screw (D) contacts the casting on the front trunnion when the blade is at 45° to the table. Tighten locknut (C).

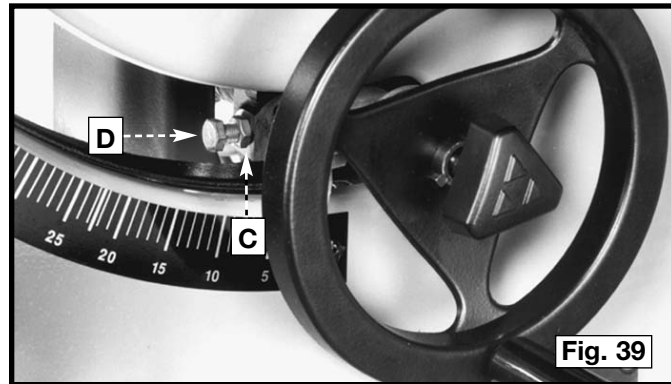
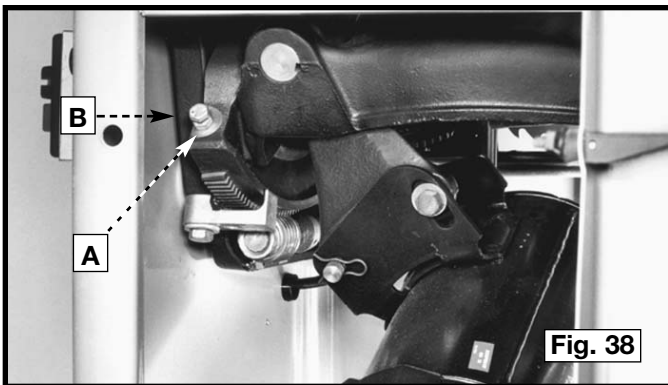

ADJUSTING THE TABLE

The miter gauge slots were aligned parallel to the saw blade at the factory. Check the alignment prior to your initial operation.

⚠ WARNING DISCONNECT MACHINE FROM POWER SOURCE!

1. Place a combination square (A) Fig. 40 on the table with one edge of the square in the miter gauge slot. Adjust the square so that the rule touches one of the teeth on the saw blade (Fig. 40). Lock the square in this position.
2. Rotate the saw blade so that the same tooth you used in **STEP 2** is in the rear position (Fig. 45). Both the front and rear measurements should be identical.
3. To adjust, loosen the four screws that hold the table to the saw cabinet.
4. Shift the table until the saw blade is in the center of the table insert slot, and parallel to the miter gauge slot.
5. Tighten the four screws that were loosened in **STEP 4**.
6. Tilt the blade to 45°, and turn the saw blade by hand to ensure that it does not contact the table insert.

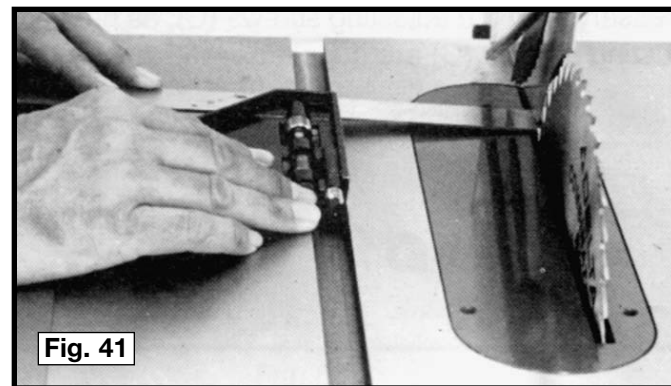
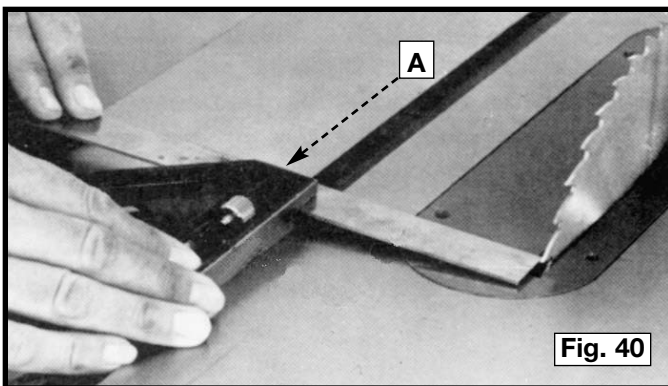

ADJUSTING THE TABLE INSERT

Place a straight edge (B) across the table at both ends of the table insert (A). The table insert (A) should always be level with the table. To adjust, turn the adjusting screws (C), with a supplied hex wrench.

NOTE: You can store the hex wrenches in the miter gauge handle when not in use. Remove the top cap (A) Fig. 44 for storage.

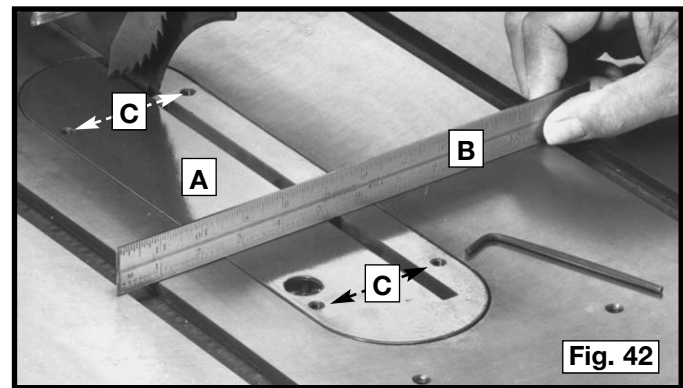

MITER GAUGE OPERATION AND ADJUSTMENT

Insert the miter gauge bar into the miter gauge slot on the table. Attach the washer and lock handle (A) Fig. 43 to the miter gauge bar.

The miter gauge is equipped with adjustable index stops at 90° and 45° right and left. You can make adjustments to the index stops by tightening or loosening the three adjusting screws (B) Fig. 48 with the supplied Hex wrench

To rotate the miter gauge, loosen the lock knob (A) Fig. 44 and move the body of the miter gauge (C).

The miter gauge body will stop at 90° and 45° both right and left. To rotate the miter gauge body past these points, move the stop link (D) Fig. 44 up and out of the way.

The head of the miter gauge pivots on a special tapered screw (G) Fig. 45. If the miter gauge head does not pivot freely, or pivots too freely, adjust it by loosening the set screw (H) Fig. 45, and turning the screw (G) in or out.

NOTE: Tighten screw (H) after you make the adjustment.

Your miter gauge is equipped with a plate (E) Fig. 45 that fits into the T-Slot groove in the table. This allows the miter gauge head to go off the front edge of the table without falling, allowing for a longer cut off capacity.

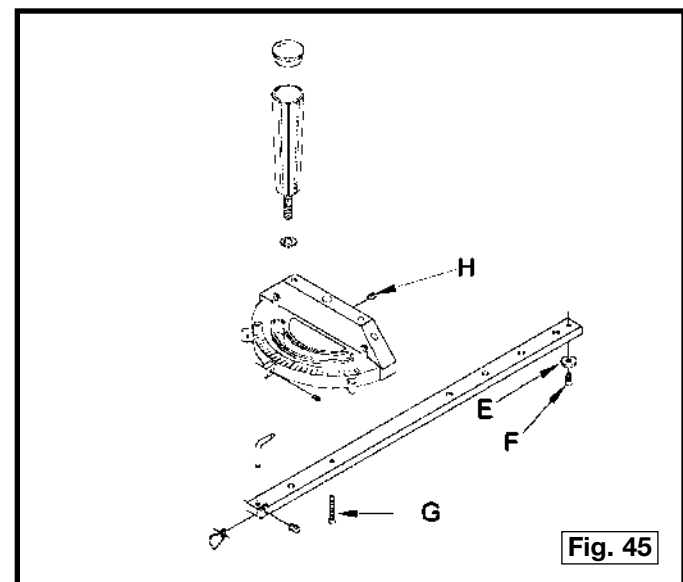
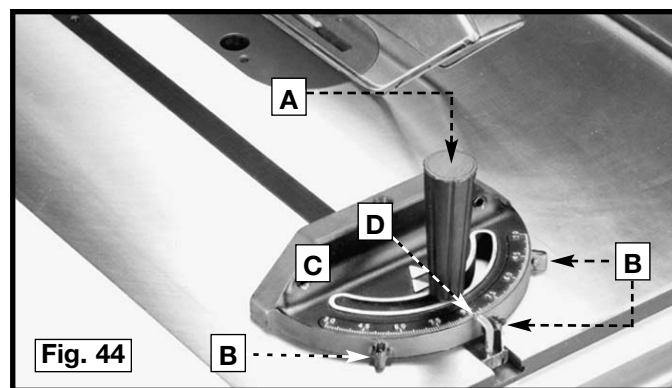
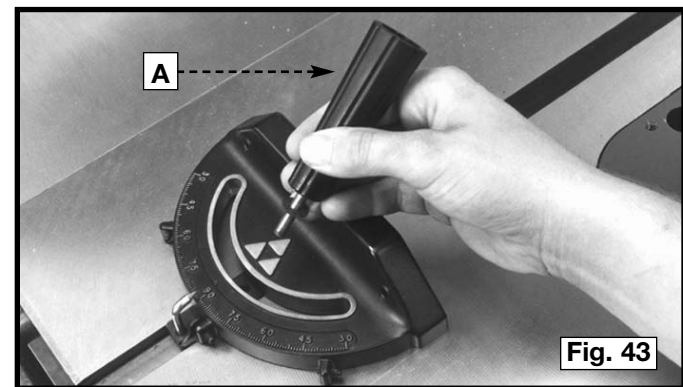

MACHINE USE

COMMON SAWING OPERATIONS

Common sawing operations include ripping and crosscutting plus a few other standard operations of a fundamental nature. As with all power machines, there is a certain amount of hazard involved with the operation and use of the machine. Using the machine with the respect and caution demanded as far as safety precautions are concerned, will considerably lessen the possibility of personal injury. However, if normal safety precautions are overlooked or completely ignored, personal injury to the operator can result. The following information describes the safe and proper method for performing the most common sawing operations.

▲WARNING The use of attachments and accessories not recommended by Delta may result in the risk of injury to the user or others.

CROSS-CUTTING

Cross-cutting requires the use of the miter gauge to position and guide the work. Place the work against the miter gauge and advance both the gauge and work toward the saw blade, as shown in Fig. 46. The miter gauge may be used in either table slot. When bevel cutting (blade tilted), use the table groove that does not cause interference of your hand or miter gauge with the saw blade guard.

Start the cut slowly and hold the work firmly against the miter gauge and the table.

▲WARNING One of the rules in running a saw is that you never hang onto or touch the part of the workpiece that will be cut off. Hold the supported piece, not the free piece that is cut off. The feed in cross-cutting continues until the work is cut in two, and the miter gauge and work are pulled back to the starting point. Before pulling the work back, it is good practice to give the work a little sideways shift to move the work slightly away from the saw blade. **Never** pick up any short length of free work from the table while the saw is running. **never** touch a cut-off piece unless it is at least a foot long.

For added safety and convenience the miter gauge can be fitted with an auxiliary wood-facing (C), as shown in Fig. 47, that should be at least 1 inch higher than the maximum depth of cut, and should extend out 12 inches or more to one side or the other depending on which miter gauge slot is being used. This auxiliary wood-facing (C) can be **fastened** to the front of the miter gauge by using two wood screws (A) through the holes provided in the miter gauge body and into the wood-facing.

▲CAUTION When using the block (B) Fig. 48, as a cut-off gauge, it is very important that the rear end of the block be positioned so the work piece is clear of the block before it enters the blade.

▲WARNING NEVER USE THE FENCE AS A CUT-OFF gauge WHEN CROSS-CUTTING.

When cross-cutting a number of pieces to the same length, a **BLOCK OF WOOD (B)**, can be clamped to the fence and used as a cut-off gauge as shown in Fig. 48. It is important that this block of wood always be positioned in front of the saw blade as shown. Once the cut-off length is determined, secure the fence and use the miter gauge to feed the work into the cut. This block of wood allows the cut-off piece to move freely along the table surface without binding between the fence and the saw blade, thereby lessening the possibility of kickback and injury to the operator.



Fig. 46

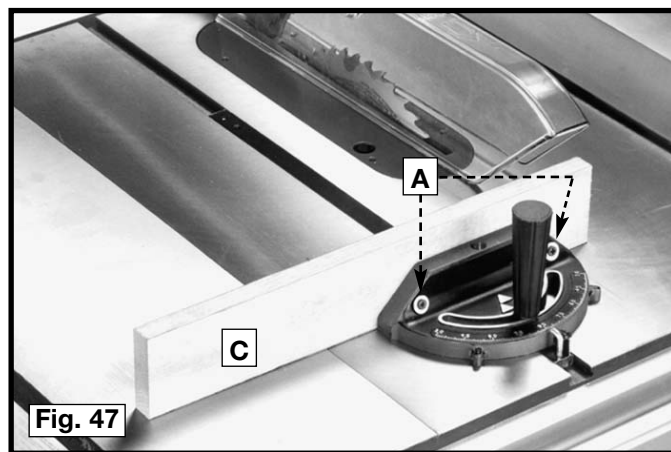

Fig. 47

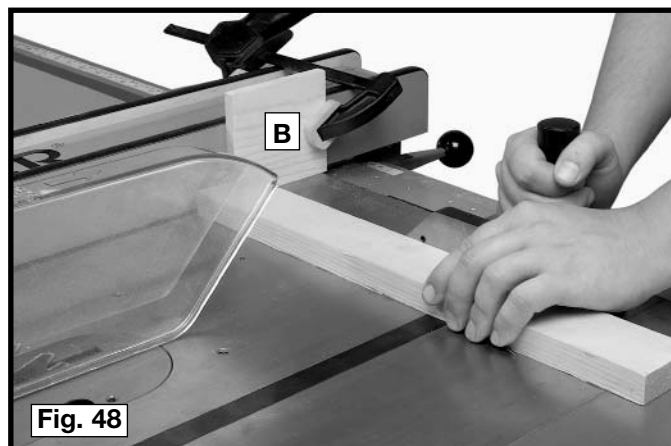

Fig. 48

RIPPING

Ripping is cutting lengthwise through a board, (Fig. 49). **NOTE:** Be sure the material to be cut is seasoned, dry and flat. The rip fence (A) is used to position and guide the work. One edge of the work rides against the rip fence while the flat side of the board rests on the table. Since the work is pushed along the fence, it must have a straight edge and make solid contact with the table.

⚠ WARNING The saw blade guard must be used. On Delta saws, the guard has anti-kickback fingers to prevent kickback and a splitter to prevent the wood kerf from closing and binding the blade. Be sure to replace or sharpen the anti-kickback devices when the points become dull.

⚠ WARNING A rip fence should always be used for ripping operations. **NEVER** perform a ripping operation free-hand.

1. Start the motor and advance the work holding it down and against the fence. **Never** stand in the line of the saw cut when ripping. When the rip width is 6 inches or wider, hold the work with both hands and push it along the fence and into the saw blade (Fig. 49). The work should then be fed through the saw blade with the right hand. Only use the left hand to guide the workpiece. Do not feed the workpiece with the left hand. After the work is beyond the saw blade and anti-kickback fingers, remove hands from the work.
2. When this is done the work will either stay on the table, tilt up slightly and be caught by the end of the rear guard, or slide off the table to the floor. Alternately, the feed can continue to the end of the table, after which the work is lifted and brought along the outside edge of the fence. The cut-off stock remains on the table and is not touched until the saw blade has stopped, unless it is a large piece allowing safe removal. When ripping boards longer than three feet, use a work support at the rear of the saw to keep the workpiece from falling off the saw table.
3. If the ripped work is less than 6 inches wide, a push stick should always be used to complete the feed, as shown in Fig. 50. The push stick can easily be made from scrap material as explained in the section **"CONSTRUCTING A PUSH STICK."**
4. Ripping narrow pieces can be dangerous if not done carefully.

⚠ WARNING When the piece is too narrow for a push stick to be effective - and if the workpiece is short enough - use a pushboard. When ripping material under 2 inches in width, ordinary push sticks may interfere with the blade guard.

When using a pushboard, the width of the pushboard must be added to the width of the rip fence position setting. A flat pushboard can be constructed as shown in Fig. 51 and should be used as shown in Fig. 52.

NOTE: Guard removed for clarity. Always use the guard.

NOTE: Some special operations (when using the moulding cutterhead) require the addition of an auxiliary wood facing to the fence, as explained in the section **"USING AUXILIARY WOOD FACING"** and use of a push stick.

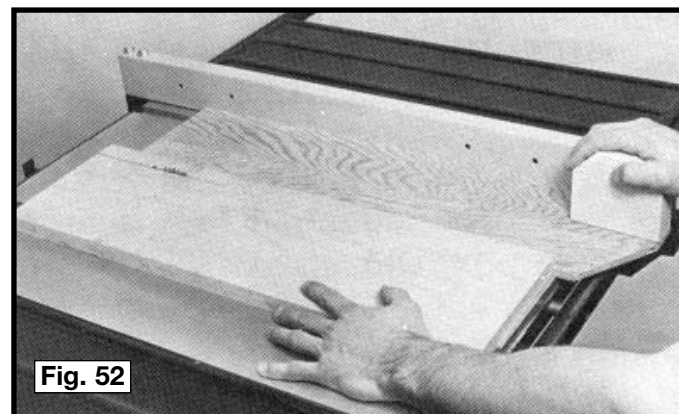
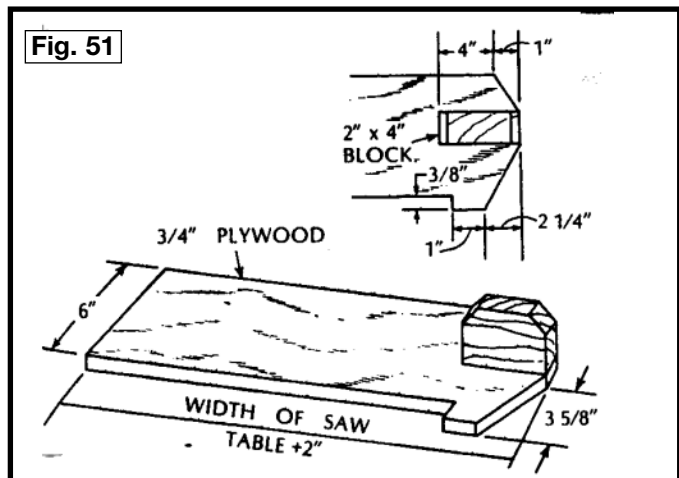
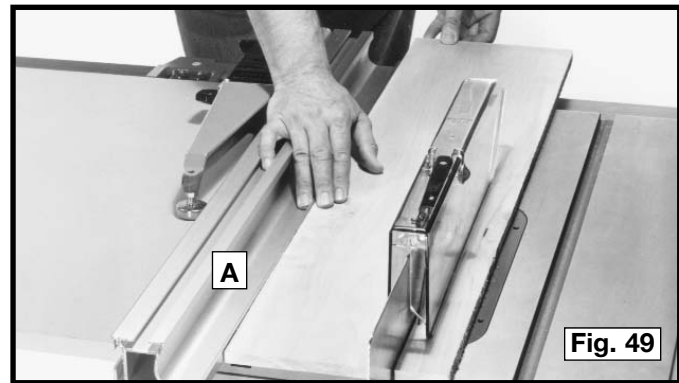

When ripping material with a veneer facing that extends over the material, the fence (A) should be in the horizontal position with the veneer (B) extending over the lip of the fence, as shown in Fig. 53

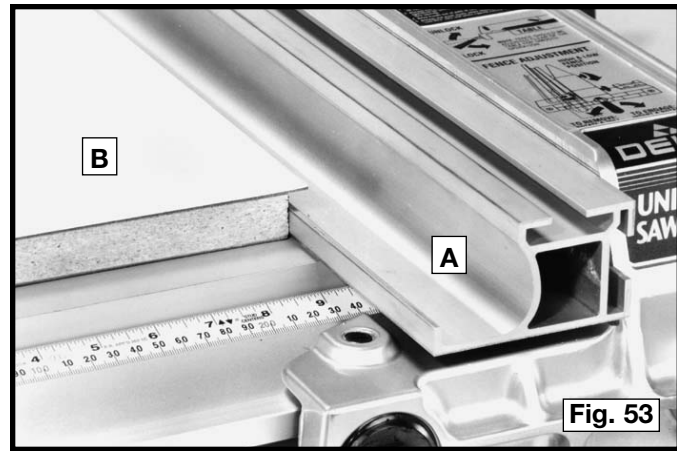

When ripping material with a veneer facing and the material is not thick enough for the veneer to extend over the lip of the fence or if the veneer facing (B) is on both sides of the material, as shown in Fig. 54, the fence can be positioned slightly above the surface of the table. The veneer can be placed between the fence and the table or the veneer can straddle the fence with the material solidly against the fence.

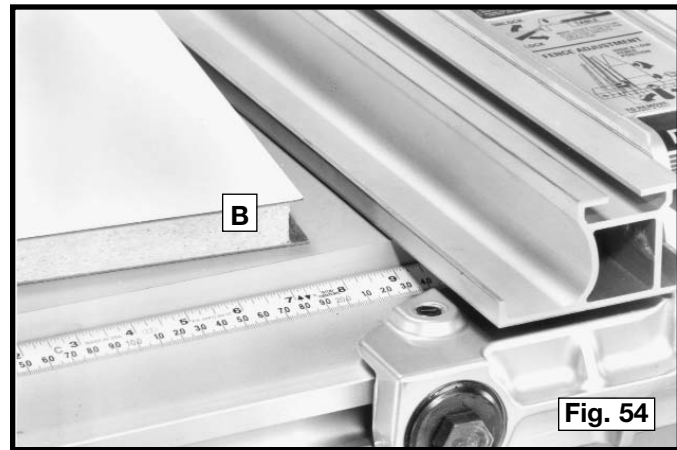

RIPPING ON LEFT SIDE OF SAW BLADE

In some cases it may be desirable to use the fence on the left side of the saw blade. This is easily accomplished by repositioning the fence (A) Figs. 55 and 56, fence clamp bar (B), and lock knobs (C) so that the fence (A) will be attached to the right side of the fence body, as shown in Fig. 56. The complete fence assembly (D) Fig. 56, can easily be moved to the left side of the saw table.

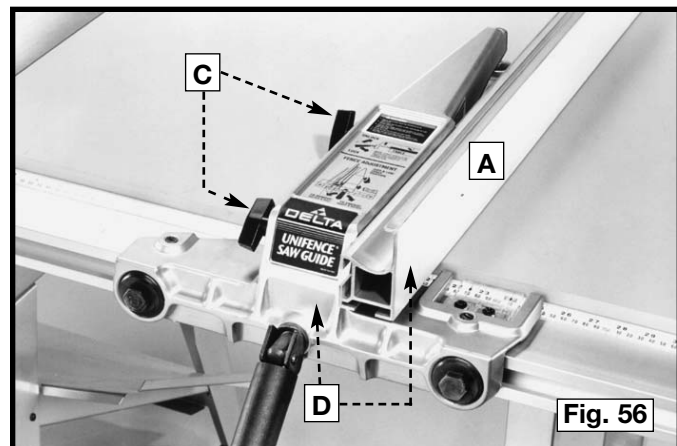
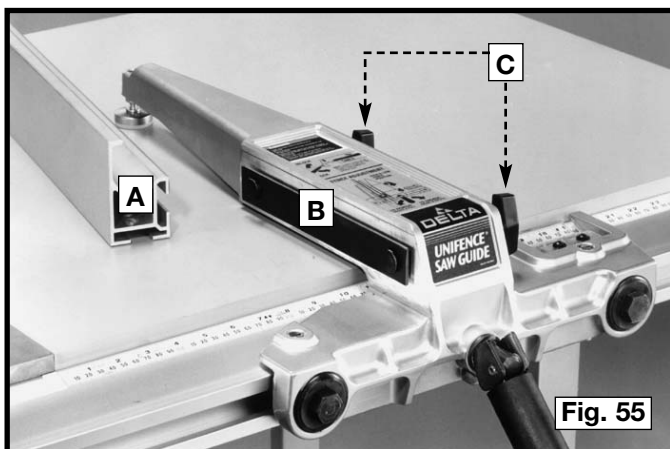

ACCESSORY MOULDING CUTTERHEAD

USING MOULDING CUTTERHEAD

Moulding is cutting a shape on the edge or face of the work. Cutting mouldings with a moulding cutterhead is a fast, safe and clean operation. The many different knife shapes available make it possible for the operator to produce almost any kind of mouldings, such as various styles of corner moulds, picture frames, table edges, etc.

The moulding head consists of a cutterhead in which can be mounted various shapes of steel knives, (Fig. 57). Each of the three knives in a set is fitted into a groove in the cutterhead and **securely clamped** with a screw. The knife grooves should be kept free of sawdust which would prevent the cutter from seating properly.

⚠ CAUTION For certain cutting operations (dadoing and moulding) where the workpiece is not cut completely through, the blade guard and splitter assembly cannot be used. Loosen screws (G) and (H) Fig. 58. Lift up and swing blade guard and splitter assembly (W) Fig. 59 to the rear of the saw and retighten (H).

⚠ WARNING Use pushsticks, hold-downs, jigs, fixtures, or featherboards to help guide and control the workpiece when the guard cannot be used.

NOTE: The outside arbor flange cannot be used with the moulding cutterhead. Tighten the arbor nut against the cutterhead body. Do not lose the outside arbor flange. It will be needed when reattaching a blade to the arbor.

⚠ WARNING Always return and fasten the blade guard and splitter assembly to its proper operating position for normal thru-sawing operations.

1. A moulding cutterhead (A) Fig. 60 is shown assembled to the saw arbor.

⚠ WARNING The accessory moulding cutterhead table insert (B) must be used in place of the standard table insert.

2. When using the moulding cutterhead, add wood-facing (C) to the face of the rip fence (Fig. 59). The wood-facing is attached to the fence with wood screws through holes which must be drilled in the fence. Stock that is 3/4" inch thick is suitable for most work, although an occasional job may require 1 inch facing.

3. Position the wood-facing over the cutterhead with the cutterhead below the surface of the table. Turn the saw on and raise the cutterhead. The cutterhead will cut its own groove in the wood-facing.

⚠ WARNING Never use a moulding cutterhead in a bevel position.

⚠ WARNING Never run the stock between the fence and the moulding cutterhead. Irregular shaped wood will cause kickback.

⚠ CAUTION Special attention should be given the grain direction. Make all cuts in the same direction as the grain whenever possible.

⚠ WARNING Always install blade guard after operation is complete.

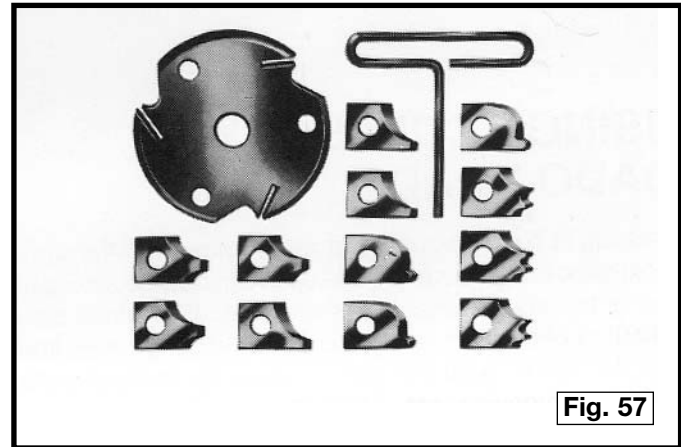

Fig. 57

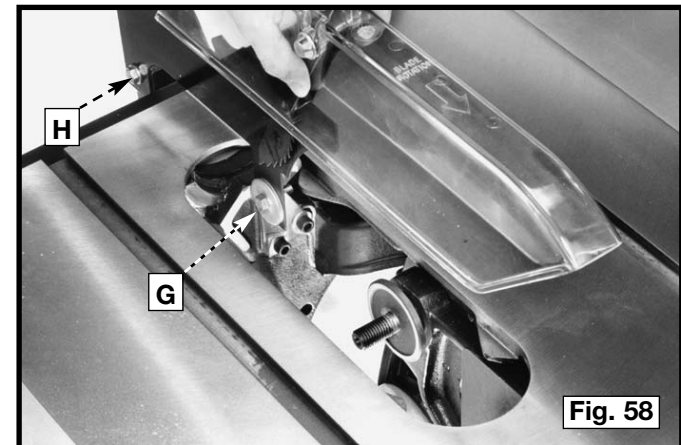

Fig. 58

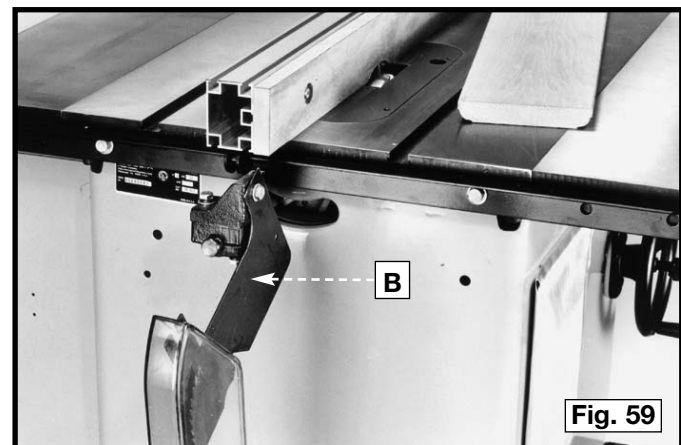

Fig. 59

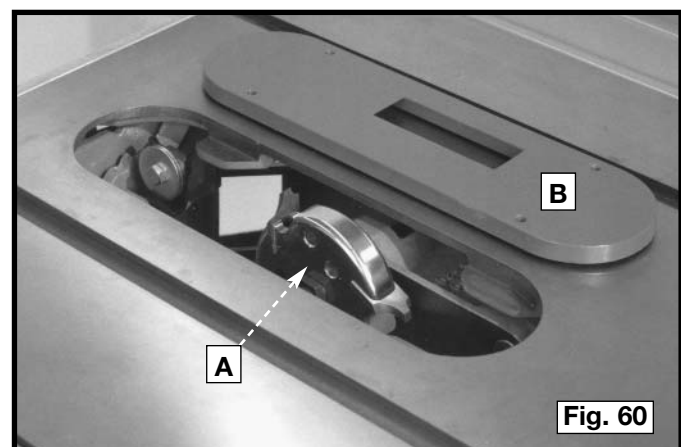

Fig. 60

USING THE ACCESSORY DADO HEAD

⚠ WARNING The blade guard and splitter assembly cannot be used when dadoing or moulding. It must be removed or swung to the rear of the saw as described in "USING ACCESSORY MOULDING CUTTERHEAD" SECTION.

⚠ WARNING Auxiliary jigs, fixtures, push sticks and feather boards should be used.

1. Dadoing is cutting a rabbet or wide groove into the work. Most dado head sets are made up of two outside saws and four or five inside cutters, (Fig. 61). Various combinations of saws and cutters are used to cut grooves from 1/8" to 13/16" for use in shelving, making joints, tenoning, grooving, etc. The cutters are heavily swaged and must be arranged so that this heavy portion falls in the gullets of the outside saws, as shown in Fig. 62. The saw and cutter overlap is shown in Fig. 63, (A) being the outside saw, (B) an inside cutter, and (C) a paper washer or washers, used as needed to control the exact width of groove. A 1/4" groove is cut by using the two outside saws. The teeth of the saws should be positioned so that the raker on one saw is beside the cutting teeth on the other saw.
2. Attach the dado head set (D) Fig. 64, to the saw arbor.

NOTE: The outside arbor flange cannot be used with the dado head set. Tighten the arbor nut against the dado head set body. Do not lose the outside arbor flange. It will be needed when reattaching a blade to the arbor.

⚠ CAUTION The accessory dado head set table insert (E) FIG. 64, must be used in place of the standard table insert.

⚠ WARNING The blade guard and splitter assembly cannot be used when dadoing and must be removed or swung to the rear of the saw as explained previously in this manual. Auxiliary jigs, fixtures, push sticks and feather boards should also be used.

3. Fig. 65 shows a typical dado operation using the miter gauge as a guide.

⚠ CAUTION Never use the dado head in a bevel position.

⚠ WARNING Always install the blade guard after the operation is completed.

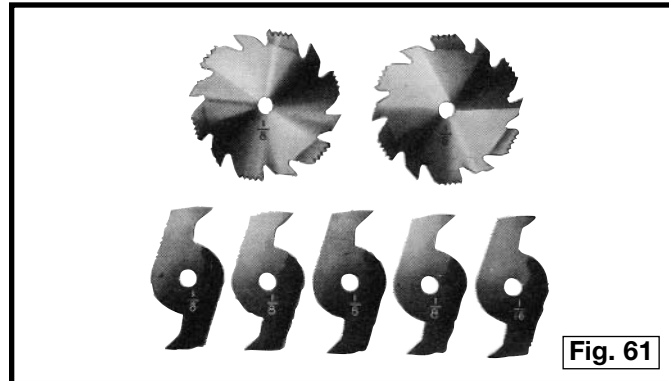

Fig. 61

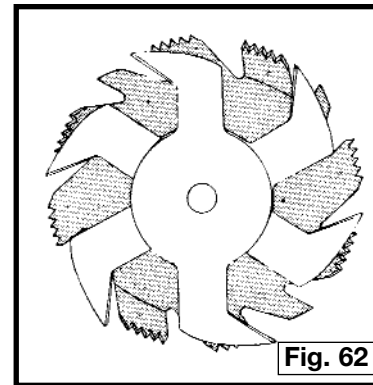

Fig. 62

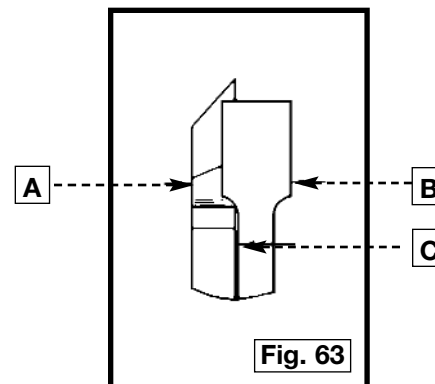

Fig. 63

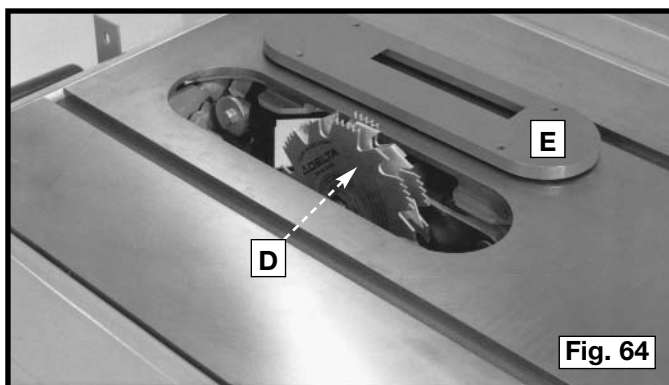

Fig. 64

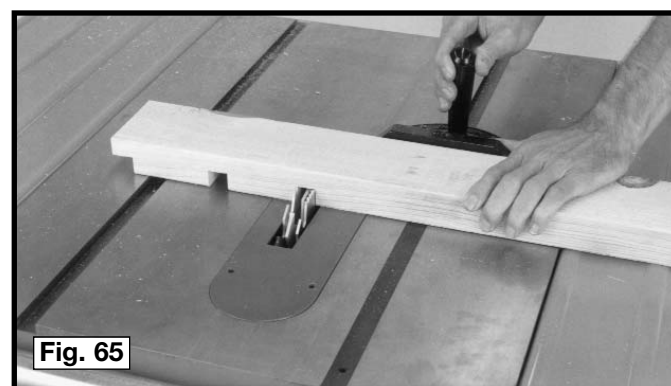

Fig. 65

USING AUXILIARY WOOD FACING ON RIP FENCE

When performing special cutting operations – and that operation may cause the cutting implement to contact the fence – it is necessary to add a wood facing (A) Fig. 145, to one side of the rip fence as shown. The wood facing is attached to the fence with wood screws through holes drilled in the fence. 3/4-inch stock is suitable for most work, although an occasional job may require one-inch facing.

CONSTRUCTING A FEATHERBOARD

Fig. 74, illustrates dimensions for making a typical featherboard. The material which the featherboard is constructed of, should be a straight piece of wood that is free of knots and cracks. Featherboards are used to keep the work in contact with the fence and table and help prevent kickbacks. Clamp the featherboards to the fence and table so that the leading edge of the featherboards will support the workpiece until the cut is completed. Use featherboards for all non "thru-sawing" operations where the guard and spreader assembly must be removed (see Fig. 75). Always replace the guard and spreader assembly when the non thru-sawing operation is completed.

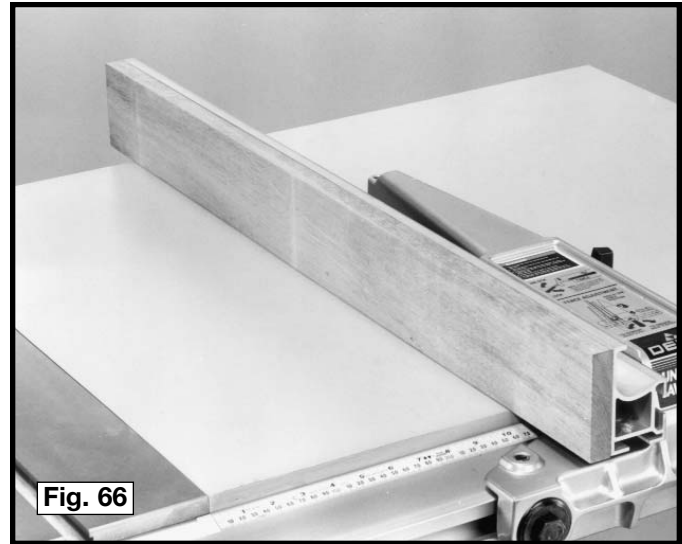

Fig. 66

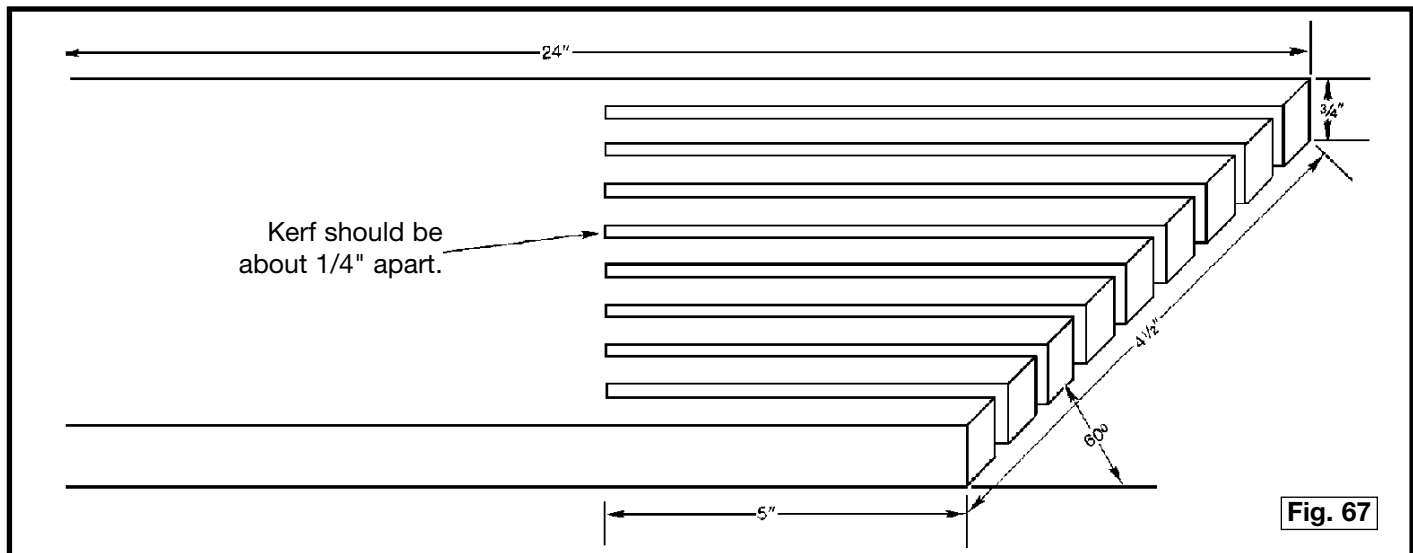

Fig. 67

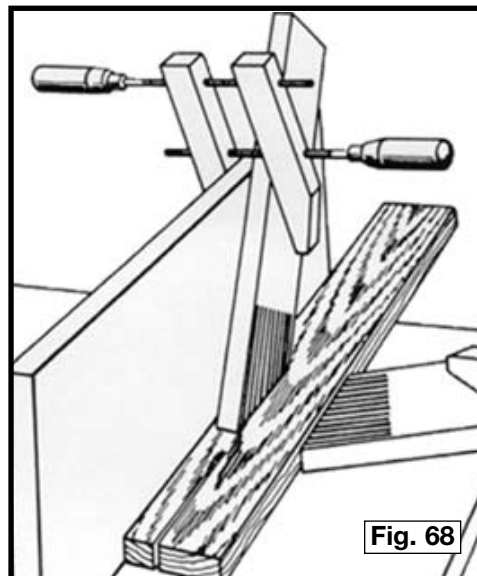
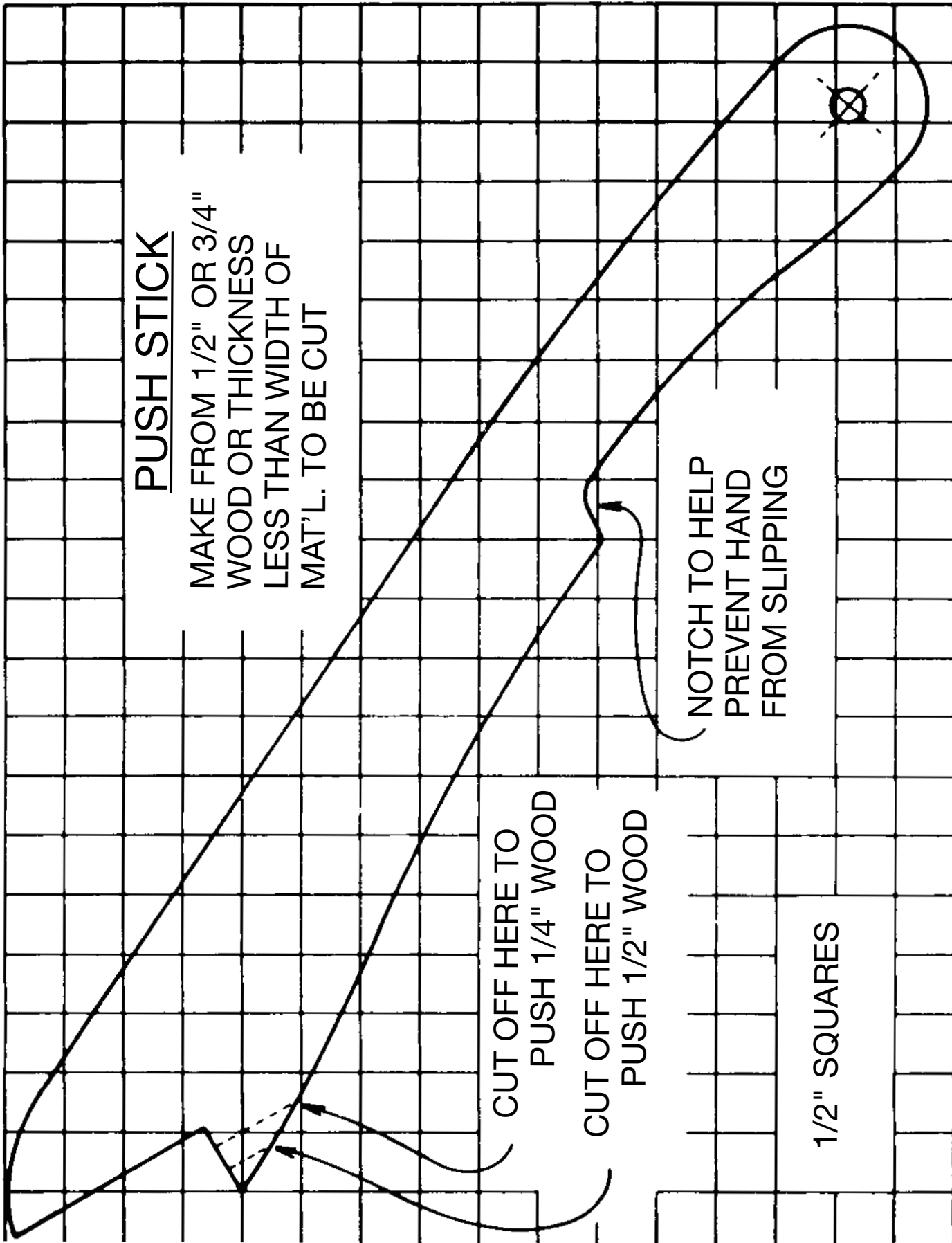

Fig. 68

CONSTRUCTING A PUSH STICK

When ripping work less than 4 inches wide, a push stick should be used to complete the feed and could easily be made from scrap material by following the pattern shown.



TROUBLESHOOTING

For assistance with your machine, visit our website at www.deltamachinery.com for a list of service centers or call the DELTA Machinery help line at 1-800-223-7278 (In Canada call 1-800-463-3582).

MAINTENANCE

CHANGING THE SAW BLADE

▲WARNING DISCONNECT MACHINE FROM POWER SOURCE!

NOTE: Two wrenches are supplied with the saw for changing the saw blade: a box-end wrench and open-end wrench.

1. Remove table insert (C) Fig. 53, and raise saw blade to its maximum height.
2. Place the open end wrench (B) Fig. 53 on the flats of the saw arbor to keep the arbor from turning, and use wrench (A), to turn the arbor nut toward the front of the saw. Remove arbor nut, blade flange, and saw blade.
3. Attach the new blade, making certain the teeth point down at the front of the saw table, and assemble outside blade flange and arbor nut. With wrench (B) Fig. 53, on the flats of the arbor to keep it from turning, **tighten arbor nut** by turning wrench (A) Fig. 54 counterclockwise toward the rear of the saw.
5. Replace table insert. **IMPORTANT:** When installing the table insert, make certain to hold on to the blade guard.

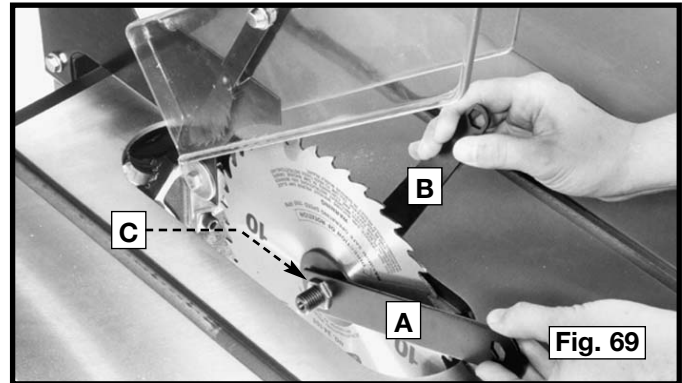

NOTE: Use only 10" saw blades with 5/8" arbor holes, rated for at least 4000 RPM.

REPLACING BELTS AND ADJUSTING BELT TENSION

1. Open the motor cover door to gain access to the motor.
 2. Place a block of wood (C) Fig. 70 between the motor and the saw cabinet.
- NOTE:** You may have to raise the saw arbor to insert the wooden block. Lower the saw arbor until the motor contacts the wood.
3. Loosen the bolt (D) Fig. 70 and continue to lower the saw arbor until all tension is removed from the belts (E). Tighten the bolt (D).
 4. Raise the saw arbor slightly and remove the block of wood (C) Fig. 70.
 5. Lower the saw arbor. Remove the belts (E) Fig. 71, one at a time from the motor pulley.
 6. Remove the belts (E) Fig. 71 one at a time from the arbor pulley (F).
 7. Install the three new belts, one at a time in the grooves of the arbor pulley (F) Fig. 71, and on the motor pulley.
 8. When the new belts are installed, loosen the screw (D) Fig. 70, and carefully let the motor rest on the belts.
 9. The correct belt tension shows approximately 1/4" deflection in the center span of the pulleys, using light finger pressure.
 10. Tighten the screw (D) Fig. 70.

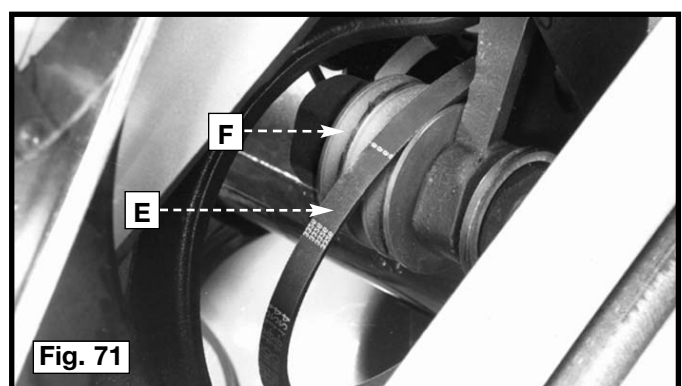
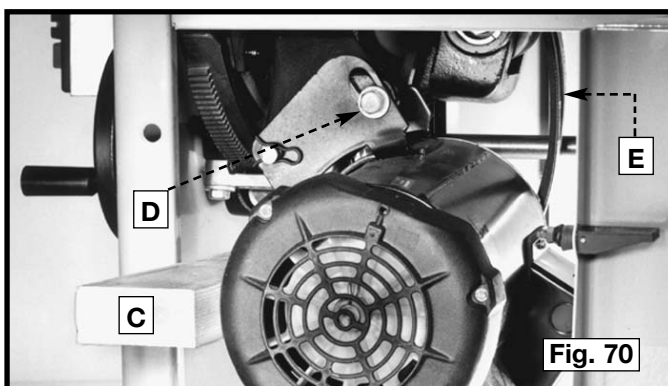

KEEP MACHINE CLEAN

Periodically blow out all air passages with dry compressed air. All plastic parts should be cleaned with a soft damp cloth. NEVER use solvents to clean plastic parts. They could possibly dissolve or otherwise damage the material.

▲WARNING Wear ANSI Z87.1 safety glasses while using compressed air.

FAILURE TO START

Should your machine fail to start, check to make sure the prongs on the cord plug are making good contact in the outlet. Also, check for blown fuses or open circuit breakers in the line.

LUBRICATION

Apply household floor paste wax to the machine table and extension table or other work surface weekly.

PROTECTING CAST IRON FROM RUST

To clean and protect cast iron tables from rust, you will need the following materials: 1 pushblock from a jointer, 1 sheet of medium Scotch-Brite™ Blending Hand Pad, 1 can of WD-40®, 1 can of degreaser, 1 can of TopCote® Aerosol. Apply the WD-40 and polish the table surface with the Scotch-Brite pad using the pushblock as a holddown. Degrease the table, then apply the TopCote® accordingly.

SERVICE



PARTS, SERVICE OR WARRANTY ASSISTANCE

All Delta Machines and accessories are manufactured to high quality standards and are serviced by a network of Porter-Cable • Delta Factory Service Centers and Delta Authorized Service Stations. To obtain additional information regarding your Delta quality product or to obtain parts, service, warranty assistance, or the location of the nearest service outlet, please call 1-800-223-7278 (In Canada call 1-800-463-3582).

ACCESSORIES

A complete line of accessories is available from your Delta Supplier, Porter-Cable • Delta Factory Service Centers, and Delta Authorized Service Stations. Please visit our Web Site www.deltamachinery.com for a catalog or for the name of your nearest supplier.

▲WARNING Since accessories other than those offered by Delta have not been tested with this product, use of such accessories could be hazardous. For safest operation, only Delta recommended accessories should be used with this product.

WARRANTY



Two Year Limited New Product Warranty

Delta will repair or replace, at its expense and at its option, any new Delta machine, machine part, or machine accessory which in normal use has proven to be defective in workmanship or material, provided that the customer returns the product prepaid to a Delta factory service center or authorized service station with proof of purchase of the product within two years and provides Delta with reasonable opportunity to verify the alleged defect by inspection. For all refurbished Delta product, the warranty period is 180 days. Delta may require that electric motors be returned prepaid to a motor manufacturer's authorized station for inspection and repair or replacement. Delta will not be responsible for any asserted defect which has resulted from normal wear, misuse, abuse or repair or alteration made or specifically authorized by anyone other than an authorized Delta service facility or representative. Under no circumstances will Delta be liable for incidental or consequential damages resulting from defective products. This warranty is Delta's sole warranty and sets forth the customer's exclusive remedy, with respect to defective products; all other warranties, express or implied, whether of merchantability, fitness for purpose, or otherwise, are expressly disclaimed by Delta.

PORTER-CABLE • DELTA SERVICE CENTERS (CENTROS DE SERVICIO DE PORTER-CABLE • DELTA)

Parts and Repair Service for Porter-Cable • Delta Machinery are Available at These Locations
(Obtenga Refaccion de Partes o Servicio para su Herramienta en los Siguients Centros de Porter-Cable • Delta)

ARIZONA

Phoenix 85013-2906
4501 N. 7th Ave.
Phone: (602) 279-6414
Fax: (602) 279-5470

CALIFORNIA

Ontario 91761 (Los Angeles)
3949A East Guasti Road
Phone: (909) 390-5555
Fax: (909) 390-5554

San Diego 92111
7290 Clairemont Mesa Blvd.
Phone: (858) 279-2011
Fax: (858) 279-0362

San Leandro 94577 (Oakland)
3039 Teagarden Street
Phone: (510) 357-9762
Fax: (510) 357-7939

COLORADO

Denver 80223
700 West Mississippi Ave.
Phone: (303) 922-8325
Fax: (303) 922-0245

FLORIDA

Davie 33314 (Miami)
4343 South State Rd. 7 (441)
Unit #107
Phone: (954) 321-6635
Fax: (954) 321-6638

Tampa 33634
4909 West Waters Ave.
Phone: (813) 884-0434
Fax: (813) 888-5997

GEORGIA

Forest Park 30297 (Atlanta)
5442 Frontage Road,
Suite 112
Phone: (404) 608-0006
Fax: (404) 608-1123

ILLINOIS

Addison 60101 (Chicago)
400 South Rohlwing Rd.
Phone: (630) 424-8805
Fax: (630) 424-8895

KANSAS

Overland Park 66214
9201 Quivira Road
Phone: (913) 495-4330
Fax: (913) 495-4378

MARYLAND

Elkridge 21075 (Baltimore)
7397-102 Washington Blvd.
Phone: (410) 799-9394
Fax: (410) 799-9398

MASSACHUSETTS

Franklin 02038 (Boston)
Franklin Industrial Park
101E Constitution Blvd.
Phone: (508) 520-8802
Fax: (508) 528-8089

MICHIGAN

Madison Heights 48071 (Detroit)
30475 Stephenson Highway
Phone: (248) 597-5000
Fax: (248) 597-5004

MINNESOTA

Eden Prairie 55344
9709 Valley View Road
Phone: (952) 884-9191
Fax: (952) 884-3750

MISSOURI

St. Louis 63146
11477 Page Service Drive
Phone: (314) 997-9100
Fax: (314) 997-9183

NEW YORK

Flushing 11365-1595 (N.Y.C.)
175-25 Horace Harding Expwy.
Phone: (718) 225-2040
Fax: (718) 423-9619

NORTH CAROLINA

Charlotte 28270
9129 Monroe Road, Suite 115
Phone: (704) 841-1176
Fax: (704) 708-4625

OHIO

Columbus 43229
1948 Schrock Road
Phone: (614) 895-3112
Fax: (614) 895-3187

Parma Heights OH 44130
6485 Pearl Road
Phone: (440) 842-9100
Fax: (440) 884-3430

OREGON

Portland 97230
14811 North East Airport Way
Phone: (503) 255-6556
Fax: (503) 255-6543

PENNSYLVANIA

Willow Grove 19090
(Philadelphia)
520 North York Road
Phone: (215) 658-1430
Fax: (215) 658-1433

TEXAS

Carrollton 75006 (Dallas)
1300 Interstate 35 N, Suite 112
Phone: (972) 446-2996
Fax: (972) 446-8157

Houston 77022-2122
536 East Tidwell Rd.
Phone: (713) 692-7111
Fax: (713) 692-1107

WASHINGTON

Auburn 98001 (Seattle)
3320 West Valley HWY, North
Building D, Suite 111
Phone: (253) 333-8353
Fax: (253) 333-9613

Authorized Service Stations are located in many large cities. Telephone **800-438-2486** or **731-541-6042** for assistance locating one. Parts and accessories for Porter-Cable•Delta products should be obtained by contacting any Porter-Cable•Delta Distributor, Authorized Service Center, or Porter-Cable•Delta Factory Service Center. If you do not have access to any of these, call **800-223-7278** and you will be directed to the nearest Porter-Cable•Delta Factory Service Center. Las Estaciones de Servicio Autorizadas están ubicadas en muchas grandes ciudades. Llame al **800-438-2486** ó al **731-541-6042** para obtener asistencia a fin de localizar una. Las piezas y los accesorios para los productos Porter-Cable•Delta deben obtenerse poniéndose en contacto con cualquier distribuidor Porter-Cable•Delta, Centro de Servicio Autorizado o Centro de Servicio de Fábrica Porter-Cable•Delta. Si no tiene acceso a ninguna de estas opciones, llame al **800-223-7278** y le dirigirán al Centro de Servicio de Fábrica Porter-Cable•Delta más cercano.

CANADIAN PORTER-CABLE • DELTA SERVICE CENTERS

ALBERTA

Bay 6, 2520-23rd St. N.E.
Calgary, Alberta
T2E 8L2
Phone: (403) 735-6166
Fax: (403) 735-6144

BRITISH COLUMBIA

8520 Baxter Place
Burnaby, B.C.
V5A 4T8
Phone: (604) 420-0102
Fax: (604) 420-3522

MANITOBA

1699 Dublin Avenue
Winnipeg, Manitoba
R3H 0H2
Phone: (204) 633-9259
Fax: (204) 632-1976

ONTARIO

505 Southgate Drive
Guelph, Ontario
N1H 6M7
Phone: (519) 767-4132
Fax: (519) 767-4131

QUÉBEC

1515 ave.
St-Jean Baptiste, Suite 160
Québec, Québec
G2E 5E2
Phone: (418) 877-7112
Fax: (418) 877-7123

1447, Begin
St-Laurent, (Montréal),
Québec
H4R 1V8
Phone: (514) 336-8772
Fax: (514) 336-3505

The following are trademarks of PORTER-CABLE • DELTA (Las siguientes son marcas registradas de PORTER-CABLE • DELTA S.A.) (Les marques suivantes sont des marques de fabricant de la PORTER-CABLE • DELTA): Auto-Set®, BAMMER®, B.O.S.S.®, Builder's Saw®, Contractor's Saw®, Contractor's Saw II™, Delta®, DELTACRAFT®, DELTAGRAM™, Delta Series 2000™, DURATRONIC™, Emc²™, FLEX®, Flying Chips™, FRAME SAW®, Grip Vac™, Homecraft®, INNOVATION THAT WORKS®, Jet-Lock®, JETSTREAM®, 'kickstand®, LASERLOC®, MICRO-SET®, Micro-Set®, MIDI LATHE®, MORTEN™, NETWORK™, OMNIJIG®, POCKET CUTTER®, PORTA-BAND®, PORTA-PLANE®, PORTER-CABLE®&(design), PORTER-CABLE®PROFESSIONAL POWER TOOLS, PORTER-CABLE REDEFINING PERFORMANCE™, Posi-Matic®, Q-3®&(design), QUICKSAND®&(design), QUICKSET™, QUICKSET II®, QUICKSET PLUS™, RIPTIDE™&(design), SAFE GUARD II®, SAFE-LOC®, Sanding Center®, SANDTRAP®&(design), SAW BOSS®, Sawbuck™, Sidekick®, SPEED-BLOC®, SPEEDMATIC®, SPEEDTRONIC®, STAIR EASE®, The American Woodshop®&(design), The Lumber Company®&(design), THE PROFESSIONAL EDGE®, THE PROFESSIONAL SELECT®, THIN-LINE™, TIGER®, TIGER CUB®, TIGER SAW®, TORQBUSTER®, TORQ-BUSTER®, TRU-MATCH™, TWIN-LITE®, UNIGUARD®, Unifence®, UNIFEEDER™, Unihead®, Uniplane™, Unirip®, Unisaw®, Univise®, Versa-Feeder®, VERSA-PLANE®, WHISPER SERIES®, WOODWORKER'S CHOICE™.

Trademarks noted with ™ and ® are registered in the United States Patent and Trademark Office and may also be registered in other countries. Las Marcas Registradas con el signo de ™ y ® son registradas por la Oficina de Registros y Patentes de los Estados Unidos y también pueden estar registradas en otros países.