

DENON

AV SURROUND RECEIVER

AVR-1910

Owner's Manual

Manuel de l'Utilisateur

※ The illustrations used for explaining operations in this manual show the buttons of the remote control unit.
The same operations can be performed using the buttons with the same names on the main unit panel.

※ Les illustrations des boutons présentes dans ce manuel servent à expliquer le fonctionnement de la télécommande.
Vous pouvez contrôler l'appareil à l'aide du bouton portant le même nom sur la façade de l'appareil.

SAFETY PRECAUTIONS



CAUTION
RISK OF ELECTRIC SHOCK
DO NOT OPEN



CAUTION:
TO REDUCE THE RISK OF ELECTRIC SHOCK, DO NOT REMOVE COVER (OR BACK). NO USER-SERVICEABLE PARTS INSIDE. REFER SERVICING TO QUALIFIED SERVICE PERSONNEL.

The lightning flash with arrowhead symbol, within an equilateral triangle, is intended to alert the user to the presence of uninsulated "dangerous voltage" within the product's enclosure that may be of sufficient magnitude to constitute a risk of electric shock to persons.

The exclamation point within an equilateral triangle is intended to alert the user to the presence of important operating and maintenance (servicing) instructions in the literature accompanying the appliance.

WARNING:
TO REDUCE THE RISK OF FIRE OR ELECTRIC SHOCK, DO NOT EXPOSE THIS APPLIANCE TO RAIN OR MOISTURE.



CAUTION:
HOT SURFACE. DO NOT TOUCH.
 The top surface over the internal heat sink may become hot when operating this product continuously.

PRECAUTION:
SURFACE CHAUDE. NE PAS TOUCHER.
 La surface supérieure du dissipateur de chaleur peut devenir chaude si vous utilisez ce produit en continu.

IMPOTANT SAFETY INSTRUCTIONS

1. Read these instructions.
2. Keep these instructions.
3. Heed all warnings.
4. Follow all instructions.
5. Do not use this apparatus near water.
6. Clean only with dry cloth.
7. Do not block any ventilation openings.
 Install in accordance with the manufacturer's instructions.
8. Do not install near any heat sources such as radiators, heat registers, stoves, or other apparatus (including amplifiers) that produce heat.
9. Do not defeat the safety purpose of the polarized or grounding-type plug. A polarized plug has two blades with one wider than the other. A grounding type plug has two blades and a third grounding prong. The wide blade or the third prong are provided for your safety. If the provided plug does not fit into your outlet, consult an electrician for replacement of the obsolete outlet.
10. Protect the power cord from being walked on or pinched particularly at plugs, convenience receptacles, and the point where they exit from the apparatus.
11. Only use attachments/accessories specified by the manufacturer.
12. Use only with the cart, stand, tripod, bracket, or table specified by the manufacturer, or sold with the apparatus. When a cart is used, use caution when moving the cart/apparatus combination to avoid injury from tip-over.
13. Unplug this apparatus during lightning storms or when unused for long periods of time.
14. Refer all servicing to qualified service personnel. Servicing is required when the apparatus has been damaged in any way, such as power-supply cord or plug is damaged, liquid has been spilled or objects have fallen into the apparatus, the apparatus has been exposed to rain or moisture, does not operate normally, or has been dropped.
15. Batteries shall not be exposed to excessive heat such as sunshine, fire or the like.



CAUTION:

- The ventilation should not be impeded by covering the ventilation openings with items, such as newspapers, tablecloths, curtains, etc.
- No naked flame sources, such as lighted candles, should be placed on the unit.
- Observe and follow local regulations regarding battery disposal.
- Do not expose the unit to dripping or splashing fluids.
- Do not place objects filled with liquids, such as vases, on the unit.

ATTENTION:

- La ventilation ne doit pas être gênée en recouvrant les ouvertures de la ventilation avec des objets tels que journaux, rideaux, tissus, etc.
- Aucune flamme nue, par exemple une bougie, ne doit être placée sur l'appareil.
- Veillez à respecter les lois en vigueur lorsque vous jetez les piles usagées.
- L'appareil ne doit pas être exposé à l'eau ou à l'humidité.
- Ne pas poser d'objet contenant du liquide, par exemple un vase, sur l'appareil.

CAUTION:
 To completely disconnect this product from the mains, disconnect the plug from the wall socket outlet. The mains plug is used to completely interrupt the power supply to the unit and must be within easy access by the user.

PRECAUTION:
 Pour déconnecter complètement ce produit du courant secteur, débranchez la prise de la prise murale. La prise secteur est utilisée pour couper complètement l'alimentation de l'appareil et l'utilisateur doit pouvoir y accéder facilement.

FCC INFORMATION (For US customers)

1. PRODUCT

This product complies with Part 15 of the FCC Rules. Operation is subject to the following two conditions: (1) this product may not cause harmful interference, and (2) this product must accept any interference received, including interference that may cause undesired operation.

2. IMPORTANT NOTICE: DO NOT MODIFY THIS PRODUCT

This product, when installed as indicated in the instructions contained in this manual, meets FCC requirements. Modification not expressly approved by DENON may void your authority, granted by the FCC, to use the product.

3. NOTE





This product has been tested and found to comply with the limits for a Class B digital device, pursuant to Part 15 of the FCC Rules. These limits are designed to provide reasonable protection against harmful interference in a residential installation.

This product generates, uses and can radiate radio frequency energy and, if not installed and used in accordance with the instructions, may cause harmful interference to radio communications. However, there is no guarantee that interference will not occur in a particular installation. If this product does cause harmful interference to radio or television reception, which can be determined by turning the product OFF and ON, the user is encouraged to try to correct the interference by one or more of the following measures:

- Reorient or relocate the receiving antenna.
- Increase the separation between the equipment and receiver.
- Connect the product into an outlet on a circuit different from that to which the receiver is connected.
- Consult the local retailer authorized to distribute this type of product or an experienced radio/TV technician for help.

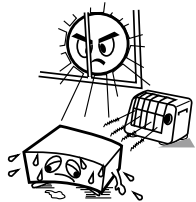
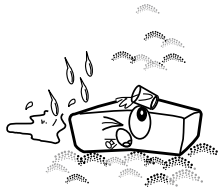
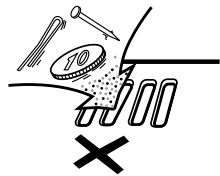
This Class B digital apparatus complies with Canadian ICES-003.
Cet appareil numérique de la classe B est conforme à la norme NMB-003 du Canada.

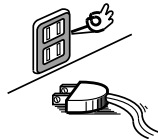
NOTE ON USE / OBSERVATIONS RELATIVES A L'UTILISATION

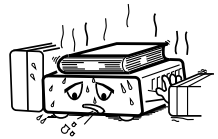
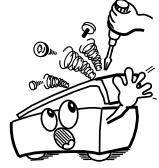
 <ul style="list-style-type: none"> • Avoid high temperatures. Allow for sufficient heat dispersion when installed in a rack. • Eviter des températures élevées. Tenir compte d'une dispersion de chaleur suffisante lors de l'installation sur une étagère. 	 <ul style="list-style-type: none"> • Keep the unit free from moisture, water, and dust. • Protéger l'appareil contre l'humidité, l'eau et la poussière. 	 <ul style="list-style-type: none"> • Do not let foreign objects into the unit. • Ne pas laisser des objets étrangers dans l'appareil.
 <ul style="list-style-type: none"> • Handle the power cord carefully. Hold the plug when unplugging the cord. • Manipuler le cordon d'alimentation avec précaution. Tenir la prise lors du débranchement du cordon. 	 <ul style="list-style-type: none"> • Unplug the power cord when not using the unit for long periods of time. • Débrancher le cordon d'alimentation lorsque l'appareil n'est pas utilisé pendant de longues périodes. 	 <ul style="list-style-type: none"> • Do not let insecticides, benzene, and thinner come in contact with the unit. • Ne pas mettre en contact des insecticides, du benzène et un diluant avec l'appareil.
 <ul style="list-style-type: none"> • Handle the power cord carefully. Hold the plug when unplugging the cord. • Manipuler le cordon d'alimentation avec précaution. Tenir la prise lors du débranchement du cordon. 	 <p>* (For apparatuses with ventilation holes)</p> <ul style="list-style-type: none"> • Do not obstruct the ventilation holes. • Ne pas obstruer les trous d'aération. 	 <ul style="list-style-type: none"> • Never disassemble or modify the unit in any way. • Ne jamais démonter ou modifier l'appareil d'une manière ou d'une autre.

Contents

Getting Started	
Flow of operations through playback	2
Accessories	2
Cautions on Handling	3
Cautions on Installation	3
About the Remote Control Unit	3
Inserting the Batteries	3
Operating Range of the Remote Control Unit	3
Part Names and Functions	4
Front Panel	4
Display	5
Rear Panel	6
Remote Control Unit	7
Connections	
Important Information	8
Cables Used for Connections	8
Converting Input video signals for Output (Video Conversion Function)	9
How the on-screen display is displayed depending on the video input signal	9
Installing/Setting the Speakers	10
Connecting the Speakers	11
Connecting Devices	12
Connecting Devices not Equipped with HDMI terminals	13
Once Connections are Completed	17
Turning the Power On	17
Turning the Power Off	17
Settings	
Menu map	18
Examples of On-screen Display and Front Display	19
Making the Optimum Settings for the Connected Speakers Automatically (Audyssey Auto Setup)	20
Making detailed settings (Manual Setup)	25
Making the input settings (Input Setup)	32

Playback

Playing Components	38
Playing Blu-ray Disc / DVD Players	38
iPod® Playback	38
Listening to FM/AM Broadcasts	39
Listening to SIRIUS Satellite Radio Programs	40
Operations During Playback	42
Selecting the Surround Mode	42
① Playing sources according to the sources' audio signal format/number of channels (Standard Playback)	42
② Playing in a DENON original surround mode	43
③ Direct Playback	43
④ Stereo Playback	44
⑤ Playing the Pure Direct mode	44
Adjusting the Sound Field Effects (Parameter)	44
Adjusting the sound field effects (Surround Parameter)	44
Adjusting the tone (Tone Control)	46
Making the MultEQ, Dynamic EQ and Dynamic Volume settings (Audyssey Settings)	46
Adjust tonal quality for each speaker using graphic equalizer (Manual EQ)	47
Restoring compressed audio to nearly pre-compressed conditions for playback (RESTORER)	48
Adjusting the audio delay time while watching the picture (Audio Delay)	48

Checking the Status (Information)

Convenient functions

HDMI Control Function	49
Setting the power to standby after a certain amount of time (Sleep Timer Function)	49
Adjust the volume of the different speakers	50
Saving frequently used settings (Quick Select Function)	50
MAIN ZONE settings	50
ZONE2 settings	50
Various memory functions	50

Playing 2-Channel Sound in ZONE2 (multizone function)

Operating the Connected Devices by Remote Control Unit

Registering Preset Codes	52
Operating Registered Devices	52
Assigning buttons that are Not Used to Operate Other Devices (Punch Through Function)	54

Other Information

Troubleshooting

Restoring all the settings to as they were at the time of purchase (Resetting the Microprocessor)	64
--	----

Specifications

List of preset codes

End of this manual

Getting Started

Flow of operations through playback

Perform the operations leading to playback on the AVR-1910 in the order shown below.

Connections

Installing/Setting the Speakers (☞ page 10)



Connecting the Speakers (☞ page 11)



Connecting Devices (☞ page 12)



Turning the Power On (☞ page 17)



Settings

Audyssey Auto Setup (☞ page 20)



Manual Setup (☞ page 25)

※ Perform "Manual Setup" as necessary.



Input Setup (☞ page 32)



Playback

Playing Components (☞ page 38)



Selecting the Surround Mode (☞ page 42)



Adjusting the Sound Field Effects (☞ page 44)

Thank you for purchasing this DENON product. To ensure proper operation, please read this owner's manual carefully before using the product. After reading them, be sure to keep them for future reference.

Accessories

Check that the following parts are supplied with the product.

- ① Owner's manual 1
- ② Getting Started 1
- ③ Warranty (for North America model only) 1
- ④ Service station list 1
- ⑤ Remote control (RC-1117) 1
- ⑥ R6/AA batteries 2
- ⑦ FM indoor antenna 1
- ⑧ AM loop antenna 1
- ⑨ Setup microphone (DM-A409, Cord length: Approx. 25 ft / 7.6 m) 1

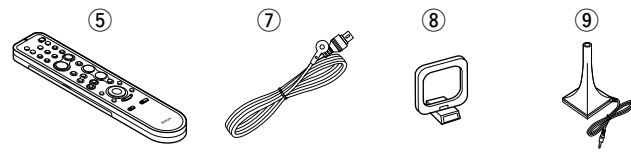

Cautions on Handling

• Before turning the power switch on

Check once again that all connections are correct and that there are no problems with the connection cables.

- Power is supplied to some of the circuitry even when the unit is set to the standby mode. When traveling or leaving home for long periods of time, be sure to unplug the power cord from the power outlet.

• About condensation

If there is a major difference in temperature between the inside of the unit and the surroundings, condensation (dew) may form on the operating parts inside the unit, causing the unit not to operate properly.

If this happens, let the unit sit for an hour or two with the power turned off and wait until there is little difference in temperature before using the unit.

• Cautions on using mobile phones

Using a mobile phone near this unit may result in noise. If so, move the mobile phone away from this unit when it is in use.

• Moving the unit

Turn off the power and unplug the power cord from the power outlet.

Next, disconnect the connection cables to other system units before moving the unit.

- Note that the illustrations in these instructions may differ from the actual unit for explanation purposes.

Cautions on Installation

Note:

For proper heat dispersal, do not install this unit in a confined space, such as a bookcase or similar enclosure.

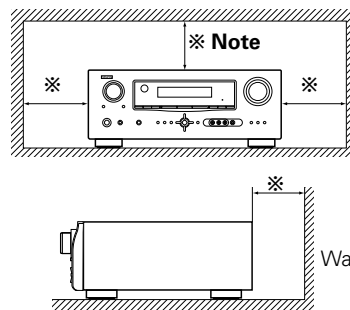

About the Remote Control Unit

In addition to the AVR-1910, the included remote control unit (RC-1117) can also be used to operate the equipment listed below.

- ① DENON system components
- ② Non-DENON system components
 - By setting the preset memory (page 52)

Inserting the Batteries

- ① Lift the clasp and remove the rear cover.
- ② Load the two batteries properly as indicated by the marks in the battery compartment.

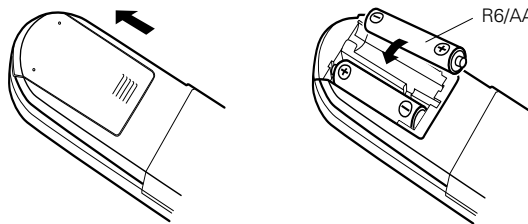

- ③ Put the rear cover back on.

NOTE

- Replace the batteries with new ones if the set does not operate even when the remote control unit is operated close to the unit.
- The supplied batteries are only for verifying operation.
- When inserting the batteries, be sure to do so in the proper direction, following the “⊕” and “⊖” marks in the battery compartment.
- To prevent damage or leakage of battery fluid:
 - Do not use a new battery together with an old one.
 - Do not use two different types of batteries.
 - Do not attempt to charge dry batteries.
 - Do not short-circuit, disassemble, heat or dispose of batteries in flames.
- If the battery fluid should leak, carefully wipe the fluid off the inside of the battery compartment and insert new batteries.
- Remove the batteries from the remote control unit if it will not be in use for long periods.
- Used batteries should be disposed of in accordance with the local regulations regarding battery disposal.

Operating Range of the Remote Control Unit

Point the remote control unit at the remote sensor when operating it.

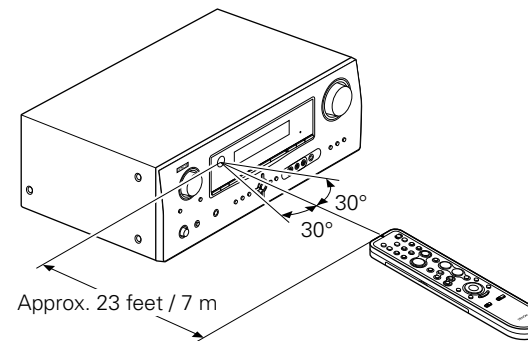

NOTE

The set may function improperly or the remote control unit may not operate if the remote control sensor is exposed to direct sunlight, strong artificial light from an inverter type fluorescent lamp or infrared light.

Part Names and Functions

Front Panel

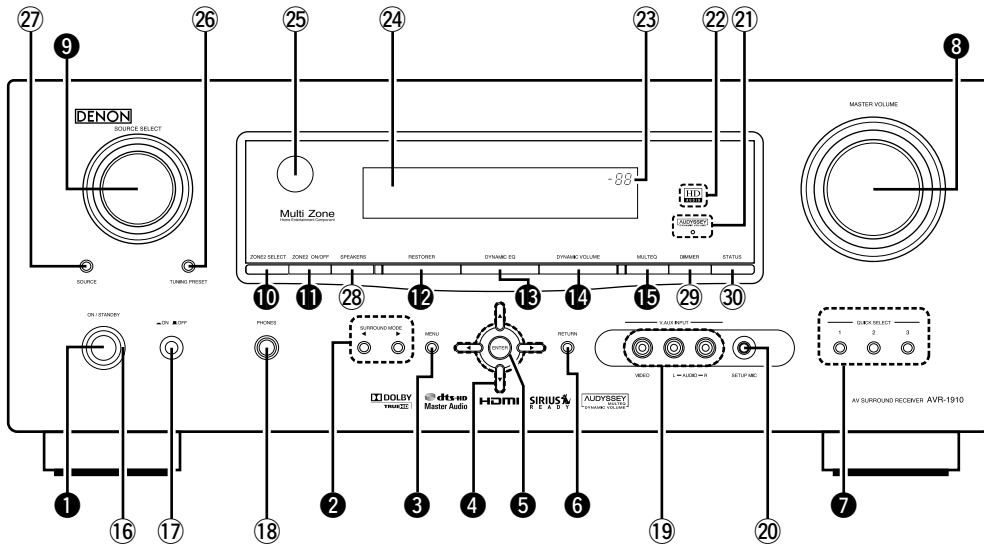

Buttons, terminals and displays only provided on the main unit

- | | |
|---|--|
| 16 Power indicator (17) | 23 MASTER VOLUME indicator (3) |
| 17 Power switch (ON/OFF) (17, 64) | 24 Display |
| 18 Headphones jack (PHONES) (42) | 25 Remote control sensor (3) |
| 19 V. AUX INPUT connectors (16) | 26 TUNING PRESET button (41) |
| 20 SETUP MIC jack (21) | 27 SOURCE MODE SELECT button (38) |
| 21 AUDYSSEY DYNAMIC VOLUME indicator (47) | 28 FRONT SPEAKERS SELECT button (42) |
| 22 HD AUDIO indicator (43) | 29 DIMMER button (31) |
| | 30 STATUS button (48) |

Button that function in the same way as remote control buttons

For buttons not explained here, see the page indicated in parentheses ().

- | | |
|--|---|
| 1 Power operation button (ON/STANDBY) (17) | 8 MASTER VOLUME control knob (38) |
| 2 SURROUND MODE buttons (42) | 9 SOURCE SELECT knob (38) |
| 3 MENU button (18) | 10 ZONE2 SELECT button (51) |
| 4 Cursor buttons (Δ ∇ ◀ ▶) (18) | 11 ZONE2 ON/OFF button (51) |
| 5 ENTER button (18) | 12 RESTORER button (48) |
| 6 RETURN button (18) | 13 DYNAMIC EQ button (47) |
| 7 QUICK SELECT buttons (50) | 14 DYNAMIC VOLUME button (47) |
| | 15 MUTEQ button (46) |

Buttons that function in the same way as Front Panel buttons

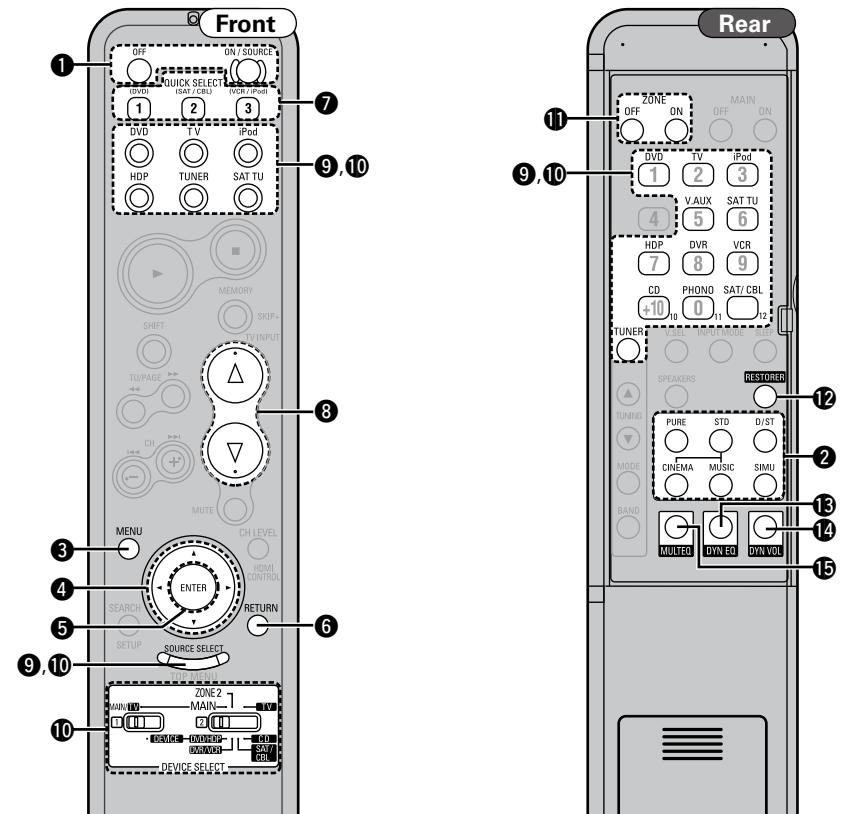

Display

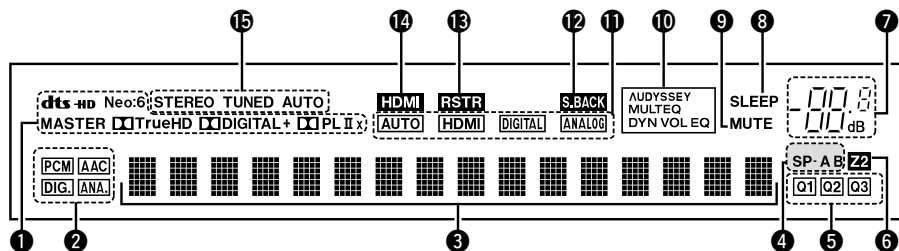

1 Decoder indicators

The indicator for the currently operating decoder lights.

2 Input audio signal indicators

3 Information display

The input source name, surround mode, setting values and other information are displayed here.

4 Front speaker indicator

These light according to the settings of the front A and B speakers (page 42).

5 QUICK SELECT indicators

These light when the Quick Select function is set (page 50).

6 ZONE2 indicator

Lights when signals are being output to the ZONE2 (page 51).

7 Master volume indicator

When performing setting operations, displays the menu number.

8 SLEEP TIMER indicator

Lights when the sleep timer is operating (page 49).

9 MUTE indicator

Lights when the muting mode is set (page 42).

10 AUDYSSEY indicator

These light as shown below in the different modes (page 46).

AUDYSSEY MULTIEQ : During "MultEQ" operation

AUDYSSEY MULTIEQ DYN EQ : During "MultEQ", "Dynamic EQ" operation

AUDYSSEY MULTIEQ DYN VOL : During "MultEQ", "Dynamic EQ", "Dynamic Volume" operation

※When speaker settings are changed after the Audyssey Auto Setup procedure, either the indicators' frame turns off or all the indicators turn off.

11 Input mode indicators

12 S.BACK indicator

Lights when audio signals are being output from the surround back speakers (page 26).

13 RESTORER indicator

Lights during "RESTORER" operation (page 48).

14 HDMI indicator

Lights when HDMI input signals are detected (page 13).

15 Tuner reception mode indicators

This lights according to the reception conditions when the input source is set to "TUNER".

• AUTO

This lights when in the auto tuning mode.

• STEREO

In the FM mode, this lights when receiving analog stereo broadcasts.

• TUNED

This lights when the broadcast is properly tuned in.

Rear Panel

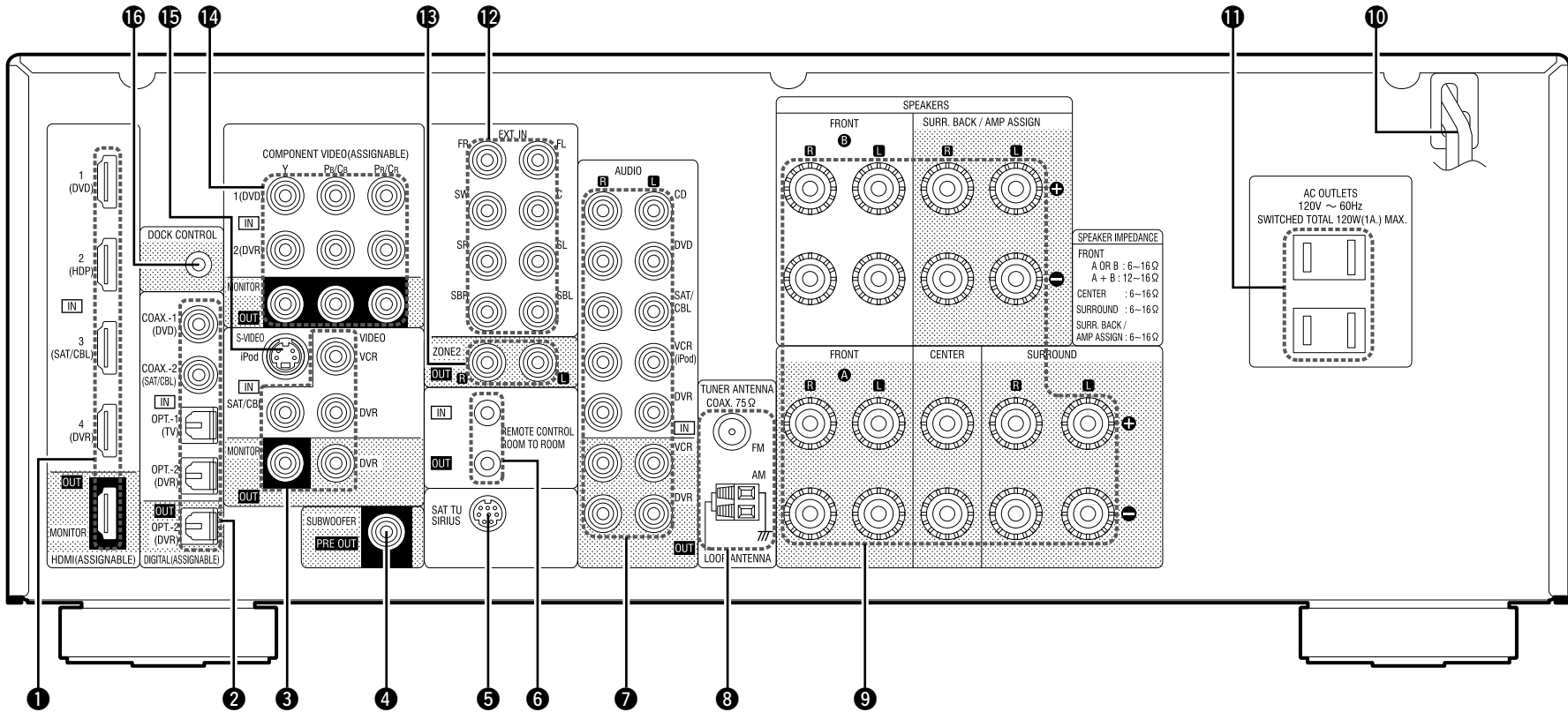

- ❶ HDMI connectors (13)
- ❷ Digital audio connectors (14)
- ❸ VIDEO connectors (15)
- ❹ PRE OUT connector (11)
- ❺ SIRIUS connector (16)

- ❻ REMOTE CONTROL jacks
Connect a device that supports the remote control function.

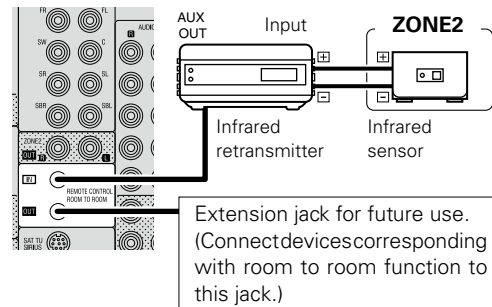

- ❼ Analog audio connectors (14)
- ❽ FM/AM antenna terminals (17)
- ❾ Speaker terminals (11)
- ❿ Power cord (17)
- ⓫ AC OUTLET (17)
- ⓬ EXT. IN connectors (16)

- Ⓜ ZONE2 connectors (51)
- Ⓨ COMPONENT VIDEO connectors (14)
- Ⓩ Control Dock for iPod S-Video input terminal (14)
- ⓐ Control Dock for iPod DOCK CONTROL jack (14)

Remote Control Unit

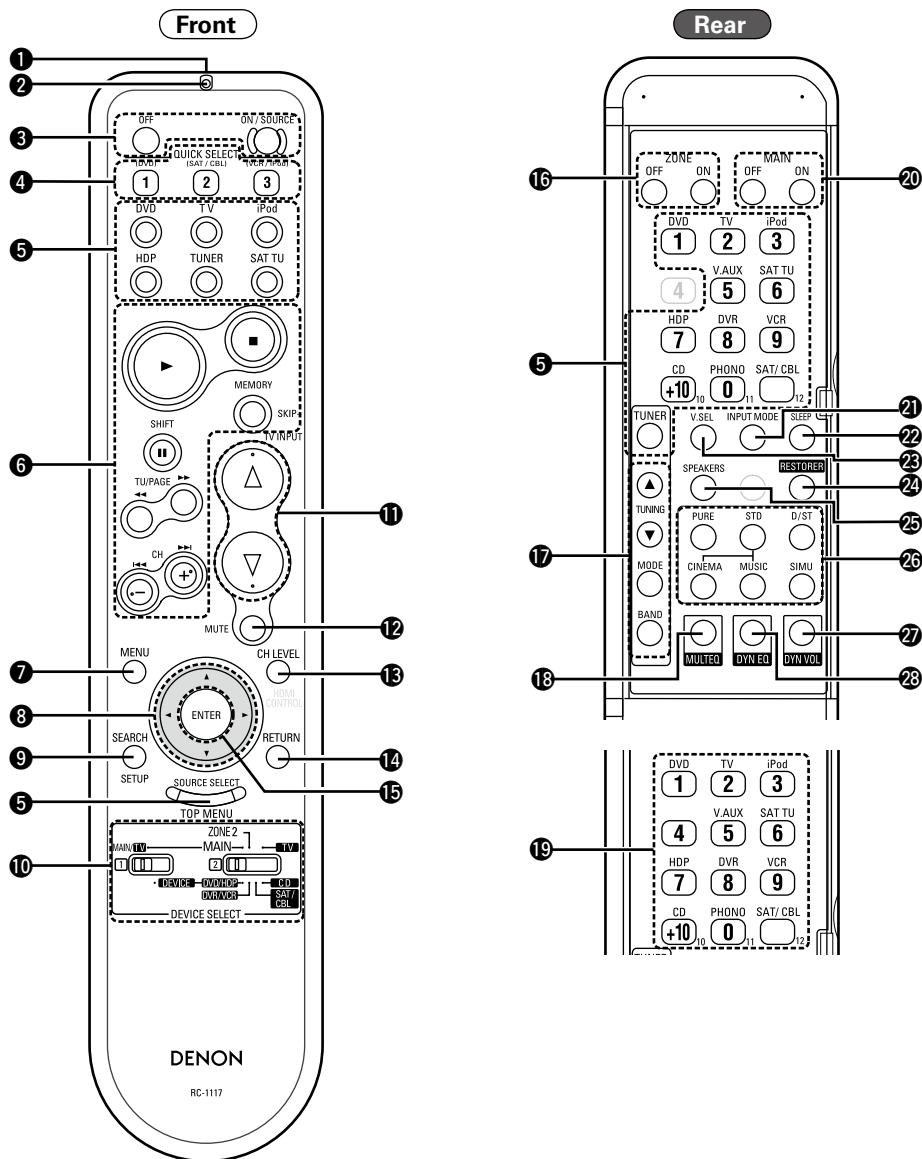

- 1 Remote control signal transmitter
- 2 Indicator
- 3 Power buttons
- 4 QUICK SELECT buttons
- 5 SOURCE SELECT button
- 6 System buttons
- 7 MENU button
- 8 Cursor buttons (Δ ∇ ◀ ▶)
- 9 SEARCH button
- 10 DEVICE SELECT switches
- 11 Master volume control buttons
- 12 MUTING button
- 13 Channel level adjustment button
- 14 RETURN button
- 15 ENTER button
- 16 ZONE2 power button
- 17 Tuner operation buttons
- 18 MULTEQ button
- 19 Number buttons (0 ~ 9, +10)
- 20 MAIN ZONE power buttons
- 21 INPUT MODE button
- 22 SLEEP TIMER button
- 23 VIDEO SELECT button
- 24 RESTORER button
- 25 FRONT HEIGHT SPEAKER ON/OFF button
- 26 Surround mode buttons
- 27 DYNAMIC VOLUME button
- 28 DYNAMIC EQ button



For buttons not explained here, see the page indicated in parentheses ().

NOTE

Buttons on the back panel may operate when the back lid is pressed.

Operations possible by remote control

- Operations on the AVR-1910
- Operations on six devices other than the AVR-1910

- Preset the remote control codes of the devices to be operated (page 52).
- Switch two device selector switches according to the devices to be operated.

Position of switches		Operable devices
		AVR-1910 (ZONE2) TV
		Blu-ray disc player or DVD Player DVD recorder or Video deck
		Satellite receiver or Cable TV
		CD player

- ZONE2 operations (page 51)
- Punch through setting (page 54)

Connections

Connection Flow

Installing/Setting the Speakers (page 10)



Connecting the Speakers (page 11)



Connecting Devices (page 12)



Connecting Devices not Equipped with HDMI terminals (page 13)

- HDMI** (page 12)
- Monitor (TV)** (page 13)
- Playback Components**
 - Blu-ray Disc player / DVD player (page 14)
 - iPod® (page 14)
 - CD Player (page 14)
- Recording Components**
 - DVD Recorder (page 15)
 - Video Cassette Recorder (page 15)
- SAT/CABLE Tuner** (page 15)
- Other Devices**
 - Video Camera / Game Console (page 16)
 - Component with Multi-channel Output connectors (page 16)
 - SIRIUS Connector (page 16)
 - Antenna terminals (page 17)
- Power Cord**



Turning the Power On (page 17)

Important Information

Connections for all compatible audio and video signal formats are described in this owner's manual. Please select the types of connections suited for the equipment you are connecting.

After connections are completed, certain settings must be made on the receiver. Make the settings indicated "Set as necessary" for the individual items.

NOTE

- Do not plug in the power cord until all connections have been completed.
- When making connections, also refer to the operating instructions of the other components.
- Be sure to connect the left and right channels properly (left with left, right with right).
- Do not bundle power cords together with connection cables. Doing so can result in humming or noise.

Cables Used for Connections

Select the cables according to the equipment being connected.

Audio and video cables	
HDMI connections	HDMI cable
Audio cables	
Coaxial digital connections	Coaxial digital cable
Optical digital connections	Optical cable
Analog connections	(White) (L) (R) (Red) (L) (R) Stereo pin-plug cable
Analog connections (monaural, for subwoofer)	Pin-plug cable
Speaker connections	Speaker cables
Video cables	
Component video connections	(Green) (Blue) (Red) Component video cable
S-Video connections	S-Video cable
Video connections	(Yellow) 75 Ω/ohms pin-plug video cable

Converting Input video signals for Output (Video Conversion Function)

The AVR-1910 is equipped with four types of video input terminals (HDMI, Component video, S-Video and video) and three types of video output terminals (HDMI, Component video and video). Use the terminals according to the devices to be connected.

This function automatically converts various formats of video signals input to the AVR-1910 into the format used to output the video signals from the AVR-1910 to a monitor.

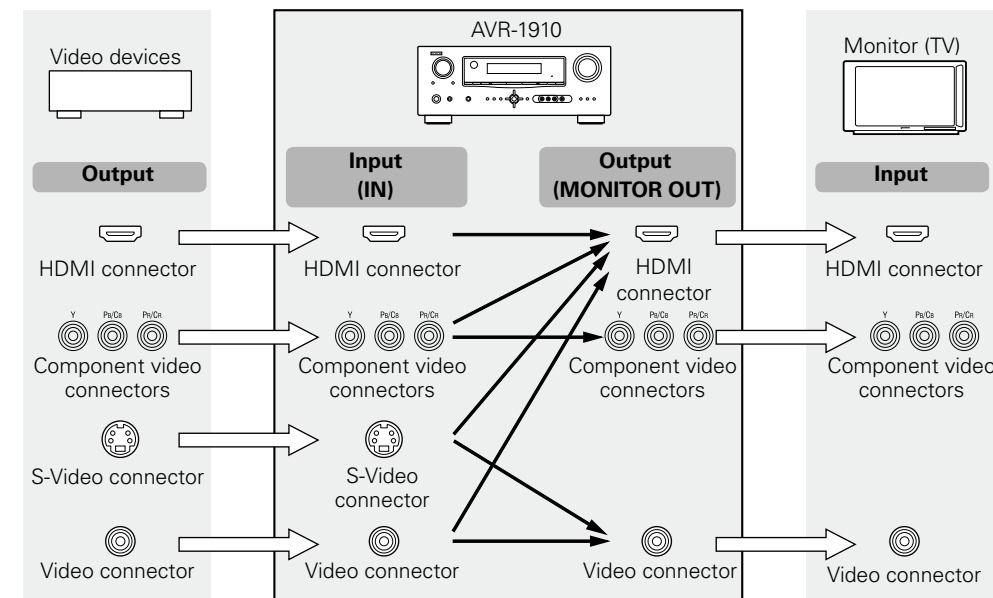

- The video conversion function supports the NTSC, PAL, SECAM, NTSC 4.43, PAL-N, PAL-M and PAL-60 formats.
- The resolution of the video signal input to the AVR-1910's HDMI terminal is the resolution set at "Resolution" (page 34). (1080p HDMI signals and 1080p component signals are output at 1080p, regardless of the setting.)
- Resolutions of HDMI-compatible TVs can be checked at "HDMI Monitor Information" (page 48).

NOTE

- The S-Video input terminal is exclusively for use with a Control Dock for iPod. It can be used when the Control Dock for iPod is connected to the terminal assigned to the iPod input source.
- HDMI signals cannot be converted into analog signals.
- When a non-standard video signal from a game machine or some other source is input, the video conversion function might not operate.

How the on-screen display is displayed depending on the video input signal

The way the on-screen display of the menus, status, etc., is displayed differs according to the type of video signal input to the AVR-1910.

When video signals are input from the HDMI or component video terminals

- **Menu:** Switches to a screen with a black background and the menu is superimposed. (※1)
- **Status display:** Not displayed.

※1: If you want to display the menu superimposed on the picture being played, input the same video signals to the S-Video or video terminals. When a menu is displayed, the picture switches to the one being input from the S-Video or video terminals and the menu is displayed superimposed over this picture.

NOTE

Menus and status display screens are not displayed for component video terminal pictures. To display them, also connect the video terminals.

When video signals are being input from the S-Video or video terminals

- **Menu:** Menus are displayed superimposed over the picture being played.
- **Status display:** Displayed.

Examples of on-screen display

- Menu screen
- Status display screen
 - When the input source is switched
 - When the volume is adjusted

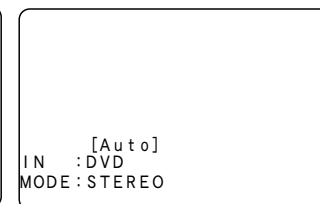
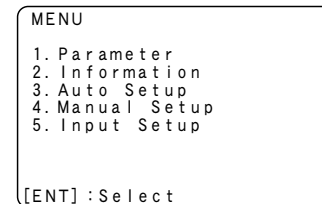

Status display: The operating status is displayed temporarily on the screen when the input source is switched or the volume is adjusted.

Installing/Setting the Speakers

- The AVR-1910 is compatible with various types of surround playback.
- Decide on the surround modes to be played on the AVR-1910 before making connections and settings.

1 Determine the Speaker Layout.

Below we introduce examples of speaker layouts. Refer to these to arrange your speakers according to their type and how you want to use them.

Installing All the Speakers

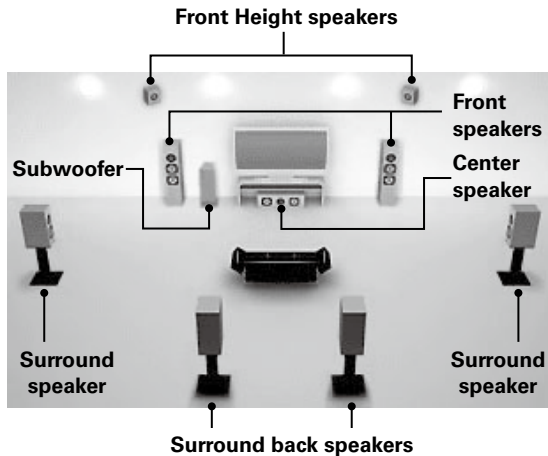

NOTE

It is not possible to use the front height speakers and surround back speakers simultaneously.

When 7.1ch (Surround Back Speaker) Connected

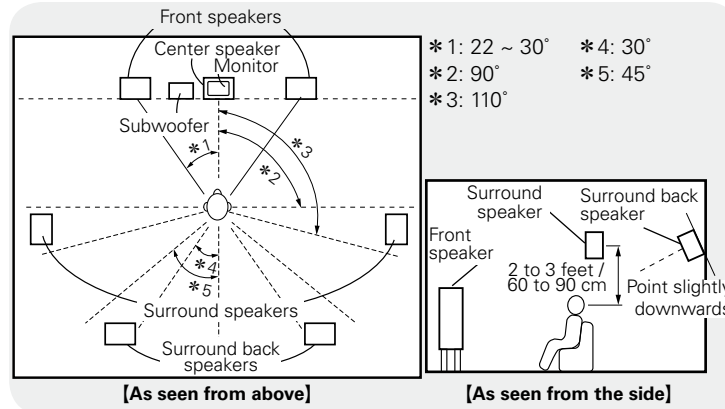

When 5.1ch Connected

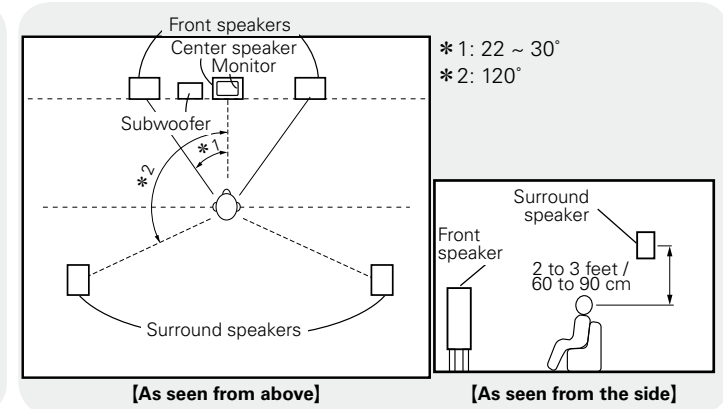

When 6.1ch Connected

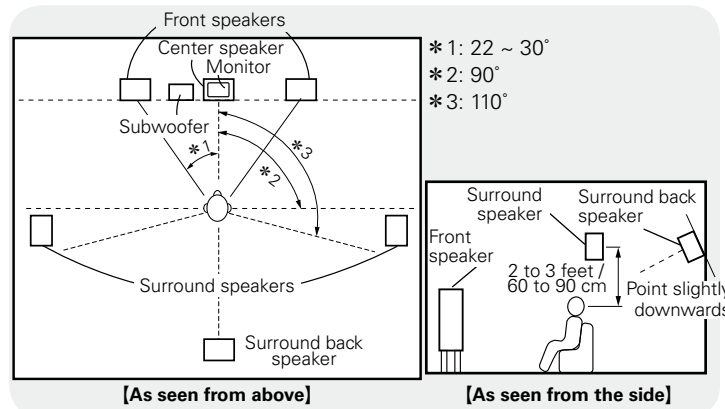



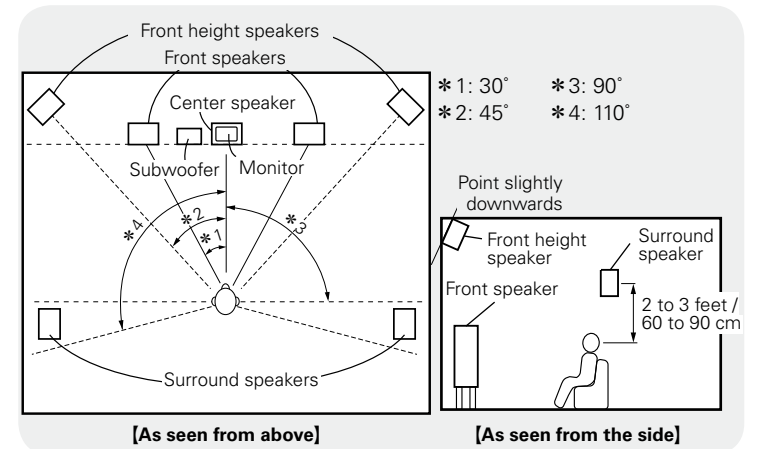

When 7.1ch (Front Height Speaker) Connected



Installing/Setting the Speakers

2 Set the "Amp Assign" Mode According to the Speaker Layout.

The signals output from the AVR-1910's SURR. BACK/AMP ASSIGN speaker terminals can be switched to signals of the surround mode being used (☞ page 25 "Amp Assign").

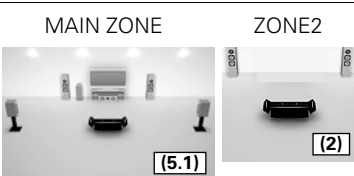
Amp assign mode (☞ page 25)	SURR. BACK/AMP ASSIGN Speaker connections	Example of speaker installation
Normal	Surround back speakers	 (7.1)
Normal	Surround back speakers ※ Connect to the "L" speaker terminal. ※ Set "Surround Back" (☞ page 26) to "1 spkr".	 (6.1)
Normal	Not connected ※ Set the "Surround Back" setting (☞ page 26) to "OFF".	 (5.1)
Front Height	Front Height speakers	 (7.1)
Front A Bi-Amp or Front B Bi-Amp	Front A or B speakers ※ For connections, see "About bi-amp connections" (☞ page 12).	 (5.1)
ZONE2 (Default)	ZONE2 speakers	 (5.1) (2)

Connecting the Speakers

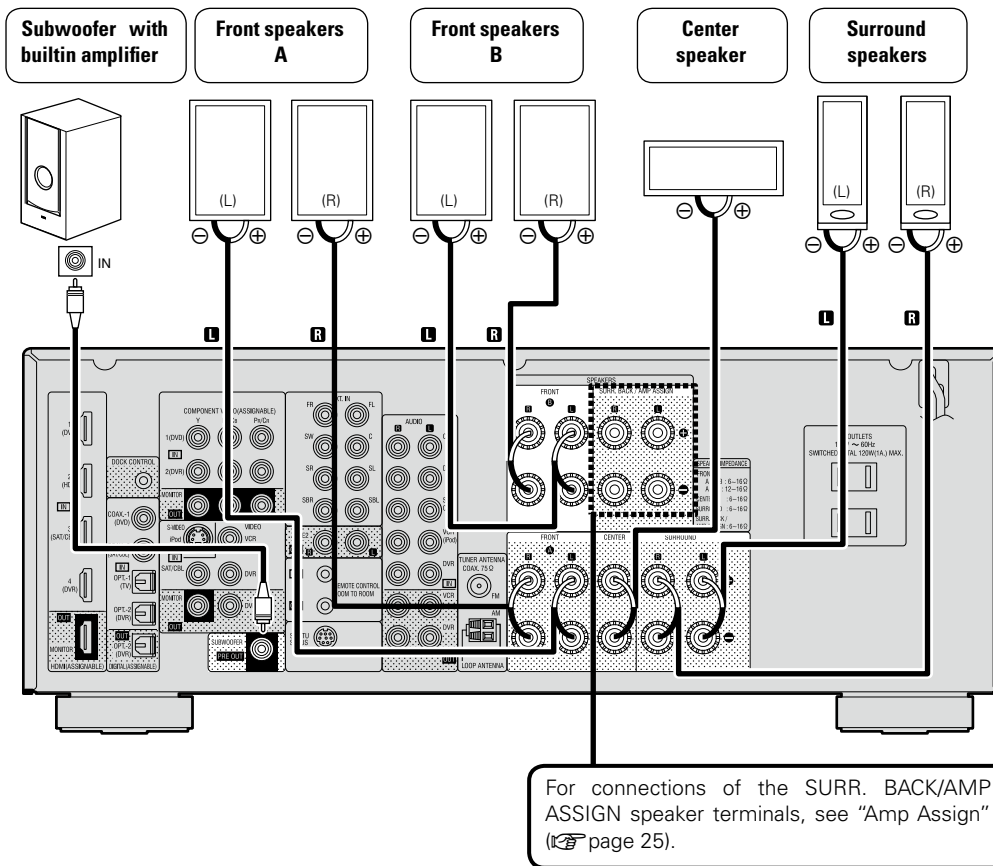

Protection circuit

If the core wires touch the rear panel and the screws etc., or the ± sides touch each other, the protection circuit will be activated and the power indicator will flash red at intervals of 0.5 secs.

If the protection circuit is activated, the speaker output is isolated, and the power supply goes to the standby state. If the power supply is turned off, after the power supply cord is withdrawn, please confirm that speaker cable and input cable are connected.





Also, if replaying large sound levels by using a speaker having an impedance less than that

specified (eg, 4 Ω/ohms), the temperature will rise, and the protection circuit might be activated. The power supply will go into the standby state, and the power indicator will flash red at 2 second intervals. In this case, please switch off the power supply, and wait until the AVR-1910 has cooled down, and the surrounding ventilation is good.

Even if there are no problems with the surrounding ventilation and connections, in the event of the protection circuit becoming activated, due to thinking that the AVR-1910 has failed, please contact DENON Service center after switching off.

Connecting the Speaker Cables

Carefully check the left (L) and right (R) channels and + (red) and – (black) polarities on the speakers being connected to the AVR-1910, and be sure to interconnect the channels and polarities correctly.

- 1** Peel off about 10 mm of sheathing from the tip of the speaker cable, then either twist the core wire together or terminate it. 
- 2** Turn the speaker terminal counterclockwise to loosen it. 
- 3** Insert the speaker cable's core wire to the hilt into the speaker terminal. 
- 4** Turn the speaker terminal clockwise to tighten it. 

When using a banana plug

Tighten the speaker terminal firmly before inserting the banana plug. 



Use speakers with an impedance of 6 to 16 Ω/ohms. When using front A and B speakers simultaneously, use speakers with an impedance of 12 to 16 Ω/ohms.

NOTE

- Connect the speaker cables in such a way that they do not stick out of the speaker terminals. The protection circuit may be activated if the core wires touch the rear panel or if the + and – sides touch each other (☞ “Protection circuit”).
- Never touch the speaker terminals while the power supply is connected. Doing so could result in electric shock.

About bi-amp connections

These connections make for higher quality playback sound with no interference between the signals of the bass and treble units. When the amplifier assignment mode is set to “Front A Bi-Amp” or “Front B Bi-Amp,” connect as shown below. (The illustration shows a connection example for the front B Bi-Amp speakers.)

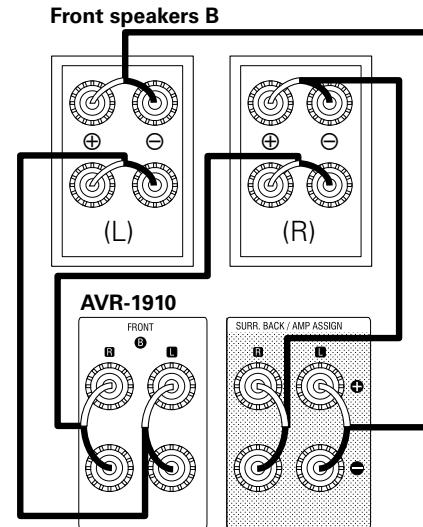

When in the “Front A Bi-Amp” and “Front B Bi-Amp” modes, the same signals are output from the front speaker terminals and the AMP ASSIGN terminals.

NOTE

- Use speakers compatible with bi-amp connections.
- When making bi-amp connections, be sure to remove the short-circuiting plate or wire between the speaker's woofer and tweeter terminals.

Connecting Devices

Connecting Devices Equipped with HDMI terminals

Important Information

About HDMI

“HDMI” is the abbreviation of “High Definition Multimedia Interface”. This interface allows transfer of digital video signals and digital audio signals over a single HDMI cable.

“HDMI”, “HDMI logo” and “High-Definition Multimedia Interface” are trademarks or registered trademarks of HDMI Licensing LLC.

Functions usable with HDMI connections

Deep Color

Eliminates on-screen color banding, for smooth tonal transitions and subtle gradations between colors.

x.v.Color

Enables displays with natural, vivid colors. “x.v.Color” is a Sony registered trademark.

Auto Lip Sync (☞ page 28)

HDMI 1.3 incorporates an automatic video/audio syncing capability that allows devices to perform this synchronization automatically with total accuracy.

HDMI control function (☞ page 28, 49)

This function allows you to operate external devices from the receiver and operate the receiver from external devices.

NOTE

These functions will not work if the device connected to the HDMI terminal does not support Deep Color or x.v.Color signal transfer or the Auto Lip Sync function.

Copyright protection system (HDCP)

The AVR-1910 supports HDCP (High-bandwidth Digital Contents Protection). HDCP is a copyright protection technology for digital video signals. The devices connected to the AVR-1910 must also support HDCP.

NOTE

When a device that does not support HDCP is connected, video signals are not properly output.

Connections

The AVR-1910 allows connection of inputs from up to 4 HDMI devices and output to 1 TV.

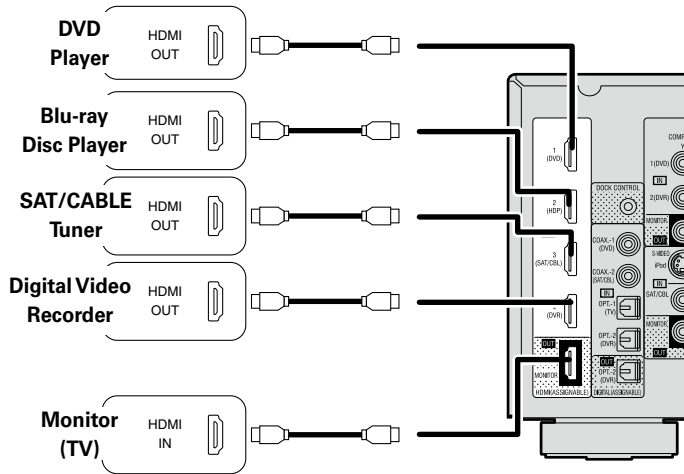

- Use a cable on which the HDMI logo is indicated (a certified HDMI product) for connection to the HDMI connector. Normal playback may not be possible when using a cable other than one on which the HDMI logo is indicated (a non-HDMI-certified product).
- When the AVR-1910 is connected to other devices with HDMI cables, also connect the AVR-1910 and TV using an HDMI cable.
- When a device supporting Deep Color signal transfer is connected, use a cable compatible with HDMI ver.1.3a.
- Video signals are not output if the input video signals do not match the monitor's resolution. In this case, switch the Blu-ray Disc player / DVD player's resolution to a resolution with which the monitor is compatible.

NOTE

- If the menu "HDMI Audio Out" setting (page 28) is set to "AMP", the sound may be interrupted when the monitor's power is turned off.
- The audio signal from the HDMI output terminal (sampling frequency, number of channels, etc.) may be limited by the HDMI audio specifications of the connected device regarding permissible inputs.

Connecting devices

Connecting to a device equipped with a DVI-D terminal

When an HDMI/DVI conversion cable (sold separately) is used, the HDMI video signals are converted to DVI signals, allowing connection to a device equipped with a DVI-D terminal.

NOTE

- No sound is output when connected to a device equipped with a DVI-D terminal. Also make the audio connections.
- Signals cannot be output to DVI-D devices that do not support HDCP.
- Depending on the combination of devices, the video signals may not be output.

Settings related to HDMI connections

Set as necessary. For details, see the respective reference pages.

Input terminal assignment (page 33)

Set this when changing the input sources of the different terminals.

HDMI Setup (page 28)

Make these settings related to HDMI input/output signals.

- Auto Lip Sync
- HDMI Audio Out
- HDMI Control
- Standby Source
- Power Off Control

NOTE

The audio signals output from the HDMI connectors are only the HDMI input signals.

Connecting Devices not Equipped with HDMI terminals

Monitor (TV)

- Select the terminal to use and connect the device.
- For video connections, see "Converting input video signals for output (Video Conversion Function)" (page 9).

For instructions on HDMI connections, see "Connecting Devices Equipped with HDMI terminals" on page 12.

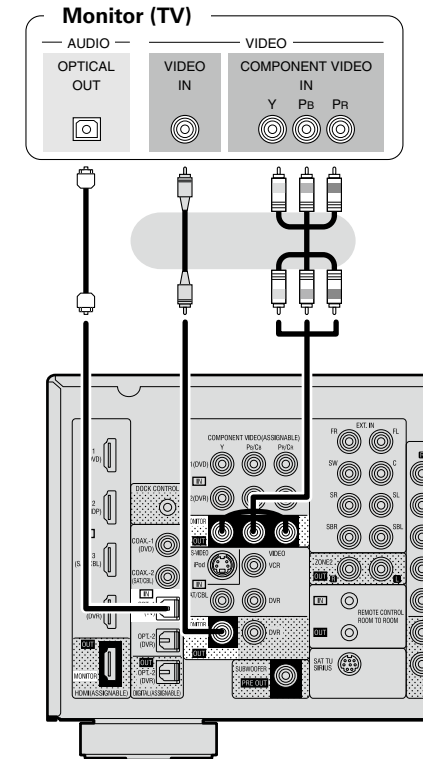

The component video connectors may be indicated differently on your monitor. For details, see the monitor's operating instructions.

Playback Components

Blu-ray Disc player / DVD player

Select the terminal to use and connect the device.

For instructions on HDMI connections, see "Connecting Devices Equipped with HDMI terminals" on page 12.

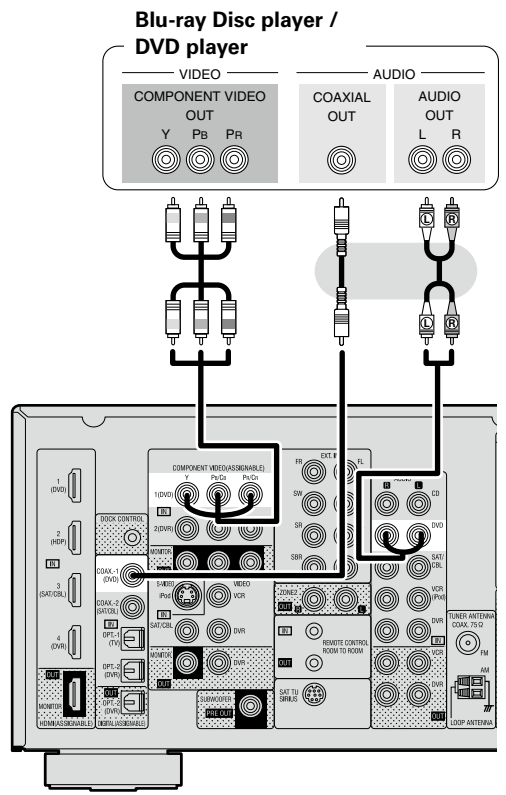

Set as necessary
Set this to change the input signal to which the input source is assigned.
"Assign" (page 33)

NOTE
When connected to a Blu-ray Disc player, and playing Dolby TrueHD, DTS-HD, Dolby Digital Plus, connect the HDMI.

Control dock for iPod®

Use a DENON control dock for iPod (ASD-1R, ASD-11R, ASD-3N or ASD-3W sold separately) to connect the iPod to the AVR-1910. For instructions on the control dock for iPod settings, refer to the control dock for iPod's operating instructions.

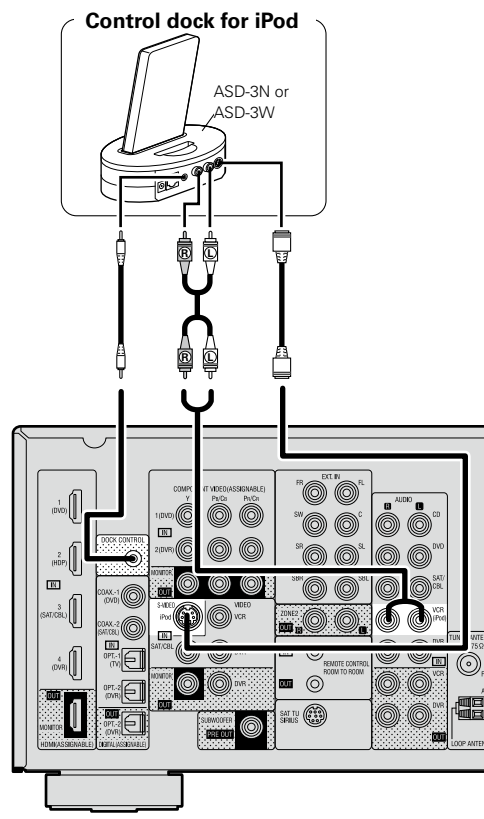

Set as necessary
Set this to assign the iPod to a terminal other than "VCR (iPod)" "iPod Dock" (page 33)

With the default settings, the iPod can be used connected to the VCR (iPod) connector.

CD Player

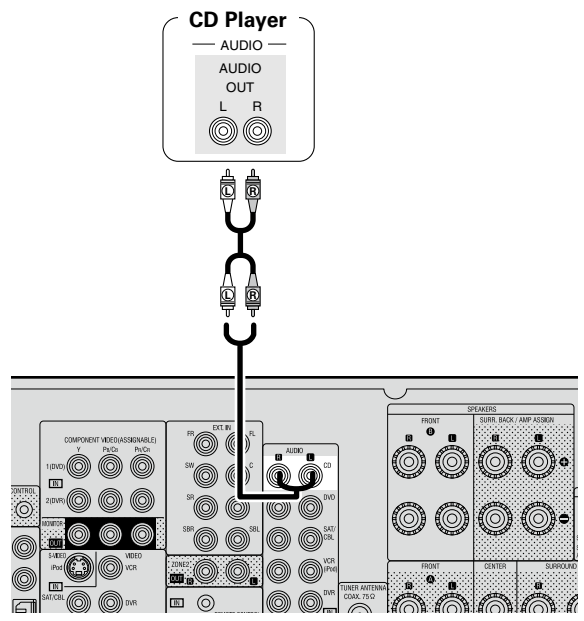

Set as necessary
Set this to change the input signal to which the input source is assigned.
"Assign" (page 33)

Recording Components

Digital Video Recorder

Select the terminal to use and connect the device.

For instructions on HDMI connections, see “Connecting Devices Equipped with HDMI terminals” on page 12.

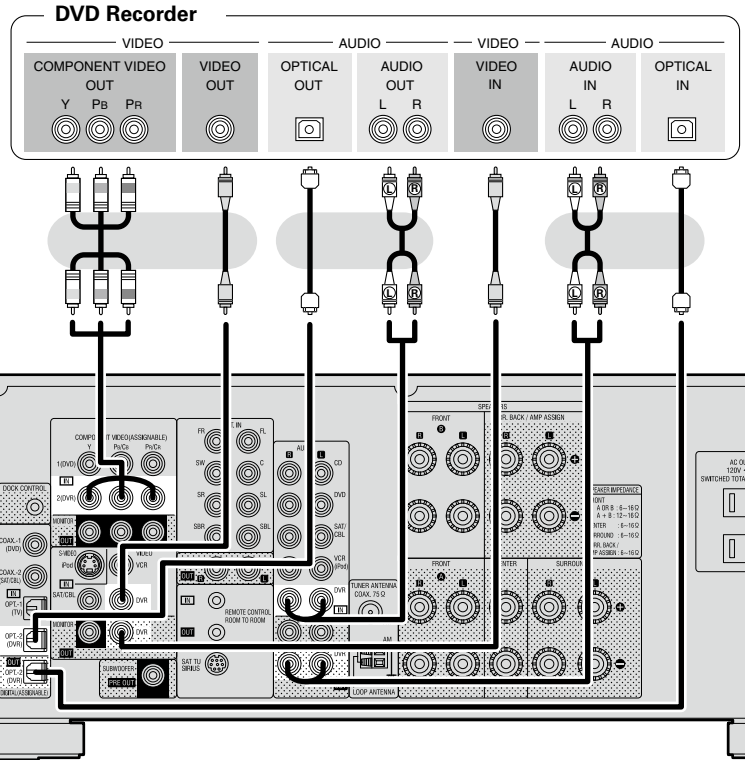

Set as necessary

Set this to change the input signal to which the input source is assigned.
 “Assign” (🔧 page 33)

NOTE

- To record video signals through the AVR-1910, use the same type of video cable for connection between the AVR-1910 and the player as the cable used for connection between the AVR-1910 and the recorder.
- Do not connect the output of the component connected to the AVR-1910's OPTICAL2 output connector to any input connector other than OPTICAL2.

Video Cassette Recorder

Select the terminal to use and connect the device.

For instructions on HDMI connections, see “Connecting Devices Equipped with HDMI terminals” on page 12.

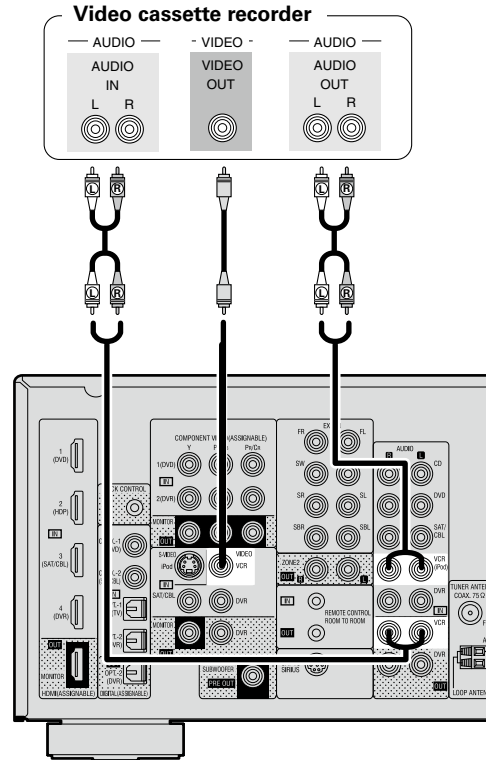

Set as necessary

Set this to change the input signal to which the input source is assigned.
 “Assign” (🔧 page 33)

NOTE

- To record video signals through the AVR-1910, use the same type of video cable for connection between the AVR-1910 and the player as the cable used for connection between the AVR-1910 and the recorder.

SAT/CABLE Tuner

Select the terminal to use and connect the device.

For instructions on HDMI connections, see “Connecting Devices Equipped with HDMI terminals” on page 12.

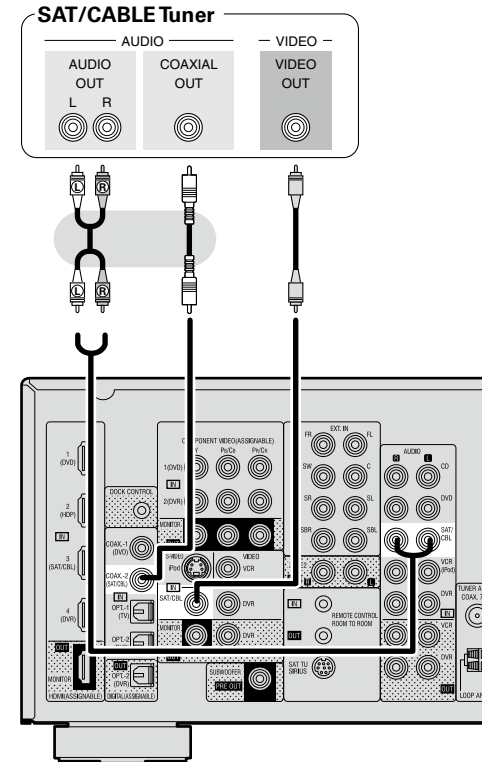

Set as necessary

Set this to change the input signal to which the input source is assigned.
 “Assign” (🔧 page 33)

Getting Started
 Connections
 Settings
 Playback
 Multi-Zone
 Remote Control
 Information
 Troubleshooting
 Specifications

Other Devices

Video Camera / Game Console

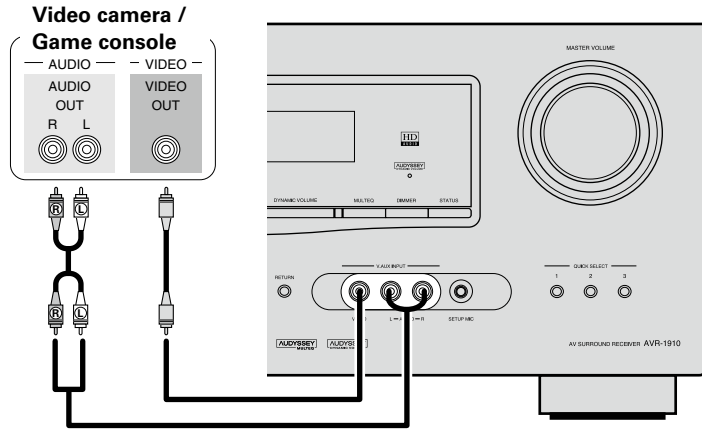

Component with Multi-channel Output connectors

The video signal can be connected in the same way as a Blu-ray Disc player / DVD player (page 14).

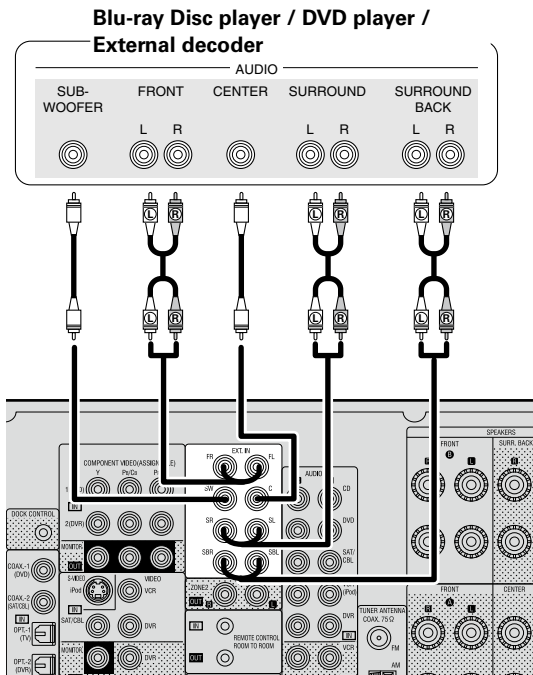

Set as necessary
 To play analog signals input from the external input (EXT. IN) terminal, set "Input Mode" (page 34) on the menu to "EXT. IN".
 "EXT. IN" can also be selected with INPUT MODE.

SIRIUS Connector

- The AVR-1910 is a SIRIUS Satellite Radio Ready® receiver. You can receive SIRIUS® Satellite Radio by connecting to the SiriusConnect Home Tuner and subscribing to the SIRIUS service.
- Plug the SIRIUS connector on the rear panel.
- Position the Home Tuner antenna near a south-facing window to receive the best signal. For details, see "Listening to SIRIUS Satellite Radio Programs" (page 40, 41). When making connections, also refer to the operating instructions of the SiriusConnect Home Tuner.

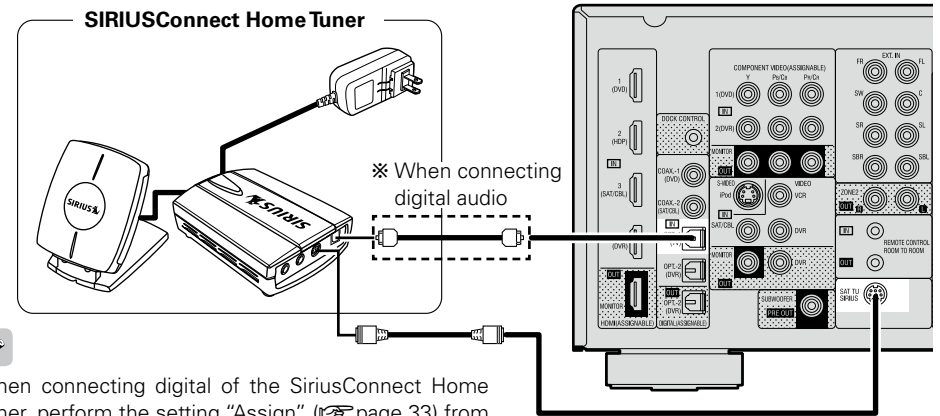

When connecting digital of the SiriusConnect Home Tuner, perform the setting "Assign" (page 33) from the menu.

NOTE
 Keep the power cord unplugged until the SiriusConnect Home Tuner connection have been completed.

"SIRIUS, XM and all related marks and logos are trademarks of Sirius XM Radio Inc. and its subsidiaries. All rights reserved. Service not available in Alaska and Hawaii."

Positioning the Antenna

For a consistent satellite signal, the antenna must be positioned correctly. Use the following map to determine which area you are in and position the antenna accordingly.

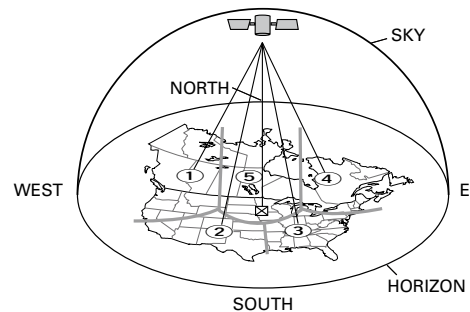

- Area 1 :** Point the antenna toward the sky in the **east, northeast, or southeast**, either through a window or outside.
- Area 2 :** Point the antenna toward the sky in the **north or northeast**, either through a window or outside.
- Area 3 :** Point the antenna toward the sky in the **north or northwest**, either through a window or outside.
- Area 4 :** Point the antenna toward the sky in the **west, northwest, or southwest**, either through a window or outside.
- Area 5 :** Put the antenna outside and point it **straight up**. The antenna cannot be used indoors.

Antenna terminals

Direction of broadcasting station

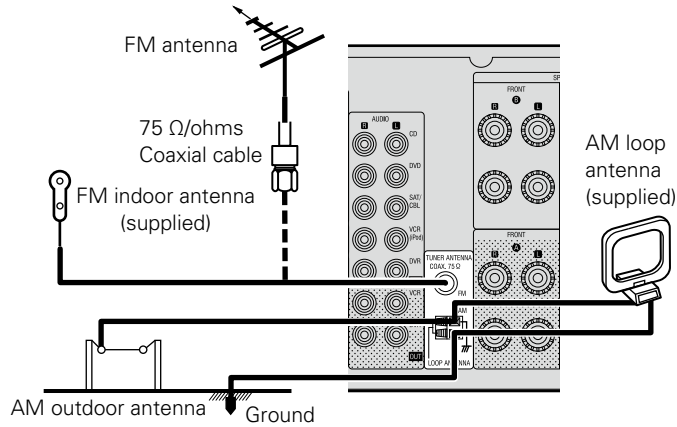

AM loop antenna assembly

- 1** Remove the vinyl tie and take out the connection line.
- 2** Bend in the reverse direction.
- 3-1** With the antenna on top of any stable surface.
- 3-2** With the antenna attached to a wall.

Connection of AM antennas

- 1** Push the lever.
- 2** Insert the conductor.

Connecting Devices not Equipped with HDMI terminals

3 Return the lever.

NOTE

- Do not connect two FM antennas simultaneously.
- Even if an external AM antenna is used, do not disconnect the AM loop antenna.
- Make sure the AM loop antenna lead terminals do not touch metal parts of the panel.

Connecting the Power Cord

Wait until all connections have been completed before connecting the power cord.

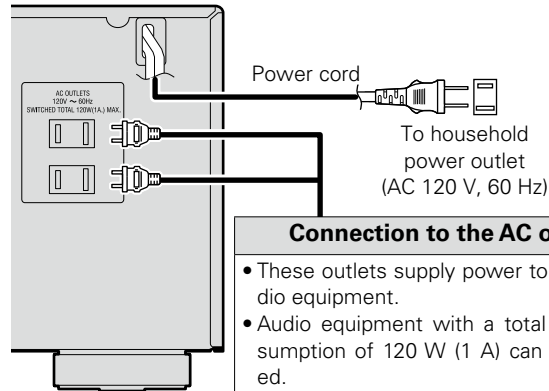

Connection to the AC outlets

- These outlets supply power to external audio equipment.
- Audio equipment with a total power consumption of 120 W (1 A) can be connected.
- The power supply turns on and off together with the ON/STANDBY button on the main unit. When set to "ON", power is supplied from the outlet. When set to "STANDBY", no power is supplied.

NOTE

When "HDMI Control" (page 28) is set to "ON", power is supplied constantly to the AC outlet (UNSWITCHED).

NOTE

- Insert the AC plugs securely. Incomplete connections could cause noise.
- Only use the AC outlets to plug in audio equipment. Do not use them as power supplies for hairdryers or anything other than audio equipment.

Once Connections are Completed

Turning the Power On

- 1** Press . The power indicator lights red and the power is set to the standby mode.
 - 2** Press . The power indicator flashes green and the power turns on.
 - Also press when in standby mode, the power turns on.
- When has been pressed, the input source set with the is set. If a has been pressed, the input source stored in the memory for the quick select function is set (page 50 "Saving frequently used settings (Quick Select Function)").

This operation can also be performed by pressing a on the main unit.

Turning the Power Off

- 1** Press . The power is set to the standby mode.
- 2** Press . The power indicator turns off, and so does the power.

NOTE

- Power continues to be supplied to some of the circuitry even when the power is in the standby mode. When leaving home for long periods of time or when traveling, either press to turn off the power, or unplug the power cord from the power outlet.
- When the ZONE2 power is switched on, and you want to switch off the MAIN ZONE power, press .

Settings

With the AVR-1910, settings and operations for most functions can be performed by operating while looking at the menus displayed on the monitor screen.

Menu map

Operations

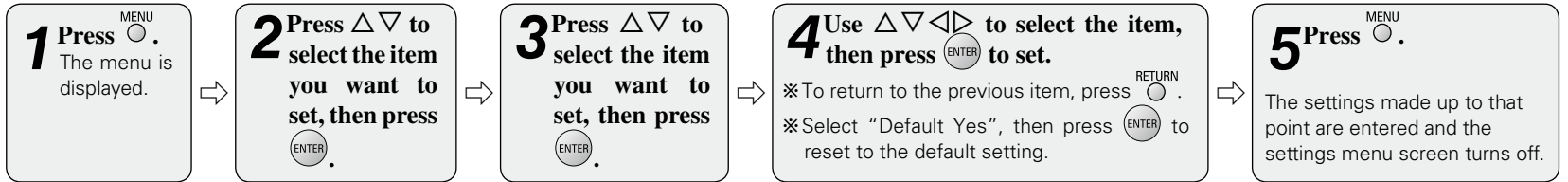

Setting menus

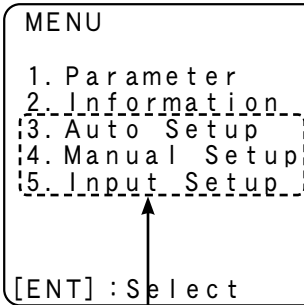



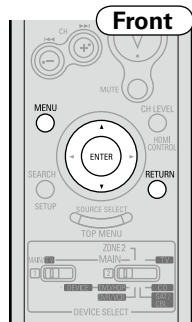





Items that only need to be set once
Set these for example upon purchase. Once these items are set, there is no need to set them again unless the speaker layout or the connected speakers have been changed.

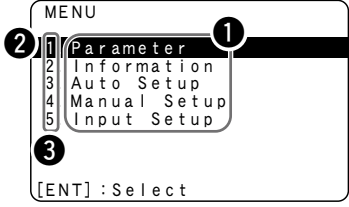
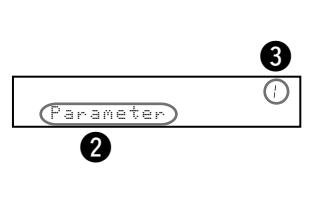
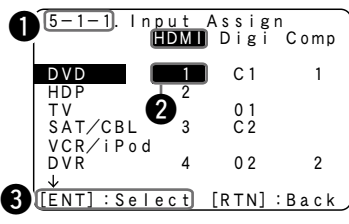

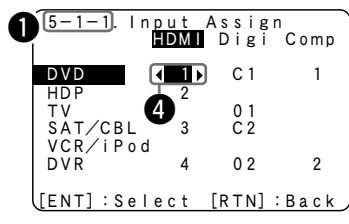
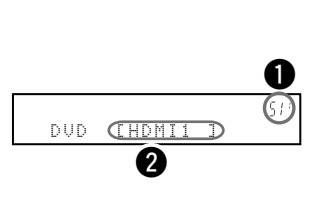
Setting items	Number	Detailed items	Description	Page
1. Parameter Adjust various audio parameters.	1-1	Surround Parameter	Adjust surround sound parameters.	44
	1-2	Tone Control	Adjusts the treble and bass tone.	46
	1-3	Audyssey Settings	Makes the MultEQ, Dynamic EQ and Dynamic Volume settings.	46
	1-4	Manual EQ	Adjust tonal quality for each speaker using graphic equalizer.	47
	1-5	RESTORER	Uncompress compressed sources and apply bass boost for richer sound.	48
	1-6	Audio Delay	Compensate for incorrect timing between video and audio.	48
2. Information Show information about receiver settings, input signals, etc.	2-1	Status	Shows information about current settings.	48
	2-2	Audio Input Signal	Shows information about audio input signals.	48
	2-3	HDMI Information	Displays the HDMI input/output signals and TV information.	48
	2-4	Auto Surround Mode	Displays the settings stored for the auto surround mode.	48
	2-5	Quick Select	Displays the settings stored for the Quick Select function.	48
	2-6	Preset Channel	Shows information about preset channels.	48
3. Auto Setup Makes the optimum speaker settings and corrects for the acoustic characteristics of the room.	3-1	Audyssey Auto Setup	Makes the optimum settings for the speakers being used automatically.	21
	3-2	Parameter Check	Check Audyssey Auto Setup measurement results. This item is only displayed after the Audyssey Auto Setup procedure has been performed.	24
4. Manual Setup Use this to make various types of detailed settings.	4-1	Speaker Setup	Sets the speaker size and distance, the channel level, etc.	25
	4-2	HDMI Setup	Make settings for HDMI video/audio output.	28
	4-3	Audio Setup	Make settings for audio playback.	29
	4-4	ZONE2 Setup	Make settings for audio playback in a ZONE2 system.	30
	4-5	Option Setup	Make various other settings.	30
5. Input Setup Use this to make settings related to playing input sources.	5-1	Assign	Change input connector assignment.	33
	5-2	Video	Makes the video settings.	34
	5-3	Input Mode	Sets the audio input mode and decode mode.	34
	5-4	Rename	Change the display name for this source.	35
	5-5	Source Level	Adjust the playback level of the audio input.	35
	5-6	iPod Playback Mode	Make settings for iPod playback.	35
	5-1	Auto Preset	Use the auto preset function to program radio stations.	36
	5-2	Preset Skip	Set the preset memories that you do not want to display when tuning.	36
	5-3	Preset Name	Assign name to a preset memory.	36
	5-2	Parental Lock	Set the channel radio reception limits.	37
5-3	Antenna Aiming	Check the SIRIUS radio reception sensitivity.	37	

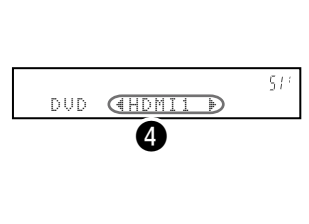
Examples of On-screen Display and Front Display

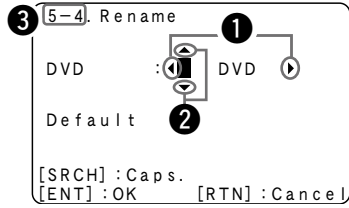
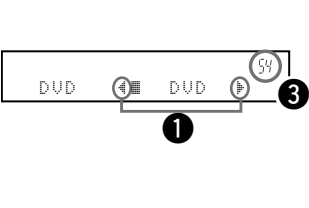
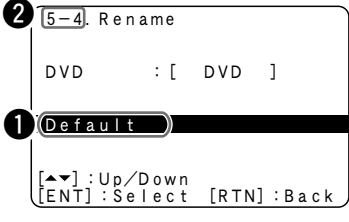
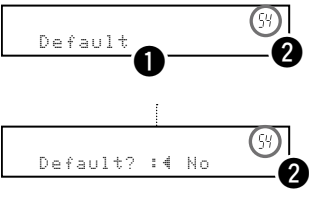
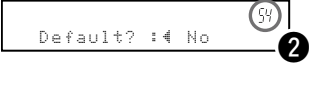
Below we describe typical examples of displays on the TV screen and on the set's display window.

On-screen Display	Front Display	Description
<p>❑ Top menu display</p>  <p>[ENT] : Select</p>		<p>① : The menu items are displayed here. ② : The selected line is displayed here. The currently selected item is displayed on the display. Use Δ/∇ to move to the item you want to set. ③ : The number of the current selected setting menu is displayed.</p>
<p>❑ Display when changing settings</p>  <p>[ENT] : Select [RTN] : Back</p> <p style="text-align: center;">↓ Press .</p>  <p>[ENT] : Select [RTN] : Back</p>	 <p style="text-align: center;">↓ Press .</p> 	<p>① : The number of the current selected setting menu is displayed. ② : Use Δ/∇/\triangleleft/\triangleright to move to the item you want to set. ③ : Press  to set to the mode in which the setting can be made. ④ : \triangleleft/\triangleright is displayed at the sides of items whose setting can be changed. Use \triangleleft/\triangleright to change to the desired setting.</p>
<p>❑ Display when inputting characters</p>  <p>[SRCH] : Caps. [ENT] : OK [RTN] : Cancel</p>		<p>① : When \triangleleft/\triangleright is pressed, the cursor moves to the left or right. ② : When Δ/∇ is pressed at the position at which you want to input the character, the character is input. ③ : The number of the current selected setting menu is displayed.</p>
<p>❑ Display when resetting</p>  <p>[Δ/∇] : Up/Down [ENT] : Select [RTN] : Back</p>	 <p style="text-align: center;">⋮</p> 	<p>① : Press ∇ to select "Default," then press  to set. ② : The number of the current selected setting menu is displayed.</p>

Getting Started
Connections
Settings
Playback
Multi-Zone
Remote Control
Information
Troubleshooting
Specifications



Making the Optimum Settings for the Connected Speakers Automatically (Audyssey Auto Setup)

The acoustic characteristics of the connected speakers and listening room are measured and the optimum settings are made automatically.

Audyssey Auto Setup Flow

Step 1 : Connect the included Setup Microphone (👉 page 21)



Step 2 : Audyssey Auto Setup Preparations (👉 page 21)

- Setting the speakers for playing the front channel (Front Sp.)** (👉 page 21)
- Changing the amplifier assignment (Amp Assign)** (👉 page 22)



Step 3 : Performing the Audyssey Auto Setup Procedure (👉 page 22)

- Check Audyssey Auto Setup Measurement Results (Parameter Check)** (👉 page 24)

Important Information

Audyssey MultEQ® automatically measures the acoustical problems in the listening environment to create the best audio experience for your home theater.

- When the Audyssey Auto Setup procedure is performed, the MultEQ, Dynamic EQ and Dynamic Volume functions (👉 page 46) are enabled.
- Use the included setup microphone (DM-A409) to perform the Audyssey Auto Setup procedure.
- Measurements are performed by placing the calibrated microphone successively at multiple positions throughout the listening area as shown in **[Example ①]**. For best results, it is strongly recommended to measure 6 positions so that the measurements have the proper spatial weighting.

Even if the listening environment is small as shown in **[Example ②]**, measuring at multiple points throughout the listening environment results in more effective correction.

- FHL** : Front height speaker (L)
- FL** : Front speaker (L)
- SW** : Subwoofer
- C** : Center speaker
- FR** : Front speaker (R)
- FHR** : Front height speaker (R)
- SR** : Surround speaker (R)
- SBR** : Surround back speaker (R)
- SBL** : Surround back speaker (L)
- SL** : Surround speaker (L)

About the main listening position (*M)

The main listening position refers to the most central position where one would normally sit within the listening environment. MultEQ uses the measurements from this position to calculate speaker distance, level, polarity, and the optimum crossover value for the subwoofer.

NOTE

- Loud test sounds may be played during Audyssey MultEQ automatic speaker setup. This is part of normal operation. If there is background noise in room, these test signals will increase in volume.
 - Do not stand between the speakers and setup microphone or allow obstacles in the path while the measurements are being made. This will cause inaccurate readings.
 - Make the room as quiet as possible. Background noise can disrupt the room measurements. Close windows, silence cell phones, televisions, radios, air conditioners, fluorescent lights, home appliances, light dimmers, or other devices as measurements may be affected by these sounds.
- Cell phones should be placed away from all audio electronics during the measurement process as Radio Frequency Interference (RFI) may cause measurement disruptions (even if the cell phone is not in use).

When using Front Height Speakers

[Example ①]

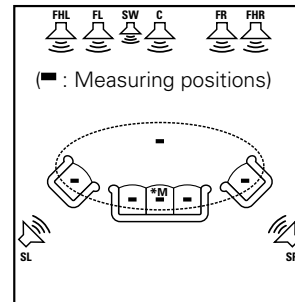

[Example ②]

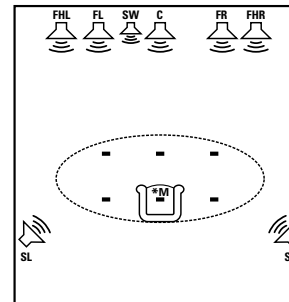

When using Surround Back Speakers

[Example ①]

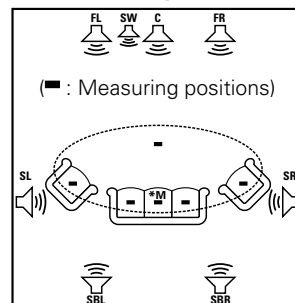

[Example ②]

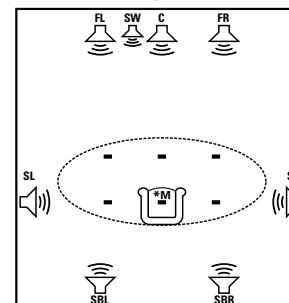

Step 1 : Connect the included Setup Microphone

NOTE

- Do not disconnect the setup microphone until the Audyssey Auto Setup procedure is completed.
- When using headphones, unplug the headphones before starting the Audyssey Auto Setup procedure.

1 Check the speaker connections.

(☞ page 11 "Connecting the Speakers")

2 Turn on the power of the TV and subwoofer.

Set the TV's input to the AVR-1910.

3 Turn on the AVR-1910's power.

(☞ page 17 "Turning the Power On")

4 Connect the included calibrated setup microphone to the SETUP MIC jack on the main unit.

The Audyssey Auto Setup screen appears automatically.

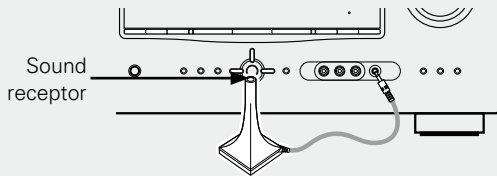

5 Mount the setup microphone on a tripod or stand and install it at the main listening position.

When installing the setup microphone, adjust its height so that the section where the sound is received is at the height of the ears during listening.

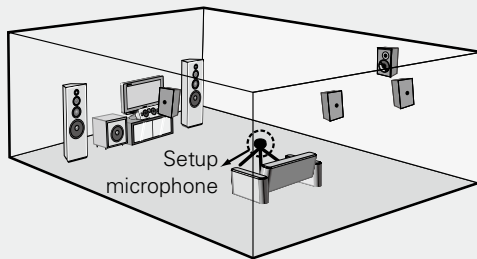

NOTE

- Do not hold the microphone in your hand during measurements.
- Avoid placing the microphone close to a seat back or wall as sound reflections may give inaccurate results.

When using a subwoofer on which the volume can be adjusted and the crossover frequency can be set

When using a subwoofer, make the following settings before starting the Audyssey Auto Setup procedure:

- When using a subwoofer with a direct mode**
Set the direct mode to "On" and disable the volume adjustment and crossover frequency setting.
- When using a subwoofer without a direct mode**
Make the following settings:
 - Volume : "12 o'clock position"
 - Crossover frequency : "Maximum/Highest Frequency"
 - Low pass filter : "Off"
 - Standby mode : "Off"

Step 2 : Audyssey Auto Setup Preparations

□ around items indicate the settings made upon purchase.

If adjustment to the environment is necessary, set the following items before proceeding.

Setting the speakers for playing the front channel (Front Sp.)

The front speaker to be measured can be selected ahead of time here.

1 Press Δ / ∇ to select "Front Sp."

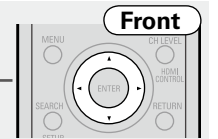

2 Use \triangleleft / \triangleright to select the speakers.

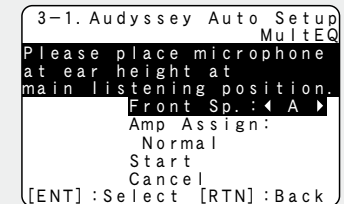

- A** : The sound is output from front speakers A when measuring the front speakers.
- B** : The sound is output from front speakers B when measuring the front speakers.
- A + B** : The sound is output simultaneously from front speakers A and B when measuring the front speakers.

To cancel Audyssey Auto Setup

Use Δ / ∇ to select "Cancel", then use \triangleleft / \triangleright to select "Yes".

Changing the amplifier assignment (Amp Assign)

The signals output from the AVR-1910's SURR. BACK/AMP ASSIGN speaker terminals can be switched to signals of the surround mode being used.

1 Press $\Delta \nabla$ to select "Amp Assign".

2 Press $\triangleleft \triangleright$ to select Amp Assign Mode.

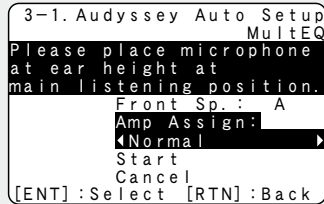
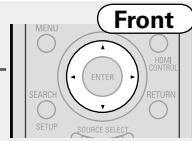

Normal : The sound of the surround back channel is output from the speakers connected to the SURR. BACK/AMP ASSIGN terminals.

ZONE2 : If the ZONE2 power is on, the sound of the ZONE2 channel is output from the speakers connected to the SURR. BACK/AMP ASSIGN terminals.

Front A Bi-Amp : The sound of the front A bi-amp channel is output from the speakers connected to the SURR. BACK/AMP ASSIGN terminals.

Front B Bi-Amp : The sound of the front B bi-amp channel is output from the speakers connected to the SURR. BACK/AMP ASSIGN terminals.

Front Height : The sound of the front height channel is output from the speakers connected to the SURR. BACK/AMP ASSIGN terminals.

To cancel Audyssey Auto Setup

Use $\Delta \nabla$ to select "Cancel", then use $\triangleleft \triangleright$ to select "Yes".

Step 3 : Performing the Audyssey Auto Setup Procedure

- The Audyssey Auto Setup function detects the presence of each speaker and automatically calculates the speaker size, channel level, distance, and optimal crossover frequency setting. Audyssey MultEQ corrects acoustical distortions within the listening area.
- Once started, MultEQ will play a series of test tones through each speaker.
- Before starting, connect and position all of your speakers.

1 Press $\Delta \nabla$ to select "Start", then press ENTER .

Detection of the speaker configuration starts.

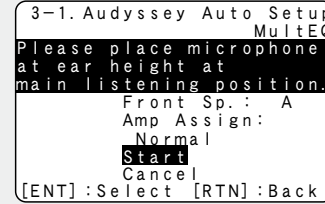

2 Once all the speakers have been detected and the screen on the right appears, check the results of detection of the connected speakers.

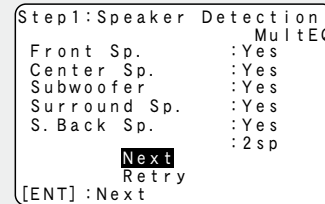

3 Once you have checked the results, use $\Delta \nabla$ to select "Next", then press ENTER .

Measurements for the main listening position begin.

4 Once the screen on the right appears, move the setup microphone to the second position, use $\Delta \nabla$ to select "Next", then press ENTER .

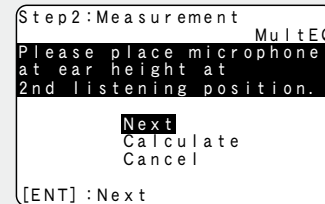

Measurements for the second position begin.

5 Perform Step 4 repeatedly for the 3rd, 4th, 5th, and 6th measurements.

Once measurements for the sixth position are completed, "All the measurements were finished." is displayed.

- ※ Measure at a total of six positions, including the main listening position and positions around it. It is possible to stop the settings with five positions or fewer, but for better results we recommend measuring at six positions.

6 Once measurements are finished, use $\Delta \nabla$ to select "Calculate", then press ENTER .

Analysis begins.

- ※ Analysis takes several minutes to complete. The time required for this analysis depends on the number of speakers connected. The greater the number of speakers connected, the longer analysis will take.

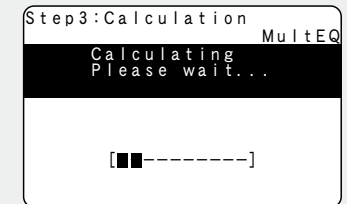
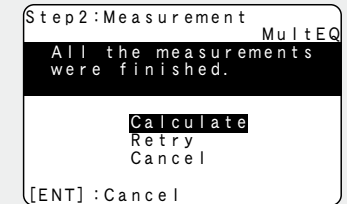

7 Use $\Delta \nabla$ to select the item you want to check, then press ENTER .

The measurement result confirmation screen is displayed.



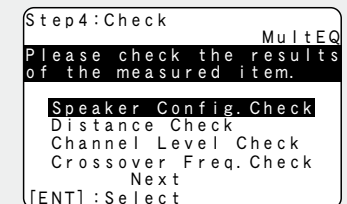



- ※ Subwoofers or other speakers may be set to a value that does not correspond to the actual distance.



See overleaf

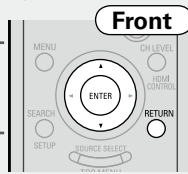



8 Press .

This returns you to analysis results items, so repeat step 7.

9 Press  to select “Next”, then press .**10** Press   to select “Store”, then press .

“Storing Please wait...” is displayed on the on-screen display while the results are being stored.

When storing is complete, “Storing complete. Auto Setup is now finished.” is displayed on the on-screen display.

※ If you do not want to save the measurement results, use   to select “Cancel”, then select “Yes” using  . All the measured Audyssey Auto Setup data will be erased.

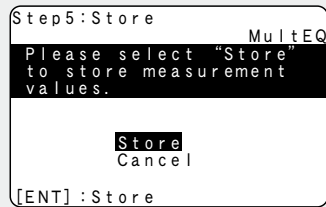

**NOTE**

Do not turn the power off while the settings are being stored.

12 Disconnect the setup microphone from the AVR-1910.**NOTE**

Do not change the speaker connections or subwoofer volume, or speaker locations after making measurements. If changes are necessary, make the changes and use the Audyssey Auto Setup once again for an updated EQ solution.



- If the result differs from the actual connection status or an error message appears, use   to on-screen display “Retry” and then press  to repeat the measurement.
- If the result still differs from the actual connection status after re-measurement or the error message still appears, it is possible that the speakers are not connected properly. Turn the AVR-1910 off, check the speaker connections and repeat the measurement process from the beginning.
- For instance, If the location or direction of a speaker is altered, the Audyssey Auto Setup should be performed again to ensure the correct EQ solution for the new room configuration.

Error Messages

If the Audyssey Auto Setup procedure could not be completed due to speaker installation, the measuring environment, etc., an error message is displayed. If this happens, check the relevant items, be sure to take the necessary measures, then perform the Audyssey Auto Setup procedure over again.

NOTE Be sure to turn the power off before checking the speaker connections.

Error messages (examples)	Cause	Measures
	<ul style="list-style-type: none"> Included setup microphone is not connected. Not all speakers could be detected. The front L speaker was not properly detected. 	<ul style="list-style-type: none"> Connect the included setup microphone to the SETUP MIC jack on the main unit. Check the speaker connections.
	<ul style="list-style-type: none"> Too much noise in the room for accurate measurements to be made. Speaker or subwoofer sound is too low for accurate measurements to be made. 	<ul style="list-style-type: none"> Either turn off any device generating noise or move it away. Try again when the surroundings are quieter. Check the speaker installation and the direction in which the speakers are facing. Adjust the subwoofer's volume.
	<ul style="list-style-type: none"> Displayed speaker could not be detected. The front R speaker were not properly detected. Only one channel of the surround speakers was detected. Sound was output from the R channel when only one surround back speaker was connected. The surround back, but the surround speaker was not detected. 	<ul style="list-style-type: none"> Check the connections of the displayed speaker.
	<ul style="list-style-type: none"> Displayed speaker connected with the polarities reversed. 	<ul style="list-style-type: none"> Check the polarities of the displayed speaker. For some speakers, this error message may be displayed even if the speaker is properly connected. If you are sure that the wiring is correct, press $\Delta \nabla$ to select "Skip," then press ENTER.

To perform the Audyssey Auto Setup procedure again

Press $\Delta \nabla$ to select "Retry," then press ENTER .

To cancel Audyssey Auto Setup

Use $\Delta \nabla$ to select "Cancel," then select "Yes" using $\triangleleft \triangleright$.

Check Audyssey Auto Setup Measurement Results (Parameter Check)

This is displayed after the Audyssey Auto Setup procedure is completed.

1 Press $\Delta \nabla$ to select "Parameter Check", then press ENTER .

"Parameter Check" is displayed on the on-screen display.

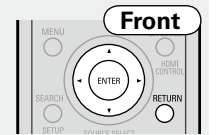
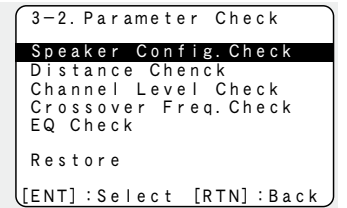

2 Use $\Delta \nabla$ to select the item you want to check, then press ENTER .

- Speaker Config. Check** : Check the speaker configuration
- Distance Check** : Check the distance
- Channel Level Check** : Check the channel level
- Crossover Freq. Check** : Check the crossover frequency
- EQ Check** : Check the equalizer

3 Use $\triangleleft \triangleright$ to switch the display between the different speakers.

4 Press RETURN . The confirmation screen reappears. Repeat steps 2 and 3.



Even if the settings are changed after the Audyssey Auto Setup procedure, the Audyssey Auto Setup settings can be restored by selecting "Restore" then pressing ENTER .



Making detailed settings (Manual Setup)

Use this procedure to change the Audyssey Auto Setup settings or to change the various audio, video and display settings.

The set can be used without changing these settings. Make these settings as necessary. For a description of "Menu map" and operating instructions, see page 18.

Items that can be set with the Manual Setup procedure



Making the speaker settings (Speaker Setup) page 25



Making the HDMI settings (HDMI Setup) page 28



Making the audio settings (Audio Setup) page 29



Making the ZONE2 settings (ZONE2 Setup) page 30



Making other settings (Option Setup) page 30

Examples of Menu Screen Displays

Speaker Setup

- 4-1. Speaker Setup
1. Amp Assign
 2. Speaker Config.
 3. Bass Setting
 4. Distance
 5. Channel Level
 6. Crossover Freq.
 7. Front Sp Setup

[ENT] : Select [RTN] : Back

HDMI Setup

- 4-2. HDMI Setup
- Auto Lipsync : ON
 - HDMI Audio Out : Amp
 - HDMI Control : OFF

[RTN] : Back

Audio Setup

- 4-3. Audio Setup
1. EXT. IN SW Level
 2. 2ch Direct/Stereo
 3. Auto Surround Mode
 4. EQ Customize

[ENT] : Select [RTN] : Back

ZONE2 Setup

- 4-4. ZONE2 Setup
- Level Lch : 0dB
 - Level Rch : 0dB
 - Vol. Display : Relative
 - Vol. limit : OFF
 - Power On Lev : Last
 - Mute Lev. : Full

[RTN] : Back

Option Setup

- 4-5. Option Setup
1. Volume Control
 2. Source Delete
 3. On-Screen Display
 4. Quick Select Name
 5. ZONE Rename
 6. Display
 7. Setup Lock

[ENT] : Select [RTN] : Back



Making the speaker settings (Speaker Setup)

Default settings are underlined.

Use this procedure to set the speakers manually or if you wish to change the settings made with the Audyssey Auto Setup procedure.

Setting items	Setting contents
Amp Assign Sets the signal output to the speaker connected to the SURR. BACK/AMP ASSIGN terminals.	Normal : The surround back channel audio signals are output. <u>ZONE2</u> : The ZONE2 audio signals are output. Front A Bi-Amp : The bi-amp audio signals are output. Set this for bi-amp playback of the front A speakers. Front B Bi-Amp : The bi-amp audio signals are output. Set this for bi-amp playback of the front B speakers. Front Height : The front height channel audio signals are output.
Speaker Config. Select speaker configuration and size. (bass reproduction capability)	Front : Set the front speaker size. <ul style="list-style-type: none"> • <u>Large</u> : Use of a large speaker that can adequately play back low frequencies. • Small : Use of a small speaker that has inadequate playback capacity for low frequencies. <p> If "Subwoofer" is set to "No", "Front" is automatically set to "Large".</p> Center : Set the presence and size of the center speaker. <ul style="list-style-type: none"> • Large : Use of a large speaker that can adequately play back low frequencies. • <u>Small</u> : Use of a small speaker that has inadequate playback capacity for low frequencies. • None : Select when a center speaker is not connected. <p> • "Large" is not displayed when "Front" is set to "Small". • Even if "Center" has been set to "Large", when "Front" is set to "Small", the "Center" setting automatically switches to "Small".</p> <ul style="list-style-type: none"> • Subwoofer : Set the presence of a subwoofer. • <u>Yes</u> : Use a subwoofer. • No : Select when a subwoofer is not connected. <p> When "Front" is set to "Small", "Subwoofer" can automatically set to "Yes".</p>

NOTE

Select "Large" or "Small" not according to the physical size of the speaker but according to the low frequency reproduction capabilities based on the frequency set at "Crossover Frequency" (page 27).



See overleaf

Setting items	Setting contents
<p>Speaker Config. Select speaker configuration and size. (bass reproduction capability)</p> <p>“S.Back” is displayed when the “Amp Assign” setting (page 25) is set to “Normal”.</p> <p>“Front Height” is displayed when the “Amp Assign” setting (page 25) is set to “Front Height”.</p> <p>NOTE Select “Large” or “Small” not according to the physical size of the speaker but according to the low frequency reproduction capabilities based on the frequency set at “Crossover Frequency” (page 27).</p>	<p>Surround : Set the presence and size of the Surround speakers.</p> <ul style="list-style-type: none"> • Large : Use of a large speaker that can adequately play back low frequencies. • Small : Use of a small speaker that has inadequate playback capacity for low frequencies. • None : Select when the surround speakers are not connected. <p> “Large” is not displayed when “Front” is set to “Small”.</p> <p>S.Back : Set the presence, size and number of surround back speakers.</p> <ul style="list-style-type: none"> • Large : Use of a large speaker that can adequately play back low frequencies. • Small : Use of a small speaker that has inadequate playback capacity for low frequencies. • None : Select when the surround back speakers are not connected. • 2sp : Use two surround back speakers. • 1sp : Use only one surround back speaker. Surround back audio is output from the surround back L terminal. <p> • “Large” is not displayed when “Surround” is set to “Small”. • Even if “S.Back” is set to “Large”, the “S.Back” setting is automatically switched to “Small” if “Surround” is set to “Small”.</p> <p>NOTE Even when the Surround Back Speaker setting is other than “None”, sound may not be emitted from the surround back speaker, depending on the playback source. In this case, “Surround Back” setting other than “OFF” (page 45).</p> <p>Front Height : Set the front height speaker size.</p> <ul style="list-style-type: none"> • Large : Use of a large speaker that can adequately play back low frequencies. • Small : Use of a small speaker that has inadequate playback capacity for low frequencies. • None : Select when a front height speaker is not connected. <p> • “Large” is not displayed when “Front” is set to “Small”. • Even if “Front Height” is set to “Large”, the “Front Height” setting is automatically switched to “Small” if “Front” is set to “Small”.</p>

Setting items	Setting contents
<p>Bass Setting Make the settings related to playback of low frequency signals (subwoofer and LFE).</p> <p>This can be set when “Speaker Config.” – “Subwoofer” (page 25) is set to “Yes”.</p>	<p>Subwoofer Mode : Select low range signal to be reproduced by subwoofer.</p> <ul style="list-style-type: none"> • LFE : Add the low frequency signal of the channel for which the speaker size is set to “Small” to the subwoofer signal and output it. • LFE+Main : Add the low frequency signal of all channels to the subwoofer signal and output it. <p> • Play music or a movie source and select the mode offering the strongest bass. • Select “LFE+Main” if you want the bass signals to always be produced from the subwoofer.</p> <p>LPF for LFE : Set the upper limit of the low frequency signals output from the subwoofer. • 80Hz / 90Hz / 100Hz / 110Hz / 120Hz / 150Hz / 200Hz / 250Hz</p> <p>Unit : Set the unit of distance.</p> <ul style="list-style-type: none"> • Feet • Meters <p>Step : Set the minimum variable width of the distance.</p> <ul style="list-style-type: none"> • 1ft / 0.1ft • 0.1m / 0.01m <p>• FL (Front L)/ FR (Front R)/ C (Center)/ SW (Subwoofer)/ SL (Surround L)/ SR (Surround R)/ SBL (Surr. Back L)/ SBR (Surr. Back R)/ FHL (Front Height L)/ FHR (Front Height R) : Select the speaker you want to set, and set the distance. Set the value that is closest to the measured distance. • 0.0ft ~ 60.0ft / 0.00m ~ 18.00m</p> <p></p> <ul style="list-style-type: none"> • The speakers that can be selected differ depending on the “Amp Assign” (page 25) and “Speaker Config.” (page 25) settings. • Default settings : Front/Center/Subwoofer/Front Height : 3.6 meters (12 feet) Surround/Surr. Back : 3.0 meters (10 feet) <p>NOTE Set the difference in the distance between the speakers to less than 6.0 meters (20 feet). “Relocate Speaker” is displayed on the screen if an inappropriate distance is set.</p> <p>Default : Reset all distance settings to factory default.</p> <ul style="list-style-type: none"> • Yes : Reset to the defaults. • No : Do not reset to the defaults.

Setting items	Setting contents
Channel Level Set the volume of the test tone to be the same when it is output from each speaker.	Test Tone Start : Output test tones. FL (Front L)/ C (Center)/ FR (Front R)/ SR (Surround R)/ SBR* (Surround Back R)/ SBL* (Surround Back L)/ SL (Surround L)/ FHL (Front Height L)/ FHR (Front Height R)/ SW (Subwoofer) : Select the speaker. *When the "S.Back" setting (page 26) is set to "1sp," "SB" is displayed. • -12.0dB ~ +12.0dB (0.0dB) : Adjust the volume.  • When "Channel Level" is adjusted, the adjusted values are set for all the surround modes. To adjust the channel level separately for the different surround modes, use the operation see "Adjust the volume of the different speakers" (page 50). • Speakers set to "None" in the "Speaker Config." (page 25) settings are not displayed. • When < is pressed while the subwoofer volume is set to "-12dB," the "Channel Level" setting switches to "OFF." • If output of the test tones begins while the muting mode is set, the muting mode is canceled.
	Default : Reset all channel level settings to factory default. Yes : Reset to the defaults. No : Do not reset to the defaults.
Crossover Frequency Outputs at below set frequency, each speaker's bass signal output from the subwoofer. Set this according to the low frequency reproduction capabilities of the speakers you are using.	Crossover : Outputs at below set frequency, each speaker's bass signal output from the subwoofer. • 40Hz / 60Hz / 80Hz / 90Hz / 100Hz / 110Hz / 120Hz / 150Hz / 200Hz / 250Hz • Advanced : Set the low frequency signals to be output from the signals of the respective speakers to the subwoofer. • Front / Center / Surround / S.Back / Front Height : Select the speaker. · 40Hz / 60Hz / 80Hz / 90Hz / 100Hz / 110Hz / 120Hz / 150Hz / 200Hz / 250Hz : Set the crossover frequency.

This can be set when "Speaker Config." – "Subwoofer" (page 25) is set to "Yes" or "No."

Setting items	Setting contents
Crossover Frequency	 <ul style="list-style-type: none"> Always set the crossover frequency to "80 Hz." When using small speakers, however, we recommend setting the crossover frequency to a higher frequency. For speakers set to "Small," sound below the crossover frequency is cut from the sound output. The cut bass sound is output from the subwoofer or front speakers. The speakers that can be set when "Advanced" is selected differ according to the "Bass Setting" setting (page 26). <ul style="list-style-type: none"> When "LFE" is selected, speakers set to "Small" at "Speaker Config." (page 25) can be set. When "LFE+Main" is selected, speakers can be set regardless of the speaker size setting.
Front Speaker Setup Select front speakers to use for each surround mode.	Setting : Choose the method for setting the front speakers. • Normal : The front speakers are set using the  . • Custom : The front speakers used for the different playing modes are set in advance. DIRECT/STEREO : The front speakers used in the direct, stereo and pure direct play modes are set in advance. <ul style="list-style-type: none"> A : Front speaker A is used. B : Front speaker B is used. A+B : Both front speakers A and B are used. MULTI CH : The front speakers used in modes other than the direct, stereo and pure direct play modes are set in advance. <ul style="list-style-type: none"> A : Front speaker A is used. B : Front speaker B is used. A+B : Both front speakers A and B are used.
	NOTE <ul style="list-style-type: none"> When set to "Custom,"  does not operate. The front speaker setting stored for the "Quick Select" function is given priority.



Making the HDMI settings (HDMI Setup)

Default settings are underlined.

Make settings for HDMI video/audio output.

Setting items	Setting contents
Auto Lip Sync Automatic compensation for timing shift in audio and video output.	ON : Compensated. OFF : Not compensated.
HDMI Audio Out Select HDMI audio output device.	Amp : Use speakers connected to AVR-1910 for audio playback. TV : Use speakers of TV for audio playback. NOTE When the HDMI control function is operating, the setting of audio playback in the connected TV takes priority (page 49 "Controlling HDMI-compatible devices from the AVR-1910 (HDMI Control Function)").
HDMI Control External devices can be controlled from the AVR-1910 and the AVR-1910 can be controlled from external devices. NOTE The HDMI control function controls operations of a TV that is compatible with the HDMI control function. Make sure that the TV and HDMI are connected when you perform HDMI control.	ON : Use the HDMI control function. OFF : Do not use the HDMI control function. • Please consult the operating instructions for each connected device to check the settings. • For details on the HDMI control function, see "Controlling HDMI-compatible devices from the AVR-1910 (HDMI Control Function)" (page 49). NOTE • When "Control" is set to "ON", it consumes more standby power. • When not using this unit for a long period, we recommend that you press to turn off (OFF) the power. • When the "HDMI Control" setting has been changed, always turn off the power to the connecting devices afterwards and then turn back on. • The "HDMI Control" does not work when the power to the equipment is off. • When "HDMI Control" is set to "ON", power is supplied constantly to the AC outlet (UNSWITCHED).
Standby Source Set the HDMI connector for HDMI signal input during standby. This can be set when "HDMI Control" is set to "ON".	Last : Standby with last used input source during power on. HDMI1 / HDMI2 / HDMI3 / HDMI4 : The standby mode is set at the input source assigned to the respective.

Setting items	Setting contents
Power Off Control The power of the AVR-1910 and external device turn off together. This can be set when "HDMI Control" is set to "ON".	ON : Switched. OFF : Not switched. • Please consult the operating instructions for each connected device to check the settings. • For details on the HDMI control function, see "Controlling HDMI-compatible devices from the AVR-1910 (HDMI Control Function)" (page 49).



Making the audio settings (Audio Setup)

Default settings are underlined.

Make settings for audio playback.

Setting items	Setting contents
EXT.IN SW Level Set the playback level of the analog subwoofer signals input from the external input terminals (EXT.IN).	<p><u>+15dB</u> : This is the recommended level.</p> <p><u>+10dB / +5dB / 0dB</u> : Select the level according to the player being used.</p>
2ch DIRECT/STEREO Make speaker settings for 2-channel mode playback.	<p>Setting : Select the method for setting the speakers used in the 2-channel direct and stereo playback modes.</p> <ul style="list-style-type: none"> • Basic : The settings at "Speaker Setup" (page 25) are applied. • Custom : Make separate settings for 2-channel mode. <p>Front : Set the front speaker size.</p> <ul style="list-style-type: none"> • <u>Large</u> : Use of a large speaker that can adequately play back low frequencies. • Small : Use of a small speaker that has inadequate playback capacity for low frequencies. <p>SW : Set the presence of a subwoofer.</p> <ul style="list-style-type: none"> • <u>Yes</u> : Use a subwoofer. • No : Select when a subwoofer is not connected. <p>SW Mode : Select low range signal to be reproduced by subwoofer.</p> <ul style="list-style-type: none"> • <u>LFE</u> : Add the low frequency signal of the channel for which the speaker size is set to "Small" to the subwoofer signal and output it. • LFE+Main : Add the low frequency signal of all channels to the subwoofer signal and output it. <p>Crossover : Outputs at below set frequency, each speaker's bass signal output from the subwoofer.</p> <ul style="list-style-type: none"> • 40Hz / 60Hz / <u>80Hz</u> / 90Hz / 100Hz / 110Hz / 120Hz / 150Hz / 200Hz / 250Hz <p>Distance FL / Distance FR : Select the speaker you want to set, and set the CH Level. Set the value that is closest to the measured distance.</p> <ul style="list-style-type: none"> • 0.0ft ~ 60.0ft (<u>12.0ft</u>) / 0.00m ~ 18.00m (<u>3.6m</u>) <p>CH Level FL/ CH Level FL FR : Select the speaker you want to set, and set the CH Level. Adjust the level of each channel.</p> <ul style="list-style-type: none"> • -12.0dB ~ +12.0dB(<u>0.0dB</u>)

Setting items	Setting contents
Auto Surround Mode Make setting for memorizing surround mode setting for each input signal type.	<p>ON : Memorize settings. Most recently stored surround mode is automatically selected.</p> <p>OFF : Do not memorize settings. Surround mode does not change according to input signal.</p> <p> The auto surround mode function lets you store in the memory the surround mode last used for playing the four types of input signals listed below.</p> <ol style="list-style-type: none"> ① Analog and PCM 2-channel signals ② Dolby Digital and DTS 2-channel signals ③ Dolby Digital and DTS multi-channel signals ④ Multi-channel signals other than Dolby Digital and DTS (PCM, etc.) <p>NOTE When playing in the PURE DIRECT mode, the surround mode does not change even if the input signal is changed.</p>
EQ Customize Set so that unused equalizer settings are not displayed when is used.	<p>Audyssey Byp. L/R / Audyssey Flat / Manual</p> <ul style="list-style-type: none"> • <u>Used</u> • Not Used <p>NOTE</p> <ul style="list-style-type: none"> • Set so that the "Audyssey Byp. L/R" and "Audyssey Flat" settings can be made when the Audyssey Auto Setup procedure is performed. • Equalizer settings for which "Not Used" is set with the Quick Select function cannot be stored and called out.



Making the ZONE2 settings (ZONE2 Setup)

Default settings are underlined.

Make settings for audio playback in a ZONE2 system.

"ZONE2 Setup" is displayed when ZONE2 is selected with "Amp Assign" (page 25).

Setting items	Setting contents
Level Lch Adjust the left channel output level.	-12dB ~ +12dB (<u>0dB</u>)
Level Rch Adjust the right channel output level.	-12dB ~ +12dB (<u>0dB</u>)
Volume Display Set the ZONE2 volume display method.	Relative : The volume is displayed within the range of -- -dB (Minimum), -80 dB ~ +18 dB. Absolute : The volume is displayed within the range of 0, 1 ~ 99.
Vol.Limit Make a setting for maximum volume.	OFF : Do not set a maximum volume. -20dB / -10dB / 0dB
Power On Level Define the volume setting that is active when the power is turned on.	Last : Use the memorized setting from the last session. --- : Always use the muting on condition when power is turned on. -80dB ~ +18dB (99) : The volume is adjusted to the set level.
Mute Level Set the amount of attenuation when muting is on.	Full : The sound is cut off entirely. -40dB : The sound is attenuated by 40 dB. -20dB : The sound is attenuated by 20 dB.



- The volume is displayed using the display method set at "Volume Display" (page 30).
- Set the main volume at "Volume Control" (page 30).



Making other settings (Option Setup)

Default settings are underlined.

Setting items	Setting contents
Volume Control Set the MAIN ZONE volume setting.	Volume Display : Set the volume display method. • Relative : The volume is displayed within the range of -- -dB (Minimum), -80 dB ~ +18 dB. • Absolute : The volume is displayed within the range of 0, 1 ~ 99. Vol.Limit : Make a setting for maximum volume. • OFF : Do not set a maximum volume. • -20dB(61) / -10dB(71) / 0dB(81) Power On Level : This sets the volume set when the MAIN ZONE's power is turned on. • Last : Use the memorized setting from the last session. • --- : Always use the muting on condition when power is turned on. • -80dB(1) ~ +18dB(99) : The volume is adjusted to the set level. Mute Level : This sets the amount of attenuation of the volume when the mute mode is set in the MAIN ZONE. • Full : The sound is cut off entirely. • -40dB : The sound is attenuated by 40 dB. • -20dB : The sound is attenuated by 20 dB.
Source Delete Remove input sources that are not used from the display.	TUNER / CD / DVD / HDP / TV / SAT/CBL / VCR / DVR / V.AUX / SIRIUS : Select the sources you do not want to use. • ON : Use this source. • Delete : Do not use this source. NOTE • The currently selected input source cannot be set. • Input sources set to "Delete" cannot be selected using .
On-Screen Display Make the settings related to displays on the TV screen.	Screensaver : Make screensaver settings. • ON : The screen switches to the screensaver if no operation is performed for approximately 3 minutes while a menu is displayed or while an iPod screen is displayed. When you press $\Delta \nabla \triangleleft \triangleright$, the screen saver is cancelled and the screen before that screen saver started is displayed. • OFF : Turn the screensaver function off. Text : The mode name is displayed when the operation for switching the surround mode, input mode, etc., is performed. • ON : Turn display on. • OFF : Turn display off. Master Volume : Master volume display during adjustment. • Bottom : Displayed at the bottom of the screen. • Top : Displayed at the top of the screen. • OFF : Turn display off.

See overleaf







Remote control operation buttons







MENU : Displaying the menu
○ : Cancel the menu

: Moves the cursor (Up/Down/Left/Right)

ENTER : Decision the setting

RETURN : Return to previous menu

Setting items	Setting contents								
On-Screen Display Make the settings related to displays on the TV screen.	Tuner Information : This sets the time the on-screen display is displayed when a tuner operation is performed. <ul style="list-style-type: none"> • Always : Show display continuously. • 30sec : Show display for 30 seconds after operation. • 10sec : Show display for 10 seconds after operation. • OFF : Turn display off. iPod Information : This sets the time the on-screen display is displayed when an iPod operation is performed. <ul style="list-style-type: none"> • Always : Show display continuously. • 30sec : Show display for 30 seconds after operation. • 10sec : Show display for 10 seconds after operation. • OFF : Turn display off. 								
Quick Select Name Change the Quick Select name.	Rename Label : Change the display name of the selected "Quick Select" setting. <ol style="list-style-type: none"> 1. Use $\Delta \nabla$ to select the name of the Quick Select setting you want to change, then press . 2. Use $\triangleleft \triangleright$ to set the cursor to the character you want to change. 3. Use $\Delta \nabla$ to change the character, then press . <ul style="list-style-type: none"> • Up to 16 characters can be input. • The input character type can be switched by pressing  while the display name is being changed. • The types of characters that can be input are as shown below. <div style="border: 1px solid black; padding: 5px; margin: 5px 0;"> <table> <tr> <td>[Capital letters]</td> <td>ABCDEFGHIJKLMNOPQRSTUVWXYZ</td> </tr> <tr> <td>[Small letters]</td> <td>abcdefghijklmnopqrstuvwxyz</td> </tr> <tr> <td>[Symbols]</td> <td>' () * + - . / : ; < = > ? []</td> </tr> <tr> <td>[Numbers]</td> <td>0123456789 (space)</td> </tr> </table> </div> 4. Repeat steps 2 and 3 to change the display name. Template : The display name can be changed by selecting "Operation" and "Device Name" from the previously set templates. <ol style="list-style-type: none"> 1. Use $\Delta \nabla$ to select the name of the Quick Select setting you want to change, then press . 2. Use $\Delta \nabla$ to select "Template", then press . 3. Use $\Delta \nabla$ to select "Operation", then press . <ul style="list-style-type: none"> • Watch / Listen to / Play / For 4. Use $\Delta \nabla \triangleleft \triangleright$ to select "Device Name", then press . <ul style="list-style-type: none"> • DVD / Blu-Ray / HDP / TV / CableTV / Satellite / VCR / DVR / iPod / V.AUX / LD / Movie (When "Operation" is selected to "Watch".) • CD / TUNER / SIRIUS / iPod / MD / TAPE / MUSIC (When "Operation" is selected to "Listen to".) • PC / Game (When "Operation" is selected to "Play".) • Father / Mother / Son / Daughter / Brother / Sister / Grandfather / Grandmother / Me (When "Operation" is selected to "For".) 	[Capital letters]	ABCDEFGHIJKLMNOPQRSTUVWXYZ	[Small letters]	abcdefghijklmnopqrstuvwxyz	[Symbols]	' () * + - . / : ; < = > ? []	[Numbers]	0123456789 (space)
[Capital letters]	ABCDEFGHIJKLMNOPQRSTUVWXYZ								
[Small letters]	abcdefghijklmnopqrstuvwxyz								
[Symbols]	' () * + - . / : ; < = > ? []								
[Numbers]	0123456789 (space)								

Setting items	Setting contents								
Quick Select Name	Default : The changed display names are reset to the defaults. <ul style="list-style-type: none"> • Yes : Reset to the defaults. • No : Do not reset to the defaults. 								
Zone Rename Rename the display names of the different zones as desired.	<ol style="list-style-type: none"> 1. Use $\Delta \nabla$ to select the zone name you want to change, then press . MAIN ZONE / ZONE2 2. Use $\triangleleft \triangleright$ to set the cursor to the character you want to change. 3. Use $\Delta \nabla$ to change the character, then press . <ul style="list-style-type: none"> • Up to 10 characters can be input. • The input character type can be switched by pressing  while the display name is being changed. • The types of characters that can be input are as shown below. <div style="border: 1px solid black; padding: 5px; margin: 5px 0;"> <table> <tr> <td>[Capital letters]</td> <td>ABCDEFGHIJKLMNOPQRSTUVWXYZ</td> </tr> <tr> <td>[Small letters]</td> <td>abcdefghijklmnopqrstuvwxyz</td> </tr> <tr> <td>[Symbols]</td> <td>' () * + - . / : ; < = > ? []</td> </tr> <tr> <td>[Numbers]</td> <td>0123456789 (space)</td> </tr> </table> </div> 4. Repeat steps 2 and 3 to change the display name. 	[Capital letters]	ABCDEFGHIJKLMNOPQRSTUVWXYZ	[Small letters]	abcdefghijklmnopqrstuvwxyz	[Symbols]	' () * + - . / : ; < = > ? []	[Numbers]	0123456789 (space)
[Capital letters]	ABCDEFGHIJKLMNOPQRSTUVWXYZ								
[Small letters]	abcdefghijklmnopqrstuvwxyz								
[Symbols]	' () * + - . / : ; < = > ? []								
[Numbers]	0123456789 (space)								
Display Adjust display brightness of the receiver.	<ul style="list-style-type: none"> • Bright : Normal display brightness. • Dim : Reduced display brightness. • Dark : Very low display brightness. • OFF : Turns the display off.  Switching is also possible by pressing  on the main unit.								
Setup Lock Protect settings from inadvertent change.	<ul style="list-style-type: none"> • ON : Turn protection on. • OFF : Turn protection off.  When "Setup Lock" is set to "ON," the settings listed below can no longer be changed. Also, "SETUP LOCKED!" is displayed if you attempt to operate related settings. <ul style="list-style-type: none"> • RESTORER • MultEQ • Dynamic EQ • Dynamic Volume • Channel Level • Audio Delay 								



Making the input settings (Input Setup)

Make the settings related to the currently selected input source.

Before displaying the menu screen, press to switch to the input source to be set.

The items that can be set differ according to the selected input source.

The set can be used without changing these settings. Make these settings as necessary.

For a description of "Menu map" and operating instructions, see page 18.

Items that can be set with the Input Setup procedure

Changing the Input Sources Assigned to the Input Terminals (Assign)

page 33

Making the video settings (Video) page 34

Changing the Input Source's Input Mode and Decoding mode (Input mode) page 34

Changing the Input Source's Display Name (Rename) page 35

Correcting the Input Source's Playback Level (Source Level)

page 35

Setting the iPod Playback Mode (iPod Playback Mode) page 35

Presetting Radio Stations (Auto Preset) page 36

Setting the Preset Channels to be Skipped (Preset Skip) page 36

Assign Name to a Preset Memory (Preset Name) page 36

Setting Radio Reception Restrictions (Parental Lock) page 37

Check the SIRIUS Radio Reception Sensitivity (Antenna Aiming)

page 37

Examples of Menu Screen Displays

Assign

5-1-1. Input Assign

HDMI	Digi	Comp
DVD	1	C1
HDP	2	
TV		01
SAT/CBL	3	C2
VCR/iPod		
DVR	4	02

[ENT] : Select [RTN] : Back

Video

5-2. Video

Video Select : ◀ Source ▶

i/p Scaler : Anlg/HDMI

Resolution A : Auto

Resolution H : Auto

Progre. Mode : Auto

Aspect : Full

[RTN] : Back

Input Mode

5-3. Input Mode

Input Mode : ◀ Auto ▶

Decode Mode : Auto

[RTN] : Back

Rename

5-4. Rename

DVD : ◀ DVD ▶

Default

[▲▼] : Up/Down [↔] : Rename

[RTN] : Back

Source Level

5-5. Source Level

Analog Input : ◀ 0dB ▶

Digital Input : 0dB

[RTN] : Back

iPod Playback Mode

5-6. iPod Playback Mode

Repeat Mode : ◀ One ▶

Shuffle Mode : OFF

[RTN] : Back

Auto Preset

5-1. Auto Preset

Auto Tuning

Preset Station Memory

Storing Preset Memory

Start

[ENT] : Start [RTN] : Back

Preset Skip

5-2. Preset Skip

Block Presets : ◀ A ▶

A Block Presets	: ON
A1 FM 87.50MHz	: ON
A2 FM 89.10MHz	: ON
A3 FM 98.10MHz	: ON
A4 FM 107.90MHz	: ON
A5 FM 90.10MHz	: ON
A6 FM 90.10MHz	: ON
A7 FM 90.10MHz	: ON
A8 FM 90.10MHz	: ON

[ENT] : Select [RTN] : Back

Preset Name

5-3. Preset Name

Block : ◀ A ▶

A1 FM 87.50MHz	: ON
A2 FM 89.10MHz	: ON
A3 FM 98.10MHz	: ON
A4 FM 107.90MHz	: ON
A5 FM 90.10MHz	: ON
A6 FM 90.10MHz	: ON
A7 FM 90.10MHz	: ON
A8 FM 90.10MHz	: ON

[ENT] : Select [RTN] : Back

Parental Lock

5-2. Parental Lock

1. Lock Setting

2. Edit Lock Code

[ENT] : Select [RTN] : Back

Antenna Aiming

5-3. Antenna Aiming

Satellite : 0

MIN MAX

Terrestrial : 0

MIN MAX

ing Started
Connections
Settings
Playback
Multi-Zone
Remote Control
Information
Troubleshooting
Specifications

Remote control operation buttons

MENU : Displaying the menu
○ : Cancel the menu

: Moves the cursor (Up/Down/Left/Right)

ENTER : Decision the setting

RETURN : Return to previous menu

Changing the Input Sources Assigned to the Input Terminals (Assign)

Default settings are underlined.



Setting items	Setting contents																						
Input Assign (HDMI) Assign input sources to input connectors.	<p>HDMI : The DVD HDP TV SAT/CBL VCR DVR V.AUX input sources are assigned to the HDMI input terminals as shown below.</p> <ul style="list-style-type: none"> • HDMI1 / HDMI2 / HDMI3 / HDMI4 • None : Do not assign an HDMI input terminal to the currently selected input source. <p>※ Upon purchase, the settings of the different input sources are as shown below.</p> <table border="1"> <thead> <tr> <th>Input source</th> <th>DVD</th> <th>HDP</th> <th>TV</th> <th>SAT/CBL</th> <th>VCR</th> <th>DVR</th> <th>V.AUX</th> </tr> </thead> <tbody> <tr> <td>Default setting</td> <td>HDMI1</td> <td>HDMI2</td> <td>None</td> <td>HDMI3</td> <td>None</td> <td>HDMI4</td> <td>None</td> </tr> </tbody> </table> <p> When HDMI is assigned to an input source, the audio signal switches to HDMI along with the video signal. To use with the digital audio input connectors assigned, set menu "Input Mode" (page 34) to "Digital".</p> <ul style="list-style-type: none"> • When the AVR-1910 and TV are connected with an HDMI cable, if the TV is not compatible with HDMI audio signal playback, only the video signals are output to the monitor. • The audio signals input from the analog, digital and EXT. IN connectors are not output to the TV. <p>NOTE When "HDMI Control" is set to "ON", HDMI cannot be assigned to "TV" at the "HDMI" settings (page 28).</p>	Input source	DVD	HDP	TV	SAT/CBL	VCR	DVR	V.AUX	Default setting	HDMI1	HDMI2	None	HDMI3	None	HDMI4	None						
Input source	DVD	HDP	TV	SAT/CBL	VCR	DVR	V.AUX																
Default setting	HDMI1	HDMI2	None	HDMI3	None	HDMI4	None																
Input Assign (Digital) Assign input sources to input connectors.	<p>Digital : The DVD HDP TV SAT/CBL VCR DVR V.AUX CD SIRIUS input sources are assigned to the digital audio input terminals as shown below.</p> <ul style="list-style-type: none"> • C1 (COAX1) / C2 (COAX2) / O1 (OPT1) / O2 (OPT2) • None : Do not assign a digital input terminal to the currently selected input source. <p>※ Upon purchase, the settings of the different input sources are as shown below.</p> <table border="1"> <thead> <tr> <th>Input source</th> <th>DVD</th> <th>HDP</th> <th>TV</th> <th>SAT/CBL</th> <th>VCR</th> </tr> </thead> <tbody> <tr> <td>Default setting</td> <td>COAX1</td> <td>None</td> <td>OPT1</td> <td>COAX2</td> <td>None</td> </tr> </tbody> </table> <table border="1"> <thead> <tr> <th>Input source</th> <th>DVR</th> <th>V.AUX</th> <th>CD</th> <th>SIRIUS</th> </tr> </thead> <tbody> <tr> <td>Default setting</td> <td>OPT2</td> <td>None</td> <td>None</td> <td>None</td> </tr> </tbody> </table>	Input source	DVD	HDP	TV	SAT/CBL	VCR	Default setting	COAX1	None	OPT1	COAX2	None	Input source	DVR	V.AUX	CD	SIRIUS	Default setting	OPT2	None	None	None
Input source	DVD	HDP	TV	SAT/CBL	VCR																		
Default setting	COAX1	None	OPT1	COAX2	None																		
Input source	DVR	V.AUX	CD	SIRIUS																			
Default setting	OPT2	None	None	None																			

Setting items	Setting contents																
Input Assign (Component) Assign input sources to input connectors.	<p>Component : The DVD HDP TV SAT/CBL VCR DVR V.AUX input sources are assigned to the component video input terminals as shown below.</p> <ul style="list-style-type: none"> • COMP1 (Component video 1 input terminal) / COMP2 (Component video 2 input terminal) • None : Do not assign the component video input terminals to the currently selected input source. <p>※ Upon purchase, the settings of the different input sources are as shown below.</p> <table border="1"> <thead> <tr> <th>Input source</th> <th>DVD</th> <th>HDP</th> <th>TV</th> <th>SAT/CBL</th> <th>VCR</th> <th>DVR</th> <th>V.AUX</th> </tr> </thead> <tbody> <tr> <td>Default setting</td> <td>COMP1</td> <td>None</td> <td>None</td> <td>None</td> <td>None</td> <td>COMP2</td> <td>None</td> </tr> </tbody> </table>	Input source	DVD	HDP	TV	SAT/CBL	VCR	DVR	V.AUX	Default setting	COMP1	None	None	None	None	COMP2	None
Input source	DVD	HDP	TV	SAT/CBL	VCR	DVR	V.AUX										
Default setting	COMP1	None	None	None	None	COMP2	None										
iPod Dock Change the input source to which the control dock for iPod is assigned.	<p>The control dock for iPod can be assigned to the DVD SAT/CBL VCR DVR V.AUX CD input sources.</p> <p>Assign : Assign the currently selected input source to the Control Dock for iPod input.</p> <p>None : Do not assign the currently selected input source to the Control Dock for iPod input.</p> <p> With the default settings, the control dock for iPod can be used connected to the VCR (iPod) connector.</p> <ul style="list-style-type: none"> • Even if "iPod Dock" is set to "Assign", if AVR-1910 and control dock for iPod are not connected, the input is used as the normal input source. 																

Making the video settings (Video)

Default settings are underlined.



The items that can be set depend on the input source and the "Assign" setting.

Setting items	Setting contents
Video Select Switch video input source while listening to audio signal.	Source : Play the picture and sound of the input source. DVD / HDP / TV / SAT/CBL / VCR / DVR / V.AUX : Select video input source to view. This can be set for individual input sources. NOTE <ul style="list-style-type: none"> It is not possible to select HDMI input signals. When playing HDMI video input signals, the analog video signal of another input source cannot be selected for the HDMI video output. Input sources for which "Delete" is selected at "Source Delete" (page 30) cannot be selected. Input sources for which "None" is selected at "Assign" (page 33) cannot be selected.  • This can also be set by pressing  . • To cancel, press  to select "Source".
i/p Scaler The input source's resolution is converted to the resolution set at "Resolution".	This can be set to the DVD HDP TV SAT/CBL VCR DVR V.AUX input sources. OFF : Do not use i/p scaler function. Analog : Analog signals are converted to HDMI signals. Analog and HDMI : Both analog signals and HDMI signals are converted to the desired HDMI resolution.
Resolution Set the output resolution. Resolution A : Analog Video Resolution H : HDMI	This can be set when the input source is set to DVD HDP TV SAT/CBL VCR DVR V.AUX , and when "i/p Scaler" is set to anything other than "OFF". AUTO : Detect monitor panel resolution and automatically set output resolution. 480p/576p / 1080i / 720p / 1080p : Select the output resolution.
Progressive Mode Select optimum progressive mode for video material.	This can be set when the input source is set to DVD HDP TV SAT/CBL VCR DVR V.AUX , and when "i/p Scaler" is set to anything other than "OFF". AUTO : The video material is automatically detected and the appropriate mode is set. Video1 : Select mode suitable for video playback. Video2 : Select mode suitable for video and 30-frame film material playback.
Aspect Set the aspect ratio of the video signal output from the HDMI terminal.	This can be set when the input source is set to DVD HDP TV SAT/CBL VCR DVR V.AUX , and when "i/p Scaler" is set to anything other than "OFF". Normal : Output at 4:3 aspect ratio. Full : Output at 16:9 aspect ratio.

Changing the Input Source's Input Mode and Decoding mode (Input Mode)

Default settings are underlined.

The selectable input modes depend on the input source and "Assign" setting (page 33 "Changing the input sources assigned to the input terminals").

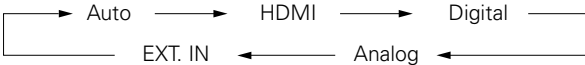





Setting items	Setting contents												
Input Mode Set the audio input modes for the different input sources.	Auto : Automatically detect input signal and perform playback. HDMI : Play only signals from HDMI input. (Excluding CD and SIRIUS) Digital : Play only signals from digital input. Analog : Play only signals from analog input. EXT. IN : Play only signals from EXT. IN input. ※ Upon purchase, the settings of the different input sources are as shown below.												
	<table border="1"> <thead> <tr> <th>Input source</th> <th>DVD</th> <th>HDP</th> <th>TV</th> <th>SAT/CBL</th> <th>VCR</th> </tr> </thead> <tbody> <tr> <td>Default setting</td> <td>Auto</td> <td>HDMI</td> <td>Digital</td> <td>Auto</td> <td>Analog</td> </tr> </tbody> </table>	Input source	DVD	HDP	TV	SAT/CBL	VCR	Default setting	Auto	HDMI	Digital	Auto	Analog
Input source	DVD	HDP	TV	SAT/CBL	VCR								
Default setting	Auto	HDMI	Digital	Auto	Analog								
	<table border="1"> <thead> <tr> <th>Input source</th> <th>DVR</th> <th>V.AUX</th> <th>CD</th> <th>TUNER</th> </tr> </thead> <tbody> <tr> <td>Default setting</td> <td>Auto</td> <td>Analog</td> <td>Analog</td> <td>Analog</td> </tr> </tbody> </table>	Input source	DVR	V.AUX	CD	TUNER	Default setting	Auto	Analog	Analog	Analog		
Input source	DVR	V.AUX	CD	TUNER									
Default setting	Auto	Analog	Analog	Analog									
	 • The "HDMI" settings are made for input sources for which HDMI input terminals are assigned at "Assign" (page 33). • The "Digital" settings are made for input sources for which digital input terminals are assigned at "Assign" (page 33). • When a digital signal is properly input, the "DIG." indicator lights on the display. If the "DIG." indicator does not light, check the digital input connector assignment and the connections. • The surround mode cannot be set if the input mode is set to "EXT. IN". • This can also be set by pressing  . Each time you press the button, the input mode display will change.												
	 <pre> graph LR Auto --> HDMI HDMI --> Digital Digital --> Analog Analog --> EXT_IN[EXT. IN] EXT_IN --> Auto </pre>												

Setting items	Setting contents
Decode Mode Set the input source's decoding mode.	<p>Auto : Detect type of digital input signal and decode and play automatically.</p> <p>PCM : Decode and play only PCM input signals.</p> <p>DTS : Decode and play only DTS input signals.</p> <p></p> <ul style="list-style-type: none"> This can be set for input sources for which "HDMI" or "Digital" is assigned at "Assign" (page 33). Normally set this to "Auto".

Changing the Input Source's Display Name (Rename)

Default settings are underlined.

Use this procedure to change the display name of the currently selected input source.

Setting items	Setting contents
Rename Change the input source's display name to the desired name.	<ol style="list-style-type: none"> Use   to set the cursor to the character you want to change. Use   to change the character, then press . <ul style="list-style-type: none"> Up to 8 characters can be input. The input character type can be switched by pressing  while the display name is being changed. The types of characters that can be input are as shown below. <div style="border: 1px solid black; padding: 5px; margin: 5px 0;"> <p>[Capital letters] ABCDEFGHIJKLMNOPQRSTUVWXYZ</p> <p>[Small letters] abcdefghijklmnopqrstuvwxyz</p> <p>[Symbols] ' () * + - . / : ; < = > ? []</p> <p>[Numbers] 0123456789 (space)</p> </div>
Default The changed display names are reset to the defaults.	<p>Yes : Reset to the defaults.</p> <p>No : Do not reset to the defaults.</p>

Correcting the Input Source's Playback Level (Source Level)

Default settings are underlined.

Use this procedure to correct the playback level of the currently selected input source's audio input. Set this if there are differences in the input volume levels between the different sources. The analog input level and digital input level can be corrected separately.

Setting items	Setting contents
Source Level (Analog) Correct the playback level of the analog audio input.	-12dB ~ +12dB (<u>0dB</u>)
Source Level (Digital) Correct the playback level of the digital audio input.	-12dB ~ +12dB (<u>0dB</u>)

Setting the iPod Playback Mode (iPod Playback Mode)

Default settings are underlined.

This can be selected for input sources for which "Assign" is assigned at the "iPod Dock" (page 33) setting.

Setting items	Setting contents
Repeat Make settings for repeat mode.	<p>All : Repeat all songs.</p> <p>One : Repeat the current song.</p> <p>OFF : Cancel repeat mode.</p>
Shuffle Make settings for shuffle mode.	<p><input type="checkbox"/> When DENON control dock for iPod ASD-1R or ASD-11R is connected</p> <p>Songs : Shuffle all songs.</p> <p>Albums : Shuffle songs from current album only.</p> <p>OFF : Cancel shuffle mode.</p>

Presetting Radio Stations (Auto Preset)

Default settings are underlined.

Setting items	Setting contents
Auto Preset Use the auto preset function to program radio stations.	This can be set when the source is set to TUNER . Start : Start the auto preset process.  If an FM station cannot be preset automatically, select the desired station by tuning it in manually, then preset it manually.



Setting the Preset Channels to be Skipped (Preset Skip)

Default settings are underlined.



Setting items	Setting contents
Preset Skip Set the preset memories that you do not want to display when tuning.	This can be set when the source is set to TUNER SIRIUS . A ~ G : Select the preset channel(s) you do not want to display. • ON : Display this number. • Skip : Skip this number.  If you set "Block Presets" to "Skip", you can skip the preset memory blocks (A to G).

Assign Name to a Preset Memory (Preset Name)

Default settings are underlined.

Setting items	Setting contents
Preset Name Assign name to a preset memory.	This can be set when the source is set to TUNER . 1. Use $\Delta \nabla$ to select the preset channel name you want to change, then press  . 2. Use $\triangleleft \triangleright$ to set the cursor to the character you want to change. 3. Use $\Delta \nabla$ to change the character, then press  . <ul style="list-style-type: none"> • Up to 8 characters can be input. • The input character type can be switched by pressing  while the display name is being changed. • The types of characters that can be input are as shown below. <div style="border: 1px solid black; padding: 5px; margin: 10px 0;"> [Capital letters] ABCDEFGHIJKLMNOPQRSTUVWXYZ [Small letters] abcdefghijklmnopqrstuvwxyz [Symbols] ' () * + - . / : ; < = > ? [] [Numbers] 0123456789 (space) </div> 4. Repeat steps 2 and 3 to change the display name.

Remote control operation buttons

 : Displaying the menu
 : Cancel the menu















 : Moves the cursor (Up/Down/Left/Right)

 : Decision the setting

 : Return to previous menu



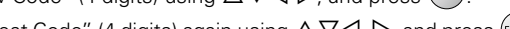









Setting Radio Reception Restrictions (Parental Lock)

Default settings are underlined.

Setting items	Setting contents
Lock Setting Set the channel radio reception limits.	This can be set when the source is set to <u>SIRIUS</u> . <ol style="list-style-type: none"> Press . Using , input the password (4 digits number) and press . Select channel by pressing , and set the lock by pressing . <ul style="list-style-type: none"> Unlock : Do not lock selected channel(s). Lock : Lock selected channel(s). ※ When a Parental Locked channel is tuned, "Code : []" is displayed, then input the password.  <ul style="list-style-type: none"> The default password is "0000". If the password is wrong, "Incorrect Code" is displayed. Input the correct password. While listening to the channel being played, you can also set parental lock ( page 41).
Edit Lock Code Change the password.	This can be set when the source is set to <u>SIRIUS</u> . <ol style="list-style-type: none"> Press . Input "Current Code" (4 digits) using , and press . Input "New Code" (4 digits) using , and press . Input "Repeat Code" (4 digits) again using , and press . If the correct password is input, "Completed" is displayed, and the new password is modified.  <ul style="list-style-type: none"> If the "Current Code" is incorrectly input, "Incorrect Code" is displayed, and proceed again from step 1. If the password input is 3 digits or less, "Enter 4-digit" is displayed, and input again with a 4 digit password. If the new password is not correctly input, "Code don't Match" is displayed and the password does not change. The password cannot be cleared even if the operation to reset the unit is performed. We recommend writing down the password so as not to forget it.

Check the SIRIUS Radio Reception Sensitivity (Antenna Aiming)

Default settings are underlined.

Setting items	Setting contents										
Antenna Aiming Check the SIRIUS radio reception sensitivity.	This can be set when the source is set to <u>SIRIUS</u> . <p>Satellite : Indicate satellite signal strength.</p> <p>Terrestrial : Indicate terrestrial signal strength.</p> <p>SIRIUS Antenna</p> <table border="1"> <thead> <tr> <th>Display</th> <th>Condition</th> </tr> </thead> <tbody> <tr> <td></td> <td>Signal strength is excellent</td> </tr> <tr> <td></td> <td>Signal strength is good</td> </tr> <tr> <td></td> <td>Signal strength is weak</td> </tr> <tr> <td></td> <td>No signal</td> </tr> </tbody> </table>	Display	Condition		Signal strength is excellent		Signal strength is good		Signal strength is weak		No signal
Display	Condition										
	Signal strength is excellent										
	Signal strength is good										
	Signal strength is weak										
	No signal										

Playback

Operation Flow

Before starting playback, make the connections between the different components and the settings on the receiver.

Playing Components (page 38)

- Playing Blu-ray Disc/DVD Players** (page 38)
- iPod® Playback** (page 38)
- Listening to FM/AM Broadcasts** (page 39)
- Listening to SIRIUS Satellite Radio Programs** (page 40)
- Operations During Playback** (page 42)



Selecting the Surround Mode (page 42)

- 1 **Standard Playback** (page 42)
- 2 **Playing in a DENON original surround mode** (page 43)
- 3 **Direct Playback** (page 43)
- 4 **Stereo Playback** (page 44)
- 5 **Playing the Pure Direct mode** (page 44)



Adjusting the Sound Field Effects (Parameter) (page 44)

NOTE

- Also refer to the operating instructions of the connected components when playing them.
- External devices can be controlled by remote control unit (page 52 "Operating the Connected Devices by Remote Control Unit").

Playing Components

Playing Blu-ray Disc / DVD Players

The following describes the procedure for playing Blu-ray disc/DVD players.

Use the same procedure to play other components.

1 Prepare for playback.

- ① Turn on the power of the TV, subwoofer and player.
- ② Set the TV's input to the AVR-1910.
- ③ Load the disc in the player.

2 Turn on the AVR-1910's power. (page 17 "Turning the Power On")

3 Press **SOURCE SELECT** and select the input source.

If "TUNING PRESET" is selected for preset channel, press **SOURCE** before turning



4 Play the component connected to the AVR-1910.

Make the necessary settings on the player (language setting, subtitles setting, etc.) beforehand.

5 Use **▲ ▼** to adjust the volume.

[Variable range] --- -80.0dB ~ 18.0dB

※ The variable range differs according to the input signal and channel level setting.

6 Select the desired surround mode.

(page 42 "Selecting the Surround Mode")

7 Adjust the desired sound field effects.

(page 44 "Adjusting the Sound Field Effects")

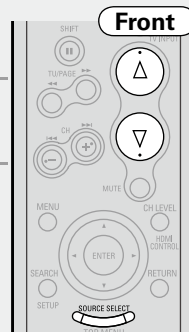

iPod® Playback

The music / video on an iPod can be played by using the control dock for iPod (ASD-1R, ASD-11R, ASD-3N or ASD-3W sold separately).

Connect the control dock for iPod beforehand. (page 14 "iPod®").

Listening to music on an iPod®

1 Prepare for playback.

- ① Set the iPod in the DENON control dock for iPod.
- ② Assign the control dock for iPod's input (page 33).
- ③ Set **DEVICE SELECT** to "MAIN/TV" and **DEVICE SELECT** to "MAIN".

2 Turn on the AVR-1910's power. (page 17 "Turning the Power On")

3 Press **○** to select the input source assigned in step 1-2 above.

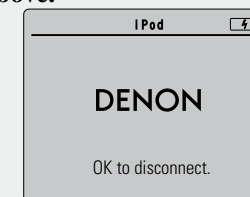

(iPod screen)



※ If the screens above are not displayed, the iPod may not be properly connected. Try connecting again.

See overleaf

4 Press and hold it down for a 2 seconds or more to select the display mode.

There are two modes for display the contents recorded on the iPod.

Browse mode : Displayed on the TV screen.

Remote mode : Displayed on the iPod's screen.

Display mode		Browse mode	Remote mode
Playable files	Audio file	<input type="radio"/>	<input type="radio"/>
	Video file	<input type="radio"/> *1	<input type="radio"/> *2
Active buttons	Remote control unit (AVR-1910)	<input type="radio"/>	<input type="radio"/>
	iPod®	×	<input type="radio"/>

*1 : When using an ASD-11R, ASD-3N or ASD-3W control dock for iPod.

*2 : Video may not be output, depending on the combination of ASD-1R or ASD-11R and iPod.

5 Use to select the menu, then press or to select the music or video file to be played.

6 Press or .

Playback starts.

7 Use to adjust the volume.

[Variable range] --- -80.0dB ~ 18.0dB

※ The variable range differs according to the input signal and channel level setting.

8 Select the desired surround mode. (☞ page 42 "Selecting the Surround Mode")

9 Adjust the desired sound field effects. (☞ page 44 "Adjusting the sound Field Effects")

To stop

During playback, either press and hold or press .

Stopping playback temporarily

During playback, press or . Press again to resume playback.

To cue to the beginning of a track

During playback, either press (to cue to the current track) or (to cue to the next track).

Repeat playback and shuffle playback

"iPod Playback Mode" (☞ page 35)

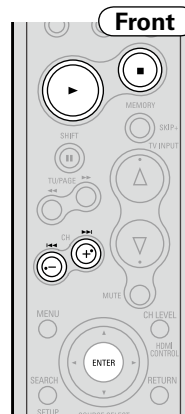

• Use the RESTORER mode to expand the low and high frequency components of compressed audio files and achieve a richer sound. The default setting is "Mode3" (☞ page 48).

• To check the name of the title, the artist or the album when playing in browse mode, press .

• The time (default : 30 sec) for which the on-screen display are displayed can be set at menu "iPod Information" (☞ page 31). Press to return to the original screen.

• Press and set the AVR-1910's power to the standby mode before disconnecting the iPod. Also switch the input source to one to which the menu "iPod dock" is not assigned before disconnecting the iPod.

NOTE

- Depending on the type of iPod and the software version, some functions may not operate.
- DENON will accept no responsibility whatsoever for any loss of iPod data.

Viewing Still Pictures or Videos on the iPod®

- Photo and video data on the iPod can be viewed on the monitor. Only for iPod equipped with slideshow or video functions. (When using an ASD-1R or ASD-11R)
- Video may not be output, depending on the combination of ASD-1R or ASD-11R and iPod.

1 Press and hold to set the Remote mode. "Remote iPod" is displayed on the AVR-1910's display.

2 Watching the iPod's screen, use to select "Photos" or "Videos".

3 Press until the image you want to view is displayed.

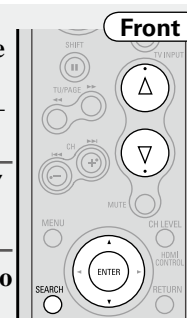

"TV Out" at the iPod's "Slideshow Settings" or "Video Settings" must be set to "On" in order to display the iPod's photo data or videos on the monitor. For details, see the iPod's operating instructions.



iPod is a trademark of Apple Inc., registered in the U.S. and other countries. The iPod may only be used to copy or play contents that are not copyrighted or contents for which copying or playback is legally permitted for your private use as an individual. Be sure to comply with applicable copyright legislation.

Listening to FM/AM Broadcasts

Basic Operation

1 Set to "MAIN/TV" and to "MAIN".

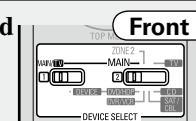

2 Press to select "TUNER".



3 Press to select “FM” or “AM”.

4 Tune in the desired broadcast station.

- ① **To tune in automatically (Auto Tuning)**
Press to light the “AUTO” indicator on the display, then use to select the station you want to hear.
- ② **To tune in manually (Manual Tuning)**
Press to turn off the display’s “AUTO” indicator, then use to select the station you want to hear.



- If the desired station cannot be tuned in with auto tuning, tune it manually.
- When tuning in stations manually, press and hold to change frequencies continuously.
- The time (default : 30 sec) for which the on-screen display are displayed can be set at “On-Screen Display” (☞ page 31).

Presetting Radio Stations (Preset Memory)

Your favorite broadcast stations can be preset so that you can tune them in easily. Up to 56 stations can be preset.

1 Tune in the broadcast station you want to preset.

2 Press .

3 Press to select the block (A to G) in which the station is to be preset.

4 Press to select the preset number (1 to 8).

5 Press again to complete the setting.



- To preset other stations, repeat steps 1 to 5.
- Stations can be preset automatically at menu “Auto Preset” (☞ page 36).

NOTE

Preset stations are erased by overwriting them.

Listening to Preset Stations

- 1** Press to select the memory block (A to G).
- 2** Press to select the desired preset channel (1 to 8).

Default settings

Auto tuner presets	
A1 ~ A8	87.5 / 89.1 / 98.1 / 107.9 / 90.1 / 90.1 / 90.1 / 90.1 MHz
B1 ~ B8	520 / 600 / 1000 / 1400 / 1500 / 1710 kHz, 90.1 / 90.1 MHz
C1 ~ C8	90.1 MHz
D1 ~ D8	90.1 MHz
E1 ~ E8	90.1 MHz
F1 ~ F8	90.1 MHz
G1 ~ G8	90.1 MHz

Listening to SIRIUS Satellite Radio Programs

About SIRIUS XM Radio

To listen to Satellite Radio, you’ll need to connect either a SIRIUS or XM Satellite Radio tuner (sold separately) to your satellite-ready receiver. Satellite Radio is available to residents of the US (except Alaska and Hawaii) and Canada.

Satellite Radio delivers a variety of commercial-free music from categories ranging from Pop, Rock, Country, R&B, Dance, Jazz, Classical and many more plus coverage of all the top professional and college sports including play by play games from select leagues and teams. Additional programming includes expert sports talk, uncensored entertainment, comedy, family programming, local traffic and weather and news from your most trusted sources.

Whether you purchase a SIRIUS or XM tuner, you’ll need to activate and subscribe to begin enjoying the service. Easy to follow installation and setup instructions are provided with the satellite tuners. Whichever service you choose, there are a variety of programming packages available, including the option of adding “The Best of SIRIUS” programming to your XM tuner or “The Best of XM” programming to your SIRIUS tuner, enabling you to enjoy the most popular programming among both services. The “Best of” packages are not available to SIRIUS or XM Canada subscribers at this time.

Family friendly packages are also available to restrict channels featuring content that may be inappropriate for children.

To subscribe to XM, U.S. customers should visit xmradio.com or call 1-800-XMRADIO (1-800-967-2346); Canadian customers should visit xmradio.ca or call XM Listener Care at 1-877-GETXMSR (1-877-438-9677).

To subscribe to SIRIUS, U.S. and Canadian customers can call 1-888-539-SIRI (1-888-539-7474) or visit sirius.com (US) or siriuscanada.ca (Canada).

SIRIUS XM Radio Legal

SIRIUS, XM and all related marks and logos are trademarks of Sirius XM Radio Inc. and its subsidiaries. All other marks and logos are the property of their respective owners. All rights reserved. SIRIUS and XM subscriptions sold separately. Taxes and a one-time activation fee may apply. XM tuners and home docks or SIRIUS tuners (each sold separately) are required to receive the SIRIUS or XM satellite radio service. All programming and fees subject to change. It is prohibited to copy, decompile, disassemble, reverse engineer, hack, manipulate or otherwise make available any technology or software incorporated in receivers compatible with the SIRIUS or XM Satellite Radio Systems.

Service not available in Alaska and Hawaii.

Basic Operation

- 1** Set to “MAIN/TV” and to “MAIN”.
- 2** Press to select “SIRIUS”.
- 3** Use to select the channel.
When the channel is tuned in, the name of the track and artist are displayed.

See overleaf

Getting Started

Connections

Settings

Playback

Multi-Zone

Remote Control

Information

Troubleshooting

Specifications



The channel switches continuously when  is pressed and held.



The song title, artist name, composer name, category and reception level can be checked by pressing  on the main unit.



The time (default : 30 sec) for which the on-screen display are displayed can be set at menu "On-Screen Display" (page 31). Press  to return to the original screen.

Checking the SIRIUS Signal Strength and Radio ID

1 Press  to select "SIRIUS".



2 Press  on the main unit until "SIGNAL" appears on the display.



The display will switch as shown below, depending on the reception conditions.

Display	Status
EXCELLENT	Signal strength is excellent
GOOD	Signal strength is good
WEAK	Signal strength is weak
NO SIGNAL	No signal

3 Adjust the position of the antenna until "SIGNAL: EXCELLENT" is shown on the display.

4 Press  on the main unit until the channel you want to check (example: "SR001") is displayed.

5 Press  and select channel 0 (SR000).

Channel No. and Sirius ID are alternately shown on the display.

SR000 SiriusID



***** ← Sirius ID



※ Write your own SIRIUS ID for storage use.

Sirius ID : _____



The strength of both the SIRIUS and terrestrial signals can be checked at menu "Antenna Aiming" (page 37).

Presetting Radio Channels (Preset Memory)

Your favorite broadcast channels can be preset so that you can tune them in easily. Up to 56 channels can be preset.

1 Tune in the broadcast channel you want to preset.

2 Press .

3 Press  to select the block (A to G) in which the channel is to be preset.

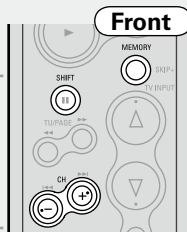

4 Press  to select the preset number (1 to 8).

5 Press  again to complete the setting.



To preset other channels, repeat steps 1 to 5.

NOTE

Preset channels are erased by overwriting them.



Listening to Preset Channels

1 Press  to select the memory block (A to G).

2 Press  to select the desired preset channel (1 to 8).



You can also operate via the main unit. In this case, perform the following operations.



- Press , then turn  on the main unit to select the preset radio channel.



Searching Categories

1 Press .

CAT : POPS ← Channel category

2 Use  to select the category, then use  to select the desired channel.

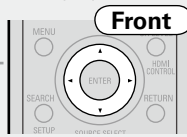

- "UPDATING" is displayed while the encoding code is being updated.
- "SIRIUS UPDATING" is displayed when updating SIRIUS tuner firmware.
- Refer to "Troubleshooting" – "SIRIUS Satellite Radio" regarding other messages (page 64).

Parental Lock

1 Tune to the channel you want to lock.

2 Press  for at least 3 seconds. "Code: []" is displayed.

3 Enter the 4-digit lock code using .

When you enter the correct code, the corresponding channel is locked.

4 Press .



- Channels under Parental Lock cannot be tuned in by performing Tuning Up/Down or by category search.
- Channels stored in preset memory can be tuned in by the preset channel select operation, even if Parental Lock is applied.
- When a channel to which Parental Lock is applied is being played, Parental Lock for that channel is cancelled by performing Step2.
- See "Edit Lock Code" (page 37) for the method of changing Parental Lock Code.
- You can also set "Parental Lock" from the menu (page 37).

Operations During Playback

Turning Off the Sound Temporarily (Muting)

Press .



- The sound is reduced to the level set at menu "Mute Level" (page 30).
- To cancel, press  again. Muting can also be canceled by adjusting the master volume.

Listening with Headphones

Plug the headphones into the PHONES jack on the main unit.

The sound from the speakers and pre-out connectors is automatically cut.

NOTE

- To prevent hearing loss, do not raise the volume level excessively when using headphones.
- Unplug headphones when performing the Audyssey Auto Setup procedure or other settings.

Switching the front speakers

Press .



NOTE

When you set to "Custom" with "Front Speaker Setup" (page 27), you cannot operate .

Selecting the Surround Mode

Select a surround mode to enjoy surround playback with your favorite sound field effects.

1 Playing sources according to the sources' audio signal format/number of channels (Standard Playback)

Operations

The selectable surround modes depend on the following:

- Format of the audio signals being input
- Number of channels of the audio signals being input
- The set amplifier assignment mode (page 25)

1 Playing the source (page 38).

2 Press to select the surround mode.

Multichannel sources

The surround modes that can be selected differ according to the input source.

2channel sources

When you select "DOLBY PLIIz"; set "Amp Assign" to "Front Height".



**DOLBY PLIIx,
DOLBY PLII
OR
DOLBY PLIIz** *

: The signals are decoded in DOLBY PLIIx, DOLBY PLII or DOLBY PLIIz, for playback.

DTS NEO:6

: The signals are decoded in DTS NEO:6 for playback.

*: DOLBY PLIIx can be selected when surround back speakers are being used.

3

This is the operation for playing 2-channel sources.

Select the mode for the source at "Mode" (page 44).

DOLBY PLIIx, DOLBY PLII

Cinema : This mode is suited for movie sources.

Music : This mode is suited for music sources.

Game : This mode is suited for games.

Pro Logic : This is the Pro Logic playback mode. This can be selected when playing with a DOLBY PLII decoder. When this mode is selected, "DOLBY PL" is displayed.



DTS NEO:6

Cinema : This mode is suited for movie sources.

Music : This mode is suited for music sources.

※ The modes that can be selected depend on the input source being played.



The "Cinema" and "Music" modes can also be set by pressing  or .

See overleaf

Displaying the currently playing surround mode

Surround playback of multichannel sources (Dolby Digital, DTS, etc.)

In the case of standard playback of multi channel sources, the AVR-1910 recognizes the format of the multi-channel audio input signal and automatically operates the appropriate decoder for surround sound.

Input signal	Display			
Dolby Digital	Dolby Digital (other than 2ch)/ Dolby Digital EX	DOLBY DIGITAL DOLBY DIGITAL EX DOLBY DIGITAL+PLIIx CINEMA DOLBY DIGITAL+PLIIx MUSIC DOLBY DIGITAL+PLIIz		
	Dolby Digital Plus (*1)	DOLBY DIGITAL++PLIIx C DOLBY DIGITAL++PLIIx M DOLBY DIGITAL++PLIIz		
	Dolby TrueHD (*1)	DOLBY TrueHD DOLBY HD+EX DOLBY HD+PLIIx CINEMA DOLBY HD+PLIIx MUSIC DOLBY HD+PLIIz		
DTS	DTS (5.1ch)/ DTS-ES Discrete 6.1 / DTS-ES Matrix 6.1 / DTS 96/24	DTS SURROUND DTS+PLIIx CINEMA DTS+PLIIx MUSIC DTS+PLIIz DTS+NEO:6 DTS ES MTRX6.1 (*2) DTS ES DSCRT6.1 (*3) DTS 96/24 (*4)		
		DTS-HD (*1)	DTS-HD HI RES DTS-HD MSTR DTS-HD+NEO:6 DTS-HD+PLIIx CINEMA DTS-HD+PLIIx MUSIC DTS-HD+PLIIz	
			PCM (multi ch)	MULTI CH IN MULTI IN+PLIIx CINEMA MULTI IN+PLIIx MUSIC MULTI IN+PLIIz MULTI CH IN 7.1

- *1 : When a signal is input, the HD AUDIO indicator lights.
- *2 : This is displayed when the input signal is "DTS-ES Matrix 6.1" and the AVR-1910's "AFDM" setting (page 45) is set to "ON".
- *3 : This is displayed when the input signal is "DTS-ES Discrete 6.1".
- *4 : This is displayed when the input signal is "DTS 96/24".

Playing in a DENON original surround mode

The desired mode according to the program source and viewing situation can be selected from among 7 DENON original surround modes.

1 Select the input source by pressing **SOURCE SELECT** and play the source (page 38).



2 Press **SIMU** to select the Surround mode.

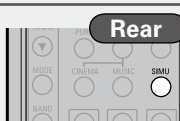

5CH/7CH STEREO : This mode is for enjoying stereo sound from all speakers.

ROCK ARENA : This mode is for enjoying the atmosphere of a live concert in an arena.

JAZZ CLUB : This mode is for enjoying the atmosphere of a live concert in a jazz club.

MONO MOVIE : This mode is for playing monaural movie sources with surround sound. *1

VIDEO GAME : This mode is suited for achieving surround sound with video games.

MATRIX : This mode lets you add a sense of expansion to stereo music sources.

VIRTUAL : This mode is for enjoying surround effects using only the front speakers or headphones.

*1 : When playing sources recorded in monaural in the MONO MOVIE mode, the sound will be off balance with a single channel (left or right), so input to both channels.



Depending on the program source being played, it may not be possible to achieve a satisfactory surround effect. In this case, try other modes to achieve a sound field suited to your tastes.

NOTE

When the input signal is DOLBY TrueHD, DOLBY DIGITAL Plus, DTS HD you cannot select DENON original surround mode.

Direct Playback

In this mode the signals bypass the tone adjustment circuitry for high quality sound. The sound is output to the same channels as the input signal.

1 Select the input source by pressing **SOURCE SELECT** and play the source (page 38).



2 Press **D/ST** to select the "DIRECT".



Displaying the currently playing surround mode

Input signal	Display
Analog signal / PCM (2ch) / Dolby Digital source / DTS source / Other 2-channel digital signals	DIRECT
PCM (multi ch)	MULTI CH DIRECT
	M DIRECT + PLIIx CINEMA
	M DIRECT + PLIIx MUSIC
	M DIRECT + PLIIz
	M DIRECT 7.1

Selecting the Surround Mode

④ Stereo Playback

This is the mode for playing in stereo. The tone can be adjusted. Sound is output from the front left and right speakers and subwoofer.

1 Select the input source by pressing **SOURCE SELECT** and play the source (page 38).

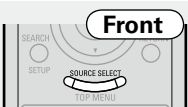

2 Press **D/ST** to select the "STEREO".



⑤ Playing the Pure Direct mode

This is the mode that recreates the original sound most faithfully, providing extremely high quality sound.

1 Select the input source by pressing **SOURCE SELECT** and play the source (page 38).



2 Press **PURE**.



- To cancel, press **PURE** again.
- The channel level and surround parameters in the PURE DIRECT mode are the same as in the DIRECT mode.

NOTE

When in the PURE DIRECT mode, the on-screen display is not displayed and the display on the main unit is turned off.



Adjusting the Sound Field Effects (Parameter)

The sound being played in the surround mode can be adjusted to your liking. The items (parameters) that can be adjusted depend on the signal being input and the currently set surround mode. For details on the adjustable parameters, see "Surround Modes and Parameters" (page 58).

NOTE

Some of the setting items cannot be set while playback is stopped. Set these items during playback.

Adjusting the sound field effects (Surround Parameter)

Default settings are underlined.

Setting items	Setting contents
<p>Mode</p> <p>Set the play mode for playing 2-channel sources in surround.</p>	<p><input type="checkbox"/> In the PLIIx, PLII or PLIIz mode</p> <p>Cinema : This is the mode for cinema source. Music : This is the mode for music source. Game : This is the mode for game source. ProLogic : Dolby Pro Logic playback mode (PLII mode only). (This is the mode for 4-channel playback (front L, front R, center, surround (MONO).))</p> <p><input type="checkbox"/> In the DTS NEO:6 mode</p> <p>Cinema : This is the mode for cinema source. Music : This is the mode for music source.</p> <p> • The "Music" mode is also effective for movie sources including a lot of stereo music. • The "Cinema" and "Music" modes can also be set by pressing CINEMA or MUSIC.</p>
<p>Cinema EQ</p> <p>Soften the treble range of movie sound tracks for better understanding.</p>	<p>OFF : "Cinema EQ" is not used. ON : "Cinema EQ" is used.</p>
<p>Dynamic Range Compression (D.Comp)</p> <p>Compress dynamic range (difference between loud and soft sounds).</p>	<p>Low/Mid/High : These set the compression level. OFF : Turn dynamic range compression off.</p> <p> The "D.Comp" indicator lights when playing DTS source that supports the "D.Comp" function.</p>
<p>Dynamic Range Control (DRC)</p> <p>Compress dynamic range</p>	<p>Auto : Dynamic range compression of Dolby TrueHD sources turns on and off automatically. Low/Mid/High : These set the compression level. OFF : Turn dynamic range compression off.</p>
<p>LFE</p> <p>Adjust the low-frequency effects level (LFE).</p>	<p>-10dB ~ 0dB</p> <p> For proper playback of the different program sources, we recommend setting to the values below.</p> <ul style="list-style-type: none"> Dolby Digital sources : "0dB" DTS movie sources : "0dB" DTS music sources : "-10dB"

Remote control operation buttons

MENU : Displaying the menu
○ : Cancel the menu

: Moves the cursor (Up/Down/Left/Right)



ENTER : Decision the setting

RETURN **○** : Return to previous menu

Adjusting the Sound Field Effect (Parameter)



Setting items	Setting contents
Center Image Assign center channel signal to front left and right channels for wider sound.	0.0 ~ 1.0 (0.3)
Panorama Assign front L/R signal also to surround channels, for wider sound.	ON : Set. OFF : Do not set.
Dimension Shift sound image center to front or rear, to adjust playback balance.	0 ~ 6 (3)
Center Width Assign center channel signal to front left and right channels for wider sound.	0 ~ 7 (3)
Delay Time Adjust delay time to control sound stage size.	0ms ~ 300ms (30ms)
Effect Level Adjust the strength of the surround effect.	1 ~ 15 (10) Set to a lower level if the positioning and sense of phase of the surround signals seems unnatural.
Room Size Determine size of acoustic environment. NOTE "Room Size" does not indicate the size of the room in which sources are played.	Small : Simulate acoustics of a small room. Medium small : Simulate acoustics of a medium-small room. Medium : Simulate acoustics of a medium room. Medium large : Simulate acoustics of a medium-large room. Large : Simulate acoustics of a large room.

Setting items	Setting contents
AFDM (Auto Flag Detect Mode) Detects the source's surround back channel signal and sets the optimum surround mode automatically.	ON : Set. OFF : Do not set.
Surround Back Sets the method of generating of the surround back channel.	<input type="checkbox"/> For 2-channel sources ON : The surround back channel is used. OFF : No signal is played from the surround back channels. <input type="checkbox"/> For multi channel sources Set this to set the method of generating of the surround back channel for sources that do not include surround back signals and when you do not want to play the surround back signals included in the source. Check the audio signals of the source being played before making this setting. OFF : No signal is played from the surround back channels. MTRX ON : Generate and play the surround back signals from the surround channel signals. PLIIx CINEMA*1 : Generate and play the surround back signals by decoding the signals in the "Dolby Pro Logic IIx Cinema" mode. PLIIx MUSIC*2 : Generate and play the surround back signals by decoding the signals in the "Dolby Pro Logic IIx Music" mode. ES MTRX : Generate and play the surround back signals from the surround channel signals of the DTS source. ES DSCRT*3 : Play the surround back signals included in the 6.1-channel DTS source. DSCRT ON*3 : Play the surround back signals included in the 7.1-channel source. *1 : This can be selected when "S.Back" in the "Speaker Config." settings (page 26) is set to "2sp". *2 : This can be selected when "S.Back" in the "Speaker Config." settings (page 26) is set to "2sp" or "1sp". *3 : When "AFDM" is set to "ON", the surround back channel is played with the AFDM function. When selected while "AFDM" is set to "OFF", the source's surround back signals are played. This can also be set by pressing .
	NOTE This is valid when the "Amp Assign" setting (page 25) is set to "7.1-channel surround back" or "6.1-channel surround back", and when the "S.Back" setting (page 26) is set to "Large" or "Small".

Setting items	Setting contents
Front Height Set whether or not to use the front height channel.	ON : Use the front height channel. OFF : Do not use the front height channel. This can also be set by pressing  .
Subwoofer ATT Attenuate subwoofer level when using EXT. IN mode.	ON : The input from the subwoofer channel is attenuated. OFF : The input from the subwoofer channel is not attenuated. Usually use in this mode.  Set this to "ON" if the subwoofer channel level seems too high when playing audio signal.
Subwoofer Turn subwoofer output on and off.	ON : The subwoofer is used. OFF : The subwoofer is not used.
Default Restores all the surround parameter settings to their defaults.	Yes : Reset to the defaults. No : Do not reset to the defaults.

Adjusting the tone (Tone Control)

Default settings are underlined.

Setting items	Setting contents
Tone Control Sets the tone control function ON and OFF. This can be set when "Dynamic EQ" ( page 47) is set to "OFF".	ON : Allow tone adjustment (treble, bass). OFF : Playback without tone adjustment.  The tone cannot be adjusted when in the DIRECT mode.
Bass Adjusts the low frequencies. This can be set when "Tone Control" is set to "ON".	-6dB ~ +6dB (0dB)
Treble Adjusts the high frequencies. This can be set when "Tone Control" is set to "ON".	-6dB ~ +6dB (0dB)

Making the MultEQ, Dynamic EQ and Dynamic Volume settings (Audyssey Settings)

Default settings are underlined.

• When the "Audyssey Auto Setup" ( page 20) procedure is performed, the "MultEQ", "Dynamic EQ" and "Dynamic Volume" functions are enabled.

• Operating conditions for each function



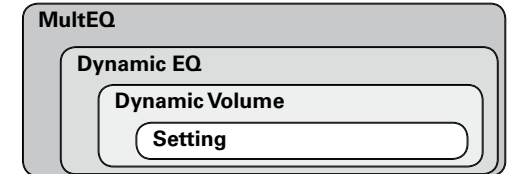

- **Dynamic EQ** :
When "MultEQ" is set to "ON"
- **Dynamic Volume** :
When "Dynamic EQ" is set to "ON"
- **Setting** :
When "Dynamic Volume" is set to "ON"





NOTE

If the speaker settings are changed after the "Audyssey Auto Setup" procedure is performed, "MultEQ", "Dynamic EQ" and "Dynamic Volume" functions cannot be selected and "Run Audyssey" is displayed.

If this happens, either perform the "Audyssey Auto Setup" procedure again, or perform the "Restore" operation ( page 24) to restore the settings to as they were after the "Audyssey Auto Setup" procedure was performed.

Setting items	Setting contents
MultEQ Corrects the frequency response of the different speakers.	Audyssey : Optimize frequency response of all speakers. Audyssey Byp.L/R : Optimize frequency response of speakers except front L and R speakers. Audyssey Flat : Optimize frequency response of all speakers to flat response. Manual : Apply frequency response set with "Manual EQ" ( page 47). OFF : The "MultEQ" equalizer cannot be used.
NOTE • "MultEQ" and "Manual EQ" settings for which "Not Used" has been set at "EQ Customize" ( page 29) cannot be selected. • When using headphones, "MultEQ" is set to "OFF".	 • When "Audyssey", "Audyssey Byp. L/R" or "Audyssey Flat" is selected, "AUDYSSEY MULTEQ" lights. • After running Audyssey Auto Setup, if the Speaker Configuration, Distance, Channel Level, and Crossover Frequency have changed without increasing the number of speakers measured, only "AUDYSSEY MULTEQ" lights. • This can also be set by pressing  .

Remote control operation buttons

 : Displaying the menu
 : Cancel the menu

 : Moves the cursor (Up/Down/Left/Right)

 : Decision the setting

 : Return to previous menu

Setting items	Setting contents
<p>Dynamic EQ Audyssey Dynamic EQ solves the problem of deteriorating sound quality as volume is decreased by taking into account human perception and room acoustics.</p> <p>This can be set when the "MultEQ" (page 46) is set to anything other than "OFF".</p>	<p>ON : Use Dynamic EQ function. OFF : Do not use Dynamic EQ function.</p> <ul style="list-style-type: none"> When set to "ON", "AUDYSSEY MULTEQ DYN EQ" is displayed. When "MultEQ" is set to "OFF", "Dynamic EQ" is automatically set to "OFF" This can also be set by pressing <p>Dynamic EQ : ON/Volume : OFF → Dynamic EQ / Volume : OFF</p> <p>NOTE "Tone Control" is set to "OFF" when "Dynamic EQ" is set to "ON".</p> <p>Reference Level Offset : Audyssey Dynamic EQ takes the standard film mixing level of 85 dB SPL during -20 dB FS input as its reference level. However, since standardization is lacking outside the film industry, the reference level of media contents may not be appropriate. In order to view such contents, Reference Level Offset of Dynamic EQ has available offsets of 5 dB, 10 dB and 15 dB.</p> <ul style="list-style-type: none"> 0dB : Suitable for viewing movies. 5dB : Suitable for listening to classical music and other content mixed at a high level. 10dB : Suitable for listening to jazz and other audio sources with a wide dynamic range. Also suitable for viewing TV. 15dB : Suitable for listening to pop, rock music and other content with an extremely wide dynamic range. <p> Setting is enabled when "Dynamic EQ" is "ON".</p>
<p>Dynamic Volume Audyssey Dynamic Volume solves the problem of large variations in volume level between television programs, commercials, and between the soft and loud passages of movies.</p> <p>This can be set when "Dynamic EQ" (page 47) is set to "ON".</p>	<p>ON : Use Dynamic Volume. The Dynamic Volume effect will be at the level of the "Setting" (page 47) OFF : Do not use Dynamic Volume.</p> <ul style="list-style-type: none"> When set to "ON", "AUDYSSEY MULTEQ DYN VOL" is displayed. When "MultEQ" is set to "OFF", "Dynamic Volume" is automatically set to "OFF". This can also be set by pressing <p>Dynamic EQ / Volume : ON → Dynamic EQ : ON / Volume : OFF</p>

Setting items	Setting contents
<p>Setting Set Dynamic Volume effect.</p> <p>This can be set when "Dynamic EQ" (page 47) is set to "ON".</p>	<p>Day : Low setting provides the least adjustments to the loudest and softest of sounds. Evening : Middle setting prevents loud and soft sounds from being much louder and softer respectively than average sounds. Midnight : High setting affects volume the most, causing all sounds to be of equal loudness.</p>

Adjust tonal quality for each speaker using graphic equalizer (Manual EQ)

Default settings are underlined.

Setting items	Setting contents
<p>Adjust CH Adjust the tonal quality of the individual speakers.</p>	<p>1. Select speaker adjustment method. All CH : Adjust tonal quality for all speakers together. L/R CH : Adjust tonal quality for each L/R speaker pair. Each CH : Adjust tonal quality for each speaker separately.</p> <p>2. Select the frequency band to be adjusted. 63Hz / 125Hz / 250Hz / 500Hz / 1kHz / 2kHz / 4kHz / 8kHz / 16kHz ※ When "L/R CH" or "Each CH" is selected, select the speaker to be adjusted.</p> <p>3. Adjust the level. -20.0dB ~ +6.0dB (0dB)</p>
<p>Base Curve Copy Copy the MultEQ "Audyssey Flat" correction curve.</p>	<p>Yes : Copy. No : Do not copy.</p> <p> "Base Curve Copy" is displayed after the Audyssey Auto Setup procedure has been performed.</p>
<p>Default Reset the "Manual EQ" settings to their defaults.</p>	<p>Yes : Reset to the defaults. No : Do not reset to the defaults.</p>

Adjusting the Sound Field Effect (Parameter)

Restoring compressed audio to nearly pre-compressed conditions for playback (RESTORER)

Default settings are underlined.

- Such compressed audio formats as MP3, WMA (Windows Media Audio) and MPEG-4 AAC reduce the amount of data by eliminating signal components that are hard for the human ear to hear. The RESTORER function generates the signals eliminated upon compression, restoring the sound to conditions near those of the original sound before compression. It also corrects the sense of volume of the bass to obtain richer sound with compressed audio signals.
- This can be set with analog signals or when a PCM signal (fs = 44.1/48 kHz) is input.

Setting contents

OFF : Do not use RESTORER.

Mode1 (RESTORER 64) : Optimized mode for compressed sources with very weak highs.

Mode2 (RESTORER 96) : Apply suitable bass and treble boost for all compressed sources.

Mode3 (RESTORER HQ) : Optimized mode for compressed sources with normal highs.

- The default setting for "iPod" is "Mode3". All others are set to "OFF".
- When set to something other than "OFF", "**RSTR**" is displayed.
- This can also be set by pressing  during playback.

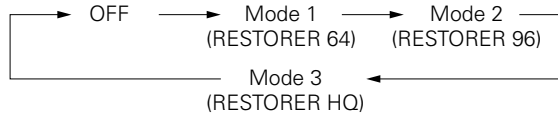

Adjusting the audio delay time while watching the picture (Audio Delay)

Default settings are underlined.

Setting contents

0ms ~ 200ms

- If you wish to adjust the "Audio Delay" while playing HDMI or component video signals, press Δ to set "OSD" to "OFF". This way the audio delay can be adjusted while watching the picture. (Press the Δ again. The display switches to the display of the menu screen only.)
- This cannot be adjusted when playing in the EXT. IN, DIRECT or STEREO mode (with "Front Speaker" set to "Large", "Tone Control" to "OFF" and "MultEQ" and "RESTORER" to "OFF").
- When the Auto Lipsync Correction function is operating, you can set within the range 0 ~ 100 ms.
- Store "Audio Delay" for each input source.



Checking the Status (Information)

Setting items	Setting contents
Status Shows information about current settings.	Select Source / Surround Mode / Input Mode / Decode Mode / HDMI / Digital / Component / iPod Dock / Video Select / Source Level / i/p Scaler / Resolution / Progressive Mode / Aspect  You can also display current status on the main unit's display each time you press STATUS on the main unit. ZONE2 • POWER/ Select Source/ Master Volume
Audio Input Signal Shows information about audio input signals.	Surround Mode : The currently set surround mode is displayed. Signal : The input signal type is displayed. fs : The input signal's sampling frequency is displayed. Format : The number of channels in the input signal (front, surround, LFE) is displayed. Offset : The dialogue normalization correction value is displayed. Flag : This is displayed when inputting signals including a surround back channel. "MATRIX" is displayed with Dolby Digital EX and DTS-ES Matrix signals, "DISCRETE" with DTS-ES Discrete signals.
HDMI Information Shows information about HDMI input signals and monitor.	HDMI Signal Information • Resolution / Color Space / Pixel Depth HDMI Monitor Information • Interface / Support Resolution
Auto Surround Mode Shows information about auto surround mode settings.	Analog/PCM / Digital 2ch / Digital 5.1ch / Multi CH
Quick Select Shows information about quick select settings.	Quick Select 1 / Quick Select 2 / Quick Select 3 • Name / Input Source / Video Select / Volume Level / MultEQ / Dynamic EQ / Dynamic Vol / Front SP / Analog/PCM / Digital 2ch / Digital 5.1ch / Multi CH ZONE2 Quick Select Quick Select 1 Source / Quick Select 1 Volume / Quick Select 1 Name Quick Select 2 Source / Quick Select 2 Volume / Quick Select 2 Name Quick Select 3 Source / Quick Select 3 Volume / Quick Select 3 Name
Preset Channel Shows information about preset channels.	A 1 ~ G 8 • TUNER / SIRIUS

Convenient functions

HDMI Control Function

When you make an HDMI connection with a TV or player compatible with AVR-1910 and HDMI control functions, you can perform the following operations by setting the HDMI control function of each device.

- AVR-1910 power off can be linked to the TV power off step**
 - * When you set "Output audio from amp" in the TV audio output setup operation, you can switch the amp power on.
- You can switch audio output devices with a TV operation**
- You can adjust AVR-1910 volume in the TV volume adjustment operation**
- You can switch AVR-1910 input source through linkage to TV input switching**
- When playing the player, the AVR-1910 input function switches to the function of that player**



- To play the TV's sound on the AVR-1910, make optical digital connections (page 13 "Connecting the TV").
- To use this function, set "HDMI Control" (page 28) to "ON".

NOTE

- When you power off AVR-1910, the HDMI control function does not operate.
- Some functions may not operate depending on the connected TV or player. Check the owner's manual of each device for details beforehand.
- When "HDMI Control" is set to "ON", it is not possible to assign an HDMI terminal to "TV" at "HDMI" (page 28).
- When "HDMI Control" (page 28) is set to "ON", power is supplied constantly to the AC outlet (UNSWITCHED).

1 Turn the power on for all the equipment connected by HDMI cable.

2 Set the HDMI control function for all equipment connected by HDMI cable.

Set "HDMI Control" (page 28) to "ON".

※ Please refer to the owner's manual as regards setting of connected devices.

※ Carry out Steps 1 and 2 should any of the equipment be unplugged.

3 Switch the television input to the HDMI connected to the AVR-1910.

4 Switch the AVR-1910 input to the HDMI input source and check if the picture from the player is ok.

5 When you turn the TV's power to standby, check that the power of the AVR-1910 and player also goes on standby.



If the HDMI control function does not operate properly, check the following points.

- Is the TV or player compatible with the HDMI control function?
- Is the AVR-1910 properly set?
 - Is "HDMI Control" (page 28) set to "ON"?
 - Is "Power Off Control" (page 28) set to "ON"?
- Are the HDMI control function settings of all equipment correct?

NOTE

Should any of the operations below be performed, the interlocking function may be reset, in which case, repeat step's 1 and 2.

- Menu "HDMI" (page 28) setting has changed.
- There is a change to the connection between the equipment and the HDMI, or an increase in equipment.

Setting the power to standby after a certain amount of time (Sleep Timer Function)

This function allows you to automatically set the power to standby after the set amount of time has passed.

When the sleep timer turns the power off in the MAIN ZONE, the power also turns off in the ZONE2.

Press  and display the time you want to set.

The "SLEEP" indicator on the display lights.

- The time switches as shown below each time  is pressed.

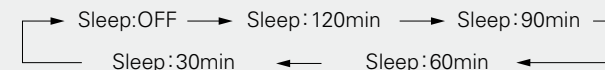

- The time display turns off after about 5 seconds, and the setting is activated.
- Once the set time has passed, the power is automatically set to standby.

To cancel the sleep timer

Press  to set "OFF".

- The "SLEEP" indicator on the display turns off.



Adjust the volume of the different speakers

You can adjust the channel level either according to the playback sources or to suit your taste, as described below.

Adjust the volume of the different speakers

1 Press **CH LEVEL**.

Channel Volume	
FL	0.0dB
C	0.0dB
FR	0.0dB
SW	0.0dB
SR	0.0dB
SBR	0.0dB
SBL	0.0dB
SL	0.0dB

Fader
FRONT ◀ : REAR

[◀▶] : CH Sel.

2 Press **△ ▽** to select the speaker.
The speaker that can be set switches each time one of the buttons is pressed.

3 Press **◀ ▶** to adjust the volume.

※ In the case of a subwoofer, reducing the volume when it is at “-12 dB” will change the setting to “OFF” (none).



If headphones are plugged in, the headphones settings screen appears.

Adjusting the volume of groups of speakers (Fader Function)

This function lets you adjust (fade) the sound from all the front (Front speaker/center speaker/Front Height speaker) or rear (Surround speaker/Surround Back speaker) speakers at once.

1 Use **CH LEVEL** or **▽** to select “Fader”, then select the item to be adjusting using **◀** or **▶**.

2 Press **◀ ▶** to adjust the volume of the speakers.



- The fader function does not affect the subwoofer.
- The fader can be adjusted until the volume of the speaker adjusted to the lowest value is -12 dB.

Saving frequently used settings (Quick Select Function)

This function allows you to save all the settings shown in step 1. When frequently used settings are saved, they can easily be set again the next time you want to use them. This function also allows you to always enjoy the same playback environment.

- Three sets of settings can be saved.

MAIN ZONE settings

Saving the settings

1 Set the items below to the settings you want to save.

- ① Input source (page 38)
- ② Input Mode (page 34)
- ③ Surround Mode (page 42)
- ④ Audyssey Settings (MultEQ, Dynamic EQ, Dynamic Volume) (page 46)
- ⑤ Front Speaker Setup (page 27)
- ⑥ Volume setting (page 38)

2 Press and hold the desired **QUICK SELECT** until “Memory” appears on the display.
The current settings will be memorized.

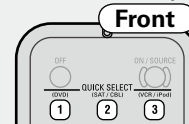

[Quick Select Defaults]

	Input Source	Volume
Quick Select 1	DVD	-40 dB
Quick Select 2	SAT/CBL	-40 dB
Quick Select 3	VCR/iPod	-40 dB

Calling the settings out

Press the **QUICK SELECT** at which the settings you want to call out are saved.

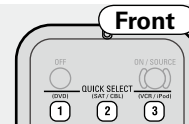

NOTE

Input sources stored with the quick select function cannot be selected if they have been deleted at menu “Source Delete” (page 30). In this case, store them again.

Naming Quick Select settings

“Quick Select Name” (page 31).

ZONE2 settings

It is also possible to save three settings for ZONE2.

Saving the settings

1 Set the remote control unit’s device selector switches as shown on right.

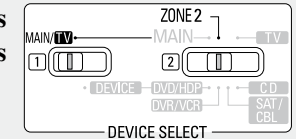

2 Perform steps 1 and 2 under “MAIN ZONE settings”.

Various memory functions

Personal Memory Plus Function

This function sets the settings (input mode, surround mode, MultEQ, Dynamic EQ, Dynamic Volume, audio delay etc.) last selected for the individual input sources.

Last Function Memory

This stores the settings as they were directly before the standby mode was set.

When the power is turned back on, the settings are restored to as they were directly before the standby mode was set.

Backup Memory

The various settings are backed up for about 1 week, even if the power is turned off or the power cord is disconnected.

Playing 2-Channel Sound in ZONE2 (multizone function)

2-channel sound can be played in rooms other than the MAIN ZONE where multichannel sound is played.

There are two methods to do this, as described below. Choose one of the methods.

- ① ZONE2 playback by speaker output
- ② ZONE2 playback by audio output (PRE OUT) (using an external amplifier)

① ZONE2 playback by speaker output

With the Amp Assign function, Zone 2 audio signals are output from the AVR-1910's SURR BACK/AMP ASSIGN terminals.

Preparations

Connecting and setting the speakers

Connecting the speakers

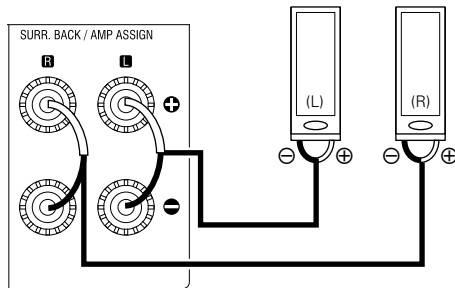

Necessary settings

- Set the AMP ASSIGN mode to "ZONE2": "AMP Assign" (☞ page 25)
- Perform the settings at "ZONE2 Setup": "Making the ZONE2 settings" (☞ page 30)

② ZONE2 playback by audio output

The audio signals connected to the AVR-1910's ZONE2 output terminals (ZONE2 OUT) are output to the ZONE2's amplifier and played with that amplifier.

Connection (ZONE2)

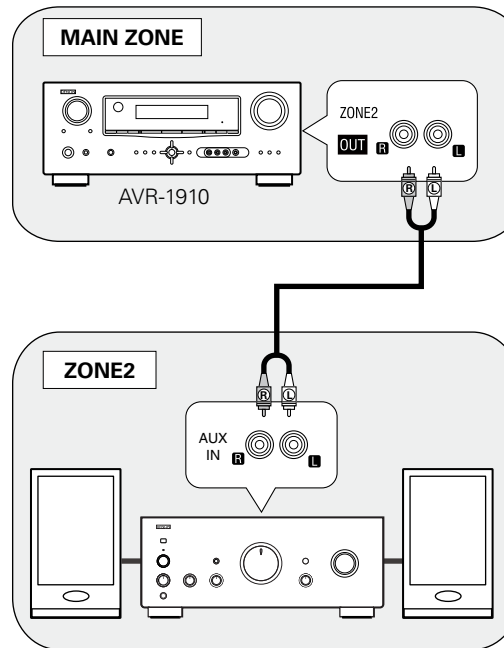

- Adjust the volume on the connected amplifier.
- Also be sure to read the operating instructions of the connected devices.

NOTE

- We recommend using high quality pin-plug cables for audio connections in order to prevent noise.
- It is not possible to play the digital audio signals input from the HDMI, COAXIAL or OPTICAL terminals in ZONE2. Play using analog connections (in stereo).

Playback

The operation is the same for "① ZONE2 playback by speaker output" and "② ZONE2 playback by audio output".

- 1 Set the remote control unit's "device selector switches" as shown on right.

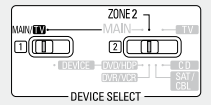

- 2 Turn on the AVR-1910's power. (☞ page 17 "Turning the Power On")



- 3 Press  to turn on the ZONE2 power. When the power turns on, the "Z2" indicator lights on the display.

※ The power can be turned on by pressing the one of  while in the standby mode.

- 4 Use the input source selector to choose the input source. The selected input source is shown on the display.

NOTE

When "SOURCE" is selected for the input source, the sound being played in the MAIN ZONE is played. No sound is output if a digital audio input source is being played in the MAIN ZONE.

Adjusting the volume (for "① ZONE2 playback by speaker output")

Use  to adjust the volume.

[Variable range] --- -80dB(1) ~ -40dB(41) ~ +18dB(99)

※ The volume can be adjusted up to the level set at "Vol. Limit" (☞ page 30).

※ The volume display is the display set at "Volume Display" (☞ page 30).



For "② ZONE2 playback by audio output", adjust the volume on the connected amplifier.

Operating the Connected Devices by Remote Control Unit

Registering Preset Codes

DENON and other makes of components can be operated by setting the preset memory.

1 Switch to **MAIN/TV**.

MAIN/TV : To register a TV

DEVICE : To operate a Blu-ray disc player, DVD player, Digital video recorder, video deck, satellite receiver, cable TV or CD player

2 Set to the component to be registered.

TV : TV

DVD/HDP : DVD player or Blu-ray disc player

DVR/VCR : Digital video recorder or video deck

SAT/CBL : Satellite receiver or cable TV

CD : CD player

3 Press and at the same time.

The indicator starts flashing.

4 Press ~ and input the 3-digit number of the brand of the component to be preset. The numbers are shown in the Preset Code Table (👉 End of this manual).



5 To store the codes of another component in the memory, repeat steps 1 to 4.



- Some manufacturers use more than one type of remote control code. Refer to the included list of preset codes to change the number and verify correct operation.
- VDP (Video Disc Player) can be preset when  is set to "DVD/HDP."
- The preset memory can be set for one component only among the following: DVD/HDP, DVR/VCR and SAT/CABLE.

Operating Registered Devices

1 Switch to **MAIN/TV**.

MAIN/TV : To operate the TV

DEVICE : To operate a Blu-ray disc player, DVD player, Digital video recorder, video deck, satellite receiver, cable TV or CD player

2 Set to the component you want to operate.

TV : TV

DVD/HDP : DVD player or Blu-ray disc player

DVR/VCR : DVD recorder or video deck

SAT/CBL : Satellite receiver or cable TV

CD : CD player

3 Operate the component.





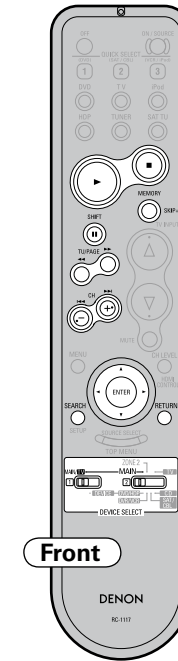

※ For details, refer to the component's operating instructions.

NOTE

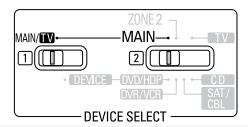
Depending on the model and year of manufacture, this function cannot be used for some models, even if they are of makes listed in the list of preset codes.

iPod

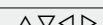

Front		
DEVICE SELECT		
	Play / Pause	
	Stop	
MEMORY	MEMORY * 1	
TU/PAGE	Page up/down * 1	
	Auto search (cue)	
	Cursor	
ENTER	Enter	
	Pause	
SEARCH	Press and hold	Once
	Browse/Remote mode switching	Page search mode switching * 2
RETURN	Return	

* 1 : This operation is possible when using a DENON ASD-3N or ASD-3W Control Dock for iPod.

* 2 : This operation is possible when using a DENON ASD-1R or ASD-11R Control Dock for iPod.

TV

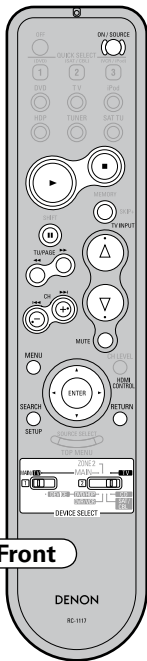

Front	
DEVICE SELECT	
ON/SOURCE	Power on / Standby
	Play *
	Pause *
	Stop *
	Manual search * (fast-reverse / fast-forward)
CH + -	Channel *
TV INPUT	Switching the input
VOLUME ▲▼	▲ : TV Volume (+) ▼ : TV Volume (-)
MUTE	TV MUTE
MENU	Calling out the menus
	Cursor operation
ENTER	Enter setting
SETUP	Setup
RETURN	Return
Rear	
1 ~ 12	Channels
Default setting (Preset code)	HITACHI (014)
Special Remarks	①

* :When the punch through function (page 54) is set, this functions as the button for the device for which punch through is set.



Blu-ray Disc / DVD Player

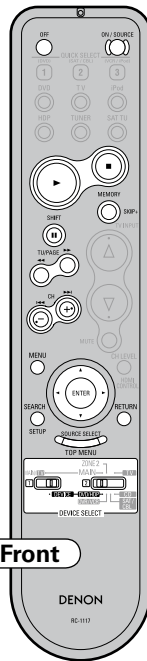

Front		
DEVICE SELECT		
POWER OFF	Power off	
ON/SOURCE	Power on or Power on / Standby	
	Play	
	Stop	
SHIFT, II	Pause	
SKIP +	BD Player	DVD Player
	-	Disc skip
	Manual search (fast-reverse / fast-forward)	
	Auto search (cue)	
MENU	Calling out the menus	
	Cursor operation	
ENTER	Enter setting	
SETUP	Setup	
RETURN	Return	
SOURCE SELECT / TOP MENU	Calling out the top menus	
Rear		
0 ~ 9, +10	Number input / Track selection	
Default setting (Preset code)	BD Player	DVD Player
	DENON (121)	DENON (111) *
Special Remarks	①, ②	

* : The initial setting of Preset code is 111 (DVD Player).

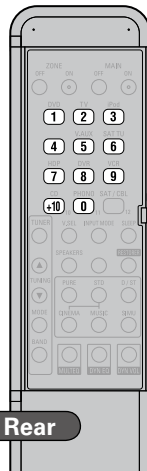

Digital Video Recorder / Video Deck



Front	
DEVICE SELECT	
ON/SOURCE	Power on / Standby
	Play
	Stop
SHIFT, II	Pause
	Manual search (fast-reverse / fast-forward)
CH + -	Switch channels (+, -)
MENU	Calling out the menus
	Cursor operation
ENTER	Enter setting
SETUP	Setup
RETURN	Return
Rear	
0 ~ 9, +10	Channels
Default setting (Preset code)	HITACHI (008)
Special Remarks	①, ②

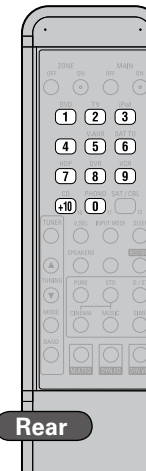

[Special Remarks]

- ① Only one device can be set in the preset memory for each mode.
When a new preset code is registered, the existing code is automatically erased.
- ② For some brands, the DVD remote control buttons may have different function names.
Check beforehand.

Satellite receiver/Cable TV

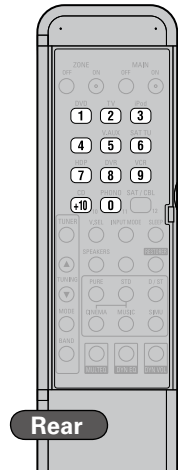
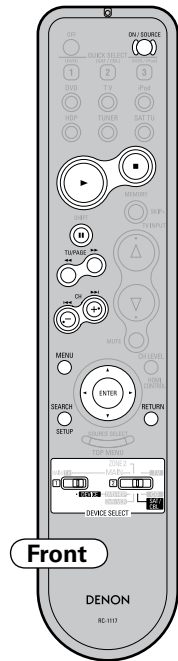

Front		
DEVICE SELECT		
ON/SOURCE	Power on / Standby	
	Play *	
	Pause *	
	Stop *	
	Manual search * (fast-reverse / fast-forward)	
CH + -	Channel *	
	Cursor operation	
ENTER	Enter setting	
MENU	Calling out the menus	
SETUP	Setup	
RETURN	Return	
Rear		
0 ~ 9, +10	Channels	
Default setting (Preset code)	Satellite Receiver	
	Cable TV	ABC (009)
Special Remarks	①	

* :When the punch through function (page 54) is set, this functions as the button for the device for which punch through is set.

[Special Remarks]

- ① Only one device can be set in the preset memory for each mode.
When a new preset code is registered, the existing code is automatically erased.
- ② For some brands, the DVD remote control buttons may have different function names. Check beforehand.

CD Player

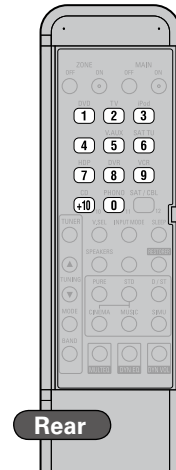
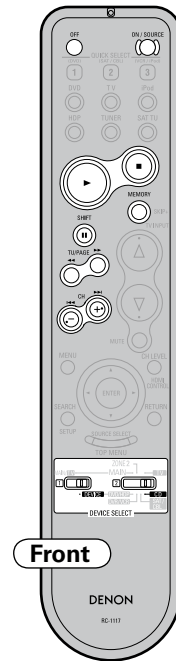

Front	
DEVICE SELECT	
POWER OFF	Power off
ON/SOURCE	Power on or Power on / Standby
	Play
	Stop
SHIFT, II	Pause
SKIP +	Disc skip +
	Manual search (fast-reverse / fast-forward)
	Auto search (cue)
Rear	
0 ~ 9, +10	Number input / Track selection
Default setting (Preset code)	DENON (111)
Special Remarks	①

Assigning buttons that are Not Used to Operate Other Devices (Punch Through Function)

The Blu-ray disc Player/DVD player, Digital Video recorder, video deck, or CD player can be operated as described below even when is set to the "SAT/CBL" or "TV" position.

- Play
- Stop
- Pause
- fast-forward
- fast-reverse
- Auto Search

1 Switch DEVICE SELECT.

MAIN/TV : Assigning TV buttons to operate other devices

DEVICE : Assigning satellite receiver or cable TV buttons to operate other devices

2 Switch DEVICE SELECT.

TV : Assigning TV buttons to operate other devices

SAT/CBL : Assigning satellite receiver or cable TV buttons to operate other devices

3 Press and at the same time. The indicator starts flashing.

4 Refer to the table below and input the number corresponding to the device to be assigned.

Device to be assigned	Numbers
iPod, Tuner	①
CD Player	②
Blu-ray Disc Player / DVD Player	③
DVD Recorder, Video Deck	④
No setting	①



This is set to "No setting" upon purchase.

Other Information

Surround

The AVR-1910 is equipped with a digital signal processing circuit that lets you play program sources in the surround mode to achieve the same sense of presence as in a movie theater.

Dolby Surround

Dolby Digital

Dolby Digital is a multichannel digital signal format developed by Dolby Laboratories.

A total of 5.1-channels are played: 3 front channels ("FL", "FR" and "C"), 2 surround channels ("SL" and "SR") and the "LFE" channel for low frequencies.

Because of this, there is no crosstalk between channels and a realistic sound field with a "three-dimensional" feeling (sense of distance, movement and positioning) is achieved.

A real, overpowering sense of presence is achieved when playing movie sources in AV rooms as well.

Dolby Digital Plus

Dolby Digital Plus is an improved Dolby Digital signal format that is compatible with up to 7.1-channels of discrete digital sound and also improves sound quality thanks to extra data bit rate performance. It is upwardly compatible with conventional Dolby Digital, so it offers greater flexibility in response to the source signal and the conditions of the playback equipment.

Dolby TrueHD

Dolby TrueHD is a high definition audio technology developed by Dolby Laboratories, using lossless coding technology to faithfully reproduce the sound of the studio master.

This format is compatible with a maximum sampling frequency of 96 kHz and up to 7.1-channels, so it is used for applications particularly prioritizing sound quality.

Dolby Pro Logic II

Dolby Pro Logic II is a matrix decoding technology developed by Dolby Laboratories.

Regular music such as that on CDs is encoded into 5-channels to achieve an excellent surround effect.

The surround channel signals are converted into stereo and full band signals (with a frequency response of 20 Hz to 20 kHz or greater) to create a "three-dimensional" sound image offering a rich sense of presence for all stereo sources.

Dolby Pro Logic IIx

Dolby Pro Logic IIx is a further improved version of the Dolby Pro Logic II matrix decoding technology.

Audio signals recorded in 2-channels are decoded to achieve a natural sound with up to 7.1-channels.

There are 3 modes: "Music" suited for playing music, "Cinema" suited for playing movies, and "Game" which is optimized for playing games.

Dolby Digital EX

Dolby Digital EX is a 6.1-channel surround format proposed by Dolby Laboratories that allows users to enjoy in their homes the "DOLBY DIGITAL SURROUND EX" audio format jointly developed by Dolby Laboratories and Lucas Films.

The 6.1 channels of sound, including surround back channels, provide improved sound positioning and expression of space.

Dolby Pro Logic IIz

Dolby Pro Logic IIz introduces a new dimension to Home Entertainment through the addition of a pair of front height channels. Compatible with stereo, 5.1 and 7.1 content, Dolby Pro Logic IIz provides enhanced spaciousness, depth and dimension to movies, concert video and videogame playback while maintaining the full integrity of the source mix.

Dolby Pro Logic IIz identifies and decodes spatial cues that occur naturally in all content, directing this information to the front height channels, complementing the performance of left and right surround sound speakers. Content that is encoded with Dolby Pro Logic IIz height channel information can be even more revealing, with perceptually discrete height channel information bringing an exciting new dimension to home entertainment. Dolby Pro Logic IIz, with front height channels is also an ideal alternative for households that cannot support the placement of back surround speakers of a typical 7.1 channel system but may have bookshelf space available to support the addition of height speakers.

Manufactured under license from Dolby Laboratories. "Dolby", "Pro Logic" and the double-D symbol are trademarks of Dolby Laboratories.

DTS Surround

DTS Digital Surround

DTS Digital Surround is the standard digital surround format of DTS, Inc., compatible with a sampling frequency of 44.1 or 48 kHz and up to 5.1-channels of digital discrete surround sound.

DTS-HD High Resolution Audio

DTS-HD High Resolution Audio is an improved version of the conventional DTS, DTS-ES and DTS 96/24 signals formats, compatible with sampling frequencies of 96 or 48 kHz and up to 7.1-channels of discrete digital sound. High data bit rate performance provides high quality sound. This format is fully compatible with conventional products, including conventional DTS digital surround 5.1-channel data.

DTS-HD Master Audio

DTS-HD Master Audio is DTS, Inc's lossless audio format compatible with up to 96 kHz/7.1-channels. The lossless audio coding technology faithfully reproduces the sound of the studio master. It is fully compatible with conventional products, including conventional DTS digital surround 5.1-channel data.

DTS-ES™ Discrete 6.1

DTS-ES™ Discrete 6.1 is a 6.1-channel discrete digital audio format adding a surround back (SB) channel to the DTS digital surround sound. Decoding of conventional 5.1-channel audio signals is also possible according to the decoder.

DTS-ES™ Matrix 6.1

DTS-ES™ Matrix 6.1 is a 6.1-channel discrete digital audio format inserting a surround back (SB) channel to the DTS digital surround sound through matrix encoding. Decoding of conventional 5.1-channel audio signals is also possible according to the decoder.

DTS NEO:6™ Surround

DTS NEO:6™ is a matrix decoding technology for achieving 6.1-channel surround playback with 2-channel sources. It includes "DTS NEO:6 Cinema" suited for playing movies and "DTS NEO:6 Music" suited for playing music.

DTS 96/24

DTS 96/24 is a digital audio format enabling high sound quality playback in 5.1-channels with a sampling frequency of 96 kHz and 24 bit quantization on DVD-Video.

Manufactured under license under U.S. Patent #'s: 5,451,942; 5,956,674; 5,974,380; 5,978,762; 6,226,616; 6,487,535; 7,212,872; 7,333,929; 7,392,195; 7,272,567 & other U.S. and worldwide patents issued & pending. DTS is a registered trademark and the DTS logos, Symbol, DTS-HD and DTS-HD Master Audio are trademarks of DTS, Inc.© 1996-2008 DTS, Inc. All Rights Reserved.

Audyssey

Audyssey MultEQ®

Audyssey MultEQ is a room equalization solution that calibrates any audio system so that it can achieve optimum performance for every listener in a large listening area. Based on several room measurements, MultEQ calculates an equalization solution that corrects for both time and frequency response problems in the listening area and also performs a fully automated surround system setup.

Audyssey Dynamic EQ™

Audyssey Dynamic EQ solves the problem of deteriorating sound quality as volume is decreased by taking into account human perception and room acoustics. Audyssey Dynamic EQ works in tandem with Audyssey MultEQ to provide well-balanced sound for every listener at any volume level.

Audyssey Dynamic Volume™

Audyssey Dynamic Volume solves the problem of large variations in volume level between television programs, commercials, and between the soft and loud passages of movies.

Audyssey Dynamic EQ is integrated into Dynamic Volume so that as the playback volume is adjusted automatically, the perceived bass response, tonal balance, surround impression, and dialog clarity remain the same.



Manufactured under license from Audyssey Laboratories. U.S. and foreign patents pending. Audyssey MultEQ® is a registered trademark of Audyssey Laboratories. Audyssey Dynamic EQ™ is a trademark of Audyssey Laboratories. Audyssey Dynamic Volume™ is a trademark of Audyssey Laboratories.

Surround Modes and Parameters

Surround mode	Signals and adjustability in the different modes																
	Channel output						Parameter (default values are shown in parentheses)										
	Front L/R	Center	Surround L/R	Surround Back L/R	Front Height L/R	Subwoofer	D. Comp *1	LFE *2	AFDM *1	SB CH Out	Cinema EQ.	Mode	Room Size	Effect	Delay time	Subwoofer	DRC *3
PURE DIRECT, DIRECT	○	⊙	⊙	⊙	×	⊙	○ (OFF)	○ (0dB)	×	×	×	×	×	×	×	○	○ (Auto)
MULTI CH DIRECT	○	⊙	⊙	⊙	×	⊙	×	○ (0dB)	○ (ON)	○	×	×	×	×	×	×	×
STEREO	○	×	×	×	×	⊙	○ (OFF)	○ (0dB)	×	×	×	×	×	×	×	×	○ (Auto)
EXT. IN	○	⊙	⊙	⊙	×	⊙	×	×	×	×	×	×	×	×	×	×	×
MULTI CH IN	○	⊙	⊙	⊙	×	⊙	×	○ (0dB)	○ (ON)	○	×	×	×	×	×	×	×
DOLBY PRO LOGIC IIx	○	⊙	⊙	⊙	×	⊙	○ (OFF)	×	×	○	○ (NOTE1)	○ (Cinema)	×	×	×	×	○ (Auto)
DOLBY PRO LOGIC II	○	⊙	⊙	×	×	⊙	○ (OFF)	×	×	○	○ (NOTE2)	○ (Cinema)	×	×	×	×	○ (Auto)
DTS NEO:6	○	⊙	⊙	⊙	×	⊙	○ (OFF)	×	×	○	○ (NOTE1)	○ (Cinema)	×	×	×	×	×
DOLBY PRO LOGIC IIz	○	⊙	⊙	×	⊙	⊙	○ (OFF)	×	×	×	○ (OFF)	×	×	×	×	×	×
DOLBY DIGITAL	○	⊙	⊙	⊙	⊙	⊙	○ (OFF)	○ (0dB)	○ (ON)	○	○ (OFF)	×	×	×	×	×	×
DOLBY DIGITAL Plus	○	⊙	⊙	⊙	⊙	⊙	○ (OFF)	○ (0dB)	○ (ON)	○	○ (OFF)	×	×	×	×	×	×
DOLBY TrueHD	○	⊙	⊙	⊙	⊙	⊙	○ (OFF)	○ (0dB)	○ (ON)	○	○ (OFF)	×	×	×	×	×	○ (Auto)
DTS SURROUND	○	⊙	⊙	⊙	⊙	⊙	○ (OFF)	○ (0dB)	○ (ON)	○	○ (OFF)	×	×	×	×	×	×
DTS 96/24	○	⊙	⊙	⊙	⊙	⊙	○ (OFF)	○ (0dB)	○ (ON)	○	○ (OFF)	×	×	×	×	×	×
DTS-HD	○	⊙	⊙	⊙	⊙	⊙	○ (OFF)	○ (0dB)	○ (ON)	○	○ (OFF)	×	×	×	×	×	×
5CH/7CH STEREO	○	⊙	⊙	⊙	⊙	⊙	○ (OFF)	○ (0dB)	×	○	×	×	×	×	×	×	×
ROCK ARENA	○	⊙	⊙	⊙	⊙	⊙	○ (OFF)	○ (0dB)	×	○	×	×	○ (Medium)	○ (10)	×	×	×
JAZZ CLUB	○	⊙	⊙	⊙	⊙	⊙	○ (OFF)	○ (0dB)	×	○	×	×	○ (Medium)	○ (10)	×	×	×
MONO MOVIE	○	⊙	⊙	⊙	⊙	⊙	○ (OFF)	○ (0dB)	×	○	×	×	○ (Medium)	○ (10)	×	×	×
VIDEO GAME	○	⊙	⊙	⊙	⊙	⊙	○ (OFF)	○ (0dB)	×	○	×	×	○ (Medium)	○ (10)	×	×	×
MATRIX	○	⊙	⊙	⊙	⊙	⊙	○ (OFF)	○ (0dB)	×	○	×	×	×	×	○ (30 ms)	×	×
VIRTUAL	○	×	×	×	×	⊙	○ (OFF)	○ (0dB)	×	×	×	×	×	×	×	×	×

○ : Signal / Adjustable
 × : No signal / Not adjustable
 ⊙ : Turned on or off by speaker configuration setting

○ : Signal / Adjustable
 × : No signal / Not adjustable
 NOTE1 : This parameter is available when the menu "Mode" (page 44) is set to "Cinema".
 NOTE2 : This parameter is available when the menu "Mode" (page 44) is set to "Cinema" or "PL".

NOTE:
 *1 : When playing Dolby Digital and DTS signals.
 *2 : When playing Dolby Digital, DTS and Linear PCM (multi ch).
 *3 : When playing Dolby TrueHD signal.

Surround mode	Signals and adjustability in the different modes									
	Parameter (default values are shown in parentheses)									
	PRO LOGIC II/IIx MUSIC mode only			NEO:6 MUSIC mode only	EXT. IN only	Tone (NOTE4)	MultEQ	Dynamic EQ (NOTE5)	Dynamic Volume (NOTE6)	RESTORER (NOTE7)
Panorama	Dimension	C. Width	Center Image	SW ATT						
PURE DIRECT, DIRECT	×	×	×	×	×	×	×	×	×	×
MULTI CH DIRECT	×	×	×	×	×	×	×	×	×	×
STEREO	×	×	×	×	×	○ (0dB)	○ (OFF)	○ (OFF)	○ (OFF)	○
EXT. IN	×	×	×	×	○	×	×	×	×	×
MULTI CH IN	×	×	×	×	×	○ (0dB)	○ (OFF)	○ (OFF)	○ (OFF)	×
DOLBY PRO LOGIC IIx	○ (OFF)	○ (3)	○ (3)	×	×	○ (0dB)	○ (OFF)	○ (OFF)	○ (OFF)	○
DOLBY PRO LOGIC II	○ (OFF)	○ (3)	○ (3)	×	×	○ (0dB)	○ (OFF)	○ (OFF)	○ (OFF)	○
DTS NEO:6	×	×	×	○ (0.3)	×	○ (0dB)	○ (OFF)	○ (OFF)	○ (OFF)	○
DOLBY PRO LOGIC IIz	×	×	×	×	×	○ (0dB)	○ (OFF)	○ (OFF)	○ (OFF)	×
DOLBY DIGITAL	×	×	×	×	×	○ (0dB)	○ (OFF)	○ (OFF)	○ (OFF)	×
DOLBY DIGITAL Plus	×	×	×	×	×	○ (0dB)	○ (OFF)	○ (OFF)	○ (OFF)	×
DOLBY TrueHD	×	×	×	×	×	○ (0dB)	○ (OFF)	○ (OFF)	○ (OFF)	×
DTS SURROUND	×	×	×	×	×	○ (0dB)	○ (OFF)	○ (OFF)	○ (OFF)	×
DTS-96/24	×	×	×	×	×	○ (0dB)	○ (OFF)	○ (OFF)	○ (OFF)	×
DTS-HD	×	×	×	×	×	○ (0dB)	○ (OFF)	○ (OFF)	○ (OFF)	×
5CH/7CH STEREO	×	×	×	×	×	○ (0dB)	○ (OFF)	○ (OFF)	○ (OFF)	○
ROCK ARENA	×	×	×	×	×	○ (NOTE3)	○ (OFF)	○ (OFF)	○ (OFF)	○
JAZZ CLUB	×	×	×	×	×	○ (0dB)	○ (OFF)	○ (OFF)	○ (OFF)	○
MONO MOVIE	×	×	×	×	×	○ (0dB)	○ (OFF)	○ (OFF)	○ (OFF)	○
VIDEO GAME	×	×	×	×	×	○ (0dB)	○ (OFF)	○ (OFF)	○ (OFF)	○
MATRIX	×	×	×	×	×	○ (0dB)	○ (OFF)	○ (OFF)	○ (OFF)	○
VIRTUAL	×	×	×	×	×	○ (0dB)	○ (OFF)	○ (OFF)	○ (OFF)	○

○ : Adjustable
 × : Not adjustable
 NOTE3 : BASS +6 dB, TREBLE +4 dB
 NOTE4 : Cannot be set when the "Dynamic EQ" (page 47) setting is "ON".
 NOTE5 : Cannot be set when the "MultEQ" (page 46) setting is "OFF".
 NOTE6 : Cannot be set when the "Dynamic EQ" (page 47) setting is "OFF".
 NOTE7 : "RESTORER" can be set for analog or PCM 48 k or 44.1 k input signals.

Differences in Surround Mode Names Depending on the Input Signals

Button	Surround mode	Note	Input signals														
			ANALOG	PCM		DTS-HD		DTS				DOLBY		DOLBY DIGITAL			
			Linear PCM (multi ch)	Linear PCM (2ch)	DTS-HD Master Audio	DTS-HD High Resolution Audio	DTS ES DSCRT (With Flag)	DTS ES MTRX (With Flag)	DTS (5.1ch)	DTS 96/24	DOLBY TrueHD	DOLBY DIGITAL Plus	DOLBY DIGITAL EX (With Flag)	DOLBY DIGITAL EX (With no Flag)	DOLBY DIGITAL (5.1/5/4ch)	DOLBY DIGITAL (4/3ch)	DOLBY DIGITAL (2ch)
STANDARD																	
DTS SURROUND																	
	DTS-HD MSTR		×	×	×	●	×	×	×	×	×	×	×	×	×	×	×
	DTS-HD HI RES		×	×	×	×	●	×	×	×	×	×	×	×	×	×	×
	DTS ES DSCRT6.1	*1 *3	×	×	×	×	×	●◎	×	×	×	×	×	×	×	×	×
	DTS ES MTRX6.1	*1 *3	×	×	×	×	×	●◎	×	×	×	×	×	×	×	×	×
	DTS SURROUND		×	×	×	×	×	○	○	●	×	×	×	×	×	×	×
	DTS 96/24		×	×	×	×	×	×	×	●	×	×	×	×	×	×	×
	DTS (-HD) + PLIIx CINEMA	*2 *3	×	×	×	○	○	○	○	○	×	×	×	×	×	×	×
	DTS (-HD) + PLIIx MUSIC	*1 *3	×	×	×	○	○	○	○	○	×	×	×	×	×	×	×
	DTS (-HD) + PLIIz	*1 *4	×	×	×	○	○	○	○	○	×	×	×	×	×	×	×
	DTS (-HD) + NEO:6	*1 *3	×	×	×	○	○	○	○	○	×	×	×	×	×	×	×
	DTS NEO:6 CINEMA		○	×	○	×	×	×	×	×	×	×	×	×	×	×	○
	DTS NEO:6 MUSIC		○	×	○	×	×	×	×	×	×	×	×	×	×	×	○
DOLBY SURROUND																	
	DOLBY TrueHD		×	×	×	×	×	×	×	×	●	×	×	×	×	×	×
	DOLBY DIGITAL+		×	×	×	×	×	×	×	×	×	●	×	×	×	×	×
	DOLBY DIGITAL EX	*1 *3	×	×	×	×	×	×	×	×	×	×	○	○	○	○	×
	DOLBY (D+) (HD) +EX	*1 *3	×	×	×	×	×	×	×	×	○	○	×	×	×	×	×
	DOLBY DIGITAL		×	×	×	×	×	×	×	×	×	×	○	●	●	●	×
	DOLBY (D) (D+) (HD) +PLIIx CINEMA	*2 *3	×	×	×	×	×	×	×	×	○	○	●◎	○	○	○	×
	DOLBY (D) (D+) (HD) +PLIIx MUSIC	*1 *3	×	×	×	×	×	×	×	×	○	○	○	○	○	○	×
	DOLBY (D) (D+) (HD) +PLIIz	*1 *4	×	×	×	×	×	×	×	×	○	○	○	○	○	○	×
	DOLBY PRO LOGIC IIx CINEMA	*3	○	×	○	×	×	×	×	×	×	×	×	×	×	×	○
	DOLBY PRO LOGIC IIx MUSIC	*3	○	×	○	×	×	×	×	×	×	×	×	×	×	×	○
	DOLBY PRO LOGIC IIx GAME	*3	○	×	○	×	×	×	×	×	×	×	×	×	×	×	○
	DOLBY PRO LOGIC IIz	*4	○	×	○	×	×	×	×	×	×	×	×	×	×	×	○
	DOLBY PRO LOGIC II CINEMA		○	×	○	×	×	×	×	×	×	×	×	×	×	×	○
	DOLBY PRO LOGIC II MUSIC		○	×	○	×	×	×	×	×	×	×	×	×	×	×	○
	DOLBY PRO LOGIC II GAME		○	×	○	×	×	×	×	×	×	×	×	×	×	×	○
	DOLBY PRO LOGIC		○	×	○	×	×	×	×	×	×	×	×	×	×	×	○

NOTE:

- *1: This mode is not available when the surround back speaker setup is set to "None".
- *2: This mode is not available when the surround back speaker setup is set to "1sp" or "None".
- *3: Can be set when "Amp Assign" is set to "Normal".
- *4: Not selectable when "Amp Assign" is set to anything other than "Front Height".

- : Mode selectable in initial status
- ◎ : Mode fixed when "AFDM" is "ON"
- : Selectable mode
- × : Non-selectable mode

Button	Surround mode	Note	Input signals														
			ANALOG	PCM		DTS-HD		DTS				DOLBY		DOLBY DIGITAL			
				Linear PCM (multi ch)	Linear PCM (2ch)	DTS-HD Master Audio	DTS-HD High Resolution Audio	DTS ES DSCRT (With Flag)	DTS ES MTRX (With Flag)	DTS (5.1ch)	DTS 96/24	DOLBY TrueHD	DOLBY DIGITAL Plus	DOLBY DIGITAL EX (With Flag)	DOLBY DIGITAL EX (With no Flag)	DOLBY DIGITAL (5.1/5/4ch)	DOLBY DIGITAL (4/3ch)
STANDARD																	
MULTI CH IN																	
	MULTI CH IN		×	●	×	×	×	×	×	×	×	×	×	×	×	×	×
	MULTI IN + PLIIx CINEMA	*2 *3	×	○	×	×	×	×	×	×	×	×	×	×	×	×	×
	MULTI IN + PLIIx MUSIC	*1 *3	×	○	×	×	×	×	×	×	×	×	×	×	×	×	×
	MULTI IN + PLIIz	*1 *5	×	○	×	×	×	×	×	×	×	×	×	×	×	×	×
	MULTI IN + Dolby EX	*1 *3	×	○	×	×	×	×	×	×	×	×	×	×	×	×	×
	MULTI CH IN 7.1	*3	×	● ◎ (7.1)	×	×	×	×	×	×	×	×	×	×	×	×	×
DIRECT																	
	DIRECT		○	×	○	○	○	○	○	○	○	○	○	○	○	○	○
	MULTI CH DIRECT		×	○	×	×	×	×	×	×	×	×	×	×	×	×	×
	M DIRECT + PLIIx CINEMA	*2 *3	×	○	×	×	×	×	×	×	×	×	×	×	×	×	×
	M DIRECT + PLIIx MUSIC	*1 *3	×	○	×	×	×	×	×	×	×	×	×	×	×	×	×
	M DIRECT + PLIIz	*1 *5	×	○	×	×	×	×	×	×	×	×	×	×	×	×	×
	M DIRECT + Dolby EX	*1 *3	×	○	×	×	×	×	×	×	×	×	×	×	×	×	×
	M DIRECT 7.1	*3	×	○ (7.1)	×	×	×	×	×	×	×	×	×	×	×	×	×
PURE DIRECT																	
	PURE DIRECT		○	×	○	○	○	○	○	○	○	○	○	○	○	○	○
	MULTI CH PURE DIRECT		×	○	×	×	×	×	×	×	×	×	×	×	×	×	×
	M PURE D + PLIIx CINEMA	*2 *3	×	○	×	×	×	×	×	×	×	×	×	×	×	×	×
	M PURE D + PLIIx MUSIC	*1 *3	×	○	×	×	×	×	×	×	×	×	×	×	×	×	×
	M PURE D + PLIIz	*1 *5	×	○	×	×	×	×	×	×	×	×	×	×	×	×	×
	M PURE D + Dolby EX	*1 *3	×	○	×	×	×	×	×	×	×	×	×	×	×	×	×
	M CH PURE DIRECT 7.1	*3	×	○ (7.1)	×	×	×	×	×	×	×	×	×	×	×	×	×
DSP SIMULATION																	
	5CH/7CH STEREO	*4	○	○	○	○	○	○	○	○	○	○	○	○	○	○	○
	ROCK ARENA		○	○	○	○	○	○	○	○	○	○	○	○	○	○	○
	JAZZ CLUB		○	○	○	○	○	○	○	○	○	○	○	○	○	○	○
	MONO MOVIE		○	○	○	○	○	○	○	○	○	○	○	○	○	○	○
	VIDEO GAME		○	○	○	○	○	○	○	○	○	○	○	○	○	○	○
	MATRIX		○	○	○	○	○	○	○	○	○	○	○	○	○	○	○
	VIRTUAL		○	○	○	○	○	○	○	○	○	○	○	○	○	○	○
STEREO																	
	STEREO		●	○	●	○	○	○	○	○	○	○	○	○	○	○	○

NOTE :

- *1: This mode is not available when the surround back speaker setup is set to "None".
- *2: This mode is not available when the surround back speaker setup is set to "1sp" or "None".
- *3: Can be set when "Amp Assign" is set to "Normal".
- *4: If the surround back speaker setup is set to "None", then "5CH STEREO" is displayed.
- *5: Not selectable when "Amp Assign" is set to anything other than "Front Height".

- : Mode selectable in initial status
- ◎ : Mode fixed when "AFDM" is "ON"
- : Selectable mode
- × : Non-selectable mode

Troubleshooting

If a problem should arise, first check the following:

1. Are the connections correct?
2. Is the set being operated as described in the owner's manual?
3. Are the other components operating properly?

If this unit does not operate properly, check the items listed in the table below. Should the problem persist, there may be a malfunction.

In this case, disconnect the power immediately and contact your store of purchase.

[General]

Symptom	Cause	Countermeasure	Page
Set does not operate properly.	<ul style="list-style-type: none"> • External noise or interference is causing the set to malfunction. 	<ul style="list-style-type: none"> • Reset the microprocessor. 	64
Power does not turn on, or turns off directly after it was turned on.	<ul style="list-style-type: none"> • Connection of the power cord is faulty. 	<ul style="list-style-type: none"> • Check the insertion of the power cord plug. 	17
No sound is produced from speakers.	<ul style="list-style-type: none"> • Connection with the input devices or connection of the speaker cables is faulty. 	<ul style="list-style-type: none"> • Check the connections. 	11
	<ul style="list-style-type: none"> • Device you want to play and set input source do not match. 	<ul style="list-style-type: none"> • Select an appropriate input source. 	38
	<ul style="list-style-type: none"> • Master volume is turned too low. 	<ul style="list-style-type: none"> • Adjust the master volume to an appropriate level. 	38
	<ul style="list-style-type: none"> • Mute mode is set. 	<ul style="list-style-type: none"> • Cancel the mute mode. 	42
	<ul style="list-style-type: none"> • Headphones are connected. 	<ul style="list-style-type: none"> • Disconnect the headphones. 	42
	<ul style="list-style-type: none"> • No digital signals are being input. 	<ul style="list-style-type: none"> • Select an input source for which the digital input setting has been made. 	33
	<ul style="list-style-type: none"> • The connectors to which the digital inputs are assigned and the settable input modes do not match. 	<ul style="list-style-type: none"> • Set the input mode. 	34
Display is off.	<ul style="list-style-type: none"> • The "Display" setting is set to "OFF". 	<ul style="list-style-type: none"> • Set to something other than "OFF". 	31
	<ul style="list-style-type: none"> • The PURE DIRECT mode is set. 	<ul style="list-style-type: none"> • Set a surround mode other than the PURE DIRECT mode. 	44
"DOLBY DIGITAL" indicator does not appear on display.	<ul style="list-style-type: none"> • Blu-ray Disc player / DVD player's digital audio output setting is not proper. 	<ul style="list-style-type: none"> • Check the Blu-ray Disc player / DVD player's audio output setting. For details, read the Blu-ray Disc player / DVD player's operating instructions. 	–

Symptom	Cause	Countermeasure	Page
Power switches off suddenly while you are using the AVR-1910, the power indicator will flash in red at intervals of approximately 2 seconds.	<ul style="list-style-type: none"> • The protection circuit will be activated depending upon the temperature rise in the internal parts of the unit. 	<ul style="list-style-type: none"> • Please switch off power at once, and re-apply the power after the body temperature has fallen sufficiently. • Please re-install AVR-1910 in a place having good ventilation. 	3 –
Power switches off suddenly while you are using the AVR-1910, the power indicator will flash red at intervals of approximately 0.5 seconds.	<ul style="list-style-type: none"> • Use speakers having impedance less than that specified. • If speaker cable core wires touch each other or the core wires become disconnected from their terminals, the protection circuit will be activated in the event of core wires coming into contact with the AVR-1910 rear panel. 	<ul style="list-style-type: none"> • Please use speakers which have the specified impedance. • Unplug the power cord, then after twisting the core wires together tightly again, or effecting termination treatments etc, please reconnect once again. 	12 12
			–
Even applying power, the power display flashes red at intervals of approximately 0.5 seconds.	<ul style="list-style-type: none"> • The AVR-1910 amplifier circuit has failed. 	<ul style="list-style-type: none"> • Switch off the power and please contact the DENON service adviser. 	–
Set does not work properly when remote control unit operated.	<ul style="list-style-type: none"> • Batteries are worn. • You are operating outside of the specified range. • Obstacle between main unit and remote control unit. • The batteries are not inserted in the proper direction, as indicated by the polarity marks in the battery compartment. • The set's remote control sensor is exposed to strong light (direct sunlight, inverter type fluorescent bulb light, etc.). • Settings do not match the remote control unit's DEVICE SELECT switch. 	<ul style="list-style-type: none"> • Replace with new batteries. • Operate within the specified range. • Remove the obstacle. • Insert the batteries in the proper direction, following the polarity marks in the battery compartment. • Move the set to a place in which the remote control sensor will not be exposed to strong light. • Match the settings to the remote control unit's DEVICE SELECT switch. 	3 3 3 3 3
			3
			3
			3
			52

[Audio]

Symptom	Cause	Countermeasure	Page
No sound is produced from center speaker.	<ul style="list-style-type: none"> You are playing a monaural source (TV, etc.) in the "STANDARD" (Dolby/DTS Surround) mode. 	<ul style="list-style-type: none"> The mode is set to something other than "STANDARD" (Dolby/DTS Surround). 	42
No sound is produced from surround speakers.	<ul style="list-style-type: none"> The surround mode is set to "STEREO", "DIRECT" or "PURE DIRECT". 	<ul style="list-style-type: none"> Set to a surround playback mode. 	42, 43
No sound is produced from surround back speaker.	<ul style="list-style-type: none"> The surround back speaker's power amplifier is assigned to a different channel. 	<ul style="list-style-type: none"> Check the setting and change it as necessary. 	25
	<ul style="list-style-type: none"> "S.Back" setting is set to "None". 	<ul style="list-style-type: none"> Set to something other than "None". 	26
	<ul style="list-style-type: none"> The "Parameter" – "Surround Parameter" – "SB CH Out" settings are "OFF". 	<ul style="list-style-type: none"> Please set "Parameter" – "Surround Parameter" – "SB CH Out" to settings other than "OFF". 	45
	<ul style="list-style-type: none"> Surround mode not set to a mode for 6.1- or 7.1-channel playback. 	<ul style="list-style-type: none"> Select a surround playback mode. 	42
No sound is produced from subwoofer.	<ul style="list-style-type: none"> Subwoofer's power not turned on. 	<ul style="list-style-type: none"> Turn on the subwoofer's power. 	–
	<ul style="list-style-type: none"> The "Subwoofer" setting at "Speaker Config." is set to "No". 	<ul style="list-style-type: none"> Set to "Yes". 	25
	<ul style="list-style-type: none"> The subwoofer is not properly connected. The subwoofer's volume is turned off. 	<ul style="list-style-type: none"> Check the connections. Adjust the subwoofer's volume to an appropriate level. 	11 50
DTS sound is not output.	<ul style="list-style-type: none"> Blu-ray Disc player / DVD player's audio output setting is not set to bitstream. 	<ul style="list-style-type: none"> Set the Blu-ray Disc player / DVD player. For details, refer to the Blu-ray Disc player / DVD player's operating instructions. 	–
	<ul style="list-style-type: none"> Blu-ray Disc player / DVD player is not compatible with DTS sound playback. 	<ul style="list-style-type: none"> Use a DTS-compatible player. 	–
	<ul style="list-style-type: none"> The AVR-1910's "Decode Mode" setting is set to "PCM". 	<ul style="list-style-type: none"> Set to the "Auto" or "DTS" mode. 	35
HDMI audio signals are not output from speakers.	<ul style="list-style-type: none"> The "Manual Setup" – "HDMI Setup" – "HDMI Audio Out" setting is set to "TV". 	<ul style="list-style-type: none"> Set to "AMP". 	28
No sound is output from the monitor connected with HDMI connections.	<ul style="list-style-type: none"> The "Manual Setup" – "HDMI Setup" – "HDMI Audio Out" setting is set to "AMP". 	<ul style="list-style-type: none"> Set to "TV". 	28

Symptom	Cause	Countermeasure	Page
Dolby TrueHD, DTS-HD, Dolby Digital Plus audio is not output.	<ul style="list-style-type: none"> HDMI is not connected. Blu-ray Disc player's audio output setting is not set to bitstream. 	<ul style="list-style-type: none"> Connect the HDMI. Set the Blu-ray Disc player. For details, refer to the Blu-ray Disc player's operating instructions. Use a DTS-compatible player. 	13 –
	<ul style="list-style-type: none"> Blu-ray Disc player is not compatible with DTS sound playback. 		–

[Video]

Symptom	Cause	Countermeasure	Page
No picture appears.	<ul style="list-style-type: none"> The connections between the AVR-1910 and monitor are faulty. The monitor's input setting is wrong. PURE DIRECT mode is set. The player is connected using the component input connectors, the monitor is connected using the video (yellow) output connectors. 	<ul style="list-style-type: none"> Check the connections. 	13 ~ 16
		<ul style="list-style-type: none"> Set properly. 	–
		<ul style="list-style-type: none"> Cancel the PURE DIRECT mode. 	44
		<ul style="list-style-type: none"> High definition (1080i/720p) and progressive (480p/576p) video signals are not down-converted. Set the player to interlace (480i/576i) signals. 	–
Picture cannot be recorded.	<ul style="list-style-type: none"> Input source does not match recorder's video connection connector (video). 	<ul style="list-style-type: none"> The video conversion function does not work for the REC OUT connectors. Match the input source and recorder connections. 	15
DVDs cannot be copied on a DVR.	–	<ul style="list-style-type: none"> This is not a malfunction. Most movie software includes copy prevention signals and cannot be copied. 	–
The menu screen and status indicators are not displayed.	<ul style="list-style-type: none"> "OFF" is displayed for the status. The main volume display is "OFF". The display during tuner operation is "OFF". The display during iPod operation is "OFF". 	<ul style="list-style-type: none"> When viewing HDMI or component video signals via the AVR-1910, the on-screen display appears when the MENU button on the main unit or the MENU button on the main remote control unit. 	9
		<ul style="list-style-type: none"> Set "Manual Setup" – "Option Setup" – "On-Screen Display" – "Text" to "ON". 	30
		<ul style="list-style-type: none"> Set "Manual Setup" – "Option Setup" – "On-Screen Display" – "Master Volume" to "Top" or "Bottom". 	30
		<ul style="list-style-type: none"> Set when "Manual Setup" – "On-Screen Display" – "Tuner Information" is not "OFF". 	31
		<ul style="list-style-type: none"> Set when "Manual Setup" – "On-Screen Display" – "iPod Information" is not "OFF". 	31

[HDMI]

Symptom	Cause	Countermeasure	Page
HDMI audio signals are not output from speakers.	<ul style="list-style-type: none"> The "Manual Setup" – "HDMI Setup" – "HDMI Audio Out" setting is set to "TV" 	<ul style="list-style-type: none"> Set to "Amp" 	28
No picture appears with HDMI connections.	<ul style="list-style-type: none"> The connections to the HDMI connectors are faulty. HDMI input setting is improper. The monitor is not compatible with copyright protection (HDCP). The HDMI format of the player and monitor do not match. 	<ul style="list-style-type: none"> Check the connections. Check the HDMI input setting. Connect a monitor that is compatible with copyright protection (HDCP). Match the HDMI format of the player and monitor. 	13 33 12 12
No sound is output from the monitor connected with HDMI connections.	<ul style="list-style-type: none"> The "Manual Setup" – "HDMI Setup" – "HDMI Audio Out" setting is set to "Amp." 	<ul style="list-style-type: none"> Set to "TV" 	28
When performing the following operations on a connected device, AVR-1910 has the same operations. · Power ON/OFF · Switching audio output devices · Adjust volume · Switch input source	<ul style="list-style-type: none"> HDMI's CEC function is operating. 	<ul style="list-style-type: none"> Set "Manual Setup" – "HDMI Setup" – "HDMI Control" to "OFF". When you only want to operate the power on/off each device, set "Power Off Control" to "OFF". 	28

[iPod]

Symptom	Cause	Countermeasure	Page
iPod cannot be played.	<ul style="list-style-type: none"> The input source assigned to "iPod Dock" is not selected. Cable is not properly connected. Control dock for iPod's AC adapter is not connected to power outlet. 	<ul style="list-style-type: none"> Switch to the input source assigned at "iPod Dock". Reconnect. Plug the control dock for iPod's AC adapter into a power outlet. 	33 14 –

[SIRIUS Satellite Radio]





Symptom	Cause	Countermeasure	Page
"CHECK SIRIUS TUNER" is displayed.	<ul style="list-style-type: none"> The SiriusConnect Home Tuner unit is not connected. 	<ul style="list-style-type: none"> Check that the connections are correct. 	16
"ANTENNA ERROR" is displayed.	<ul style="list-style-type: none"> The antenna is not connected. 	<ul style="list-style-type: none"> Check that the connections are correct. 	16
"NO SIGNAL" is displayed.	<ul style="list-style-type: none"> The signal cannot be received. 	<ul style="list-style-type: none"> Reposition the antenna. 	–
"INVALID CHANNEL" is displayed.	<ul style="list-style-type: none"> Channel is not present. 	<ul style="list-style-type: none"> Select another channel. 	–
"ACQUIRING SIGNAL" is displayed.	<ul style="list-style-type: none"> The signal cannot be received. Displays while SiriusConnect Home Tuner is connected. 	<ul style="list-style-type: none"> Reposition your SiriusConnect Home Tuner and Home Dock antenna. Reposition your SiriusConnect Home Tuner and Home Dock antenna. 	– –
"Call SIRIUS" * is displayed.	<ul style="list-style-type: none"> Channels are not subscribed to. 	<ul style="list-style-type: none"> If you subscribe to the channel, you can receive the channel. 	–
"SUBSCRIPTION UPDATED" is displayed.	<ul style="list-style-type: none"> While updating contract information. 	–	–
"Enter Lock Code []" is displayed.	<ul style="list-style-type: none"> Selected channels are locked. 	<ul style="list-style-type: none"> Please insert pass word (4 digits) into "[]". 	41

* : After scroll displays "Call 888-539-...." twice, displays "Call SIRIUS".

Restoring all the settings to as they were at the time of purchase (Resetting the Microprocessor)

Perform this procedure if the display is abnormal or if operations cannot be performed.

When the microprocessor is reset, all the settings are reset to their default values.

- 1** Turn off the power using  on the main unit.
- 2** Press  while simultaneously pressing  and  on the main unit.
- 3** Once the display starts flashing at intervals of about 1 second, release the two buttons.



If in step 3 the display does not flash at intervals of about 1 second, start over from step 1.

Specifications

Audio section

Power amplifier

Rated output:

Front (A, B):

90 W+90 W (8 Ω/ohms, 20 Hz ~ 20 kHz with 0.08 % T.H.D.)

125 W+125 W (6 Ω/ohms, 1 kHz with 0.7 % T.H.D.)

Center:

90 W (8 Ω/ohms, 20 Hz ~ 20 kHz with 0.08 % T.H.D.)

125 W (6 Ω/ohms, 1 kHz with 0.7 % T.H.D.)

Surround:

90 W+90 W (8 Ω/ohms, 20 Hz ~ 20 kHz with 0.08 % T.H.D.)

125 W+125 W (6 Ω/ohms, 1 kHz with 0.7 % T.H.D.)

Surround Back:

90 W+90 W (8 Ω/ohms, 20 Hz ~ 20 kHz with 0.08 % T.H.D.)

125 W+125 W (6 Ω/ohms, 1 kHz with 0.7 % T.H.D.)

Output connectors:

Front: A or B 6~16 Ω/ohms
A + B 12~16 Ω/ohms

Center, Surround, Surround Back / Amp Assign:
6~16 Ω/ohms

Analog

Input sensitivity / Input impedance: 200 mV / 47 kΩ/kohms

Frequency response: 10 Hz ~ 100 kHz — +1, -3 dB (DIRECT mode)

S/N: 100 dB (IHF-A weighted, DIRECT mode)

Video section

Standard video connectors

Input / output level and impedance: 1 Vp-p, 75 Ω/ohms

Frequency response: 5 Hz ~ 10 MHz — +1, -3 dB

Color component video connector

Input / output level and impedance: Y (brightness) signal — 1 Vp-p, 75 Ω/ohms

P_B / C_B signal — 0.7 Vp-p, 75 Ω/ohms

P_R / C_R signal — 0.7 Vp-p, 75 Ω/ohms

Frequency response: 5 Hz ~ 60 MHz — +0, -3 dB

Tuner section

	[FM]	[AM]
Receiving Range:	(note: μV at 75 Ω/ohms, 0 dBf = 1 × 10 ⁻¹⁵ W) 87.5 MHz ~ 107.9 MHz	520 kHz ~ 1710 kHz
Usable Sensitivity:	1.2 μV (12.8 dBf)	18 μV
50 dB Quieting Sensitivity:	MONO 2.8 μV (20.2 dBf) STEREO 48.7 μV (45.0 dBf)	
S/N (IHF-A):	MONO 70 dB STEREO 67 dB	
Total harmonic Distortion (at 1 kHz):	MONO 0.7 % STEREO 1.0 %	

General

Power supply: AC 120 V, 60 Hz

Power consumption: 5.5 A

0.3 W (Standby)

Maximum external dimensions: 434 (W) x 171 (H) x 377 (D) mm (17-3/32" x 6-47/64" x 14-27/32")

Weight: 10.7 kg (25 lbs 5.7 oz)

Remote control unit (RC-1117)

Batteries: R6/AA Type (two batteries)

Maximum external dimensions: 52 (W) x 243 (H) x 21 (D) mm (2-3/64" x 9-9/16" x 53/64")

Weight: 184 g (Approx 6.5 oz) (including batteries)

* For purposes of improvement, specifications and design are subject to change without notice.

DEVICE SELECT : TV

Television

3M	100
A Addison	163
Admiral	033, 044, 050, 141
Advent	130
Adventura	041
Aiko	138
Akai	018, 019, 034, 119, 137, 151
Albatron	127, 131
Alleron	039
America Action	139
Ampro	129
Amtron	038
Anam	139
Anam National	035, 038
AOC	030, 036, 079, 137, 151, 154
Apex	048, 062
Apex Digital	174
Audiovox	038, 067, 071, 138, 139, 140
Aventura	029
Axion	120
B Bang & Olufsen	146
Barco	020
Baur	034
Belcor	030
Bell & Howell	033
Benq	089, 135
Blue Sky	020
Bradford	038, 139
Brilliant	145
Brockwood	030
Broksonic	050, 139, 141
byd:sign	123
C Candle	037, 041, 137, 151
Carnivale	137, 151
Carver	155
CCE	147, 152
Celebrity	034
Celera	048
Changhong	048
Ching Tai	163
Chun Yun	157, 163, 169, 173
Chung Hsin	160, 169
Citizen	037, 038, 049, 137, 138, 151, 153, 156
Clarion	139
Coby	074

Contec	139
Contec/Cony	038
Craig	038, 139
Crosley	049, 155
Crown	038, 139, 153
CTX	082
Curtis Mathes	010, 019, 044, 137, 140, 143, 151, 153, 155, 156
CXC	038, 139
Cytron	118
D Daewoo	030, 036, 049, 138, 140, 153
Daytron	030
Dell	012, 032
Denon	143
DiamondVision	125
Dimensia	010
Disney	060
Dumont	013, 030
Durabrand	012, 029, 050, 111, 136, 139, 141
Dwin	044, 128
E Electroband	034
Electrograph	142
Electrohome	034, 035, 050
Element	106
Emerson	012, 029, 030, 038, 039, 049, 050, 139, 141, 153
Emprex	124
Envision	137, 151
Epson	080, 097
Erres	149
ESA	018, 029
Ether	158
F Firststar	170
Fujitsu	037, 039, 077
Funai	029, 038, 039, 139
Furi	165
Futuretech	038, 139
G Gateway	085, 142, 144
GE	010, 012, 035, 040, 045, 055, 140
GFM	027, 028
Gibraltar	013, 030, 137, 151
Go Video	134
Goldstar	012, 030, 036, 137, 151
Gradiente	084
Grundig	152
Grunpy	038, 039, 139
H Haier	107, 114, 136, 148
Hallmark	012
Hankook	158, 168, 169
Harman/Kardon	155

Harvard	038, 139
Havermy	044
Hello Kitty	140
Hewlett Packard	068
Hisense	087, 167, 174
Hitachi	[014]*, 058, 103, 143, 181
HP	031
Hyundai	133
I Ilo	090, 115, 117, 122
IMA	038
Infinity	155
InFocus	099
Initial	117
Innova	152
Insignia	029, 108, 109, 110
J Janeil	041
JBL	155
JC Penney	010, 036, 037, 040
JCB	034
Jean	159, 163, 167, 170
Jinxiang	161, 165, 167
JVC	023, 024, 025, 040, 050
K Kawasho	034
Kaypani	154
KEC	139
Kenwood	030, 137, 151
Kioto	020, 155
KLH	048
Kloss Novabeam	038, 041
Kolin	166, 169
KTV	038, 137, 139, 147, 151, 153
L LG	012, 030, 036, 127, 151
Logik	033
LXI	010, 012, 155
M M & S	155
Magnasonic	049
Magnavox	028, 037, 047, 054, 056, 137, 151, 155
Majestic	033
Marantz	046, 137, 151, 152, 155
Maxent	112, 142
Mediator	149
Megapower	127
Megatron	012, 143
Memorex	012, 029, 033, 036, 050, 141
MGA	012, 030, 036, 137, 151
Megatron	013, 040, 153
Mintek	117
Mitsubishi	012, 030, 036, 044, 057, 178
Monivision	127, 131

Montgomery Ward	033
Motorola	035, 044
MTC	030, 036, 137, 151, 156
Multitech	038, 139, 147
N NAD	012, 152
NEC	030, 035, 036, 081, 137, 151
Netsat	152
Net-TV	090, 142
Newave	163, 164, 168
Nikko	012, 137, 138, 151
Norcent	079, 174
Norwood Micro	090
Noshi	150
NTC	138
O Olevia	064, 072, 078
Onwa	038, 139
Oppo	121
Optoma	098
Optonica	044
Orion	050, 141
Otto Versand	034
P Panasonic	007, 008, 009, 035, 040, 059, 069, 176
Penney	012, 030, 137, 150, 151, 153, 156
Philco	030, 035, 036, 037, 050, 137, 151, 155
Philips	020, 021, 022, 035, 037, 046, 066, 105, 149, 152, 155
Philips Magnavox	020, 046, 047
Phonola	149
Pilot	030, 137, 151, 153
Pioneer	180, 184
Polaroid	030, 048, 075
Portland	030, 036, 138, 153
Prima	083, 130
Princeton	127
Prism	040
Proscan	010
Proton	012, 154
Protron	073
Proview	086, 106
Pulsar	013, 030
Pye	149
Q Quasar	035, 040
Quelle	034
R Radio Shack/Realistic	010, 038
Radiola	149
RadioShack	012, 030, 137, 139, 151, 153
RCA	010, 011, 030, 035, 036, 043, 045, 150, 156
Realistic	012, 030, 137, 139, 151, 153

Runco	013, 137, 151
S Sampo	137, 142, 151, 153, 154
Samsung	012, 018, 019, 030, 036, 101, 102, 137, 147, 151, 152, 156
Samsux	153
Sansui	050, 141
Sanyo	092
SBR	149
Sceptre	096
Scimitsu	030
Scotch	012
Scott	012, 030, 038, 039, 116, 139
Sears	010, 012, 029, 039, 088, 155
SEI	034
Sharp	015, 016, 017, 044, 070, 153, 179, 183
Shen Ying	163
Sheng Chia	044, 164
Shogun	030
Signature	033
Simpson	037
Sinudyne	034
SKY	152
Skygiant	169
Sony	000, 001, 002, 034, 052, 053, 175, 182
Soundesign	012, 037, 038, 039, 139
Sova	073
Sowa	162, 167
Squareview	029
SSS	030, 038, 139
Starlite	038, 139
Studio Experience	131
Superscan	044
Supre-Macy	041
Supreme	034
SVA	020, 113, 148, 174
Sylvania	026, 027, 028, 029, 037, 063, 104, 137, 151, 155
Symphonic	029, 038, 139
Synco	157, 162, 163, 164, 168, 172
Syntax	072
Syntax-Brilliant	072, 088
T Tacico	163, 168
Tandy	044
Tatung	035, 090, 144, 159, 162, 167
Technics	040
Techview	132
Techwood	040
Teco	159, 164, 168
Teknika	030, 033, 036, 037, 038, 039, 138, 139, 153, 155, 156

Telefunken	019
TMK	012
Toshiba	003, 004, 005, 006, 030, 051, 156, 177
Totevision	153
Trutech	091
Tuntex	158, 163
TVS	050, 141
U US Logic	090
V Vector Research	137, 151
Vidikron	155
Vidtech	012, 030, 036
Viewsonic	061, 076, 142
Viking	041
Viore	115
Vizio	061, 093, 094, 095, 126, 144
W Wards	010, 012, 030, 033, 036, 039, 137, 151, 155
Westinghouse	061, 065, 140
White Westinghouse	049, 050, 141
Y Yamaha	030, 036, 137, 151
Yapshe	171
Z Zenith	012, 013, 014, 030, 033, 042, 050, 138, 141

TV/VCR Combination

R RCA	011
S Sylvania	026

TV/DVD Combination

A Akai	119
Apex	062
Axion	120
C Coby	074
Cytron	118
D DiamondVision	125
Disney	060
G GFM	028
H Haier	114
I Ilo	117
Initial	117
Insignia	108
L LG	030
M Mintek	117
O Oppo	121
P Panasonic	069
Philips	066
Polaroid	075
R RCA	010
S Sansui	051
Sharp	070
Sylvania	027, 063

T Toshiba	005, 051
W Westinghouse	065

TV/DVD/VCR Combination

M Magnavox	028
P Panasonic	059
T Toshiba	006

DEVICE SELECT : DVD/HDP

Blu-ray Disc Player

D Denon	121
----------------	-----

DVD Player

A Accele Vision	088
Accurian	146
Advent	131
Akai	098, 126
Alco	129
Allegro	142
Amphion MediaWorks	117
AMW	117
Apex	025, 026, 027, 028, 049, 059, 136
Apple	109
Argo	043
Aspire	132
Astar	090
Audiovox	075, 129
Axion	099
B Bang & Olufsen	137
Blaupunkt	136
Blue Parade	039
BOSS	089
Broksonic	061, 126
C California Audio Labs	128
Changhong	071, 153
CineVision	074, 142
Coby	050, 081
Curtis Mathes	143
CyberHome	029, 043, 151, 152, 155, 156
Cytron	097
D Daewoo	057, 142
Denon	014, 070, [111]*, 112, 128
Desay	116
DiamondVision	124, 125
Disney	053, 063
Durabrand	144
E Emerson	127, 138, 145

Enterprise	138
Epson	120
ESA	145
F Fisher	139
Funai	145
G Gateway	068, 154
GE	044, 054, 136
GFM	101
Go Video	012, 142
Gradiente	128
Greenhill	136
H Haier	103
Harman/Kardon	082, 140
Hitachi	013
Hiteker	025
I Ilo	096
Initial	096, 136
Insignia	055, 102, 145
Integra	039
Irradio	091
iSymphony	108
J JBL	140
JVC	030, 031, 032, 033, 034
K Kawasaki	129
Kenwood	080, 128
KLH	058, 129, 136
Koss	067, 134
L Landel	147
Lasonic	141
Lenoxx	133, 144
LG	055, 076, 077, 095, 138, 142
Liquid Video	134
Liteon	068, 146
M Magnavox	047, 062, 127, 135, 145
Memorex	053, 126
Microsoft	044
Mintek	096, 136
Mitsubishi	056
N Nesa	136
Next Base	147
Nexstech	115
O Onkyo	071, 135
Oppo	100, 114
Optoma	122
Oritron	067, 134
P Panasonic	017, 018, 019, 020, 021, 022, 023, 024, 078, 083, 084, 085, 128, 135
Philips	007, 037, 038, 047, 052, 064, 073, 104, 135
Pioneer	039, 040, 041, 042, 087
Polaroid	028, 086
Proceed	025
Proscan	044

Protron	119
Q Qwestar	067
R RCA	035, 036, 039, 044, 129, 136
Regent	133
Rio	142
Rowa	130
S Sampo	148, 150
Samsung	011, 012, 013, 015, 016, 048, 128
Sansui	008, 126
Sanyo	126, 139
Sharp	051, 060, 079, 092, 093, 094
Shinsonic	096
Sonic Blue	142
Sony	000, 001, 002, 003, 004, 005, 006, 045, 065, 066, 105, 106, 107
Sungale	113
Superscan	127
Sylvania	046, 101, 123, 127, 145
Symphonic	038
T Teac	129, 149, 157, 158
Technics	128
Theta Digital	039
Toshiba	007, 008, 009, 010, 069, 126, 135
Trutech	110
U Urban Concepts	135
US Logic	096
V Venturer	129
VocoStar	118
W Westinghouse	072
X Xbox	044
Y Yamaha	017, 128
Z Zenith	055, 135, 138, 142

DVD/VCR Combination

B Broksonic	061
C CineVision	074
G Go Video	012
I Insignia	055
P Panasonic	018, 019, 020
S Samsung	012, 048
Sony	002, 003, 004, 005
Sylvania	046
T Toshiba	007, 010

TV/DVD Combination

A Akai	098
Apex	026
Audiovox	075
Axion	099
C Coby	081

Cytron	097
D DiamondVision	124
Disney	063
G GFM	101
H Haier	103
I Ilo	096
Initial	096
Insignia	102
L LG	077
M Mintek	096
O Oppo	100
P Panasonic	078
Philips	073
Polaroid	086
R RCA	035
S Sansui	008
Sharp	079
Sylvania	046, 123
T Toshiba	008, 101
W Westinghouse	072

TV/DVD/VCR Combination

M Magnavox	062
P Panasonic	021
T Toshiba	009

DEVICE SELECT : DVR/VCR

Digital Video Recorder

A ABS	035
Alienware	035
B Bang & Olufsen	079
C CyberPower	035
D Dell	035
DIRECTV	063, 065, 066, 067, 071, 073, 077
Dish Network	076
Dishpro	076
E EchoStar	076
ExpressVu	076
G Gateway	035
GOI	076
H Hewlett Packard	035
HNS	072
Howard Computers	035
HP	035
HTS	076
Hughes Network Systems	063, 065, 066, 067, 073
Humax	063
Hush	035

I	iBUYPOWER	035
J	JVC	063, 076
L	Linksys	035
M	Media Center PC	035
	Microsoft	035
	Mind	035
N	Niveus Media	035
	Northgate	035
P	Panasonic	070
	Philips	063, 065, 066, 067, 068, 072
	Proscan	077
R	RCA	063, 065, 072, 077
	ReplayTV	069
S	Samsung	065, 067, 072
	Sonic Blue	069
	Sony	035, 064, 074, 078
	Stack	035
	Systemax	035
T	Tagar Systems	035
	Tivo	063, 064, 065, 068, 073, 074, 078
	Toshiba	035, 075
	Touch	035
U	UltimateTV	077
V	Viewsonic	035
	Voodoo	035
Z	ZT Group	035

Video Cassette Recorder

A	ABS	035
	Adventura	008, 033
	Aiwa	008, 033
	Akai	020
	Alienware	035
	American High	032
	Asha	013, 030
	Audio Dynamics	018
	Audiovox	031
B	Beaumarck	013, 030
	Bell & Howell	029
	Broksonic	056
C	Calix	031
	Candle	030, 031
	Canon	032
	CineVision	058
	Citizen	030, 031
	Colorlyme	018
	Craig	013, 030, 031
	Curtis Mathes	012, 018, 030, 032
	Cybernex	013, 030
	CyberPower	035

D	Daewoo	019, 033
	Davidson	008
	DBX	018
	Dell	035
	Denon	014
	DIRECTV	061
	Durabrand	025
	Dynatech	008, 033
E	Electrohome	010, 031
	Electroponic	031
	Emerson	008, 010, 021, 031, 032, 033
F	Fisher	029
	Fuji	026, 032
	Funai	008, 021, 033
G	Garrard	008, 033
	Gateway	035
	GE	012, 013, 030, 032
	Go Video	013, 048
	Goldstar	018, 031
	Gradiente	008, 033
H	Harley Davidson	033
	Harman/Kardon	018
	Headquarter	029
	Hewlett Packard	035
	Hitachi	[008]*, 014
	Howard Computers	035
	HP	035
	Hughes Network Systems	014, 061
	Humax	061
	Hush	035
I	iBUYPOWER	035
	Insignia	059
	Instant Replay	032
J	JC Penney	018, 029, 030, 031, 032
	JCL	032
	JVC	016, 017, 018, 029
K	Kenwood	018, 029
	Kodak	031, 032
L	LG	031
	Linksys	035
	Lloyd's	008, 033
	LXI	031
M	Magnasonic	021
	Magnavox	008, 021, 022, 025, 028, 032
	Magnin	013, 031
	Marantz	018, 029, 032
	Marta	031
	Matsushita	032
	Media Center PC	035
	MEI	032
	Memorex	008, 013, 025, 029, 030, 031, 032, 033, 062

	MGA	010, 013
	MGN Technology	013, 030
	Microsoft	035
	Mind	035
	Minolta	014
	Mitsubishi	010, 038
	Motorola	032
	MTC	008, 013, 030
	Multitech	008, 030, 033
N	NEC	018, 029
	Nikko	031
	Niveus Media	035
	Noblex	013, 030
	Northgate	035
O	Olympus	032
	Optimus	021, 031
	Optonica	024
	Orion	044, 062
P	Panasonic	000, 001, 002, 003, 004, 032, 060
	Penney	013, 014
	Pentax	014
	Philco	032
	Philips	024, 032, 041, 061
	Philips Magnavox	041
	Pilot	031
	Profitronic	013
	Pulsar	025
Q	Quarter	029
	Quartz	029
	Quasar	032
R	RadioShack	008, 024, 031
	Radio Shack/Realistic	024, 029, 030, 031, 032, 033
	Radix	031
	Randex	031
	RCA	011, 012, 013, 014, 015, 030, 032, 051
	Realistic	008, 024, 029, 030, 031, 032, 033
	ReplayTV	060
	Ricavision	035
	Runco	025
S	Samsung	013, 019, 020, 030, 040, 048, 049, 061
	Sanky	025
	Sansui	008, 044, 062
	Sanyo	013, 029, 030
	Scott	010, 019
	Sears	008, 014, 029, 031, 032
	Sharp	023, 024, 042
	Shogun	013, 030
	Singer	032
	Sonic Blue	060

	Sony	005, 006, 007, 008, 026, 034, 035, 036, 037, 045, 052, 053, 054
	Stack	035
	STS	014, 032
	Sylvania	008, 010, 021, 022, 032, 033, 046, 055
	Symphonic	008, 021, 022, 033
	Systemax	035
T	Tagar Systems	035
	Tandy	029
	Tashiko	031
	Teac	008, 033
	Technics	032
	Teknika	008, 031, 032, 033
	Thomas	008
	Tivo	061
	TMK	013, 030
	Toshiba	009, 010, 019, 035, 039, 047, 050, 057
	Totevision	013, 030, 031
	Touch	035
U	Unitech	013, 030
V	Vector	019
	Vector Research	018
	Video Concepts	018, 019
	Videosonic	013, 030
	Viewsonic	035
	Villain	008
	Voodoo	035
W	Wards	008, 013, 014, 024, 030, 031, 032, 033
X	XR-1000	008, 032, 033
Y	Yamaha	018, 029
Z	Zenith	008, 025, 026, 027, 043
	ZT Group	035

DVD/VCR Combination

B	Broksonic	056
C	CineVision	058
G	Go Video	048
I	Insignia	059
P	Panasonic	002, 003, 004
S	Samsung	040, 048, 049
	Sony	037, 045, 052, 053, 054
	Sylvania	046
T	Toshiba	039, 050, 057

TV/VCR Combination

R	RCA	051
S	Sylvania	055

TV/DVD/VCR Combination

M	Magnavox	022
P	Panasonic	001
T	Toshiba	047

DEVICE SELECT : SAT/CBL

Satellite Receiver

A	AccessHD	109
	Alpha Digital	109
	Alphastar	083
	Artec	106
C	CaptiveWorks	102
	Channel Master	111
	Chaparral	077
	Coolsat	103
	Coship	114
	Crossdigital	120
D	Digital Stream	110
	DIRECTV	058, 059, 060, 061, 062, 063, 064, 068, 069, 073, 074, 075, 076, 088, 089, 090, 093, 095, 116
	Dish Network	052, 053, 054, 055, 065, 091, 115, 119
	Dishpro	115, 119
	Drake	078
E	Echostar	052, 065, 091, 115, 119
	Expressvu	119
G	GE	056, 057, 112
	General Instrument	079, 117
	GOI	119
	Goodmind	112
H	Hisense	118
	Hitachi	074, 084
	HTS	119
	Hughes Network Systems	060, 062, 067, 068, 070, 075, 093
	Humax	104
I	Ilo	118
	Insignia	096
J	Jerrold	117
	JVC	052, 065, 091, 119
L	Lasonic	113
	LG	096, 105
M	Magnavox	073, 107
	Memorex	073
	MicroGem	108
	Mitsubishi	068, 099
	Motorola	117
N	Next Level	117
P	Panasonic	061, 095, 097

Pansat	100
Paysat	073
PCT	111
Philco	107
Philips	060, 067, 068, 070, 072, 073, 090
Pioneer	060
Primestar	082
Proscan	056, 057
Proton	118
R RadioShack	117
RCA	056, 057, 058, 070, 076, 086, 087, 088, 089, 092
Realistic	080
S Samsung	060, 062, 069, 070, 071, 094
Sharp	098
Sony	059, 066, 116
Star Choice	117
STS	085
T Tivax	109
Tivo	060, 070
Toshiba	063
U UltimateTV	116
Uniden	073, 081
US Digital	118
V Viewsat	101
Voom	117
Z Zenith	064, 096

Cable TV

A ABC	[009]*, 010, 012, 028, 040
Adelphia	007
Americast	047
Antronix	014, 015
Archer	015
AT&T	003
B Bell South	047
C Cable Vision	006
Cabletenna	014
Cableview	013
Clearmaster	046
ClearMax	046
Colour Voice	016
Comcast	000, 005, 033
Comtronics	017
Contec	018
Coolmax	046
COX	005
D Daeryung	036
Director	033
Dumont	051
E Eastern	019

Everquest	041
F Focus	045
G GC Electronics	015
GE	009, 010
Gehua	033
Gemini	020, 041
General Instrument	005, 010, 033, 044
Goldstar	042
H Hamlin	021
Hitachi	010
J Jasco	041
Jerrold	005, 010, 020, 028, 029, 033, 041, 044
L LG	050
M Magnavox	022
MegaCable	005
Memorex	023, 040
Motorola	000, 003, 005, 033, 037, 039, 044
Movie Time	024
Multitech	046
N NEC	011
NET Brazil	035
NSC	024
Oak	018
O Pace	008, 043
Panasonic	026, 027, 040
Paragon	040
Philips	016, 022
Pioneer	002, 030, 036, 042
Popular Mechanics	045
Proscan	009, 010
Pulsar	040
Quasar	040
R RadioShack	041, 046
RCA	013, 027
Realistic	015
Recoton	045
Regal	021
Regency	019
Rembrandt	010
Runco	040
S Samsung	008, 034, 042
Scientific Atlanta	001, 002, 003, 007, 012, 036, 038
Signal	020, 041
Signature	010
Sony	006, 048
Sprucer	027
Standard Component	025
Starcom	020, 028, 041
Stargate	020, 041
Starquest	020, 041

Supercable	044
Supermax	046
T Time Warner	004
Tocom	031
Torx	049
Toshiba	040
Trans PX	044
Tristar	046
TS	049
Tusa	020, 041
TV86	024
U Unika	014, 015
United Cable	028
Universal	014, 015
V V2	046
View Star	018, 022, 024
Viewmaster	046
Vision	046
Vortex View	046
Z Zenith	032, 040, 047
Zentek	045

DEVICE SELECT : CD

CD Player

A Accuphase	018
Acoustic Research	019
ADS	020
Aiwa	021
Akai	022
Audio Alchemy	023
Audio Pro	024
Audio-Technica	025
B B & K	026
C California Audio Labs	036
Carver	040, 041
D Denon	001, 042, [111]*
DKK	035
DMX Electronics	040
Dynamic Bass	041
G GE	017
Genexxa	037
H Harman/Kardon	007
J JVC	003, 011, 012
K Kenwood	038, 039
L Krell	040
L Linn	040
M Magnavox	027
Marantz	028
Miro	035

Mission	040
Musical Fidelity	029
N NEC	030
NSM	040
O Onkyo	002
Optimus	035, 037, 039, 041
P Philips	009, 010
Pioneer	006
Polk Audio	040
Proscan	017
Proton	040
Q QED	040
Quad	040
R RCA	000, 017
Realistic	041
Rotel	040
S SAE	040
Sansui	040
Sanyo	031
SAST	040
Sharp	032
Silsonic	038
Sonic Frontiers	040
Sony	004, 005, 008, 013, 014
Soundesign	033
Symphonic	034
T TAG McLaren	040
Technics	015
W Wards	040
Y Yamaha	016
Z Zonda	040

[]*: Preset codes set upon shipment from the factory.
: Les codes préréglés diffèrent en fonction des livraisons de l'usine.

DVD preset codes / Codes préréglés DVD			
DENON	Modél No. / Modèle numéro	111 (default / défaut)	
		014	
DVD-900	DVD-2900	DVD-800	
DVD-700	DVD-2910	DVD-1600	
DVD-1000	DVD-2930	DVD-2000	
DVD-1400	DVD-3800	DVD-2500	
DVD-1500	DVD-3910	DVD-3000	
DVD-1710	DVD-3930	DVD-3300	
DVD-1720	DVD-A11		
DVD-1730	DVD-A1XV		
DVD-1740	DVD-A1		
DVD-1910			
DVD-1920			
DVD-1930			
DVD-1940			
DVD-2200			
DVD-2800			
DVD-2800II			

Blu-Ray preset codes / Codes préréglés Blu-Ray	
DENON	Modél No. / Modèle numéro
	121
	DVD-1800BD DVD-2500BT DVD-3800BD DVD-A1UDCI

DENON

www.denon.com

D&M Holdings Inc.
Printed in China 5411 10250 005DA