

DENON

AV SURROUND RECEIVER

AVR-3808CI

Owner's Manual

GUI *Graphical User Interface*

Use this manual in combination with the operating guide displayed on the GUI screen.

GUI Menu Operation (👉 page 23)

GUI Menu Map (👉 page 24)

SAFETY PRECAUTIONS

CAUTION
RISK OF ELECTRIC SHOCK
DO NOT OPEN

CAUTION:
TO REDUCE THE RISK OF ELECTRIC SHOCK, DO NOT REMOVE COVER (OR BACK). NO USER-SERVICEABLE PARTS INSIDE. REFER SERVICING TO QUALIFIED SERVICE PERSONNEL.

The lightning flash with arrowhead symbol, within an equilateral triangle, is intended to alert the user to the presence of uninsulated "dangerous voltage" within the product's enclosure that may be of sufficient magnitude to constitute a risk of electric shock to persons.

The exclamation point within an equilateral triangle is intended to alert the user to the presence of important operating and maintenance (servicing) instructions in the literature accompanying the appliance.

WARNING:
TO REDUCE THE RISK OF FIRE OR ELECTRIC SHOCK, DO NOT EXPOSE THIS APPLIANCE TO RAIN OR MOISTURE.

SAFETY INSTRUCTIONS

1. Read Instructions – All the safety and operating instructions should be read before the product is operated.
2. Retain Instructions – The safety and operating instructions should be retained for future reference.
3. Heed Warnings – All warnings on the product and in the operating instructions should be adhered to.
4. Follow Instructions – All operating and use instructions should be followed.
5. Cleaning – Unplug this product from the wall outlet before cleaning. Do not use liquid cleaners or aerosol cleaners.
6. Attachments – Do not use attachments not recommended by the product manufacturer as they may cause hazards.
7. Water and Moisture – Do not use this product near water – for example, near a bath tub, wash bowl, kitchen sink, or laundry tub; in a wet basement; or near a swimming pool; and the like.
8. Accessories – Do not place this product on an unstable cart, stand, tripod, bracket, or table. The product may fall, causing serious injury to a child or adult, and serious damage to the product. Use only with a cart, stand, tripod, bracket, or table recommended by the manufacturer, or sold with the product. Any mounting of the product should follow the manufacturer's instructions, and should use a mounting accessory recommended by the manufacturer.
9. A product and cart combination should be moved with care. Quick stops, excessive force, and uneven surfaces may cause the product and cart combination to overturn.
10. Ventilation – Slots and openings in the cabinet are provided for ventilation and to ensure reliable operation of the product and to protect it from overheating, and these openings must not be blocked or covered. The openings should never be blocked by placing the product on a bed, sofa, rug, or other similar surface. This product should not be placed in a built-in installation such as a bookcase or rack unless proper ventilation is provided or the manufacturer's instructions have been adhered to.
11. Power Sources – This product should be operated only from the type of power source indicated on the marking label. If you are not sure of the type of power supply to your home, consult your product dealer or local power company. For products intended to operate from battery power, or other sources, refer to the operating instructions.
12. Grounding or Polarization – This product may be equipped with a polarized alternating-current line plug (a plug having one blade wider than the other). This plug will fit into the power outlet only one way. This is a safety feature. If you are unable to insert the plug fully into the outlet, try reversing the plug. If the plug should still fail to fit, contact your electrician to replace your obsolete outlet. Do not defeat the safety purpose of the polarized plug.
13. Power-Cord Protection – Power-supply cords should be routed so that they are not likely to be walked on or pinched by items placed upon or against them, paying particular attention to cords at plugs, convenience receptacles, and the point where they exit from the product.
15. Outdoor Antenna Grounding – If an outside antenna or cable system is connected to the product, be sure the antenna or cable system is grounded so as to provide some protection against voltage surges and built-up static charges. Article 810 of the National Electrical Code, ANSI/NFPA 70, provides information with regard to proper grounding of the mast and supporting structure, grounding of the lead-in wire to an antenna discharge unit, size of grounding conductors, location of antenna-discharge unit, connection to grounding electrodes, and requirements for the grounding electrode. See Figure A.
16. Lightning – For added protection for this product during a lightning storm, or when it is left unattended and unused for long periods of time, unplug it from the wall outlet and disconnect the antenna or cable system. This will prevent damage to the product due to lightning and power-line surges.
17. Power Lines – An outside antenna system should not be located in the vicinity of overhead power lines or other electric light or power circuits, or where it can fall into such power lines or circuits. When installing an outside antenna system, extreme care should be taken to keep from touching such power lines or circuits as contact with them might be fatal.
18. Overloading – Do not overload wall outlets, extension cords, or integral convenience receptacles as this can result in a risk of fire or electric shock.
19. Object and Liquid Entry – Never push objects of any kind into this product through openings as they may touch dangerous voltage points or short-out parts that could result in a fire or electric shock. Never spill liquid of any kind on the product.
20. Servicing – Do not attempt to service this product yourself as opening or removing covers may expose you to dangerous voltage or other hazards. Refer all servicing to qualified service personnel.
21. Damage Requiring Service – Unplug this product from the wall outlet and refer servicing to qualified service personnel under the following conditions:
 - a) When the power-supply cord or plug is damaged,
 - b) If liquid has been spilled, or objects have fallen into the product,
 - c) If the product has been exposed to rain or water,
 - d) If the product does not operate normally by following the operating instructions. Adjust only those controls that are covered by the operating instructions as an improper adjustment of other controls may result in damage and will often require extensive work by a qualified technician to restore the product to its normal operation,
 - e) If the product has been dropped or damaged in any way, and
 - f) When the product exhibits a distinct change in performance – this indicates a need for service.
22. Replacement Parts – When replacement parts are required, be sure the service technician has used replacement parts specified by the manufacturer or have the same characteristics as the original part. Unauthorized substitutions may result in fire, electric shock, or other hazards.
23. Safety Check – Upon completion of any service or repairs to this product, ask the service technician to perform safety checks to determine that the product is in proper operating condition.
24. Wall or Ceiling Mounting – The product should be mounted to a wall or ceiling only as recommended by the manufacturer.
25. Heat – The product should be situated away from heat sources such as radiators, heat registers, stoves, or other products (including amplifiers) that produce heat.

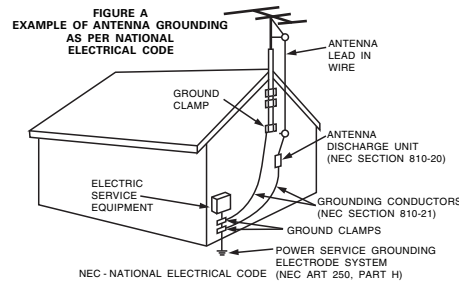

FCC INFORMATION (For US customers)

1. COMPLIANCE INFORMATION

Product Name: AV Surround Receiver
Model Number: AVR-3808CI

This product complies with Part 15 of the FCC Rules. Operation is subject to the following two conditions: (1) this product may not cause harmful interference, and (2) this product must accept any interference received, including interference that may cause undesired operation.

Denon Electronics (USA), LLC
(a D & M Holdings Company)

100 Corporate Drive
Mahwah, NJ 07430-2041
Tel. (800) 497-8921

2. IMPORTANT NOTICE: DO NOT MODIFY THIS PRODUCT

This product, when installed as indicated in the instructions contained in this manual, meets FCC requirements. Modification not expressly approved by DENON may void your authority, granted by the FCC, to use the product.

3. NOTE

This product has been tested and found to comply with the limits for a Class B digital device, pursuant to Part 15 of the FCC Rules. These limits are designed to provide reasonable protection against harmful interference in a residential installation.

This product generates, uses and can radiate radio frequency energy and, if not installed and used in accordance with the instructions, may cause harmful interference to radio communications. However, there is no guarantee that interference will not occur in a particular installation. If this product does cause harmful interference to radio or television reception, which can be determined by turning the product OFF and ON, the user is encouraged to try to correct the interference by one or more of the following measures:

- Reorient or relocate the receiving antenna.
- Increase the separation between the equipment and receiver.
- Connect the product into an outlet on a circuit different from that to which the receiver is connected.
- Consult the local retailer authorized to distribute this type of product or an experienced radio/TV technician for help.

This Class B digital apparatus complies with Canadian ICES-003.

Cet appareil numérique de la classe B est conforme à la norme NMB-003 du Canada.

NOTE ON USE / OBSERVATIONS RELATIVES A L'UTILISATION

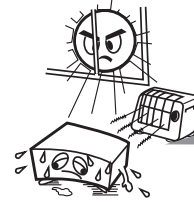

- Avoid high temperatures. Allow for sufficient heat dispersion when installed in a rack.
- Éviter des températures élevées. Tenir compte d'une dispersion de chaleur suffisante lors de l'installation sur une étagère.



- Keep the unit free from moisture, water, and dust.
- Protéger l'appareil contre l'humidité, l'eau et la poussière.



- Do not let foreign objects into the unit.
- Ne pas laisser des objets étrangers dans l'appareil.

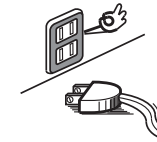

- Handle the power cord carefully. Hold the plug when unplugging the cord.
- Manipuler le cordon d'alimentation avec précaution. Tenir la prise lors du débranchement du cordon.



- Unplug the power cord when not using the unit for long periods of time.
- Débrancher le cordon d'alimentation lorsque l'appareil n'est pas utilisé pendant de longues périodes.

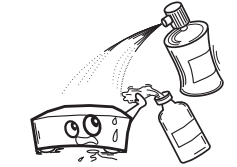

- Do not let insecticides, benzene, and thinner come in contact with the unit.
- Ne pas mettre en contact des insecticides, du benzène et un diluant avec l'appareil.



* (For apparatuses with ventilation holes)

- Do not obstruct the ventilation holes.
- Ne pas obstruer les trous d'aération.

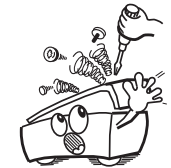

- Never disassemble or modify the unit in any way.
- Ne jamais démonter ou modifier l'appareil d'une manière ou d'une autre.

Contents

Getting Started

Accessories	2
Cautions on Handling	3
Cautions on Installation	3
About the Remote Control Unit	3
Inserting the Batteries	3
Operating Range of the Remote Control Unit	3
Part Names and Functions	4
Front Panel	4
Display	4
Rear Panel	5
Remote Control Unit	6

Connections

Preparations	7
Cables Used for Connections	7
Video Conversion Function	8
Speaker Connections	9
Speaker Installation	9
Speaker Connections	9, 10
Connecting Equipment with HDMI connectors	11
Connecting the Monitor	12
Connecting the Playback Components	12
DVD Player	12
Record Player	13
CD Player	13
iPod®	13
TV/CABLE Tuner	14
Satellite Receiver	14
Connecting the Recording Components	15
Digital Video Recorder	15
Video Cassette Recorder	15
CD Recorder / MD Recorder / Tape Deck	16
Connections to Other Devices	16
Components Equipped with a DENON LINK connector	16
Video Camera / Game Console	17
Component with Multi-channel Output connectors	17
External Power Amplifier	17
USB Port	18
XM connector	18
Antenna terminals	19
Network Audio	20
Multi Zone	21
External Controller	21
Connecting the Power Cord	22
Once Connections are Completed	22

GUI Menu Operations

Example of the Display of the GUI Mark at a Title	23
Example of Display of Default Values	23
Examples of GUI Screen Displays	23
Example: Browse Menu (Top Menu)	23
Example: Menu with Illustrations (Auto Setup)	23
Cursor Position Display	23
Operations	23
GUI Menu Map	24

Auto Setup

Preparations	25
Auto Setup	26
1 Auto Setup	26
Error Messages	27
2 Option	27
3 Parameter Check	27

Manual Setup

Speaker Setup	28
1 Speaker Configuration	28
2 Subwoofer Mode	28
3 Distance	28
4 Channel Level	29
5 Crossover Frequency	29
6 Surround Speaker	29
HDMI Setup	30
1 i/p Scaler	30
2 Resolution	30
3 Progressive Mode	30
4 Aspect	30
5 Color Space	30
6 RGB Range	30
7 Auto Lip Sync	30
8 Audio	30
Audio Setup	30
1 EXT. IN Setup	30
2 2ch Direct/Stereo	31
3 Downmix Option	31
4 Auto Surround Mode	31
5 Manual EQ	31
Network Setup	31
1 Network Setup	32
2 Other	32
3 Network Information	32
Zone Setup	33
1 ZONE2	33
2 ZONE3	33
Option Setup	33
1 Amp Assign	33
2 Volume Control	34

3 Source Delete	34
4 GUI	34
5 Quick Select Name	34
6 Trigger Out 1	35
7 Trigger Out 2	35
8 Remote ID	35
9 2Way Remote	35
10 Dimmer	35
11 Setup Lock	35
12 Maintenance Mode	35
13 Firmware Update	36
Language	36

Source Select

Input Source Selection	36, 37
Settings Related to Playing Input Sources	37
1 Play	37
2 Auto Preset	37
3 Preset Skip	37
4 Preset Name	37
5 Input Mode	37, 38
6 Rename	38
7 Other	38
8 Playback Mode (iPod)	38
9 Assign	39
10 Playback Mode	39
11 Antenna Aiming	40

Surround Modes

Standard Playback	40
Surround Playback of 2-channel Sources	40
Playing Multi-channel Sources (Dolby Digital, DTS, etc.)	40
DSP Simulation Playback	41
Stereo Playback	41
Direct Playback	41
Playback in the Pure Direct Mode	41

Parameter

Audio	41
1 Surround Parameters	41 ~ 43
2 Tone	43
3 Room EQ	43
4 RESTORER	43
5 Night Mode	44
6 Audio Delay	44
Picture Adjust	44
1 Contrast	44
2 Brightness	44
3 Chroma Level	44
4 Hue	44

Information	
Status	44
1 MAIN ZONE	44
2 ZONE2/3	44
Audio Input Signal	45
HDMI Information	45
1 Signal Information	45
2 Monitor	45
Auto Surround	45
Quick Select	45
Preset Station	45

Playback	
Preparations	46
Turning the Power On	46
Operations During Playback	46
Playing Video and Audio Equipment	46
Listening to FM/AM Broadcasts	47
Basic Operation	47
Presetting Radio Stations (Preset Memory)	47
Listening to Preset Stations	48
Listening to XM Satellite Radio Programs	48
Basic Operation	48
Checking the XM Signal Strength and Radio ID	49
Searching Categories	49
Accessing XM Radio Stations Directly	49
iPod® Playback	50
Basic Operation	50
Listening to Music	50
Viewing Still Pictures or Videos on the iPod	50
Playing Network Audio or USB Memory Devices	51
Basic Operation	52
Listening to Internet Radio	52, 53
Presetting Internet Radio Stations	53
Registering Internet Radio Stations as Your Favorites	53
Playing Files Stored on a Computer	54
Playing Files Stored on USB Memory Devices	54
Operating the AVR-3808CI Using a Browser (Web control)	55

Other Operations and Functions	
Other Operations	55
Playing Super Audio CDs	55
Recording on an External Device (REC OUT mode)	56
Convenient Functions	56
Channel Level	56
Fader Function	56
Quick Select Function	57
Personal Memory Plus Function	57
Last Function Memory	57
Backup Memory	57
Resetting the Microprocessor	58

Remote Control Unit Operations	
Main Remote Control Unit	59
Operating DENON Audio Components	59
Presetting	59
Operating Preset Components	59 ~ 61
Setting the Remote ID	62
Learning Function	62
System Call Function	63
Punch Through Function	63
Setting the Time the Backlight Stays Lit	63
Adjusting the Backlight's Brightness	64
Resetting the Main Remote Control Unit	64
Sub Remote Control Unit Operations	65, 66
Switching Zones	67
Setting the Zone for Which the Sub Remote Control Unit is Used (ZONE SELECT LOCK Mode)	67
Setting the Remote ID	67
Resetting the Settings	67

Amp Assign / Multi Zone Connections and Operations	
Multi-Zone Settings with the Amp Assign Function	68, 69
Multi-Zone Settings and Operations with Zone Pre-out Output	70
Multi-Zone Operations	71
Turning the Power On and Off	71
Selecting the Input Source	71
Adjusting the Volume	71
Turning off the Sound Temporarily	71

Other Information	72 ~ 81
-------------------	---------

Troubleshooting	82 ~ 85
-----------------	---------

Specifications	86
----------------	----

List of preset codes End of this manual

Getting Started

Thank you for purchasing this DENON product. To ensure proper operation, please read this owner's manual carefully before using the product.
After reading them, be sure to keep them for future reference.

Accessories

Check that the following parts are supplied with the product.

- | | |
|---|---|
| ① Owner's manual | 1 |
| ② Warranty (for North America model only) | 1 |
| ③ Service station list | 1 |
| ④ Power cord (Cord length: Approx. 5 ft / 1.5 m) | 1 |
| ⑤ Main remote control (RC-1068) | 1 |
| ⑥ LR6/AA batteries (for RC-1068) | 2 |
| ⑦ Sub remote control (RC-1070) | 1 |
| ⑧ R03/AAA batteries (for RC-1070) | 2 |
| ⑨ FM indoor antenna | 1 |
| ⑩ AM loop antenna | 1 |
| ⑪ Setup microphone (Cord length: Approx. 25 ft / 7.6 m) | 1 |

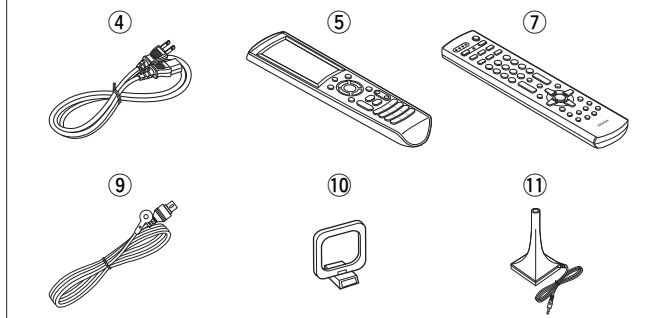

Cautions on Handling

• Before turning the power switch on

Check once again that all connections are correct and that there are no problems with the connection cables.

- Power is supplied to some of the circuitry even when the unit is set to the standby mode. When traveling or leaving home for long periods of time, be sure to unplug the power cord from the power outlet.

• About condensation

If there is a major difference in temperature between the inside of the unit and the surroundings, condensation (dew) may form on the operating parts inside the unit, causing the unit not to operate properly.

If this happens, let the unit sit for an hour or two with the power turned off and wait until there is little difference in temperature before using the unit.

• Cautions on using mobile phones

Using a mobile phone near this unit may result in noise. If so, move the mobile phone away from this unit when it is in use.

• Moving the unit

Turn off the power and unplug the power cord from the power outlet.

Next, disconnect the connection cables to other system units before moving the unit.

- Note that the illustrations in these instructions may differ from the actual unit for explanation purposes.

Cautions on Installation

Note:

For proper heat dispersal, do not install this unit in a confined space, such as a bookcase or similar enclosure.

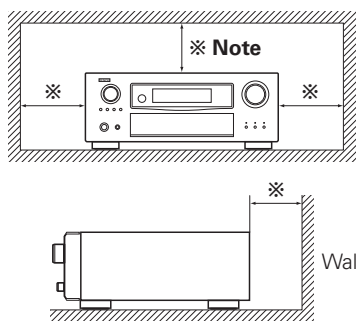

About the Remote Control Unit

In addition to the AVR-3808CI, the included main remote control unit (RC-1068) can also be used to operate the equipment listed below.

- ① DENON system components
- ② Non-DENON system components
 - By setting the preset memory (page 59 ~ 61)
 - By using the learn function (page 62)

Inserting the Batteries

- ① Lift the clasp and remove the rear lid.

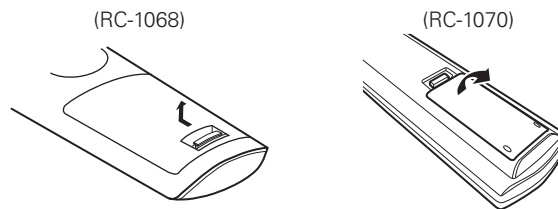

- ② Load the two batteries properly as indicated by the marks in the battery compartment.

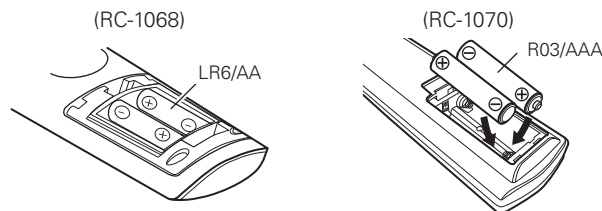

- ③ Put the rear cover back on.

NOTE

- Replace the batteries with new ones if the set does not operate even when the remote control unit is operated close to the unit.
- The supplied batteries are only for verifying operation.
- When inserting the batteries, be sure to do so in the proper direction, following the “⊕” and “⊖” marks in the battery compartment.
- To prevent damage or leakage of battery fluid:
 - Do not use a new battery together with an old one.
 - Do not use two different types of batteries.
 - Do not attempt to charge dry batteries.
 - Do not short-circuit, disassemble, heat or dispose of batteries in flames.
- If the battery fluid should leak, carefully wipe the fluid off the inside of the battery compartment and insert new batteries.
- Remove the batteries from the remote control unit if it will not be in use for long periods.
- When replacing the batteries, have the new batteries ready and insert them as quickly as possible.

Operating Range of the Remote Control Unit

Point the remote control unit at the remote sensor when operating it.

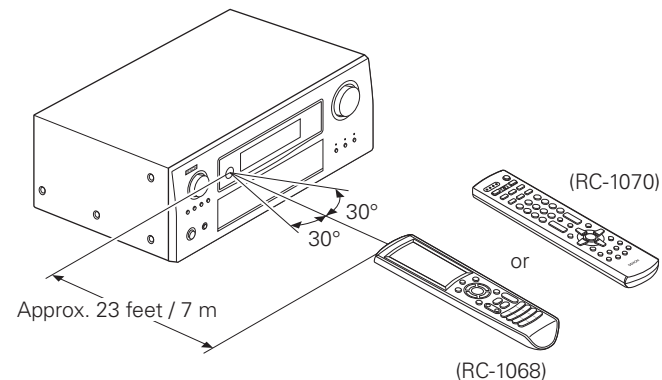

NOTE

The set may function improperly or the remote control unit may not operate if the remote control sensor is exposed to direct sunlight, strong artificial light from an inverter type fluorescent lamp or infrared light.

Part Names and Functions

For buttons not explained here, see the page indicated in parentheses ().

Front Panel

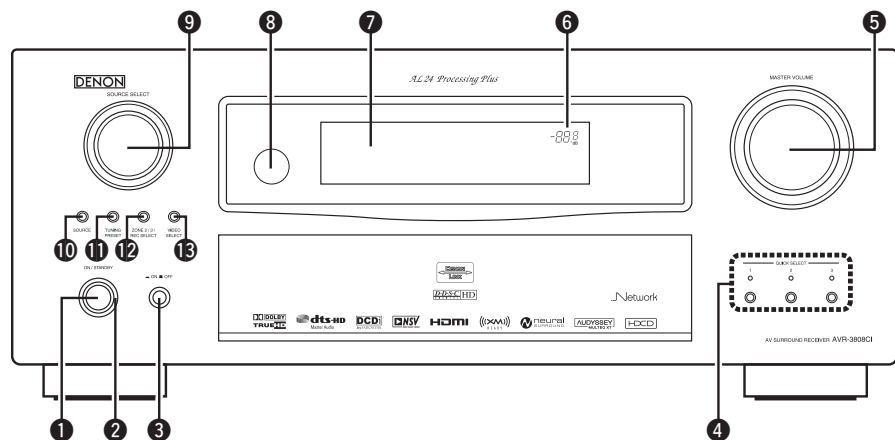

With the door open

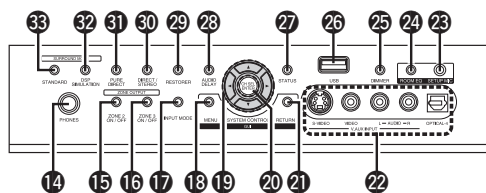

- 1 Power operation button (ON/STANDBY) (46)
- 2 Power indicator (46)
- 3 Power switch (ON OFF) (46)
- 4 QUICK SELECT buttons / indicators (57)
- 5 MASTER VOLUME control knob (46)
- 6 Master volume indicator
- 7 Display

- 8 Remote control sensor (3)
- 9 SOURCE SELECT knob (36)
- 10 SOURCE button (36)
- 11 TUNING PRESET button (48)
- 12 ZONE2/3 / REC SELECT button (56, 71)
- 13 VIDEO SELECT button (38)
- 14 Headphones jack (PHONES) (46)
- 15 ZONE2 ON/OFF button (71)
- 16 ZONE3 ON/OFF button (71)
- 17 INPUT MODE button (38)
- 18 MENU button (23)
- 19 Cursor buttons (Δ ▽ ◀ ▶) (23)
- 20 CH SEL / ENTER button (23, 56)
- 21 RETURN button (23)
- 22 V.AUX INPUT connectors (17)
- 23 SETUP MIC jack (25)
- 24 ROOM EQ button (43)
- 25 DIMMER button (35)

- 26 USB port (18)
- 27 STATUS button (45)
- 28 AUDIO DELAY button (44)
- 29 RESTORER button (43)
- 30 DIRECT/STEREO button (41)
- 31 PURE DIRECT button (41)
- 32 DSP SIMULATION button (41)
- 33 STANDARD button (40)

Display

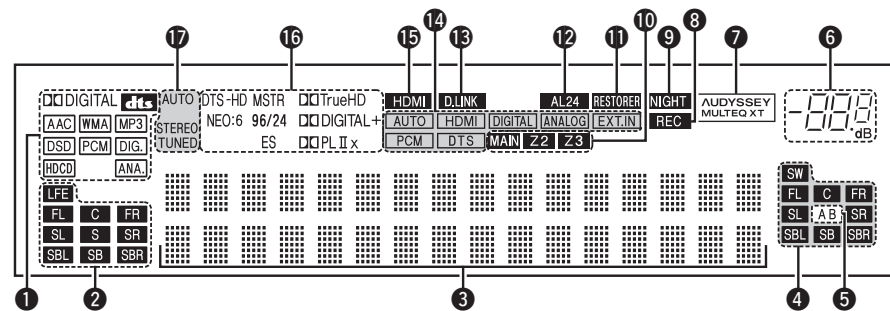

- 1 Input signal indicators
- 2 Input signal channel indicators
These light when digital signals are input.
- 3 Information display
The input source name, surround mode, setting values and other information are displayed here.
- 4 Output signal channel indicators
- 5 Surround speaker indicators
These light according to the settings of the surround A and B speakers.
- 6 Master volume indicator
- 7 AUDYSSEY MULTEQ XT indicator
This lights when the room equalizer is selected.
- 8 Recording output source indicator
This lights when the REC OUT mode is selected.
- 9 NIGHT indicator
This lights when the night mode is selected.
- 10 Multi zone indicators
These light when the power for the respective zone is turned on.
- 11 RESTORER indicator
This lights when the RESTORER mode is selected.
- 12 AL24 indicator
This lights when AL24 Processing Plus is activated (page 74).
- 13 D.LINK indicator
This lights when playing using DENON LINK connections.
- 14 Input mode indicators
- 15 HDMI indicator
This lights when playing using HDMI connections.
- 16 Decoder indicators
These light when the respective decoders are operating.
- 17 Tuner reception mode indicators
These light according to the reception conditions when the input source is set to "TUNER":
 - AUTO
These light when in the auto tuning mode.
 - STEREO
In the FM mode, these light when receiving analog stereo broadcasts.
 - TUNED
Lights when the broadcast is properly tuned in.

Rear Panel

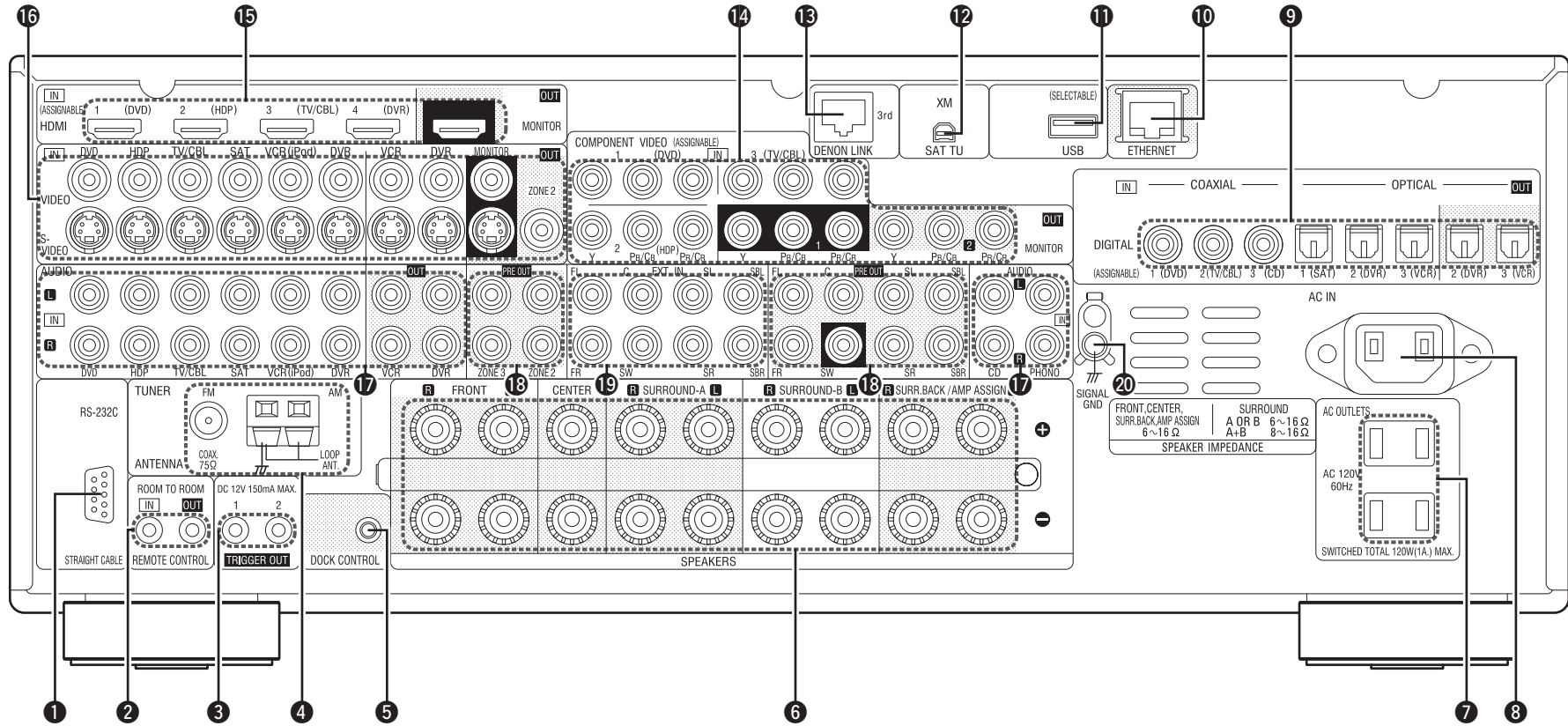

- 1 RS-232C connector (21)
- 2 REMOTE CONTROL jacks (21)
- 3 TRIGGER OUT jacks (21)
- 4 FM/AM antenna terminals (TUNER ANTENNA) (19)
- 5 DOCK CONTROL jack (13)
- 6 Speaker terminals (SPEAKERS) (9)
- 7 AC OUTLETS (22)
- 8 AC inlet (AC IN) (22)
- 9 Digital audio connectors (OPTICAL / COAXIAL) (12, 14)
- 10 ETHERNET connector (20)
- 11 USB port (18)
- 12 XM connector (SAT TU) (18)
- 13 DENON LINK connector (16)
- 14 COMPONENT VIDEO connectors (12)
- 15 HDMI connectors (11)
- 16 VIDEO / S-VIDEO connectors (12)
- 17 Analog audio connectors (AUDIO) (12)
- 18 PRE OUT connectors (17, 21)
- 19 EXT. IN connectors (17)
- 20 SIGNAL GND terminal (13)

Remote Control Unit

□ Main remote control unit (RC-1068)

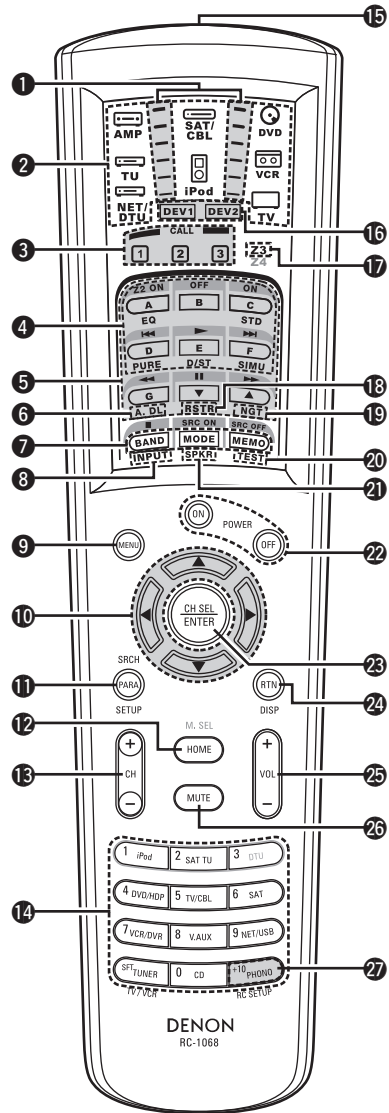

- 1 Signal transmission indicator (59)
- 2 Mode select buttons (59)
- 3 Quick select / System call buttons (57, 63)
- 4 Surround mode buttons (40, 41)
- 5 System buttons (60, 61)
- 6 Audio delay button (A. DL) (44)
- 7 Tuner system buttons (47)
- 8 Input mode button (INPUT) (38)
- 9 MENU button (23)
- 10 Cursor buttons (Δ▽◀▶) (23)
- 11 Parameter / Search button (PARA / SRCH) (41, 49, 50)
- 12 HOME button (59)
- 13 Channel buttons (CH) (47)
- 14 Input source select / Number buttons .. (36, 47)
- 15 Remote control signal transmitter (3)
- 16 Device select indicators (DEV1 / DEV2) ... (59)
- 17 ZONE3 select indicators (Z3) (71)
- 18 RESTORER button (RSTR) (43)
- 19 Night button (NGT) (44)
- 20 Test tone button (TEST) (29)
- 21 Surround speaker select button (SPKR) ... (29)
- 22 POWER buttons (46)
- 23 Channel select (CH SEL) / ENTER button (23, 56)
- 24 Return button (RTN) (23)
- 25 Master volume control buttons (VOL) (46)
- 26 Muting button (MUTE) (46, 71)
- 27 Main remote control unit setup button (RC SETUP) (59)



The time for which the backlight stays on can be changed (page 63 "Setting the Time the Backlight Stays Lit").

NOTE

- The **M. SEL**, **DTU** buttons cannot be used.
- The ZONE2 mode **QUICK SELECT (1 ~ 3)**, **A.DL**, **RSTR**, **NGT**, **INPUT**, **SPKR**, **TEST** and surround mode buttons cannot be used.
- The ZONE4 mode cannot be used.

□ Sub remote control unit (RC-1070)

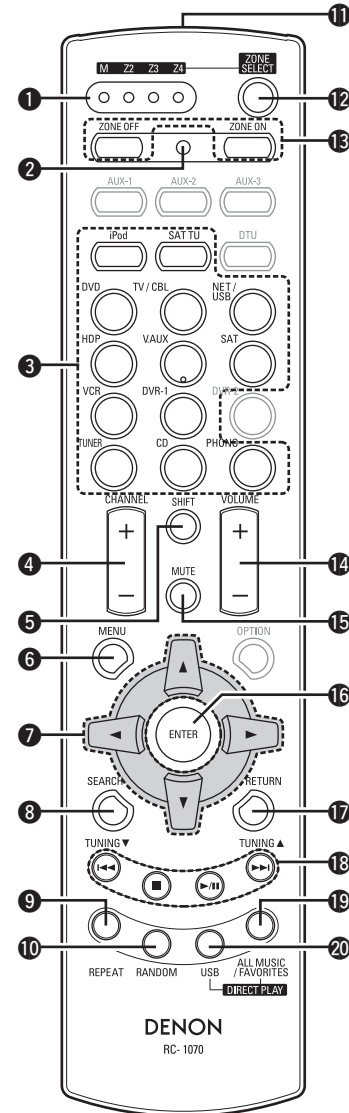

- 1 ZONE indicators (67)
- 2 Advanced setup button (67)
- 3 Input source select buttons (36)
- 4 CHANNEL buttons (47)
- 5 SHIFT button (47)
- 6 MENU button (23)
- 7 Cursor buttons (Δ▽◀▶) (23)
- 8 SEARCH button (49, 50)
- 9 REPEAT button (50)
- 10 RANDOM button (50)
- 11 Remote control signal transmitter (3)
- 12 ZONE SELECT button (67)
- 13 Zone power on/off buttons (ZONE ON / ZONE OFF) (71)
- 14 Master volume control buttons (VOLUME) (65, 66)
- 15 Muting button (MUTE) (46, 71)
- 16 ENTER button (23)
- 17 RETURN button (23)
- 18 System buttons (47, 65)
- 19 ALL MUSIC/FAVORITES (DIRECT PLAY) button (65)
- 20 USB (DIRECT PLAY) button (65)

NOTE

The **AUX-1**, **AUX-2**, **AUX-3**, **DTU**, **DVR-2** and **OPTION** buttons cannot be used.

Connections

Connections for all compatible audio and video signal formats are described in these operating instructions. Please select the types of connections suited for the equipment you are connecting. With some types of connections, certain settings must be made on the AVR-3808CI. For details, refer to the instructions for the respective connection items below.















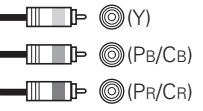

NOTE

- Do not plug in the power cord until all connections have been completed.
- When making connections, also refer to the operating instructions of the other components.
- Be sure to connect the left and right channels properly (left with left, right with right).
- Do not bundle power cords together with connection cables. Doing so can result in humming or noise.

Preparations

Cables Used for Connections

Select the cables according to the equipment being connected.

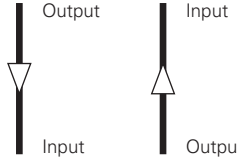
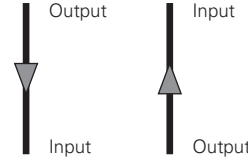
Audio cables	Video cables
<p>Coaxial digital connections</p> <p>(Orange)  Coaxial digital (75 Ω/ohms pin-plug) cable</p> <p>Optical digital connections</p> <p> Optical cable</p> <p>Analog connections (stereo)</p> <p>(White)  (Red)  Stereo pin-plug cable</p> <p>Analog connections (monaural, for subwoofer)</p> <p>(Black)  Pin-plug cable</p> <p>DENON LINK connections</p> <p> DENON LINK cable</p> <p>Speaker connections</p> <p> Speaker cables</p> <p>Network connections</p> <p> Ethernet cable</p>	<p>Component video connections</p> <p>(Green)  (Y)  (Blue)  (PB/CB)  (Red)  (PR/CR)  Component video cable</p> <p>S-Video connections</p> <p> S-Video cable</p> <p>Video connections</p> <p>(Yellow)  75 Ω/ohms pin-plug video cable</p>
Audio and video cables	
<p>HDMI connections</p> <p> 19-pin HDMI cable</p>	
Signal direction	
<p>Audio signal:  Video signal: </p>	

Video Conversion Function

- This function automatically converts various formats of video signals input to the AVR-3808CI into the format used to output the video signals from the AVR-3808CI to a monitor.
- The AVR-3808CI's video input/output circuitry is compatible with the following four types of video signals:

Digital video signals: HDMI

Analog video signals: Component video, S-Video and Video

Flow of video signals inside the AVR-3808CI

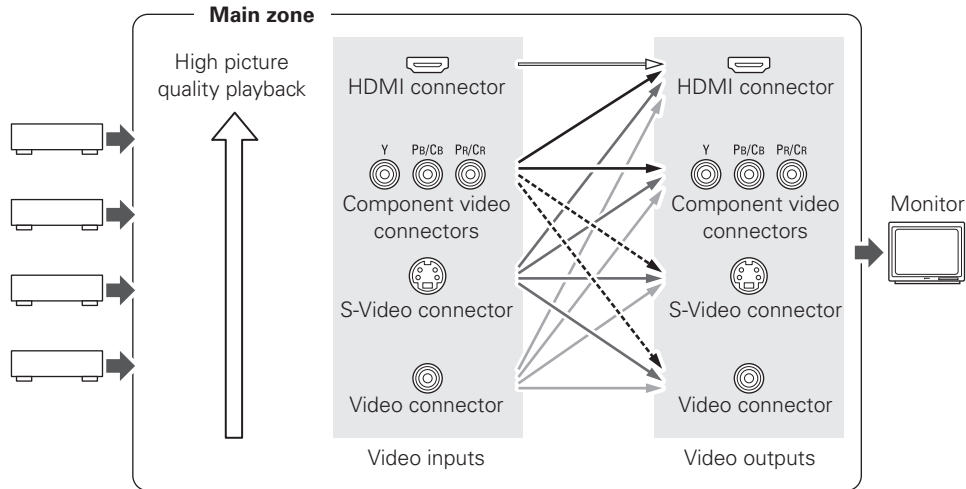

----- : When 480i/576i signals are input in the main zone

Flow of video signals for ZONE2G

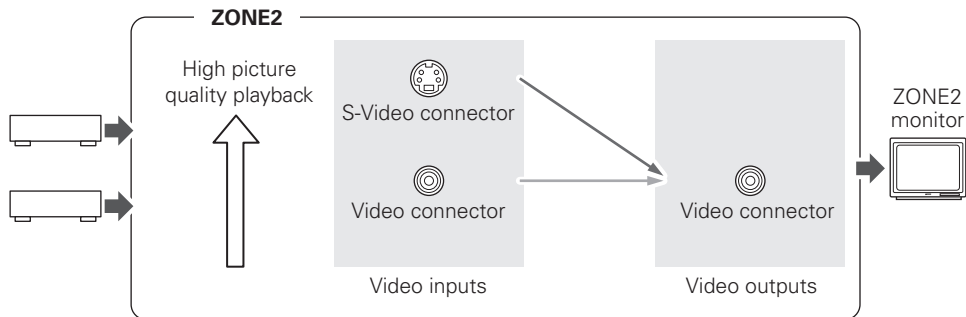

- When not using this function, connect a monitor output with the same type of connector as the video input connector.
- The resolution of the HDMI input-compatible monitor connected to the AVR-3808CI can be checked at GUI menu "Information" – "HDMI Information" – "Monitor" (☞ page 45).

NOTE

- HDMI signals cannot be converted into analog signals.
- 1080p component input video signals cannot be output to anything other than component video connectors.
- 480p/576p, 1080i and 720p component video input signals cannot be converted into S-Video or Video format.
- When a non-standard video signal from a game machine or some other source is input, the video conversion function might not operate.

Speaker Connections

Speaker Installation

The illustration below shows a basic example of installation of the amplifier combined with 8 speakers and a monitor.

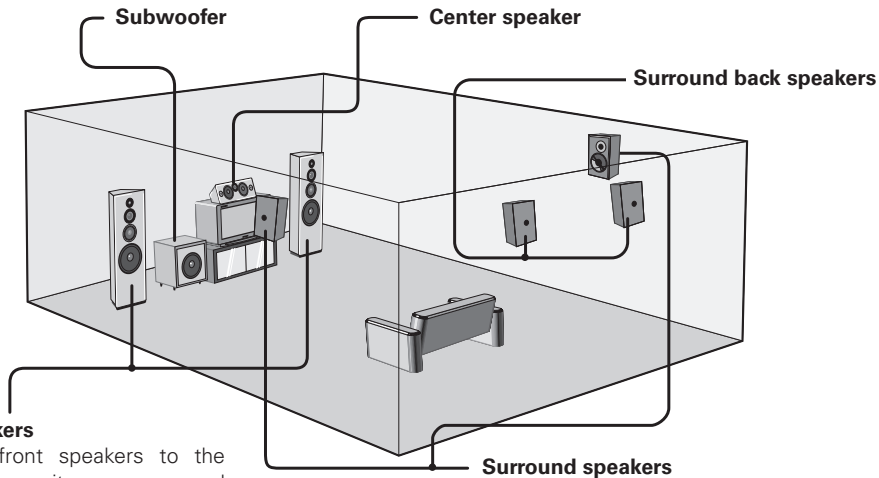

Front speakers

Place the front speakers to the sides of the monitor or screen and as flush with the screen surface as possible.



The table below shows a typical speaker configuration for the AVR-3808CI.

	Front		Center	Surround A		Surround B		Surround back			Subwoofer
	L	R		L	R	L	R	L	R	1 only	
7.1-channels (Surround A+B)	○	○	○	○	○	○	○	○	○	○	○
7.1-channels	○	○	○	○	○	-	-	○	○	-	○
6.1-channels	○	○	○	○	○	-	-	-	-	○	○
5.1-channels	○	○	○	○	○	-	-	-	-	-	○
3.1-channels	○	○	○	-	-	-	-	-	-	-	○
2.1-channels	○	○	-	-	-	-	-	-	-	-	○
2-channels	○	○	-	-	-	-	-	-	-	-	-

Speaker Connections

Example: 5.1-channels (Surround A+B) and ZONE2 use

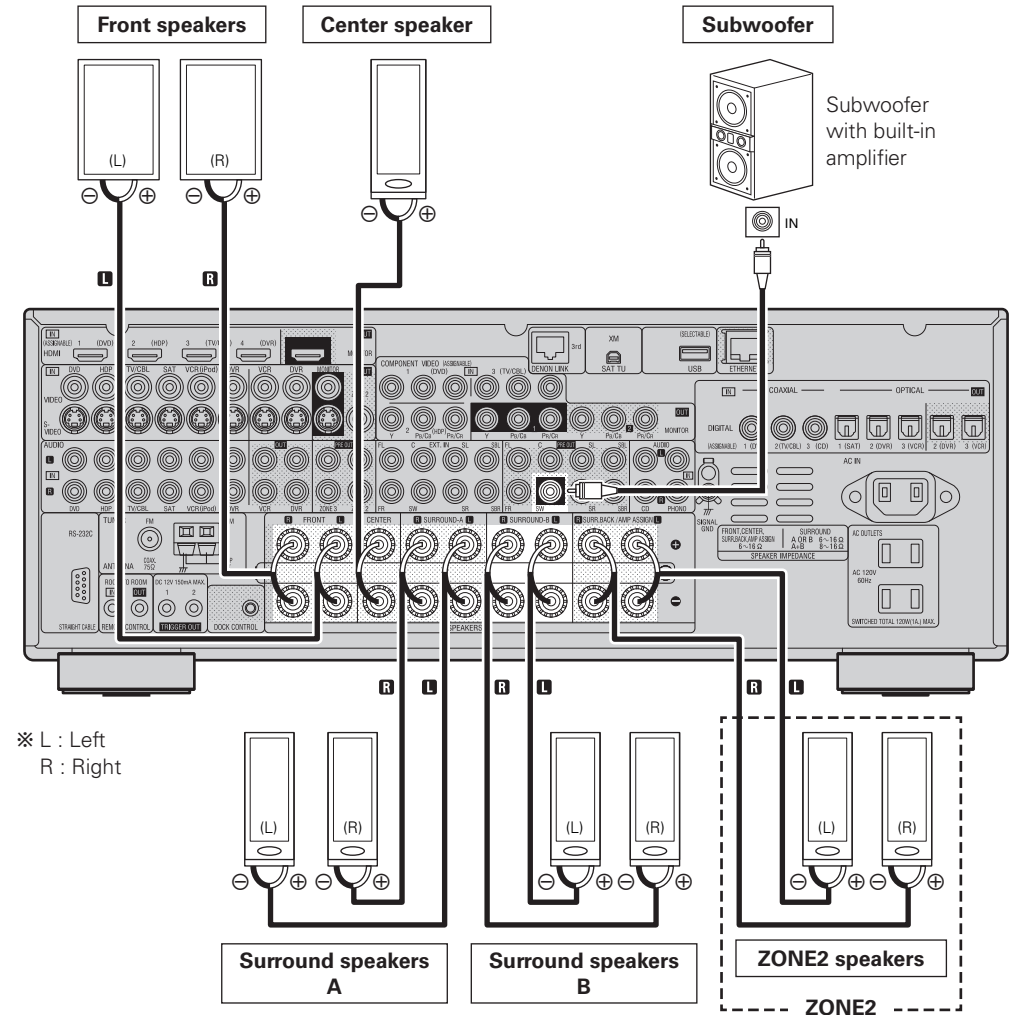

※ L : Left
R : Right



When using just one surround back speaker, connect it to the left channel (SBL).

NOTE

By default, the AVR-3808CI's "Amp Assign" setting is set to "ZONE2." To use as the surround back speaker for the main zone, change the "Amp Assign" setting (page 68, 69).

Connecting the Speaker Cables

Carefully check the left (L) and right (R) channels and + (red) and – (black) polarities on the speakers being connected to the AVR-3808CI, and be sure to interconnect the channels and polarities correctly.

1 Peel off about 0.03 ft/10 mm of sheathing from the tip of the speaker cable, then either twist the core wire tightly or terminate it.



2 Turn the speaker terminal counterclockwise to loosen it.

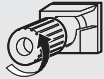

3 Insert the speaker cable's core wire to the hilt into the speaker terminal.



4 Turn the speaker terminal clockwise to tighten it.

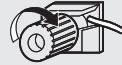

When using a banana plug

Tighten the speaker terminal firmly before inserting the banana plug.

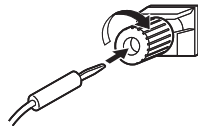

NOTE

- Use speakers with an impedance of 6 to 16 Ω /ohms. When using surround A and B speakers simultaneously, use speakers with an impedance of 8 to 16 Ω /ohms.
- Connect the speaker cables in such a way that they do not stick out of the speaker terminals. The protection circuit may be activated if the core wires touch the rear panel or if the + and – sides touch each other (☞ "Protection circuit").
- Never touch the speaker terminals while the power supply is connected. Doing so could result in electric shock.

Protection circuit

If speakers with an impedance lower than specified (for example 4 Ω /ohms speakers) are used for an extended period of time with the volume turned up high, the temperature may rise, activating the protection circuit.

When the protection circuit is activated, the speaker output is shut off and the power indicator flashes red. If this happens, unplug the power cord, then check the speaker cable and input cable connections. If the set is extremely hot, wait for it to cool off and improve ventilation around it. Once this is done, plug the power cord back in and turn the set's power back on.

If the protection circuit is activated again even though there are no problems in the ventilation around the set nor in the connections, the set may be damaged. Turn the power off, then contact a DENON service center.

Connecting Equipment with HDMI connectors

With HDMI connections, the video and audio signals can be transferred with a single cable.

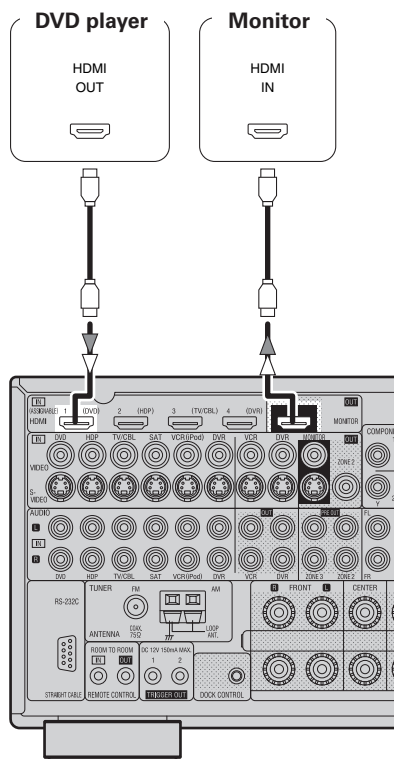

- ※ The AVR-3808CI is equipped for HDMI version 1.3a. This version is compatible with other versions, allowing connection to all components equipped with an HDMI connector.
- ※ The AVR-3808CI is compatible with 30- and 36-bit Deep Color.

Compatible audio format	Details	Discs (examples)
2-channel linear PCM	2ch 32-192 kHz 16/20/24 bits	CD, DVD-Video, DVD-Audio
Multi-channel linear PCM	8ch 32-192 kHz 16/20/24 bits	DVD-Audio
Dolby Digital, DTS	Bitstream	DVD-Video
DSD	2/5.1ch 2.8224 MHz 1 bit	SACD
Dolby Digital Plus, Dolby TrueHD, DTS-HD	Bitstream	HD DVD, Blu-ray Disc

Copyright protection system (HDCP)

In order to play the digital video and audio signals of a DVD-Video or DVD-Audio disc using HDMI/DVI connections, both the connected DVD player and monitor must be equipped for a copyright protection system called "HDCP" (High-bandwidth Digital Content Protection). HDCP is a copy protection technology consisting of data encoding and mutual identification of the devices. The AVR-3808CI is HDCP-compatible. For details on the DVD player or monitor you are using, refer to its operating instructions.

NOTE

- Use a CPPM-compatible DVD player to play DVD-Audio discs that are copyright-protected by CPPM.
- The AVR-3808CI cannot be controlled from another device via the HDMI cable.
- The audio signals output from the HDMI connector (sampling frequency, bit rate, etc.) may be restricted by the connected device.
- Video signals are not output properly when using devices that are not HDCP-compatible.
- Video signals are not output if the input video signals do not match the monitor's resolution. In this case, switch the DVD player's resolution to a resolution with which the monitor is compatible.
- If the GUI menu "Manual Setup" – "HDMI Setup" – "Audio" setting (page 30) is set to "Amp", the sound may be interrupted when the monitor's power is turned off.
- Use a cable on which the HDMI logo is indicated (a certified HDMI product) for connection to the HDMI connector. Normal playback may not be possible when using a cable other than one on which the HDMI logo is indicated (a non-HDMI-certified product).
- If the monitor or DVD player does not support deep color, deep color signal transfer is not possible.
- If the monitor or DVD player does not support xvYCC, xvYCC signal transfer is not possible.
- If the monitor does not support "Auto Lipsync Correction" function, this function will not work.



- When the AVR-3808CI and DVD player are connected using an HDMI cable, also connect the AVR-3808CI and monitor using an HDMI cable.
- If the connected monitor or DVD player only has a DVI-D connector, use an HDMI/DVI converter cable. When using a DVI cable, no audio signals are transmitted.
- Use a Deep Color compatible cable for connection to Deep Color compatible devices.

When connecting with an HDMI/DVI converter cable (adapter)

- HDMI video signals are theoretically compatible with the DVI format. When connecting to a monitor, etc., equipped with a DVI-D connector, connection is possible using an HDMI/DVI converter cable, but depending on the combination of components in some cases the video signals will not be output.
- When connecting using an HDMI/DVI converter adapter, the video signals may not be output properly due to poor connections with the connected cable, etc.



- By default, the HDMI audio signals are output from the speakers connected to the AVR-3808CI.
- To output the sound from the TV, make the settings at GUI menu "Manual Setup" – "HDMI Setup" – "Audio" – "TV" (page 30).

Connecting the Monitor

- Connect the cables to be used (☞ page 8 “Video Conversion Function”).
- With HDMI connections, the video and audio signals can be transferred with a single cable.
- To output the audio signals to the monitor with HDMI connections, set GUI menu “Manual Setup” – “HDMI Setup” – “Audio” to “TV” (☞ page 30).

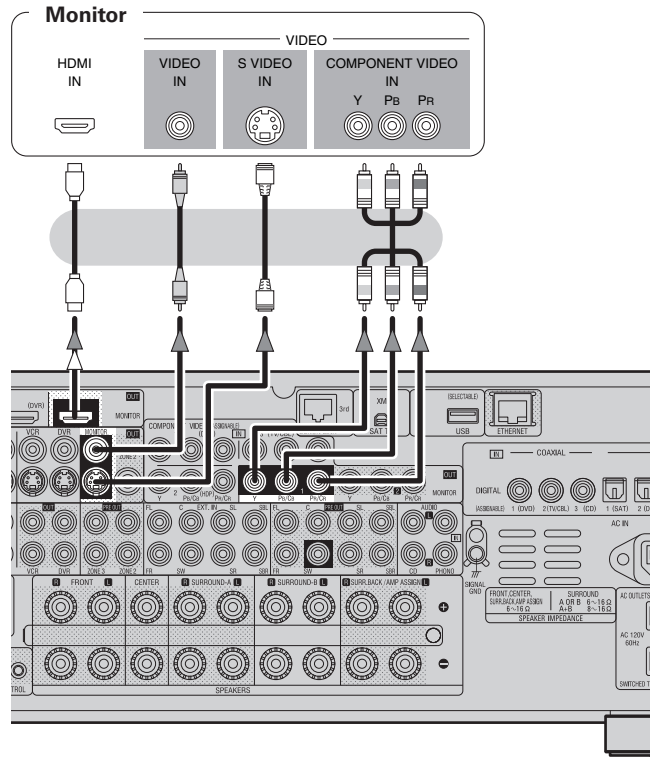

NOTE

- The component video connectors may be indicated differently on your monitor. For details, see the monitor’s operating instructions.
- The audio signals output from the HDMI connectors are only the HDMI input signals.

Connecting the Playback Components

Carefully check the left (L) and right (R) channels and the inputs and outputs, and be sure to interconnect correctly.

DVD Player

- Connect the cables to be used.
- With HDMI connections, the video and audio signals can be transferred with a single cable.

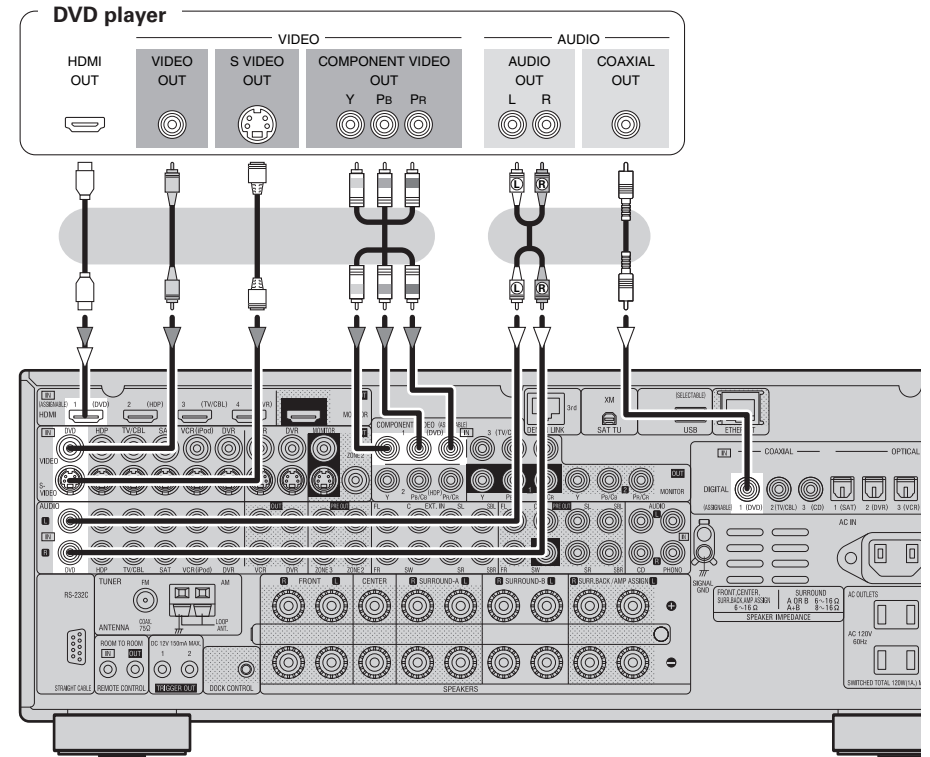

- Connect an HDP (High-Definition Player) in the same way.
- When using an optical cable for the digital audio connection, make the settings at GUI menu “Source Select” – “DVD” – “Assign” – “Digital” (☞ page 39).

Record Player

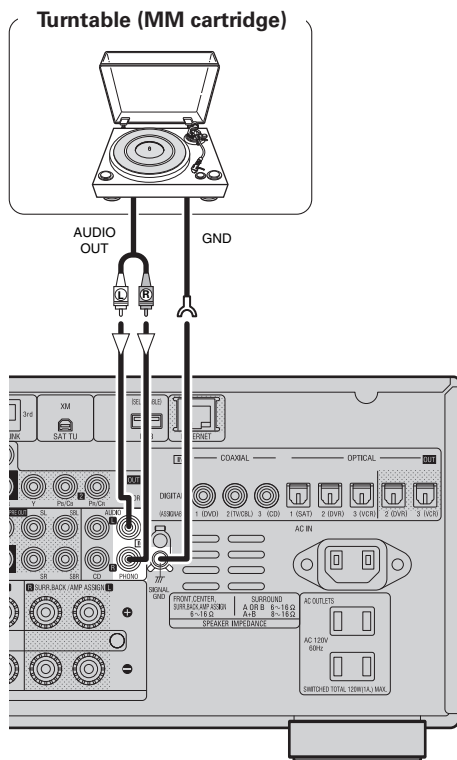

- When connecting a record player with an MC cartridge, use a commercially available MC head amplifier or a step-up transformer.
- Induction humming (a booming sound) may be produced from the speakers if the volume is raised with no record player connected.
- With some record players, noise may be generated when the ground wire is connected. If so, disconnect the ground wire.

NOTE

The AVR-3808CI's SIGNAL GND terminal is meant to reduce noise when a record player is connected. This is not a safety ground terminal.

CD Player

Connect the cables to be used.

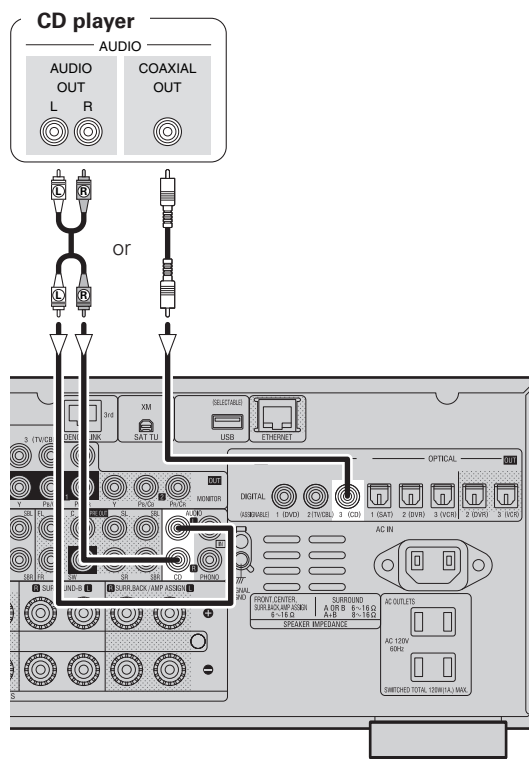

When using an optical cable for the digital audio connection, make the settings at GUI menu "Source Select" – "CD" – "Assign" – "Digital" (page 39).

iPod®

Use a DENON Control Dock for iPod (ASD-1R, sold separately) to connect the iPod to the AVR-3808CI. For instructions on the Control Dock for iPod settings, refer to the Control Dock for iPod's operating instructions.

Example :

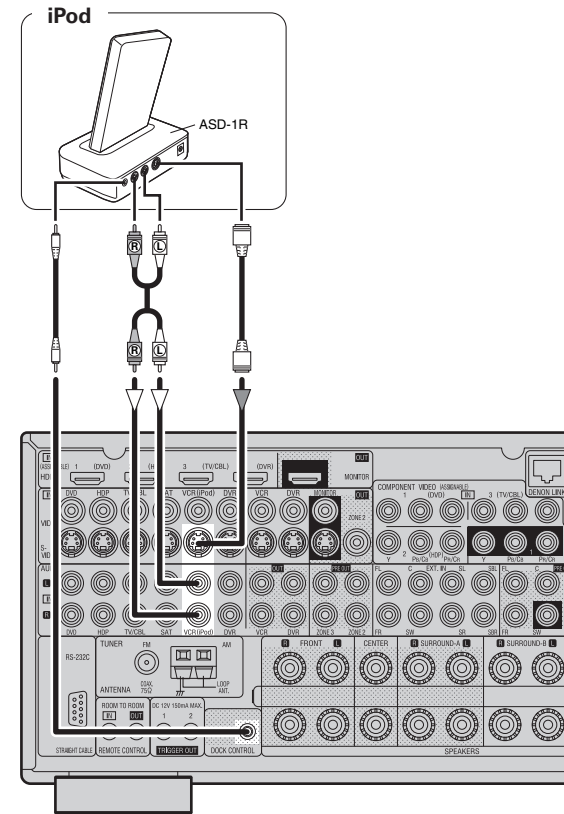

- With the default settings, the iPod can be used connected to the VCR (iPod) connector.
- To assign the iPod to a connector other than VCR (iPod), make the settings at GUI menu "Source Select" – "(input source to which iPod dock assigned)" – "Assign" – "iPod dock" (page 39).

TV/CABLE Tuner

Connect the cables to be used.

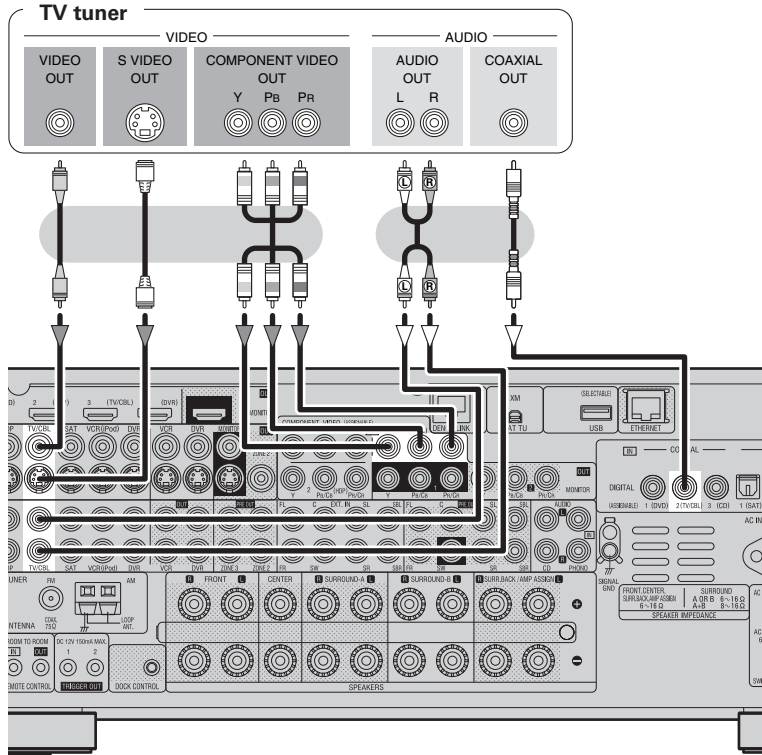

When using an optical cable for the digital audio connection, make the settings at GUI menu "Source Select" – "TV/CBL" – "Assign" – "Digital" (page 39).

Satellite Receiver

Connect the cables to be used.

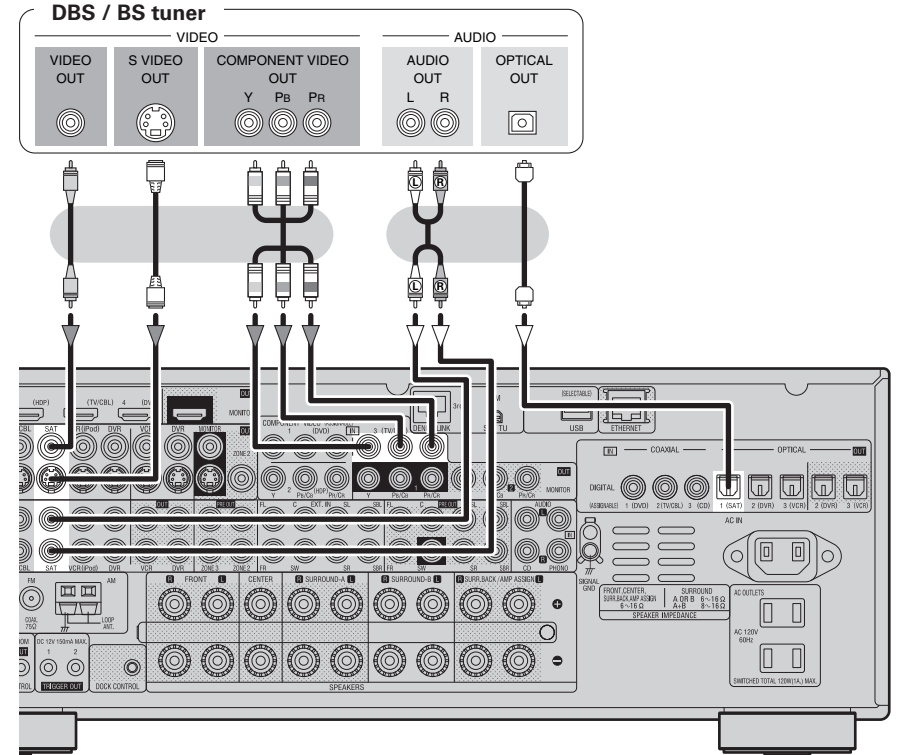

- When using a coaxial digital cable for the digital audio connection, make the settings at GUI menu "Source Select" – "SAT" – "Assign" – "Digital" (page 39).
- When using a component video cable for the video connection, make the settings at GUI menu "Source Select" – "SAT" – "Assign" – "Component" (page 39).

Connecting the Recording Components

Carefully check the left (L) and right (R) channels and the inputs and outputs, and be sure to interconnect correctly.

Digital Video Recorder

Connect the cables to be used.

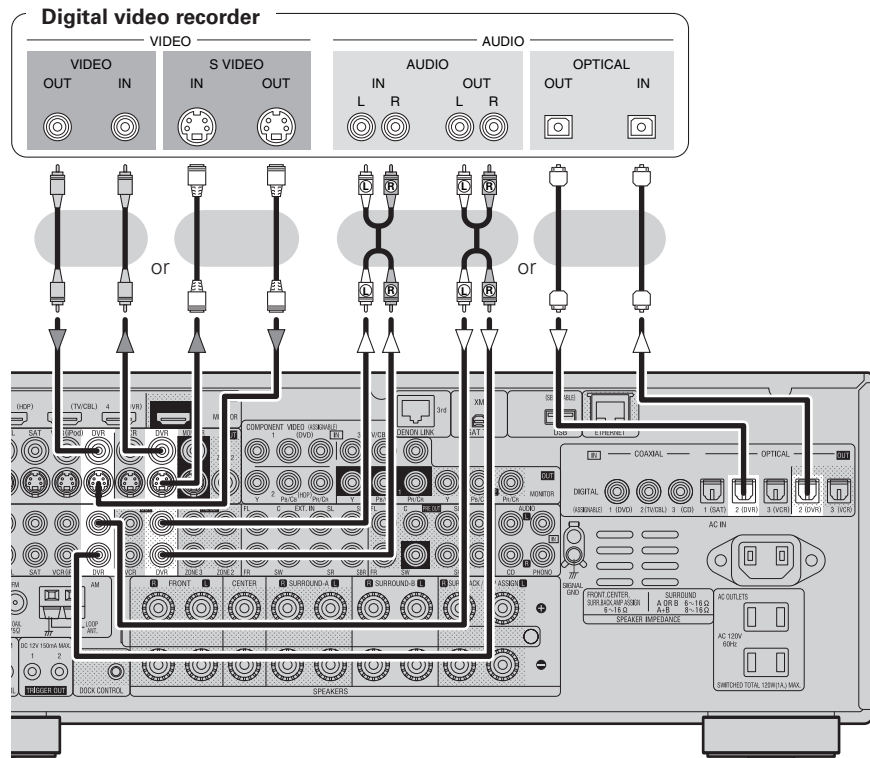

- Make analog connections if you wish to record analog audio signals.
- When recording to a digital video recorder, it is necessary that the type of cable used with the playback source equipment be the same type that is connected to the AVR-3808CI DVR OUT connector.
Example: TV IN → S-Video cable : DVR OUT → S-Video cable
TV IN → Video cable : DVR OUT → Video cable
- When using a component video cable for the video connection, make the settings at GUI menu "Source Select" – "DVR" – "Assign" – "Component" (page 39).

NOTE

Do not connect the output of the component connected to the AVR-3808CI's OPTICAL2 output connector to any input connector other than OPTICAL2.

Video Cassette Recorder

Connect the cables to be used.

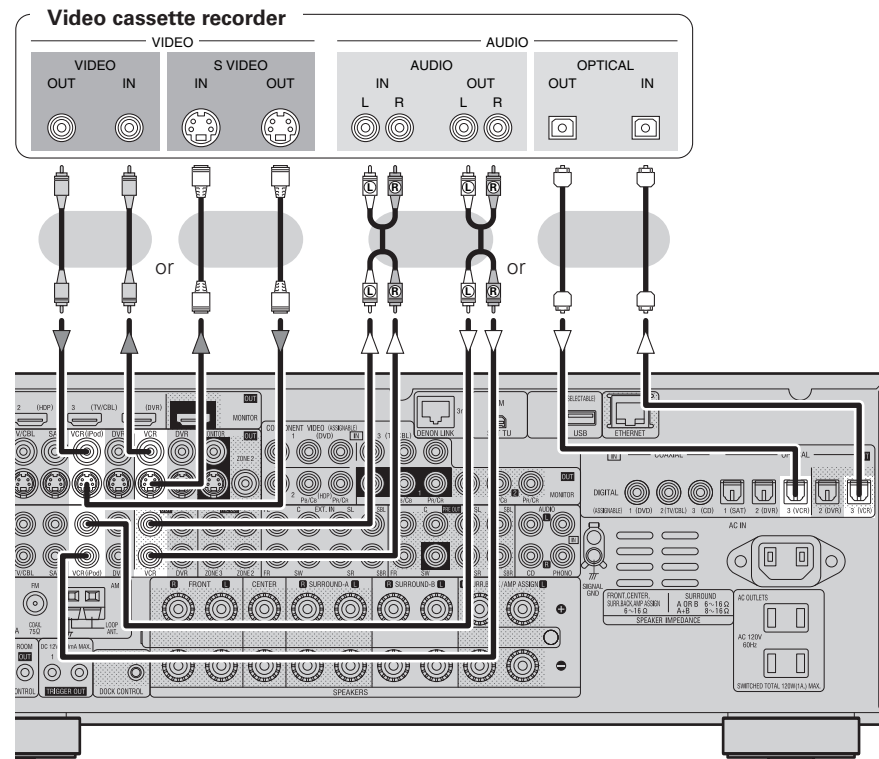

- When recording to a VCR, it is necessary that the type of cable used with the playback source equipment be the same type that is connected to the AVR-3808CI VCR OUT connector.
Example: TV IN → S-Video cable : VCR OUT → S-Video cable
TV IN → Video cable : VCR OUT → Video cable
- When using a component video cable for the video connection, make the settings at GUI menu "Source Select" – "VCR" – "Assign" – "Component" (page 39).

NOTE

Do not connect the output of the component connected to the AVR-3808CI's OPTICAL3 output connector to any input connector other than OPTICAL3.

CD Recorder / MD Recorder / Tape Deck

Make analog connections if you wish to record analog audio signals, or digital connections if you wish to record digital audio signals, depending on the types of connectors on the components being used.

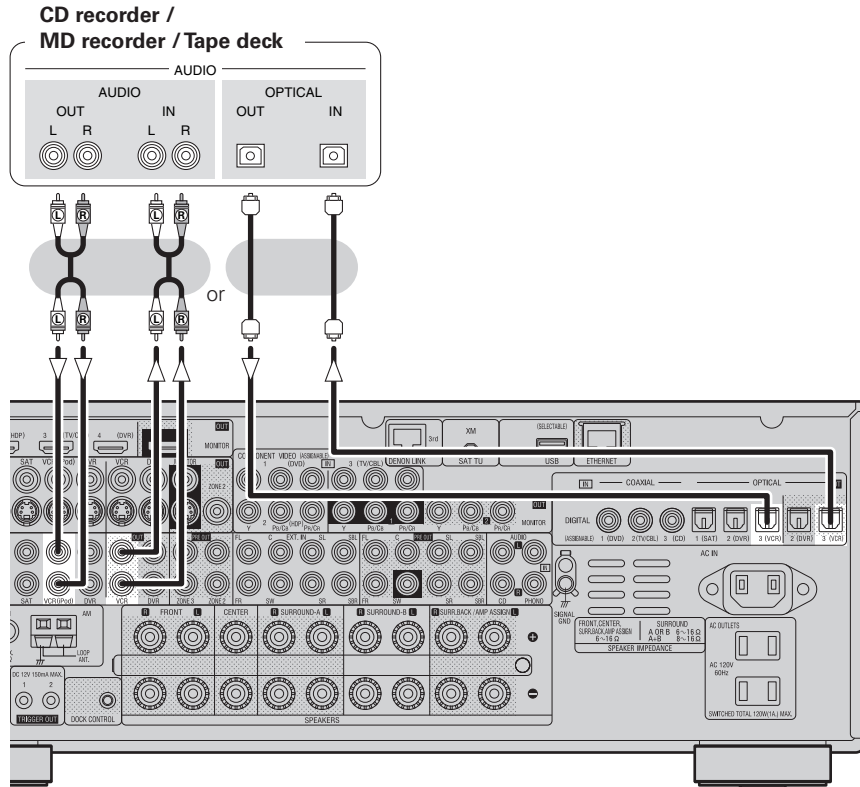

NOTE

Do not connect the output of the component connected to the AVR-3808CI's OPTICAL3 output connector to any input connector other than OPTICAL3.

Connections to Other Devices

Carefully check the left (L) and right (R) channels and the inputs and outputs, and be sure to interconnect correctly.

Components Equipped with a DENON LINK connector

Multi-channel playback is possible with DVD-Audio discs, Super Audio CD, etc.

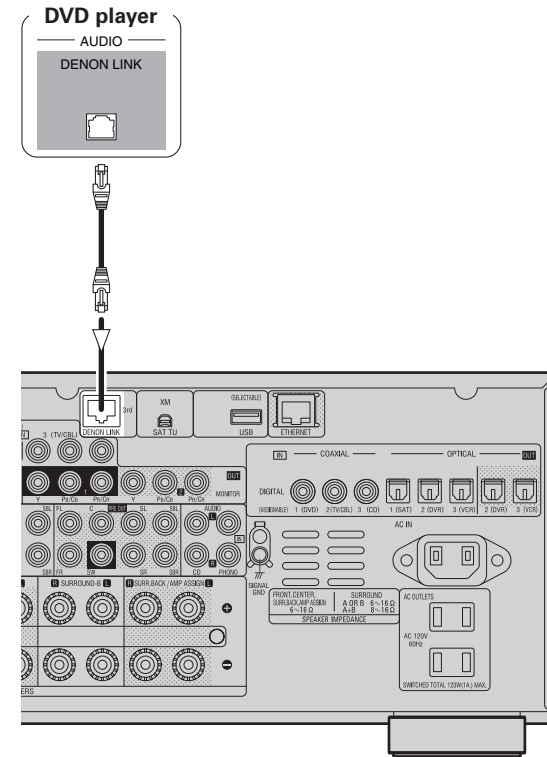

To use with DENON LINK connections, make the settings at GUI menu "Source Select" – "Assign" – "Digital" – "DENON LINK" (page 39).

Video Camera / Game Console

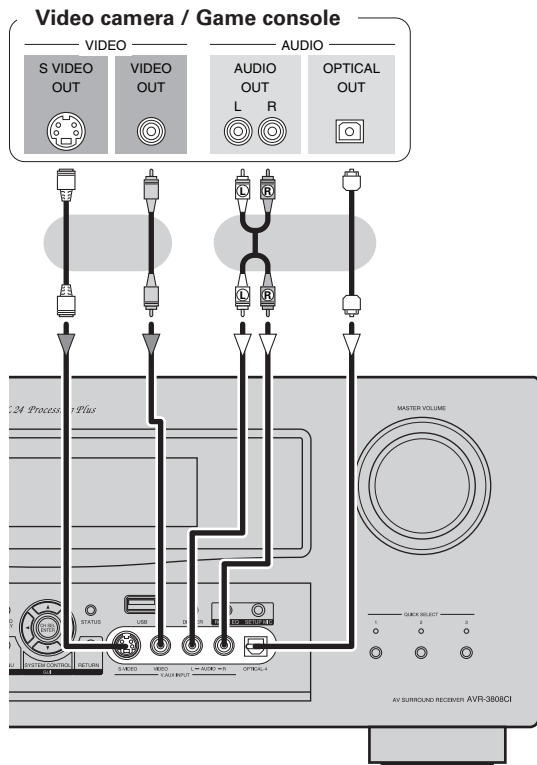

Component with Multi-channel Output connectors

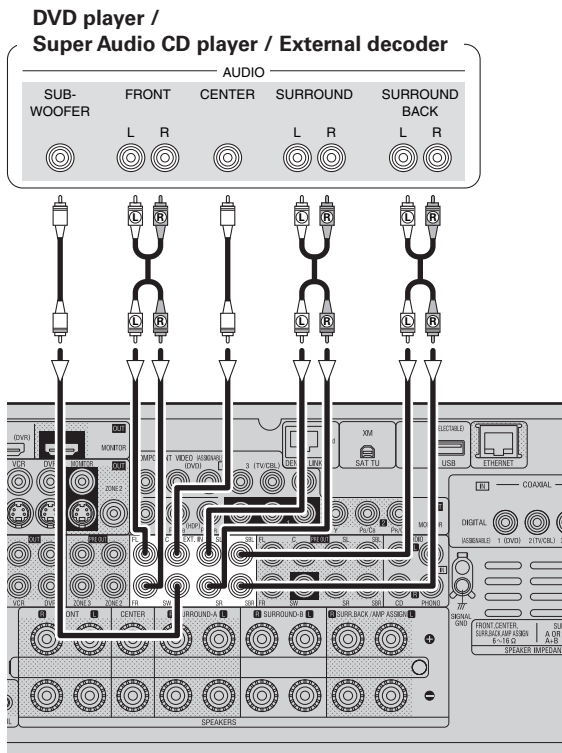

- To play the analog input signals input to the EXT. IN connectors, press the **INPUT MODE** button on the main unit or **INPUT** button on the main remote control unit and select "EXT. IN" or make the settings at GUI menu "Source Select" – "(input source)" – "Input Mode" – "Input Mode" – "EXT. IN" (👉 page 37).
- The video signal can be connected in the same way as a DVD player (👉 page 12).
- To play copyright-protected discs, connect the AVR-3808CI's EXT. IN connector with the DVD player's analog multi-channel output connector.

External Power Amplifier

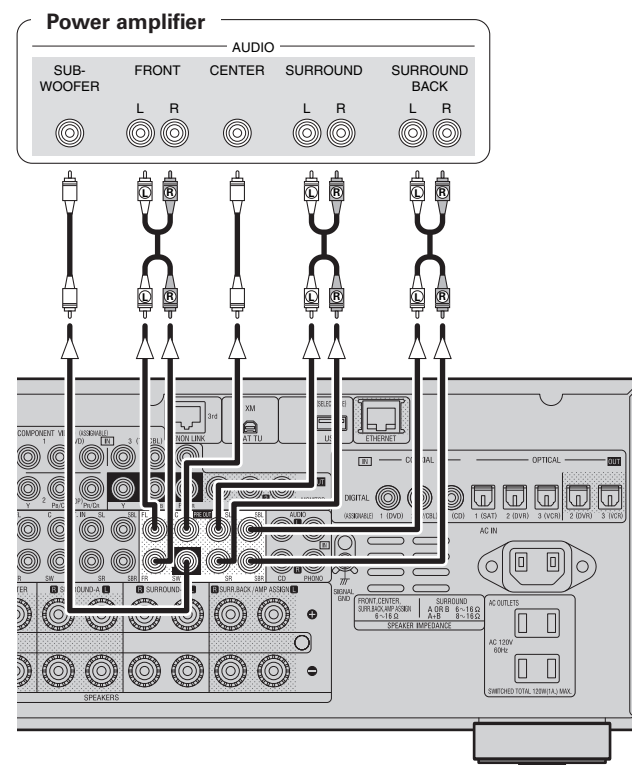

When using just one surround back speaker, connect it to the left channel (SBL).

USB Port

Front panel

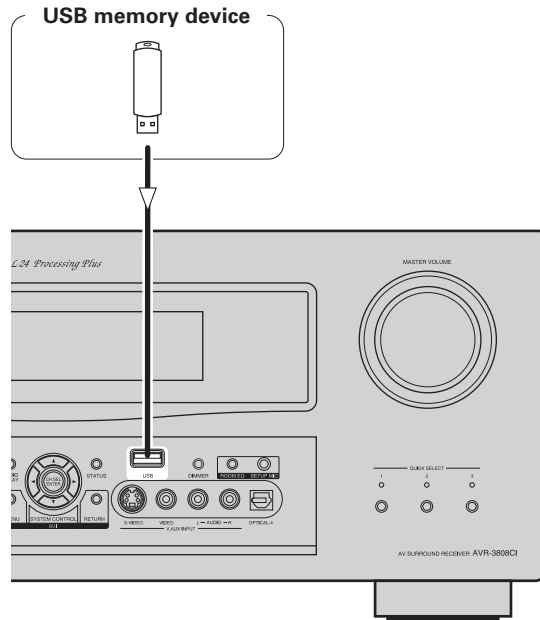

Rear panel

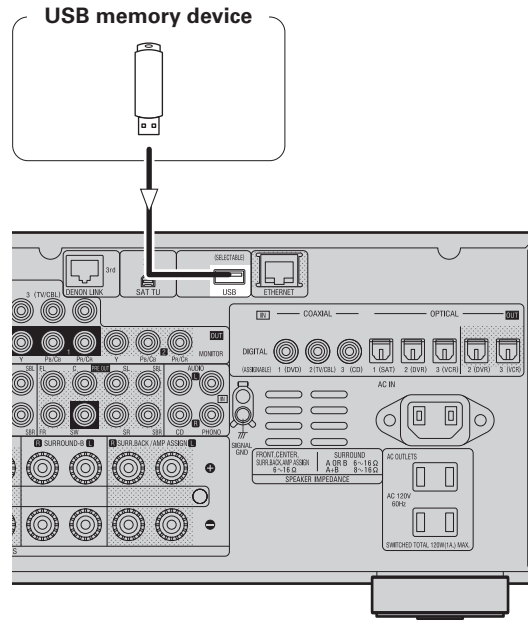

- In the initial status, USB memory devices can be used by connecting them to the USB port on the front panel.
- To change the port to be used, see “USB Select” on page 39.
- For instructions on playing the files on a USB memory device, see page 54.

NOTE

- Set to the USB port you want to use.
- The AVR-3808CI is equipped with two USB ports, one each on the front and rear panels. It is not possible to use the set with USB memory devices connected to both the ports at the same time. Select the USB port you want to use at the “Source Select” – “NET/USB” – “Playback Mode” – “USB Select” menu.
- Do not use the extension cable for connecting the USB memory device to the AVR-3808CI’s USB port. Use of the extension cable may cause harmful interference.

XM connector

- The AVR-3808CI is an XM Ready® receiver. You can receive XM® Satellite Radio by connecting to the XM Mini-Tuner and Home Dock (includes home antenna, sold separately) and subscribing to the XM service.
- Plug the XM Mini-Tuner and Home Dock into the XM connector on the rear panel.
- Position the Home Dock antenna near a south-facing window to receive the best signal.

For details, see “Listening to XM Satellite Radio Programs” (page 48, 49).

When making connections, also refer to the operating instructions of the XM Mini-Tuner and Home Dock.

XM Mini-Tuner and Home Dock

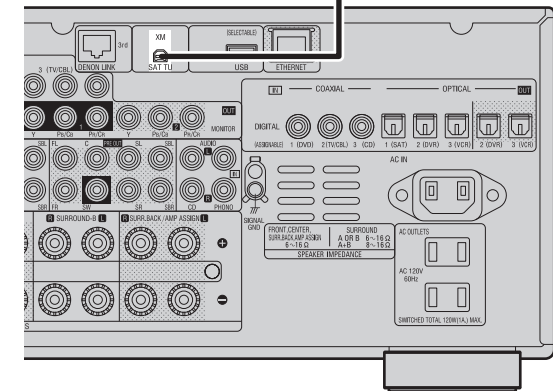
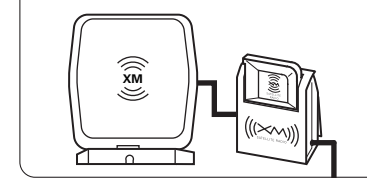

NOTE

Keep the power cord unplugged until the XM Mini-Tuner and Home Dock connection have been completed.

- The XM name and related logo are registered trademarks of XM Satellite Radio Inc. All rights reserved.
- XM Ready is a registered trademark of XM Satellite Radio Inc. All rights reserved.

Antenna terminals

An F-type FM antenna cable plug can be connected directly.

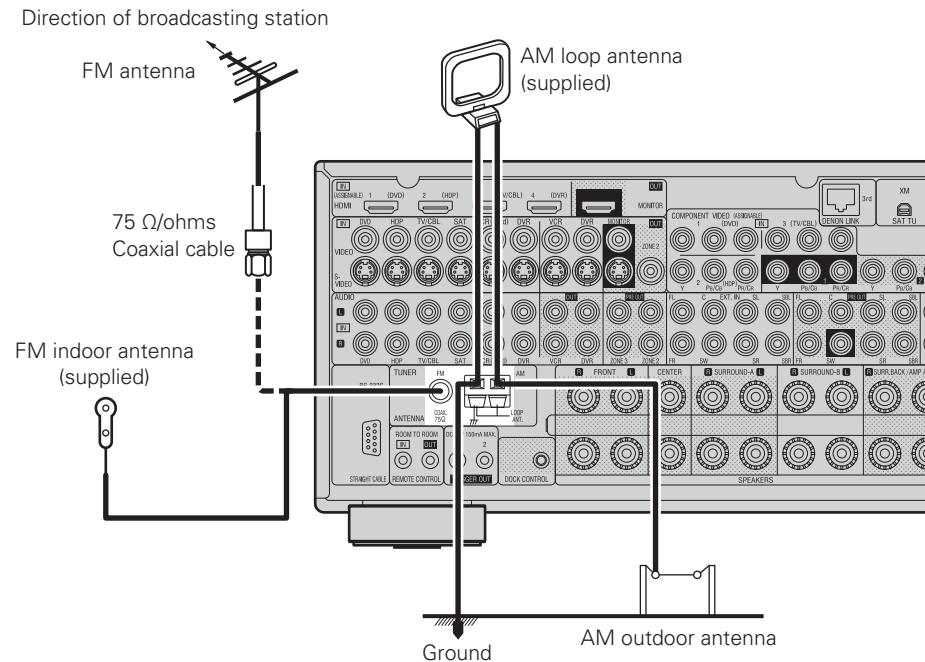

AM loop antenna assembly

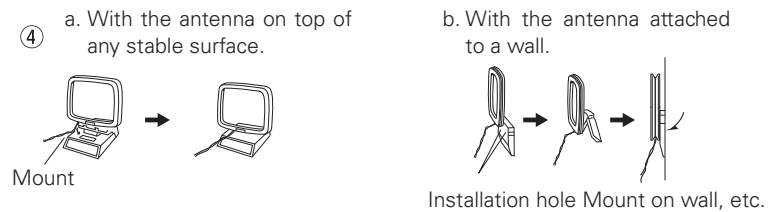
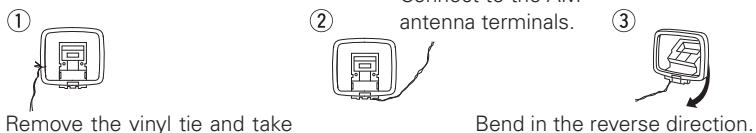

Connection of AM antennas

1. Push the lever.
2. Insert the conductor.
3. Return the lever.



NOTE

- Do not connect two FM antennas simultaneously.
- Even if an external AM antenna is used, do not disconnect the AM loop antenna.
- Make sure the AM loop antenna lead terminals do not touch metal parts of the panel.

Note to CATV system installer:

This reminder is provided to call the CATV system installer's attention to Article 820-40 of the NEC which provides guidelines for proper grounding and, in particular, specifies that the cable ground shall be connected to the grounding system of the building, as close to the point of cable entry as practical.

Network Audio

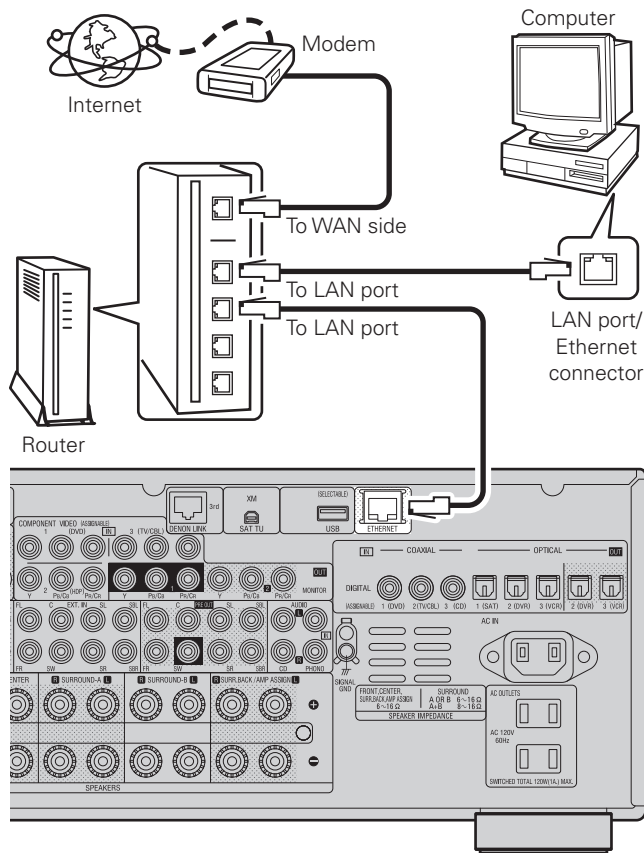

Required system

❑ Broadband Internet connection

A broadband line connection to the Internet is required in order to use the AVR-3808CI's Internet radio function and firmware update.

❑ Modem

This is a device that is connected to the broadband line to communicate with the Internet. Some are integrated with the router.

❑ Router

When using the AVR-3808CI, we recommend you use a router equipped with the following functions:

- Built-in DHCP (Dynamic Host Configuration Protocol) server
This function automatically assigns IP addresses on the LAN.
- Built-in 100 BASE-TX switch
When connecting multiple devices, we recommend a switching hub with a speed of 100 Mbps or greater.

❑ Ethernet cable (CAT-5 or greater recommended)

- The AVR-3808CI does not come with an Ethernet cable.
- Some flat type Ethernet cables are easily affected by noise.
We recommend using a normal type cable.
- If the sound is broken in an environment in which there is much power supply noise from electric products or in a noisy network environment, use a shielded type Ethernet cable.

❑ Computer

A computer with the following specifications is required to use a music server:

- OS
Windows® XP Service Pack2, Windows Vista
- Software (Prepare one of the following.)
 - .NET Framework 1.1 and Windows Media Connect (Windows XP)
 - Windows Media Player ver.11
 - DLNA-compatible server software
- Internet browser
Microsoft Internet Explorer 5.01 or later
- LAN port
- 300 MB or more free disk space

※ Free disk space is required to store music files. The following sizes are approximate.

Format	Bit rate	Per minute	Per hour
MP3 / WMA	128 kbps	Approx. 1 MB	Approx. 60 MB
	192 kbps	Approx. 1.5 MB	Approx. 90 MB
MPEG-4 AAC	256 kbps	Approx. 2 MB	Approx. 120 MB
	392 kbps	Approx. 3 MB	Approx. 180 MB
WAV (LPCM)	1400 kbps	Approx. 10 MB	Approx. 600 MB
FLAC	1080 kbps	Approx. 7.7 MB	Approx. 464 MB



For connections to the Internet, contact an ISP (Internet Service Provider) or a computer shop.

NOTE

- A contract with an ISP is required to connect to the Internet.
No additional contract is needed if you already have a broadband connection to the Internet.
- The types of routers that can be used depend on the ISP. Contact an ISP or a computer shop for details.
- Depending on the server, video files may be displayed, but they cannot be played on the AVR-3808CI.

❑ Others

- If you have an Internet provider contract for a line on which network settings are made manually, make the settings at GUI menu "Manual Setup" – "Network Setup" (page 32).
- With the AVR-3808CI, it is possible to use the DHCP and Auto IP functions to make the network settings automatically.
- When using a broadband router (DHCP function), the AVR-3808CI sets the IP address, etc., automatically.
When using the AVR-3808CI connected to a network with no DHCP function, make the settings for the IP address, etc., at GUI menu "Manual Setup" – "Network Setup" (page 32).
- The AVR-3808CI is not compatible with PPPoE. A PPPoE-compatible router is required if you have a contract for a line of the type with which the PPPoE is set.
- Depending on the ISP with which you have your contract, it may be necessary to make proxy server settings to use the Internet radio function. If you made proxy server settings on the computer to connect to the Internet, make the proxy server settings on the AVR-3808CI in the same way.

Multi Zone

ZONE2 or ZONE3 Pre-out Connections

- If another power amplifier or pre-main (integrated) amplifier is connected, the ZONE2 or ZONE3 pre-out connectors can be used to play a different program source in ZONE2 or ZONE3 the same time (☞ page 68 ~ 71).
- When using an S-Video cable or a video cable for connection between the AVR-3808CI and an input device, connect to the video connectors.
- The ZONE2 video out is only for ZONE2.

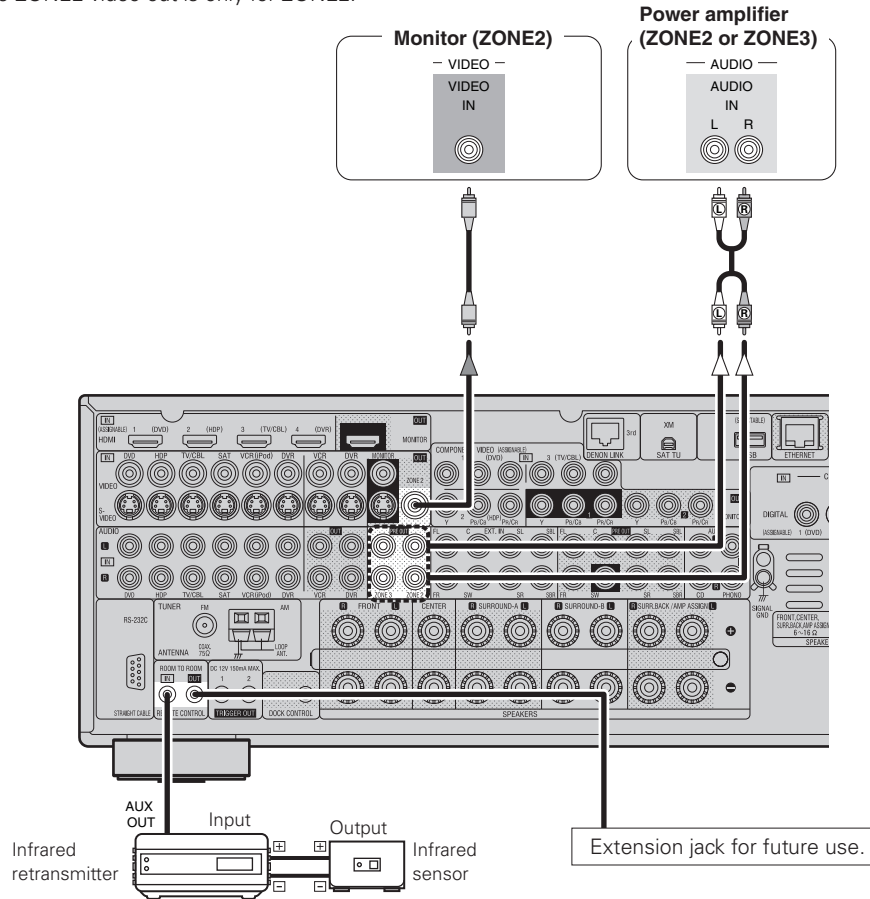

NOTE

- For the audio output, use high quality pin-plug cords so that no induction humming or noise is produced.
- For instructions on installing and operating separately sold devices, refer to the respective devices' operating instructions.
- To conduct multi-zone playback, see "Amp Assign / Multi Zone Connections and Operations" (☞ page 68 ~ 71).

External Controller

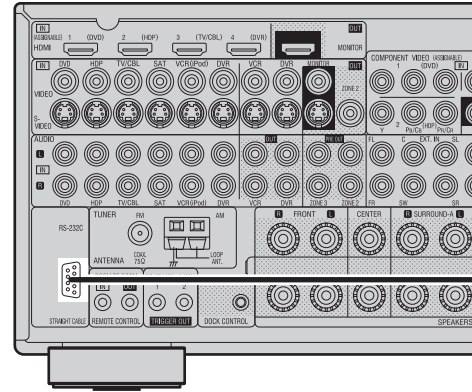

RS-232C connector

- This connector is used for an external controller.
- ※ If you wish to control the AVR-3808CI from an external controller using the RS-232C connector, perform the operation below beforehand.
 - ① Turn the AVR-3808CI's power.
 - ② Turn off the AVR-3808CI's power from the external controller.
 - ③ Check that the AVR-3808CI is in the standby mode.



- When using in combination with an RF Remote Controller (RC-7000CI, sold separately) or RF Remote Receiver (RC-7001RCI, sold separately) two-way communication with an RF Remote Controller is possible. The AVR-3808CI's status information as well as iPod and Internet audio music files can be browsed watching the RF Remote Controller's display. For details, refer to the operating instructions of the respective devices.
- When used in combination with an RF Remote Controller or RF Remote Receiver, make the settings at GUI menu "Manual Setup" – "Option Setup" – "2Way Remote" – "Used" (☞ page 35).

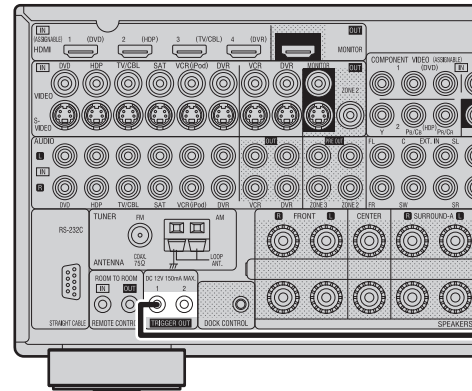

Trigger output jacks

- The power of an external device equipped with a trigger input jack can be turned on and off in association with operations on the AVR-3808CI. For details, see GUI menu "Manual Setup" – "Option Setup" – "Trigger Out 1" or "Trigger Out 2" (☞ page 35).
- Output level: 150 mA/12 V
Check the trigger input conditions of the connected device.
 - If the trigger input level of the connected device is higher than 150 mA/12 V and depending on the short-circuiting conditions, the AVR-3808CI's protection circuit may be activated, in which case "TRIGGER PROTECT" appears on the display. If this happens, turn off the AVR-3808CI's power and disconnect the connected device.

Connecting the Power Cord

Wait until all connections have been completed before connecting the power cord.

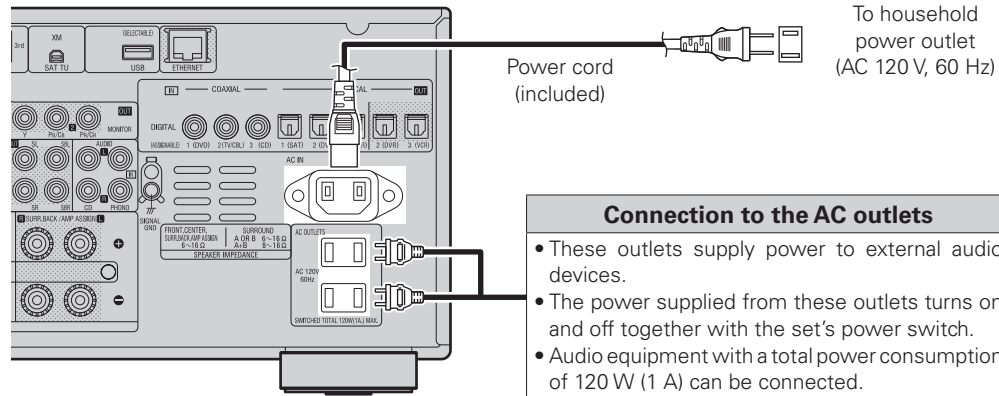

NOTE

- Insert the AC plugs securely. Incomplete connections could cause noise.
- Only use the AC outlets to plug in audio devices. Do not use them as power supplies for hairdryers or anything other than audio equipment.

Once Connections are Completed

Turning the Power On (page 46)

GUI Menu Operations

With the AVR-3808CI, settings and operations for most functions can be performed by operating while looking at the GUI menus displayed on the monitor screen.

The GUI cannot be superimposed when xVYCC signals and component 1080p signal, computer's resolution (e.g.VGA) are input.

Example of the Display of the GUI Mark at a Title

Items for which this mark is indicated at the title can be operated from the GUI. We recommend performing such operations from the GUI.

Auto Setup

Optimize settings for speakers in use.



This is the GUI icon for this setting item or for the menu series to which this item belongs.

Example of Display of Default Values

In lists of selectable items or adjustable ranges, the item surrounded by a border is the default value.

[Selectable items] 7.1 (B) 7.1 **5.1**

Examples of GUI Screen Displays

Some typical examples are described below.

Example: Browse Menu (Top Menu)

Example: Menus with Illustrations (Auto Setup)

Cursor Position Display

Icon

List

Operations

The same operation is possible on the main unit or remote control unit.

- 1 Press the MENU button.**
The GUI menu is displayed.
※ To operate from the main remote control unit, be sure to set the remote control unit to the AMP mode.
- 2 Press the Δ ∇ ▷ button to select the menu to be set or operated.**
※ To return to the previous item, press the ◀ or RETURN button.
- 3 Press the ENTER button to enter the setting.**
- 4 Press the MENU button to finish.**

When "Screensaver" is set to "ON", the screensaver is activated if no operation is performed for about 3 minutes.

GUI Menu Map

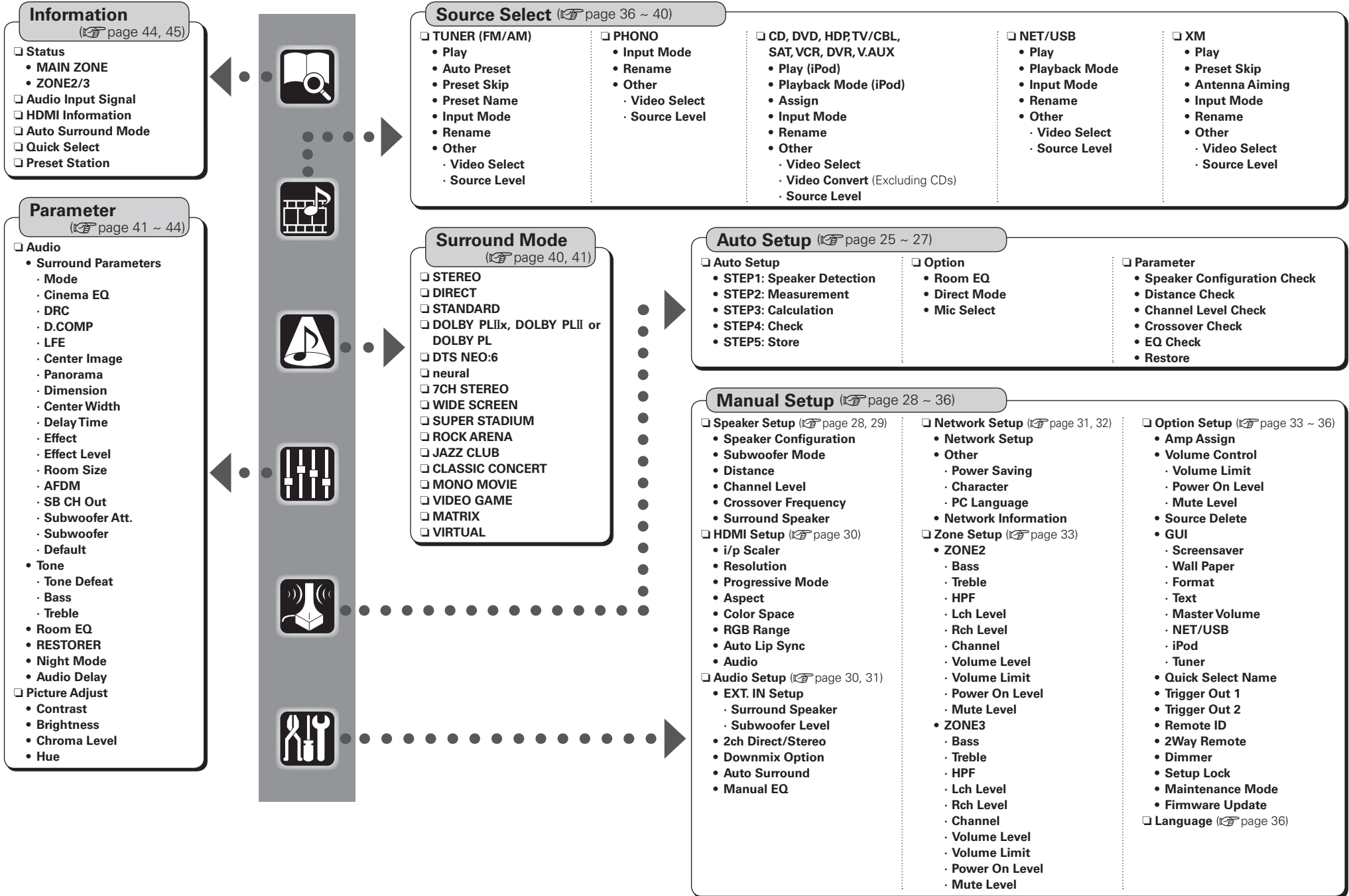

Auto Setup

GUI



- Audyssey MultEQ® XT automatically measures the acoustical problems in the listening environment to create the best audio experience for your home theater.
- It optimizes a large listening area where one or more listeners are seated.

Measurements are performed by placing the calibrated microphone (DM-A405) successively at multiple positions throughout the listening area as shown in **Example ①**. For best results, it is strongly recommended to measure 6 or more positions so that the measurements have the proper spatial weighting.

Even if the listening environment is small as shown in **Example ②**, measuring at multiple points throughout the listening environment results in more effective correction.

Example ①

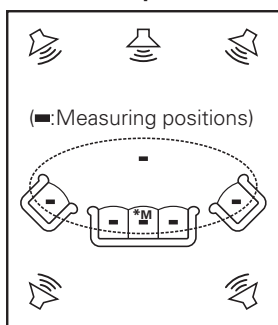

Example ②

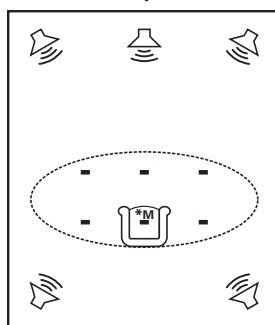

About the main listening position (*M)

The main listening position refers to the most central position where one would normally sit within the listening environment.

MultEQ XT uses the measurements from this position to calculate speaker distance, level, polarity, and the optimum crossover value for the subwoofer.



To make manual adjustments to the settings, see pages 28, 29.

Preparations

1 Connect the included calibrated setup microphone to the SETUP MIC jack on the main unit.

The auto setup screen appears automatically.

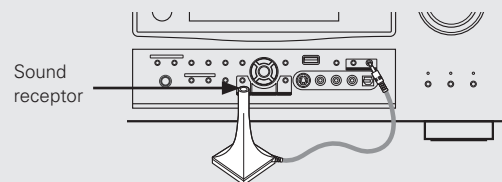

2 Place the microphone at ear height on a tripod or stand with the microphone pointing directly up towards the ceiling.

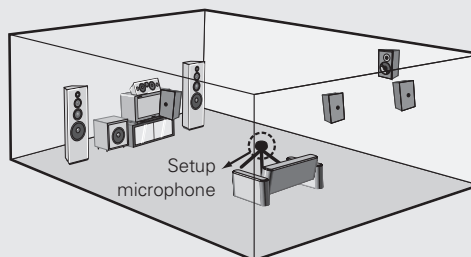

※ It is not recommended to hold it in your hand. Be sure that the path from microphone to the speakers is not blocked by objects. Avoid placing the microphone close to a seat back or wall as sound reflections may give inaccurate results.



When using a subwoofer, make the following settings before starting the auto setup procedure:

- Defeat the volume and crossover controls if possible
- If this is not possible then set
 - Volume: "12 o'clock" position
 - Crossover frequency: "Maximum/Highest Frequency"
 - Low pass filter: "Off"
 - Standby mode: "Off"

NOTE

- Do not disconnect the setup microphone until the auto setup procedure is completed.
- When using headphones, unplug the headphones before starting the auto setup procedure.

Auto Setup

Optimize settings for speakers in use.

GUI



Menu tree

Auto Setup

1 Auto Setup

2 Option

3 Parameter

1 Auto Setup

The settings are performed automatically.



Auto setup flow

STEP1: Speaker Detection



STEP2: Measurement (2 to 8 positions)



STEP3: Calculation



STEP4: Check



STEP5: Store

Start

Start Auto Setup.

The Audyssey MultEQ XT Auto Setup process automatically calculates the size, level, distance, bass management crossover frequency, and optimal settings for each speaker and subwoofer. Audyssey MultEQ XT corrects acoustical distortions within the listening area.

Before starting, connect and position all your speakers.

Once started, MultEQ XT will play a series of test tones through each speaker.



If an error message appears during the measurements, check "Error Messages" (page 27), take the advised action, then start the measurements again.

Configuration

The speaker system to be measured can be selected ahead of time here.

[Selectable items] 7.1 (B) 7.1 5.1

NOTE

"Amp Assign" is initially set to "ZONE2"; so "7.1 (B)" and "7.1" cannot be selected. To use "7.1 (B)" or "7.1", change the "Amp Assign" setting (page 68 ~ 70).



Setting the correct speaker configuration can reduce the time required to measure during the auto setup procedure as the system will not have to look for speakers that are not connected.

Amp Assign

Advanced setting : changes power amplifier assignment.

NOTE

The items selectable at "Config." differ according to the "Amp Assign" settings.

STEP1 : Speaker Detection

The speaker connection and polarity are detected at the first measurement position. The following attributes are also determined at this time: "Speaker Size", "Speaker Distance", "Channel Level", "Crossover Frequency".

Once the measurements are completed, the results are displayed.

NOTE

- Loud test tone may be played during Audyssey MultEQ XT Automatic Speaker Setup. This is part of normal operation. If there is background noise in room, these test tones will increase in volume.
- Do not stand between the speakers and setup microphone or allow obstacles in the path while the measurements are being made. This will cause inaccurate readings.
- Quiet the listening environment before beginning measurements and refrain from talking. Turn off air conditioning units or other devices that emit noise if at all possible as measurements may be affected by these sounds.
- Operating the **MASTER VOLUME** knob on the main unit or the **VOL +/-** buttons on the remote control unit during the measurements will cancel the measurements.
- Do not change the speaker connections or subwoofer volume after "STEP1".

STEP2: Measurement

After completing a measurement position, move the microphone to the next position.



Measure at least 6 positions (main listening position and at least 5 other surrounding positions). For best results it is recommend measuring **6 or more positions** (with a maximum of 8 positions).

STEP3: Calculation

When "Calculate" is selected at "STEP2"; the measurements taken are analyzed automatically to determine how the speaker system interacts with the room.



The time required for this analysis depends on the number of speakers connected. The higher the number of speakers, the longer the time required for analysis.

STEP4: Check

Once the auto setup procedure is complete, a measuring result check screen appears.

Select any item whose results you want to check to review the results.



Values that are different from the actual distance may be set for speakers with built-in filters (subwoofers, etc.). This is because filters add electrical delay to the signal that should be compensated.

STEP5: Store

The auto setup measurement results are stored in the AVR-3808CI.

NOTE

Do not turn the power off while the settings are being stored.

Error Messages

If the auto setup procedure could not be completed due to speaker installation, the measuring environment, etc., an error message is displayed. If this happens, check the relevant items, be sure to take the necessary measures, then perform the auto setup procedure over again.

Error messages (examples)	Cause	Measures
No microphone or speaker	<ul style="list-style-type: none"> Included setup microphone is not connected. Not all speakers could be detected. 	<ul style="list-style-type: none"> Connect the included setup microphone to the SETUP MIC jack on the main unit. Check the speaker connections.
Ambient noise is too high or Level is too low	<ul style="list-style-type: none"> Too much noise in the room for accurate measurements to be made. Speaker or subwoofer sound is too low for accurate measurements to be made. 	<ul style="list-style-type: none"> Either turn off any device generating noise or move it away. Try again when the surroundings are quieter. Check the speaker installation and the direction in which the speakers are facing. Adjust the subwoofer's volume.
None	<ul style="list-style-type: none"> Displayed speaker could not be detected. <ul style="list-style-type: none"> The front L and front R speakers were not properly detected. Only one channel of the surround (A) and surround (B) speakers was detected. Sound was output from the R channel when only one surround back speaker was connected. The surround back or the surround (B) speaker was detected, but the surround (A) speaker was not detected. 	<ul style="list-style-type: none"> Check the connections of the displayed speaker.
Phase	<ul style="list-style-type: none"> Displayed speaker connected with the polarities reversed. 	<ul style="list-style-type: none"> Check the polarities of the displayed speaker. For some speakers, this error message may be displayed even if the speaker is properly connected. If you are sure that the wiring is correct, select "Skip".

 Select "Retry" to make the measurements again.

NOTE Be sure to turn the power off before checking the speaker connections.

2 Option

Select settings for room EQ, mic, etc.



Room EQ

Select room EQ setting method.

[Selectable items] **All** **Assign**

Direct Mode

Select room EQ use for DIRECT or PURE DIRECT mode.

[Selectable items] **ON** **OFF**

Mic Select

Select the microphone type if not using supplied mic. The microphone connected to V.AUX Lch is used.

[Selectable items] **Mic** **V.AUX L**



Only a professionally certified installer should ever connect a professionally-calibrated microphone to the V.AUX L input on the front panel.

3 Parameter Check

Check auto setup measurement results. This is displayed after the auto setup procedure is completed.



[Items to be checked] **Spkr Config Check** **Distance Check**
Ch. Level Check **Crossover Check**
EQ Check



The auto setup results can be reset to what was originally calculated by MultEQ XT when "Restore" is selected.

Manual Setup



Make detail settings for various parameters.

Speaker Setup

Use this procedure to set the speakers manually or if you wish to change the settings made with the auto setup procedure.



Menu tree

Manual Setup

Speaker Setup

1 Speaker Configuration

2 Subwoofer Mode

3 Distance

4 Channel Level

5 Crossover Frequency

6 Surround Speaker

1 Speaker Configuration

Select speaker configuration and size.
(bass reproduction capability)

Front

Select front speaker size.

[Selectable items] **Large** **Small**

Center

Select center speaker use and size.

[Selectable items] **Large** **Small** **None**

Subwoofer

Select subwoofer use.

[Selectable items] **Yes** **No**

Surround A

Select surround speakers A use and size.

[Selectable items] **Large** **Small** **None**

Surround B

Select surround speakers B use and size.

[Selectable items] **Large** **Small** **None**

Surround Back

Select surround back speaker use and size.

[Selectable items] (**Large** **Small** **None**)
(**2spkrs** **1spkr**)

NOTE

By default, the AVR-3808CI's "Amp Assign" setting is set to "ZONE2". To use as the surround back speaker for the main zone, change the "Amp Assign" setting (page 68, 69).

Large : Select this for a large speaker with strong bass reproduction.

Small : Select this for a smaller speaker with weaker bass reproduction.



- Select "Large" or "Small" not according to the physical size of the speaker but according to the low frequency reproduction capabilities based on the frequency set at "Crossover Frequency" (page 29).
- When "Front" is set to "Small", "Subwoofer" is automatically set to "Yes".
- If "Subwoofer" is set to "No", "Front" is automatically set to "Large".
- If "Surround A" is set to "None", "Surround B" and "Surround Back" are automatically set to "None".
- When using just one surround back speaker, connect it to the left channel (SBL).

2 Subwoofer Mode

Select low range signal to be reproduced by subwoofer.

[Selectable items] **LFE** **LFE+Main**



- This can be set when GUI menu "Speaker Configuration" – "Subwoofer" is set to "Yes".
- Play music or a movie source and select the mode offering the strongest bass.
- Select "LFE+Main" if you want the bass signals to always be produced from the subwoofer.

3 Distance

Set distance from listening position to speakers.
Before making the settings, measure the distance from the listening position to the different speakers.

Feet / Meters

Select unit for distance.

Step

Select step. (smallest distance)

[Selectable items] **1ft** / **0.1ft** *1 / **0.1m** / **0.01m** *2
*1: Can be selected when "Feet" is set.
*2: Can be selected when "Meters" is set.

Default

Resets the settings to the default values.

Distance measurement

Select the speaker you want to set, then set the distance.
Set the value closest to the measured distance.

[Variable range] **0.0ft ~ 60.0ft** *1 / **0.00m ~ 18.00m** *2
*1: Display when "Feet" is set.
*2: Display when "Meters" is set.

NOTE

Set the distance between the listening position and the various speakers to no more than 20.0 ft (6.00 meters).

4 Channel Level

Adjust channel levels to obtain equal volume from all speakers.

Mode

Select test tone playback method.

[Selectable items] **Auto** **Manual**

Surround

Select surround speaker from which test tone is output.

[Selectable items] **A** **B** **A+B**

Start

Output test tone.

[Variable range] **-12dB** ~ **0dB** ~ **+12dB**

Operating from the main remote control unit

Adjusting with the main remote control unit using the test tones is only possible in the "Auto" mode and only effective in the STANDARD mode. The adjusted levels for the different modes are automatically stored in the memory.

Adjusting using test tones

- 1 Press the **TEST** button.
Test tones are output from the various speakers.
- 2 Use the ◀ ▶ button to adjust so that the volume is equal for all speakers.
- 3 When the adjustments are completed, press the **TEST** button again.



- When the GUI menu "Speaker Configuration" – "Surround Back" setting (page 28) is set to "1spkr", the surround back speaker display is set to "Surround Back".
- Speakers set to "None" in the "Speaker Configuration" settings are not displayed.
- "Surround" can be set when GUI menu "Speaker Configuration" – "Surround A" or "Surround B" is set to "Large" or "Small" (page 28).
- When using surround speakers, be sure to adjust the volume of the different speakers.
- When "Channel Level" is adjusted, the adjusted values are set for all the surround modes. To adjust the channel level separately for the different surround modes, use the operation see page 56.

Default

Resets the settings to the default values.

5 Crossover Frequency

Select crossover frequency from which subwoofer handles low range signal.

[Selectable items]

40Hz **60Hz** **80Hz** **90Hz** **100Hz** **110Hz**
120Hz **150Hz** **200Hz** **250Hz**

Only the portion of the bass sound of the various speakers output from the subwoofer that has a frequency below the frequency set here is output.

Set this according to the low frequency reproduction capabilities of the speakers you are using.

Advanced :

Set the crossover frequency separately for the different speakers.



- The "Crossover Frequency" can be set when there are speakers that have been set to "Small" at GUI menu "Speaker Configuration" or when "Subwoofer" is set to "Yes" (page 28).
- If GUI menu "Subwoofer Mode" (page 28) is set to "LFE", speakers set to "Small" at "Speaker Configuration" can be set. If set to "LFE+Main", this can be set regardless of the size of the speaker.
- For speakers set to "Small", sound below the crossover frequency is cut from the sound output. The cut bass sound is output from the subwoofer or front speakers.
- Always set the crossover frequency to "80 Hz". When using small speakers, however, we recommend setting the crossover frequency to a higher frequency.

6 Surround Speaker

Select surround speakers to use for each surround mode.

[Selectable items] **A** **B** **A+B**



Operating from the main remote control unit

Press the **SPKR** button.



- This can be set when GUI menu "Speaker Configuration" – "Surround A" and "Surround B" are used (page 28).
- When using the pre-out connectors, select and use either "Surround A" or "Surround B".
- Make the surround speaker settings when the input mode is set to "EXT. IN" at GUI menu "Manual Setup" – "Audio Setup" – "EXT. IN Setup" (page 30).

About Speaker Type Setting when Using Both Surround speakers A and B

If "Small" is set for either surround speakers A or B, the output is the same as when "Small" is set for both A and B.

HDMI Setup

Make settings for HDMI video/audio output.



Menu tree

Manual Setup

HDMI Setup

- 1 i/p Scaler
- 2 Resolution
- 3 Progressive Mode
- 4 Aspect
- 5 Color Space
- 6 RGB Range
- 7 Auto Lip Sync
- 8 Audio

1 i/p Scaler

Make settings for i/p scaler function.

[Selectable items] **A to H** A to H & H to H OFF



A to H & H to H setting

- Deep color (10 bit/12 bit) signals are converted into 8-bit signals.
- The i/p scaler function does not work if xVCC or computer's resolution signals are input.

2 Resolution

Make settings for resolution of HDMI video output signal.

[Selectable items] **Auto** 480p/576p 1080i 720p 1080p



This can be set when "i/p Scaler" is set to anything other than "OFF".

NOTE

- It is not possible to convert "1080i" signals into "720p" format.
- It is not possible to convert "720p" signals into "1080i" format.

3 Progressive Mode

Select optimum progressive mode for video material.

[Selectable items] **Auto** Video1 Video2



This can be set when "i/p Scaler" is set to anything other than "OFF".

4 Aspect

This sets the aspect ratio when outputting 480i/576i or 480p/576p input signals from the HDMI output connector.

[Selectable items] **Full** Normal



This can be set when "i/p Scaler" is set to anything other than "OFF".

5 Color Space

Make settings for output color space.

[Selectable items] **YCbCr** RGB



When connected to a monitor with a DVI-D connector (HDCP compatible) using an HDMI/DVI converter cable, the signals are output in RGB format, regardless of this setting.

6 RGB Range

Make settings for RGB output range.

[Selectable items] **Normal** Enhanced

7 Auto Lip Sync

Automatic compensation for timing shift in audio and video output.

[Selectable items] **ON** OFF

8 Audio

Select HDMI audio output device.

[Selectable items] **Amp** TV

Audio Setup

Make settings for audio playback.



Menu tree

Manual Setup

Audio Setup

- 1 EXT.IN Setup
- 2 2ch Direct/Stereo
- 3 Downmix Option
- 4 Auto Surround Mode
- 5 Manual EQ

1 EXT. IN Setup

Make speaker settings for EXT. IN mode playback.

Surround Speaker

Select the surround speakers to use.

[Selectable items] **A** B A+B

Subwoofer Level

Set the subwoofer level for playback.
Select according to the player in use.

[Selectable items] **0dB** +5dB +10dB +15dB



We recommend setting to "+15 dB".

2 2ch Direct/Stereo

Make speaker settings for 2-channel mode playback.

Setting

To change the settings, select "Custom".

[Selectable items] **Basic** * **Custom**

*: Use the same settings as in "Speaker Setup".

Front

Select front speaker size.

[Selectable items] **Large** **Small**

Subwoofer

Select subwoofer use.

[Selectable items] **Yes** **No**

Subwoofer Mode

Select low range signal to be reproduced by subwoofer.

[Selectable items] **LFE** **LFE+Main**

Crossover

Select crossover frequency from which subwoofer handles low range signal.

[Selectable items] **40Hz** **60Hz** **80Hz** **90Hz** **100Hz**
110Hz **120Hz** **150Hz** **200Hz** **250Hz**

Distance FL

Set distance from listening position to front left speaker.

[Variable range] **0.0ft ~ 60.0ft**

Distance FR

Set distance from listening position to front right speaker.

[Variable range] **0.0ft ~ 60.0ft**

3 Downmix Option

Set dynamic range for downmix playback of Dolby Digital sources.

[Selectable items] **ON** **OFF**



- Set this to "ON" if the sound from the front speakers seems distorted.
- When not using the center speaker or surround speakers, the playback sound is down-mixed and output from the front speakers.

4 Auto Surround Mode

Make setting for memorizing surround mode setting for each input signal type.

[Selectable items] **ON** **OFF**



- The auto surround mode function lets you store in the memory the surround mode last used for playing the four types of input signals listed below.
 - ① Analog and PCM 2-channel signals
 - ② Dolby Digital and DTS 2-channel signals
 - ③ Dolby Digital and DTS multi-channel signals
 - ④ Multi-channel signals other than Dolby Digital and DTS (PCM, DSD, etc.)
- When playing in the PURE DIRECT mode, the surround mode does not change even if the input signal is changed.

5 Manual EQ

Adjust tonal quality for each speaker using graphic equalizer.

Adjust CH

Select speaker adjustment method.

[Selectable items] **Each** **L/R** **All**

Manual EQ

Select the speaker and frequency band and adjust the level.

[Selectable items] **63** **125** **250** **500** **1k** **2k** **4k**
8k **16k**

[Variable range] **-20dB ~ +6dB**

Curve Copy

Copy "Audyssey Flat" curve from Room EQ.

[Selectable items] **Yes** **No**



"Curve Copy" is displayed after the auto setup procedure has been performed.

Default

Resets the settings to the default values.

Network Setup

Make network settings.



● Menu tree ●

Manual Setup

Network Setup

Network Setup

Other

Network Information

1 Network Setup

Make settings for LAN.

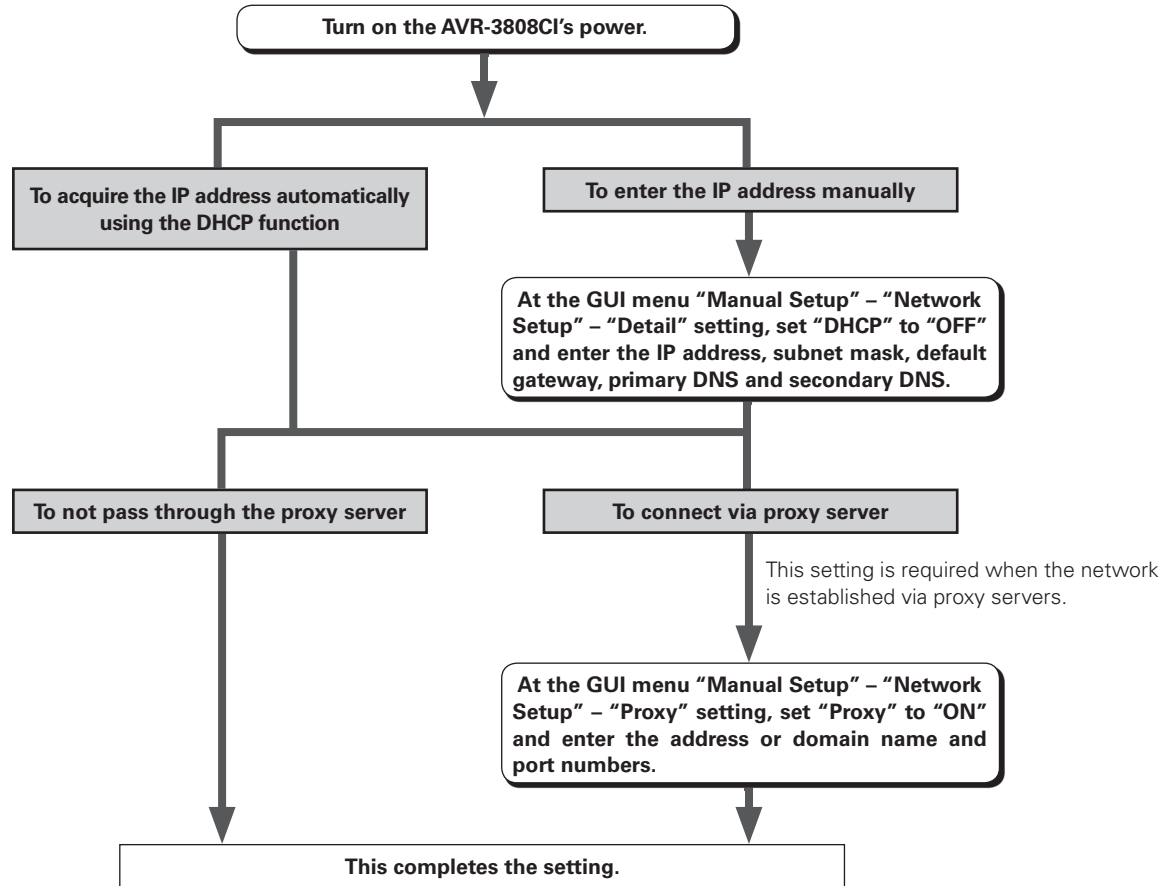

Recheck the connections and settings if you cannot connect to the Internet (☞ page 20).

NOTE Knowledge about networks is required to make the IP address and proxy settings. For details, consult a network administrator.

2 Other

Make setting for amp power save mode and computer language environment.

Power Saving

Make setting for power saving when not connected to network.

[Selectable items] ON OFF

Character

Set the character code type of the MP3 ID3-Tag played by USB.

[Selectable items] Auto Latin Japanese



If the characters are not properly displayed when set to "Auto", set to "Latin" or "Japanese".

PC Language

Select computer environment language.

[Selectable items]

ara	chi (smp)	chi (trad)	cze	dan		
dut	eng	fin	fre	ger	gre	heb
hun	ita	jpn	kor	nor	pol	por
por (BR)	rus	spa	swe	tur		

3 Network Information

Display network information.

[Items to be checked] DHCP= ON or OFF IP Address
 MAC Address

Zone Setup

Make settings for audio playback in a multi-zone system.



● Menu tree ●

Manual Setup

Zone Setup

1 ZONE2

2 ZONE3

1 ZONE2

Make settings for audio playback in a ZONE2 system.

2 ZONE3

Make settings for audio playback in a ZONE3 system.

Bass

Adjust low frequency range (bass).

[Variable range] ~ ~

Treble

Adjust high frequency range (treble).

[Variable range] ~ ~

HPF

When using speakers that cannot satisfactorily play low frequencies, distortion of the bass sound can be reduced by setting "HPF" to "ON".

[Selectable items] ON OFF

Lch Level

Adjust the left channel output level.

[Variable range] ~ ~

Rch Level

Adjust the right channel output level.

[Variable range] ~ ~

Channel

Switch between stereo and mono output.

[Selectable items] Stereo Mono



When GUI menu "Manual Setup" – "Option Setup" – "Amp Assign" (page 33) is set to "ZONE (MONO)", the "Channel" setting is automatically set to "Mono".

Volume Level

Adjust the main volume level.

[Selectable items] Variable -40dB 0dB



"Variable" is displayed when a power amplifier is assigned to the ZONE2 output channel at GUI menu "Manual Setup" – "Option Setup" – "Amp Assign".

Volume Limit

Make a setting for maximum volume.

[Selectable items] OFF -20dB -10dB 0dB

Power On Level

Define the volume setting that is active when the power is turned on.

[Selectable items] Last --- -70dB ~ +18dB

Mute Level

Set the amount of attenuation when muting is on.

[Selectable items] Full -40dB -20dB

Option Setup

Make various other settings.



● Menu tree ●

Manual Setup

Option Setup

1 Amp Assign

2 Volume Control

3 Source Delete

4 GUI

5 Quick Select Name

6 Trigger Out 1

7 Trigger Out 2

8 Remote ID

9 2Way Remote

10 Dimmer

11 Setup Lock

12 Maintenance Mode

13 Firmware Update

1 Amp Assign

Define how the amplifier for the surround back speaker channels is used.

The places where the surround back amplifier are used can be set freely according to the usage environment. This makes it possible to output sound to rooms other than the room (the main zone) where surround playback is performed (multi-zone playback) or play the sound with high quality using the front speakers (bi-amp connections).

[Selectable items]

7.1CH ZONE2 ZONE3 ZONE(MONO) Bi-Amp 2CH



For details, see "Amp Assign / Multi Zone Connections and Operations" (page 68, 69).

2 Volume Control

Set the main zone volume setting.

Volume Limit

Make a setting for maximum volume.

[Selectable items] **OFF** **-20dB** **-10dB** **0dB**

Power On Level

This sets the volume set when the main zone's power is turned on.

[Selectable items] **Last** **---** **-80dB ~ +18dB**

Mute Level

This sets the amount of attenuation of the volume when the mute mode is set in the main zone.

[Selectable items] **Full** **-40dB** **-20dB**

3 Source Delete

Remove input sources that are not used from the display.

[Selectable items] **ON** **Delete**

NOTE

- Input sources being used in the various zones cannot be deleted.
- Input sources set to "Delete" cannot be selected from GUI menu "Source Select" or using the **SOURCE SELECT** knob on the main unit or **SOURCE SELECT** button on the remote control unit.

4 GUI

Make GUI related settings.

Screensaver

Make screensaver settings.

Use the screensaver to prevent burn-in on the monitor screen. When set to "ON", the screensaver is activated if there is no activity for about 3 minutes.

[Selectable items] **ON** **OFF**

Wall Paper

Change the GUI background.

[Selectable items] **Picture** **Black** **Gray** **Blue**

Format

Select the video output signal format to match the monitor.

[Selectable items] **NTSC** **PAL**

NOTE

When a format other than the video format of the connected monitor is set, the picture will not be displayed properly. Use the procedure described below to change the video format.



Operating from the main unit

- ① Press and hold the **STATUS** and **RETURN** buttons for at least 3 seconds.
"Video Format" appears on the display.
- ② Use the <|> button to make the setting.
- ③ Press the **ENTER**, **MENU** or **RETURN** button to complete the setting.

```
*Video Format
< NTSC >
```

Text

Text information display.

[Selectable items] **ON** **OFF**

Master Volume

Master volume display during adjustment.

[Selectable items] **ON** **OFF**

NET/USB / iPod / Tuner

This sets the time the on-screen display is displayed when an operation is performed.

[Selectable items] **Always** **30s** **10s** **OFF**

5 Quick Select Name

Change the Quick Select name.
Up to 16 characters can be input.

[Input characters] **A ~ Z** **a ~ z** **0 ~ 9**

! " # % & ' () * + , - . / : ; < = > ? @ [\] (space)

6 Trigger Out 1

Select the conditions to turn on the trigger out 1 with respect to the zone, input source, surround mode. For details about the trigger out function, see page 21.

7 Trigger Out 2

This sets the conditions to turn on the trigger out 2, in the same way as "Trigger Out 1" above.

[Selectable items] **ON** ---

Setting with Respect to the Zone

- When the power of the zone turned on/off, the trigger out turns on.
- Associated with the power supply of zones set to "ON".

Setting with Respect to the Input Source

- When the input source set to on is selected, the trigger out turns on.
- Associated with respect to the input source for zones set to "ON" at "Setting with Respect to the Zone".

Setting with Respect to the Surround Mode

- When the surround mode set to on is selected, the trigger out turns on.
- Associated with respect to surround modes that are set to "ON".
- This can be set if the "MAIN ZONE" setting at "Setting with Respect to the Zone" is set to "ON".
- Associated when an input source for which "Setting with Respect to the Input Source" is set to "ON" is selected.

8 Remote ID

Set remote control ID. Match the ID setting of the remote control unit and the receiver.

[Selectable items] **1** **2** **3** **4**



- When changing the remote ID, also change the AMP, iPod, TU and NET/DTU modes of the main remote control unit at the same time (☞ page 62).
- When changing the remote ID, also change the sub remote control unit at the same time (☞ page 67).

9 2Way Remote

Make setting for 2-way remote control unit.

[Selectable items] **Used** **Not Used**



When using a 2-way remote control unit (RC-7000CI and RC-7001RCI, sold separately), set this to "Used".

10 Dimmer

Adjust display brightness of the receiver.

[Selectable items] **Bright** **Dim** **Dark** **OFF**



Operating from the main unit

Press the **DIMMER** button.



11 Setup Lock

Protect settings from inadvertent change.

[Selectable items] **ON** **OFF**



- When "Setup Lock" is set to "ON", the settings listed below can no longer be changed. Also, "SETUP LOCKED!" is displayed if you attempt to operate related buttons.
 - GUI menu operations
 - RESTORER
 - Night Mode
 - Parameter
 - Room EQ
 - Channel Level
 - Audio Delay
- To cancel the setting, press the **MENU** button to re-display the "Setup Lock" screen, then change the setting to "OFF".

12 Maintenance Mode

This sets the function for maintenance by a DENON serviceperson or installer. (For professional use only.)

This function allows a DENON serviceperson or installer to check the AVR-3808CI's status and make settings via the Internet.

NOTE

Only use this function if so instructed by a DENON serviceperson or installer.

13 Firmware Update

Update the firmware of the receiver.

[Selectable items]

Start :

Execute the update process.

When updating starts, the power indicator lights red. "Updating ***" is shown on the display during updating. Once updating is completed, "Updating complete" is displayed.

"Latest firmware" is displayed when the firmware is the latest version.

※ If the display reads as shown below, check the settings and network environment, then update again.

Display	Description
Updating failed	Updating failed.
Login failed	Failure to log into server.
Server is busy	Server is busy. Wait a while then try again.
Connection failed	Failure connecting to server.
Regist failed	Failure registering to server.

NOTE

- Connection to the network and specific settings are required to update the firmware. For details, see page 20, 32.
- Do not turn off the power until updating is completed.
- Normally there is no need to use this function, aside from the cases described below.
 - The Firmware Update function is only used for updating the firmware (free or for a charge) via the Internet, for example for the purpose of adding functions to the AVR-3808CI in the future.
 - Information regarding the Firmware Update function will be announced on the DENON web site each time related plans are defined.
 - A broadband connection to the Internet is required to use this function (see page 20).
 - Even with a broadband connection to the Internet, approximately 1 hour is required for the updating procedure to be completed. Once updating starts, normal operations on the AVR-3808CI cannot be performed until updating is completed.
- Furthermore, updating the firmware may reset the backup data for the parameters, etc., set for the AVR-3808CI.

Language

This sets the language used on the display screens.

● Menu tree ●

Manual Setup

Language

[Selectable items]

English

Français



Operating from the main unit

- ① Press and hold the **STATUS** and **RETURN** buttons for at least 3 seconds.
"Video Format" appears on the display.
- ② Use the Δ / ∇ button to set "GUI Language".
- ③ Use the \triangleleft / \triangleright button to make the setting.
- ④ Press the **ENTER**, **MENU** or **RETURN** button to complete the setting.

```
*GUI Language  
< ENGLISH >
```

Source Select

Use this procedure to select the input source and make the settings related to playing input sources.

Input Source Selection

● Menu tree ●

Source Select

TUNER

PHONO

CD

DVD

HDP

TV/CBL

SAT

VCR

DVR

V.AUX

NET/USB

XM



Operating from the main unit or main remote control unit

Operation on the main unitG

Turn the **SOURCE SELECT** knob.

※ If "Rec Select" or "Video Select" is selected for the input source, press the **SOURCE** button before turning the **SOURCE SELECT** knob.

Operation on the main remote control unitG

Press the **SOURCE SELECT** button.

The desired input source can be selected directly.



(Main unit)

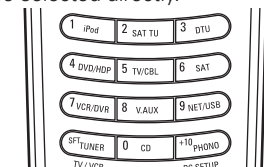

(Main remote control unit)



To operate the AVR-3808CI using the main remote control unit, set the remote control unit to the AMP mode (see page 59 "Remote Control Unit Operations").

Settings Related to Playing Input Sources GUI

● Menu tree ●

Source Select

- TUNER**
 - 1 Play
 - 2 Auto Preset
 - 3 Preset Skip
 - 4 Preset Name
 - 5 Input Mode
 - 6 Rename
 - 7 Other
- PHONO**
 - 5 Input Mode
 - 6 Rename
 - 7 Other
- CD, DVD, HDP, TV/CBL, SAT, VCR, DVR, V.AUX**
 - 1 Play*
 - 8 Playback Mode (iPod)*
 - 9 Assign
 - 5 Input Mode
 - 6 Rename
 - 7 Other
- NET/USB**
 - 1 Play
 - 10 Playback Mode
 - 5 Input Mode
 - 6 Rename
 - 7 Other

Source Select

XM

- 1 Play
- 3 Preset Skip
- 11 Antenna Aiming
- 5 Input Mode
- 6 Rename
- 7 Other

* : "Play" and "Playback Mode (iPod)" are displayed for input sources for which "iPod dock" is assigned.

1 Play

The playback screen is displayed.

[Input source] **TUNER** **NET/USB** **XM** (iPod)

2 Auto Preset

Use the auto preset function to program radio stations.

[Input source] **TUNER**

[Selectable items] **Start**



If an FM station cannot be preset automatically, select the desired station by tuning it in manually, then preset it manually.

3 Preset Skip

Set the preset memories that you do not want to display when tuning.

A ~ G

Select the preset channel(s) you do not want to display.

[Input source] **TUNER** **XM**

[Selectable items] **All** 1 2 3 4 5 6 7 8

[Selectable items] **ON** **Skip**



When set to "All" to "Skip", it is possible to skip entire preset memory blocks (A to G).

4 Preset Name

Assign name to a preset memory.
Names containing up to 8 characters can be input.

A1 ~ G8

Select the preset memory number.

[Input source] **TUNER**

[Characters that can be input]

A ~ Z **a ~ z** **0 ~ 9** ! " # % & ' () * + , - . / : ; < = > ? @ [\] (space)

5 Input Mode

Make input mode and decode mode settings for this source.
The selectable input modes depend on the input source and "Assign" setting (see page 39).

Input Mode

Set the input mode for this source.

[Input source] **TUNER** **PHONO** (iPod)

[Selectable items] **Analog** **EXT. IN**

[Input source] **NET/USB** **XM**

[Selectable items] **Auto** **EXT. IN**

[Input source]

CD **DVD** **HDP** **TV/CBL** **SAT** **VCR** **DVR** **V.AUX**

[Selectable items]

Auto **HDMI** **Digital** **Analog** **EXT. IN**



- When a digital signal is properly input, the "[DIG]" indicator lights on the display. If the "[DIG]" indicator does not light, check the digital input connector assignment and the connections.
- The surround mode cannot be set if the input mode is set to "EXT. IN".



Operating from the main unit or main remote control unit

Press the **INPUT MODE** button on the main unit or the **INPUT** button on the main remote control unit.



- *1: This can be selected for input sources for which the GUI menu "Assign" setting is set to "HDMI" (page 39). Excluding CD.
- *2: This can be selected for input sources for which the GUI menu "Assign" setting is set to "Digital" (page 39).

Decode Mode

Set the decode mode for this source.

[Input source] **CD** **DVD** **HDP** **TV/CBL** **SAT** **VCR**
DVR **V.AUX**

[Selectable items] **Auto** **PCM** **DTS**



- This can be selected for input sources for which the GUI menu "Assign" setting is set to "HDMI" or "Digital" (page 39).
- Only set "PCM" and "DTS" when playing the respective signals.

6 Rename

Change the display name for this source.
Names containing up to 8 characters can be input.

[Characters that can be input]

A ~ Z **a ~ z** **0 ~ 9** **! " # % & ' () * + , - . / : ; < = > ? @ [\] (space)**

7 Other

Make various other settings.

Video Select

Switch video input source while listening to audio signal.

[Selectable items]

DVD **HDP** **TV/CBL** **SAT** **VCR** **DVR** **V.AUX** **Source**



Operating from the main unit

Press the **VIDEO SELECT** button, then turn the **SOURCE SELECT** knob until the desired picture appears.

※ To cancel, press the main unit's **VIDEO SELECT** button, then turn the main unit's **SOURCE SELECT** knob and select "Source".

NOTE

- It is not possible to select HDMI input signals.
- When playing HDMI video input signals, the analog video signal of another input source cannot be selected for the HDMI video output.
- Input sources for which "Delete" is selected at "Source Delete" cannot be selected.

Video Convert

Automatically convert video input signal to monitor output format.

[Input source] **DVD** **HDP** **TV/CBL** **SAT** **VCR** **DVR**
V.AUX

[Selectable items] **ON** **OFF**

NOTE

When a non-standard video signal from a game machine or some other source is input, the video conversion function might not operate. If this happens, please set the conversion mode to "OFF".

Source Level

Corrects the playback level of the selected input source's audio input.

[Variable range] **-12dB** ~ **0dB** ~ **+12dB**



For input sources for which "HDMI" or "Digital" are set at the GUI menu "Assign" setting, the analog input level and digital input level can be set separately.

8 Playback Mode (iPod)

Make settings for "iPod" playback.

Repeat

Make settings for repeat mode.

[Input source] **CD** **DVD** **HDP** **TV/CBL** **SAT** **VCR**
DVR **V.AUX**

[Selectable items] **All** **One** **OFF**

Shuffle

Make settings for shuffle mode.

[Input source] **CD** **DVD** **HDP** **TV/CBL** **SAT** **VCR**
DVR **V.AUX**

[Selectable items] **Songs** **Albums** **OFF**



This can be selected for input sources for which "Assign" is assigned at the "iPod dock" setting.

9 Assign

Assign input sources to input connectors.

HDMI

Select HDMI connector to assign to this source.

[Input source]

[Selectable items]

Input source	DVD	HDP	TV/CBL	SAT	VCR	DVR	V.AUX
Default setting	HDMI1	HDMI2	HDMI3	None	None	HDMI4	None



- With HDMI, the video and audio signals are transferred simultaneously. When HDMI is assigned to an input source, the audio signal switches to HDMI along with the video signal. To use with the digital audio input connectors assigned, set GUI menu "Input Mode" to "Digital" (page 37, 38).
- When the AVR-3808CI and monitor are connected with an HDMI cable, if the monitor is not compatible with HDMI audio signal playback, only the video signals are output to the monitor.
- The audio signals input from the analog, digital and EXT. IN connectors are not output to the monitor.

NOTE

This cannot be set for input sources for which "iPod dock" is assigned.

Digital

Select digital input connector to assign to this source.

[Input source]

[Selectable items]

Input source	CD	DVD	HDP	TV/CBL	SAT	VCR	DVR	V.AUX
Default setting	Coaxial 3	Coaxial 1	None	Coaxial 2	Optical 1	Optical 3	Optical 2	Optical 4

*: When a DENON DVD player and the DENON LINK have been connected, be sure to make a setting to "DENON LINK".

NOTE

- This cannot be set for input sources for which "iPod dock" is assigned.
- When "DENON LINK" is assigned at the GUI menu "Assign" setting, the PCM signals, network audio signals (Internet radio, music server and USB), XM signals input from the digital input connectors cannot be output from the ZONE2 and ZONE3 audio output connectors and the analog REC OUT connectors.

Component

Select component video input to assign to this source.

[Input source]

[Selectable items]

Input source	DVD	HDP	TV/CBL	SAT	VCR	DVR	V.AUX
Default setting	Component 1	Component 2	Component 3	None	None	None	None

NOTE

This cannot be set for input sources for which "iPod dock" is assigned.

iPod dock

Assign Control Dock for iPod to this source.

[Input source]

[Selectable items]



- With the default settings, the Control Dock for iPod can be used connected to the VCR (iPod) connector.
- Even if "iPod dock" is set to "Assign", if the AVR-3808CI is not connected to a Control dock for iPod, the input source can be used as the normal input source.

10 Playback Mode

Make settings for "NET/USB" playback.

[Input source]

USB Select

Select USB port to use.

[Selectable items]



Match the port to be used and the setting.

Repeat

Make settings for repeat mode.

[Selectable items]

Random

Make random mode settings.

[Selectable items]

Direct Play

Set the folder to be played using the **DIRECT PLAY** button on the sub remote control unit.

[Selectable items]

Antenna Aiming

Adjust the XM radio reception sensitivity.

[Input source] **XM**

Satellite

Indicate satellite signal strength.

Terrestrial

Indicate terrestrial signal strength.

Display	Condition
■■■■■	Signal strength is strong
■■■■	Signal strength is good
■■■	Signal strength is marginal
■■	Signal strength is weak
■	No signal

Surround Modes

Standard Playback

This is the standard mode for enjoying surround sound according to the program source.

Surround Playback of 2-channel Sources

To select these surround modes using the buttons on the main unit and main remote control unit, press the **STANDARD** button. The mode switches each time the button is pressed.

- When using a surround back speaker

[Selectable items] **DOLBY PLIIx** **DTS NEO:6** **neural**

- When not using a surround back speaker

[Selectable items] **DOLBY PLII** **DTS NEO:6** **neural**

DOLBY PLIIx or **DOLBY PLII** : The signals are decoded in DOLBY PLIIx or DOLBY PLII for playback.

- **Cinema** : This mode is suited for movie sources.
- **Music** : This mode is suited for music sources.
- **Game** : This mode is suited for games.
- **Pro Logic** : This is the Pro Logic playback mode. This can be selected when playing with a DOLBY PLII decoder. When this mode is selected, "DOLBY PL" is displayed.

DTS NEO:6 : The signals are decoded in DTS NEO:6 for playback.

- **Cinema** : This mode is suited for movie sources.
- **Music** : This mode is suited for music sources.

neural : It is possible to play analog input signals and PCM (2-channel, 48 kHz or less) in the surround mode. This is the optimum mode for playing sources recorded in XM HD Surround (page 74).



Select the "Cinema," "Music," "Game" and "Pro Logic" modes at GUI menu "Parameter" – "Audio" – "Surround Parameters" – "Mode" (page 41).

Playing Multi-channel Sources (Dolby Digital, DTS, etc.)

[Selectable items]

STANDARD :

This mode is for decoding the input signals according to their format and playing surround sound. The display when the STANDARD mode is selected depends on the input signal and surround back output playback mode.

Input signal		Display
Dolby Digital Source	DOLBY DIGITAL (other than 2ch) / DOLBY DIGITAL EX	DOLBY DIGITAL DOLBY DIGITAL EX DOLBY DIGITAL+PLIIx CINEMA DOLBY DIGITAL+PLIIx MUSIC
	DOLBY DIGITAL Plus	DOLBY DIGITAL +
	DOLBY TrueHD	DOLBY TrueHD
DTS Surround Source	DTS (5.1ch) / DTS-ES Discrete 6.1 / DTS-ES Matrix 6.1 / DTS 96/24	DTS SURROUND DTS+PLIIx CINEMA DTS+PLIIx MUSIC DTS+NEO:6 DTS ES MTRX6.1 (*1) DTS ES DSCRT6.1 (*2) DTS 96/24 (*3)
	DTS-HD High Resolution Audio	DTS-HD HI RES
	DTS-HD Master Audio	DTS-HD MSTR
	DVD-Audio, SACD	PCM (multi ch) / DSD (multi ch)

*1 : This is displayed when the input signal is "DTS-ES Matrix 6.1" and the AVR-3808CI's "AFDM" setting is set to "ON".

*2 : This is displayed when the input signal is "DTS-ES Discrete 6.1".

*3 : This is displayed when the input signal is "DTS 96/24".



For details, see page 77.

DSP Simulation Playback

The desired mode according to the program source and viewing situation can be selected from among 10 DENON original surround modes.

The surround parameters can be adjusted (☞ page 77, 78) to achieve an even more realistic, powerful sound field.

[Selectable items]

- 7CH STEREO** : This mode is for enjoying stereo sound from all speakers.
- WIDE SCREEN** : This mode is for enjoying the atmosphere of viewing a movie on a large screen.
- SUPER STADIUM** : This mode is suited for viewing sports programs.
- ROCK ARENA** : This mode is for enjoying the atmosphere of a live concert in an arena.
- JAZZ CLUB** : This mode is for enjoying the atmosphere of a live concert in a jazz club.
- CLASSIC CONCERT** : This mode is for appreciating classical concert programs.
- MONO MOVIE** * : This mode is for playing monaural movie sources with surround sound.
- VIDEO GAME** : This mode is suited for achieving surround sound with video games.
- MATRIX** : This mode lets you add a sense of expansion to stereo music sources.
- VIRTUAL** : This mode is for enjoying surround effects using only the front speakers or headphones.

* : When playing sources recorded in monaural in the MONO MOVIE mode, the sound will be off balance with a single channel (left or right), so input to both channels.



- To select these surround modes using the buttons on the main remote control unit, press the **SIMU** button. The mode switches each time the button is pressed.
- Depending on the program source being played, it may not be possible to achieve a satisfactory surround effect. In this case, try other modes to achieve a sound field suited to your tastes.

Stereo Playback

[Selectable items]

STEREO :

This is the mode for playing in stereo. The tone can be adjusted. Sound is output from the front left and right speakers and subwoofer.

Direct Playback

[Selectable items]

DIRECT :

In this mode the signals bypass the tone control circuitry for high quality sound.

The sound is output to the same channels as the input signal.

The display when the DIRECT mode is selected depends on the input signal.

For multi-channel sources, the display depends on the surround back output's play mode.

Input signal	Display
Analog signal / PCM (2ch) / Dolby Digital source / DTS source / Other 2-channel digital signals	DIRECT
DSD (2ch)	DSD DIRECT (*) MULTI CH DIRECT
PCM (multi ch)	M DIRECT + PLIIx CINEMA
	M DIRECT + PLIIx MUSIC
	M DIRECT 7.1
DSD (multi ch)	DSD MULTI DIRECT (*)

* : When DSD signals are converted to PCM signals as set by the audio parameters and speaker settings, "DIRECT" or "MULTI CH DIRECT" is displayed.



For details, see page 78.

Playback in the Pure Direct Mode

This is the mode that recreates the original sound most faithfully, providing extremely high quality sound.

Press the PURE DIRECT button.



- When in the PURE DIRECT mode, the GUI screen is not displayed and the display on the main unit is turned off.
- If the HDMI input connector is selected, video outputs are output in the PURE DIRECT mode.
- The channel level and surround parameters in the PURE DIRECT mode are the same as in the DIRECT mode.



Parameter

Parameters can be called out directly by pressing the **PARA** button on the main remote control unit.



Audio

Adjust various audio parameters.



Menu tree

Parameter

Audio

- 1 Surround Parameters
- 2 Tone
- 3 Room EQ
- 4 RESTORER
- 5 Night Mode
- 6 Audio Delay

1 Surround Parameters

Adjust surround sound parameters.

The adjustable parameters differ for the different surround modes (☞ page 75, 76).

Mode

Select the mode according to the playback source.

[Selectable items]

In the PLIIx or PLII mode: **Cinema** **Music** **Game**
Pro Logic *

In the DTS NEO:6 mode: **Cinema** **Music**

* : Can be selected in the PLII mode.



The "Music" mode is also effective for movie sources including a lot of stereo music.

Cinema EQ

Soften the treble range of movie soundtracks for better understanding.

[Selectable items] ON OFF

DRC

Compress dynamic range (difference between loud and soft sounds).

[Selectable items] Auto Low Middle High OFF



This can be set in the Dolby TrueHD mode.

D.COMP

Compress dynamic range (difference between loud and soft sounds).

[Selectable items] OFF Low Middle High



When playing DTS sources, this is only displayed for compatible software.

LFE

Adjust the low-frequency effects level (LFE).

[Variable range] ~



For proper playback of the different program sources, we recommend setting to the values below.

- Dolby Digital sources: "0 dB"
- DTS movie sources: "0 dB"
- DTS music sources: "-10 dB"

Center Image

Assign center channel signal to front left and right channels for wider sound.

[Variable range] ~ ~

Panorama

Assign front L/R signal also to surround channels, for wider sound.

[Selectable items] ON OFF

Dimension

Shift sound image center to front or rear, to adjust playback balance.

[Variable range] ~ ~

Center Width

Assign center channel signal to front left and right channels for wider sound.

[Variable range] ~ ~

Delay Time

Adjust delay time to control sound stage size.

[Variable range] ~ ~

Effect

Switch effect signal for multi-surround speakers on and off.

[Selectable items] ON OFF

Effect Level

Adjust effect signal level.

[Variable range] ~ ~



Set to a lower level if the positioning and sense of phase of the surround signals seems unnatural.

Room Size

Determine size of acoustic environment.

[Selectable items] Small Medium small Medium Medium large Large

NOTE

"Room Size" does not indicate the size of the room in which sources are played.

AFDM

Auto-select surround mode by source.

This function only works for software containing a special identification signal.

If the software being played is recorded in Dolby Digital EX or DTS-ES, it is played in 6.1-channels. If not, it is played in 5.1-channels.

[Selectable items] ON OFF

Example : Playing Dolby Digital software (with EX flag)

- When "AFDM" is set to "ON", the surround mode is automatically set to the DOLBY D + PLIIx C mode.
- To play in the DOLBY DIGITAL EX mode, set "AFDM" to "OFF" and "SB CH Out" to "MTRX ON".



Some Dolby Digital EX sources do not include EX flags. If the playback mode does not switch automatically even when "AFDM" is set to "ON", set "SB CH Out" to "MTRX ON" or "PLIIx CINEMA".

SB CH Out (for Multi-channel sources)

Select playback mode for surround back channels.

[Selectable items]

NON MTRX MTRX ON PLIIx CINEMA *1 PLIIx MUSIC *2
 ES MTRX *3 ES DSCRT *4 DSCRT ON OFF

*1: This can be selected when "Surround Back" is set to "2spkr" at the GUI menu "Manual Setup" – "Speaker Setup" – "Speaker Configuration" setting (page 28).

*2: This can be selected when "Surround Back" is set to "2spkr" or "1spkr" at the GUI menu "Manual Setup" – "Speaker Setup" – "Speaker Configuration" setting.

*3: This can be selected when playing DTS sources.

*4: This can be selected when playing DTS sources including a discrete 6.1-channel signal identification signal.

SB CH Out (for 2-channel sources)

Determine whether to use surround back speakers.

[Selectable items] ON OFF

Subwoofer Att.

Attenuate subwoofer level when using EXT. IN mode.

[Selectable items] **ON** **OFF**



Set this to "ON" if the subwoofer channel level seems too high when playing Super Audio CD.

Subwoofer

Turn subwoofer output on and off.

[Selectable items] **ON** **OFF**

Default

Resets the settings to the default values.

2 Tone

Adjust the tonal quality of the sound.

Tone Defeat

Turn tone adjustments off.

[Selectable items] **ON** **OFF**



The tone cannot be adjusted when in the DIRECT mode.

Bass

Adjust low frequency range (bass).

[Variable range] **-6dB ~ +6dB**

Treble

Adjust high frequency range (treble).

[Variable range] **-6dB ~ +6dB**



"Bass" and "Treble" can be set when "Tone Defeat" is set to "OFF".

3 Room EQ

Select room equalizer for current environment.

[Selectable items]

Audyssey : Optimize frequency response of all speakers.

Audyssey Byp. L/R : Optimize frequency response of speakers except front L and R speakers.

Audyssey Flat : Optimize frequency response of all speakers to flat response.

Manual : Apply frequency response set with "Manual EQ."

OFF : Turn equalizer off.



Operating from the main unit or main remote control unit

Press the **ROOM EQ** button on the main unit or the **EQ** button on the main remote control.



When "Audyssey" is selected, "**AUDYSSEY MULTEQ XT**" lights.

When "Audyssey Byp. L/R" or "Audyssey Flat" is selected, or when the auto setup measuring results have changed, "**AUDYSSEY MULTEQ XT**" lights.



- "Audyssey", "Audyssey Byp. L/R" and "Audyssey Flat" can be selected after the auto setup procedure has been performed.
- If the settings of the speakers for which "None" has been determined at "Auto Setup" are changed, "Audyssey", "Audyssey Byp. L/R" and "Audyssey Flat" cannot be selected and measurements have to be taken again to include the newly-added speakers.
- When using headphones, "Room EQ" is always set to "OFF".

4 RESTORER

This function restores compressed audio signals to how they were before compression and corrects the sense of volume of the bass to obtain richer playback sound.

[Selectable items]

OFF

Mode1 (RESTORER 64)

Mode2 (RESTORER 96)

Mode3 (RESTORER HQ)

The default setting for "NET/USB" and "iPod" is "Mode3". All others are set to "OFF".



Operating from the main unit or main remote control unit

During playback, press the **RESTORER** button on the main unit or the **RSTR** button on the main remote control unit.

When set to something other than "OFF", "**RESTORER**" is displayed.

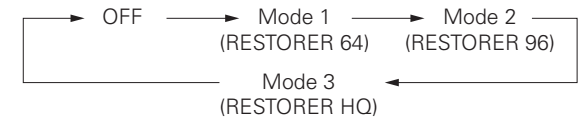

About the RESTORER function

- Such compressed audio formats as MP3, WMA (Windows Media Audio) and MPEG-4 AAC reduce the amount of data by eliminating signal components that are hard for the human ear to hear. The RESTORER function generates the signals eliminated upon compression, restoring the sound to conditions near those of the original sound before compression. It also corrects the sense of volume of the bass to obtain richer sound with compressed audio signals.
- This is displayed on the GUI menu and can be set when the input source is set to "XM" or "NET/USB"; or when analog signals (including AM/FM signals) or PCM signals (fs = 44.1/48 kHz) are input.

5 Night Mode

Optimized setting for late-night listening.

[Selectable items] **OFF** **Low** **Middle** **High**



Operating from the main remote control unit

Press the **NGT** button.

The "**NIGHT**" indicator lights when "Low," "Middle" or "High" is selected.

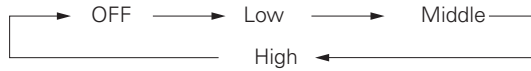

6 Audio Delay

Compensate for mismatched timing between video and audio.

Delay audio.

This sets the delay time for audio signals.

[Variable range] **0 ms** ~ **200 ms**



Operating from the main unit or main remote control unit

- Press the **AUDIO DELAY** button on the main unit or the **A. DL** button on the main remote control unit.
- Use the **◀▶** button to set.



- This cannot be adjusted when playing in the EXT. IN, DIRECT or STEREO mode (with "Front" set to "Large," "Tone Defeat" to "ON" and "Room EQ" to "OFF").
- The adjustment range is 0 to 100 ms when the Auto Lipsync Correction function is activated.

Picture Adjust

Adjust the picture quality.

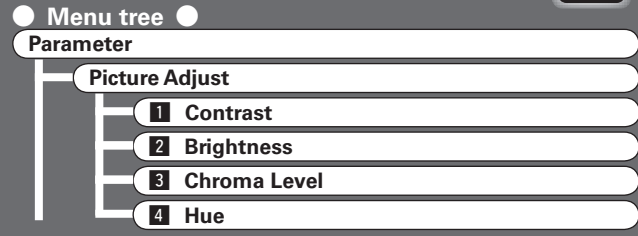

1 Contrast

Adjust picture contrast.

[Variable range] **-6** ~ **0** ~ **+6**

2 Brightness

Adjust picture brightness.

[Variable range] **0** ~ **+12**

3 Chroma Level

Adjust picture chroma level (saturation).

[Variable range] **-6** ~ **0** ~ **+6**

4 Hue

Adjust color hue.

[Variable range] **-6** ~ **0** ~ **+6**



- Adjusting the "Contrast," "Brightness," "Chroma Level" and "Hue" settings does not affect the HDMI input signal.
- "Hue" can be adjusted for composite video and S-Video signals.
- The adjustment values are stored for the individual input sources.

Information



Status

Shows information about current settings.

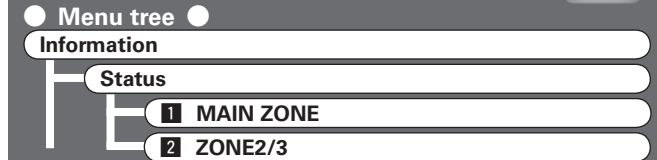

1 MAIN ZONE

Shows information about settings for main zone.
The items displayed differ according to the input source.

[Items to be checked]

Select Source	Name	Surround Mode	Input Mode
Assign	Room EQ	Video Select	Src Level
Night Mode	RESTORER	etc.	Rec Select

2 ZONE2/3

Shows information about settings for multi-zone.

[Items to be checked] **Power** **Select Source** **Volume Level**

Audio Input Signal

Shows information about audio input signals.



- Menu tree ●
- Information
 - Audio Input Signal

[Items to be checked]

- Surround Mode** : The currently set surround mode is displayed.
- Signal** : The input signal type is displayed.
- fs** : The input signal's sampling frequency is displayed.
- Format** : The number of channels in the input signal (front, surround, LFE) is displayed.
- Offset** : The dialogue normalization correction value is displayed.
- Flag** : "MATRIX" is displayed if the input signal has undergone matrix processing, "DISCRETE" if the input signal has undergone discrete processing.

Dialogue normalization function

This is automatically activated when playing Dolby Digital sources. This function automatically corrects the standard signal level for individual program sources. The correction value can be checked using the **STATUS** button on the main unit.



The figure is the correction value when the standard level is corrected.

HDMI Information

Shows information about HDMI input/output signals and monitor.



- Menu tree ●
- Information
 - HDMI Information
 - 1 Signal Information
 - 2 Monitor

1 Signal Information

The HDMI input/output signal information is displayed.

[Items to be checked] Resolution Color Space Pixel Depth

2 Monitor

The HDMI monitor information is displayed.

[Items to be checked] Interface Supported resol.

Auto Surround

Shows information about auto surround mode settings. The surround mode for which the last memory function was used for the different input signal types is displayed.



- Menu tree ●
- Information
 - Auto Surround

[Items to be checked]

Analog/PCM 2ch Digital 2ch Digital 5.1ch Multi ch

Quick Select

Shows information about quick select settings.



- Menu tree ●
- Information
 - Quick Select
 - 1
 - 2
 - 3

[Items to be checked]

Input Source Input Mode Room EQ
Auto Surround Mode setting Volume Level



For instructions on storing settings at Quick Select 1 to 3, see page 57.

Preset Station

Shows information about preset stations.



- Menu tree ●
- Information
 - Preset Station
 - A
 - B
 - C
 - D
 - E
 - F
 - G

[Input source] TUNER XM NET/USB

[Items to be checked] A1 ~ G8



When the **STATUS** button on the main unit is pressed, the set's status can be checked on the display.

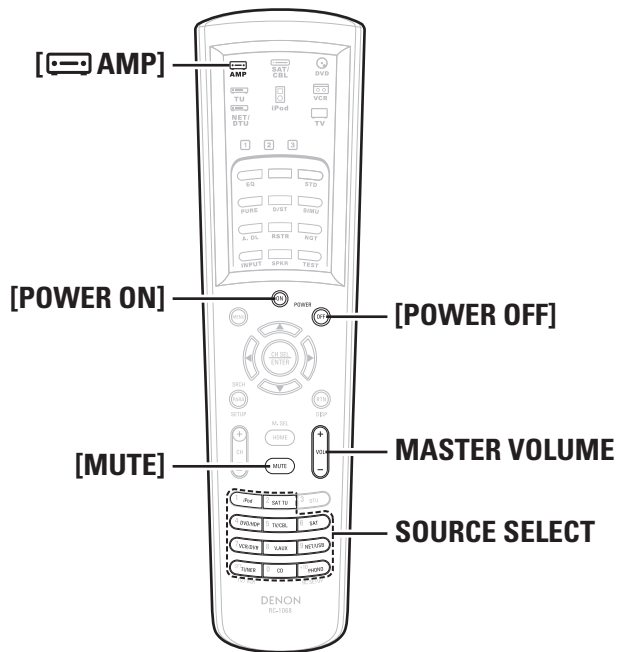
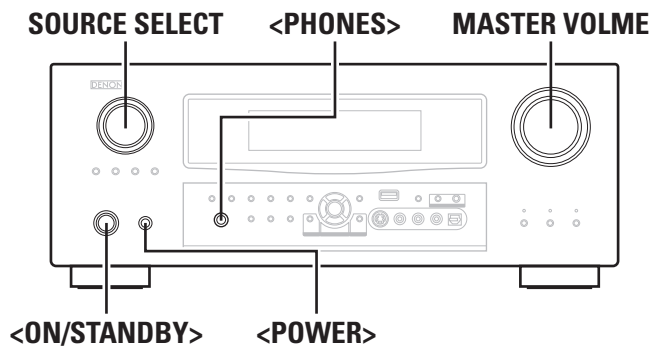

About the button names in these explanations
 < > : Buttons on the main unit
 [] : Buttons on the remote control unit
Button name only:
 Buttons on the main unit and remote control unit

Playback

Preparations

Turning the Power On

- 1 Press **<POWER>**.
The power indicator lights red and the power is set to the standby mode.
- 2 Press **<ON/STANDBY>** or **[POWER ON]**.
The power indicator flashes green and the power turns on.

To operate the AVR-3808CI using the main remote control unit, set the remote control unit to the AMP mode (see page 59 "Remote Control Unit Operations").

Turning the Power Off

- 1 Press **<ON/STANDBY>** or **[POWER OFF]**.
The power is set to the standby mode.
- 2 Press **<POWER>**.
The power indicator turns off, and so does the power.

NOTE
 Power continues to be supplied to some of the circuitry even when the power is in the standby mode. When leaving home for long periods of time or when traveling, either press **<POWER>** to turn off the power, or unplug the power cord from the power outlet.

Operations During Playback

Adjusting the Master Volume

Either turn **<MASTER VOLUME>** or press **[MASTER VOLUME]**.

Turning Off the Sound Temporarily (Muting)

Press **[MUTE]**.

To cancel, press **[MUTE]** again. Muting can also be canceled by adjusting the master volume.

Listening with Headphones

Plug the headphones into <PHONES>.
 The sound from the speakers and pre-out connectors is automatically cut.

NOTE
 Be careful not to set the volume too high when using headphones.

Playing Video and Audio Equipment

Basic Operation

- 1 Prepare the equipment.
 - 1 Load the DVD, CD or other software in the player. (See the operating instructions of the respective devices.)
 - 2 To play a video device, switch the monitor input. (See the monitor's operating instructions.)
- 2 To operate using the main remote control unit, set the remote control unit to the AMP mode. (See page 59 "Remote Control Unit Operations")
- 3 Use **SOURCE SELECT** to select the input source.
GUI : "Source Select" (See page 36, 37)
- 4 Start playback. (See the operating instructions of the respective devices.)

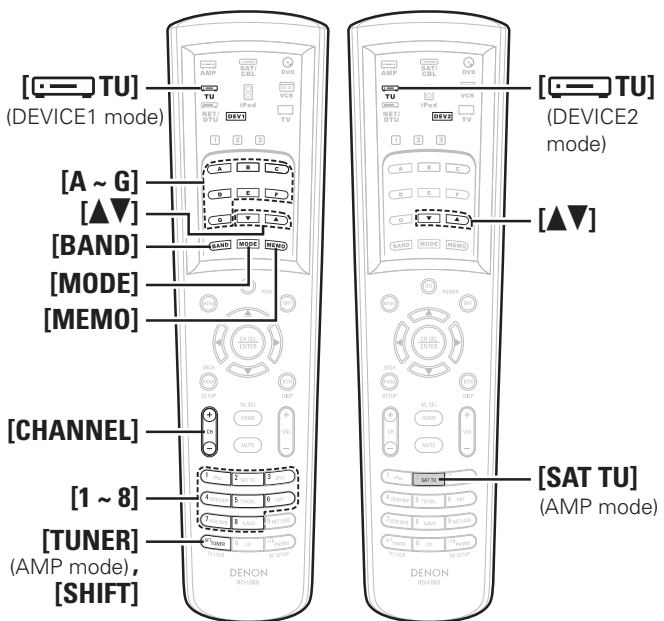
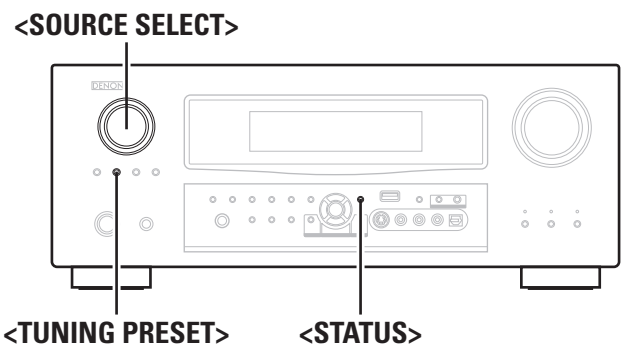

About the button names in these explanations

< > : Buttons on the main unit

[] : Buttons on the remote control unit

Button name only:

Buttons on the main unit and remote control unit

Listening to FM/AM Broadcasts

Basic Operation

1 Either turn **<SOURCE SELECT>** or press **[TUNER]** (AMP mode) to select "TUNER".

GUI : "Source Select" (☞ page 36, 37)

2 To operate using the main remote control unit, set the remote control unit to the TUNER (DEVICE1) mode.
(☞ page 59 "Remote Control Unit Operations")

3 Press **[BAND]** to select "FM" or "AM".

4 Tune in the desired broadcast station.

- ① **To tune in automatically (Auto Tuning)**
Press **[MODE]** to light the "AUTO" indicator on the display, then use **[▲▼]** to select the station you want to hear.
- ② **To tune in manually (Manual Tuning)**
Press **[MODE]** to turn off the display's "AUTO" indicator, then use **[▲▼]** to select the station you want to hear.

- It is also possible to switch to "FM" or "AM" in step 1 by pressing **[TUNER]**.
- If the desired station cannot be tuned in with auto tuning, tune it in manually.
- When tuning in stations manually, press and hold **[▲▼]** to change frequencies continuously.
- The time for which the GUI menus are displayed can be set at GUI menu "Manual Setup" – "Option Setup" – "GUI" – "Tuner" (☞ page 34).

Presetting Radio Stations (Preset Memory)

Your favorite broadcast stations can be preset so that you can tune them in easily. Up to 56 stations can be preset.

1 Tune in the broadcast station you want to preset.

2 Press **[MEMO]**.

3 Press **[A ~ G]** to select the block in which the station is to be preset, then press **[CHANNEL]** or **[1 ~ 8]** to select the preset number.

※ The memory block can also be selected by pressing **[SHIFT]**.

4 Press **[MEMO]** again to complete the setting.

- To preset other stations, repeat steps 1 to 4.
- Stations can be preset automatically at GUI menu "Source Select" – "Tuner" – "Auto Preset" (☞ page 37).

NOTE

Preset stations are erased by overwriting them.

Listening to Preset Stations

Operation on the Main Unit

Press **<TUNING PRESET>**, then turn **<SOURCE SELECT>** to select the preset radio station.

Operation on the Main Remote Control Unit

1 Press **[A ~ G]** to select the memory block.

2 Press **[CHANNEL]** or **[1 ~ 8]** to select the desired preset channel.

□ Default settings

Auto tuner presets	
A1 ~ A8	87.5 / 89.1 / 98.1 / 107.9 / 90.1 / 90.1 / 90.1 / 90.1 MHz
B1 ~ B8	520 / 600 / 1000 / 1400 / 1500 / 1710 kHz, 90.1 / 90.1 MHz
C1 ~ C8	90.1 MHz
D1 ~ D8	90.1 MHz
E1 ~ E8	90.1 MHz
F1 ~ F8	90.1 MHz
G1 ~ G8	90.1 MHz

Listening to XM Satellite Radio Programs

About XM Satellite Radio

XM Satellite Radio offers an extraordinary variety of commercial-free music, plus the best in sports, news, talk and entertainment. XM is broadcast in superior digital audio from coast to coast. From rock to reggae, from classical to hip hop, XM has something for every music fan. XM's dedication to playing the richest selection of music is matched by its passion for live sporting events, talk radio, up-to-the-minute news, stand-up comedy, children's programming, and much more. For U.S. customers, information about XM Satellite Radio is available online at www.xmradio.com. For Canadian customers, information about XM Canada is online at www.xmradio.ca.

XM Ready® Legal

Hardware and required monthly subscription sold separately. Other fees and taxes, including a one-time activation fee may apply. Subscription fee is consumer only. All fees and programming subject to change. Channels with frequent explicit language are indicated with an XL. Channel blocking is available for XM radio receivers by calling 1-800-XMRADIO (US residents) and 1-877-GET-XMSR (Canadian residents). For a full listing of the XM commercial-free channels and advertising-supported channels, visit lineup.xmradio.com (US residents) or xmradio.ca (Canadian residents).

Subscriptions subject to Customer Agreement available at xmradio.com (US residents) and xmradio.ca (Canadian residents). Only available in the 48 contiguous United States and Canada. ©2006 XM Satellite Radio Inc. All rights reserved. All other trademarks are the property of their respective owners.

XM Ready® Subscriptions

Once you have installed the XM Mini-Tuner Dock, inserted the XM Mini-Tuner, connected the XM Dock to your XM Ready® home audio system, and installed the antenna, you are ready to subscribe and begin receiving XM programming. There are three places to find your eight character XM Radio ID: on the XM Mini-Tuner, on the XM Mini-Tuner package, and on XM Channel 0. Record the Radio ID in the following eight squares for reference.



Note: The XM Radio ID does not use the letters "I," "O," "S" or "F". Activate your XM Satellite Radio service in the U.S. online at <http://activate.xmradio.com> or call 1-800-XM-RADIO (1-800-967-2346). You will need a major credit card. XM will send a signal from the satellites to activate the full channel lineup. Activation normally takes 10 to 15 minutes, but during peak busy periods you may need to keep your XM Ready home audio system on for up to an hour. When you can access the full channel lineup on your XM Ready home audio system you are done. For more information or to subscribe in Canada, visit XM on the Web at www.xmradio.ca or call XM's Listener Care at 1-877-GET-XMSR (1-877-438-9677).

Basic Operation

1 Either turn **<SOURCE SELECT>** or press **[SAT TU]** (AMP mode) to select "XM".

GUI: "Source Select" (☞ page 36, 37)

2 To operate using the main remote control unit, set the remote control unit to the **TUNER (DEVICE2) mode**.

(☞ page 59 "Remote Control Unit Operations")

3 Use **[▲▼]** to select the station. When the station is tuned in, the name of the track and artist are displayed.



- The channel switches continuously when **[▲▼]** is pressed and held.
- XM Radio stations can be preset using the same procedure as for FM/AM stations (☞ page 47 "Presetting Radio Stations (Preset Memory)" and "Listening to Preset Stations").
- The artist name, track name, category and reception level can be checked by pressing **<STATUS>**.
- The time for which the GUI menus are displayed can be set at GUI menu "Manual Setup" – "Option Setup" – "GUI" – "Tuner" (☞ page 34).

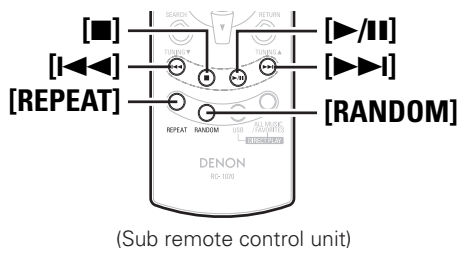
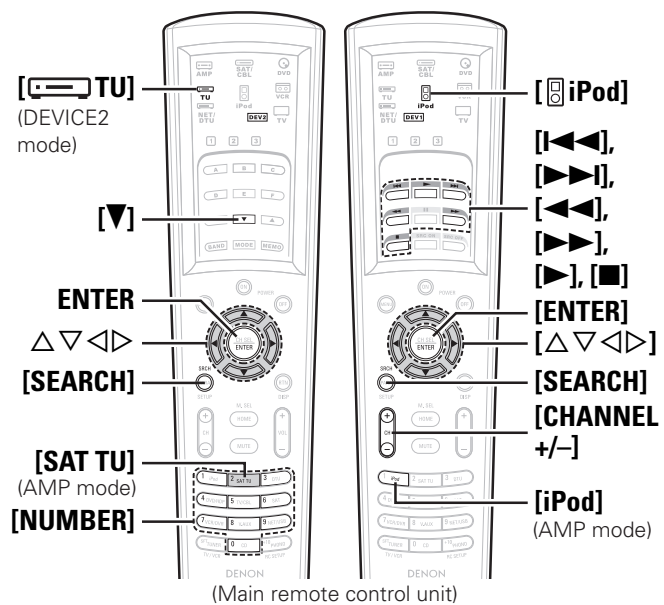
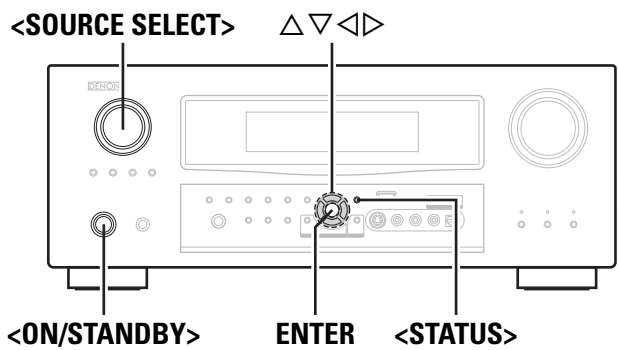

About the button names in these explanations
 < > : Buttons on the main unit
 [] : Buttons on the remote control unit
Button name only:
 Buttons on the main unit and remote control unit

Checking the XM Signal Strength and Radio ID

1 Either turn <SOURCE SELECT> or press [SAT TU] (AMP mode) to select “XM”.

2 Press <STATUS> until “SIGNAL” appears on the display.
 The display will switch as shown below, depending on the reception conditions.

Display	GUI	Status
GOOD	📶	Signal strength is good
MARGINAL	📶	Signal strength is marginal
WEAK	📶	Signal strength is weak
NO	📶	No signal

3 Adjust the position of the antenna until “SIGNAL: GOOD” is shown on the display.

4 Press <STATUS> until the station you want to check (example: “XM001”) is displayed.

5 Press [V] and select channel 0 (XM000).
 The radio ID is shown on the display.



The strength of both the XM satellite and terrestrial signals can be checked at GUI menu “Source Select” – “XM” – “Antenna Aiming” (page 40).

Searching Categories

1 Press <>.



2 Use <> to select the category, then use Δ∇ to select the desired station.

Accessing XM Radio Stations Directly

1 Press [SEARCH].

2 Press [NUMBER] then input the station’s channel.

Example: Accessing station “XM123”:
 [1] → [2] → [3]

※ If no button is pressed within several seconds, the station automatically switches to the one whose number has been input.

3 Press ENTER to set that station.
 Reception switches to the selected station.

- “LOADING” is displayed while stations or data are being received.
- “UPDATING” is displayed while the encoding code is being updated.
- “XM - - -” is displayed if the selected channel cannot be used.

iPod® Playback

The music on an iPod can be played by using the Control Dock for iPod (ASD-1R, sold separately).

The operation can also be performed using the buttons on the main unit or remote control unit while watching the GUI menus.



iPod is a trademark of Apple Inc., registered in the U.S. and other countries.

※ The iPod may only be used to copy or play contents that are not copyrighted or contents for which copying or playback is legally permitted for your private use as an individual. Be sure to comply with applicable copyright legislation.

Basic Operation

1 Make the necessary preparations.

- Set the iPod in the DENON Control Dock for iPod.
(See the Control Dock for iPod's operating instructions.)
- Assign the Control Dock for iPod's input.

GUI : "Source Select" – "(input source)" – "Assign" – "iPod dock" (page 39)

2 Either turn <SOURCE SELECT> or press [iPod] (AMP mode) to select the input source assigned in step 1-② above.



(iPod screen)

※ If the screens above are not displayed, the iPod may not be properly connected. Try connecting again.

GUI : "Source Select" – "(input source)" – "Play" (page 37)

3 To operate using the main remote control unit, set the remote control unit to the iPod mode.

(page 59 "Remote Control Unit Operations")



- With the default settings, the iPod can be used connected to the VCR (iPod) connector.
- Use the RESTORER mode to expand the low and high frequency components of compressed audio files and achieve a richer sound. The default setting is "Mode3".
- Press <ON/STANDBY> and set the AVR-3808CI's power to the standby mode before disconnecting the iPod. Also switch the input source to one to which the GUI menu "iPod dock" is not assigned before disconnecting the iPod.

NOTE

- Depending on the type of iPod and the software version, some functions may not operate.
- DENON will accept no responsibility whatsoever for any loss of iPod data.

Listening to Music

1 Use Δ ∇ to select the menu, then press ENTER or \triangleright to select the music file to be played.

2 Press ENTER or \triangleright . Playback starts.

Stopping playback temporarily

During playback, press ENTER or \triangleright .
Press again to resume playback.

Fast-forwarding or fast-reversing

During playback, either press and hold Δ (to fast-reverse) or ∇ (to fast-forward), or press [\lll] or [\ggg].

To cue to the beginning of a track

During playback, either press Δ (to cue to the previous track) or ∇ (to cue to the next track), or press [\lll] or [\ggg].

To stop

During playback, either press and hold ENTER or press [■].

Playing repeatedly

Press [CHANNEL -] or [REPEAT] on the sub remote control unit.

[Selectable items] All One OFF

GUI : "Source Select" – "(input source)" – "Playback Mode (iPod)" – "Repeat" (page 38)

Shuffling playback

Press [CHANNEL +] or [RANDOM] on the sub remote control unit.

[Selectable items] Albums Songs OFF

GUI : "Source Select" – "(input source)" – "Playback Mode (iPod)" – "Shuffle" (page 38)

Searching up or down pages

Press [SEARCH], then press \triangleleft (down) or \triangleright (up).
To cancel, press Δ ∇ or [SEARCH].

To switch between the Browse and Remote modes

Either press and hold [SEARCH].



- The title name, artist name and album name can be checked by pressing <STATUS> during playback.
- On the AVR-3808CI, folder and file names can be displayed as titles. Any characters that cannot be displayed are replaced with " . (period)".
- The time for which the GUI menus are displayed can be set at GUI menu "Manual Setup" – "Option Setup" – "GUI" – "iPod" (page 34).

Viewing Still Pictures or Videos on the iPod

Photo and video data on the iPod can be viewed on the monitor. (Only for iPod equipped with slideshow or video functions.)

1 Press and hold [SEARCH] to set the Remote mode. "Remote iPod" is displayed on the AVR-3808CI's display.

2 Watching the iPod's screen, use Δ ∇ to select "Photos" or "Videos".

3 Press ENTER until the image you want to view is displayed.



"TV Out" at the iPod's "Slideshow Settings" or "Video Settings" must be set to "On" in order to display the iPod's photo data or videos on the monitor. For details, see the iPod's operating instructions.

Playing Network Audio or USB Memory Devices

This procedure can be used to play Internet radio stations or music files stored on a computer or USB memory device.

□ About the Internet radio function

- Internet radio refers to radio broadcasts distributed over the Internet. Internet radio stations from around the world can be tuned in.

The AVR-3808CI is equipped with the following Internet radio functions:

- Stations can be selected by genre and region.
- Up to 56 Internet radio stations can be preset.
- Internet radio stations in MP3 and WMA (Windows Media Audio) format can be listened to.
- Your favorite radio stations can be registered by accessing an exclusive DENON Internet radio URL from a Web browser on a computer.

※ The function is managed for individual users, so you must provide your MAC or e-mail address.

Exclusive URL: <http://www.radiodenon.com>

※ The radio station database service may be suspended without notice.

- The AVR-3808CI's Internet radio station list is created using a radio station database service (vTuner). This database service provides a list edited and created for the AVR-3808CI. vTuner services may be discontinued without notice.

□ Music server

This function lets you play music files and playlists (m3u, wpl) stored on a computer (music server) connected to the AVR-3808CI via a network.

With the AVR-3808CI's network audio playback function, connection to the server is possible using one of the technologies below.

- Windows Media Player Network Sharing Service
- Windows Media DRM10

□ USB memory devices

A USB memory device can be connected to the AVR-3808CI's USB port to play music files stored on the USB memory device.

- Only USB memory devices conforming to mass storage class and MTP (Media Transfer Protocol) standards can be played on the AVR-3808CI.

- The AVR-3808CI is compatible with USB memory devices in "FAT16" or "FAT32" format.

[Compatible formats]

	Internet radio	Music server [※]	USB [※]
WMA (Windows Media Audio)	○	○	○*
MP3 (MPEG-1 Audio Layer-3)	○	○	○
WAV *	-	○	○
MPEG-4 AAC	-	○*	○*
FLAC (Free Lossless Audio Codec)	-	○	○

A server or server software compatible with distribution in the corresponding formats is required to play music files via a network.

*: Only files that are not protected by copyright can be played on the AVR-3808CI.

Contents downloaded from pay sites on the Internet are copyright protected. Also, files encoded in WMA format when ripped from a CD, etc., on a computer may be copyright protected, depending on the computer's settings.

※ Music server and USB

- The AVR-3808CI is compatible with MP3 ID3-Tag (Ver. 2) standards.
- The AVR-3808CI is compatible with WMA META tags.

[Playable formats]

	Sampling frequency	Bit rate	Extension
WMA (Windows Media Audio)	32/44.1/48 kHz	48~192 kbps	.wma
MP3 (MPEG-1 Audio Layer-3)	32/44.1/48 kHz	32~320 kbps	.mp3
WAV	32/44.1/48 kHz	-	.wav
MPEG-4 AAC	32/44.1/48 kHz	16~320 kbps	.aac/.m4a/.mp4
FLAC (Free Lossless Audio Codec)	32/44.1/48 kHz	-	.flac

WAV format Quantization bit rate: 16 bits.

Installing Windows Media Player ver. 11

① If Windows XP Service Pack 2 has not yet been installed, either download it free of charge from Microsoft or install it via a Windows update installer.

② Download the latest version of Windows Media Player ver. 11, either directly from Microsoft or using a Windows update installer.

※ When using Windows Vista, there is no need to download a new version of Windows Media Player.

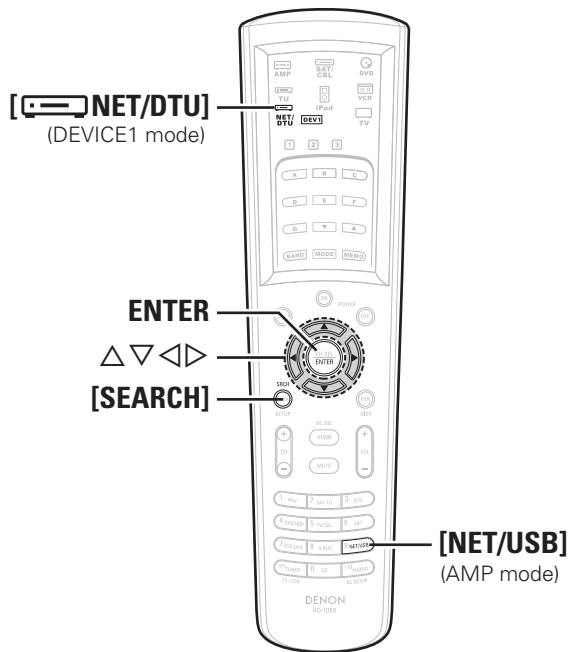
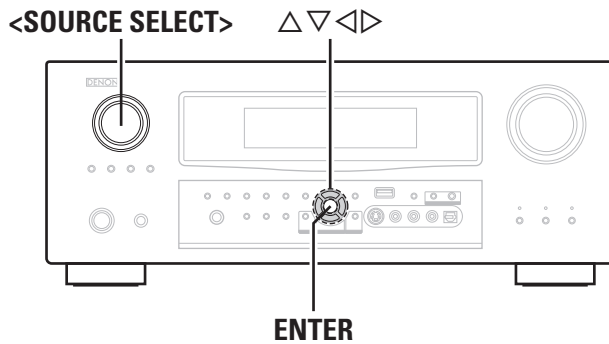

About the button names in these explanations
 < > : Buttons on the main unit
 [] : Buttons on the remote control unit
Button name only:
 Buttons on the main unit and remote control unit

Basic Operation

1 Make the necessary preparations.

- ① Check the network environment, then turn on the AVR-3808CI's power. (☞ page 20 "Network Audio")
- ② If settings are required, make the network settings. (☞ page 31, 32 "Network Setup")
- ③ Prepare the computer. (☞ Computer's operating instructions) Install "Windows Media Player ver. 11"

2 Either turn <SOURCE SELECT> or press [NET/USB] (AMP mode) to select "NET/USB".

GUI : "Source Select" – "NET/USB" – "Play"
 (☞ page 37)

3 To operate using the main remote control unit, set the remote control unit to the NET/DTU (DEVICE 1) mode.

(☞ page 59 "Remote Control Unit Operations")

4 Use Δ ∇ to select the menu, then press ENTER or ▷ to select the file you want to play.

5 Press ENTER or ▷.

Playback starts.

Stopping playback temporarily

During playback, press **ENTER**.
 Press again to resume playback.

To stop

During the play or pause mode, press and hold **ENTER**.

Searching up or down pages

Press **[SEARCH]**, then press ◀ (down) or ▶ (up).
 To cancel, press Δ ∇ or **[SEARCH]**.

Searching by first letter (Character search)

This operation is convenient for choosing items from the menu screens for Internet radio stations or files stored on the computer.

- ① When the menu screen is displayed, press **[SEARCH]** twice.
- ② Use ◀ ▶ to select the first letter you want to search for.
 If there are multiple items starting with the selected letter, they are displayed in alphabetical order.
 If it is not possible to search the list, "Unsorted list..." is displayed.



- Use the RESTORER mode to expand the low and high frequency components of compressed audio files and achieve a richer sound. The default setting is "Mode3".
- The time for which the GUI menus are displayed can be set at GUI menu "Manual Setup" – "Option Setup" – "GUI" – "NET/USB" (☞ page 34).
- The display can be switched between the artist name, track name, album name.

Listening to Internet Radio

1 Use Δ ∇ to select "Internet Radio", then press ENTER or ▷.

2 Use Δ ∇ to select the item you want to play, then press ENTER or ▷.

The station list is displayed.

3 Use Δ ∇ to select the station, then press ENTER or ▷.

Playback starts once buffering reaches "100%".



- There are many Internet radio stations on the Internet, and the quality of the programs they broadcast as well as the bit rate of the tracks varies widely.
 Generally, the higher the bit rate, the higher the sound quality, but depending on the communication lines and server traffic, the music or audio signals being streamed may be interrupted.
 Inversely, lower bit rates mean a lower sound quality but less tendency for the sound to be interrupted.
- "Server Full" or "Connection Down" is displayed if the station is busy or not broadcasting.
- On the AVR-3808CI, folder and file names can be displayed as titles. Any characters that cannot be displayed are replaced with " . (period)".

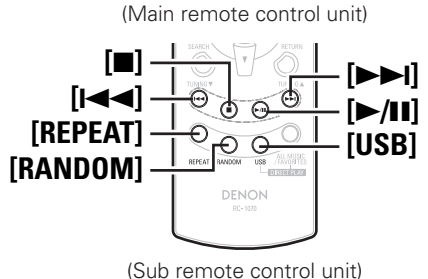
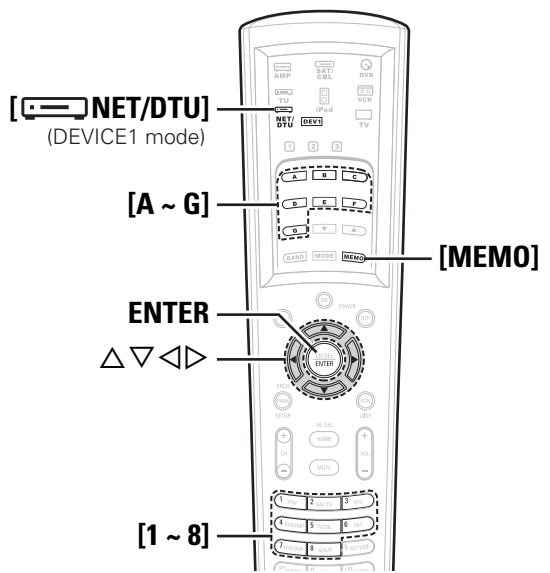
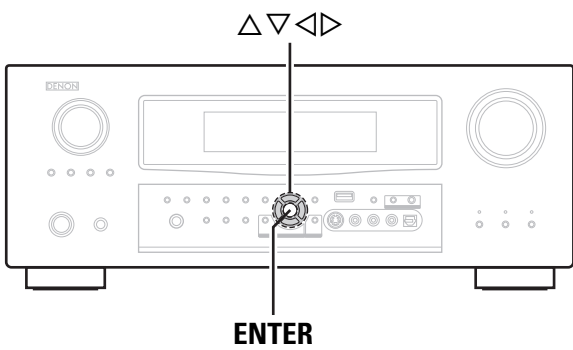

About the button names in these explanations
 < > : Buttons on the main unit
 [] : Buttons on the remote control unit
Button name only:
 Buttons on the main unit and remote control unit

Recently Played Internet Radio Stations

Recently played internet radio stations can be selected from "Recently Played" in top menu.

- 1** Use $\Delta \nabla$ to select "Recently Played", then press **ENTER** or \triangleright .
- 2** Use $\Delta \nabla$ to select the item you want to play, then press **ENTER** or \triangleright .

NOTE
Up to 20 stations stored in "Recently Played"

Presetting Internet Radio Stations

Preset Internet radio stations can be selected directly.

- 1** While the Internet radio station you want to preset is playing, press [**MEMO**].
- 2** Use $\Delta \nabla$ to select "Preset", then press **ENTER**.
- 3** Press [A ~ G], then press [1 ~ 8] to select the desired preset number.
The Internet radio station is now preset.

NOTE
If registered at a number that has already been preset, the previously registered setting is cleared.

Listening to Preset Internet Radio Stations

With the input source set to "NET/USB", press [A ~ G], then press [1 ~ 8].
The AVR-3808CI automatically connects to the Internet and playback begins.

Registering Internet Radio Stations as Your Favorites

Favorites are listed at the top of the menu screen, so when a station is registered as a favorite it can be tuned in easily.

- 1** Press [**MEMO**] while the Internet radio station you want to register is playing.
- 2** Use $\Delta \nabla$ to select "Favorites", then press **ENTER**.
- 3** Press \triangleleft to select "Yes".
The Internet radio station is registered.
If you do not want to register it, press \triangleright .

Listening to Internet Radio Stations Registered in Your Favorites

- 1** Use $\Delta \nabla$ to select "Favorites", then press **ENTER** or \triangleright .
- 2** Use $\Delta \nabla$ to select the Internet radio station, then press **ENTER** or \triangleright .
The AVR-3808CI automatically connects to the Internet and playback begins.

Clearing Internet Radio Stations from Your Favorites

- 1** Use $\Delta \nabla$ to select "Favorites", then press **ENTER** or \triangleright .
- 2** Use $\Delta \nabla$ to select the Internet radio station you want to clear, then press [**MEMO**].
- 3** Press \triangleleft to select "Delete".
The selected Internet radio station is cleared.
To cancel the operation without clearing the station, press \triangleright .

Playing Files Stored on a Computer

Use this procedure to play music files or playlists.

- 1 Use Δ / ∇ to select the host name of the computer on which the music file you want to play is located, then press **ENTER** or \triangleright .
- 2 Use Δ / ∇ to select the search item or folder, then press **ENTER** or \triangleright .
- 3 Use Δ / ∇ to select the file, then press **ENTER** or \triangleright . Playback starts once buffering reaches "100%".

Selecting tracks

During playback, either press Δ (previous track) or ∇ (next track).



- Connections to the required system and specific settings must be made in order to play music files (page 20).
- Before starting, you must launch the computer's server software and set the files as server contents. For details, see the operating instructions of your server software.

Playing files that have been Preset or Registered in Your Favorites

Files can be preset, registered in your favorites and played using the same operations as for Internet radio stations.

NOTE

- Presettings are erased by overwriting them.
- When the operation described below is performed, the music server's database is updated and it may no longer be possible to play preset or favorite music files.
 - When you quit the music server and then restart it.
 - When music files are deleted or added on the music server.
- When using an ESCIENT server, place "ESCIENT" before the server name.

Playing Files Stored on USB Memory Devices

Only USB memory devices conforming to mass storage class and MTP (Media Transfer Protocol) standards can be played on the AVR-3808CI.

Basic Operation

- 1 **Make the necessary preparations.**
 - Set the USB port to be used.
GUI: "Source Select" – "NET/USB" – "Playback Mode" – "USB Select" (page 39)
 - Connect the USB memory device to the set USB port.
- 2 Use Δ / ∇ to select "USB", then press **ENTER** or \triangleright .
- 3 Use Δ / ∇ to select the search item or folder, then press **ENTER** or \triangleright .
- 4 Use Δ / ∇ to select the file, then press **ENTER** or \triangleright . Playback starts once buffering reaches "100%".



By default, the front panel's USB port will be used.

Playing repeatedly

Press **[REPEAT]** on the sub remote control unit.

[Selectable items] **All** **One** **OFF**

GUI: "Source Select" – "NET/USB" – "Playback Mode" – "Repeat" (page 39)

Playing in random order

Press **[RANDOM]** on the sub remote control unit.

[Selectable items] **ON** **OFF**

GUI: "Source Select" – "NET/USB" – "Playback Mode" – "Random" (page 39)

Selecting tracks

During playback, either press Δ (previous track) or ∇ (next track).



- If the USB memory device is divided into multiple partitions, only the top partition can be selected.
- The AVR-3808CI is compatible with MP3 files conforming to "MPEG-1 Audio Layer-3" standards.
- If **[USB]** on the sub remote control unit is pressed when the USB memory device or folder is selected, all the tracks on the USB memory device or in the folder are played.

NOTE

- The AVR-3808CI is equipped with two USB ports, one each on the front and rear panels. It is not possible to use the set with USB memory devices connected to both the ports at the same time. Select the USB port you want to use at the "Source Select" – "NET/USB" – "Playback Mode" – "USB Select" menu.
- DENON will accept no responsibility whatsoever for any loss or damage to data on USB memory devices when using the USB memory device connected to the AVR-3808CI.
- USB memory devices will not work via a USB hub.
- DENON does not guarantee that all USB memory devices will operate or receive power. When using a USB connection type portable hard disk of the type for which power can be supplied by connecting an AC adapter, we recommend using the AC adapter.
- It is not possible to connect and use a computer via the AVR-3808CI's USB port using a USB cable.
- The AVR-3808CI is not compatible with the iPod shuffle.

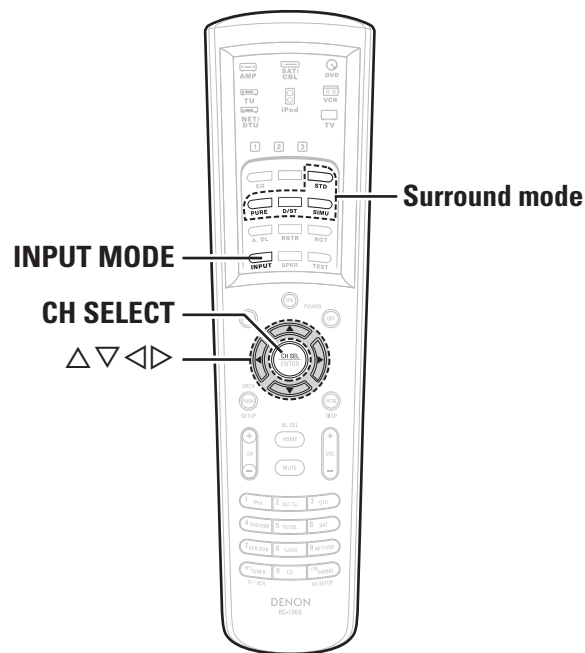
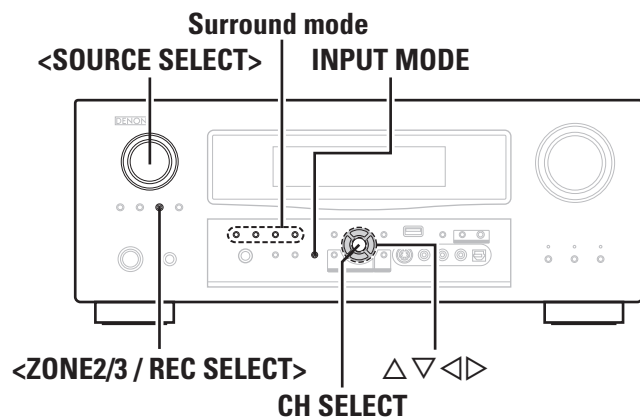

About the button names in these explanations
 < > : Buttons on the main unit
 [] : Buttons on the remote control unit
Button name only:
 Buttons on the main unit and remote control unit

Operating the AVR-3808CI Using a Browser (Web control)

This function lets you operate the AVR-3808CI using Internet Explorer.

- 1 Check the AVR-3808CI's IP address.**
GUI : "Manual Setup" – "Network Setup" – "Network Information" (☞ page 32)
- 2 Input the AVR-3808CI's IP address in Internet Explorer.**
 The AVR-3808CI can be operated in the same way as with regular Internet browsing.

To use the web control function, set the GUI menu "Manual Setup" – "Network Setup" – "Other" – "Power Saving" setting to "OFF" (☞ page 32).

Other Operations and Functions

Other Operations

Playing Super Audio CDs

- 1 At the "Digital" or "HDMI" setting (☞ page 39), select the input source for which "DENON LINK" or "HDMI" is assigned.**
 The "[D.LINK]" or "[HDMI]" indicator lights on the display.
- 2 Use INPUT MODE to select "Auto" (☞ page 37, 38).**
 Select the input mode according to the program source to be played.
- 3 Select the surround mode (☞ page 40, 41).**
 We recommend playing in the DIRECT mode.
- 4 Start playing the Super Audio CD.**
 The "[DSD]" indicator lights on the display.
 For operating instructions, refer to the respective equipment's operating instructions.

-
- When playing DSD signals in the DIRECT or PURE DIRECT mode, the DSD signals are converted as such into analog signals. When playing in other surround modes, the DSD signals are first converted into PCM format, then into analog signals.
 - "DSD DIRECT" is shown on the display when playing DSD 2-channel signals in the DIRECT mode. "DSD MULTI DIRECT" is shown on the display when playing DSD multi-channel signals in the DIRECT mode.

Recording on an External Device (REC OUT mode)

You can listen to one program source while recording a different program source.

1 Press <ZONE2/3 / REC SELECT>.

"ZONE2 SOURCE" is shown on the display.

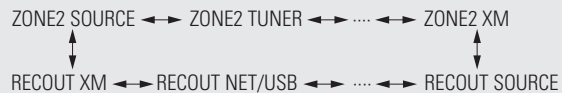

2 Turn <SOURCE SELECT> until "RECOUT SOURCE" is displayed.

The "REC" indicator lights.

3 Turn <SOURCE SELECT> to choose the input source to be recorded.

4 Play the program source.

For operating instructions, refer to the respective equipment's operating instructions.

To record FM or AM broadcasts, select the broadcast (page 47).

5 Start recording.

For operating instructions, refer to the respective equipment's operating instructions.



- To cancel, press <ZONE2/3 / REC SELECT>, then turn <SOURCE SELECT> until "ZONE2 SOURCE" is displayed.
- Make a test recording before starting the actual recording.
- Signals are only output to the analog REC OUT connectors when the digital signals input to the digital input connectors (OPTICAL/COAXIAL) are PCM (2-channel) signals.
- Digital audio signals input to the DENON LINK or HDMI connectors are not output to the REC OUT connectors, so connect using the OPTICAL or COAXIAL connectors.
- Sources selected with the REC OUT mode are output from ZONE2 as well.
- In the REC OUT mode, the remote control unit's ZONE2 mode buttons cannot be operated.
- The "XM" digital audio output signals are not output from the OPTICAL2 or OPTICAL3 output connectors. Also, network audio signals (Internet radio, music server, USB) are not output if they are copyright-protected.

NOTE

- Recordings you make are for your personal enjoyment and should not be used for other purposes without permission of the copyright holder.
- When "DENON LINK" is assigned at the GUI menu "Assign" setting, the PCM signals, network audio signals (Internet radio, music server and USB), XM signals input from the digital input connectors cannot be output from the analog REC OUT connectors.
- Input sources for which "Delete" is selected at "Source Delete" cannot be selected.

Convenient Functions

Channel Level

You can adjust the channel level either according to the playback sources or to suit your taste, as described below.

1 Press CH SELECT.

2 Use Δ ∇ or CH SELECT to select the speaker.

The speaker that can be set switches each time one of the buttons is pressed.

3 Use \triangleleft \triangleright to adjust the volume.

※ "OFF" can be set by pressing \triangleleft when the subwoofer's volume is set to -12 dB.

Fader Function

This function lets you adjust (fade) the sound from all the front or rear speakers at once.

1 Press CH SELECT.

2 Press Δ ∇ or CH SELECT to select "Fader".

3 Use \triangleleft \triangleright to adjust the volume of the speakers. (\triangleleft : front, \triangleright : rear)



- The fader function does not affect the subwoofer.
- The fader can be adjusted until the volume of the speaker adjusted to the lowest value is -12 dB.

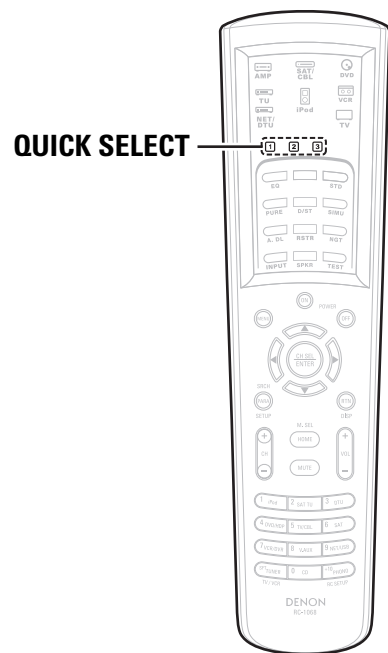
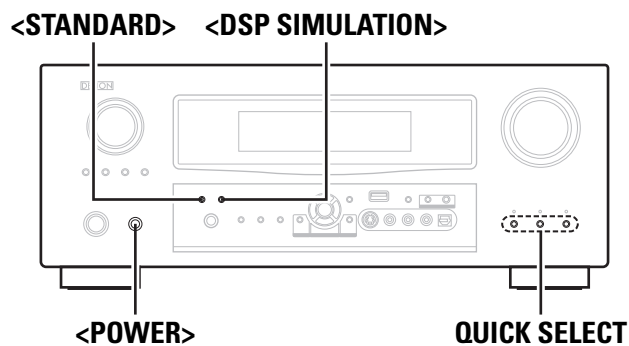

Quick Select Function

With this function, the currently playing input source, input mode, surround mode, room EQ settings and volume can be stored in the memory.

1 Set the input source, input mode, surround mode, room EQ settings and volume to the conditions you want to store.

2 Press and hold the desired **QUICK SELECT**.
Keep pressing the button until the quick select indicator lights.

[Quick Select Defaults]

	Input Source	Volume
Quick Select 1	DVD	-40 dB
Quick Select 2	TV/CBL	-40 dB
Quick Select 3	VCR	-40 dB



- To call out the settings, press **QUICK SELECT** at which the desired settings were stored.
- The Quick Select name can be changed (🔧 page 34).

NOTE

Input sources stored with the quick select function cannot be selected if they have been deleted at GUI menu "Manual Setup" – "Option Setup" – "Source Delete" (🔧 page 34). In this case, store them again.

Personal Memory Plus Function

This function sets the settings (input mode, surround mode, etc.) last selected for the individual input sources. When you switch to an input source, the settings are automatically set to the ones that were set the last time that input source was used.



The surround parameters, tone control, room EQ settings and the volumes of the different speakers are stored for the individual surround modes.

Last Function Memory

This stores the settings as they were directly before the standby mode was set.

When the power is turned back on, the settings are restored to as they were directly before the standby mode was set.

Backup Memory

The various settings are backed up for about 1 week, even if the power is turned off or the power cord is disconnected.

About the button names in these explanations

- < > : Buttons on the main unit
[] : Buttons on the remote control unit

Button name only:

Buttons on the main unit and remote control unit

Resetting the Microprocessor

Perform this procedure if the display is abnormal or if operations cannot be performed.
When the microprocessor is reset, all the settings are reset to their default values.

- 1** Turn off the power using <POWER>.
- 2** Press <POWER> while simultaneously pressing <STANDARD> and <DSP SIMULATION>.
- 3** Once the display starts flashing at intervals of about 1 second, release the two buttons.



If in step 3 the display does not flash at intervals of about 1 second, start over from step 1.

Remote Control Unit Operations

Main Remote Control Unit

- On the main remote control unit, the display switches according to the device being operated and the mode.
- In modes other than iPod, the mode switches between "DEVICE1" and "DEVICE2" each time the **[MODE SELECTOR]** is pressed.
- In the AMP, TUNER, NET/DTU and iPod modes, when the remote ID is set, the AVR-3808CI can be used independently even in an environment containing multiple DENON amplifiers.

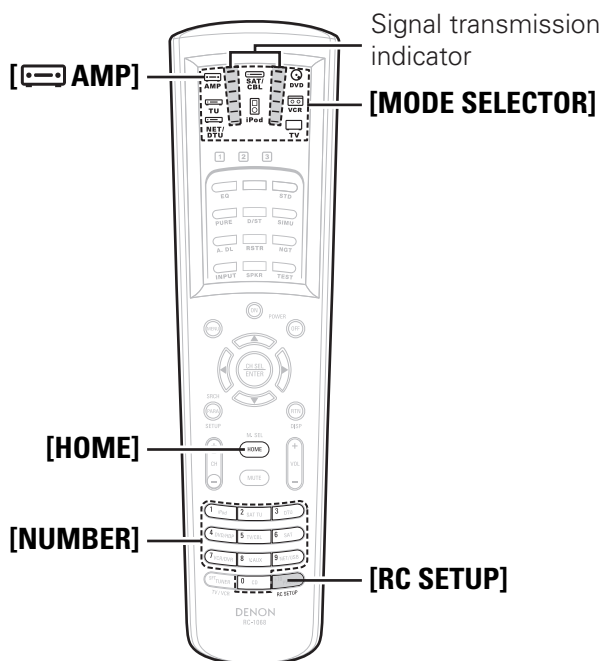

Depending on the model and year of manufacture of your equipment, some buttons may not operate.

NOTE

The device mode ("DEVICE1" or "DEVICE2") cannot be changed while the setting is being made.

Operating DENON Audio Components

1 Press **[MODE SELECTOR]** for the component to be operated.

The indicator for the component to be operated flashes.

: AMP / ZONE2 / ZONE3 / ZONE4* / SYSTEM CALL	: iPod
: TUNER (FM/AM) / XM	: DVD player (Recorder) / CD player (Recorder)
: NETWORK/USB / DIGITAL TUNER*	: VCR / TAPE
: Satellite Receiver / Cable TV	: TV

* The AVR-3808CI cannot be used in the ZONE4 or NET/DTU (DEVICE2) modes.

※ The mode switches each time **[AMP]** is pressed.

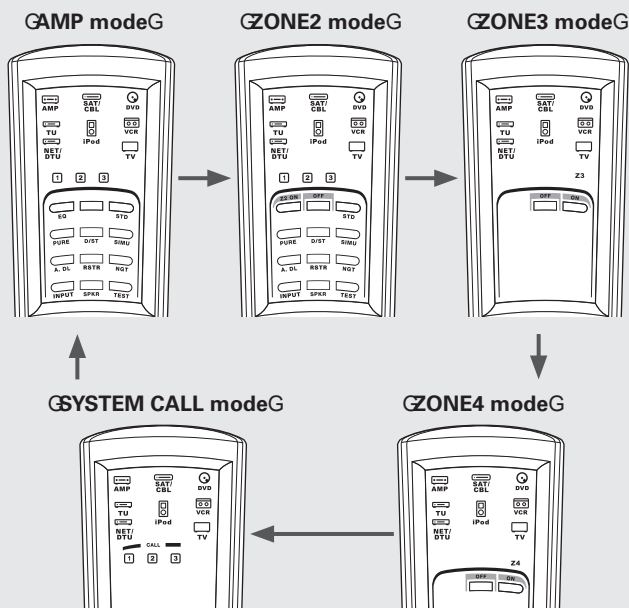

2 Operate the component.

※ For details, refer to the component's operating instructions.



[HOME] is used to return to the AMP mode (AMP, ZONE2, ZONE3, ZONE4 or SYSTEM CALL) when in any mode other than AMP.

Presetting

The included main remote control unit can be preset to operate devices of various brands.

1 Press **[MODE SELECTOR]** for the device you want to preset.

2 Press and hold in **[RC SETUP]** for at least 3 seconds.

The signal transmission indicator flashes twice.

3 Press **[NUMBER]** and input the 5-digit number of the brand of the component to be preset. The numbers are shown in the Preset Code Table (End of this manual).

When the code is registered, the signal transmission indicator flashes twice.

When the preset code is transmitted, the mode indicator for the component to which that code belongs flashes.

※ The input mode is canceled if no button is operated for 10 seconds.



Some brands have more than one preset code. If the component does not operate, try inputting a different code.

Operating Preset Components

1 Press **[MODE SELECTOR]** for the component to be operated.

The mode indicator of the device to be operated flashes.

2 Operate the component.

※ For details, refer to the component's operating instructions.

Functions of Buttons by Component

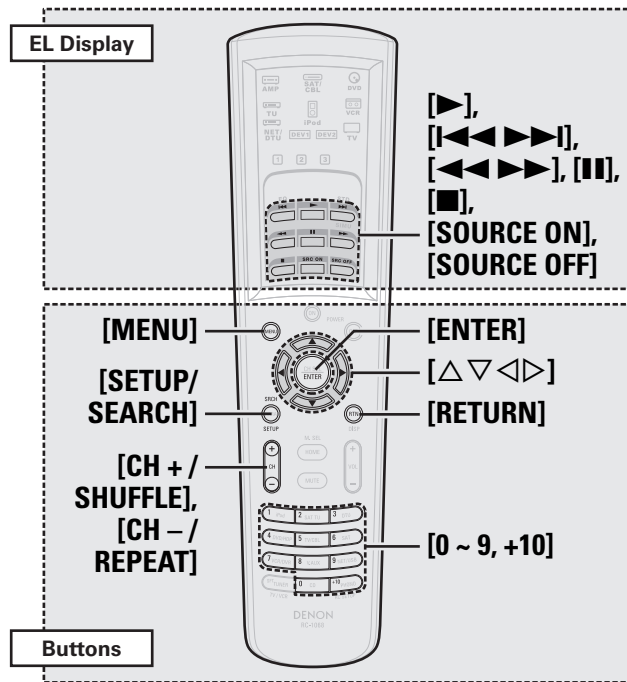

EL Display							
MODE SELECTOR	DVD				VCR		iPod
Device Mode	DEVICE 1		DEVICE 2		DEVICE 1	DEVICE 2	DEVICE 1
Device operated	DVD (Default setting)	DVD Recorder	CD (Default setting)	CD Recorder	VCR	TAPE	iPod
[▶]	Playback	Playback	Playback	Playback	Playback	Playback	Playback/Pause
[<<▶▶]	Auto search (cue)	Auto search (cue)	Auto search (cue)	Auto search (cue)	Auto search (cue)	Auto search (cue)	Auto search (cue)
[<<▶▶]	Manual search (fast-reverse/ fast-forward)	Manual search (fast-reverse/ fast-forward)	Manual search (fast-reverse/ fast-forward)	Manual search (fast-reverse/ fast-forward)	Manual search (fast-reverse/ fast-forward)	Manual search (fast-reverse/ fast-forward)	Manual search (fast-reverse/ fast-forward)
[⏸]	Pause	Pause	Pause	Pause	Pause	Pause	–
[■]	Stop	Stop	Stop	Stop	Stop	Stop	Stop
[SOURCE ON]	Power on	Power on	–	–	Power on	–	–
[SOURCE OFF]	Power off	Power off	–	–	Power off	–	–
Buttons							
[MENU]	Menu/guide	Menu/guide	–	–	Menu/guide	–	Menu
[△ ▽ ◀ ▶]	Cursor	Cursor	–	–	Cursor	–	Cursor
[ENTER]	Enter setting	Enter setting	–	–	Enter setting	–	Enter
[SETUP/SEARCH]	Set up	Set up	–	–	Set up	–	Page forward screen / Browse/ Remote mode switching (Press and hold)
[RETURN]	Return	Return	–	–	Cancel	–	Return
[CH + / SHUFFLE]	–	–	–	–	Switch channels	–	1-track/album shuffle play
[CH - / REPEAT]	–	–	–	–	Switch channels	–	1-track/All-track repeat play
[0 ~ 9, +10]	Select track	Select track	Select track	Select track	–	–	–
Special Remarks	①, ②		①		①	①	–

Special RemarksG

- ① Only one component can be preset for each mode. If a new code is preset, the previous code is automatically cleared.
- ② The names of the functions for the DVD remote control buttons differ from brand to brand. Check beforehand.

NOTE

- Preset a DVD player or DVD recorder for the “DVD” – “DEVICE1” mode. Preset a CD player or CD recorder for the “DVD” – “DEVICE2” mode.
- Preset a VCR for the “VCR” – “DEVICE1” mode. Preset a tape deck for the “VCR” – “DEVICE2” mode.

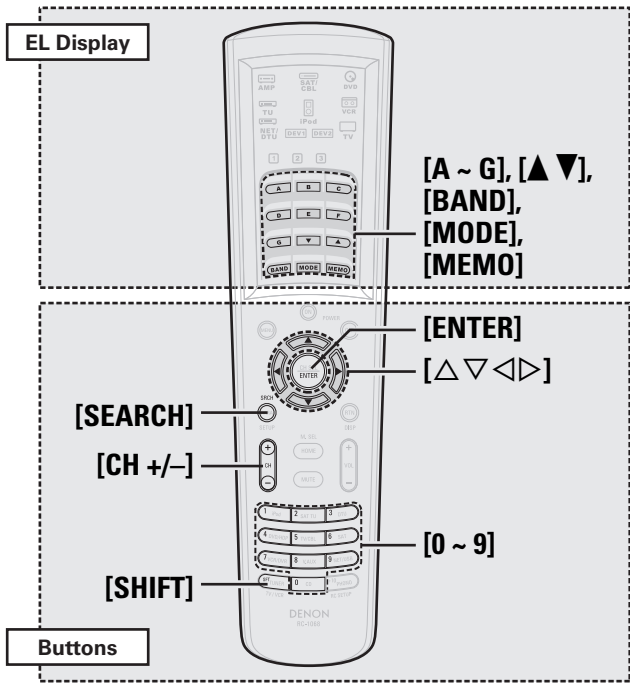
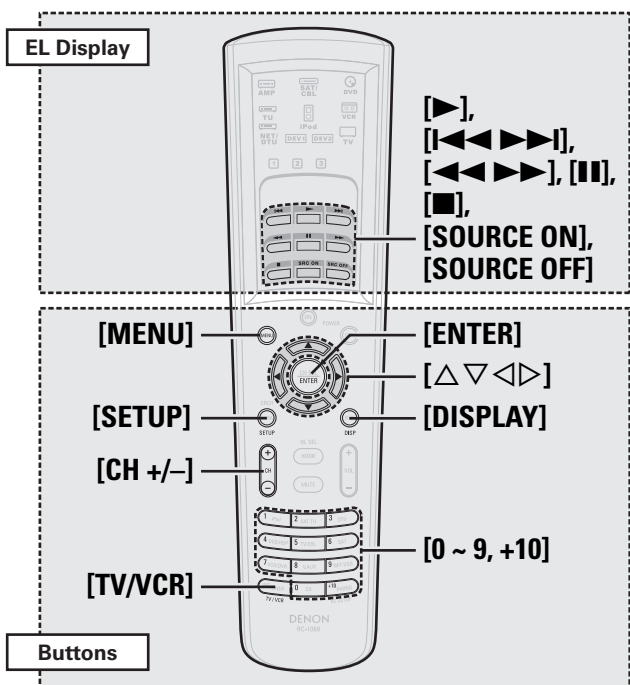

EL Display				
MODE SELECTOR	TV		Satellite Receiver / Cable TV	
Device Mode	DEVICE 1	DEVICE 2	DEVICE 1	DEVICE 2
Device operated	TV (HITACHI)	TV (SONY)	SAT	SAT
>				
<<<<<<<>>>>>>>				
<<<<<<>>>>>>>				
■				
SOURCE ON	Power on	Power on	Power on	Power on
SOURCE OFF	Power off	Power off	Power off	Power off
Buttons				
MENU	Menu/guide	Menu/guide	Menu/guide	Menu/guide
△ ▽ ◀ ▶	Cursor	Cursor	Cursor	Cursor
ENTER	Enter setting	Enter setting	Enter setting	Enter setting
SETUP	Set up	Set up	Set up	Set up
DISPLAY	Display	Display	Display	Display
CH +/-	Switch channels	Switch channels	Switch channels	Switch channels
0 ~ 9, +10	Channel selection	Channel selection	Channel selection	Channel selection
TV/VCR	Switch inputs	Switch inputs	-	-
Special Remarks	①, ③	①, ③	①, ③	①, ③

Special Remarks

- ① Only one component can be preset for each mode. If a new code is preset, the previous code is automatically cleared.
- ③ The CD, VCR or DVD buttons (one only set) can be assigned to the monitor, satellite receiver and cable TV (page 63 "Punch Through Function").

EL Display			
MODE SELECTOR	TU		NET / DTU
Device Mode	DEVICE 1	DEVICE 2	DEVICE 1
Device operated	Analog tuner	XM	NET / USB
A ~ G	Preset memory block selection	Preset memory block selection	Preset memory block selection
▲ ▼	Tuning +/-	Channel selection	-
BAND	AM/FM switching	-	-
MODE	Switch search modes	-	-
MEMO	Preset memory registration	Preset memory registration	Preset memory registration
Buttons			
△ ▽ ◀ ▶	-	Category search	Cursor
ENTER	-	-	Enter, Playback/Pause
SEARCH	-	Direct search	Search
CH +/-	Preset channel selection	Preset channel selection	Preset channel selection
0 ~ 9	Preset channel selection (1 ~ 8)	Preset channel selection (1 ~ 8) / Direct channel search (0 ~ 9)	Preset channel selection (1 ~ 8)
SHIFT	Switch memory block	Switch memory block	Switch memory block

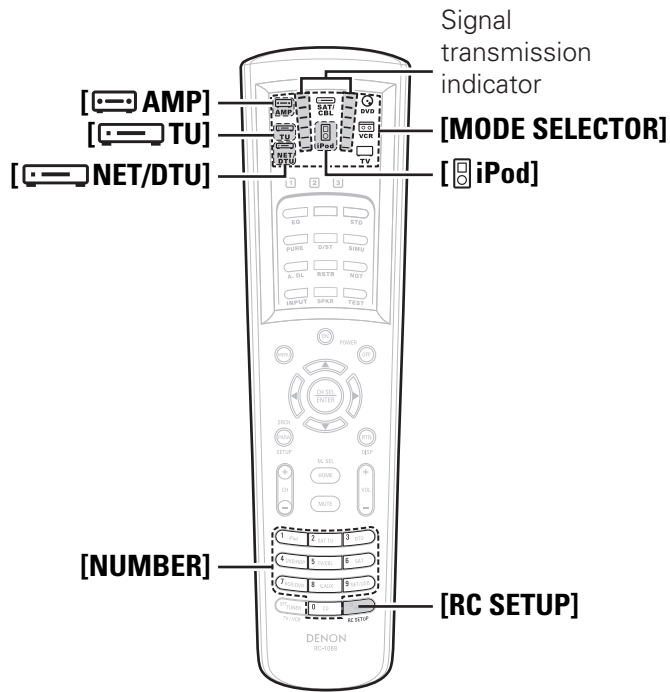

Setting the Remote ID

When using multiple DENON AV receivers in the same room, make this setting so that only the desired AV receiver operates.

- 1** Press **[AMP]** to set the main remote control unit to the AMP mode.
- 2** Press and hold in **[RC SETUP]** for at least 3 seconds. The signal transmission indicator flashes twice.
- 3** Refer to the table at the right, and use **[NUMBER]** to input the 5-digit number corresponding to the remote ID to be changed. The signal transmission indicator flashes twice.
- 4** Press **[TU]**, **[iPod]** or **[NET/DTU]** to select the mode to be set.
- 5** Repeat steps 2 to 4 to set the remote IDs for all modes.

MODE SELECTOR	AMP (MAIN)	TUNER		iPod	NET/DTU
		DEVICE1 (Analog TUNER)	DEVICE2 (XM)		DEVICE1 (Net Audio / USB)
Remote ID					
1 (Default)	81001	52863	52864	72815	62865
2	82001	52795	52812	72816	62837
3	83001	52800	52813	72817	62838
4	84001	52805	52814	72818	62839

NOTE

- When changing a setting, be sure to set the same remote ID as the AVR-3808CI's (page 35).
- When changing the AMP mode's remote ID, also change the "TUNER"; "iPod" and "NET/DTU" remote ID at the same time.
- Set the remote ID of an analog tuner for "TUNER" – "DEVICE1"; the XM remote ID for "DEVICE2".

Learning Function

If your AV devices are of a brand other than DENON or if they cannot be operated with the preset memory function, their remote control signals can be transferred to stored in the AVR-3808CI's main remote control unit.

- 1** Press **[MODE SELECTOR]** for the device you want to set.
- 2** Press and hold in **[RC SETUP]** for at least 3 seconds. The signal transmission indicator flashes twice.
- 3** Press **[9], [7] and [5], in that order.** The signal transmission indicator flashes twice and the learning mode is set.
- 4** Press the button to be set. The main remote control unit's display turns off.
 - ※ If a button that cannot be learned is pressed, the signal transmission indicator lights but the signal is not learned.

5 Point the main remote control units directly at each other and press and hold the button on the other device's remote control unit that you want to learn.

Once learning is completed normally, the display lights and the signal transmission indicator flashes twice.

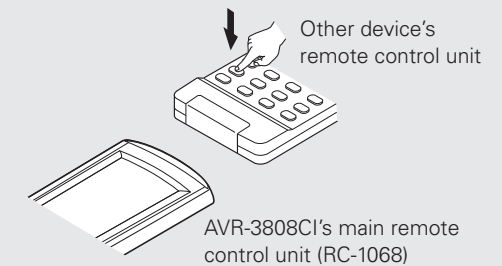

- ※ If you want to learn other buttons, repeat steps 4 and 5.
- ※ The mode can be switched by pressing **[MODE SELECTOR]**.
- ※ The signal transmission indicator lights once for a long time if learning was not possible

6 Press and hold in **[RC SETUP]** for at least 3 seconds.

The signal transmission indicator flashes twice and the setting is completed.



- With some remote control units, the signals cannot be learned or the device will not operate properly even when the signals have been learned. In this case, use the device's own remote control unit.
- Learned buttons have priority over the preset memory. If you no longer need the learned setting, reset the learning function (page 64).

NOTE

- **[HOME]** cannot be learned.
- Do not learn any remote control signals at **[RC SETUP]**.
- The AMP, ZONE2, ZONE3, ZONE4 and SYSTEM CALL modes cannot be learned.

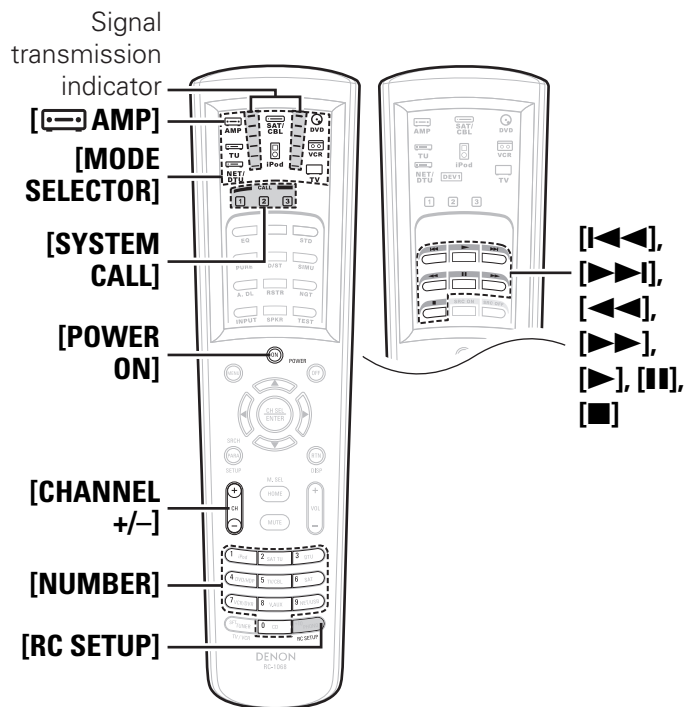

System Call Function

This function lets you register a series of operations at a single button.
For example, the amplifier can be turned on, the input source selected, the monitor's power turned on, the source device's power turned on and the play mode set all by pressing a single button.
Up to 32 signals each can be registered at [SYSTEM CALL] (1, 2 or 3).

Registering

- 1 Press [MODE SELECTOR] for the device you want to register.
- 2 Press and hold in [RC SETUP] for at least 3 seconds.
The signal transmission indicator flashes twice.
- 3 Press [9], [7] and [8], in that order.
The signal transmission indicator flashes twice and the system call registration mode is set.
- 4 Press [SYSTEM CALL] (1, 2 or 3) at which you want to register the signals.
- 5 Press the buttons you want to register in the same sequence as the operations you want to perform.
The signal transmission indicator lights when a button is pressed.
Example : Press [POWER ON].
↓
Press [MODE SELECTOR] – [DVD].
↓
Press [▶].
※ The mode can be switched by pressing [MODE SELECTOR].
※ Perform the registration procedure for all the buttons you want to register.
- 6 Press and hold in [RC SETUP] for at least 3 seconds.
The signal transmission indicator flashes twice and the setting is completed.

Calling out

- 1 Press [AMP], to select "SYSTEM CALL".
- 2 Press [SYSTEM CALL] (1, 2 or 3) at which the signals were registered.
The registered signals are transmitted in the registered sequence.

Punch Through Function

CD, DVD or VCR mode buttons can be stored at unused TV or SAT/CBL mode buttons.
For example, when DVD mode buttons are assigned to the TV mode, the DVD mode operations can be performed while in the TV mode.

- 1 Press [MODE SELECTOR] for the device you want to punch through (CD, DVD or VCR).
- 2 Press and hold in [RC SETUP] for at least 3 seconds.
The signal transmission indicator flashes twice.
- 3 Press [9], [8] and [4], in that order.
The signal transmission indicator flashes twice and the punch through setting mode is set.
- 4 Press the button you want to punch through (▶, ■, ◀◀, ▶▶, ◀◀▶▶, ▶▶◀◀ or ◀◀▶▶◀◀).
- 5 Press [MODE SELECTOR] for the device you want to punch through (TV or SAT/CBL).
- 6 Press and hold in [RC SETUP] for at least 3 seconds.
The signal transmission indicator flashes twice and the setting is completed.

Setting the Time the Backlight Stays Lit

- 1 Press and hold in [RC SETUP] for at least 3 seconds.
The signal transmission indicator flashes twice.
- 2 Press [9], [7] and [3], in that order.
The signal transmission indicator flashes twice and the backlight on time setting mode is set.
- 3 Set the light on time.
The signal transmission indicator flashes twice.
[Settable times] : [1] : 5 sec.
[2] : 10 sec. (Default)
[3] : 15 sec.
[4] : 20 sec.
[5] : 25 sec.

Adjusting the Backlight's Brightness

The display's brightness can be adjusted in 5 steps.
(Default: Step 3)

- 1 Press and hold in [RC SETUP] for at least 3 seconds.**
The signal transmission indicator flashes twice.
- 2 Press [CHANNEL +] or [CHANNEL -].**
The display gets one step brighter when [+] is pressed.
The display gets one step darker when [-] is pressed.
- 3 Press [RC SETUP] to complete the setting.**

Resetting the Main Remote Control Unit

Learning Function

Resetting button by buttonG

- 1 Press [MODE SELECTOR] for the device you want to reset.**
- 2 Press and hold in [RC SETUP] for at least 3 seconds.**
The signal transmission indicator flashes twice.
- 3 Press [9], [7] and [6], in that order.**
The signal transmission indicator flashes twice.
- 4 Press the button you want to reset twice.**
The signal transmission indicator flashes twice.

Resetting by device modeG

- 1 Press [MODE SELECTOR] for the device you want to reset.**
- 2 Press and hold in [RC SETUP] for at least 3 seconds.**
The signal transmission indicator flashes twice.
- 3 Press [9], [7] and [6], in that order.**
The signal transmission indicator flashes twice.
- 4 Press [MODE SELECTOR] for the device you want to reset twice.**
The signal transmission indicator flashes twice.

System Call Function

- 1 Press and hold in [RC SETUP] for at least 3 seconds.**
The signal transmission indicator flashes twice.
- 2 Press [9], [7] and [8], in that order.**
The signal transmission indicator flashes twice.
- 3 Press [SYSTEM CALL] (1, 2 or 3) you want to reset.**
- 4 Press and hold in [RC SETUP] for at least 3 seconds.**
The signal transmission indicator flashes twice.

Punch Through Function

- 1 Press [MODE SELECTOR] for the device you want to reset (TV or SAT/CBL).**
- 2 Press and hold in [RC SETUP] for at least 3 seconds.**
The signal transmission indicator flashes twice.
- 3 Press [9], [8] and [4], in that order.**
The signal transmission indicator flashes twice.
- 4 Press and hold in [RC SETUP] for at least 3 seconds.**
The signal transmission indicator flashes twice.

All Settings

- 1 Press and hold in [RC SETUP] for at least 3 seconds.**
The signal transmission indicator flashes twice.
- 2 Press [9], [8] and [1], in that order.**
The signal transmission indicator flashes 4 times.
All the settings are restored to their defaults.

Sub Remote Control Unit Operations

- The sub remote control unit is equipped with frequently used buttons, so it can be used for simple remote control unit operations.
- The sub remote control unit can also be used for multi-zone, so you can use it to control the AVR-3808CI from other rooms.
- The operations listed below can be performed with the sub remote control unit.
 - Switching the input source
 - Adjusting the volume
 - Tuner (AM/FM), XM and iPod operations
 - NET/USB direct play
 - GUI menu and ZONE2 on-screen display operations
 - Zone power on/off
- It is not possible to operate devices other than the amplifier.

Functions of Buttons by Component

Device operated	DVD, HDP, TV / CBL, DVR1, VCR, V.AUX, SAT, CD, PHONO			TUNER (AM/FM)			SAT TU (XM)		
	M	Z2	Z3	M	Z2	Z3	M	Z2	Z3
ZONE SELECT	Zone operation mode selection			Zone operation mode selection			Zone operation mode selection		
ZONE OFF	Power turned off (※1)			Power turned off (※1)			Power turned off (※1)		
ZONE ON	Power turned on (※1)			Power turned on (※1)			Power turned on (※1)		
SOURCE SELECT	Input source selection (※2)			Input source selection			Input source selection		
CHANNEL +/-	-			Preset channel selection			Preset channel selection		
SHIFT	-			Preset channel memory block selection			Preset channel memory block selection		
VOLUME +/-	Adjustment of volume (※1)			Adjustment of volume (※1)			Adjustment of volume (※1)		
MUTE	Muting (※1)			Muting (※1)			Muting (※1)		
MENU	Selected zone menu			Selected zone menu			Selected zone menu		
$\Delta \nabla \triangleleft \triangleright$	-			-			Category search		
I◀▶I, TUNING ▲ ▼	-			Tuning			Channel selection		
USB	※2			※2			※2		
ALL MUSIC * (Music server only)	※3			※3			※3		
FAVORITES *	※4			※4			※4		

※1: Affects the currently selected zone.

※2: The input source switches to "NET/USB" and the files on the USB memory device are played.

※3: The input source switches to "NET/USB" and the files in "All Music" on the music server are played.

※4: The input source switches to "NET/USB" and the files in "Favorites" are played.

*: Whether "All Music" or "Favorites" is selected depends on the "Direct Play" setting (▶▶▶ page 39).

DIRECT PLAY button
<ul style="list-style-type: none"> Playback is possible in the mode selected at GUI menu "Source Select" – "NET/USB" – "Playback Mode" – "Direct Play".
<p>FAVORITES: Playback starts from the first track registered in the favorites.</p> <p>ALL MUSIC: Playback starts from the first track registered in the "All Music" folder.</p> <ul style="list-style-type: none"> When [USB] is pressed, playback starts from the first track on the USB memory device.
<p>NOTE</p> <p>When the music server is stopped or restarted, it may no longer be possible to play tracks stored in the favorites.</p>

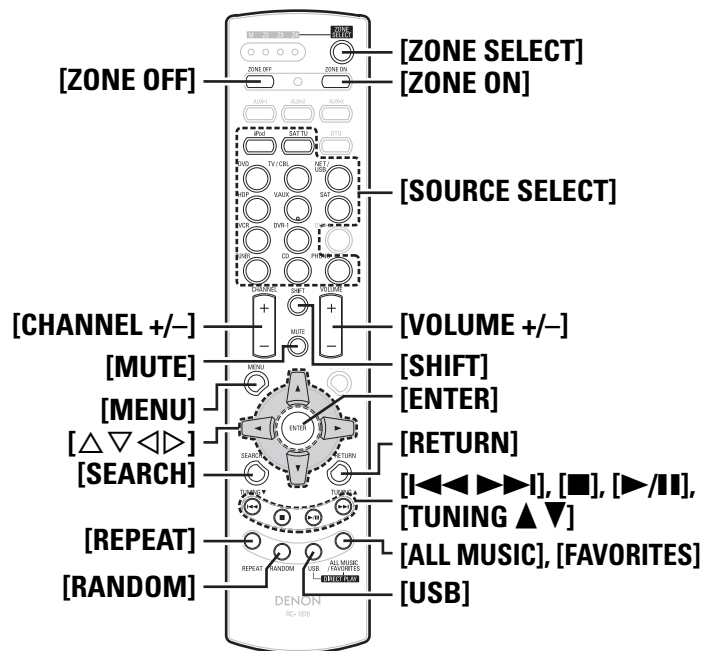

Device operated	NET / USB			iPod		
	M	Z2	Z3	M	Z2	Z3
ZONE SELECT	Zone operation mode selection			Zone operation mode selection		
ZONE OFF	Power turned off (※1)			Power turned off (※1)		
ZONE ON	Power turned on (※1)			Power turned on (※1)		
SOURCE SELECT	Input source selection (※2)			Input source selection		
CHANNEL + / -	Preset channel selection			-		
SHIFT	Preset channel memory block selection			-		
VOLUME + / -	Adjustment of volume (※1)			Adjustment of volume (※1)		
MUTE	Muting (※1)			Muting (※1)		
MENU	Selected zone menu			Selected zone menu		
△ ▽ ◀ ▶	File operations			File operations		
ENTER	File operations			File operations		
SEARCH	Page forward screen / Character search			Page forward screen / Browse/Remote mode switching (press and hold)		
RETURN	File operations			-		
I◀◀ ▶▶I, TUNING ▲ ▼	Track search			Track search		
■	Stop			Stop		
▶/II	Play/pause			Play/pause		
REPEAT	1-track/All-track repeat play (USB)			1-track/All-track repeat play		
RANDOM	1-track random play (USB)			1-track/album shuffle play		
USB	※2			※2		
ALL MUSIC * (Music server only)	※3			※3		
FAVORITES *	※4			※4		

※1: Affects the currently selected zone.

※2: The input source switches to "NET/USB" and the files on the USB memory device are played.

※3: The input source switches to "NET/USB" and the files in "All Music" on the music server are played.

※4: The input source switches to "NET/USB" and the files in "Favorites" are played.

*: Whether "All Music" or "Favorites" is selected depends on the "Direct Play" setting (page 39).

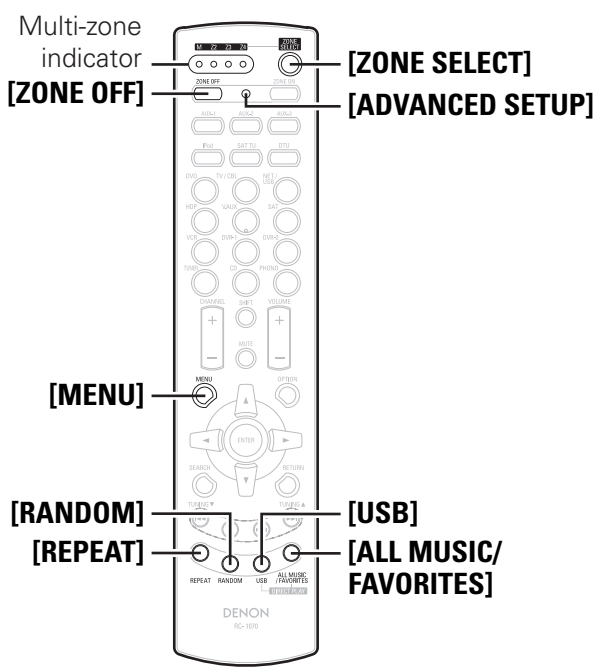

Switching Zones

Use this procedure to select the zone to be operated by the sub remote control unit.

- 1** Press **[ZONE SELECT]**.
The currently selected multi-zone indicator lights.
- 2** While the multi-zone indicator is light, press **[ZONE SELECT]** to select the zone to be operated.
The currently selected multi-zone indicator lights.

Setting the Zone for Which the Sub Remote Control Unit is Used (ZONE SELECT LOCK Mode)

We recommend always using the sub remote control unit for the same room. When this is done, the unit can be set so that the zone does not switch when buttons are operated.

- 1** Use the tip of a pen to press **[ADVANCED SETUP]**.
All the multi-zone indicators light.
- 2** Select the multi-zone to be set.
The selected multi-zone indicator lights.
 - ① To set to main zone : Press **[REPEAT]**.
 - ② To set to ZONE2 : Press **[RANDOM]**.
 - ③ To set to ZONE3 : Press **[USB]**.
- 3** Use the tip of a pen to press **[ADVANCED SETUP]**.
The multi-zone indicator turns off.

To Cancel

- 1** Use the tip of a pen to press **[ADVANCED SETUP]**.
The currently selected multi-zone indicator lights.
- 2** Press **[ZONE SELECT]**.
All the multi-zone indicators light.
- 3** Use the tip of a pen to press **[ADVANCED SETUP]**.
The multi-zone indicator turns off.

Setting the Remote ID

When using multiple DENON AV receivers in the same room, make this setting so that no AV receiver other than the desired one operates.

- 1** While pressing **[MENU]**, press **[ADVANCED SETUP]** with the tip of a pen.
The multi-zone indicator corresponding to the currently selected remote ID flashes.
- 2** Select the remote ID to be set.
 - ① To set to 1 : Press **[REPEAT]**.
The "M" indicator flashes.
 - ② To set to 2 : Press **[RANDOM]**.
The "Z2" indicator flashes.
 - ③ To set to 3 : Press **[USB]**.
The "Z3" indicator flashes.
 - ④ To set to 4 : Press **[ALL MUSIC/FAVORITES]**.
The "Z4" indicator flashes.

- 3** While pressing **[MENU]**, press **[ADVANCED SETUP]** with the tip of a pen.
The multi-zone indicator turns off.

NOTE
When changing a setting, be sure to set the same remote ID as the AVR-3808CI's (page 35).

Resetting the Settings

While pressing **[ZONE OFF]**, press **[ADVANCED SETUP]** with the tip of a pen.
All the multi-zone indicators flash 4 times, then all the settings are restored to their defaults.

Amp Assign / Multi Zone Connections and Operations

The AVR-3808CI is compatible with the following types of playback:

- **Multi-zone playback (ZONE2 & ZONE3)**
- **Bi-amp playback (front speaker)**

NOTE

- For bi-amp playback, use speakers compatible with that type of connection.
- When conducting bi-amp playback, remove the short-circuiting boards (or wires) from the speaker terminals.

Multi-Zone Settings with the Amp Assign Function

The amp assign function lets you assign the amplifiers for the different channels built into the AVR-3808CI to the speaker outputs for the different zones.

Select the desired playback environment from among "Setting 1" to "Setting 4", then set the corresponding "Amp Assign" mode at GUI menu "Manual Setup" – "Option Setup" – "Amp Assign" (page 33).

Connect the speakers as described at "Amp Assign mode settings and speakers connected to the various speaker terminals".



"Setting 3" is possible to switch the Amp Assign mode between the 5.1-channel mode and 2-channel mode without changing the speaker connections.

Setting 1 :

● Multi-zone playback

- 5.1-channel playback + ZONE2 or ZONE3 stereo playback
- 5.1-channel playback + ZONE2 or ZONE3 monaural playback

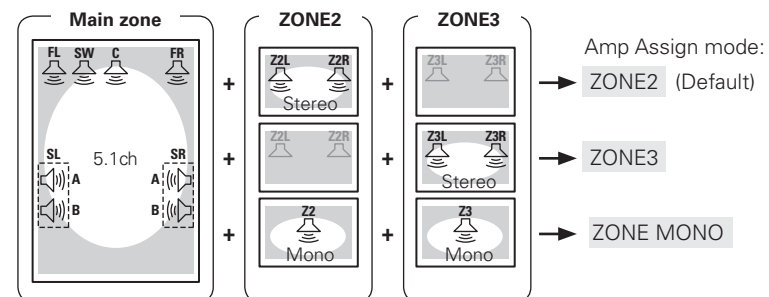

- "STEREO" or "MONO" depends on the setting at GUI menu "Manual Setup" – "Zone Setup" – "Channel" (page 33).
- Both A and B can be installed for SR and SL.

□ Amp Assign mode setting and speakers connected to the various speaker terminals

Speaker terminal	FRONT		CENTER	SURR-A		SURR-B		SURR. BACK / AMP ASSIGN	
	R	L		R	L	R	L	R	L
ZONE2								Z2R	Z2L
ZONE3	FR	FL	C	SR-A	SL-A	SR-B	SL-B	Z3R	Z3L
ZONE MONO								Z3 (MONO)	Z2 (MONO)

Setting 2 : ● 7.1-channel playback

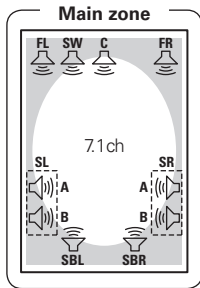

Both A and B can be installed for SR and SL.

- ❑ **Amp Assign mode setting and speakers connected to the various speaker terminals**

Speaker terminal	FRONT		CENTER	SURR-A		SURR-B		SURR. BACK / AMP ASSIGN	
	R	L		R	L	R	L	R	L
Amp Assign mode									
7.1CH	FR	FL	C	SR-A	SL-A	SR-B	SL-B	SBR	SBL

Setting 3 : With this setting it is possible to switch between the following two playback modes. ● 5.1-channel playback ● 2-channel playback Switching Surround Mode switching

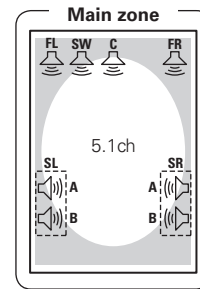

Both A and B can be installed for SR and SL.

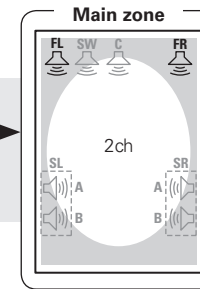

Amp Assign mode:

2ch

- ❑ **Amp Assign mode setting and speakers connected to the various speaker terminals**

Speaker terminal	FRONT		CENTER	SURR-A		SURR-B		SURR. BACK / AMP ASSIGN	
	R	L		R	L	R	L	R	L
Amp Assign mode									
2CH	FR	FL	C	SR-A	SL-A	SR-B	SL-B	FR	FL

Setting 4 :

- Making bi-amp connections for the FL and FR channels in the main zone and conducting 5.1-channel playback (switching with other modes not possible)

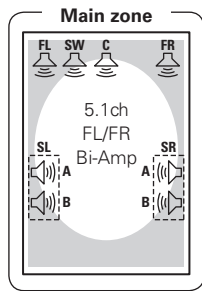

Amp Assign mode:

Bi-Amp

Both A and B can be installed for SR and SL.

- Amp Assign mode setting and speakers connected to the various speaker terminals

Speaker terminal	FRONT		CENTER	SURRE-A		SURRE-B		SURRE. BACK / AMP ASSIGN	
	R	L		R	L	R	L	R	L
Amp Assign mode								FR	FL
Bi-Amp	FR	FL	C	SR-A	SL-A	SR-B	SL-B	FL/FR Bi-Amp connection	

Multi-Zone Settings and Operations with Zone Pre-out Output

Prepare power amplifiers for ZONE2 and ZONE3.

	Connectors for audio output	Audio signals	Connectors for video output
ZONE2	ZONE2 PRE OUT	Stereo	ZONE2 VIDEO OUT
ZONE3	ZONE3 PRE OUT	Stereo	-

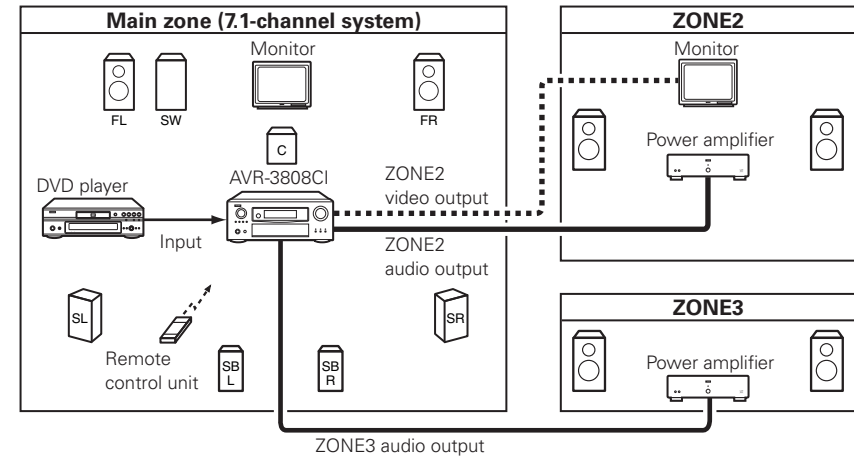

-----: Multi-zone video cable
 —————: Multi-zone audio cable



- When only using one speaker for ZONE2 or ZONE3, set to "Mono". In this case, the ZONE2 (ZONE3) monaural output is output from the ZONE2 (ZONE3) pre-out L and R connectors, so connect as desired.
- Separate power amplifiers are needed for ZONE2 and ZONE3.

<SOURCE SELECT> <ZONE3 ON/OFF> <VOLUME>

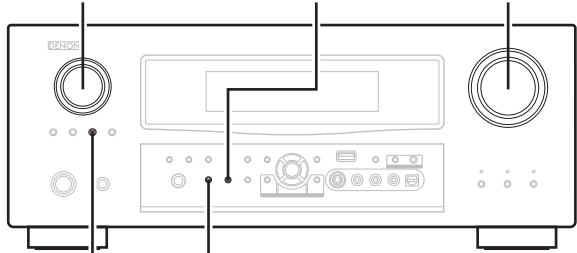

<ZONE2 ON/OFF>

<ZONE2/3 / REC SELECT>

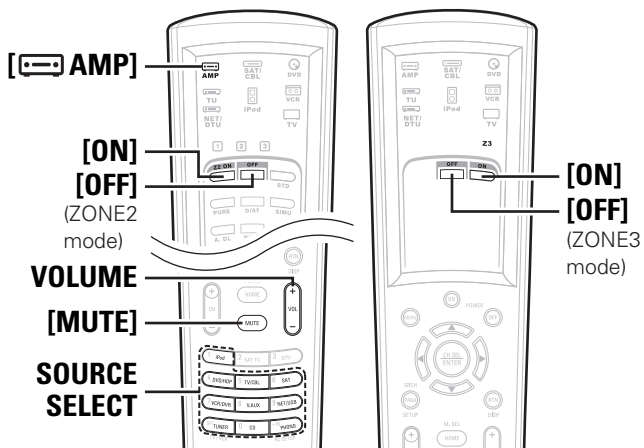

(Main remote control unit)

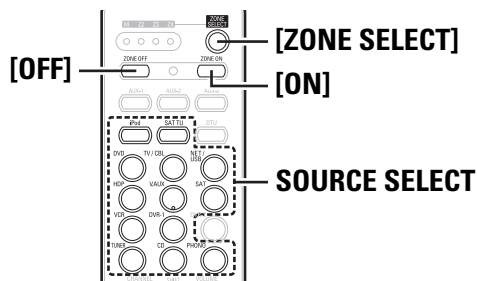

(Sub remote control unit)

About the button names in these explanations

< > : Buttons on the main unit
[] : Buttons on the remote control unit

Button name only:

Buttons on the main unit and remote control unit

Multi-Zone Operations

Turning the Power On and Off

Operation on the main unitG

Press <ZONE2 ON/OFF>, <ZONE3 ON/OFF> for the zone to be operated. When the power turns on, the multi-zone indicator lights on the display.

Operation on the remote control unitG

In the zone mode you want to operate, press [ON] or [OFF].

Selecting the Input Source

Operation on the main unitG

- 1 Press <ZONE2/3 / REC SELECT> and select the zone to be adjusted.
- 2 Turn <SOURCE SELECT>.

Operation on the remote control unitG

In the zone mode you want to operate, press [SOURCE SELECT].

Adjusting the Volume

Operation on the main unitG

- 1 Press <ZONE2/3 / REC SELECT> and select the zone to be adjusted.
- 2 Turn <VOLUME> to adjust.

Operation on the remote control unitG

In the zone mode whose volume you want to adjust, press [VOLUME].

[Variable range] --- -70dB ~ -40dB ~ +18dB



The volume can be adjusted when GUI menu "Manual Setup" - "Zone Setup" - "(select the zone)" - "Volume Level" is set to "Variable". The volume can be increased up to the value set at GUI menu "Manual Setup" - "Zone Setup" - "(select the zone)" - "Volume Limit" (page 33).

Turning off the Sound Temporarily

In the zone mode for which you want to mute the sound, press [MUTE].

The sound is reduced to the level set at GUI menu "Manual Setup" - "Zone Setup" - "(select the zone)" - "Mute Level" (page 33).

To cancel, either adjust the volume or press [MUTE] again.

The setting is canceled when the zone's power is turned off.



- The source selected for ZONE2 is also output from the recording output connectors.
- For ZONE2, the "Zone Setup" can be made while watching the on-screen display. Also, when ZONE3 is operated, the on-screen display appears on the ZONE2 monitor, so operation can be performed watching this on-screen display.

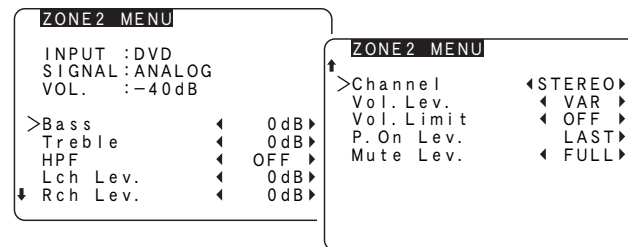

NOTE

- When the input source to which the digital input connectors (OPTICAL/COAXIAL) are assigned is selected in ZONE2 or ZONE3, playback is only possible if the digital signal being input is in PCM (2-channel) format.
- Digital audio signals input from the DENON LINK or HDMI connectors cannot be played in multi-zone.
- When certain digital signals are being input, noise may be output from the ZONE2 and ZONE3 audio output connectors.
- When "DENON LINK" is assigned at the GUI menu "Assign" setting, the PCM signals, network audio signals (Internet radio, music server and USB), XM signals input from the digital input connectors cannot be output from the ZONE2 and ZONE3 audio output connectors.

Other Information

About Speaker Installation

Surround back speakers

Sound positioning directly to the rear can be achieved easily by adding a surround back speaker to a 5.1-channel system. In addition, the acoustic image extending between the sides and the rear is narrowed, thus greatly improving the expression of the surround signals for sounds moving from the sides to the back and from the front to the point directly behind the listening position.

Change of positioning and acoustic image with 5.1-channel systems

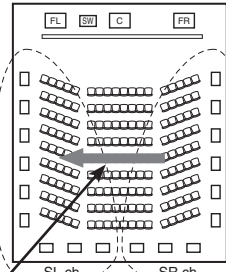

Movement of acoustic image from SR to SL

Change of positioning and acoustic image with 6.1-channel systems

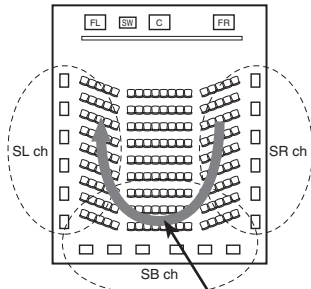

Movement of acoustic image from SR to SB to SL

In addition to sources recorded in 6.1-channels, the surround effect of conventional 2- to 5.1-channel sources can also be enhanced.

Number of surround back speakers

We recommend using 2 speakers. When using dipolar speakers in particular, be sure to use 2 speakers.

Placement of the surround left and right channels when using surround back speakers

We recommend installing the speakers for the surround "L" and "R" channels a bit forward.

Examples of speaker layouts

Below we introduce examples of speaker layouts. Refer to these to arrange your speakers according to their type and how you want to use them.

Using surround back speaker(s)

① When mainly playing movies

Recommended when your surround speakers are single or 2-way speakers.

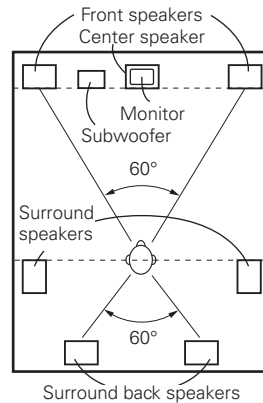

As seen from above

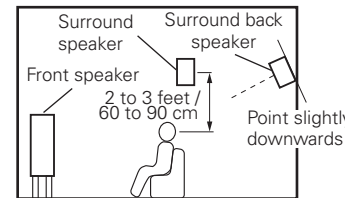

As seen from the side

② Setting for primarily watching movies using diffusion type speakers for the surround speakers

For the greatest sense of surround sound envelopment, diffuse radiation speakers such as bipolar types, or dipolar types, provide a wider dispersion than is possible to obtain from a direct radiating speaker (monopolar). Place these speakers at either side of the prime listening position, mounted above ear level.

Path of the surround sound from the speakers to the listening position

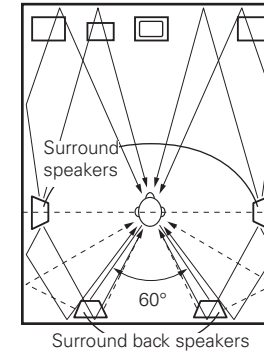

As seen from above

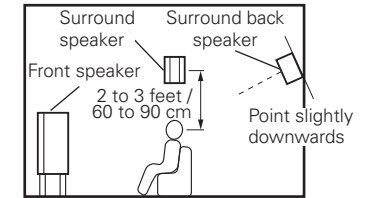

As seen from the side

③ When playing movies and music

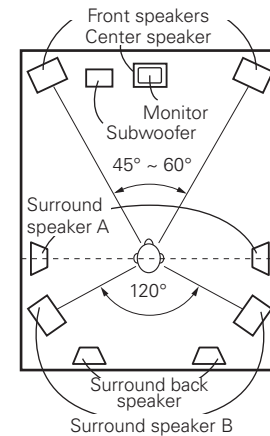

As seen from above

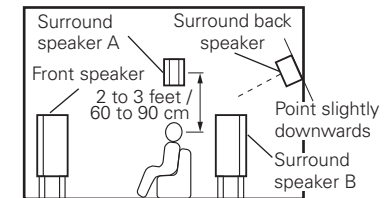

As seen from the side

⚠️ When not using surround back speakers

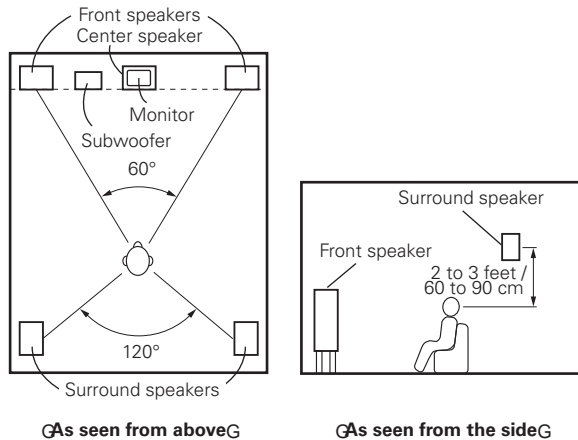

Surround

The AVR-3808CI is equipped with a digital signal processing circuit that lets you play program sources in the surround mode to achieve the same sense of presence as in a movie theater.

Dolby Surround

Dolby Digital

Dolby Digital is a multi-channel digital signal format developed by Dolby Laboratories. A total of 5.1-channels are played: 3 front channels ("FL", "FR" and "C"), 2 surround channels ("SL" and "SR") and the "LFE" channel for low frequencies. Because of this, there is no crosstalk between channels and a realistic sound field with a "three-dimensional" feeling (sense of distance, movement and positioning) is achieved. A real, overpowering sense of presence is achieved when playing movie sources in AV rooms as well.

Dolby Digital Plus

Dolby Digital Plus is an improved Dolby Digital signal format that is compatible with up to 7.1-channels of discrete digital sound and also improves sound quality thanks to extra data bit rate performance. It is upwardly compatible with conventional Dolby Digital, so it offers greater flexibility in response to the source signal and the conditions of the playback equipment.

Dolby TrueHD

Dolby TrueHD is a high definition audio technology developed by Dolby Laboratories, using lossless coding technology to faithfully reproduce the sound of the studio master. This format is compatible with a maximum sampling frequency of 96 kHz and up to 7.1-channels, so it is used for applications particularly prioritizing sound quality.

Dolby Pro Logic II

Dolby Pro Logic II is a matrix decoding technology developed by Dolby Laboratories. Regular music such as that on CDs is encoded into 5-channels to achieve an excellent surround effect. The surround channel signals are converted into stereo and full band signals (with a frequency response of 20 Hz to 20 kHz or greater) to create a "three-dimensional" sound image offering a rich sense of presence for all stereo sources.

Dolby Pro Logic IIx

Dolby Pro Logic IIx is a further improved version of the Dolby Pro Logic II matrix decoding technology. Audio signals recorded in 2-channels are decoded to achieve a natural sound with up to 7.1-channels. There are 3 modes: "Music" suited for playing music, "Cinema" suited for playing movies, and "Game" which is optimized for playing games.

※ Sources recorded in Dolby Surround

Sources recorded in Dolby Surround are indicated with the following logo marks.
Dolby Surround support mark :

Manufactured under license from Dolby Laboratories. "Dolby," "Pro Logic" and the double-D symbol are trademarks of Dolby Laboratories.

DTS Surround

DTS Digital Surround

/DTS Digital Surround is the standard digital surround format of DTS, Inc., compatible with a sampling frequency of 44.1 or 48 kHz and up to 5.1-channels of digital discrete surround sound.

DTS-HD High Resolution Audio

DTS-HD High Resolution Audio is an improved version of the conventional DTS, DTS-ES and DTS 96/24 signals formats, compatible with sampling frequencies of 96 or 48 kHz and up to 7.1-channels of discrete digital sound. High data bit rate performance provides high quality sound. This format is fully compatible with conventional products, including conventional DTS digital surround 5.1-channel data.

DTS-HD Master Audio

DTS-HD Master Audio is DTS, Inc's lossless audio format compatible with up to 96 kHz/7.1-channels. The lossless audio coding technology faithfully reproduces the sound of the studio master. It is fully compatible with conventional products, including conventional DTS digital surround 5.1-channel data.

DTS-ES™ Discrete 6.1

DTS-ES™ Discrete 6.1 is a 6.1-channel discrete digital audio format adding a surround back (SB) channel to the DTS digital surround sound. Decoding of conventional 5.1-channel audio signals is also possible according to the decoder.

DTS-ES™ Matrix 6.1

DTS-ES™ Matrix 6.1 is a 6.1-channel discrete digital audio format inserting a surround back (SB) channel to the DTS digital surround sound through matrix encoding. Decoding of conventional 5.1-channel audio signals is also possible according to the decoder.

DTS NEO:6™ Surround

DTS NEO:6™ is a matrix decoding technology for achieving 6.1-channel surround playback with 2-channel sources. It includes "DTS NEO:6 CINEMA" suited for playing movies and "DTS NEO:6 MUSIC" suited for playing music.

DTS 96/24

DTS 96/24 is a digital audio format enabling high sound quality playback in 5.1-channels with a sampling frequency of 96 kHz and 24 bit quantization on DVD-Video.

Manufactured under license under U.S. Patent #'s: 5,451,942; 5,956,674; 5,974,380; 5,978,762; 6,226,616; 6,487,535 & other U.S. and worldwide patents issued & pending. DTS is a registered trademark and the DTS logos, Symbol, DTS-HD and DTS-HD Master Audio are trademarks of DTS, Inc.© 1996-2007 DTS, Inc. All Rights Reserved.

Neural Surround

Neural Surround™, a breakthrough in audio technology, will bring the excitement of surround music to more of America's listening audience. It provides the rich envelopment and discrete image detail of surround sound in a format 100 % compatible with stereo. With superior spectral resolution and channel separation, Neural Surround™ draws the brain's attention to sonic details in musical instruments, vocals, and ambience that are typically masked by other playback systems. This allows the listener to fully experience the richness and subtleties in recorded performance as never before. As the chosen format for XM Satellite Radio's new XM HD surround programming, Neural Surround will help deliver more surround music to more listeners than any other broadcast format. XM Satellite Radio will be the first radio company to broadcast surround sound on the radio 24 hours a day and will offer three channels fully dedicated to Neural Surround™ music. This alone will amount to more than 25,000 hours of Neural Surround™ music each year.



This product is manufactured under license from Neural Audio Corporation.

D&M Holdings Inc. hereby grants the user a non-exclusive, nontransferable, limited license right exercisable to use the NA SURROUND Technology and other US and World Wide Patents Pending technology.

"Neural" and "Neural Audio" and "Neural Surround" are trademarks of Neural Audio Corporation. All Rights Reserved.

Audyssey MultEQ® XT

Audyssey MultEQ® XT is a technology designed to provide the optimum listening environment for multiple listeners within the listening area. Test data collected from multiple listening points is analyzed comprehensively and equalization that improves the sound quality for the entire listening area is performed.

Audyssey MultEQ XT not only corrects frequency response problems in large listening areas, it also fully automates the surround system setup.

For a detailed description, see page 25.



Audyssey MultEQ® XT is a trademark of Audyssey Laboratories. It is licensed under US and National Patent Applications 20030235318 and 10/700,220. Additional U.S. and Foreign Patents pending. MultEQ XT and the Audyssey MultEQ XT logo are trademarks of Audyssey Laboratories, Inc.. All rights reserved.

HDCD® (High Definition Compatible Digital®)

HDCD® is an encoding/decoding technology that greatly reduces the distortion that occurs upon digital recording while maintaining compatibility with the conventional CD format, thus expanding the dynamic range and achieving a high resolution.

Conventional CDs and HDCD compatible CDs are identified automatically to select the optimum digital processing.

HDCD®, HDCD®, High Definition Compatible Digital® and Microsoft® are either registered trademarks or trademarks of Microsoft Corporation, Inc. in the United States and/or other countries. HDCD system manufactured under license from Microsoft Corporation, Inc. This product is covered by one or more of the following: In the USA: 5,479,168, 5,638,074, 5,640,161, 5,808,574, 5,838,274, 5,854,600, 5,864,311, 5,872,531, and in Australia: 669114. Other patents pending.

DENON LINK

DENON LINK is a unique digital, balanced transfer type interface developed by DENON. It offers high speed, high quality transfer of digital audio data with low signal loss. It can be used together with DENON DVD players equipped with a special DENON LINK connector using a single cable to enable playback with high sound quality.

It allows digital transfer of the 192 kHz/24 bit 2-channel digital signals of DVD-Audio discs, PCM multi-channel signals, etc. Full-spec digital transfer of the audio contents of Super Audio CD is possible by connecting a player equipped for DENON LINK 3rd Edition.

AL24 Processing Plus

AL24 Processing for All Channels

DENON has further developed its proprietary AL24 Processing, an analog waveform reproduction technology, to support the 192 kHz sampling frequency of DVD-Audio. AL24 Processing Plus, thoroughly suppresses quantization noise associated with D/A conversion of LPCM signals to reproduce the low-level signals with optimum clarity that will bring out all the delicate nuances of the music.

Equipped for not only front left and right channels but also for the surround left and right, center and subwoofer channels.

HDMI (High-Definition Multimedia Interface)

HDMI is a digital interface standard for next generation TVs based on DVI (Digital Visual Interface) standards and optimized for use in consumer equipment.

Non-compressed digital video and multi-channel audio signals are transmitted with a single connection.

HDMI is also compatible with HDCP (High-bandwidth Digital Contents Protection), a technology for protecting copyrights that encrypts digital video signals in the same way as with DVI.

Deep Color

Eliminates on-screen color banding, for smooth tonal transitions and subtle gradations between colors.

Enables increased contrast ratio.

Can represent many times more shades of gray between black and white.

At 30-bit pixel depth, a four times improvement would be the minimum, and the typical improvement would be eight times or more.

xvYCC

Next-generation "xvYCC" color space supports 1.8 times as many colors as existing HDTV signals.

Lets HDTVs display colors more accurately.

Enables displays with natural, vivid colors.

Lip Sync

Because consumer electronics devices are using increasingly complex digital signal processing to enhance the clarity and detail of the content, synchronization of video and audio in user devices has become a greater challenge and could potentially require complex end-user adjustments. HDMI 1.3 incorporates an automatic video/audio syncing capability that allows devices to perform this synchronization automatically with total accuracy.

"HDMI", "HDMI logo" and "High-Definition Multimedia Interface" are trademarks or registered trademarks of HDMI Licensing LLC.

Surround Modes and Parameters

Surround Mode	Signals and adjustability in the different modes									
	Channel output					Parameter (default values are shown in parentheses)				
	Front L/R	Center	Surround L/R	Surround Back L/R	Subwoofer	D. COMP *1	LFE *2	AFDM *1	SB CH Out	Cinema EQ.
PURE DIRECT, DIRECT	○	×	×	×	⊙	○ (OFF)	○ (0 dB)	×	×	×
DSD DIRECT	○	×	×	×	×	×	×	×	×	×
DSD MULTI DIRECT	○	⊙	⊙	⊙	⊙	×	○ (0 dB)	×	○	×
MULTI CH DIRECT	○	⊙	⊙	⊙	⊙	×	○ (0 dB)	○ (ON)	○	×
STEREO	○	×	×	×	⊙	○ (OFF)	○ (0 dB)	×	×	×
EXT. IN	○	⊙	⊙	⊙	⊙	×	×	×	×	×
MULTI CH IN	○	⊙	⊙	⊙	⊙	×	○ (0 dB)	○ (ON)	○	×
WIDE SCREEN	○	⊙	⊙	⊙	⊙	○ (OFF)	○ (0 dB)	×	○	○ (OFF)
DOLBY PRO LOGIC IIx	○	⊙	⊙	⊙	⊙	○ (OFF)	×	×	○	○ (NOTE1)
DOLBY PRO LOGIC II	○	⊙	⊙	×	⊙	○ (OFF)	×	×	○	○ (NOTE2)
DTS NEO:6	○	⊙	⊙	⊙	⊙	○ (OFF)	×	×	○	○ (NOTE1)
DOLBY DIGITAL	○	⊙	⊙	⊙	⊙	○ (OFF)	○ (0 dB)	○ (ON)	○	○ (OFF)
DTS SURROUND	○	⊙	⊙	⊙	⊙	○ (OFF)	○ (0 dB)	○ (ON)	○	○ (OFF)
neural	○	⊙	⊙	⊙	⊙	×	×	×	○	×
7CH STEREO	○	⊙	⊙	⊙	⊙	○ (OFF)	○ (0 dB)	×	○	×
SUPER STADIUM	○	⊙	⊙	⊙	⊙	○ (OFF)	○ (0 dB)	×	○	×
ROCK ARENA	○	⊙	⊙	⊙	⊙	○ (OFF)	○ (0 dB)	×	○	×
JAZZ CLUB	○	⊙	⊙	⊙	⊙	○ (OFF)	○ (0 dB)	×	○	×
CLASSIC CONCERT	○	⊙	⊙	⊙	⊙	○ (OFF)	○ (0 dB)	×	○	×
MONO MOVIE	○	⊙	⊙	⊙	⊙	○ (OFF)	○ (0 dB)	×	○	×
VIDEO GAME	○	⊙	⊙	⊙	⊙	○ (OFF)	○ (0 dB)	×	○	×
MATRIX	○	⊙	⊙	⊙	⊙	○ (OFF)	○ (0 dB)	×	○	×
VIRTUAL	○	×	×	×	⊙	○ (OFF)	○ (0 dB)	×	×	×

○ : Signal / Adjustable

× : No signal / Not adjustable

⊙ : Turned on or off by speaker configuration setting

NOTE1 : This parameter is available when the GUI menu "Parameter" - "Audio" - "Surround Parameters" - "Mode" is set to "Cinema" (page 41).

NOTE2 : This parameter is available when the GUI menu "Parameter" - "Audio" - "Surround Parameters" - "Mode" is set to "Cinema" or "Pro Logic" (page 41).

NOTE:

*1 : When playing Dolby Digital and DTS signals.

*2 : When playing Dolby Digital, DTS, DVD-Audio and Super Audio CD.

Surround Mode	Signals and adjustability in the different modes													
	Parameter (default values are shown in parentheses)													
	Mode	Room Size	Effect Level	Delay Time	Subwoofer	PRO LOGIC II/IIx MUSIC mode only			NEO:6 MUSIC mode only	EXT. IN only	Tone	Night Mode	Room EQ	RESTORER
Panorama						Dimension	Center Width	Center Image	Subwoofer Att.					
PURE DIRECT, DIRECT	×	×	×	×	○	×	×	×	×	×	×	○ (OFF)	○ (NOTE5)	○
DSD DIRECT	×	×	×	×	○	×	×	×	×	×	×	×	×	×
DSD MULTI DIRECT	×	×	×	×	×	×	×	×	×	×	×	×	×	×
MULTI CH DIRECT	×	×	×	×	×	×	×	×	×	×	×	○ (OFF)	○ (NOTE5)	×
STEREO	×	×	×	×	×	×	×	×	×	×	○ (0 dB)	○ (OFF)	○ (OFF)	○
EXT. IN	×	×	×	×	×	×	×	×	×	○	×	×	×	×
MULTI CH IN	×	×	×	×	×	×	×	×	×	×	○ (0 dB)	○ (OFF)	○ (OFF)	×
WIDE SCREEN	×	×	○ (ON, 10)	×	×	×	×	×	×	×	○ (0 dB)	○ (OFF)	○ (OFF)	○
DOLBY PRO LOGIC IIx	○ (Cinema)	×	×	×	×	○ (OFF)	○ (3)	○ (3)	×	×	○ (0 dB)	○ (OFF)	○ (OFF)	○
DOLBY PRO LOGIC II	○ (Cinema)	×	×	×	×	○ (OFF)	○ (3)	○ (3)	×	×	○ (0 dB)	○ (OFF)	○ (OFF)	○
DTS NEO:6	○ (Cinema)	×	×	×	×	×	×	×	○ (0.3)	×	○ (0 dB)	○ (OFF)	○ (OFF)	○
DOLBY DIGITAL	×	×	×	×	×	×	×	×	×	×	○ (0 dB)	○ (OFF)	○ (OFF)	×
DTS SURROUND	×	×	×	×	×	×	×	×	×	×	○ (0 dB)	○ (OFF)	○ (OFF)	×
neural	×	×	×	×	×	×	×	×	×	×	○ (0 dB)	○ (OFF)	○ (OFF)	○
7CH STEREO	×	×	×	×	×	×	×	×	×	×	○ (0 dB)	○ (OFF)	○ (OFF)	○
SUPER STADIUM	×	○ (Medium)	○ (10)	×	×	×	×	×	×	×	○ (NOTE3)	○ (OFF)	○ (OFF)	○
ROCK ARENA	×	○ (Medium)	○ (10)	×	×	×	×	×	×	×	○ (NOTE4)	○ (OFF)	○ (OFF)	○
JAZZ CLUB	×	○ (Medium)	○ (10)	×	×	×	×	×	×	×	○ (0 dB)	○ (OFF)	○ (OFF)	○
CLASSIC CONCERT	×	○ (Medium)	○ (10)	×	×	×	×	×	×	×	○ (0 dB)	○ (OFF)	○ (OFF)	○
MONO MOVIE	×	○ (Medium)	○ (10)	×	×	×	×	×	×	×	○ (0 dB)	○ (OFF)	○ (OFF)	○
VIDEO GAME	×	○ (Medium)	○ (10)	×	×	×	×	×	×	×	○ (0 dB)	○ (OFF)	○ (OFF)	○
MATRIX	×	×	×	○ (30 ms)	×	×	×	×	×	×	○ (0 dB)	○ (OFF)	○ (OFF)	○
VIRTUAL	×	×	×	×	×	×	×	×	×	×	○ (0 dB)	○ (OFF)	○ (OFF)	○

○ : Signal / Adjustable

× : No signal / Not adjustable

NOTE3 : BASS +6 dB, TREBLE 0 dB

NOTE4 : BASS +6 dB, TREBLE +4 dB

NOTE5 : Can be used according to the "Direct Mode" setting.

Differences in Surround Mode Names Depending on the Input Signals

Button	Surround Mode	Note	Input signals															
			ANALOG	LINEAR PCM / WAV	WMA (Windows Media Audio) / MP3 / MPEG-4 AAC / FLAC	DTS				DOLBY DIGITAL					DVD-AUDIO		Super Audio CD	
						DTS ES DSCRT (With Flag)	DTS ES MTRX (With Flag)	DTS (5.1ch)	DTS 96/24	DOLBY DIGITAL EX (With Flag)	DOLBY DIGITAL EX (With no Flag)	DOLBY DIGITAL (5.1/5/4ch)	DOLBY DIGITAL (4/3ch)	DOLBY DIGITAL (2ch)	DVD-Audio (multi ch)	DVD-Audio (2ch)	DSD (multi ch)	DSD (2ch)
STANDARD																		
DTS SURROUND																		
	DTS ES DSCRT6.1	*1	×	×	×	●◎	×	×	×	×	×	×	×	×	×	×	×	
	DTS ES MTRX6.1	*1	×	×	×	×	●◎	×	×	×	×	×	×	×	×	×	×	
	DTS SURROUND		×	×	×	○	○	●	×	×	×	×	×	×	×	×	×	
	DTS 96/24		×	×	×	×	×	×	●	×	×	×	×	×	×	×	×	
	DTS + PLIIx CINEMA	*2	×	×	×	○	○	○	○	×	×	×	×	×	×	×	×	
	DTS + PLIIx MUSIC	*1	×	×	×	○	○	○	○	×	×	×	×	×	×	×	×	
	DTS + NEO:6	*1	×	×	×	×	○	○	○	×	×	×	×	×	×	×	×	
	DTS NEO:6 CINEMA		○	○	○	×	×	×	×	×	×	×	○	×	○	×	○	
	DTS NEO:6 MUSIC		○	○	○	×	×	×	×	×	×	×	○	×	○	×	○	
DOLBY SURROUND																		
	DOLBY DIGITAL EX	*1	×	×	×	×	×	×	×	○	○	○	○	×	×	×	×	
	DOLBY DIGITAL		×	×	×	×	×	×	×	○	●	●	●	×	×	×	×	
	DOLBY DIGITAL + PLIIx CINEMA	*2	×	×	×	×	×	×	×	●◎	○	○	○	×	×	×	×	
	DOLBY DIGITAL + PLIIx MUSIC	*1	×	×	×	×	×	×	×	○	○	○	○	×	×	×	×	
	DOLBY PRO LOGIC IIx CINEMA		○	○	○	×	×	×	×	×	×	×	×	●	×	○	×	
	DOLBY PRO LOGIC IIx MUSIC		○	○	○	×	×	×	×	×	×	×	×	○	×	○	×	
	DOLBY PRO LOGIC IIx GAME		○	○	○	×	×	×	×	×	×	×	×	○	×	○	×	
	DOLBY PRO LOGIC II CINEMA		○	○	○	×	×	×	×	×	×	×	×	○	×	○	×	
	DOLBY PRO LOGIC II MUSIC		○	○	○	×	×	×	×	×	×	×	×	○	×	○	×	
	DOLBY PRO LOGIC II GAME		○	○	○	×	×	×	×	×	×	×	×	○	×	○	×	
	DOLBY PRO LOGIC		○	○	○	×	×	×	×	×	×	×	×	○	×	○	×	
	neural		○	○	○	×	×	×	×	×	×	×	×	×	×	○*	×	
MULTI CH IN																		
	MULTI CH IN		×	×	×	×	×	×	×	×	×	×	×	×	×	●	×	
	MULTI IN + PLIIx CINEMA	*2	×	×	×	×	×	×	×	×	×	×	×	×	○	×	○	
	MULTI IN + PLIIx MUSIC	*1	×	×	×	×	×	×	×	×	×	×	×	×	○	×	○	
	MULTI CH IN 7.1		×	×	×	×	×	×	×	×	×	×	×	×	×	●◎ (7.1)	×	

NOTE:

*1: This mode is not available when the surround back speaker setup is set to "None".

*2: This mode is not available when the surround back speaker setup is set to "1spkr" or "None".

● : Mode selectable in initial status

◎ : Mode fixed when "AFDM" is "ON"

○ : Selectable mode

×

* : HDMI input only

Button	Surround Mode	Note	Input signals																																																																																																																																																																																																																																																																																																																																																																																																																																																																																																																																										
			ANALOG	LINEAR PCM / WAV	WMA (Windows Media Audio) / MP3 / MPEG-4 AAC / FLAC	DTS				DOLBY DIGITAL					DVD-AUDIO		Super Audio CD																																																																																																																																																																																																																																																																																																																																																																																																																																																																																																																												
						DTS ES DSCRT (With Flag)	DTS ES MTRX (With Flag)	DTS (5.1ch)	DTS 96/24	DOLBY DIGITAL EX (With Flag)	DOLBY DIGITAL EX (With no Flag)	DOLBY DIGITAL (5.1/5/4ch)	DOLBY DIGITAL (4/3ch)	DOLBY DIGITAL (2ch)	DVD-Audio (multi ch)	DVD-Audio (2ch)	DSD (multi ch)	DSD (2ch)																																																																																																																																																																																																																																																																																																																																																																																																																																																																																																																											
DIRECT																				DIRECT		○	○	○	○	○	○	○	○	○	○	○	○	×	○	×	○		DSD DIRECT		×	×	×	×	×	×	×	×	×	×	×	×	×	×	×	○		DSD MULTI DIRECT		×	×	×	×	×	×	×	×	×	×	×	×	×	×	○	×		MULTI CH DIRECT		×	×	×	×	×	×	×	×	×	×	×	○	×	○	×		M DIRECT + PLIIX CINEMA	*2	×	×	×	×	×	×	×	×	×	×	×	○	×	○	×		M DIRECT + PLIIX MUSIC	*1	×	×	×	×	×	×	×	×	×	×	×	○	×	○	×		M DIRECT 7.1		×	×	×	×	×	×	×	×	×	×	×	○	×	×	×	PURE DIRECT																			PURE DIRECT		○	○	○	○	○	○	○	○	○	○	○	×	○	×	○		DSD PURE DIRECT		×	×	×	×	×	×	×	×	×	×	×	×	×	×	○		DSD MULTI PURE		×	×	×	×	×	×	×	×	×	×	×	×	×	○	×		MULTI CH PURE DIRECT		×	×	×	×	×	×	×	×	×	×	×	○	×	○	×		M PURE D + PLIIX CINEMA	*2	×	×	×	×	×	×	×	×	×	×	×	○	×	○	×		M PURE D + PLIIX MUSIC	*1	×	×	×	×	×	×	×	×	×	×	×	○	×	○	×		M CH PURE DIRECT 7.1		×	×	×	×	×	×	×	×	×	×	×	○	×	×	×	DSP SIMULATION																			7CH STEREO	*3	○	○	○	○	○	○	○	○	○	○	○	○	○	○	○		WIDE SCREEN		○	○	○	○	○	○	○	○	○	○	○	○	○	○	○		SUPER STADIUM		○	○	○	○	○	○	○	○	○	○	○	○	○	○	○		ROCK ARENA		○	○	○	○	○	○	○	○	○	○	○	○	○	○	○		JAZZ CLUB		○	○	○	○	○	○	○	○	○	○	○	○	○	○	○		CLASSIC CONCERT		○	○	○	○	○	○	○	○	○	○	○	○	○	○	○		MONO MOVIE		○	○	○	○	○	○	○	○	○	○	○	○	○	○	○		VIDEO GAME		○	○	○	○	○	○	○	○	○	○	○	○	○	○	○		MATRIX		○	○	○	○	○	○	○	○	○	○	○	○	○	○	○		VIRTUAL		○	○	○	○	○	○	○	○	○	○	○	○	○	○	○	STEREO																			STEREO		●	●	●	○	○	○	○	○	○	○	○	○	○	○	○
	DIRECT		○	○	○	○	○	○	○	○	○	○	○	○	×	○	×	○		DSD DIRECT		×	×	×	×	×	×	×	×	×	×	×	×	×	×	×	○		DSD MULTI DIRECT		×	×	×	×	×	×	×	×	×	×	×	×	×	×	○	×		MULTI CH DIRECT		×	×	×	×	×	×	×	×	×	×	×	○	×	○	×		M DIRECT + PLIIX CINEMA	*2	×	×	×	×	×	×	×	×	×	×	×	○	×	○	×		M DIRECT + PLIIX MUSIC	*1	×	×	×	×	×	×	×	×	×	×	×	○	×	○	×		M DIRECT 7.1		×	×	×	×	×	×	×	×	×	×	×	○	×	×	×	PURE DIRECT																			PURE DIRECT		○	○	○	○	○	○	○	○	○	○	○	×	○	×	○		DSD PURE DIRECT		×	×	×	×	×	×	×	×	×	×	×	×	×	×	○		DSD MULTI PURE		×	×	×	×	×	×	×	×	×	×	×	×	×	○	×		MULTI CH PURE DIRECT		×	×	×	×	×	×	×	×	×	×	×	○	×	○	×		M PURE D + PLIIX CINEMA	*2	×	×	×	×	×	×	×	×	×	×	×	○	×	○	×		M PURE D + PLIIX MUSIC	*1	×	×	×	×	×	×	×	×	×	×	×	○	×	○	×		M CH PURE DIRECT 7.1		×	×	×	×	×	×	×	×	×	×	×	○	×	×	×	DSP SIMULATION																			7CH STEREO	*3	○	○	○	○	○	○	○	○	○	○	○	○	○	○	○		WIDE SCREEN		○	○	○	○	○	○	○	○	○	○	○	○	○	○	○		SUPER STADIUM		○	○	○	○	○	○	○	○	○	○	○	○	○	○	○		ROCK ARENA		○	○	○	○	○	○	○	○	○	○	○	○	○	○	○		JAZZ CLUB		○	○	○	○	○	○	○	○	○	○	○	○	○	○	○		CLASSIC CONCERT		○	○	○	○	○	○	○	○	○	○	○	○	○	○	○		MONO MOVIE		○	○	○	○	○	○	○	○	○	○	○	○	○	○	○		VIDEO GAME		○	○	○	○	○	○	○	○	○	○	○	○	○	○	○		MATRIX		○	○	○	○	○	○	○	○	○	○	○	○	○	○	○		VIRTUAL		○	○	○	○	○	○	○	○	○	○	○	○	○	○	○	STEREO																			STEREO		●	●	●	○	○	○	○	○	○	○	○	○	○	○	○																			
	DSD DIRECT		×	×	×	×	×	×	×	×	×	×	×	×	×	×	×	○		DSD MULTI DIRECT		×	×	×	×	×	×	×	×	×	×	×	×	×	×	○	×		MULTI CH DIRECT		×	×	×	×	×	×	×	×	×	×	×	○	×	○	×		M DIRECT + PLIIX CINEMA	*2	×	×	×	×	×	×	×	×	×	×	×	○	×	○	×		M DIRECT + PLIIX MUSIC	*1	×	×	×	×	×	×	×	×	×	×	×	○	×	○	×		M DIRECT 7.1		×	×	×	×	×	×	×	×	×	×	×	○	×	×	×	PURE DIRECT																			PURE DIRECT		○	○	○	○	○	○	○	○	○	○	○	×	○	×	○		DSD PURE DIRECT		×	×	×	×	×	×	×	×	×	×	×	×	×	×	○		DSD MULTI PURE		×	×	×	×	×	×	×	×	×	×	×	×	×	○	×		MULTI CH PURE DIRECT		×	×	×	×	×	×	×	×	×	×	×	○	×	○	×		M PURE D + PLIIX CINEMA	*2	×	×	×	×	×	×	×	×	×	×	×	○	×	○	×		M PURE D + PLIIX MUSIC	*1	×	×	×	×	×	×	×	×	×	×	×	○	×	○	×		M CH PURE DIRECT 7.1		×	×	×	×	×	×	×	×	×	×	×	○	×	×	×	DSP SIMULATION																			7CH STEREO	*3	○	○	○	○	○	○	○	○	○	○	○	○	○	○	○		WIDE SCREEN		○	○	○	○	○	○	○	○	○	○	○	○	○	○	○		SUPER STADIUM		○	○	○	○	○	○	○	○	○	○	○	○	○	○	○		ROCK ARENA		○	○	○	○	○	○	○	○	○	○	○	○	○	○	○		JAZZ CLUB		○	○	○	○	○	○	○	○	○	○	○	○	○	○	○		CLASSIC CONCERT		○	○	○	○	○	○	○	○	○	○	○	○	○	○	○		MONO MOVIE		○	○	○	○	○	○	○	○	○	○	○	○	○	○	○		VIDEO GAME		○	○	○	○	○	○	○	○	○	○	○	○	○	○	○		MATRIX		○	○	○	○	○	○	○	○	○	○	○	○	○	○	○		VIRTUAL		○	○	○	○	○	○	○	○	○	○	○	○	○	○	○	STEREO																			STEREO		●	●	●	○	○	○	○	○	○	○	○	○	○	○	○																																						
	DSD MULTI DIRECT		×	×	×	×	×	×	×	×	×	×	×	×	×	×	○	×		MULTI CH DIRECT		×	×	×	×	×	×	×	×	×	×	×	○	×	○	×		M DIRECT + PLIIX CINEMA	*2	×	×	×	×	×	×	×	×	×	×	×	○	×	○	×		M DIRECT + PLIIX MUSIC	*1	×	×	×	×	×	×	×	×	×	×	×	○	×	○	×		M DIRECT 7.1		×	×	×	×	×	×	×	×	×	×	×	○	×	×	×	PURE DIRECT																			PURE DIRECT		○	○	○	○	○	○	○	○	○	○	○	×	○	×	○		DSD PURE DIRECT		×	×	×	×	×	×	×	×	×	×	×	×	×	×	○		DSD MULTI PURE		×	×	×	×	×	×	×	×	×	×	×	×	×	○	×		MULTI CH PURE DIRECT		×	×	×	×	×	×	×	×	×	×	×	○	×	○	×		M PURE D + PLIIX CINEMA	*2	×	×	×	×	×	×	×	×	×	×	×	○	×	○	×		M PURE D + PLIIX MUSIC	*1	×	×	×	×	×	×	×	×	×	×	×	○	×	○	×		M CH PURE DIRECT 7.1		×	×	×	×	×	×	×	×	×	×	×	○	×	×	×	DSP SIMULATION																			7CH STEREO	*3	○	○	○	○	○	○	○	○	○	○	○	○	○	○	○		WIDE SCREEN		○	○	○	○	○	○	○	○	○	○	○	○	○	○	○		SUPER STADIUM		○	○	○	○	○	○	○	○	○	○	○	○	○	○	○		ROCK ARENA		○	○	○	○	○	○	○	○	○	○	○	○	○	○	○		JAZZ CLUB		○	○	○	○	○	○	○	○	○	○	○	○	○	○	○		CLASSIC CONCERT		○	○	○	○	○	○	○	○	○	○	○	○	○	○	○		MONO MOVIE		○	○	○	○	○	○	○	○	○	○	○	○	○	○	○		VIDEO GAME		○	○	○	○	○	○	○	○	○	○	○	○	○	○	○		MATRIX		○	○	○	○	○	○	○	○	○	○	○	○	○	○	○		VIRTUAL		○	○	○	○	○	○	○	○	○	○	○	○	○	○	○	STEREO																			STEREO		●	●	●	○	○	○	○	○	○	○	○	○	○	○	○																																																									
	MULTI CH DIRECT		×	×	×	×	×	×	×	×	×	×	×	○	×	○	×		M DIRECT + PLIIX CINEMA	*2	×	×	×	×	×	×	×	×	×	×	×	○	×	○	×		M DIRECT + PLIIX MUSIC	*1	×	×	×	×	×	×	×	×	×	×	×	○	×	○	×		M DIRECT 7.1		×	×	×	×	×	×	×	×	×	×	×	○	×	×	×	PURE DIRECT																			PURE DIRECT		○	○	○	○	○	○	○	○	○	○	○	×	○	×	○		DSD PURE DIRECT		×	×	×	×	×	×	×	×	×	×	×	×	×	×	○		DSD MULTI PURE		×	×	×	×	×	×	×	×	×	×	×	×	×	○	×		MULTI CH PURE DIRECT		×	×	×	×	×	×	×	×	×	×	×	○	×	○	×		M PURE D + PLIIX CINEMA	*2	×	×	×	×	×	×	×	×	×	×	×	○	×	○	×		M PURE D + PLIIX MUSIC	*1	×	×	×	×	×	×	×	×	×	×	×	○	×	○	×		M CH PURE DIRECT 7.1		×	×	×	×	×	×	×	×	×	×	×	○	×	×	×	DSP SIMULATION																			7CH STEREO	*3	○	○	○	○	○	○	○	○	○	○	○	○	○	○	○		WIDE SCREEN		○	○	○	○	○	○	○	○	○	○	○	○	○	○	○		SUPER STADIUM		○	○	○	○	○	○	○	○	○	○	○	○	○	○	○		ROCK ARENA		○	○	○	○	○	○	○	○	○	○	○	○	○	○	○		JAZZ CLUB		○	○	○	○	○	○	○	○	○	○	○	○	○	○	○		CLASSIC CONCERT		○	○	○	○	○	○	○	○	○	○	○	○	○	○	○		MONO MOVIE		○	○	○	○	○	○	○	○	○	○	○	○	○	○	○		VIDEO GAME		○	○	○	○	○	○	○	○	○	○	○	○	○	○	○		MATRIX		○	○	○	○	○	○	○	○	○	○	○	○	○	○	○		VIRTUAL		○	○	○	○	○	○	○	○	○	○	○	○	○	○	○	STEREO																			STEREO		●	●	●	○	○	○	○	○	○	○	○	○	○	○	○																																																																												
	M DIRECT + PLIIX CINEMA	*2	×	×	×	×	×	×	×	×	×	×	×	○	×	○	×		M DIRECT + PLIIX MUSIC	*1	×	×	×	×	×	×	×	×	×	×	×	○	×	○	×		M DIRECT 7.1		×	×	×	×	×	×	×	×	×	×	×	○	×	×	×	PURE DIRECT																			PURE DIRECT		○	○	○	○	○	○	○	○	○	○	○	×	○	×	○		DSD PURE DIRECT		×	×	×	×	×	×	×	×	×	×	×	×	×	×	○		DSD MULTI PURE		×	×	×	×	×	×	×	×	×	×	×	×	×	○	×		MULTI CH PURE DIRECT		×	×	×	×	×	×	×	×	×	×	×	○	×	○	×		M PURE D + PLIIX CINEMA	*2	×	×	×	×	×	×	×	×	×	×	×	○	×	○	×		M PURE D + PLIIX MUSIC	*1	×	×	×	×	×	×	×	×	×	×	×	○	×	○	×		M CH PURE DIRECT 7.1		×	×	×	×	×	×	×	×	×	×	×	○	×	×	×	DSP SIMULATION																			7CH STEREO	*3	○	○	○	○	○	○	○	○	○	○	○	○	○	○	○		WIDE SCREEN		○	○	○	○	○	○	○	○	○	○	○	○	○	○	○		SUPER STADIUM		○	○	○	○	○	○	○	○	○	○	○	○	○	○	○		ROCK ARENA		○	○	○	○	○	○	○	○	○	○	○	○	○	○	○		JAZZ CLUB		○	○	○	○	○	○	○	○	○	○	○	○	○	○	○		CLASSIC CONCERT		○	○	○	○	○	○	○	○	○	○	○	○	○	○	○		MONO MOVIE		○	○	○	○	○	○	○	○	○	○	○	○	○	○	○		VIDEO GAME		○	○	○	○	○	○	○	○	○	○	○	○	○	○	○		MATRIX		○	○	○	○	○	○	○	○	○	○	○	○	○	○	○		VIRTUAL		○	○	○	○	○	○	○	○	○	○	○	○	○	○	○	STEREO																			STEREO		●	●	●	○	○	○	○	○	○	○	○	○	○	○	○																																																																																														
	M DIRECT + PLIIX MUSIC	*1	×	×	×	×	×	×	×	×	×	×	×	○	×	○	×		M DIRECT 7.1		×	×	×	×	×	×	×	×	×	×	×	○	×	×	×	PURE DIRECT																			PURE DIRECT		○	○	○	○	○	○	○	○	○	○	○	×	○	×	○		DSD PURE DIRECT		×	×	×	×	×	×	×	×	×	×	×	×	×	×	○		DSD MULTI PURE		×	×	×	×	×	×	×	×	×	×	×	×	×	○	×		MULTI CH PURE DIRECT		×	×	×	×	×	×	×	×	×	×	×	○	×	○	×		M PURE D + PLIIX CINEMA	*2	×	×	×	×	×	×	×	×	×	×	×	○	×	○	×		M PURE D + PLIIX MUSIC	*1	×	×	×	×	×	×	×	×	×	×	×	○	×	○	×		M CH PURE DIRECT 7.1		×	×	×	×	×	×	×	×	×	×	×	○	×	×	×	DSP SIMULATION																			7CH STEREO	*3	○	○	○	○	○	○	○	○	○	○	○	○	○	○	○		WIDE SCREEN		○	○	○	○	○	○	○	○	○	○	○	○	○	○	○		SUPER STADIUM		○	○	○	○	○	○	○	○	○	○	○	○	○	○	○		ROCK ARENA		○	○	○	○	○	○	○	○	○	○	○	○	○	○	○		JAZZ CLUB		○	○	○	○	○	○	○	○	○	○	○	○	○	○	○		CLASSIC CONCERT		○	○	○	○	○	○	○	○	○	○	○	○	○	○	○		MONO MOVIE		○	○	○	○	○	○	○	○	○	○	○	○	○	○	○		VIDEO GAME		○	○	○	○	○	○	○	○	○	○	○	○	○	○	○		MATRIX		○	○	○	○	○	○	○	○	○	○	○	○	○	○	○		VIRTUAL		○	○	○	○	○	○	○	○	○	○	○	○	○	○	○	STEREO																			STEREO		●	●	●	○	○	○	○	○	○	○	○	○	○	○	○																																																																																																																
	M DIRECT 7.1		×	×	×	×	×	×	×	×	×	×	×	○	×	×	×	PURE DIRECT																			PURE DIRECT		○	○	○	○	○	○	○	○	○	○	○	×	○	×	○		DSD PURE DIRECT		×	×	×	×	×	×	×	×	×	×	×	×	×	×	○		DSD MULTI PURE		×	×	×	×	×	×	×	×	×	×	×	×	×	○	×		MULTI CH PURE DIRECT		×	×	×	×	×	×	×	×	×	×	×	○	×	○	×		M PURE D + PLIIX CINEMA	*2	×	×	×	×	×	×	×	×	×	×	×	○	×	○	×		M PURE D + PLIIX MUSIC	*1	×	×	×	×	×	×	×	×	×	×	×	○	×	○	×		M CH PURE DIRECT 7.1		×	×	×	×	×	×	×	×	×	×	×	○	×	×	×	DSP SIMULATION																			7CH STEREO	*3	○	○	○	○	○	○	○	○	○	○	○	○	○	○	○		WIDE SCREEN		○	○	○	○	○	○	○	○	○	○	○	○	○	○	○		SUPER STADIUM		○	○	○	○	○	○	○	○	○	○	○	○	○	○	○		ROCK ARENA		○	○	○	○	○	○	○	○	○	○	○	○	○	○	○		JAZZ CLUB		○	○	○	○	○	○	○	○	○	○	○	○	○	○	○		CLASSIC CONCERT		○	○	○	○	○	○	○	○	○	○	○	○	○	○	○		MONO MOVIE		○	○	○	○	○	○	○	○	○	○	○	○	○	○	○		VIDEO GAME		○	○	○	○	○	○	○	○	○	○	○	○	○	○	○		MATRIX		○	○	○	○	○	○	○	○	○	○	○	○	○	○	○		VIRTUAL		○	○	○	○	○	○	○	○	○	○	○	○	○	○	○	STEREO																			STEREO		●	●	●	○	○	○	○	○	○	○	○	○	○	○	○																																																																																																																																		
PURE DIRECT																			PURE DIRECT		○	○	○	○	○	○	○	○	○	○	○	×	○	×	○		DSD PURE DIRECT		×	×	×	×	×	×	×	×	×	×	×	×	×	×	○		DSD MULTI PURE		×	×	×	×	×	×	×	×	×	×	×	×	×	○	×		MULTI CH PURE DIRECT		×	×	×	×	×	×	×	×	×	×	×	○	×	○	×		M PURE D + PLIIX CINEMA	*2	×	×	×	×	×	×	×	×	×	×	×	○	×	○	×		M PURE D + PLIIX MUSIC	*1	×	×	×	×	×	×	×	×	×	×	×	○	×	○	×		M CH PURE DIRECT 7.1		×	×	×	×	×	×	×	×	×	×	×	○	×	×	×	DSP SIMULATION																			7CH STEREO	*3	○	○	○	○	○	○	○	○	○	○	○	○	○	○	○		WIDE SCREEN		○	○	○	○	○	○	○	○	○	○	○	○	○	○	○		SUPER STADIUM		○	○	○	○	○	○	○	○	○	○	○	○	○	○	○		ROCK ARENA		○	○	○	○	○	○	○	○	○	○	○	○	○	○	○		JAZZ CLUB		○	○	○	○	○	○	○	○	○	○	○	○	○	○	○		CLASSIC CONCERT		○	○	○	○	○	○	○	○	○	○	○	○	○	○	○		MONO MOVIE		○	○	○	○	○	○	○	○	○	○	○	○	○	○	○		VIDEO GAME		○	○	○	○	○	○	○	○	○	○	○	○	○	○	○		MATRIX		○	○	○	○	○	○	○	○	○	○	○	○	○	○	○		VIRTUAL		○	○	○	○	○	○	○	○	○	○	○	○	○	○	○	STEREO																			STEREO		●	●	●	○	○	○	○	○	○	○	○	○	○	○	○																																																																																																																																																				
	PURE DIRECT		○	○	○	○	○	○	○	○	○	○	○	×	○	×	○		DSD PURE DIRECT		×	×	×	×	×	×	×	×	×	×	×	×	×	×	○		DSD MULTI PURE		×	×	×	×	×	×	×	×	×	×	×	×	×	○	×		MULTI CH PURE DIRECT		×	×	×	×	×	×	×	×	×	×	×	○	×	○	×		M PURE D + PLIIX CINEMA	*2	×	×	×	×	×	×	×	×	×	×	×	○	×	○	×		M PURE D + PLIIX MUSIC	*1	×	×	×	×	×	×	×	×	×	×	×	○	×	○	×		M CH PURE DIRECT 7.1		×	×	×	×	×	×	×	×	×	×	×	○	×	×	×	DSP SIMULATION																			7CH STEREO	*3	○	○	○	○	○	○	○	○	○	○	○	○	○	○	○		WIDE SCREEN		○	○	○	○	○	○	○	○	○	○	○	○	○	○	○		SUPER STADIUM		○	○	○	○	○	○	○	○	○	○	○	○	○	○	○		ROCK ARENA		○	○	○	○	○	○	○	○	○	○	○	○	○	○	○		JAZZ CLUB		○	○	○	○	○	○	○	○	○	○	○	○	○	○	○		CLASSIC CONCERT		○	○	○	○	○	○	○	○	○	○	○	○	○	○	○		MONO MOVIE		○	○	○	○	○	○	○	○	○	○	○	○	○	○	○		VIDEO GAME		○	○	○	○	○	○	○	○	○	○	○	○	○	○	○		MATRIX		○	○	○	○	○	○	○	○	○	○	○	○	○	○	○		VIRTUAL		○	○	○	○	○	○	○	○	○	○	○	○	○	○	○	STEREO																			STEREO		●	●	●	○	○	○	○	○	○	○	○	○	○	○	○																																																																																																																																																																						
	DSD PURE DIRECT		×	×	×	×	×	×	×	×	×	×	×	×	×	×	○		DSD MULTI PURE		×	×	×	×	×	×	×	×	×	×	×	×	×	○	×		MULTI CH PURE DIRECT		×	×	×	×	×	×	×	×	×	×	×	○	×	○	×		M PURE D + PLIIX CINEMA	*2	×	×	×	×	×	×	×	×	×	×	×	○	×	○	×		M PURE D + PLIIX MUSIC	*1	×	×	×	×	×	×	×	×	×	×	×	○	×	○	×		M CH PURE DIRECT 7.1		×	×	×	×	×	×	×	×	×	×	×	○	×	×	×	DSP SIMULATION																			7CH STEREO	*3	○	○	○	○	○	○	○	○	○	○	○	○	○	○	○		WIDE SCREEN		○	○	○	○	○	○	○	○	○	○	○	○	○	○	○		SUPER STADIUM		○	○	○	○	○	○	○	○	○	○	○	○	○	○	○		ROCK ARENA		○	○	○	○	○	○	○	○	○	○	○	○	○	○	○		JAZZ CLUB		○	○	○	○	○	○	○	○	○	○	○	○	○	○	○		CLASSIC CONCERT		○	○	○	○	○	○	○	○	○	○	○	○	○	○	○		MONO MOVIE		○	○	○	○	○	○	○	○	○	○	○	○	○	○	○		VIDEO GAME		○	○	○	○	○	○	○	○	○	○	○	○	○	○	○		MATRIX		○	○	○	○	○	○	○	○	○	○	○	○	○	○	○		VIRTUAL		○	○	○	○	○	○	○	○	○	○	○	○	○	○	○	STEREO																			STEREO		●	●	●	○	○	○	○	○	○	○	○	○	○	○	○																																																																																																																																																																																								
	DSD MULTI PURE		×	×	×	×	×	×	×	×	×	×	×	×	×	○	×		MULTI CH PURE DIRECT		×	×	×	×	×	×	×	×	×	×	×	○	×	○	×		M PURE D + PLIIX CINEMA	*2	×	×	×	×	×	×	×	×	×	×	×	○	×	○	×		M PURE D + PLIIX MUSIC	*1	×	×	×	×	×	×	×	×	×	×	×	○	×	○	×		M CH PURE DIRECT 7.1		×	×	×	×	×	×	×	×	×	×	×	○	×	×	×	DSP SIMULATION																			7CH STEREO	*3	○	○	○	○	○	○	○	○	○	○	○	○	○	○	○		WIDE SCREEN		○	○	○	○	○	○	○	○	○	○	○	○	○	○	○		SUPER STADIUM		○	○	○	○	○	○	○	○	○	○	○	○	○	○	○		ROCK ARENA		○	○	○	○	○	○	○	○	○	○	○	○	○	○	○		JAZZ CLUB		○	○	○	○	○	○	○	○	○	○	○	○	○	○	○		CLASSIC CONCERT		○	○	○	○	○	○	○	○	○	○	○	○	○	○	○		MONO MOVIE		○	○	○	○	○	○	○	○	○	○	○	○	○	○	○		VIDEO GAME		○	○	○	○	○	○	○	○	○	○	○	○	○	○	○		MATRIX		○	○	○	○	○	○	○	○	○	○	○	○	○	○	○		VIRTUAL		○	○	○	○	○	○	○	○	○	○	○	○	○	○	○	STEREO																			STEREO		●	●	●	○	○	○	○	○	○	○	○	○	○	○	○																																																																																																																																																																																																										
	MULTI CH PURE DIRECT		×	×	×	×	×	×	×	×	×	×	×	○	×	○	×		M PURE D + PLIIX CINEMA	*2	×	×	×	×	×	×	×	×	×	×	×	○	×	○	×		M PURE D + PLIIX MUSIC	*1	×	×	×	×	×	×	×	×	×	×	×	○	×	○	×		M CH PURE DIRECT 7.1		×	×	×	×	×	×	×	×	×	×	×	○	×	×	×	DSP SIMULATION																			7CH STEREO	*3	○	○	○	○	○	○	○	○	○	○	○	○	○	○	○		WIDE SCREEN		○	○	○	○	○	○	○	○	○	○	○	○	○	○	○		SUPER STADIUM		○	○	○	○	○	○	○	○	○	○	○	○	○	○	○		ROCK ARENA		○	○	○	○	○	○	○	○	○	○	○	○	○	○	○		JAZZ CLUB		○	○	○	○	○	○	○	○	○	○	○	○	○	○	○		CLASSIC CONCERT		○	○	○	○	○	○	○	○	○	○	○	○	○	○	○		MONO MOVIE		○	○	○	○	○	○	○	○	○	○	○	○	○	○	○		VIDEO GAME		○	○	○	○	○	○	○	○	○	○	○	○	○	○	○		MATRIX		○	○	○	○	○	○	○	○	○	○	○	○	○	○	○		VIRTUAL		○	○	○	○	○	○	○	○	○	○	○	○	○	○	○	STEREO																			STEREO		●	●	●	○	○	○	○	○	○	○	○	○	○	○	○																																																																																																																																																																																																																												
	M PURE D + PLIIX CINEMA	*2	×	×	×	×	×	×	×	×	×	×	×	○	×	○	×		M PURE D + PLIIX MUSIC	*1	×	×	×	×	×	×	×	×	×	×	×	○	×	○	×		M CH PURE DIRECT 7.1		×	×	×	×	×	×	×	×	×	×	×	○	×	×	×	DSP SIMULATION																			7CH STEREO	*3	○	○	○	○	○	○	○	○	○	○	○	○	○	○	○		WIDE SCREEN		○	○	○	○	○	○	○	○	○	○	○	○	○	○	○		SUPER STADIUM		○	○	○	○	○	○	○	○	○	○	○	○	○	○	○		ROCK ARENA		○	○	○	○	○	○	○	○	○	○	○	○	○	○	○		JAZZ CLUB		○	○	○	○	○	○	○	○	○	○	○	○	○	○	○		CLASSIC CONCERT		○	○	○	○	○	○	○	○	○	○	○	○	○	○	○		MONO MOVIE		○	○	○	○	○	○	○	○	○	○	○	○	○	○	○		VIDEO GAME		○	○	○	○	○	○	○	○	○	○	○	○	○	○	○		MATRIX		○	○	○	○	○	○	○	○	○	○	○	○	○	○	○		VIRTUAL		○	○	○	○	○	○	○	○	○	○	○	○	○	○	○	STEREO																			STEREO		●	●	●	○	○	○	○	○	○	○	○	○	○	○	○																																																																																																																																																																																																																																														
	M PURE D + PLIIX MUSIC	*1	×	×	×	×	×	×	×	×	×	×	×	○	×	○	×		M CH PURE DIRECT 7.1		×	×	×	×	×	×	×	×	×	×	×	○	×	×	×	DSP SIMULATION																			7CH STEREO	*3	○	○	○	○	○	○	○	○	○	○	○	○	○	○	○		WIDE SCREEN		○	○	○	○	○	○	○	○	○	○	○	○	○	○	○		SUPER STADIUM		○	○	○	○	○	○	○	○	○	○	○	○	○	○	○		ROCK ARENA		○	○	○	○	○	○	○	○	○	○	○	○	○	○	○		JAZZ CLUB		○	○	○	○	○	○	○	○	○	○	○	○	○	○	○		CLASSIC CONCERT		○	○	○	○	○	○	○	○	○	○	○	○	○	○	○		MONO MOVIE		○	○	○	○	○	○	○	○	○	○	○	○	○	○	○		VIDEO GAME		○	○	○	○	○	○	○	○	○	○	○	○	○	○	○		MATRIX		○	○	○	○	○	○	○	○	○	○	○	○	○	○	○		VIRTUAL		○	○	○	○	○	○	○	○	○	○	○	○	○	○	○	STEREO																			STEREO		●	●	●	○	○	○	○	○	○	○	○	○	○	○	○																																																																																																																																																																																																																																																																
	M CH PURE DIRECT 7.1		×	×	×	×	×	×	×	×	×	×	×	○	×	×	×	DSP SIMULATION																			7CH STEREO	*3	○	○	○	○	○	○	○	○	○	○	○	○	○	○	○		WIDE SCREEN		○	○	○	○	○	○	○	○	○	○	○	○	○	○	○		SUPER STADIUM		○	○	○	○	○	○	○	○	○	○	○	○	○	○	○		ROCK ARENA		○	○	○	○	○	○	○	○	○	○	○	○	○	○	○		JAZZ CLUB		○	○	○	○	○	○	○	○	○	○	○	○	○	○	○		CLASSIC CONCERT		○	○	○	○	○	○	○	○	○	○	○	○	○	○	○		MONO MOVIE		○	○	○	○	○	○	○	○	○	○	○	○	○	○	○		VIDEO GAME		○	○	○	○	○	○	○	○	○	○	○	○	○	○	○		MATRIX		○	○	○	○	○	○	○	○	○	○	○	○	○	○	○		VIRTUAL		○	○	○	○	○	○	○	○	○	○	○	○	○	○	○	STEREO																			STEREO		●	●	●	○	○	○	○	○	○	○	○	○	○	○	○																																																																																																																																																																																																																																																																																		
DSP SIMULATION																			7CH STEREO	*3	○	○	○	○	○	○	○	○	○	○	○	○	○	○	○		WIDE SCREEN		○	○	○	○	○	○	○	○	○	○	○	○	○	○	○		SUPER STADIUM		○	○	○	○	○	○	○	○	○	○	○	○	○	○	○		ROCK ARENA		○	○	○	○	○	○	○	○	○	○	○	○	○	○	○		JAZZ CLUB		○	○	○	○	○	○	○	○	○	○	○	○	○	○	○		CLASSIC CONCERT		○	○	○	○	○	○	○	○	○	○	○	○	○	○	○		MONO MOVIE		○	○	○	○	○	○	○	○	○	○	○	○	○	○	○		VIDEO GAME		○	○	○	○	○	○	○	○	○	○	○	○	○	○	○		MATRIX		○	○	○	○	○	○	○	○	○	○	○	○	○	○	○		VIRTUAL		○	○	○	○	○	○	○	○	○	○	○	○	○	○	○	STEREO																			STEREO		●	●	●	○	○	○	○	○	○	○	○	○	○	○	○																																																																																																																																																																																																																																																																																																				
	7CH STEREO	*3	○	○	○	○	○	○	○	○	○	○	○	○	○	○	○		WIDE SCREEN		○	○	○	○	○	○	○	○	○	○	○	○	○	○	○		SUPER STADIUM		○	○	○	○	○	○	○	○	○	○	○	○	○	○	○		ROCK ARENA		○	○	○	○	○	○	○	○	○	○	○	○	○	○	○		JAZZ CLUB		○	○	○	○	○	○	○	○	○	○	○	○	○	○	○		CLASSIC CONCERT		○	○	○	○	○	○	○	○	○	○	○	○	○	○	○		MONO MOVIE		○	○	○	○	○	○	○	○	○	○	○	○	○	○	○		VIDEO GAME		○	○	○	○	○	○	○	○	○	○	○	○	○	○	○		MATRIX		○	○	○	○	○	○	○	○	○	○	○	○	○	○	○		VIRTUAL		○	○	○	○	○	○	○	○	○	○	○	○	○	○	○	STEREO																			STEREO		●	●	●	○	○	○	○	○	○	○	○	○	○	○	○																																																																																																																																																																																																																																																																																																																						
	WIDE SCREEN		○	○	○	○	○	○	○	○	○	○	○	○	○	○	○		SUPER STADIUM		○	○	○	○	○	○	○	○	○	○	○	○	○	○	○		ROCK ARENA		○	○	○	○	○	○	○	○	○	○	○	○	○	○	○		JAZZ CLUB		○	○	○	○	○	○	○	○	○	○	○	○	○	○	○		CLASSIC CONCERT		○	○	○	○	○	○	○	○	○	○	○	○	○	○	○		MONO MOVIE		○	○	○	○	○	○	○	○	○	○	○	○	○	○	○		VIDEO GAME		○	○	○	○	○	○	○	○	○	○	○	○	○	○	○		MATRIX		○	○	○	○	○	○	○	○	○	○	○	○	○	○	○		VIRTUAL		○	○	○	○	○	○	○	○	○	○	○	○	○	○	○	STEREO																			STEREO		●	●	●	○	○	○	○	○	○	○	○	○	○	○	○																																																																																																																																																																																																																																																																																																																																								
	SUPER STADIUM		○	○	○	○	○	○	○	○	○	○	○	○	○	○	○		ROCK ARENA		○	○	○	○	○	○	○	○	○	○	○	○	○	○	○		JAZZ CLUB		○	○	○	○	○	○	○	○	○	○	○	○	○	○	○		CLASSIC CONCERT		○	○	○	○	○	○	○	○	○	○	○	○	○	○	○		MONO MOVIE		○	○	○	○	○	○	○	○	○	○	○	○	○	○	○		VIDEO GAME		○	○	○	○	○	○	○	○	○	○	○	○	○	○	○		MATRIX		○	○	○	○	○	○	○	○	○	○	○	○	○	○	○		VIRTUAL		○	○	○	○	○	○	○	○	○	○	○	○	○	○	○	STEREO																			STEREO		●	●	●	○	○	○	○	○	○	○	○	○	○	○	○																																																																																																																																																																																																																																																																																																																																																										
	ROCK ARENA		○	○	○	○	○	○	○	○	○	○	○	○	○	○	○		JAZZ CLUB		○	○	○	○	○	○	○	○	○	○	○	○	○	○	○		CLASSIC CONCERT		○	○	○	○	○	○	○	○	○	○	○	○	○	○	○		MONO MOVIE		○	○	○	○	○	○	○	○	○	○	○	○	○	○	○		VIDEO GAME		○	○	○	○	○	○	○	○	○	○	○	○	○	○	○		MATRIX		○	○	○	○	○	○	○	○	○	○	○	○	○	○	○		VIRTUAL		○	○	○	○	○	○	○	○	○	○	○	○	○	○	○	STEREO																			STEREO		●	●	●	○	○	○	○	○	○	○	○	○	○	○	○																																																																																																																																																																																																																																																																																																																																																																												
	JAZZ CLUB		○	○	○	○	○	○	○	○	○	○	○	○	○	○	○		CLASSIC CONCERT		○	○	○	○	○	○	○	○	○	○	○	○	○	○	○		MONO MOVIE		○	○	○	○	○	○	○	○	○	○	○	○	○	○	○		VIDEO GAME		○	○	○	○	○	○	○	○	○	○	○	○	○	○	○		MATRIX		○	○	○	○	○	○	○	○	○	○	○	○	○	○	○		VIRTUAL		○	○	○	○	○	○	○	○	○	○	○	○	○	○	○	STEREO																			STEREO		●	●	●	○	○	○	○	○	○	○	○	○	○	○	○																																																																																																																																																																																																																																																																																																																																																																																														
	CLASSIC CONCERT		○	○	○	○	○	○	○	○	○	○	○	○	○	○	○		MONO MOVIE		○	○	○	○	○	○	○	○	○	○	○	○	○	○	○		VIDEO GAME		○	○	○	○	○	○	○	○	○	○	○	○	○	○	○		MATRIX		○	○	○	○	○	○	○	○	○	○	○	○	○	○	○		VIRTUAL		○	○	○	○	○	○	○	○	○	○	○	○	○	○	○	STEREO																			STEREO		●	●	●	○	○	○	○	○	○	○	○	○	○	○	○																																																																																																																																																																																																																																																																																																																																																																																																																
	MONO MOVIE		○	○	○	○	○	○	○	○	○	○	○	○	○	○	○		VIDEO GAME		○	○	○	○	○	○	○	○	○	○	○	○	○	○	○		MATRIX		○	○	○	○	○	○	○	○	○	○	○	○	○	○	○		VIRTUAL		○	○	○	○	○	○	○	○	○	○	○	○	○	○	○	STEREO																			STEREO		●	●	●	○	○	○	○	○	○	○	○	○	○	○	○																																																																																																																																																																																																																																																																																																																																																																																																																																		
	VIDEO GAME		○	○	○	○	○	○	○	○	○	○	○	○	○	○	○		MATRIX		○	○	○	○	○	○	○	○	○	○	○	○	○	○	○		VIRTUAL		○	○	○	○	○	○	○	○	○	○	○	○	○	○	○	STEREO																			STEREO		●	●	●	○	○	○	○	○	○	○	○	○	○	○	○																																																																																																																																																																																																																																																																																																																																																																																																																																																				
	MATRIX		○	○	○	○	○	○	○	○	○	○	○	○	○	○	○		VIRTUAL		○	○	○	○	○	○	○	○	○	○	○	○	○	○	○	STEREO																			STEREO		●	●	●	○	○	○	○	○	○	○	○	○	○	○	○																																																																																																																																																																																																																																																																																																																																																																																																																																																																						
	VIRTUAL		○	○	○	○	○	○	○	○	○	○	○	○	○	○	○	STEREO																			STEREO		●	●	●	○	○	○	○	○	○	○	○	○	○	○	○																																																																																																																																																																																																																																																																																																																																																																																																																																																																																								
STEREO																			STEREO		●	●	●	○	○	○	○	○	○	○	○	○	○	○	○																																																																																																																																																																																																																																																																																																																																																																																																																																																																																																										
	STEREO		●	●	●	○	○	○	○	○	○	○	○	○	○	○	○																																																																																																																																																																																																																																																																																																																																																																																																																																																																																																																												

NOTE :

- *1: This mode is not available when the surround back speaker setup is set to "None".
- *2: This mode is not available when the surround back speaker setup is set to "1spkr" or "None".
- *3: If the surround back speaker setup is set to "None", then "5CH STEREO" is displayed.

- : Mode selectable in initial status
- : Selectable mode
- ×

× : Non-selectable mode

About Networks

Windows Media Player ver. 11

This is a media player distributed free of charge by Microsoft Corporation.

It can be used to play playlists created with Windows Media Player ver. 11 as well as files in such formats as WMA, DRM WMA, MP3 and WAV.

vTuner

This is a free online contents server for Internet radio. Note that usage fees are included in upgrade costs.

For inquiries about this service, visit the vTuner site below.

vTuner website: <http://www.radiodenon.com>

This product is protected by certain intellectual property rights of Nothing Else Matters Software and BridgeCo. Use or distribution of such technology outside of this product is prohibited without a license from Nothing Else Matters Software and BridgeCo or an authorized subsidiary.

DLNA

- DLNA and DLNA CERTIFIED are trademarks and/or service marks of Digital Living Network Alliance.
- Some contents may not be compatible with other DLNA CERTIFIED™ products.

Windows Media DRM

A copyright-protected technology developed by Microsoft.

- Windows Vista and the Windows logo are trademarks of the Microsoft group of companies.
- The PlaysForSure logo, Windows Media and the Windows logo are trademarks or registered trademarks of Microsoft Corporation in the United States and/or other countries.
- Content providers are using the digital rights management technology for Windows Media contained in this device (WM-DRM) to protect the integrity of their content (Secure Content) so that their intellectual property, including copyright, in such content is not misappropriated. This device uses WM-DRM software to play Secure Content (WM-DRM Software). If the security of the WM-DRM Software in this device has been compromised, owners of Secure Content (Secure Content Owners) may request that Microsoft revoke the WM-DRM Software's right to acquire new licenses to copy, display and/or play Secure Content. Revocation does not alter the WM-DRM Software's ability to play unprotected content. A list of revoked WM-DRM Software is sent to your device whenever you download a license for Secure Content from the Internet or from a PC. Microsoft may, in conjunction with such license, also download revocation list onto your device on behalf of Secure Content Owners.

Relationship Between Video Signals and Monitor Output

□ Main zone

Video Convert	Input signal				Monitor output				Monitor output (when GUI menu displayed)				
	HDMI	COMPONENT	S-VIDEO	VIDEO	HDMI	COMPONENT	S-VIDEO	VIDEO	HDMI	COMPONENT	S-VIDEO	VIDEO	
ON	With HDMI monitor	×	×	×	×	※				※ *3			
		×	×	×	×	※ VIDEO*1	VIDEO*1	VIDEO*1 *4	VIDEO*1 *4	※ VIDEO*2	VIDEO*2	VIDEO*2	VIDEO*2
		×	×	×	×	※ S-VIDEO*1	S-VIDEO*1	S-VIDEO*1	S-VIDEO*1	※ S-VIDEO*2	S-VIDEO*2	S-VIDEO*2	S-VIDEO*2
		×	×	×	×	※ S-VIDEO*1	S-VIDEO*1	S-VIDEO*1	S-VIDEO*1	※ S-VIDEO*2	S-VIDEO*2	S-VIDEO*2	S-VIDEO*2
		×	○ (1080p)	×	×	×	COMPONENT	×	×	※ *3	*3	*3	*3
		×	○ (480p ~ 720p)	×	×	※ COMPONENT*1	COMPONENT*1	×	×	※ COMPONENT*2	COMPONENT*2	×	×
		×	○ (480i/576i)	×	×	※ COMPONENT*1	COMPONENT*1	COMPONENT*1	COMPONENT*1	※ COMPONENT*2	COMPONENT*2	COMPONENT*2	COMPONENT*2
		×	○ (1080p)	×	×	※ VIDEO*1	COMPONENT	VIDEO*1 *4	VIDEO*1 *4	※ VIDEO*2	VIDEO*2	VIDEO*2	VIDEO*2
		×	○ (480p ~ 720p)	×	×	※ COMPONENT*1	COMPONENT*1	×	VIDEO	※ COMPONENT*2	COMPONENT*2	×	VIDEO
		×	○ (480i/576i)	×	×	※ COMPONENT*1	COMPONENT*1	COMPONENT*1	COMPONENT*1	※ COMPONENT*2	COMPONENT*2	COMPONENT*2	COMPONENT*2
		×	○ (1080p)	×	×	※ S-VIDEO*1	COMPONENT	S-VIDEO*1	S-VIDEO*1	※ S-VIDEO*2	S-VIDEO*2	S-VIDEO*2	S-VIDEO*2
		×	○ (480p ~ 720p)	×	×	※ COMPONENT*1	COMPONENT*1	S-VIDEO	S-VIDEO	※ COMPONENT*2	COMPONENT*2	S-VIDEO	S-VIDEO
		×	○ (480i/576i)	×	×	※ COMPONENT*1	COMPONENT*1	COMPONENT*1	COMPONENT*1	※ COMPONENT*2	COMPONENT*2	COMPONENT*2	COMPONENT*2
		×	○ (1080p)	×	×	※ S-VIDEO*1	COMPONENT	S-VIDEO*1	S-VIDEO*1	※ S-VIDEO*2	S-VIDEO*2	S-VIDEO*2	S-VIDEO*2
		×	○ (480p ~ 720p)	×	×	※ COMPONENT*1	COMPONENT*1	S-VIDEO	S-VIDEO	※ COMPONENT*2	COMPONENT*2	S-VIDEO	S-VIDEO
		×	○ (480i/576i)	×	×	※ COMPONENT*1	COMPONENT*1	COMPONENT*1	COMPONENT*1	※ COMPONENT*2	COMPONENT*2	COMPONENT*2	COMPONENT*2
	Without HDMI monitor or with HDMI monitor off	○	×	×	×	HDMI	×	×	×	HDMI*2	×	×	×
		○	×	×	×	HDMI	VIDEO*1	VIDEO*1 *4	VIDEO*1 *4	HDMI*2	VIDEO	VIDEO	VIDEO
		○	×	×	×	HDMI	S-VIDEO*1	S-VIDEO*1	S-VIDEO*1	HDMI*2	S-VIDEO	S-VIDEO	S-VIDEO
		○	×	×	×	HDMI	S-VIDEO*1	S-VIDEO*1	S-VIDEO*1	HDMI*2	S-VIDEO	S-VIDEO	S-VIDEO
		○	○ (1080p)	×	×	HDMI	COMPONENT	×	×	HDMI*2	COMPONENT	×	×
		○	○ (480p ~ 720p)	×	×	HDMI	COMPONENT*1	×	×	HDMI*2	COMPONENT	×	×
		○	○ (480i/576i)	×	×	HDMI	COMPONENT*1	COMPONENT*1	COMPONENT*1	HDMI*2	COMPONENT	COMPONENT	COMPONENT
		○	○ (1080p)	×	×	HDMI	COMPONENT	VIDEO*1 *4	VIDEO*1 *4	HDMI*2	COMPONENT	VIDEO	VIDEO
		○	○ (480p ~ 720p)	×	×	HDMI	COMPONENT*1	×	VIDEO	HDMI*2	COMPONENT	×	VIDEO
		○	○ (480i/576i)	×	×	HDMI	COMPONENT*1	COMPONENT*1	COMPONENT*1	HDMI*2	COMPONENT	COMPONENT	COMPONENT
		○	○ (1080p)	×	×	HDMI	COMPONENT	S-VIDEO*1	S-VIDEO*1	HDMI*2	COMPONENT	S-VIDEO	S-VIDEO
		○	○ (480p ~ 720p)	×	×	HDMI	COMPONENT*1	S-VIDEO	S-VIDEO	HDMI*2	COMPONENT	S-VIDEO	S-VIDEO
		○	○ (480i/576i)	×	×	HDMI	COMPONENT*1	COMPONENT*1	COMPONENT*1	HDMI*2	COMPONENT	COMPONENT	COMPONENT
		○	○ (1080p)	×	×	HDMI	COMPONENT	S-VIDEO*1	S-VIDEO*1	HDMI*2	COMPONENT	S-VIDEO	S-VIDEO
		○	○ (480p ~ 720p)	×	×	HDMI	COMPONENT*1	S-VIDEO	S-VIDEO	HDMI*2	COMPONENT	S-VIDEO	S-VIDEO

○ : Signal present
 × : No signal
 480p ~ 720p : 480p / 576p / 1080i / 720p

× : No output
 *1 : The "Picture Adjust" setting can be made.
 *2 : Superimposed over video signal
 *3 : Only displayed when the **MENU** button is pressed
 *4 : If the input signal is in SECAM format, it is converted to PAL for output

※ : Output according to "Resolution" setting (i/p Scaler : When "A to H" is set) (page 30).
 ■ : Wallpaper or set background color displayed
 ■ : Output according to "Resolution" setting (i/p Scaler : When "H to H" is set) (page 30).
 ■ : GUI menu not displayed

- The main zone video conversion function is compatible with the following formats: NTSC, PAL, SECAM, NTSC4,43, PAL -N, PAL -M and PAL -60.
- When SECAM signals of video input are up-converted, the signals are output in PAL format from the S-Video connector.
- If the input signal is a component 1080p signal, up-converting to HDMI is not possible.
- The GUI menu display cannot be superimposed when xvYCC signals and component 1080p signal, computer's resolution (e.g. VGA) are input.

Video Convert	SIGNAL IN				MONITOR OUT (Normally)				MONITOR OUT (when GUI menu displayed)			
	HDMI	COMPONENT	S-VIDEO	VIDEO	HDMI	COMPONENT	S-VIDEO	VIDEO	HDMI	COMPONENT	S-VIDEO	VIDEO
OFF	×	×	×	×	×	×	×	×	○	○	○	○
	×	×	×	○	×	×	×	○ (VIDEO)	○	○	○	○
	×	×	○	×	×	×	○ (S-VIDEO)	×	○	○	○	○
	×	×	○	○	×	×	○ (S-VIDEO)	○ (VIDEO)	○	○	○	○
	×	○	×	×	×	○ (COMPONENT)	×	×	○	○	○	○
	×	○	×	○	×	○ (COMPONENT)	×	○ (VIDEO)	○	○	○	○
	×	○	○	×	×	○ (COMPONENT)	○ (S-VIDEO)	×	○	○	○	○
	×	○	○	○	×	○ (COMPONENT)	○ (S-VIDEO)	○ (VIDEO)	○	○	○	○
	○	×	×	×	○ (HDMI)	×	×	×	○ (HDMI)*2	×	×	×
	○	×	×	○	○ (HDMI)	×	×	○ (VIDEO)	○ (HDMI)*2	×	×	×
	○	×	○	×	○ (HDMI)	×	○ (S-VIDEO)	×	○ (HDMI)*2	×	×	×
	○	×	○	○	○ (HDMI)	×	○ (S-VIDEO)	○ (VIDEO)	○ (HDMI)*2	×	×	×
	○	○	×	×	○ (HDMI)	○ (COMPONENT)	×	×	○ (HDMI)*2	×	×	×
	○	○	×	○	○ (HDMI)	○ (COMPONENT)	×	○ (VIDEO)	○ (HDMI)*2	×	×	×
	○	○	○	×	○ (HDMI)	○ (COMPONENT)	○ (S-VIDEO)	×	○ (HDMI)*2	×	×	×
	○	○	○	○	○ (HDMI)	○ (COMPONENT)	○ (S-VIDEO)	○ (VIDEO)	○ (HDMI)*2	×	×	×

○ : Signal present
× : No signal

○ : Output present
× : No output
*2: Superimposed over video signal



To display the GUI menu on an HDMI monitor, output with a resolution of 480p/576p.

ZONE2

Input		MONITOR OUT
S-VIDEO	VIDEO	VIDEO
×	×	×
×	○	○ (VIDEO)
○	×	○ (S-VIDEO)
○	○	○ (S-VIDEO)

○ : Signal present
× : No signal

○ : Output present
× : No output

Troubleshooting

If a problem should arise, first check the following:

1. Are the connections correct?
2. Is the set being operated as described in the owner's manual?
3. Are the other components operating properly?

If this unit does not operate properly, check the items listed in the table below. Should the problem persist, there may be a malfunction.

In this case, disconnect the power immediately and contact your store of purchase.

GeneralG

Symptom	Cause	Countermeasure	Page
Power does not turn on, or turns off directly after it was turned on.	<ul style="list-style-type: none"> • Connection of the power cord is faulty. 	<ul style="list-style-type: none"> • Check that the power plugs are securely inserted into the AVR-3808CI's AC inlets and the wall power outlet. 	22
No sound is produced from speakers.	<ul style="list-style-type: none"> • Connection with the input devices or connection of the speaker cables is faulty. 	<ul style="list-style-type: none"> • Check the connections. 	9
	<ul style="list-style-type: none"> • Device you want to play and set input source do not match. 	<ul style="list-style-type: none"> • Select an appropriate input source. 	36, 37
	<ul style="list-style-type: none"> • Master volume is turned too low. 	<ul style="list-style-type: none"> • Adjust the master volume to an appropriate level. 	46
	<ul style="list-style-type: none"> • Mute mode is set. • Headphones are connected. 	<ul style="list-style-type: none"> • Cancel the mute mode. • Disconnect the headphones. 	46
	<ul style="list-style-type: none"> • No digital signals are being input. 	<ul style="list-style-type: none"> • Select an input source for which the digital input setting has been made. 	39
	<ul style="list-style-type: none"> • The connectors to which the digital inputs are assigned and the settable input modes do not match. 	<ul style="list-style-type: none"> • Set the input mode. 	39
Display is off.	<ul style="list-style-type: none"> • The "Dimmer" setting is set to "OFF". 	<ul style="list-style-type: none"> • Set to something other than "OFF". 	35
	<ul style="list-style-type: none"> • The PURE DIRECT mode is set. 	<ul style="list-style-type: none"> • Set a surround mode other than the PURE DIRECT mode. 	40, 41
"DOLBY DIGITAL" indicator does not appear on display.	<ul style="list-style-type: none"> • DVD player's digital audio output setting is not proper. 	<ul style="list-style-type: none"> • Check the DVD player's audio output setting. For details, read the DVD player's operating instructions. 	–

Symptom	Cause	Countermeasure	Page
Power turns off suddenly and power indicator flashes red.	<ul style="list-style-type: none"> • Protection circuit activated due to rise of internal temperature. 	<ul style="list-style-type: none"> • Turn off the power, wait for the set to fully cool down, then turn the power back on. 	10
	<ul style="list-style-type: none"> • Core wires of two speakers are touching each other or a core wire is sticking out of the terminal and touching the set's rear panel, activating the protection circuit. 	<ul style="list-style-type: none"> • Place the set in a well-ventilated place. • First unplug the power cord, then twist the core wires tightly or terminate the speaker cables, then reconnect. 	10
	<ul style="list-style-type: none"> • Speakers with an impedance other than specified are being used. 	<ul style="list-style-type: none"> • Use speakers with the specified impedance. 	10
	<ul style="list-style-type: none"> • Set is damaged. 	<ul style="list-style-type: none"> • Turn off the power and contact a DENON service center. 	–

Remote Control UnitG

Symptom	Cause	Countermeasure	Page
Set does not work properly when remote control unit operated.	<ul style="list-style-type: none"> • Batteries are worn. 	<ul style="list-style-type: none"> • Replace with new batteries. 	3
	<ul style="list-style-type: none"> • You are operating outside of the specified range. 	<ul style="list-style-type: none"> • Operate within the specified range. 	3
	<ul style="list-style-type: none"> • Obstacle between main unit and remote control unit. 	<ul style="list-style-type: none"> • Remove the obstacle. 	3
	<ul style="list-style-type: none"> • The batteries are not inserted in the proper direction, as indicated by the polarity marks in the battery compartment. 	<ul style="list-style-type: none"> • Insert the batteries in the proper direction, following the polarity marks in the battery compartment. 	3
	<ul style="list-style-type: none"> • The set's remote control sensor is exposed to strong light (direct sunlight, inverter type fluorescent bulb light, etc.). 	<ul style="list-style-type: none"> • Move the set to a place in which the remote control sensor will not be exposed to strong light. 	3
	<ul style="list-style-type: none"> • The remote ID of the main unit and remote control unit do not match. 	<ul style="list-style-type: none"> • Set the same remote IDs for the main unit and remote control unit. 	35, 62

GAudioG

Symptom	Cause	Countermeasure	Page
No sound is produced from center speaker.	<ul style="list-style-type: none"> You are playing a monaural source (TV, AM radio broadcast, etc.) in the STANDARD (Dolby/DTS Surround) mode. 	<ul style="list-style-type: none"> The mode is set to something other than "STANDARD (Dolby/DTS Surround)". 	41
No sound is produced from surround speakers.	<ul style="list-style-type: none"> The surround mode is set to "STEREO," "DIRECT" or "PURE DIRECT". 	<ul style="list-style-type: none"> Set to a surround playback mode. 	40, 41
No sound is produced from surround back speaker.	<ul style="list-style-type: none"> The surround back speaker's power amplifier is assigned to a different channel. Surround back speaker setting is set to "None". Surround mode not set to a mode for 6.1- or 7.1-channel playback. 	<ul style="list-style-type: none"> Check the setting and change it as necessary. Set to something other than "None". Select a surround playback mode. 	33 28 40, 41
No sound is produced from subwoofer.	<ul style="list-style-type: none"> Subwoofer's power not turned on. The "Subwoofer" setting at "Speaker configuration" is set to "No". The subwoofer is not properly connected. The subwoofer's volume is turned off. 	<ul style="list-style-type: none"> Turn on the subwoofer's power. Set to "Yes". Check the connections. Adjust the subwoofer's volume to an appropriate level. 	- 28 9 56
No test tones are produced when main remote control unit's TEST TONE button is pressed.	<ul style="list-style-type: none"> Surround mode not set to "STANDARD" (Dolby/DTS Surround). 	<ul style="list-style-type: none"> Set to the STANDARD (Dolby/DTS Surround) mode. 	40
DTS sound is not output.	<ul style="list-style-type: none"> DVD player's audio output setting is not set to bitstream. DVD player is not compatible with DTS sound playback. The AVR-3808CI's "Decode Mode" setting is set to "PCM". 	<ul style="list-style-type: none"> Set the DVD player. For details, refer to the DVD player's operating instructions. Use a DTS-compatible player. Set to the "Auto" or DTS mode. 	- - 38
HDMI audio signals are not output from speakers.	<ul style="list-style-type: none"> The "Manual Setup" – "HDMI Setup" – "Audio" setting is set to "TV". 	<ul style="list-style-type: none"> Set to "Amp". 	30

Symptom	Cause	Countermeasure	Page
No sound is output from the monitor connected with HDMI connections.	<ul style="list-style-type: none"> The "Manual Setup" – "HDMI Setup" – "Audio" setting is set to "Amp". 	<ul style="list-style-type: none"> Set to "TV". 	30

GVideoG

Symptom	Cause	Countermeasure	Page
The on-screen display does not appear.	<ul style="list-style-type: none"> The format of the GUI and TV (NTSC or PAL) do not match. 	<ul style="list-style-type: none"> Match the format of the GUI and TV. 	34
No picture appears.	<ul style="list-style-type: none"> The connections between the AVR-3808CI and monitor are faulty. The monitor's input setting is wrong. PURE DIRECT mode is set. The player is connected using the component input connectors, the monitor is connected using the video (yellow) or S-Video output connectors. 	<ul style="list-style-type: none"> Check the connections. Set properly. Cancel the PURE DIRECT mode. High definition (1080i/720p) and progressive (480p/576p) video signals are not down-converted. Set the player to interlace (480i/576i) signals. 	11 ~ 22 - 40, 41 -
No picture appears with HDMI connections.	<ul style="list-style-type: none"> The connections to the HDMI connectors are faulty. HDMI input setting is improper. The monitor is not compatible with copyright protection (HDCP). The HDMI format of the player and monitor do not match. 	<ul style="list-style-type: none"> Check the connections. Check the HDMI input setting. Connect a monitor that is compatible with copyright protection (HDCP). Match the HDMI format of the player and monitor. 	11 39 11
Picture cannot be recorded.	<ul style="list-style-type: none"> Input source does not match recorder's video connection connector (video or S-Video). 	<ul style="list-style-type: none"> The video conversion function does not work for the REC OUT connectors. Match the input source and recorder connections. 	15
DVDs cannot be copied on a VCR.	-	<ul style="list-style-type: none"> This is not a malfunction. Most movie software includes copy prevention signals and cannot be copied. 	-

GPodG

Symptom	Cause	Countermeasure	Page
iPod cannot be played.	<ul style="list-style-type: none"> The input source assigned to "iPod dock" is not selected. Cable is not properly connected. Control Dock for iPod's AC adapter is not connected to power outlet. 	<ul style="list-style-type: none"> Switch to the input source assigned at "iPod dock". Reconnect. Plug the Control Dock for iPod's AC adapter into a power outlet. 	39
			13
			–

GNET/USBG

Symptom	Cause	Countermeasure	Page
When a USB memory device is connected, "USB" is not displayed on the GUI menu.	<ul style="list-style-type: none"> The set cannot recognize a USB memory device. A USB memory device not conforming to mass storage class or MTP standards is connected. The set port and the connected port do not match. A USB memory device that the set cannot recognize is connected. USB memory device is connected via USB hub. 	<ul style="list-style-type: none"> Check the connection. Connect a USB memory device conforming to mass storage class or MTP standards. Connect to the port set at "USB Select". This is not a malfunction. DENON does not guarantee that all USB memory devices will operate or receive power. Connect the USB memory device directly to the USB port. 	18
			–
			39
			–
Files on a USB memory device cannot be played.	<ul style="list-style-type: none"> USB memory device is in format other than FAT16 or FAT32. USB memory device is divided into multiple partitions. Files are stored in a non-compatible format. You are attempting to play a file that is copyright protected. 	<ul style="list-style-type: none"> Set the format to FAT16 or FAT32. For details, refer to the USB memory device's operating instructions. When divided into multiple partitions, only files stored in the top partition can be played. Record the files in a compatible format. Files that are copyright protected cannot be played on this set. 	–
			–
			51
			51
The file names are not displayed properly ("..," etc.).	<ul style="list-style-type: none"> Characters that cannot be displayed are used. 	<ul style="list-style-type: none"> This is not a malfunction. On this set, characters that cannot be displayed are replaced with " . (period)". 	–

Symptom	Cause	Countermeasure	Page
Internet radio cannot be played.	<ul style="list-style-type: none"> Ethernet cable is not properly connected or network is disconnected. Program is being broadcast in non-compatible format. The computer's or router's firewall is activated. Radio station is not currently broadcasting. IP address is wrong. 	<ul style="list-style-type: none"> Check the connection status. Only Internet radio programs in MP3 and WMA can be played on this set. Check the computer's or router's firewall settings. Choose a radio station that is currently broadcasting. Check the set's IP address. 	20
			51
			–
			52
Files stored on a computer cannot be played.	<ul style="list-style-type: none"> Files are stored in a non-compatible format. You are attempting to play a file that is copyright protected. Set and computer are connected by USB cable. 	<ul style="list-style-type: none"> Record in a compatible format. Files that are copyright protected cannot be played on this set. The set's USB port cannot be used for connection to a computer. 	51
			–
Server is not found, or it is not possible to connect to the server.	<ul style="list-style-type: none"> The computer's or router's firewall is activated. Computer's power is not turned on. Server is not running. Set's IP address is wrong. 	<ul style="list-style-type: none"> Check the computer's or router's firewall settings. Turn on the power. Launch the server. Check the set's IP address. 	–
			–
			–
			32
Cannot connect to preset or favorite radio stations.	<ul style="list-style-type: none"> Radio station is not currently broadcasting. Radio station is not currently in service. 	<ul style="list-style-type: none"> Wait a while before trying again. It is not possible to connect to radio stations that are no longer in service. 	–
			–
For some radio stations, "Server Full" or "Connection Down" is displayed and station cannot be connected to.	<ul style="list-style-type: none"> Station is congested or not currently broadcasting. 	<ul style="list-style-type: none"> Wait a while before trying again. 	–
Sound is broken during playback.	<ul style="list-style-type: none"> Network's signal transfer speed is slow or communications lines or radio station is congested. 	<ul style="list-style-type: none"> This is not a malfunction. When playing broadcast data with a high bit rate, the sound may be broken, depending on the communications conditions. 	–
Sound quality is poor or played sound is noisy.	<ul style="list-style-type: none"> File being played has a low bit rate. 	<ul style="list-style-type: none"> This is not a malfunction. 	–

XM Satellite RadioG

Symptom	Cause	Countermeasure	Page
"CHECK ANTENNA" is displayed in the XM mode.	<ul style="list-style-type: none"> • AVR-3808CI's XM connector and the XM Mini-Tuner and Home Dock is not properly connected. 	<ul style="list-style-type: none"> • Check that the connections are correct. 	18
"NO SIGNAL" is displayed in the XM mode.	<ul style="list-style-type: none"> • The signal cannot be received. 	<ul style="list-style-type: none"> • Reposition your XM Mini-Tuner and Home Dock antenna. 	49
"OFF AIR" is displayed in the XM mode.	<ul style="list-style-type: none"> • The selected channel is not currently broadcasting. 	<ul style="list-style-type: none"> • Select another channel. 	48, 49
Receiving only XM channels 0 and 1.	<ul style="list-style-type: none"> • The XM Tuner is not activated. 	<ul style="list-style-type: none"> • Contact XM Radio. 	48

Specifications

Audio section

Power amplifier

Rated output:

Front:
130 W + 130 W (8 Ω/ohms, 20 Hz ~ 20 kHz with 0.05 % T.H.D.)
160 W + 160 W (6 Ω/ohms, 1 kHz with 0.7 % T.H.D.)

Center:
130 W (8 Ω/ohms, 20 Hz ~ 20 kHz with 0.05 % T.H.D.)
160 W (6 Ω/ohms, 1 kHz with 0.7 % T.H.D.)

Surround (A + B):
130 W + 130 W (8 Ω/ohms, 20 Hz ~ 20 kHz with 0.05 % T.H.D.)
160 W + 160 W (6 Ω/ohms, 1 kHz with 0.7 % T.H.D.)

Surround back:
130 W + 130 W (8 Ω/ohms, 20 Hz ~ 20 kHz with 0.05 % T.H.D.)
160 W + 160 W (6 Ω/ohms, 1 kHz with 0.7 % T.H.D.)

Dynamic power:
140 W x 2ch (8 Ω/ohms)
210 W x 2ch (4 Ω/ohms)

Output connectors:
Front, Center, Surround back 6 ~ 16 Ω/ohms
Surround: A or B 6 ~ 16 Ω/ohms
A + B 8 ~ 16 Ω/ohms

Analog

Input sensitivity / Input impedance: 200 mV / 47 kΩ/kohms
Frequency response: 10 Hz ~ 100 kHz — +1, -3 dB (DIRECT mode)
S/N: 102 dB (IHF-A weighted, DIRECT mode)
Distortion: 0.005 % (20 Hz ~ 20 kHz) (DIRECT mode)
Rated output: 1.2 V

Digital

D/A output:
Rated output — 2 V (at 0 dB playback)
Total harmonic distortion — 0.008 % (1 kHz, at 0 dB)
S/N ratio — 102 dB
Dynamic range — 96 dB
Format — Digital audio interface

Digital input:

Phono equalizer (PHONO input — REC OUT)

Input sensitivity: 2.5 mV
RIAA deviation: ±1 dB (20 Hz to 20 kHz)
S/N: 74 dB (A weighting, with 5 mV input)
Rated output: 150 mV
Distortion factor: 0.03 % (1 kHz, 3 V)

Video section

Standard video connectors

Input / output level and impedance: 1 Vp-p, 75 Ω/ohms
Frequency response: 5 Hz ~ 10 MHz — +0, -3 dB (when video convert set to "OFF")

S-Video connectors

Input / output level and impedance: Y (brightness) signal — 1 Vp-p, 75 Ω/ohms
C (color) signal — 0.286 Vp-p, 75 Ω/ohms
Frequency response: 5 Hz ~ 10 MHz — +0, -3 dB (when video convert set to "OFF")

Frequency response:

Color component video connector

Input / output level and impedance: Y (brightness) signal — 1 Vp-p, 75 Ω/ohms
P_B / C_B signal — 0.7 Vp-p, 75 Ω/ohms
P_R / C_R signal — 0.7 Vp-p, 75 Ω/ohms
Frequency response: 5 Hz ~ 100 MHz — +0, -3 dB (when video convert set to "OFF")

Tuner section

	[FM]	[AM]
Receiving Range:	87.5 MHz ~ 107.9 MHz	520 kHz ~ 1710 kHz
Usable Sensitivity:	1.0 μV (11.2 dBf)	18 μV
50 dB Quieting Sensitivity:	MONO 1.6 μV (15.3 dBf) STEREO 23 μV (38.5 dBf)	
S/N (IHF-A):	MONO 77 dB STEREO 72 dB	
Total harmonic Distortion (at 1 kHz):	MONO 0.15 % STEREO 0.3 %	

(note: μV at 75 Ω/ohms, 0 dBf = 1 × 10⁻¹⁵ W)

General

Power supply: AC 120 V, 60 Hz
Power consumption: 7.2 A
0.3 W (Standby)
Maximum external dimensions: 434 (W) x 171 (H) x 420 (D) mm (17-3/32" x 6-47/64" x 16-17/32")
Weight: 17.8 kg (39 lbs 3.9 oz)

Main remote control unit (RC-1068)

Batteries: LR6/AA Type (two batteries)
Maximum external dimensions: 63 (W) x 238 (H) x 31 (D) mm (2-31/64" x 9-3/8" x 1-7/32")
Weight: 190 g (Approx 6.7 oz) (including batteries)

Sub remote control unit (RC-1070)

Batteries: R03/AAA Type (two batteries)
Maximum external dimensions: 49 (W) x 220 (H) x 24.5 (D) mm (1-59/64" x 8-21/32" x 31/32")
Weight: 114 g (Approx 4 oz) (including batteries)

* For purposes of improvement, specifications and design are subject to change without notice.

List of preset codes / Liste de codes pré-réglés

Denon Amp

D Denon 81001, 82001, 83001, 84001

Denon Tuner

D Denon (Analog) 52863, 52795, 52800, 52805
Denon (XM Radio) 52864, 52812, 52813, 52814

Denon Digital Tuner

D Denon (NET/USB) 62865, 62837, 62838, 62839

Denon iPod

D Denon 72815, 72816, 72817, 72818

Cable

A A-Mark 00008, 00144
ABC 00237, 00003, 00008
Accuphase 00003
Acorn 00237
Action 00237
Active 00237
ADB 01230
Aichi Denshi 01512
Americast 00899
Amstrad 01222
Archer 00237
Auna 01230
Austar 00276
B BCC 00276
Bell South 00899
Bestlink 00303
Birmingham Cable Communications 00276
British Telecom 00003
C Cable & Wireless 01068
Century 00008
Coship 01462
D Daehan 00778
Daeryung 01877, 00877, 00477, 00008
Digeo 01187
Director 00476
DX Antenna 01500
E Emerson 00303
Encon 00008
F Fosgate 00276
Foxtel 01222
France Telecom 00817
Freebox 01482

Fujitsu 01497
G Galaxi 00008
GE 00237, 00144
Gehua 00476
General Instrument 00476, 00810, 00276, 00003
Gibraltar 00003
GNI 01466
GoldStar 00144
H Hitachi 00003, 00008
Hongtian Jiangsu 01462
Hwain 00303
Insight 00476, 00810
J Jerrold 00476, 00810, 00276, 00003
Jiuzhou 01445
K KNC 00008
L LG 00144
M Macab 00817
Madritel 01230
Maspro 01510
Matav 01082
Memorex 00000
Mitsubishi 00003
Motorola 01376, 00476, 00810, 00276, 01187
MS 00303
N NEC 01496
Noos 00817
Nova Vision 00008
Novaplex 00008
NTL 00276, 00003, 01060, 01068
O Oak 00303
Ono 01068
Optus 00276, 01060
P Pace 01877, 00877, 00237, 00008, 01060, 01068, 01577
Panasonic 00000, 00008, 00144, 01488
Paragon 00000, 00008, 00525
Penney 00000
Philips 01305, 00317, 00817
Pioneer 01877, 00877, 00144, 00533, 01500
Pulsar 00000
PVP Stereo Visual Matrix 00003
Q Quasar 00000
R RadioShack 00303
Regal 00276
Runco 00000
S Sagem 00817
Salora 00000
Samsung 00003, 00000, 00144, 00778, 00840, 01060, 01666

Scientific Atlanta 01877, 00877, 00477, 00237, 00003, 00000, 00008, 01510
Skyworth 01464
Sony 01006, 01460
Sprucer 00144
Starcom 00003
StarHub 00276
Sumitomo 01500, 01504
Supercable 00276
T Taihan 00778
TCL 01445
Telewest 01068
Time Warner cable 01877
TongKook 00840
Torx 00003
Toshiba 00000, 01509
Trans PX 00276, 00303
TS 00003, 00303
U United Cable 00276, 00003
US Electronics 00276, 00003, 00008
V Videoway 00000
Visiopass 00817
Z Zenith 00000, 00525, 00899

Cable/PVR Combination ※1

A Americast 00899
D Digeo 01187
F Freebox 01482
G General Instrument 00810
J Jerrold 00810
M Motorola 01376, 00810, 01187
P Pace 01877, 00237
Pioneer 01877, 00877
S Scientific Atlanta 01877, 00877
Sony 01006
Supercable 00276
T Time Warner cable 01877
Z Zenith 00899

CD Player

A Acoustic Research 40420
Advantage 40032
Aiwa 40157
Arcam 40157
Audio Research 40157
Audiolab 40157
Audiomeca 40157
Audioton 40157
AVI 40157

B Balanced Audio Technology 40157
Burmester 40420
Bush 40388
C Cairn 40157
California Audio Labs 40029, 40303
Cambridge 40157
Cambridge Audio 40157
Cambridge Soundworks 40157
Carver 40157, 40179
CDC 40420
CEC 40420
Copland 40393
Curtis Mathes 40032
Cyrus 40157
D Denon 40873, 40003, 40766, [42867] *, 42868
DKK 40000
DMX Electronics 40157
Dual 40003
Dynaco 40157
Dynamic Bass 40179
F Fisher 40000, 40179
G Garrard 40393, 40420
Genexxa 40000, 40032, 40037, 40179
Goldmund 40157
Grundig 40157
H Hafler 40173
Harman/Kardon 40100, 40157, 40173
Hitachi 40032
I Inkel 40157
Integra 40101
J Jerrold 40003
JVC 40032, 40072
K Kenwood 40681, 40000, 40029, 40157, 40028, 40037, 40036, 40190
KLH 41318
Krell 40157
L Linn 40157
Loewe 40157
Luxman 40393
LXI 40179
M Magnavox 40157
Marantz 40029, 40157
Matsui 40157
MCS 40029
Memorex 40000, 40032, 40179, 40420, 40468
Meridian 40157
Micromega 40157
Miro 40000
Mission 40157

Modulaire 40000, 40032, 40087, 40179, 40420, 40468
MTC 40420
Musical Fidelity 40393
Myryad 40157
N NAD 40000, 40721
Naim 40157
NSM 40157
O Onkyo 40868, 40101
Optimus 40000, 40032, 40037, 40087, 40179, 40393, 40420, 40468
Orion 40393
P Panasonic 40029, 40303, 40388, 40752
Parasound 40420
Penney 40029
Philips 40157
Pioneer 40032, 40101, 40468
Polk Audio 40157
Proceed 40420
Proton 40157
Q QED 40157
Quad 40157
Quasar 40029
R Radiola 40157
RadioShack 40000, 40032, 40179, 40420, 40468
RCA 40032, 40053, 40179, 40420, 40468
Realistic 40000, 40032, 40087, 40179, 40420, 40468
Restek 40157
Revox 40157
Roksan 40420
Rotel 40157, 40420
Royal 40420
S SAE 40157
Saisho 40000
Sansui 40000, 40157
Sanyo 40000, 40087, 40179
SAST 40157
Sears 40179
Sharp 40037
Siemens 40157
Silsonic 40036
Simaudio 40157
Sonic Frontiers 40157
Sony 40490, 40000, 40100, 41364, 40185
Sugden 40157
Sylvania 40157
T TAG McLaren 40157
Tandy 40032
Tascam 40393, 40420

T	Teac	40490, 40393, 40420
	Technics	40029, 40303
	Techwood	40303
	Thomson	40053
	Thorens	40157
	Thule Audio	40157
	Tokai	40420
U	Universum	40157, 40053
V	Victor	40072
W	Wadia	40393
	Wards	40000, 40032, 40157, 40053, 40087, 40179
Y	Yamaha	40490, 40868, 40032, 40036
	Yorx	40000

CD Recorder

D	Denon	40766, 42868
J	JVC	40072
R	RCA	40053, 40420
S	Sony	40000, 40100, 41364
T	Teac	40420
	Thomson	40053

Tape Deck

A	Aiwa	20029, 20197, 20200, 21315
	Akai	20283, 20439
	Arcam	20076
	Audiolab	20029
C	Carver	20029
D	Denon	20076, 20371, 21311, [22471]*
F	Fisher	20074
G	Garrard	20308, 20309, 20375, 20439
	Genexxa	20439
	GoldStar	20375
	Grundig	20029, 20375
H	Harman/Kardon	20182, 20029, 21314
I	Inkel	20070, 20071, 20337
J	JVC	20244, 20273, 20274, 20303, 20304, 20310, 21309
K	Kenwood	20070, 20071, 20092, 20233, 20234, 21364
L	LG	20375
	Luxman	20308, 20309
M	Magnavox	20029
	Marantz	20029, 20009
	Memorex	20099
	Mitsubishi	20283, 20439
	Myryad	20029
O	Onkyo	20135, 20136, 20282
	Optimus	20027, 20220, 20337, 20439
	Orion	20308, 20309

P	Palladium	20375
	Panasonic	20229
	Philips	20029, 20229
	Phonotrend	20337
	Pioneer	20027, 20220, 20099, 20109, 21306, 21312
	Polk Audio	20029
R	Radiola	20029
	RCA	20027, 20220
	Revox	20029
S	Sansui	20029, 20009
	Sanyo	20074
	Sharp	20231, 20371
	Sherwood	20337
	Sonic	20375
	Sony	20243, 20170, 20291, 20234, 21313

T	TaeKwang	20439
	Tandberg	20109
	Teac	20280, 20283, 20289, 20308, 20309
	Technics	20229
	Technovox	20229
	Thorens	20029

U	Universum	20375, 20439
V	Victor	20244, 20273, 20274
W	Wards	20027, 20029
	Wharfedale	20439
Y	Yamaha	20097, 20094

HDTV Tuner ※1

A	ABS	01272
	Accurian	01653
	Alienware	01272
C	CyberPower	01272
D	D-Link	01554
	Dgtec	01363
E	Epson	01563
G	Gateway	01272
H	Hewlett Packard	01272, 01267
	Howard Computers	01272
	HP	01272, 01267
	Hush	01272
I	iBUYPOWER	01272
L	LG	01415
	Linksys	01272, 01365
M	Media Center PC	01272
	Microsoft	01272, 01805
	Mind	01272
	Motorola	01363
N	Niveus Media	01272
	Northgate	01272

P	Packard Bell	01272
	Panasonic	01120
	Pioneer	01010
R	Ricavision	01272
S	Samsung	01190, 01490
	Sensory Science	01126
	Sharp	01010
	SMC	01456
	Sony	01272, 01324, 01364
	Stack 9	01272
	Sylvania	01563
	Systemax	01272
T	Tagar Systems	01272
	Toshiba	01272
	Touch	01272
V	Viewsonic	01272, 01329
	Vizio	01126
	Voodoo	01272
X	Xbox	01805
Z	ZT Group	01272

Satellite Receiver

A	@sat	01300
	@Sky	01334
	A-Mark	00345
	ABsat	00123, 00713
	ADB	00642, 01259, 01367, 01418, 01473, 01491
	AGS	00710
	Aiwa	01514
	Akai	00200
	Alba	00455, 00713, 01284, 01659, 01811
	Allsat	00200, 01043
	Alltech	00713
	Allvision	01232, 01334, 01412
	AlphaStar	00772
	Amitronica	00713
	Amstrad	00345, 00713, 00795, 00847, 00863, 00882, 01113, 01175, 01693, 01801
	Anglo	00713
	Ankaro	00713
	AntSat	01083
	Apollo	00455
	Arcon	01043, 01075
	Armstrong	00200
	Arnion	01300
	Asat	00200
	ASCI	01334
	ASLF	00713
	AssCom	00853
	Astacom	00710

	Aston	00142
	Astra	00713
	Astratec	01743
	Astro	00173, 00658, 01099, 01100, 01113
	Atlantic Telephone	01333
	Atsat	01300
	AtSky	01334
	Audioline	01672
	Aurora	00642, 00879, 01333, 01433
	Austar	00497, 00642, 00863, 00879, 01176, 01259
	Axiel	00710
	Axil	01457, 01659
	Axis	01111
B	B@ytronic	01412
	Beko	00455
	Bell ExpressVu	00775
	Big Sat	01457
	Black Diamond	01284
	Blaupunkt	00173
	Blue Sky	00713
	Boca	00713, 01232, 01366
	Boston	00710, 01251
	Brainwave	00658, 01672
	British Sky Broadcasting	00847, 01175, 01662, 01847
	Broco	00713
	BskyB	00847, 01175, 01662
	BT	00710, 01296
	Bubu Sat	00713
	Bush	01284, 01645, 01672, 01743, 01811
C	Canal	00853
	Canal Digital	00853, 01622
	Canal Satellite	00853, 01339, 01853
	Canal+	00853
	Centrex	01457
	CGV	01413, 01567
	Chaparral	00216
	Cherokee	00123, 00710
	Chess	00713, 01085, 01334, 01626
	Chili	01718
	CityCom	00299, 00394, 00818, 01075, 01176, 01232
	Classic	01672
	Clatronic	01413
	CNS	01367
	Comag	01232, 01366, 01412, 01413
	Condor	01700
	Conia	01695
	Contec	00394
	Continental Edison	01695
	Coship	01457

	Crossdigital	01109
	Crown	01284
	Cryptovision	00455, 00795
	Cyfra+	01076
	Cyrus	00200
D	D-box	00723, 00873, 01114
	Daewoo	00713, 01111, 01296, 01743
	Delfa	00863
	Deltasat	01075
	Dgtec	01542, 01631, 01242
	Digenius	00299
	Digitality	01685
	Digifusion	01645, 01743
	DigiLogic	01284
	DigiQuest	00863, 01300, 01457, 01473
	DigiSat	01232
	Digisky	01457
	DigitAll World	01227
	Digiturk	01076
	Digiwave	01631
	Dijam	01296
	DiPro	01367, 01543
		01377, 00392, 00566, 00639, 01639, 01142, 00247, 00749, 01749, 00724, 00819, 01856, 01076, 01108, 00099, 01109, 01414, 01442, 01609, 01392, 01640
	DiracTV	
	Discovery	00710
	Dish Network System	01505, 01005, 00775, 01775
	Dishpro	01505, 01005, 00775, 01775
	Distratel	01283, 01704
	DMT	01075
	DNT	00200
	Dream Multimedia	01237
	DSE	01375
	DSTV	00642, 00879, 01433
	Durabrand	01284
	DX Antenna	01530
		01505, 01005, 00775, 00455, 00610, 00713, 00853, 00871, 01086, 01200, 01323, 01409, 01418, 01473, 01775
E	Echostar	00713
	Einhell	00713
	Elap	00713, 01567
	Elsat	00713
	Elta	00200, 01659
	Emme Esse	00871
	Energy Sistem	01631
	Engel	00713, 01251
	EP Sat	00455
	Esat	00879
	Eurieult	00882

Eurocrypt	00455
EuroLine	01251
Europa	00863
Europhon	00299
Eurosky	00262, 00299
Eurostar	00818
Eutelsat	00713
Expressvu	00775, 01775
F Fenner	00713
Ferguson	00455, 01291, 01743
Finlandia	00455
Finlux	00455
Flair Mate	00713
FMD	01251, 01413, 01457
Force	01101
Fortec Star	01083
Foxtel	00455, 00497, 00795, 00879, 01162, 01176, 01356
Fracapro Planet	00871
Fracarro	00125, 00871
France Telecom	00871
Freesat	00882
FTE	00863
FTEmaximal	00713, 00863
Fuba	00173, 00262, 00299, 00394, 01214, 01251, 01801
Fugionkyo	00125
Funai	01377
G Galaxis	00853, 00863, 01101, 01111, 01557
Gardiner	00818
Garnet	01075
GbSAT	01214
GE	00392, 00566
Gecco	01412
General Instrument	00869
General Satellite	01176
GF Good Friends	01043
GF Star	01043
Globo	01251, 01334, 01412, 01429, 01626
GOD Digital	00200
GOI	00775, 01775
Gold Box	00853
Gold Vision	01631
Golden Interstar	01283
GoldStar	00394
Goodmans	00455, 01284, 01291
Gradiente	00887
Granada	00455
Grundig	00173, 00345, 00847, 00853, 00879, 01291
H Handan	01622
Hanseatic	01099, 01100

Hauptpage	01672
HB	01214, 01801
HDT	01159
Hills	01232
Hirschmann	00125, 00173, 00299, 00710, 00882, 01085, 01111, 01232, 01412
Hisense	01535
Hitachi	00749, 00819, 00455, 01250, 01284, 01518, 01523, 01525
Homecast	01214, 01680, 01700
Hornet	01300
Houston	00775
HTS	00775, 01775
Hughes Network Systems	01142, 00749, 01749, 01442
Humax	00863, 01176, 01225, 01406, 01427, 01675, 01743, 01790, 01915
Huth	01075
Hyundai	01075, 01159
I iCan	01367
ID Digital	01176
ILLUSION sat	01557, 01631
iLo	01535
Imperial	01334, 01429, 01672
Indovision	00887
Ingelen	00882
Innova	00099
Interstar	01214
InVideo	00871
ISkyB	00887
Italtel	00871
ITT Nokia	00455, 00723, 00873
J Jadeworld	00642
Jaeger	01334
Jerrold	00869
Jiuzhou	01450
JOK	00710
JVC	00775, 01507, 01531, 01775
K K-SAT	00713
Kamm	00713
Kaon	01300
KaTelco	01111
Kathrein	00123, 00173, 00200, 00249, 00394, 00442, 00480, 00504, 00658, 00713, 00818, 01221, 01416, 01561, 01567
Kennex	00125
Kenwood	00853
Klap	00710
Kocmoc TB	01333
Koscom	01043
Kosmos	00442, 01333
Kreiling	00249, 00658

Kreismeyer	00173
Kross	01695
L L&S Electronic	01043, 01334
Labgear	01296
LaSAT	00173, 00299
Lava	01631
Legend	01718
Legrand	01718
Lemon	01334
Lenco	00713
Lenoxx	01611
LG	01075, 01414
Lifesat	00299, 00713, 01043
Lodos	01284
Logik	01284
Logix	01075
Lorenzen	00299
Luxor	00345, 00873
M M Electronic	00818
M vision	01557
Magnavox	00724, 00722
Manata	00710, 00713
Manhattan	00455, 00710, 01083
Marantz	00200
Maspro	00173, 00713, 01530
Master's	00394
Matsui	00173, 00710, 01284, 01743
Maximum	01075, 01334, 01685
McIntosh	00869
MDS	01225
Mediabox	00853
Mediacom	01206
MediaSa	00853
Medion	00299, 00713, 01043, 01075, 01232, 01334, 01412, 01626
Medison	00713
Mega	00200
Memorex	00724
Metronic	00713, 00818, 01283, 01334, 01375, 01704
Metz	00173
MiCO	01811
Micro	00713
Micro Elektronik	00713
Micro Technology	00713
Micromaxx	00299
Microstar	01075
Microtec	00713
Mitsubishi	00749, 00455
Morgan's	00200, 00713, 01232, 01412
Motorola	00869, 00856, 01473
MTEC	01214
Muller	01695

Multibroadcast	00642, 00879
Multichoice	00642, 00879, 01333, 01433, 01559, 01560
Mx Onda	01659
Myriad	00200
Mysat	00713
MySky	01693, 01848, 01850
N NEC	01519
NEOTION	01334
Netgem	01322
Netsat	00099, 00887
Neuf TV	01322
Neuhaus	00713
Neuling	01232
Neusat	00713
Nevir	01659
Next Level	00869
Nikko	00200, 00713, 00723
Noda Electronic	01704
Nokia	00455, 00723, 00751, 00853, 00873, 01023, 01223, 01723
Nordmende	00455, 01611
O OctalTV	01505
Okano	00442
Omega	00887
Opentel	01232, 01412
Optex	00394, 00713, 01043, 01283, 01611
Optimus	00724
Optus	00879
Orbis	01232, 01334, 01412
Orbitech	01099, 01100
Origo	00497
OSAT	00345
P P/Sat	01232
Pace	00200, 00329, 00455, 00497, 00795, 00847, 00853, 00887, 01175, 01323, 01356, 01423, 01693, 01717, 01848, 01850
Pacific	01284, 01375
Packard Bell	01111
Packsat	00710
Palcom	00299, 01409
Panarex	01159
Panasat	00615, 00879, 01333, 01433
Panasonic	00247, 00701, 00455, 00847, 01304, 01404, 01508, 01526, 01527
Panda	00173, 00455
Pansat	01159
Patriot	00710
Paysat	00724
peekTon	01457

Philips	01142, 00749, 01749, 00775, 00724, 00819, 01076, 00722, 00099, 00710, 00455, 00818, 00200, 00847, 00853, 00173, 01114, 00133, 01442, 01543, 01672
Phonotrend	00863, 01200
Pilotime	01339
Pino	01334
Pioneer	01142, 00329, 00853, 01308, 01442
Planet	00871
Plasmatic	00442
Neuf TV	00713, 01611
Polytron	00394
Portland	01296
Preisner	00262, 01101, 01113, 01366
Premier	00723, 00853, 00873, 01429
Prima	00795
Primacom	01111
Primestar	00869
Profile	00710
Promax	00455
Proscan	00392, 00566
Proton	01535
Q QNS	01367, 01402, 01404
Quadral	00710
Quelle	00299
R Radiola	00200
RadioShack	00566, 00775, 00869
Radix	00394, 00882, 01113, 01317
RCA	00392, 00566, 01142, 00775, 00855, 00143, 01291, 01392, 01442
Rebox	01214
Regal	01251
RFT	00200
Roadstar	00713, 00853
Rollmaster	01413
Rover	00713
Rownsonic	01567
S SAB	01251
Saba	00710, 00820
Sabre	00455
Sagem	00820, 01114, 01253, 01307, 01690
Samsung	01377, 01142, 01276, 01108, 01109, 00853, 00863, 01206, 01442, 01458, 01570, 01609, 01700, 01916
Sat Control	01300
Sat Team	00713
SAT+	01409
Satec	00713
Satelco	01232
Satplus	01100

Satstation	01083
Schaub Lorenz	01214
Schneider	00710, 01206, 01251
Schwaiger	00394, 00504, 00863, 01075, 01083, 01111, 01317, 01334, 01412, 01457
SCS	00299
Sedea Electronique	00125, 01206, 01283, 01626
SEG	01075, 01087, 01251, 01626
Seleco	00871
Septimo	01375
Serd	01412
Serino	00610
Servimat	01611
ServiSat	00713, 01251
Sharp	01517
Siemens	00173, 01334, 01429
Silva	00299
Skantin	00713
SKR	00713
SKY	00856, 00099, 00847, 00887, 01014, 01175, 01662, 01693, 01847, 01848, 01850
SKY Italia	00853, 01693, 01847, 01848
Sky Television	01014
Sky XL	01251, 01412
Sky+	01175
Skymaster	00713, 01075, 01085, 01200, 01334, 01409, 01567, 01611
Skymax	00200
Skyplus	01232, 01334, 01412
SkySat	00713
Skyvision	01334
SL	00299, 01672
SM Electronic	00713, 01200, 01409
Smart	00713, 00882, 01101, 01113, 01232, 01404, 01413
Sony	00639, 01639, 00455, 00847, 00853, 01524, 01558, 01640
Star	00887
Star Choice	00869
Star Trak	00772, 00869
Starland	00713
Starlite	00200
Stream	01847, 01848
Strong	00125, 00713, 00820, 00853, 00879, 01159, 01284, 01300, 01409, 01626
Sunkai	00123
Sunny	01300
Sunsat	00713
Sunstar	00642
Supernova	00887
SVA	01455
Systec	01334

T Tantec	00455
Tarbs	01225
Tatung	00455
TBoston	01659
Teac	01225, 01227, 01251, 01322
Tecatel	01200
TechniSat	00262, 00455, 00863, 01099, 01100, 01195, 01197, 01322
Technomate	01283, 01610
Technosonic	01672
Technotrend	01429
Techwood	01284, 01626
Tele System Electronic	01251, 01409, 01611, 01801
Teleciel	01043
TeleClub	01367
Telefunken	00710
Teleka	00262, 00442
Telestar	01099, 01100, 01251, 01334, 01610, 01626
Telesystem	01801
Televés	00455, 01214, 01300, 01334
Televisa	00887
Telewire	01232
Tevion	00713, 01409, 01622, 01672
Thomson	00392, 00566, 00455, 00710, 00713, 00820, 00847, 00853, 01046, 01175, 01291, 01534, 01543, 01662
Thorn	00455
Tiny	01672
Tioko	00394
Tivo	01142, 01442
Tokai	00200
Tonna	00455, 00713, 01611
Topfield	01206, 01208, 01545, 01783
Toshiba	00749, 01749, 00790, 00819, 00455, 01285, 01501, 01516, 01530
TPS	00820, 01253, 01307
Triax	00200, 00713, 00853, 01113, 01227, 01251, 01291, 01296, 01626
Trio	01075
TT-micro	01429
Turnsat	00713
Twiner	00713, 01611
U UEC	00879, 01162, 01333, 01356
UltimateTV	01392, 01640
Uniden	00724, 00722
Unisat	00200
United	01251
Universum	00173, 00299, 01087, 01099, 01251
US Digital	01535
USDTV	01535

V Variosat	00173
Ventana	00200
Vestel	01251
VH Sat	00299
Viasat	01682
ViewSat	01232
Visionic	00125, 01283
VisionNet	01557
Visiosat	00142, 00710, 00713, 01413, 01457, 01718
Viva	00856
Vivid	01162
Voom	00869
VTech	00818
W Wavelength	01232, 01413
Wewa	00455
Wharfedale	01284
Winbox	01801
Wintel	00299
Wisi	00173, 00299, 00455
Worldsat	00123, 00710, 01214, 01251, 01543
X Xcom	00123
XMS	01075
Xsat	00123, 00713, 00847, 01214, 01323
Xtreme	01300
Y Yakumo	01413
Yamada	01718
Yes	00887
Zehnder	00394, 00504, 00818, 01075, 01232, 01251, 01334, 01412, 01413
Zenith	00856, 01856
Zeta Technology	00200
Zodiac	01801

Satellite Receiver/ PVR Combination ※1, ※3

※1	
A @sat	01300
Allvision	01412
Amstrad	01175
Atsat	01300
B B@ytronic	01412
British Sky Broadcasting	01175
BskyB	01175, 01662
Bush	01645
C Canal Satellite	01339
Comag	01412
D Digi fusion	01645
DigiQuest	01300
Digiturk	01076

DirecTV	01377, 00392, 00639, 01142, 01076, 00099, 01392, 01442, 01640
Dish Network System	01505, 00775
Dishpro	01505, 00775
DMT	01075
Dream Multimedia	01237
E EchoStar	01505, 00775, 00610
Expressvu	00775
F Foxtel	01356
G GbSAT	01214
Gecco	01412
Globo	01412
H HDT	01159
Hirschmann	01412
Homecast	01680
Hughes Network Systems	01142, 01442
Humax	01176, 01427, 01675
Huth	01075
Hyundai	01075, 01159
K Kaon	01300
Kathrein	00249, 00658, 01221, 01561
L LG	01075
M Maximum	01334
Mediacom	01206
Medion	01412
Microstar	01075
Morgan's	01412
Motorola	00869
MTEC	01214
Multichoice	01333, 01559, 01560
MySky	01693, 01848, 01850
N NEOTION	01334
Nokia	01023
O Opentel	01412
Orbis	01412
P Pace	01175, 01356, 01423, 01850
Panasonic	01304
Philips	01142, 00099, 01442
Pilotime	01339
Proscan	00392
R Radix	01317
RCA	01392
Rebox	01214
S Sagem	01253, 01307
Samsung	01206, 01442, 01570, 01609
Sat Control	01300
Schneider	01206
Schwaiger	01075, 01412
Sedea Electronique	01206
Serd	01412
SKY	01175, 01693, 01848, 01850

SKY Italia	01848
Sky XL	01412
Skymaster	01075
Skyplus	01412
Sony	00639, 01640
Star Choice	00869
Strong	01300
Sunny	01300
T TechniSat	01195, 01197
Thomson	01175, 01534, 01662
Topfield	01206, 01545, 01783
TPS	01253, 01307
X Xtreme	01300
Z Zehnder	01075, 01412

※3

H Hughes Network Systems	20739
P Philips	20739
S Samsung	20739

Television

1 888	10264
A A-Mark	10047, 10054, 10009
A.R. Systems	10037, 10352, 10374, 10455, 10556
Accent	10009, 10037
Accuscan	10047
Accuscreen	10001
Acoustic Research	11269
Action	10030, 10650
Acura	10009
Addison	10092, 10108, 10653
ADL	11217
Admiral	10047, 10054, 10017, 10051, 10093, 10463, 10180, 10163, 10264, 10418
Advent	10761, 10783, 10815, 10817, 10842, 10876, 11933
Adventuri	10000
Adyson	10217
AEG	11163, 11556
Agashi	10217, 10264
Agna	10150
Aiko	10092, 10009, 10035, 10037, 10217, 10264, 10361, 10371, 10433
Aim	10706, 10037, 10455, 10805
Aiwa	10264, 10701, 11904, 11911
Akai	10000, 10060, 10812, 10702, 10178, 10030, 10145, 10602, 10606, 10631, 10648, 10672, 10714, 10715, 11207, 11537, 11675, 11676, 11903, 10556, 10548, 10480, 10433, 10371, 10361, 10264, 10218, 10217, 10208, 10163, 10037, 10035, 10009

Akashi	10009, 10860
Akiba	10037, 10218, 10455
Akira	10418
Akito	10037
Akura	10171, 10009, 10037, 10163, 10218, 10264, 10668, 10714, 11037, 11498, 11556, 11982
Alaron	10170
Alba	10009, 10036, 10037, 10073, 10163, 10218, 10352, 10370, 10371, 10418, 10443, 10487, 10668, 10714, 11037
Albatron	10700, 10843
Alfide	10672
All-Tel	10865, 11269
Alleron	10030, 10170
Allorgan	10217
Allstar	10037
Ambassador	10150
America Action	10180
American High	10000, 10060
Amplivision	10217, 10370
Amstrad	10000, 10171, 10009, 10011, 10037, 10163, 10218, 10264, 10362, 10371, 10433, 10648, 11037, 11982
Amtron	10000, 10180
Anam	10250, 10180, 10009, 10037, 10700, 10861
Anam National	10250, 10037, 10650
Andersson	11149, 11163
Anglo	10009, 10264
Anhua	10051
Anitech	10009, 10037, 10264
Ansonic	10009, 10037, 10163, 10370, 10374, 10668
AOC	10451, 10093, 10180, 10060, 10178, 10030, 10092, 10009, 10108
Aolinpike	10264
Apex Digital	10156, 10748, 10879, 10765, 10767, 11217, 11943
AR	10352, 10556
Arc En Ciel	10109
Arcam	10217
Ardem	10037, 10714
Aristocrat	10163
Aristona	10037, 10556
ART	11037
Arthur Martin	10163
ASA	10070
Asberg	10037
Asora	10009
Astra	10037
Asuka	10217, 10218, 10264
ATD	10698
Atlantic	10001, 10037

Atori	10009
Auchan	10163
Audinac	10180
Audiosonic	10009, 10037, 10109, 10217, 10218, 10264, 10370, 10374, 10486, 10714, 10715, 10820
Audioton	10217, 10264, 10370, 10486
Audiovox	10451, 10180, 10092, 10623, 10802, 10875, 11937, 11951, 11952
Audioworld	10698
Aumark	10060
Autovox	10217
Aventura	10171
AVP	10000
Awa	10451, 10009, 10011, 10036, 10108, 10217, 10264, 10374, 10606
Axon	11937, 11958
Axxent	10009
Baier	10876
Baihe	10009, 10264
Baile	10001, 10009, 10374, 10661
Baird	10037, 10073, 10109, 10208, 10217, 10343, 11196
Bang & Olufsen	10565
Baohuashi	10264
Baosheng	10009, 10817
Barco	10163, 10556
Basic Line	10009, 10037, 10163, 10217, 10218, 10374, 10455, 10556, 10668, 11037, 11163
Bastide	10217
Bauer	10805
Baur	10037, 10195, 10361, 10455, 10512
Baysonic	10180
Bazin	10217
Beaumont	10017, 10178, 10030
Beijing	10812, 10001, 10009, 10208, 10226, 10264, 10374, 10661, 10817, 10821
Beko	10037, 10195, 10370, 10418, 10486, 10606, 10714, 10715, 10808, 11037
Belcor	10030
Bell & Howell	10054, 10017, 10154, 10093
Belson	10698, 11191
Belstar	11037
BenQ	11032, 11756
Beon	10037, 10163, 10218, 10418
Berthen	10668
Best	10370
Bestar	10037, 10370, 10374
Bestar-Daewoo	10374
Binatone	10217
Black Diamond	10614, 10820, 10821, 11037, 11163, 11909

B

Blackway	10218
Blaupunkt	10036, 10170, 10195, 10200, 10327, 10455
Blue Sky	10037, 10218, 10455, 10487, 10499, 10556, 10668, 10714, 10715, 11037, 11191, 11363
Boots	10009, 10217
BPL	10037, 10208
Bradford	10180
Brandt	10109, 10287, 10335, 10560, 10625, 10714
Brinkmann	10037, 10418, 10486, 10668
Brionvega	10037, 10362
Britannia	10217
Brockwood	10178, 10030
Broksonic	10236, 10463, 10180, 11911, 11938
Brother	10264
BSR	10163
BTC	10218
Bush	11900, 11556, 11037, 10778, 10714, 10698, 10668, 10661, 10614, 10556, 10487, 10374, 10371, 10361, 10335, 10264, 10218, 10217, 10208, 10163, 10037, 10036, 10009
Caihong	10009, 10817
Cailing	10748
Candle	10030
Canton	10218
Capehart	10017, 10178, 10030, 10092, 10036
Capetronic	10030
Capsonic	10264
Carad	10610, 10668, 11037
Carena	10037, 10455
Carnivale	10030
Carrefour	10036, 10037, 10070
Carver	10054, 10170
Cascade	10009, 10037
Casio	10037
Cathay	10037, 10218
CCE	10037, 10217
Celebrity	10000
Celera	10765
Celestial	10767, 10819, 10820, 10821
Centrex	10780
Centrum	11037
Centurion	10037
CGE	10074, 10163, 10370, 10418
Changcheng	10051, 10001, 10009, 10264, 10374, 10661, 10817
Changfei	10009, 10374, 10817
Changfeng	10264, 10817
Changhai	10009, 10817

C

Changhong	10156, 10765, 10009, 10264, 10508, 10767, 10783, 10817, 10819, 10820, 10821, 11008, 11156
Chengdu	10009, 10817
Ching Tai	10092, 10009
Chun Yun	10000, 10180, 10092, 10009, 10700, 10843
Chunfeng	10009, 10264
Chung Hsin	10180, 10053, 10036, 10108
Chunsun	10009, 10817
Cimline	10009, 10218
Cinema	10672
Cineral	10451, 10092
Cinex	10648, 11556
Citek	10047
Citizen	10054, 10000, 10451, 10463, 10180, 10060, 10030, 10171, 10092, 10001, 10035
City	10009
Clarion	10180
Clarivox	10037, 10070, 10418
Classic	10030, 10092, 10499
Clatronic	10009, 10037, 10217, 10218, 10264, 10370, 10371, 10714
Clayton	11037
CMS Hightec	10217
Colortyme	10047, 10054, 10017, 10060, 10178, 10030
Commercial Solutions	11447, 10047
Concorde	10009
Condor	10009, 10037, 10264, 10370, 10418
Conia	10820, 10821, 11498
Conic	10178
Conrac	10808
Conrowa	10156, 10145, 10009, 10264, 10698, 11156, 11170
Contec	10180, 10009, 10036, 10037
Continental Edison	10109, 10287, 10487
Cosmel	10009, 10037
Craig	10180, 10171
Crosley	10054, 10000, 10180, 10030, 10171, 10074, 10163, 10370, 10093, 10180, 10053, 10009, 10037, 10208, 10370, 10418, 10486, 10487, 10606, 10672, 10712, 10714, 10715, 11037
Crown	
Crown Mustang	10672
CS Electronics	10218
CTX	11756
Curtis Mathes	10047, 10054, 10154, 10000, 10051, 10451, 10093, 10180, 10060, 10702, 10178, 10030, 10145, 10166, 10037, 10035, 11147, 11347
CXC	10180
Cybertron	10218
Cytronix	11298
D-Vision	10037, 10556, 11982

D

Daewoo	10154, 10451, 10180, 10178, 10030, 10092, 11661, 10634, 10661, 10672, 10700, 10860, 10865, 10876, 10880, 11755, 11756, 11909, 10623, 10556, 10499, 10374, 10264, 10218, 10217, 10170, 10109, 10108, 10037, 10036, 10009
Dainichi	10218
Dansai	10009, 10035, 10036, 10037, 10208, 10217
Dantax	10370, 10486, 10714, 10715
Datsura	10208
Dawa	10009, 10037
Daytek	10672, 11207
Dayton	10092, 10009, 11207
Daytron	10180, 10178, 10030, 10092, 10009, 10036, 10037, 10374
Dayu	10374, 10661
De Graaf	10163, 10208, 10548
Decca	10037, 10217
Degraff	10163, 10208
Deitron	10374
Dell	11080, 11178
Denko	10264
Denon	10145, 10511
Denver	10037, 10587
Desmet	10009, 10037
Diamant	10037
Diamond	10706, 10009, 10371, 10672, 10698, 10820, 10860
Digatron	10037
Digiline	10037, 10668
Digital Life	10872
Digitex	10820
Digitor	10037
Digix Media	10880
Dixi	10009, 10037, 10217
DL	10587, 10780, 10872
Domeos	10668
Domland	10394
Dongda	10009
Donghai	10009
Dream Vision	11164, 11704
DSE	10698, 10820, 11556
DTS	10009
Dual	10037, 10217, 10343, 10352, 10394, 11037, 11137
Dual Tec	10217
Dumont	10017, 10180, 10178, 10070, 10217
Durabrand	10463, 10180, 10178, 10171, 11034, 11463
Dux	10037
Dwin	10093
Dynatech	10217
Dynatron	10037

E	Easy Living	11248
	Eaton	10060
	Ecco	10773
	ECE	10037
	Edison-Minerva	10487
	Elbe	10037, 10217, 10218, 10362, 10610
	Elcit	10163
	Electroband	10000
	Electrograph	11755
	Electrohome	10154, 10000, 10463, 10150, 10178, 10030, 10073
	Elekta	10009, 10264
	Elfunk	11037, 11208
	ELG	10037
	Elin	10009, 10037, 10361, 10548
	Elite	10037, 10218
	Elta	10009, 10264
	Emerald	10178
		10047, 10017, 10154, 10451, 10236, 10463, 10180, 10150, 10178, 10171, 11944, 11911, 11909, 10714, 10668, 10623, 10486, 10036, 10371, 10370, 10361, 10037, 10195, 10170, 10070, 10073
	Emerson	
	Envision	10030, 10813
	Enzer	10860
	Erae	11371
	Erres	10037
	ESA	10812, 10171, 11944
	ESC	10037, 10217
	Ether	10030, 10009
	Etron	10001, 10009, 10163, 10820
	Eurofeel	10217, 10264
	Euroman	10037, 10217, 10264, 10370
	Europa	10037
	Europhon	10037, 10109, 10217
	Evesham Technology	11248
	Evolution	11756
	Expert	10163
	Exquisit	10037
F	Feilang	10009
	Feilu	10009, 10817
	Feiyan	10264
	Feiyue	10009, 10817
	Fenner	10009, 10374
	Fer0	10335
		10053, 10037, 10073, 10109, 10195, 10287, 10335, 10343, 10443, 10548, 10560, 10625, 11037
	Ferguson	
	Fidelity	10171, 10037, 10163, 10217, 10264, 10361, 10371, 10512
	Filsai	10217
	Finlandia	10163, 10208, 10346, 10361, 10548

	Finlux	10037, 10070, 10163, 10217, 10346, 10480, 10556, 10631, 10714, 10715, 10808, 11556
	Firstar	10236, 10009
	Firstline	10009, 10037, 10208, 10217, 10361, 10374, 10556, 10668, 10714, 10808, 11037, 11191, 11363, 11371
	Fisher	10047, 10054, 10154, 10000, 10036, 10208, 10217, 10361, 10370
	Flint	10037, 10218, 10264, 10455, 10610
	Force	11149
	Formenti	10037, 10163
	Fortress	10093
	Fraba	10037, 10370
	Friac	10009, 10037, 10370, 10499, 10610
	Frontech	10009, 10163, 10217, 10264
	Fujimaro	10865, 11498
	Fujitsu	10009, 10217, 10352, 10683, 10809, 10853
	Fujitsu General	10009, 10217, 10683
	Fujitsu Siemens	10808, 10809, 11163, 11298
	Funai	10000, 10180, 10171, 10264, 10668, 11271, 11904
	Furi	10145, 10264, 10817
	Furichi	10860
	Futronic	10264, 10860
	Futuretech	10180
G	Galaxi	10037
	Galaxis	10037, 10370
	Ganxin	10817
	Gateway	11755, 11756
	GBC	10009, 10163, 10218, 10374
		11447, 10047, 11454, 10000, 10051, 10451, 10093, 10180, 10060, 10178, 10030, 10092, 11922, 11917, 11347, 11147, 10625, 10560, 10335, 10035
	GE	
	GEC	10037, 10163, 10217, 10361
	Geloso	10009, 10163, 10374
	Gemini	10047
	General	10109, 10287
	General Technic	10009
	Genesis	10009, 10037
	Genexxa	10009, 10037, 10163, 10218
	Gericom	10808, 10865, 10880, 11217, 11298
	Gevalt	11371
	Giant	10009, 10217
	Gibraltar	10017, 10000, 10030
	Go Video	10060, 10886
	Go Vision	11937
	Goldfunk	10668
		10047, 10054, 10154, 10178, 10030, 10715, 10714, 10606, 10455, 10361, 10217, 10163, 10109, 10073, 10037, 10036, 10009, 10061
	GoldStar	

	Gooding	10487
		10000, 11909, 11900, 11163, 11037, 10880, 10808, 10714, 10668, 10661, 10634, 10625, 10587, 10560, 10556, 10499, 10487, 10480, 10374, 10371, 10343, 10335, 10264, 10218, 10217, 10037, 10036, 10035, 10011, 10009
	Goodmans	
	Gorenje	10370
	GPM	10218
	Gradiente	10053, 10037, 10170
	Graetz	10163, 10361, 10371, 10487, 10714, 11163
	Gran Prix	10648
	Granada	10036, 10037, 10108, 10163, 10208, 10217, 10226, 10343, 10548, 10560
	Grandin	10009, 10037, 10163, 10218, 10374, 10455, 10610, 10668, 10714, 10715, 10865, 10880, 11037, 11191
	Gronic	10217
		10706, 10009, 10036, 10037, 10070, 10163, 10195, 10443, 10487, 10556, 10587, 10672, 10683, 11371
	Grundig	
	Grundy	10180, 10195
	Grunkel	11163
	Grunpy	10180
H	H & B	10808
	Haaz	10706
	Galaxi	11034, 10037, 10508, 10587, 10698, 11017
	Haihong	10009
	Haiyan	10264, 10817
	Halifax	10217, 10264
	Hallmark	10236, 10180, 10178
	Hampton	10217
	Hanimex	10218
	Hankook	10180, 10178, 10030
		10009, 10037, 10217, 10361, 10370, 10394, 10499, 10556, 10634, 10661, 10714, 10808
	Hanseatic	
	Hantarex	10009, 10037, 10865
	Hantor	10037
	Harley Davidson	10000, 10180, 10060, 10178, 10030, 11904
	Harman/Kardon	10054
	Harsper	10865
	Harvard	10180
	Harwa	10773, 11196, 11269
	Harwood	10009, 10037, 10487
	Hauppauge	10037
	Havermy	10093
	HCM	10009, 10037, 10217, 10218, 10264, 10418
	Heathkit	10017
	Helios	10865
	Hello Kitty	10451

	Hema	10009, 10217
	Hewlett Packard	11494, 11502
	Hifivox	10109
	Highline	10037, 10264
	Hikona	10218
	Hikone	10218
	Hinari	10009, 10036, 10037, 10163, 10208, 10218, 10264, 10352, 10443
	Hisawa	10218, 10455, 10610, 10714
		10156, 10748, 10145, 10009, 10208, 10508, 10556, 10780, 10821, 10860, 11022, 11156, 11170, 11208, 11363
	Hisense	
		10047, 10054, 10017, 10000, 11256, 10156, 10051, 10150, 10178, 10030, 11145, 10145, 10092, 10744, 10877, 10634, 11037, 11137, 11149, 11156, 11170, 11225, 11576, 11904, 11960, 10578, 10548, 10508, 10499, 10481, 10480, 10343, 10217, 10163, 10109, 10108, 10037, 10036, 10035, 10009
	Hitachi	
	Hitachi Fujian	10150, 10108, 10860
	Hitec	10698
	Hitsu	10009, 10218, 10455, 10610
	Hoehner	10714, 10865, 11163, 11556
	Home Electronics	10606
	Hongmei	10093, 10009, 10264, 10817
	Hongyan	10264, 10817
	Hornophon	10037
	Hoshai	10218, 10455
	HP	11494, 11502
	Hua Tun	10009
	Huafa	10145, 10009
	Huanghai mei	10009
	Huanghe	10009, 10817
	Huanglong	10009
	Huangshan	10009, 10264, 10817
	Huanyu	10217, 10264, 10374, 10817
	Huaqiang	10264
	Huari	10145, 10264
	Hugoson	11217
	Huodateji	10051
	Hygashi	10217
	Hyper	10009, 10217
	Hypersonic	10361
		10037, 10217, 10264, 10455, 10486, 10556, 10668, 10714, 10715, 11037
	Hypson	
	Hyundai	10849, 10860, 10865, 10876, 11556
I	Iberia	10037
	ICE	10037, 10217, 10218, 10264, 10371
	ICeS	10218
	Iiyama	10877, 11217

	Ima	10236, 10180, 10178
	Imperial	10037, 10074, 10370, 10418
	Imperial Crown	10001, 10009, 10264, 10374, 10661
	Indiana	10037
	Infinity	10054
	InFocus	11164
	Ingelen	10163, 10487, 10610, 10714
	Ingersol	10009
	Inno Hit	10009, 10217, 10218, 11163
	Innova	10037
	Innowert	10865, 11298
	Inotech	10773, 10820
	Insignia	10171, 11517
	Inteq	10017, 10145
	Interbuy	10009, 10037, 10264
	Interfunk	10037, 10109, 10163, 10200, 10327, 10361, 10512
	Internal	10037, 11909
	Intervision	10009, 10037, 10217, 10218, 10264, 10394, 10455, 10486, 10487
	Irradio	10009, 10037, 10218, 10371
	Isukai	10037, 10218, 10455
	ITC	10217
	ITS	10037, 10218, 10264, 10371
	ITT	10163, 10208, 10346, 10361, 10480, 10548, 10610
		10070, 10163, 10195, 10208, 10346, 10361, 10480, 10548, 10606, 10610
	ITT Nokia	
	ITV	10037, 10264, 10374
	IX	10877
J	JBL	10054
	JCB	10000
	JDV	11982
	Jean	10156, 10051, 10236, 10092, 10009, 10036
	JEC	10035
	Jensen	10761, 10815, 10817, 11933
	Jiahua	10051
	JiaLiCai	10009, 10264
	JIL	10030
	Jinfeng	10051, 10208, 10226, 10817
	Jinque	10009, 10264, 10817
	Jinta	10009, 10264
		10054, 10156, 10145, 10009, 10037, 10264, 10556, 10698, 10817, 10821, 11011
	Jinxing	
	JMB	10443, 10499, 10556, 10634
	JNC	10876
	Jocel	10712
	Johnson	10455
	Jubilee	10556
	Juhua	10264, 10817
	Jutan	10030

JVC	10054, 10093, 10463, 10053, 10030, 10070, 10036, 10218, 10371, 10418, 10508, 10606, 10650, 10653, 10683, 10731, 11253, 11923
K Kaige	10009, 10264, 10817
Kaisui	10009, 10037, 10217, 10218, 10455
Kambrook	10217
Kamp	10017, 10180, 10217
Kangli	10001, 10009, 10264, 10374, 10661, 10817
Kangyi	10009, 10264
Kapsch	10163, 10361
Karcher	10264, 10370, 10606, 10610, 10714, 10778, 11556
Kathrein	10556
Kawa	10371
Kawasho	10030
KB Aristocrat	10163
KDS	11498
KEC	10180, 10060
Kendo	10037, 10362, 10370, 10610, 10648, 11037
Kennedy	10163
Kennex	10668, 11037
Kenwood	10180, 10030
Khind	10706
KIC	10217
Kiota	10001, 10371, 10455
Kioto	10706, 10556
Kiton	10037, 10668
KLH	10156, 10180, 10765, 10767, 11962
KLL	10037
Kloss	10030
Kneissel	10037, 10362, 10370, 10374, 10499, 10556, 10610
Kolin	10180, 10150, 10053, 10036, 10108, 11331
Kolster	10037, 10218
Kongque	10009, 10264, 10817
Konichi	10009
Konig	10037
Konka	10180, 10037, 10218, 10371, 10418, 10587, 10641, 10714, 10817, 11084
Kontakt	10487
Korpel	10037
Korting	10370
Kosmos	10037
Koyoda	10009
Kreisen	10876
KTV	10463, 10180, 10030, 10217
Kuaile	10009, 10264
Kulun	10009
Kunlun	10051, 10208, 10226, 10264, 10374, 10661, 10817

L Kyoshu	10418
Kyoto	10163, 10217
L&S Electronic	10714, 10808, 10865
Lark	10154
LaSAT	10486
Lavis	11037
Leader	10009
Lecson	10037
Legend	10009
Lenco	10037, 10374, 10587
Lenoir	10009
Lexsor	11196
Leyco	10037, 10264
LG	10054, 11265, 10060, 10178, 10030, 11758, 11637, 11191, 11178, 10856, 10715, 10714, 10700, 10698, 10556, 10370, 10361, 10217, 10163, 10109, 10108, 10037, 10009, 10001
Liesenk & Tter	10037
Liesenkotter	10037, 10327
Lifetec	10009, 10037, 10218, 10374, 10668, 10683, 10714, 11037, 11137
Lihua	10817
Lloyd's	10236, 10180, 10030, 10001, 10009, 11904
Local India TV	10009, 10208, 10602
Local Malaysia TV	10698
Lodos	11037
Loewe	10037, 10370, 10512, 10633, 10790
Logik	10236, 10180, 10060, 10001, 10009, 10011, 10371, 10698, 10773, 10880, 11037, 11217
Logix	10668
Longjiang	10264, 10817
Luker	11982
Luma	10009, 10163, 10362, 10374, 11037
Lumatron	10037, 10073, 10163, 10217, 10264, 10361, 10556
Lux May	10009, 10037
Luxor	10163, 10208, 10217, 10346, 10361, 10480, 10548, 10631, 11037, 11163
LXI	10047, 10054, 10017, 10154, 10000, 10156, 10051, 10093, 10060, 10053, 10178, 10030, 10171, 10166, 10037, 10036, 10035, 10001, 10208
M M Electronic	10009, 10037, 10109, 10163, 10195, 10217, 10287, 10343, 10346, 10374, 10480, 10512, 10634, 10661, 10714
Madison	10037
MAG	11498
Magnadyne	10054, 10163
Magnafon	10073
Magnasonic	10054, 10000, 10156, 10093, 10030, 10092, 10109

Magnavox	10047, 11454, 10054, 10154, 10000, 10250, 10051, 10180, 10060, 10030, 10171, 10092, 10706, 11944, 11904, 11755, 11254, 10802, 10780, 10011, 10035, 10037, 10036
Magnum	10037, 10648, 10714, 10715
Majestic	10017
Mandor	10264
Manesth	10035, 10037, 10217, 10264
Manhattan	10037, 10668, 10778, 10876, 11037, 11267
Marantz	11454, 10054, 10030, 10037, 10556, 10704, 10855
Mark	10009, 10037, 10217, 10374, 10714, 10715
Master's	10499
Mastro	10053, 10706, 10698, 10780
Masuda	10009, 10037, 10217, 10218, 10264, 10371
Matsui	11037, 10744, 10714, 10556, 10487, 10455, 10443, 10433, 10371, 10352, 10335, 10217, 10208, 10195, 10163, 10037, 10036, 10035, 10011, 10009
Matsushita	10250, 10051, 10650
Maxdorf	10773
Maxent	11755, 11756
Maxim	11556, 11982
MCE	10009
Meck	10698
Mediator	10037, 10556
Medion	10037, 10512, 10556, 10668, 10698, 10714, 10808, 10880, 11037, 11137, 11248, 11900
Megapower	10700
Megas	10610
Megatron	10047, 10178, 10145, 10009
MEI	11037
Meile	10264, 10817
Memorex	10154, 10250, 10463, 10180, 10150, 10060, 10178, 10030, 10009, 10035, 10037, 10195, 10877, 11037, 11911
Memphis	10009
Mercury	10060, 10001, 10009, 10037
Mermaid	10037
Metronic	10625
Metz	10037, 10195, 10367, 10388, 10447, 10587, 10668, 10746, 11163
MGA	10150, 10178, 10030, 10218, 10374
MGN Technology	10178
Micro Genius	10150
Micromaxx	10037, 10668, 10714, 10808, 11037
Microstar	10808
MicroTEK	10820, 10860
Midland	10047, 10017, 10051
Mikomi	11037, 11149

Minato	10037, 10556
Minerva	10070, 10108, 10195, 10487
Minoka	10037
Mirror	11900
Mitsubishi	10154, 10250, 10093, 10236, 10180, 11250, 10150, 10178, 10030, 11917, 11037, 10836, 10817, 10556, 10512, 10195, 10108, 10037, 10036, 10011
Mivar	10217
Monaco	10009
Monivision	10700, 10843
Morgan's	10037
Motorola	10054, 10051, 10093, 10150
MTC	10180, 10060, 10030, 10092, 10011, 10370, 10512
MTlogic	10714
Mudan	10051, 10009, 10208, 10226, 10264, 10817
Multitec	10037, 10486, 10668, 11037, 11556
Multitech	10180, 10009, 10037, 10217, 10264, 10370, 10486
Murphy	10163
Musikland	10218
Mx Onda	11498
Myryad	10556
NAD	10156, 10178, 10166, 10037, 10361, 10866, 11156
Naiko	10037, 10606, 11982
Nakimura	10037, 10374
Nanbao	10009, 10264
Nansheng	10264, 10817
Narita	11982
NAT	10226
National	10051, 10208, 10226, 10508
NEC	10047, 10154, 10156, 10051, 10053, 10178, 10030, 11704, 11270, 11170, 10817, 10704, 10661, 10653, 10508, 10499, 10455, 10374, 10264, 10217, 10170, 10036, 10011, 10009
Neckermann	10037, 10200, 10327, 10370, 10418, 10556
NEI	10037, 10163, 10371
Neovia	10865, 10876, 11371
Netsat	10037
NetTV	11755
Neufunk	10009, 10037, 10218, 10556, 10610, 10714
New Tech	10009, 10037, 10217, 10343, 10556
New World	10218
Newwave	10093, 10178, 10092, 10009
Nikkai	10009, 10035, 10036, 10037, 10163, 10217, 10218, 10264
Nikkei	10714
Nikko	10178, 10030, 10092
Nikkodo	10178, 10030, 10092

Nishi	10030
Noblisko	10070
Nogamatic	10109
Nokia	10163, 10208, 10346, 10361, 10374, 10480, 10548, 10606, 10610, 10631
Norcent	10748, 10824
Nordic	10217
Nordmende	10037, 10109, 10195, 10287, 10343, 10560, 10714
Normerel	10037
Novatronic	10037, 10374
NTC	10092
Nu-Tec	10455, 10698, 10820
Nyon	10000
O Oceanic	10163, 10208, 10361, 10548
Odeon	10264
Okano	10009, 10037, 10264, 10370
Olevia	11144, 11240, 11331, 11610
Omega	10264
Omni	10748, 10698, 10780, 10872
Onida	10053, 11253
Onimax	10714
Onwa	10180, 10218, 10371, 10433, 10602
Opera	10037
Optimus	10154, 10250, 10093, 10180, 10150, 10178, 10030, 10166, 10650
Optoma	10887
Optonica	10093
Orbit	10037
Orcom	11504
Orion	10017, 10236, 10463, 10180, 10178, 11463, 10011, 10037, 10264, 10443, 10556, 10714, 10880, 11196, 11911
Orline	10037, 10218
Ormond	10668, 11037
Osaki	10037, 10217, 10218, 10264, 10374, 10556
Osio	10037
Oso	10218
Osume	10036, 10037, 10218
Otic	11498
Otto Versand	10093, 10036, 10037, 10109, 10195, 10217, 10226, 10343, 10361, 10512, 10556
P Pace	10092
Pacific	10037, 10443, 10556, 10714, 11037, 11137
Palladium	10037, 10163, 10200, 10217, 10327, 10370, 10418, 10556, 10714, 11137
Palsonic	10001, 10037, 10217, 10218, 10264, 10418, 10698, 10773, 10778, 11196, 11269, 11904
Panama	10009, 10037, 10217, 10264
Panashiba	10001

Panasonic	10054, 10000, 10156, 10250, 10051, 10236, 10030, 11947, 11946, 11941, 11480, 11310, 11291, 11271, 10853, 10650, 10548, 10508, 10367, 10361, 10226, 10208, 10163, 10108, 10037, 10035
Panavision	10037
Panda	10051, 10706, 10009, 10208, 10226, 10264, 10508, 10698, 10780, 10817, 10821
Pathe Cinema	10163
Pathe Marconi	10109
Pausa	10009
Paxonic	10060, 10030
PCE	10156, 10060
Penney	10047, 10000, 10156, 10250, 10051, 10060, 10178, 10030, 10035, 10036, 10037, 10070, 10108, 11347
Perdio	10037, 10163
Perfekt	10037
Petters	11523
Philco	10054, 10451, 10463, 10180, 10178, 10030, 10145, 11661, 10037, 10074, 10163, 10370, 10418
Philharmonic	10217
Philips	11454, 10054, 10017, 10000, 10051, 10178, 10030, 10171, 10092, 11961, 11756, 11254, 10690, 10556, 10512, 10374, 10361, 10343, 10200, 10108, 10037, 10009
Phocus	10714
Phoenix	10037, 10163, 10370, 10486
Phonola	10037, 10556
Pilot	10051, 10060, 10178, 10030, 10706, 10011
Pioneer	10166, 10011, 10037, 10109, 10163, 10170, 10287, 10361, 10370, 10486, 10512, 10679, 10760, 10866, 11260
Pionier	10370, 10486, 11556
Plantron	10009, 10037, 10264
Playsonic	10037, 10217, 10714, 10715
Polaroid	10765, 10865, 11276, 11316, 11341, 11498, 11523
Poppy	10009
Portland	10451, 10092, 10374
Powerpoint	10037, 10487, 10698
Prandoni-Prince	10361
Precision	10236, 10180, 10217
Premier	10009, 10264
President	10860
Prima	10761, 10009, 10264, 10783, 10815, 10817, 11269, 11933
Princeton	10700
Prinston	11037
Prinz	10361
Prism	10250, 10051

Profex	10009, 10163, 10361
Profi	10009
Profilo	11556
Profitronic	10037
Proline	10037, 10073, 10625, 10634, 11037
Proscan	11447, 10047, 11347, 11922
Proscoc	10156
Prosonic	10037, 10217, 10370, 10371, 10374, 10668, 10714
Protec	10009, 10037, 10217, 10264
Protech	10009, 10037, 10217, 10264, 10418, 10486, 10668, 11037
Proton	10178, 10030, 10001, 10009
Proview	11498
ProVision	10037, 10556, 10714, 11037
Pulsar	10017, 10092
Pulser	10178, 10092
Pvision	10876, 11191
Pye	10037, 10374, 10556
Pymi	10009
Q	
Qingdao	10051, 10208, 10226, 10264, 10817
Quadral	10051, 10218
Quartz	10150, 10178
Quasar	10250, 10051, 10009, 10035, 10650, 10865
Quelle	10011, 10037, 10070, 10074, 10109, 10195, 10200, 10327, 10361, 10512, 10668, 11037
Questa	10036
Questar	10036
R	
R-Line	10037
Rabbit	10047
Radialva	10163, 10218
Radiola	10037, 10217, 10556
Radiomarelli	10037
RadioShack	10047, 10154, 10180, 10150, 10178, 10030, 10037, 11904
Radiotone	10009, 10037, 10264, 10370, 10418, 10648, 10668, 11037
Rank	10070
Rank Arena	10036, 10602
RBM	10070
RCA	11447, 10047, 11454, 10054, 10000, 10051, 10093, 10178, 10030, 10092, 11958, 11953, 11948, 11922, 11917, 11547, 11347, 11247, 11147, 11047, 10679, 10625, 10560, 10090
Realistic	10047, 10154, 10180, 10150, 10178, 10030
Recor	10037, 10418
Rectiligne	10037
Rediffusion	10036, 10163, 10346, 10361, 10548
Redstar	10037
Reflex	10037, 10668, 11037
Relisys	10865, 10876, 10877, 11207, 11298

Remotec	10250, 10093, 10145, 10171, 10037
Reoc	10714
Revoc	10037
Rex	10163, 10264
RFT	10037, 10264
Rinex	10773
Roadstar	10009, 10037, 10218, 10264, 10418, 10668, 10714, 11037, 11900
Rolson	11371
Rover	10036, 10877
Rowa	10748, 10009, 10037, 10264, 10587, 10698, 10712, 10817
Royal Lux	10335, 10370
Runco	10017, 10060, 10030
Ruyi	10817
S	
Saba	10250, 10109, 10163, 10287, 10335, 10343, 10361, 10498, 10548, 10560, 10625, 10714
Sagem	10455, 10610, 10618
Saige	10009, 10817
Saisho	10009, 10011, 10163, 10217, 10264
Saivod	10037, 10668, 10712, 11037, 11163, 11556, 11982
Sakai	10163
Sakyno	10455
Salora	10163, 10208, 10361, 10480, 10548, 10631
Salsa	10335
Sampo	10047, 10154, 10093, 10178, 10030, 10171, 10092, 10009, 10036, 10650, 10700, 11755, 11756
Samsung	10047, 10054, 10017, 10154, 10156, 10093, 10060, 10812, 10702, 10178, 10030, 10092, 10814, 10766, 10718, 10618, 10587, 10817, 10821, 11060, 11249, 11312, 11903, 11959, 10556, 10371, 10370, 10362, 10264, 10226, 10217, 10208, 10163, 10090, 10037, 10036, 10035, 10009
Sandra	10217
Sanjian	10264
Sanky	10060, 10030
Sansui	10463, 10060, 10030, 10706, 10037, 10371, 10455, 10602, 10714, 10861, 11371, 11537, 11904, 11911
Santon	10009
Sanyo	10047, 10054, 10154, 10000, 10156, 10463, 10180, 10145, 10171, 11755, 11208, 10704, 10508, 10370, 10264, 10217, 10208, 10170, 10163, 10108, 10088, 10037, 10036, 10011, 10009
Sanyong	10037
Sanyuan	10093, 10009, 10817
Saville	10060

SBR	10037, 10556
Sceptre	11217
Schaub Lorenz	10361, 10374, 10486, 10548, 10606, 10714, 11191
Schneider	11982, 11904, 11137, 11037, 10714, 10668, 10648, 10556, 10394, 10371, 10361, 10352, 10343, 10218, 10217, 10163, 10070, 10037
Scotch	10178
Scotland	10163
Scott	10236, 10180, 10178, 10030
Sears	10047, 10054, 10017, 10154, 10000, 10156, 10051, 10093, 10060, 10053, 10178, 10030, 10171, 10166, 10035, 10036, 10037, 10001, 10208, 11904
Seaway	10634
Seelver	11037
SEG	10009, 10036, 10037, 10217, 10218, 10264, 10362, 10487, 10668, 11037, 11163
SEI	10037, 10163
Sei-Sinudyne	10037
Seleco	10163, 10264, 10346, 10362, 10371
Semivox	10180
Semp	10156
Sencora	10009
Sentra	10035
Serino	10093, 10455, 10610
Shancha	10264, 10817
Shanghai	10009, 10208, 10226, 10264, 10817
Shaofeng	10145, 10817
Sharp	10054, 10093, 10180, 10053, 10030, 10009, 10036, 10200, 10650, 10653, 10668, 11193, 11393, 11917
Shen Ying	10092, 10009
Shencai	10145, 10009, 10264
Sheng Chia	10093, 10236, 10009
Shenyang	10009, 10264, 10817
Sherwood	10009
Shintoshi	10037
Shivaki	10178, 10037, 10374, 10443, 10556
Show	10009, 10418
Siarem	10163
Siemens	10145, 10037, 10195, 10200, 10327
Siera	10037, 10556
Siesta	10370
Signature	10047, 10093, 10030
Silva	10037, 10361, 10648
Silva Schneider	10037, 11556
Silvano	10587
Silver	10036, 10361, 10455, 10715
SilverCrest	11037

Simpson	10178, 10030, 10011
Singer	10060, 10092, 10009, 10037, 10335, 10371, 10433, 11537
Sinotec	10773
Sinudyne	10037, 10163, 10361
Skantic	10163
SKY	10037, 10880, 11504
Sky Brazil	10880
Sky-North	10037
Skygiant	10180
Skyworth	10748, 10009, 10037, 10264, 10698, 10805, 10817, 11115
Sliding	10865, 10880
SLX	10668
Smaragd	10487
Soemtron	10865, 11298
Solar Drape	10000
Solavox	10037, 10163, 10361, 10548
Sole	10813
Sonawa	10218
Songba	10009
Soniko	10037
Sonitron	10208, 10217, 10370
Sonneclair	10037
Sonoko	10009, 10037, 10217, 10264
Sonolor	10163, 10208, 10361, 10548
Sontec	10009, 10037, 10370
Sony	10017, 10154, 11100, 10000, 10150, 10053, 10011, 10036, 10037, 10074, 10353, 10650, 11505, 11651, 11751, 11904
Sound & Vision	10218, 10374
Soundesign	10180, 10178
Soundwave	10037, 10418, 10715
Sova	11952
Sowa	10156, 10051, 10060, 10178, 10092, 10036, 10226
Soyea	10773
Spectra	10009
Spectravision	10156, 10178
Spectroniq	11498
Squareview	10171
SR2000	10154, 10171
SSangyong	10009
SSS	10180
Staksonic	10009
Standard	10009, 10037, 10217, 10218, 10374, 11037
Standard Components	10009, 10218
Starlite	10236, 10180, 10009, 10037, 10163, 10264
Stenway	10218
Stern	10163, 10264
Stevison	11982
Strato	10009, 10037, 10264

Strong	11149, 11163
Studio Experience	10843
Stylandia	10217
Sunkai	10218, 10455, 10487, 10610, 10865
Sunstar	10009, 10037, 10264, 10371
Sunwatt	10455
Sunwood	10037
Superla	10217
Superscan	10093, 10864, 11944
Supersonic	10009, 10208, 10455, 10805
SuperTech	10009, 10037, 10218, 10556
Supra	10178, 10009, 10374
Supreme	10000
Susumu	10218, 10287, 10335
Sutron	10009
SV2000	10054
SVA	10748, 10587, 10865, 10870, 10871, 10872
Svasa	10455
Swisstec	10880, 11504
Sydney	10217
Sylvania	10047, 10054, 10154, 10000, 10051, 10178, 10030, 10171, 10092, 10036, 10037, 10876, 11271, 11904, 11944
Symphonic	10000, 10180, 10178, 10171, 11904, 11944
Synco	10000, 10451, 10093, 10060, 10178, 10092, 10036
Syntax	11144, 11240, 11331
Sysline	10037
T+A	10447
Tacico	10178, 10092, 10009
Tai Yi	10009
Taishan	10009, 10374, 10817
Tandberg	10109, 10361, 10367
Tandy	10093, 10163, 10217, 10218
Targa	11371
Tashiko	10092, 10036, 10163, 10170, 10217, 10650
Tatung	10054, 10154, 10000, 10156, 10051, 10060, 10037, 10036, 10011, 10009, 10217, 11156, 11191, 11248, 11254, 11371, 11556, 11756
TCL	10706, 10698, 11027, 11537
TCM	10714, 10808
Teac	10154, 10178, 10171, 10706, 11755, 11149, 11037, 10714, 10712, 10698, 10668, 10512, 10455, 10418, 10264, 10217, 10170, 10037, 10009
Tec	10009, 10037, 10163, 10217, 10335
Tech Line	10037, 10668, 11163
Techica	10218
Technica	11982

Technics	10054, 10250, 10051, 10226, 10556, 10650
TechniSat	10556, 11267
Technisson	10714
Technosonic	10499, 10556
Technovox	10030, 10217
Techview	10847
Techwood	10250, 10051, 10060, 11163
Tecnimagen	10556
Teco	10051, 10093, 10178, 10092, 10009, 10036, 10218, 10264, 10653, 11040
Tedelex	10009, 10208, 10217, 10418, 10606, 10698, 11537
Teiron	10009
Tek	10820
Teknika	10054, 10463, 10180, 10150, 10060, 10178, 10092
Tele System Electronic	10876
Teleavia	10287, 10343
Telecolor	10017
Telecor	10037, 10163, 10217, 10218, 10394
Telefunken	10702, 11504, 10821, 10820, 10819, 10714, 10712, 10698, 10625, 10587, 10560, 10498, 10486, 10346, 10343, 10335, 10287, 10109, 10074, 10073, 10037
Tefusion	10037
Telegazi	10037, 10163, 10218, 10264
Telemeister	10037
Telesonic	10037
Telestar	10009, 10037, 10556
Teletech	10009, 10037, 10668, 11037
Teleton	10036, 10217
Televideon	10163
Television	10037
Tempest	10009, 10264, 10455
Tennessee	10037
Tensai	10009, 10037, 10217, 10218, 10371, 10374, 10715, 11037
Tenson	10009
Tera	10030, 10092
Tevion	10037, 10556, 10648, 10668, 10714, 10808, 11037, 11137, 11248, 11298, 11498, 11556
Textet	10009, 10217, 10218, 10374
Texla	10780
ThemeScene	10887
Thomas	10047, 10178, 10001, 11904
Thomson	11447, 10047, 10037, 10109, 10287, 10335, 10343, 10560, 10625
Thorn	10035, 10036, 10037, 10073, 10074, 10109, 10163, 10264, 10335, 10343, 10361, 10499, 10512
Thorn-Ferguson	10073, 10335, 10343, 10499

Tiane	10093, 10817
Tiny	11269
TMK	10236, 10180, 10178
TML	11756
TNCi	10017
Tobishi	10218
Tobo	10748, 10009, 10264
Tocom	10156
Tokai	10009, 10037, 10163, 10217, 10374, 10668, 11037
Tokaido	11037
Tokyo	10035
Tomashi	10218
Tongguang	10264
Tongtel	10587, 10780
Topline	10668, 11037
Toshiba	10154, 11256, 10156, 10150, 11265, 10060, 11145, 10145, 10166, 11037, 11156, 11163, 11164, 11356, 11508, 11556, 11656, 11704, 11945, 11971, 10845, 10821, 10718, 10650, 10618, 10508, 10264, 10217, 10195, 10109, 10070, 10036, 10035, 10011, 10009
Totevision	10051
Towada	10217
Toyoda	10009, 10264, 10371
Toyomenka	10178
Trakton	10217, 10264
Trans Continens	10037, 10217, 10668, 11037
TRANS-continents	10556, 10865
Transonic	10009, 10037, 10264, 10418, 10455, 10512, 10587, 10698, 10712, 10780
Triad	10218, 10556
Trident	10217
Trio	11498
Tristar	10218, 10264
Triumph	10037, 10346, 10556
Truetone	10250, 10051
Tuntex	10030, 10092, 10009
TVS	10463
TVTEXT 95	10556
Uher	10037, 10370, 10374, 10418, 10480, 10486
Ultra	10092
Ultravox	10037, 10163, 10374
Unic Line	10037, 10455
United	10037, 10587, 10714, 10715, 11037, 11982
Universal	10047, 10037
Universum	11163, 11037, 10668, 10631, 10618, 10512, 10480, 10418, 10370, 10362, 10361, 10346, 10327, 10264, 10217, 10200, 10195, 10170, 10109, 10074, 10070, 10037, 10036, 10011, 10009

Univox	10037, 10163
V	10864, 10885, 11755, 11756
V2max	10865
V7 Videoseven	10880, 11217, 11755
Vector Research	10030
Vestel	10037, 10217, 10668, 11037, 11163
Vexa	10009, 10037
Victor	10250, 10053, 10036, 10650, 10653
Videocon	10508
Videologic	10218
Videologique	10217, 10218
Videomac	10009
VideoSystem	10037
Videotechnic	10217, 10374
Videoton	10163
Vidikron	10054
Vidtech	10178, 10036
Viewpia	10876
Viewsonic	10857, 10864, 10885, 11330, 11578, 11627, 11755
Viking	10060
Viore	11207
Vision	10037, 10217, 10264
Vizio	10864, 10885, 11755, 11756, 11758
Vortec	10037
Voxson	10178, 10037, 10163, 10418
Waltham	10037, 10109, 10217, 10418, 10443, 10668, 11037
Wards	10047, 10054, 10017, 10154, 10000, 10156, 10051, 10093, 10236, 10180, 10060, 10178, 10030, 10166, 11347, 11156, 11147, 10866, 10195, 10001, 10037, 10035
Warumaia	10374, 10661
Watson	10009, 10037, 10163, 10218, 10394, 10668, 10714, 11037
Watt Radio	10163
Waycon	10156
Wega	10036, 10037
Wegavox	10009
Weipai	10009
Welltech	10714
Weltblick	10217
Welton	10178
Weltstar	11037
Westinghouse	10000, 10451, 10885, 10889, 11282, 11577
Wharfedale	10037, 10556, 10860, 11556
White	10451, 10236, 10463, 10037, 10623, 10889, 11909
Windsor	10668, 11037
Windy Sam	10556
Wintel	10714
World	10451, 10236, 10463, 10180

World-of-Vision	10865, 10877, 10880, 11217, 11298
Worldview	10455
X-View	11191
Xenius	10634, 10661
Xiahua	10009, 10264, 10698, 10773, 10817
Xianghai	10009
Xiangyang	10264
Xiangyu	10009
Xihu	10264, 10817
Xingfu	10009
Xinghai	10264
XLogic	10698, 10860
Xoceco	11064
Xoro	11196, 11217
XR-1000	10154, 10180, 10171
Xrypton	10037
Yamaha	10030, 10650, 11576
Yamishi	10037, 10217, 10218, 10455
Yapshie	10250
Yingge	10009
Yokan	10037
Yoko	10009, 10037, 10217, 10218, 10264, 10370
Yonggu	10009
Yorx	10030, 10218
Youlanasi	10817
Yousida	10009
Yuhang	10009
Zanussi	10163, 10217, 10264
Zenith	10047, 10017, 10000, 10093, 10463, 11265, 10812, 10178, 10030, 11145, 10145, 10171, 10092, 10037, 11904, 11909, 11911
ZhuHai	10009, 10374

TV/DVD Combination ※2, ※4

※2

A Advent	11933
Akai	11675
Akura	11982
Alba	11037
Amstrad	11982
Apex Digital	11943
Audiovox	11937, 11951, 11952
Axion	11937, 11958
B Black Diamond	11037
Bush	10698, 11037, 11900
C Centrum	11037
Crown	11037
D D-Vision	11982
Denver	10587

E	Elfunk	11037
F	Ferguson	11037
	Finlux	11556
G	Goodmans	10587, 11037, 11900
H	Hitachi	11960
J	JDV	11982
	Jensen	11933
K	KLH	11962
L	Lenco	10587
	Logik	11037
	Luker	11982
	Luxor	11037
M	Matsui	11037
	Maxim	11982
	Medion	11900
	Mirror	11900
N	Naiko	11982
	Narita	11982
P	Panasonic	11941
	Philips	11454, 10556, 11961
	Powerpoint	10698
	Prima	11933
R	RCA	11948, 11958
	Roadstar	11900
S	Saivod	11982
	Samsung	11903
	Schneider	11982
	SEG	11037
	Sova	11952
	Stevison	11982
	Sylvania	10171
T	Teac	10698
	Technica	11982
	Telefunken	10698
	Thomson	10625
	Transonic	10587
U	United	10587, 11037, 11982
V	Vestel	11037
※4		
A	Akai	30695
	Akura	31367
	Alba	30695, 30884
	Amstrad	31367
	Apex Digital	30830
B	Black Diamond	30713, 30884
	Broksonic	30695
	Bush	30713, 30884
C	Centrum	30713
	Citizen	30695
	Crown	30713
D	D-Vision	31367

	DMTech	31271
E	Elfunk	30713, 30884
	Emerson	30675, 31268
	ESA	31268
F	Ferguson	30695, 30713, 30884
	Funai	31268
G	Goodmans	30713
	Grandin	30713
	Grundig	30539, 30695
H	Hitachi	31247
I	Insignia	31268
J	JDV	31367
	JNC	31271
K	Konka	31192
L	Logik	30713, 30884
	Luker	31367
	Luxor	30713
M	Magnavox	31268
	Matsui	30713, 30884
	Maxim	31367
N	Naiko	31367
	Narita	31367
	Neovia	31271
O	Orion	30695
P	Pacific	30695
	Panasonic	31490
	Philips	30539, 30854, 31260
R	RCA	31022
S	Saivod	31367
	Samsung	30899
	Sansui	30695
	Schneider	31367
	SEG	30713, 30884
	Sliding	31115
	Stevison	31367
	Sylvania	30630, 30675, 31268
T	Technica	31367
	Thomson	30551
	Toshiba	30695
U	United	30713, 30884, 31367
	Universum	30713
V	Vestel	30884
TV/VCR Combination ※2, ※3, ※4		
※2		
A	Aiwa	11904, 11911
	America Action	10180
	Amstrad	10171
	Audiovox	10180
B	Beko	10486
	Black Diamond	11909

	Broksonic	10463, 11911
	Bush	11556
C	Curtis Mathes	10051
D	Daewoo	11909
E	Emerson	10236, 10463, 11909, 11911
F	Ferguson	10073, 10625
	Fidelity	10171
	Funai	11904
G	GE	10047, 10051, 10093, 11917, 11922
	GoldStar	10037
	Goodmans	10374, 11909
	Grundig	10037, 10195, 10556
H	Harley Davidson	11904
	Hinari	10036
	Hitachi	11904
I	Internal	11909
J	JVC	11923
L	LG	10178
	Lloyd's	11904
M	Magnavox	10054, 11904
	Memorex	10250
	Mitsubishi	10093, 10556, 11917
O	Orion	10463, 11911
P	Palsonic	11904
	Panasonic	10250, 10051
	Penney	10051
	Philips	10037, 10556
Q	Quasar	10250, 10051
R	Radiola	10556
	RadioShack	11904
	RCA	10047, 10051, 10093, 11917, 11922
S	Saba	10625
	Samsung	11959
	Sansui	10463, 11904, 11911
	Schneider	10037, 10556, 11904
	Sears	11904
	Sharp	10093, 11917
	Siemens	10037
	Sony	10000, 11505, 11904
	Sylvania	10054
	Symphonic	11904
T	Teac	10178, 10171
	Technics	10556
	Thomas	11904
	Thomson	10625
	Toshiba	11971
	White Westinghouse	11909
Z	Zenith	11904, 11909, 11911
※3		
A	Aiwa	20000, 20352, 20479, 20742, 21137

	Akai	20352
	Alba	20352
	America Action	20278
	Amstrad	20000
	Audiovox	20278
B	Beko	20104
	Bestar	20278
	Blue Sky	20278, 20352, 20742
	BPL	20046
	Broksonic	20002, 20479, 21479
	Bush	20352, 20742
C	Citizen	20278, 21278
	Curtis Mathes	20035, 21035
D	Daewoo	20278, 20637, 21278
	Dantax	20352
E	Emerson	20002, 20278, 20479, 20637, 21278, 21479
F	Ferguson	20000, 20278
	Fidelity	20000
	Firstline	20278
	Funai	20000
G	GE	20060, 20035, 20048, 20240, 20807, 21035, 21060
	GoldStar	20037, 20480, 21237
	Goodmans	20278, 20352, 20637
	Grandin	20278, 20742
	Grundig	20081, 20347, 20352, 20742
H	Hanimex	20352
	Harley Davidson	20000
	Hinari	20352
	Hitachi	20000
	Hypson	20037
	Internal	20278, 20637
J	JBL	20278
	JMB	20352
K	Kambrook	20037
	Kneissel	20278, 20352
L	LG	20037, 20480, 21237
	Lloyd's	20000
	Loewe	20037
M	Magnasonic	20278, 21278
	Magnavox	20081, 20000, 21781
	Magnin	20240
	Matsui	20352, 20742
	Medion	20352
	Memorex	20162, 20037, 21162, 21237, 21262
	MGA	20240
	Mitsubishi	20048, 20081, 20043, 20807
O	Optimus	20162, 21162, 21262
	Orion	20002, 20352, 20479, 20742, 21479
P	Pace	20352
	Pacific	20742

	Palsonic	20000
	Panasonic	20035, 20162, 21035, 21162, 21262
	Penney	20035, 20037, 20240, 21035, 21237
	Philips	20081
	Portland	20637
Q	Quasar	20035, 20162, 21035, 21162
R	Radiola	20081
	RadioShack	20000
	RCA	20060, 20035, 20048, 20240, 20807, 21035, 21060
S	Saba	20320
	Samsung	20240, 20432, 21014
	Sansui	20000, 20479, 21479
	Sanyo	20240
	Saville	20352
	Schneider	20081, 20000
	Sears	20037, 20000, 21237
	SEG	20637
	Sharp	20037, 20048, 20807
	Shivaki	20037
	Siemens	20081
	Sinudyne	20352
	Sony	20032, 20000, 21232
	Supra	20348
	Sylvania	20081, 21781
	Symphonic	20000
T	Tatung	20352
	Teac	20037, 20000, 20637, 20642
	Technics	20081
	Technosonic	20352
	Telefunken	20278
	Thomas	20000
	Thomson	20278
	Toshiba	20352, 20432, 20845, 21145
U	United	20742
W	White Westinghouse	20278, 20637
Z	Zenith	20000, 20479, 20637, 21479
※4		
T	Thomson	30551

TV/VCR/DVD Combination

※2, ※3, ※4

※2		
A	Akai	11903
B	Broksonic	11938
E	Emerson	11944
	ESA	11944
M	Magnavox	11944
P	Panasonic	11946, 11947
R	RCA	11953

S	Sharp	11917
	Sylvania	11944
	Symphonic	11944
T	Toshiba	11945

※3

S	Sharp	20807
----------	-------	-------

※4

A	Akai	30899
E	Emerson	30821
	ESA	30821
M	Magnavox	30821
P	Panasonic	31362, 31462
R	RCA	31132
S	Sharp	30630
	Superscan	30821
	Sylvania	30821
	Symphonic	30821
T	Toshiba	31045

VCR

A	A-Mark	20037, 20240, 20000, 20278, 20046
	ABS	21972
	Admiral	20060, 20048, 20039, 20047, 20104, 20121, 20209, 20479
	Adventura	20037, 20240, 20000
	Aiko	20278
	Aim	20278, 20348, 20642
	Aiwa	20037, 20032, 20000, 20209, 20041, 20348, 20352, 20479, 20742, 21137
	Akai	20037, 20240, 20041, 20106, 20315, 20348, 20352, 20642
	Akura	20041
	Alba	20081, 20000, 20209, 20278, 20315, 20348, 20352
	Alienware	21972
	Allegro	20039, 21137
	Allorgan	20240
	Allstar	20081
	America Action	20278
	American High	20035, 20081
	Amoisonic	20479
	Amstrad	20000, 20278
	Anam	20162, 20037, 20240, 20278, 20226, 20480
	Anam National	20162, 20226, 21162, 21562
	Ansonic	20000
	Aristona	20081
	ASA	20037, 20081
	Asha	20240
	Astra	20035, 20240
	Asuka	20037, 20081, 20000, 20038

	Audiolab	20081
	Audiosonic	20278
	Audiovox	20037, 20278, 20038
	Avis	20000
	AVP	20000, 20352
	Awa	20037, 20043, 20278, 20642

B

	Baird	20000, 20104, 20041, 20278, 20046, 20106
	Basic Line	20104, 20278, 20046
	Beaumarck	20240
	Beko	20104
	Bell & Howell	20035, 20048, 20039, 20000, 20104, 20046, 20479
	Bestar	20278
	Black Diamond	20642
	Black Panther	20278
	Blaupunkt	20162, 20081, 20226
	Blue Sky	20037, 20209, 20278, 20348, 20352, 20480, 20642, 20742, 21137
	BPL	20046
	Brandt	20041, 20320
	Brandt Electronique	20041
	Brinkmann	20209, 20348
	Broksonic	20184, 20121, 20209, 20002, 20348, 20479, 21479
	Bush	20081, 20000, 20209, 20278, 20315, 20348, 20352, 20642, 20742

C

	Calix	20037
	Candle	20037, 20038
	Canon	20035
	Capehart	20002
	Carena	20081, 20209
	Carrefour	20045
	Carrera	20240
	Carver	20035, 20081
	Casio	20000
	Cathay	20278
	CCE	20278
	CGE	20000, 20041
	Changhong	20048, 20081
	Cimline	20209
	Cineral	20278
	CineVision	21137
	Citizen	20035, 20037, 20240, 20000, 20209, 20278, 20479, 21278
	Classic	20037
	Clatronic	20000, 21593
	Colorlyme	20060, 20035, 20045, 20278
	Colt	20000
	Combitech	20352
	Condor	20278
	Craig	20037, 20047, 20240
	Criterion	20000

D

	Crosley	20035, 20081, 20000
	Crown	20037, 20278, 20480
	Curtis Mathes	20060, 20035, 20162, 20240, 20000, 20041, 20278, 20432, 21035
	Cybernex	20240
	CyberPower	21972
	Cyrus	20081
	Daewoo	20037, 20045, 20104, 20209, 20278, 20046, 20352, 20637, 20642, 21137, 21278

	Dansai	20278
	Dantax	20352
	Daytron	20037, 20278
	De Graaf	20048, 20081, 20042, 20104, 20046
	Decca	20081, 20000, 20067, 20209, 20041, 20352
	Degraff	20048, 20081, 20042, 20104
	Deitron	20278
	Dell	21972
	Denon	20081, 20042
	Derwent	20041
	Diamant	20037
	Diamond	20348
	Digitor	20642
	DirecTV	20739
	Domland	20209
	DSE	20642
	Dual	20081, 20000, 20041, 20278, 20348
	Dumont	20081, 20000, 20104
	Durabrand	20039, 20038, 20642
	Dynatech	20240, 20000

E

	Elbe	20278, 20038
	Electrohome	20060, 20037, 20240, 20000, 20043, 20209
	Electroponic	20037
	Elin	20240
	Elta	20278
	Emerald	20184, 20121
	Emerex	20032
	Emerson	20035, 20037, 20184, 20039, 20240, 20045, 20000, 20121, 20043, 20209, 20002, 20278, 20348, 20479, 20637, 21278, 21479, 21593

	ESA	21137
	ESC	20240, 20278
	EuroLine	21593

F

	Ferguson	20000, 20041, 20278, 20320, 20348
	Fidelity	20240, 20000, 20352, 20432
	Finlandia	20037, 20048, 20081, 20000, 20042, 20104, 20043, 20046, 20106, 20226
	Finlux	20081, 20000, 20042, 20104

G

	Firstline	20037, 20045, 20042, 20043, 20209, 20278, 20348, 20480, 21137
	Fisher	20039, 20047, 20000, 20104, 20046
	Flint	20209, 20348
	Fuji	20035, 20033
	Fujitsu	20037, 20045, 20000
	Fujitsu General	20037
	Funai	20037, 20000, 20278, 21593
	Galaxi	20000
	Galaxis	20278
	Garrard	20000
	Gateway	21972

	GE	20060, 20035, 20048, 20240, 20000, 20226, 20320, 20807, 21035, 21060
	GEC	20081
	Gemini	20060
	General	20045
	General Technic	20348
	Genexxa	20037, 20000, 20104, 20278
	Go Video	20240, 20432, 20614, 21137
	GoldStar	20035, 20037, 20039, 20000, 20209, 20278, 20038, 20225, 20226, 20480, 21137, 21237
	Goodmans	20037, 20081, 20240, 20000, 20209, 20278, 20348, 20352, 20637, 20642, 20742

	GPX	20037
	Gradiente	20000
	Graetz	20240, 20104, 20041
	Granada	20035, 20037, 20048, 20081, 20240, 20000, 20042, 20104, 20046, 20226
	Grandin	20037, 20000, 20209, 20278, 20742
	Grundig	20081, 20226, 20320, 20347, 20348, 20352, 20742

H

	Haaz	20348
	Hanimex	20352
	Hanseatic	20037, 20081, 20209, 20038
	Haojie	20240
	Harley Davidson	20000
	Harman/Kardon	20081, 20038
	Headquarter	20046
	Hewlett Packard	21972
	Hi-Q	20035, 20047, 20000
	Hinari	20240, 20209, 20041, 20278, 20352
	Hisawa	20209, 2035
	Hischito	20045
	Hitachi	20035, 20037, 20081, 20240, 20045, 20000, 20042, 20041, 20046, 20089
	Hoehner	20278, 20642
	Hornophon	20081
	Howard Computers	21972
	HP	21972

	Hughes Network Systems	20042, 20739
	Humax	20739
	Hush	21972
	Hypson	20037, 20000, 20209, 20278, 20352, 20480
	Hytek	20047, 20000

I

	iBUYPOWER	21972
	Imperial	20000
	Ingersol	20240, 20209
	Interbuy	20037
	Interfunk	20081, 20104
	Internal	20278, 20637
	International	20037, 20278, 20642
	Intervision	20037, 20000, 20209, 20278, 20348
	Irradio	20037, 20081, 21137
	ITT	20240, 20104, 20041, 20046, 20106
	ITT Nokia	20240, 20104, 20041, 20106
	ITV	20037, 20278

J

	Janeil	20240
	JBL	20278
	Jensen	20067, 20041
	JMB	20209, 20348, 20352, 20742
	Joyce	20000
	JVC	20184, 20081, 20045, 20067, 20041, 21162

K

	Kambrook	20037
	Karcher	20081, 20278, 20642
	KEC	20037, 20278
	Kendo	20037, 20209, 20278, 20106, 20315, 20348, 20642
	Kenwood	20067, 20041, 20038, 20046
	KIC	20000
	Kimari	20047
	Kneissel	20037, 20209, 20278, 20348, 20352
	Kodak	20035, 20037
	Kolin	20043, 20041
	Kolster	20209
	KTV	20000
	Kuba	20047
	Kuba Electronic	20047

L

	Lenco	20278
	LI-Q	20037, 20240, 20045, 20000, 20042, 20209, 20278, 20038, 20225, 20480, 21137, 21237
	Lifetec	20209, 20348
	Linksys	21972
	Lloyd's	20240, 20000, 20038
	Loewe	21062, 20162, 20037, 20081, 21262, 21562
	Logik	20240, 20000, 20209, 20106
	Lumatron	20278, 21137
	Lunatron	21137

Luxor	20048, 20047, 20104, 20043, 20046, 20106, 20315
LXI	20037, 20000, 20042, 20067
M Electronic	20037, 20240, 20000, 20038
Magnadyne	20081
Magnasonic	20037, 20240, 20000, 20278, 21278
Magnavox	20035, 20037, 20048, 20039, 20081, 20240, 20000, 20226, 20618, 20642, 21593, 21781
Magnin	20240
Magnum	20642
Manesth	20081, 20045, 20209
Marantz	20035, 20081, 20209, 20038
Mark	20000, 20278
Marta	20037
Mastec	20642
Master's	20278
Matsui	20037, 20240, 20209, 20278, 20348, 20352, 20742
Matsushita	20035, 20162, 20081, 20226, 21162
Media Center PC	21972
Mediator	20081
Medion	20209, 20348, 20352, 20642
MEI	20035
Memorex	20035, 20162, 20037, 20048, 20039, 20047, 20240, 20000, 20104, 20209, 20278, 20046, 20348, 20479, 21162, 21237, 21262
Metronic	20081
Metz	21062, 20162, 20037, 20081, 20226, 20347, 20836, 21162, 21262, 21562
MGA	20060, 20240, 20043
MGN Technology	20240
Micormay	20348
Micromaxx	20209
Microsoft	21972
Midland	20240
Migros	20000
Mind	21972
Minolta	20042
Mitsubishi	20060, 20048, 20047, 20081, 20000, 20042, 20067, 20043, 20041, 20480, 20642, 20807
Motorola	20035, 20048
MTC	20240, 20000
MTX	20000
Multitec	20037
Multitech	20039, 20000
Murphy	20000
Myryad	20081
NAD	20240, 20104
Naiko	20348, 20642
NAP	20039
National	20226

Nebula Electronics	20033
NEC	20035, 20037, 20048, 20104, 20067, 20041, 20278, 20038, 21137
Neckermann	20081, 20041
Nesco	20000
Neufunk	20209
Newave	20037
Nikkai	20278
Nikko	20037, 20278
Nikkodo	20037, 20278
Nishi	20240
Niveus Media	21972
Noblex	20240
Nokia	20048, 20081, 20240, 20042, 20104, 20041, 20278, 20046, 20106, 20315
Nordmende	20067, 20041, 20320
Northgate	21972
Nu-Tec	20209
Oceanic	20048, 20081, 20000, 20104, 20041, 20046, 20106
Okano	20209, 20278, 20315, 20348
Olympus	20035, 20162, 20104, 20226
Onimax	20642
Onkyo	20222
Optimus	21062, 20035, 20162, 20037, 20048, 20047, 20240, 20000, 20104, 20432, 21162, 21262
Orion	20184, 20240, 20000, 20104, 20121, 20209, 20002, 20278, 20348, 20352, 20479, 20742, 21479
Orson	20000
Osaki	20037, 20000
Otake	20209
Otto Versand	20081
Pace	20352
Pacific	20000, 20348, 20642, 20742
Packard Bell	21972
Palladium	20037, 20209, 20041, 20348
Palsonic	20000, 20642
Panama	20035
Panasonic	21062, 20035, 20162, 20000, 20225, 20226, 20614, 20616, 20836, 21035, 21162, 21262, 21562
Pathe Cinema	20043
Pathe Marconi	20041
Penney	20035, 20162, 20037, 20047, 20081, 20240, 20000, 20042, 20067, 20038, 21035, 21237
Pentax	20042
Perdio	20000, 20209
Philco	20035, 20081, 20000, 20209, 20038, 20226, 20479

O

P

Philips	20035, 20162, 20048, 20081, 20045, 20000, 20209, 20226, 20616, 20618, 20739, 21081, 21181
Phoenix	20278
Phonola	20081
Pilot	20037
Pioneer	20162, 20081, 20042, 20067
Polk Audio	20081
Portland	20278, 20637
Presidian	21593
Prinz	20000
Profitronic	20081, 20240
Proline	20000, 20278, 20320, 20642
Proscan	20060, 21060
Proscoc	20278
Prosonic	20209, 20278
Protec	20000
Protech	20081
ProVision	20278
Pulsar	20039, 20240, 20278
Pulser	20240
Pye	20081, 20000
Qisheng	20060
Quarter	20046
Quartz	20035, 20047, 20046
Quasar	20035, 20162, 20002, 20278, 20226, 21035, 21162
Quelle	20081
Radialva	20037, 20048, 20081
Radiola	20081
Radionette	20037, 21137
RadioShack	20035, 20162, 20037, 20048, 20047, 20240, 20000, 20104, 20046, 21162
Radix	20037
Randex	20037
Rank	20041
Rank Arena	20041
RCA	20060, 20035, 20048, 20240, 20045, 20000, 20042, 20106, 20226, 20320, 20807, 20880, 21035, 21060
Realistic	20035, 20162, 20037, 20048, 20047, 20240, 20000, 20104, 20121, 20278, 20046, 21162
Reoc	20348
ReplayTV	20614, 20616
Rex	20041
Ricavision	21972
Rio	21137
Roadstar	20037, 20081, 20240, 20278, 20038, 20742
Runco	20039
Saba	20041, 20278, 20320
Saisho	20209, 20348
Salora	20104, 20043, 20046, 20106

S

Sampo	20037, 20048
Samsung	20060, 20240, 20045, 20000, 20038, 20432, 20739, 21014
Samtron	20240
Sanky	20048, 20039
Sansei	20048
Sansui	20240, 20000, 20067, 20209, 20041, 20002, 20106, 20348, 20479, 21479
Sanyo	20048, 20047, 20240, 20000, 20104, 20067, 20209, 20046, 20348, 20479, 21137
Saville	20240, 20278, 20352
SBR	20081
ScanSonic	20240
Schaub Lorenz	20000, 20104, 20041, 20106, 20315, 20348
Schneider	20037, 20081, 20240, 20000, 20042, 20278, 20348, 20352, 20642, 21137
Scott	20184, 20045, 20121, 20043
Sears	20060, 20035, 20162, 20037, 20048, 20039, 20047, 20033, 20045, 20000, 20042, 20104, 20067, 20043, 20209, 20041, 21237, 20046
Seaway	20278
SEG	20081, 20240, 20278, 20637, 20642
SEI	20081
Sei-Sinudyne	20081
Seleco	20037, 20041
Semp	20045
Sentra	20278
Sharp	20037, 20048, 20047, 20032, 20000, 20209, 20807
Shinco	20000
Shintom	20039, 20240, 20000, 20104
Shivaki	20037
Shogun	20240
Siemens	20037, 20081, 20104, 20046, 20320, 20347
Siera	20081
Signature	20060, 20035, 20037, 20048, 20000, 20046, 20479
Silva	20037
Silver	20278
SilverCrest	20642
Singer	20037, 20240, 20045, 20348
Sinudyne	20081, 20209, 20352
Smaragd	20348
Sonic Blue	20614, 20616, 21137
Sonographe	20046
Sonorol	20048, 20046
Sontec	20037, 20278
Sonwa	20642
Sony	20035, 20048, 20047, 20032, 20033, 20000, 20067, 20046, 20106, 20226, 20636, 21232, 21972

T

Soundmaster	20000
Soundwave	20037, 20209, 20348
Stack 9	21972
Standard	20278
Stern	20278
STS	20042
Sunkai	20209, 20278, 20348
Sunstar	20000
Suntronic	20000
Supra	20037, 20278, 20348
Susumu	20037
SV2000	20000
SVA	20000
Sylvania	20035, 20081, 20000, 20043, 21593, 21781
Symphonic	20240, 20000, 20002, 21593
Systemax	21972
T+A	20162
Tagar Systems	21972
Taisho	20209
Tandberg	20278
Tandy	20000, 20104
Tashiko	20037, 20048, 20081, 20240, 20000
Tatung	20048, 20081, 20045, 20000, 20067, 20043, 20209, 20041, 20348, 20352
Tchibo	20348
TCM	20348
Teac	20037, 20000, 20067, 20041, 20278, 20637, 20642, 21593
Technics	20035, 20162, 20037, 20081, 20000, 20226, 21162
TechniSat	20348
Technosonic	20352
Teco	20035, 20037, 20048, 20041, 20038
Tedex	20037, 20209, 20348, 20642
Teknika	20035, 20037, 20000
Teleavia	20041
Telecorder	20240
Telefunken	20209, 20041, 20278, 20320, 20642
Telerent	20226
Telestari	20037
Teletech	20000, 20278
Tensai	20037, 20000, 20278
Tevion	20209, 20348, 20479, 20642
Textet	20278
Thomas	20000, 20002
Thomson	20060, 20067, 20041, 20278, 20320
Thorn	20037, 20104, 20041, 20320
Tisonic	20278
Tivo	20618, 20636, 20739, 21996
TMK	20240, 20000

TNIX	20037
Tocom	20240
Tokai	20037, 20104, 20041
Topline	20348
Toshiba	20081, 20240, 20045, 20000, 20042, 20067, 20043, 20209, 20041, 20352, 20432, 20742, 20845, 21008, 21145, 21972, 21996
Tosonic	20278
Totevision	20037, 20240
Touch	21972
Toyoda	20278
Tradex	20081
Triad	20278
Trix	20037
U Uher	20240
Ultra	20045, 20278
Ultravox	20278
Unitech	20240
United	20348, 20742, 21593
Universum	20037, 20081, 20240, 20000, 20104, 20209, 20106, 20348, 21137
V Vector	20045
Vector Research	20184, 20038
Victor	20067, 20041
Video Concepts	20045
Video Technic	20000
Videomagic	20037
Videosonic	20240, 20000
Viewsonic	21972
Villain	20000
Voodoo	21972
Wards	20060, 20035, 20037, 20048, 20039, 20047, 20081, 20033, 20240, 20045, 20000, 20042, 20043, 20041, 20038, 20046, 20479
Watson	20081, 20352, 20642
Weltblick	20037
Wharfedale	20642
White Westinghouse	20000, 20209, 20278, 20479, 20637
World	20209, 20002, 20348, 20479
X XR-1000	20035, 20240, 20000
Y Yamaha	20041, 20038
Yamishi	20278
Yoko	20037, 20240
Zenith	20037, 20039, 20033, 20000, 20209, 20041, 20278, 20479, 20637, 21137, 21479
ZT Group	21972
ZX	20209, 20348, 20352

PVR ※3	
A ABS	21972
Alienware	21972
C CyberPower	21972
D Dell	21972
DirectTV	20739
G Gateway	21972
Go Video	20614
H Hewlett Packard	21972
Howard Computers	21972
HP	21972
Hughes Network Systems	20739
Humax	20739
Hush	21972
I iBUYPOWER	21972
L Linksys	21972
M Media Center PC	21972
Microsoft	21972
Mind	21972
N Niveus Media	21972
Northgate	21972
P Panasonic	20614, 20616
Philips	20618, 20739
R RCA	20880
ReplayTV	20614, 20616
S Samsung	20739
Sonic Blue	20614, 20616
Sony	20636, 21972
Stack 9	21972
Systemax	21972
T Tagar Systems	21972
Tivo	20618, 20636, 20739
Toshiba	21008, 21972, 21996
Touch	21972
V Viewsonic	21972
Voodoo	21972
Z ZT Group	21972

DVD Player	
1 3D LAB	30503, 30539
4Kus	31158
A A-Trend	30714
Acoustic Solutions	30713, 30730, 31228
AEG	30770, 30788, 30790, 31923
AFK	31051, 31152, 31923
Aim	30672, 30699, 30833
Airis	30672, 31005, 31224, 31250, 31321, 31345
Aiwa	30533, 30641

Akai	30690, 30695, 30705, 30770, 30788, 30790, 30884, 30898, 30899, 31115, 31205, 31233, 31695
Akashi	30838
AKI	31005
Akira	30699, 31321
Akura	30898, 31051, 31140, 31233, 31367
Alba	30672, 30539, 30717, 30695, 30699, 30713, 30730, 30783, 30884, 31140, 31530, 31695
Alco	30790
Alize	31151
All-Tel	31451
Allegro	30869
Altacom	31224
Amitech	30784, 30770, 30850
Amoi	30852
Amphion Media Works	30872
Amstrad	30713, 30770, 31151, 31367
AMW	30872
Anam	31913
Ansonic	30759, 30774, 30831
Apex Digital	30533, 30672, 30717, 30755, 30794, 30796, 30797, 30830, 31004, 31020, 31056, 31061
Aristona	30539, 30646
Arrgo	31023
ASCOMTEC	31923
Asono	31224
Aspire Digital	31168
Atacom	31224
Audiosonic	30690, 31923
Audiovox	30717, 30790
Audioworld	30790
Autovox	30713
Auvio	30843
Awa	30730, 30872
Axion	30730
B Base	31451
Basic Line	30713
Baze	30898
BBK	30862, 31224
Beep	31163
Bellagio	31004
Belson	31086, 31923
Binatone	31923
Black Diamond	30713, 30833, 30884
Blaupunkt	30717
Blu:sens	31233, 31321
Blue Nova International	31321
Blue Parade	30571

Blue Sky	30672, 30651, 30695, 30699, 30713, 30790, 30843, 31423
Boghe	31004
Boman	30783, 30898, 31005
Bose	32023
Brainwave	30770, 31115
Brandt	30503, 30651, 30551
Broksonic	30695
Bush	30672, 30717, 30690, 30699, 30713, 30723, 30730, 30831, 30833, 30884, 31051, 31140, 31483, 31695, 31832
Byd:sign	30872
C C-Tech	30798, 31152
California Audio Labs	30490
Cambridge Audio	30751, 31109
Cambridge Soundworks	30690
Campomatic Digital	31051
Cat	30699, 30789, 31421, 31923
CCE	30730
Celestial	31020
cello	31730
Centrex	30672, 31004
Centrum	30713, 30789, 31005, 31227, 31923
CGV	30751, 31115
Changhong	30627, 31061
Cinea	30831, 30841
Cinetec	30713, 30872
cineULTRA	30699
CineVision	30833, 30869, 31483
Citizen	30695
Clairtone	30571
Classic	30730, 31730
Clatronic	30672, 30675, 30788, 31233
Clayton	30713
Coby	30730, 30852, 31086, 31321, 31923
Codex	31233
Commax	31321
Conia	30672, 30852, 31321
Contel	30788
Continental Edison	30831, 30872
Craig	30831
Creative	30503, 30539
Crown	30690, 30713, 30770, 31115
Crypto	31228
Curtis Mathes	31087
Cybercom	30831
CyberHome	30714, 30816, 30874, 31023, 31024, 31117, 31129, 31502
Cytron	30651, 30705, 30774, 31347
D D-Vision	31115, 31367
Daenyx	30872

Daewoo	30490, 30784, 30705, 30714, 30770, 30833, 30869, 30872, 31172, 31483, 31906
Dalton	31036
Dansai	30770, 30783, 31115, 31695
Dantax	30539, 30713, 30723, 30790
Daytek	30872, 31005
Dayton	30872
DCE	30831
Decca	30770, 31115
Denon	30490, 30634, 31634, [32134]*
Denver	30672, 30699, 30788, 30898, 31056, 31104, 31321, 31923
Denzel	30665
Desay	30843, 31212
Dgtec	30672
Diamond	30651, 30751, 30768, 30790
Digihome	30713
DigiLogic	30713
digiRED	30717
Digitech	31832
Digitor	30651, 30690, 30833, 31005, 31423
Digitrex	30672, 31004, 31056
DiK	30831
Dinamic	30788
Disney	30675, 30831, 31270
DiViDo	30705
DK Digital	30831
DMTech	30783, 31271
Dragon	30831
DreamX	31151
DSE	30833, 31152, 31730
Dual	30651, 30665, 30675, 30713, 30730, 30783, 30790, 30831, 31023
Durabrand	30713, 30831, 31023, 31502
DVD2000	30521
DVX	30768
E E:max	31233, 31321
EagleTec	30714
eBench	31152
ECC	30730
Eclipse	30723, 30751
Elfunk	30713, 30850, 30884
Elin	30770
Elite	31152
Ellion	30850, 31421
Elta	30672, 30690, 30770, 30788, 30850, 31051, 31115, 31151, 31233
Eltax	31233, 31321
Emerson	30591, 30675, 30705, 30821, 31268
Enterprise	30591

Entivo	30503, 30539
Enzer	30784, 30770, 31228
ESA	30821, 31268
EuroLine	30675, 30788, 31115, 31233
F Fenner	30651
Ferguson	30651, 30695, 30713, 30884, 30898, 31695, 31730
Finlux	30672, 30591, 30741, 30751, 30770, 30783
Firstline	30651, 30713, 30843, 30869, 31530
Fisher	30670
Funai	30675, 30695, 31268
Fusion	30862
G Gateway	31158
GE	30522, 30815, 30717
General Electric	30717
Germatic	31051
Global Link	31224
Global Solutions	30768
Global Sphere	31152
Go Video	30573, 30744, 30717, 30715, 30741, 30783, 30833, 30869, 31044, 31075, 31099, 31158, 31483, 31730
GoldStar	30591, 30741, 30869
Goodmans	30651, 30690, 30713, 30723, 30730, 30783, 30790, 30833, 31004, 31140, 31423, 31530, 31730, 31923
GP Audio	31140
GPX	30699, 30741
Gradiente	30490, 30651
Graetz	30665
Gran Prix	30831, 30898
Grandin	30713, 31233
Greenhill	30717
Grundig	30539, 30651, 30551, 30670, 30686, 30695, 30705, 30713, 30775, 30790, 31004, 31036, 31695, 31730, 31832, 31920
Grunkel	30770, 30790, 30831
H H & B	30713, 30841, 30850, 31233, 31421
Haaz	30751, 31152
Haier	30843
Hanseatic	30741, 30783, 30790
Harman/Kardon	30582, 30702
HCM	30788
HDT	30705
HE	30730, 31163, 31923
Henss	30713
HiMAX	30843
Hitachi	30573, 30664, 30665, 30713, 31247, 31920
Hiteker	30672, 31923
Hoehner	30651, 30713, 30831, 31004, 31224

Home Electronics	30730, 30770
Home Tech Industries	31224
Hoyo	30665
Humax	30646
Hyundai	30783, 30850, 31061, 31228
I iLo	31348
Ingelen	30788
Ingersol	31023
Initial	30839, 30717
Inno Hit	30713
Insignia	31268
Integra	30571, 30627, 31634
Irradio	30869, 31115, 31224, 31233
IRT	30783
ISP	30695
J Jamo	31036
Jaton	30665
JBL	30702
JDB	30730
JDV	31367
Jeken	30699
Jepssen	31250
JMB	30695
JNC	30672, 31271
JSI	31423
JVC	30503, 30539, 30558, 30623, 30867, 31164, 31597, 31860
jWin	31051
K Kansas Technologies	31233, 31530
Karcher	30783
Kawasaki	30790
Kendo	30672, 30699, 30713, 30831
Kennex	30713, 30770, 30898
Kenwood	30490, 30534
Kiiri	30770
Kiss	30665, 30841, 31523
KLH	30815, 30717, 30790, 31020
Kloss	30533
Koda	31230
Konka	31192
Koss	30651, 31061, 31423
Kreisen	31421
KXD	31321, 31923
L Lasonic	30627, 30798, 30789
Lawson	30768
Lecson	31533
Leiker	30872
Lenco	30651, 30699, 30713, 30770, 30774
Lenoir	31228
Lenoxx	30690, 30838
Lexia	30699, 30768

LG	30591, 30741, 30790, 30869, 31906
Lifetec	30651, 30831, 31347
Limit	30768, 31104
LiteOn	31058, 31158
Lodos	30713
Loewe	30539, 30511, 30741, 30885
Logik	30713, 30884
Logix	30705, 30783
Luker	31367
Lumatron	30695, 30705, 30713, 30741, 30833, 31115, 31321, 31832
Lunatron	30741
Luxman	30573
Luxor	30713, 31004, 31695, 31730
M Magnasonic	30651, 30675
Magnat	31923
Magnavox	30503, 30539, 30646, 30675, 30713, 30821, 30885, 31140, 31268
Magnex	30723
Majestic	31345
Manhattan	30705, 30713
Marantz	30503, 30539, 30675
Mark	30713
Marquant	30770
Matsui	30672, 30651, 30695, 30713, 30884, 31004, 31695, 31730
Maxdorf	30788
Maxent	31347
Maxim	30713, 30872, 31367
Maya	31345
MBO	30690, 30730, 31730
McIntosh	31533
MDS	30713
Mecotek	30770
Medion	30651, 30630, 30774, 30783, 30831, 31006, 31270, 31345, 31347, 31423
MEI	30790
Memorex	30690, 30695, 30831, 31270
Metronic	30690
Metz	30525, 30571, 30713
MiCO	30723, 30751, 31223
Micromaxx	31695
Micromedia	30503, 30539
Micromega	30539, 31005
Microsoft	30522, 31708
Microstar	30831
Minato	30752
Minax	30713
Minerva	30705
Minoka	30770, 31115
Mintek	30839, 30717
Mirror	30752

Mitsubishi	31521, 30521, 30713, 31403
Mizuda	30770, 31451
Monyka	30665
MPX	30843
Mustek	30730, 31730
Mx Onda	30651, 30751, 31223
Mystral	30831
N NAD	30741
Naiko	30770, 31004, 31367
Narita	31367
NEC	30741, 30869, 31404
Neovia	31271
Nesa	30717
Neufunk	30665
Nevir	30770, 30831, 31197
NexxTech	31402
Nikkai	31923
Nintaus	31051, 31202
Niro	32024
Norcent	30872, 31923
Nordmende	30774, 30831
Noriko	30752
Nova	31923
Nowa	30843
Nu-Tec	31228
O Okano	30752
Olidata	30672
Omni	30690, 30833, 30838, 30862, 31104, 31832
Onix	30838
Onkyo	30503, 30627
Oopla	31158
Oppo	31224
Optim	30843
Optimus	30525, 30571
Orbit	30872
Orion	30695, 31233, 31695
Oritron	30651
Ormond	30713
P P&B	31451
Pacific	30695, 30713, 30759, 30768, 30790, 30831
Packard Bell	30831
Palladium	30695, 30713, 31906, 31920
Palsonic	30672, 30852, 31056, 31321
Panasonic	30503, 30490, 30571, 30703, 31362, 31462, 31490, 31579, 31762, 31834, 31905, 31908
Panda	30717, 30789, 31203
peekTon	30898, 31224
Philco	30690, 30862
Philips	30503, 30539, 30646, 30675, 30854, 30885, 31158, 31260, 31267, 31340, 31354

Philo	31345
Phonotrend	30699
PianoDisc	31024
Pioneer	30490, 30525, 30571, 30631, 31965
Plu2	30850
Pointer	30784
Polaroid	31020, 31061, 31086
Polk Audio	30539
Portland	30770
Powerpoint	30872, 31005
Presidian	30675
Prima	31228
Prinz	30831
Prism	30705, 30831
Pro2	31345
ProCaster	31004
Proceed	30672
Proline	30672, 30651, 30686, 30833, 31004, 31483
Proscan	30522
Proson	30713
Prosonic	30699, 30752
ProVision	30699, 30730, 31163, 31321, 31923
Pye	30539, 30646
Q QONIX	31051
Qwestar	30651
R Radionette	30741, 30869, 31906, 32024
RadioShack	30571
Raite	30665
RCA	30522, 30571, 30717, 30790, 30822, 31022, 31132, 31769, 31913, 31965
Realistic	30571
REC	30490
Redstar	30759, 30763, 30770, 30788, 30898, 31345, 31923
Relisys	31347
Reoc	30752, 30768
Revoy	30699, 30841
Rex	30838
Richmond	31233
Rio	30869
Roadstar	30672, 30690, 30699, 30713, 30730, 30833, 30898, 31051, 31227
Rocksonic	30789
Ronin	30872
Rotel	30558, 30623
Rowa	30717, 30759, 30872, 31004
Rownsonic	30789
S Saba	30651, 3055
Sabaki	30798
Saivod	30759, 30831, 31367

Salora	30741
Sampo	30752, 31321, 31347
Samsung	30490, 30573, 30744, 30199, 30820, 30899, 31044, 31075, 31635, 31932
Sansui	30784, 30695, 30751, 30763, 30768, 31051, 31228, 31230, 31695, 31832
Sanyo	30670, 30675, 30695, 30713, 30873, 31228
Scan	30705, 30850
ScanMagic	30730, 31730
ScanSonic	31695
Schaub Lorenz	30770, 30788, 31115, 31151
Schneider	30539, 30646, 30651, 30705, 30713, 30774, 30783, 30788, 30790, 30831, 30869, 31367
Schwaiger	30752
Scientific Labs	30768
Scott	30672, 30651, 31005, 31036, 31233, 31423
Seeltech	31224, 31451
SEG	30798, 30665, 30713, 30763, 30872, 30884, 31483, 31530
Sensory Science	31158
Shanghai	30672
Sharp	30630, 30675, 30713, 30752, 31256, 32015, 32024
Sharper Image	31117
Sherwood	30717, 30741, 30770
Shinco	30717
Shinsonic	30533, 30839
Siemssen	31382
Sigmatek	31005, 31224
Siltex	31224
Silva	30788, 30898
Silva Schneider	30831, 30898
SilverCrest	31152
Simaudio	30885
Singer	30690, 30751, 30768
Sistemas	30672
Skantic	30539, 30713
Skymaster	30730, 30768
Skyworth	30898
Sliding	31115
Slim Art	30784
SM Electronic	30690, 30730, 30768, 31152
Smart	30705, 30713
Sonai	30755
Sonashi	30831
Sonic Blue	30573, 30715, 30783, 30869, 31099
Sony	30533, 31533, 30864, 30573, 30630, 30772, 31033, 31070, 31431, 31433, 31536, 31633, 31769, 31981, 32043
Sound Color	31233
Soundmaster	30768

Soundmax	30768
Soundwave	30783
Spectra	30872
Standard	30651, 30768, 30788, 30831, 30898
Star Clusters	31152, 31227
Starlogic	31005
Starmedia	31005, 31224
Stevison	31367
Strong	30713
Sunkai	30770, 30850
Sunstech	30831
Sunwood	30788, 30898
Superscan	30821
Supervision	30768, 31152
SVA	30672, 30717, 30752, 31105
Sylvania	30630, 30675, 30821, 31268
Symphonic	30675, 30821, 31268
Synn	30768
Tandberg	30713, 31695
Tangent	31321
Targa	31227
Tatung	30770, 31695
Tchibo	30741
TCL	31180
TCM	30741, 30790
Teac	30571, 30717, 30675, 30741, 30759, 30768, 30790, 30833, 31006, 31197, 31227
Tec	30898
Technica	31367, 31695
Technics	30490, 30703, 31905
Technika	30770, 30831, 31115, 31695
Technisson	31115
Technosonic	30730, 31051, 31115
Techwood	30713, 31530
Tedalex	30690, 30768, 31004, 31228
Telefunken	30789, 30790, 30833, 31483, 31832, 31923
Teletech	30713, 30768
Tensai	30651, 30690, 30770
Tevion	30651, 30798, 30768, 30833, 30898, 31036, 31227, 31347, 31382, 31483, 31730, 31923
Theta Digital	30571
Thomson	30522, 30511, 30551
Tivo	31503
Tokai	30784, 30665, 30788, 30790, 30898
Tom-Tec	30789
Top Suxess	31224
Toshiba	30503, 30573, 30539, 30695, 31045, 31154, 31503, 31510, 31769
TRANS-continents	30831, 30872, 31321, 31327
Transonic	30730

Tredex	30843
TruVision	31451
Tsinghua Tongfang	31205
TSM	31224
Umax	30690, 31151
Unimax	30770
United	30675, 30695, 30699, 30713, 30730, 30788, 30884, 31115, 31152, 31228, 31367, 31832
Universum	30591, 30713, 30741, 30790, 30869, 31227, 31530, 31913
Uptek	30763
upXus	31345
Urban Concepts	30503, 30539
US Logic	30839
Venturer	30790
Vestel	30713, 30884, 31530
Victor	31597
Vieta	30705
Viewmaster	30862, 31224
Voxson	30690, 30730, 30774, 30831
Vtrek	31228
Waitec	31151, 31224, 31233
Walkvision	30717
Waltham	31530
Welkin	30831
Wellington	30713
Weltstar	30713
Wesder	30699
Wharfedale	30686, 30751, 30752, 30790, 31832
Wilson	30831, 31233
Windsor	30713
Windy Sam	30573
WIZE	31115
Woxter	31005, 31151, 31224
Xbox	30522, 31708
Xenius	30790
XLogic	30768, 31152, 31228
XMS	30770, 30788
Xoro	31183, 31250
Yakumo	31004, 31056
Yamada	30872, 31004, 31056, 31151, 31158
Yamaha	30490, 30539, 30646, 30545, 31354
Yamakawa	30665, 30872, 31104
Yukai	30730, 31730
Zenith	30503, 30591, 30741, 30869, 31906
Zeus	30784

DVD Recorder

1 4Kus	31158
--------	-------

Airis	31321
Akira	31321
Alba	31530
Apex Digital	31056
Aristona	30646
Aspire Digital	31168
Belson	31086
Cat	31421
cello	31730
Centrum	31227
Classic	31730
Coby	31086
Commax	31321
Conia	31321
CyberHome	31129, 31502
Cytron	31347
Denon	30490
Denver	31056
Digitrex	31056
DSE	31730
Durabrand	31502
E:max	31321
Ellion	31421
Eltax	31321
Emerson	30675
Ferguson	31730
Firstline	31530
Funai	30675
Gateway	31158
Go Video	30741, 31158, 31730
Goodmans	31530, 31730
GPX	30741
Grundig	31730
H & B	31421
Humax	30646
iLo	31348
JVC	31164, 31597
Kansas Technologies	31530
Kreisen	31421
KXD	31321
LG	30741
Lifetec	31347
LiteOn	31158
Loewe	30741
Lumatron	31321
Luxor	31730
Magnavox	30646, 30675
Matsui	31730
Maxent	31347
MBO	31730
Medion	31347
MiCO	30751

Mitsubishi	31403
Mustek	31730
NEC	31404
Oopla	31158
Palsonic	31056, 31321
Panasonic	30490, 31579
Philips	30646, 31158
Pioneer	30631
Polaroid	31086
ProVision	31321
Pye	30646
RCA	30522
Relisys	31347
Roadstar	31227
Sampo	31347
Samsung	30490, 31635
ScanMagic	31730
Schneider	30646
SEG	31530
Sensory Science	31158
Sharp	30630, 30675
Sony	31033, 31070, 31431, 31433, 31536
Star Clusters	31227
Sylvania	30675
Tangent	31321
Targa	31227
Teac	31227
Techwood	31530
Tevion	31227, 31347, 31730
Thomson	30551
Toshiba	31510
Universum	31227, 31530
Vestel	31530
Victor	31597
Waltham	31530
Yakumo	31056
Yamada	31056, 31158
Yamaha	30646
Yukai	31730
Zenith	30741

DVD preset codes / Codes pré-réglés DVD			
DENON Model No. / Modèle numéro	32134 (default / défaut)		30490
	DVD-555	DVD-2910	DVD-800
DVD-755	DVD-2930CI	DVD-1600	
DVD-900	DVD-3800	DVD-2000	
DVD-910	DVD-3910	DVD-2500	
DVD-955	DVD-3930CI	DVD-3000	
DVD-1000	DVD-5900	DVD-3300	
DVD-1200	DVD-5910		
DVD-1500	DVD-9000		
DVD-1710	DVM-715		
DVD-1910	DVM-1800		
DVD-1930CI	DVM-1805		
DVD-2200	DVM-1815		
DVD-2800	DVM-2815		
DVD-2800II	DVM-4800		
DVD-2900			

[]* : Preset codes set upon shipment from the factory.

: Les codes pré-réglés diffèrent en fonction des livraisons de l'usine.

※1 : These preset codes can be recorded in the SAT/CBL mode.

: Ces codes de présélection peuvent être enregistrés en mode SAT/CBL.

※2 : These preset codes can be recorded in the TV mode.

: Ces codes de présélection peuvent être enregistrés en mode TV.

※3 : These preset codes can be recorded in the VCR mode.

: Ces codes de présélection peuvent être enregistrés en mode VCR.

※4 : These preset codes can be recorded in the DVD mode.

: Ces codes de présélection peuvent être enregistrés en mode DVD.





DENON

www.denon.com

Denon Brand Company, D&M Holdings Inc.
Printed in Japan 00D 511 4649 103