

DENSO

BHT-400B-CE

BHT-400BW-CE

Operator's Guide

This guide has been prepared expressly for the hands-on user. Always keep it nearby for speedy reference.

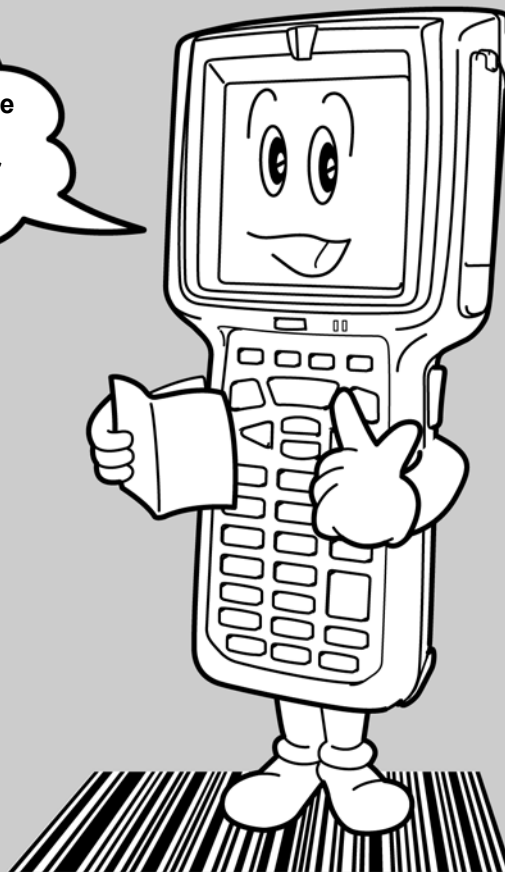

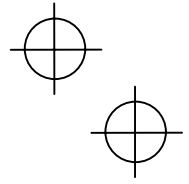
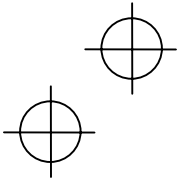

If you leave the BHT with the battery cartridge discharged or with no battery cartridge loaded or if you replace the battery cartridge in a wrong way, the BHT may lose the data stored in it.

Before cold booting (refer to "Warm and Cold Booting"), it is recommended that important data be saved into the FLASH folder or uploaded to the host computer. Cold booting will erase all data stored in the RAM.

All products and company names mentioned in this manual are trademarks or registered trademarks of their respective holders.

The latest precision manufacturing technology yields LCD panels whose pixels are 99.99% defect free. The downside, note, is that up to 0.01% of the pixels can remain permanently dark or lit on today's state-of-the-art panels.

A thin Newton's rings (rainbow-like patterns) may appear on the touch panel. This does not necessarily indicate a problem with the touch panel.

- DENSO WAVE INCORPORATED does not assume any product liability arising out of, or in connection with, the application or use of any product, circuit, or application described herein.
- If it is judged by DENSO WAVE INCORPORATED that malfunction of the product is due to the product having been dropped or subjected to impact, repairs will be made at a reasonable charge even within the warranty period.
- Intellectual Property Precaution
DENSO WAVE INCORPORATED ("DENSO WAVE") takes reasonable precautions to ensure its products do not infringe upon any patent or other intellectual property rights of other(s), but DENSO WAVE cannot be responsible for any patent or other intellectual property right infringement(s) or violation(s) which arise from (i) the use of DENSO WAVE's product(s) in connection or in combination with other component(s), product(s), data processing system(s) or equipment or software not supplied from DENSO WAVE; (ii) the use of DENSO WAVE's products in a manner for which the same were not intended nor designed; or (iii) any modification of DENSO WAVE's products by other(s) than DENSO WAVE.

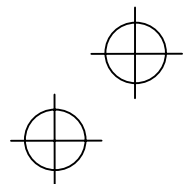
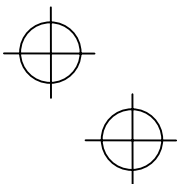

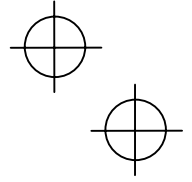
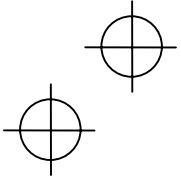

Related Publications

BHT-400B-CE/400BW-CE User's Manual (This manual can be downloaded from our Web site given below.)

Instructions for using the handy terminal (BHT-400B-CE/400BW-CE) and optical communication unit (CU-400).

BHT-400-CE API Reference Manual (This manual can be downloaded from our Web site given below.)

Description for developing application programs for the handy terminal in Microsoft eMbedded Visual C++ 4.0.

DENSO WAVE INCORPORATED <http://www.denso-wave.com/>

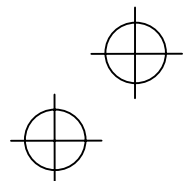
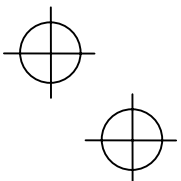

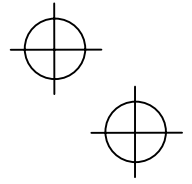
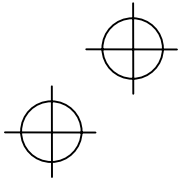

Contents

SAFETY PRECAUTIONS	5
Components and Functions	10
Operating the Touch Screen	14
Windows Desktop on the LCD	14
Reading Bar Codes	15
Using Radio Link	17
Using Infrared Link	18
Loading the Battery Cartridge	19
Calibrating the Touch Screen	21
BHT Turning-off Notes	22
Battery Replacement Notes	23
Warm and Cold Booting	24
About Status Indicators	26
Setting the Backlight	28
Adjusting the Beeper Volume, Switching the Beeper & Vibrator, Calibrating the Touch Screen, and Setting the Backlight	31
Error Messages	36
Proper Care of the BHT	38
Handling Notes	39
US and Canada Regulations	エラー! ブックマークが定義されていません。
Declaration of Conformity (For European Union)	44
Customer Registration	44

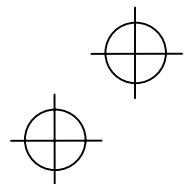
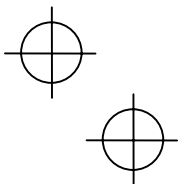

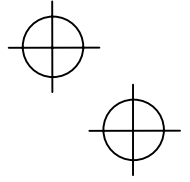
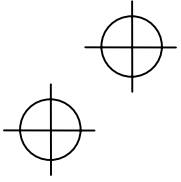

SAFETY PRECAUTIONS

Be sure to observe all these safety precautions.

Strict observance of these warning and caution indications are a MUST for preventing accidents which could result in bodily injury and substantial property damage. Make sure you fully understand all definitions of these terms and related symbols given below, before you proceed on to the text itself.



WARNING

Alerts you to those conditions which could cause serious bodily injury or death if the instructions are not followed correctly.



CAUTION

Alerts you to those conditions which could cause minor bodily injury or substantial property damage if the instructions are not followed correctly.

Meaning of Symbols



A triangle (\triangle) with a picture inside alerts you to a warning of danger. Here you see the warning for electrical shock.





A diagonal line through a circle (\odot) alerts you to something you should not do; it may or may not have a picture inside. Here you see a screwdriver inside the circle, meaning that you should not disassemble.



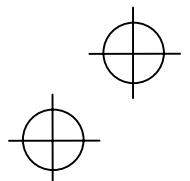
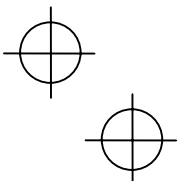



A black circle (\bullet) with a picture inside alerts you to something you MUST do. This example shows that you MUST unplug the power cord.





Handling the battery cartridge

 WARNING	
	<ul style="list-style-type: none">• Only use the dedicated charger for charging the rechargeable battery cartridge. Using a different type of charger could cause battery-rupture or leakage of battery fluid and result in a fire, bodily injury, or serious damage to property.
	<ul style="list-style-type: none">• Never disassemble or heat the rechargeable battery cartridge, nor put it into fire or water; doing so could cause battery-rupture or leakage of battery fluid, resulting in a fire or bodily injury.
	<ul style="list-style-type: none">• Do not carry or store the battery cartridge together with metallic ballpoint pens, necklaces, coins, hairpins, etc. Doing so could short-circuit the terminal pins, causing the batteries to rupture or the battery fluid to leak, resulting in a fire or bodily injury.
	<ul style="list-style-type: none">• Avoid dropping the battery cartridge or letting it undergo any shock or impact. Doing so could cause the batteries to break, generate heat, rupture or burn.
	<ul style="list-style-type: none">• Never charge the rechargeable battery cartridge where any inflammable gases may be emitted; doing so could cause fire.





Handling the BHT

 WARNING	
	<ul style="list-style-type: none"> The BHT uses a laser light for indicating the scanning range. The intensity of the laser light might be too low to inflict bodily injury. However, do not look into the laser beam or view directly with optical instruments. <p>The BHT complies with IEC 60825-1:1993+A2:2001.</p> <p>In accordance with Clause 8 and 9, IEC 60825-1, the following information is provided to the user:</p> <p style="text-align: center;">For USA and Canada</p> <div style="text-align: center;">  <div style="border: 1px solid black; padding: 2px; width: fit-content; margin: 0 auto;"> <p style="font-size: 8px; margin: 0;">LASER RADIATION-DO NOT STARE INTO BEAM OR VIEW DIRECTLY WITH OPTICAL INSTRUMENTS CLASS 2M LASER PRODUCT (M MAXIMUM OUTPUT: 530mW LASER IEC60825-1:1993+A2:2001)</p> <p style="font-size: 8px; margin: 0;">THIS DEVICE COMPLIES WITH 21 CFR 1040.10 AND 1040.11 EXCEPT FOR DEVIATIONS PURSUANT TO LASER NOTICE No.30, DATED JULY 26,2001</p> </div> </div> <p style="text-align: center;">For European Union</p> <div style="text-align: center;">  <div style="border: 1px solid black; padding: 2px; width: fit-content; margin: 0 auto;"> <p style="font-size: 8px; margin: 0;">LASER RADIATION-DO NOT STARE INTO BEAM OR VIEW DIRECTLY WITH OPTICAL INSTRUMENTS CLASS 2M LASER PRODUCT (M MAXIMUM OUTPUT: 530mW LASER IEC60825-1:1993+A2:2001)</p> </div> </div> <p style="text-align: center;">LASER RADIATION DO NOT STARE INTO BEAM OR VIEW DIRECTLY WITH OPTICAL INSTRUMENTS CLASS 2M LASER PRODUCT</p> <p>Caution - Use of controls or adjustments or performance of procedures other than those specified herein may result in hazardous laser light exposure.</p>
	<ul style="list-style-type: none"> Do not look into the light source through the reading window or point the light source towards the eyes. <p>The light emitted through the reading window is harmful to the eyes.</p> <ul style="list-style-type: none"> Do not poke at the eyes with the stylus that comes with the BHT.



Handling the rechargeable cartridge

 CAUTION	
	<ul style="list-style-type: none"> Never charge a wet or damp rechargeable battery cartridge. Doing so could cause the batteries to break, generate heat, rupture or burn.

Handling the BHT

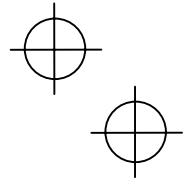
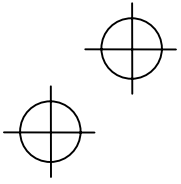
 CAUTION	
	<ul style="list-style-type: none"> If smoke, abnormal odors or noises come from the BHT, immediately turn off the power, pull out the battery cartridge, and contact your nearest dealer. Failure to do so could cause smoke or fire.
	<ul style="list-style-type: none"> If foreign material or water gets into the BHT, immediately turn off the power, pull out the battery cartridge, and contact your nearest dealer. Failure to do so could cause smoke or fire.
	<ul style="list-style-type: none"> If you drop the BHT so as to damage its housing, immediately turn off the power, pull out the battery cartridge, and contact your nearest dealer. Failure to do so could cause smoke or fire.
	<ul style="list-style-type: none"> Do not use batteries or power sources other than the specified ones; doing so could generate heat or cause malfunction.
 Never disassembly	<ul style="list-style-type: none"> Never disassemble or modify the BHT; doing so could result in an accident such as break or fire.
	<ul style="list-style-type: none"> Never put the BHT in places where there are excessively high temperatures, such as inside closed-up automobiles, or in places exposed to direct sunlight. Doing so could affect the housing or parts, resulting in a fire.
	<ul style="list-style-type: none"> Avoid using the BHT in extremely humid or dusty areas, or where there are drastic temperature changes. Moisture or dust will get into the BHT, resulting in malfunction, fire or electrical shock.



 CAUTION	
	<ul style="list-style-type: none">• In environments where static electricity can build into significant charges (e.g., if you wipe off the plastic plate with a dry cloth), do not operate the BHT. Doing so will result in malfunction or machine failure.• Touch (tap) the LCD only with the stylus that comes with the BHT. Using the tip of a pen or any pointed object will result in a damaged or broken LCD.

■ Limited Warranty on Software Products

In no event will DENSO WAVE INCORPORATED be liable for direct, indirect, special, incidental, or consequential damages (including imaginary profits or damages resulting from interruption of operation or loss of business information) resulting from any defect in the software or its documentation or resulting from inability to apply the software or its documentation.

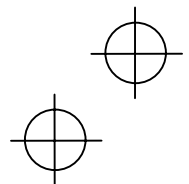
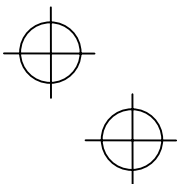

Components and Functions

Built-in antenna*

Do not cover this antenna section with metal-evaporated tape or by hand. Doing so may result in communications failures.

Touch screen LCD (liquid crystal display)

Shows the characters and graphic patterns. You may directly tap the screen with the stylus for data entry.

Charge LED

Illuminates in red during charging and turns green at completion of charging.

Indicator LED

Illuminates in blue when the BHT has successfully read a bar code.

*Provided on the BHT-400BW-CE

Interface port

USB and RS-232C interfaces

Trigger switch (M3 key)

Press this switch to start bar code reading.

- Press this halfway to emit a laser light.
- Press this fully to scan a bar code.

IrDA interface port

Used to exchange data/programs with the host computer via its integrated IR port or via the optical communication unit CU-400.

Hand strap

Be sure to put your hand through this strap to prevent you from dropping the BHT accidentally.

Reading window

CompactFlash card slot

Insert an optional CompactFlash card into this memory extension slot.

Hand belt

Rechargeable battery cartridge

Main power source of the BHT.

Stylus

Reset button

Trigger switch (M4 key)

Press this switch to start bar code reading.

- Press this halfway to emit a laser light.
- Press this fully to scan a bar code.

Battery cartridge cover

Remove this cover to replace the battery cartridge.

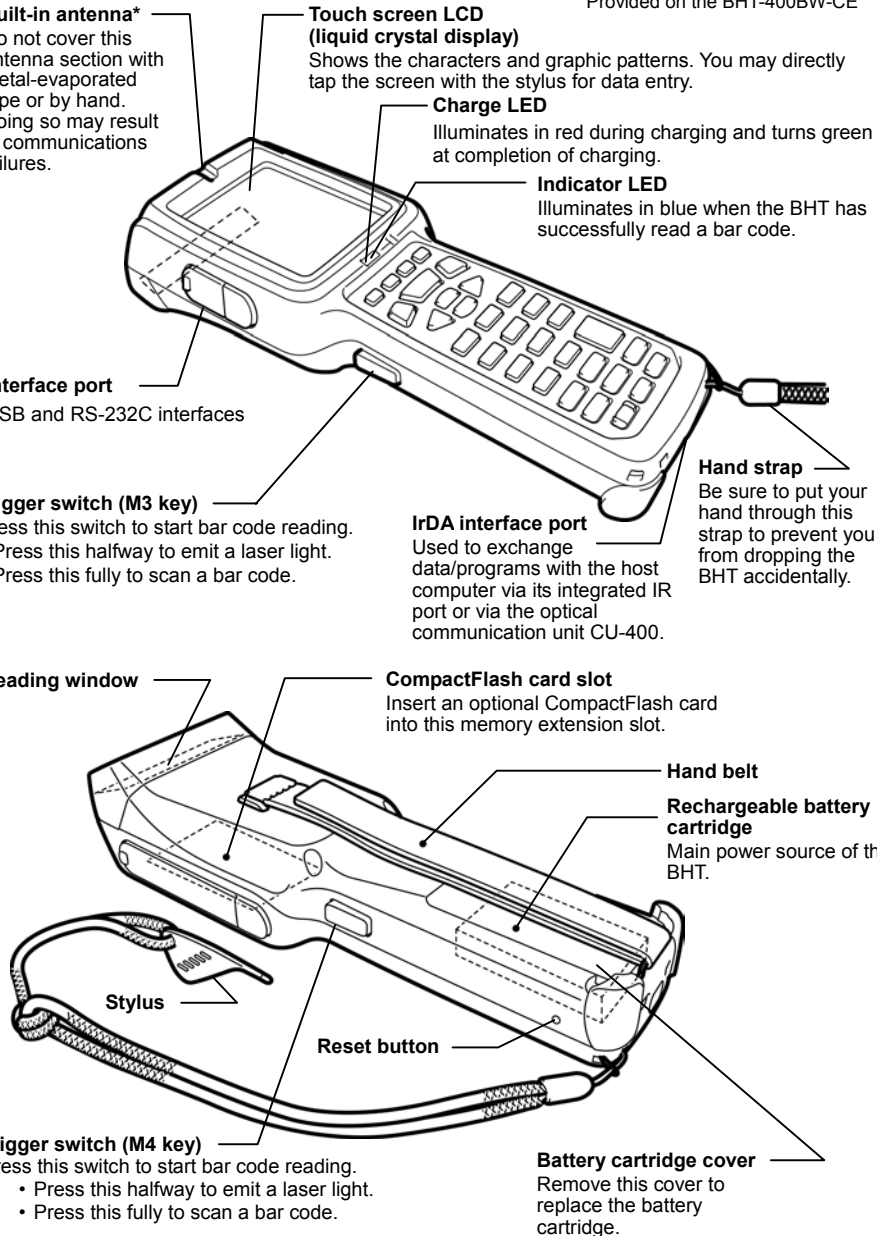

31-key pad

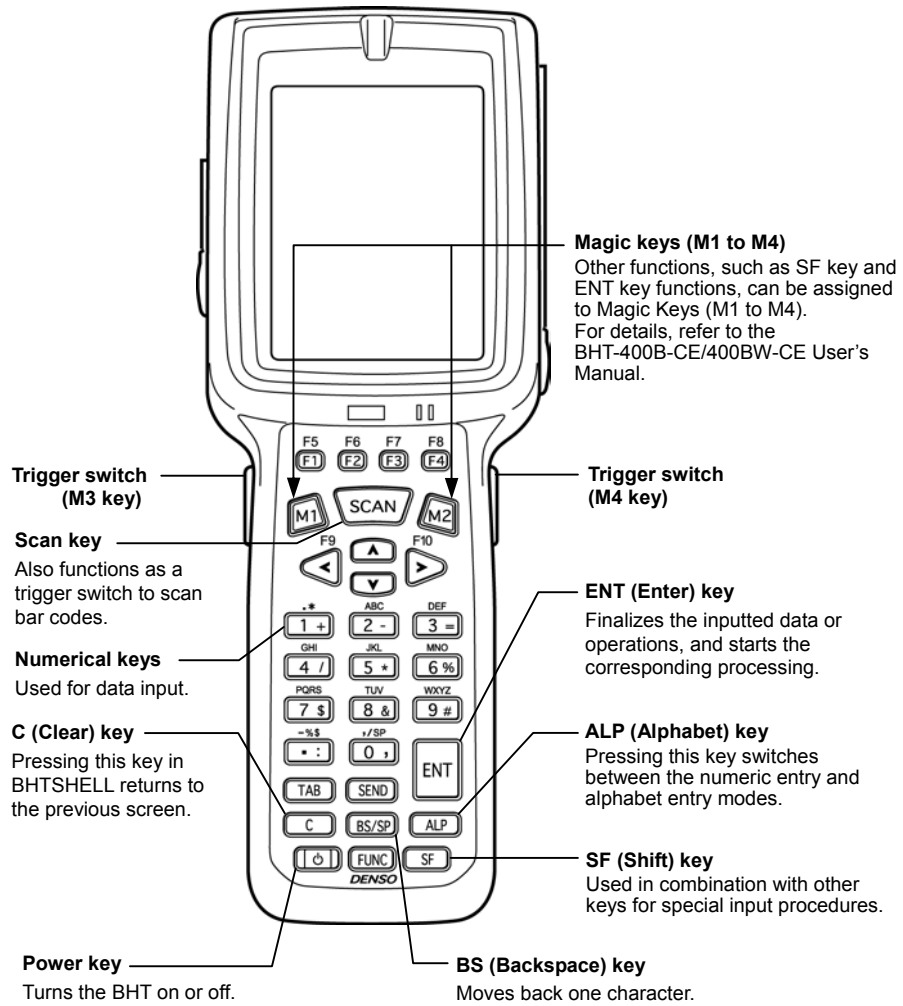

50-key pad (Phone-type key layout)

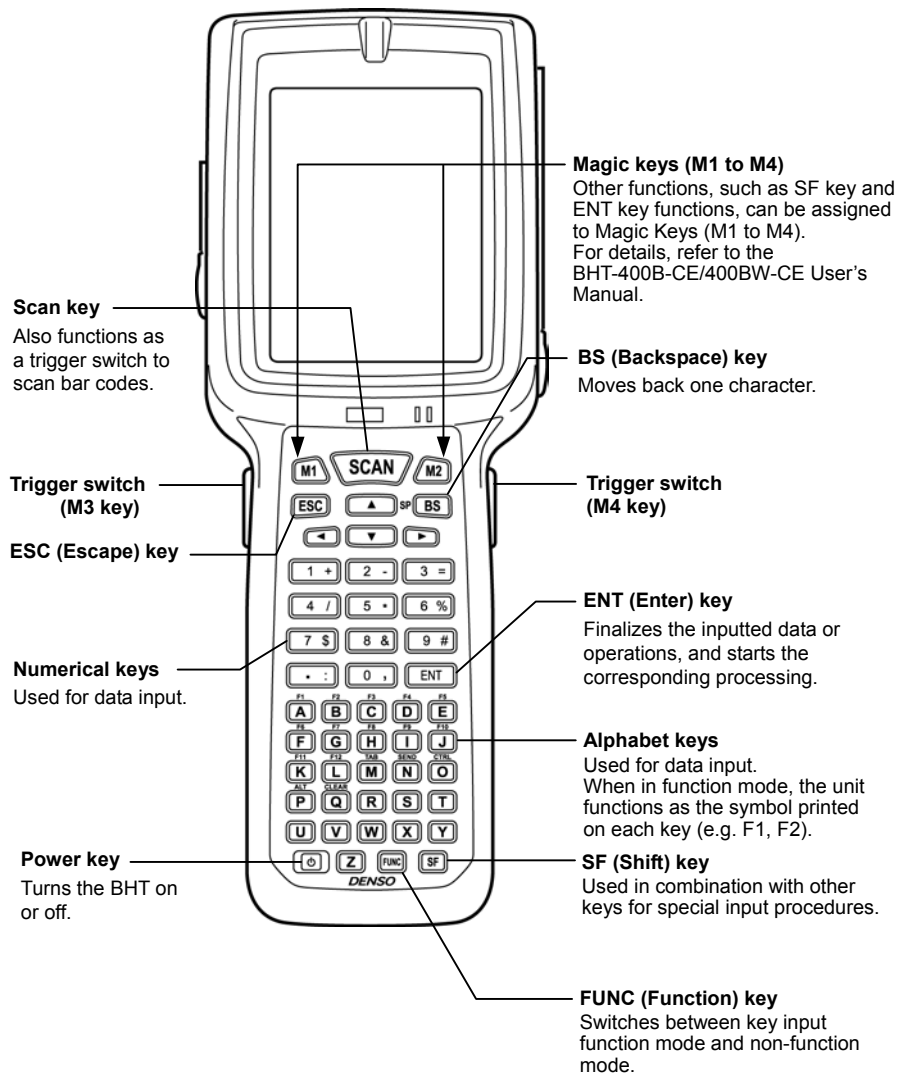

50-key pad (Calculator-type key layout)

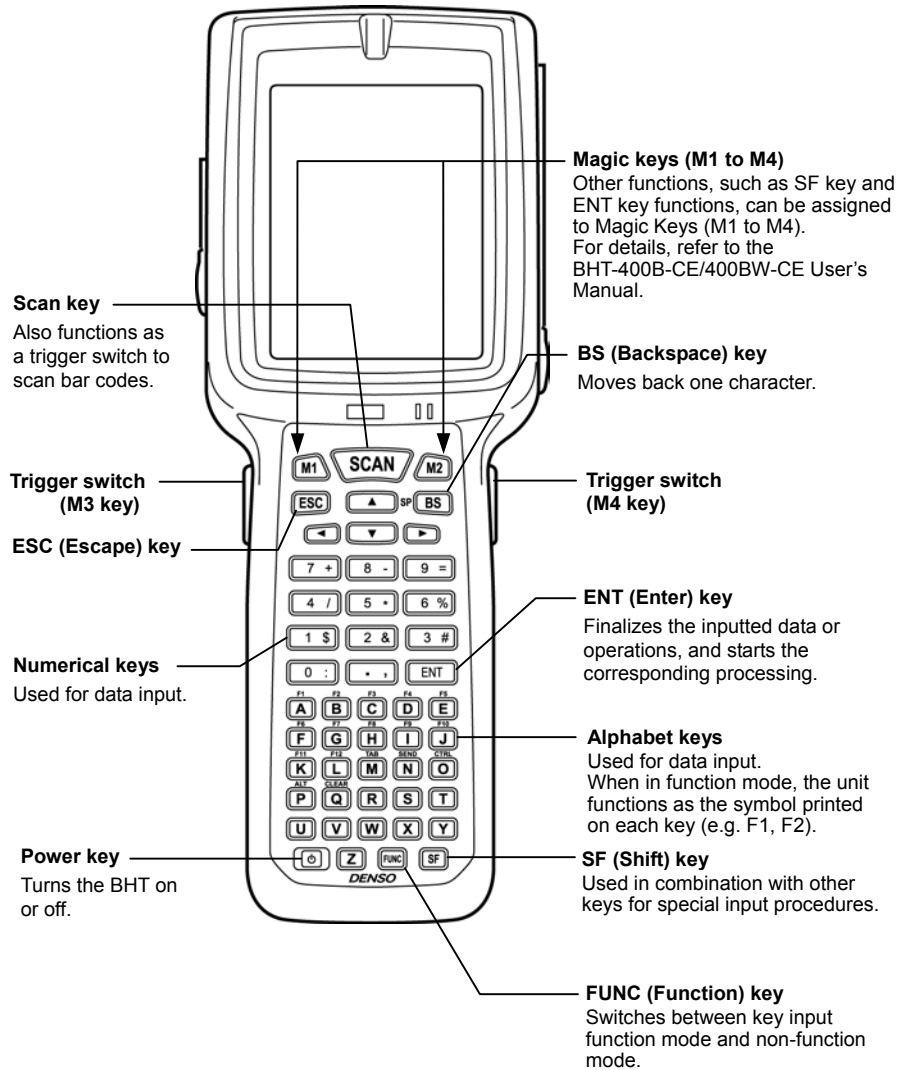

Operating the Touch Screen

You can perform tasks by tapping the elements on the touch screen LCD with the stylus that comes with the BHT.

Action	Description
Tap	Refers to touching the LCD once. (Functionally equivalent to "click" with a mouse on a PC.)
Double-tap	Refers to quickly touching the LCD twice. (Functionally equivalent to "double-click" with a mouse on a PC.)
Drag	Refers to moving the stylus to the object while touching the LCD. (Functionally equivalent to "drag" with a mouse on a PC.)

* Always use the stylus to operate the touch screen. Do not use your fingernails or any pointed or hard object or apply a strong pressure or impact to the LCD.

* Before operation, clean the LCD surface and stylus if dirty. Using dirty ones will scratch the LCD surface or prevent the stylus from sliding smoothly.

Windows Desktop on the LCD

The Windows desktop in the screens in this operator's guide may be a little different from that in the actual screens on the LCD.

(Windows desktop sample)

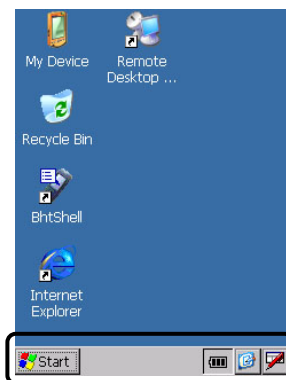

← This task tray also may be a little different from that in the actual screens.

Reading Bar Codes

Turn the BHT on, bring the bar-code reading window to the bar code to be scanned, and press the trigger switch. Pressing the trigger switch halfway emits a laser light to indicate the scanning range and pressing it fully turns on the illumination LED to scan the bar code.

Bar codes can also be scanned by pressing the Scan key.

When the BHT has read the bar code successfully, the indicator LED will illuminate in blue.

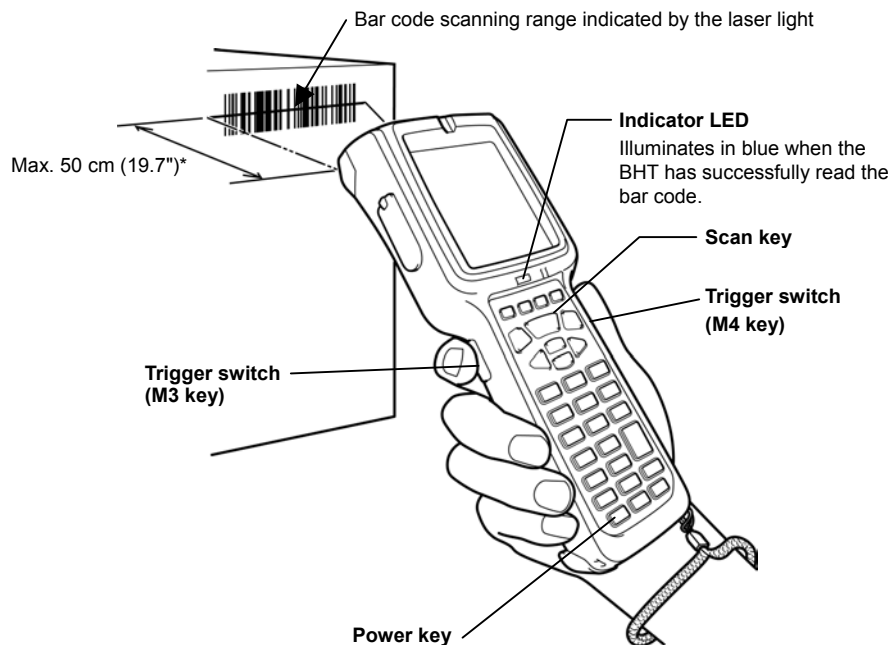

* The BHT can read bar codes at a maximum distance of 50 cm (19.7") from the reading window. (*For details, refer to the BHT-400B-CE/400BW-CE User's Manual.)

- If the BHT fails to read due to specular effects or other factors, change the scanning angle of the reading window or the distance from codes as shown at right, and try it again. (Specular effects occur when the reflection of the light from the bar code becomes excessively strong. This can easily happen when the reflecting surface is polished or covered with vinyl.)
- The laser light indicates the scanning range as a guide. The indicated scanning range will deviate a little bit from the actual one. Keep the BHT so that the laser light comes to almost the center of the bar code height.
- The bar code reading procedure may differ depending upon the application used, so follow the application's manual.

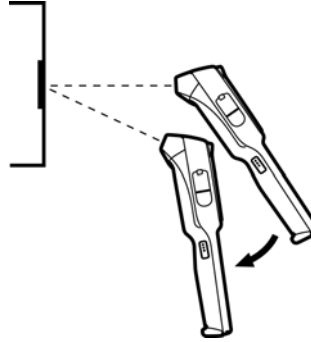
**NOTE**

- Before reading labels, clean them if stained.
- Avoid using the BHT in direct sunlight. The BHT might fail to read correctly.
- To read bar codes on curved surfaces, apply the bar-code reading window to the center of each bar code at a right angle.
- If you pull the bar-code reading window away from bar codes, the actual scanning range will become narrower than the range covered by the illumination LED.

TIP

The light intensity of the laser light or illumination LED will vary depending upon the scanning conditions and variation of its elements.

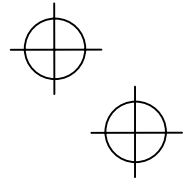
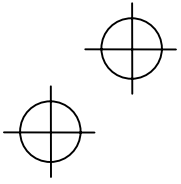

Using Radio Link

The BHT-400BW-CE supports spread spectrum communication.

- If there are too many communications errors, first make sure that the BHT-400BW-CE points directly at an access point because the 2.4-GHz band requires a more or less straight line path. Note also that the low-power radio waves have trouble passing through human bodies and other obstacles along that path.
- This link will not operate properly in the vicinity of microwave ovens, industrial heaters, high-frequency medical equipment, and other sources of radio waves in the 2.4-GHz band.
- Electromagnetic noise from personal computers, refrigerators, and other home appliances can also interfere with link operation.
- Environmental factors that can also interfere with link operation include large metallic objects, metallic dust, or metallic walls in the vicinity of the path and vibration at either end.

NOTE

To System Designers:

- Before developing the application, make sure that the intended environment is free of the interference factors above and thus actually capable of supporting link operation.
- Assume that there will be communications failures requiring robust retry capabilities in the software.
- When introducing the BHT link operation into an environment where equipment using radio waves in the 2.4-GHz band operates or when introducing such equipment after the introduction of the BHT link operation, be sure to confirm that the BHT radio link operates properly with all equipment being in operation beforehand.
- If the environment of the radio communications system is changed after the introduction (e.g., newly installed household appliances and movement/addition of shelves or objects), then confirm that the radio link operates properly again before the actual use.

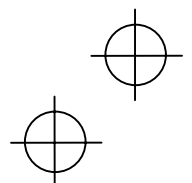
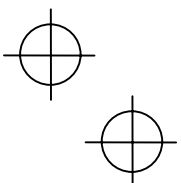

Using Infrared Link

■ CU-400

Make sure that the BHT is securely in the CU-400.

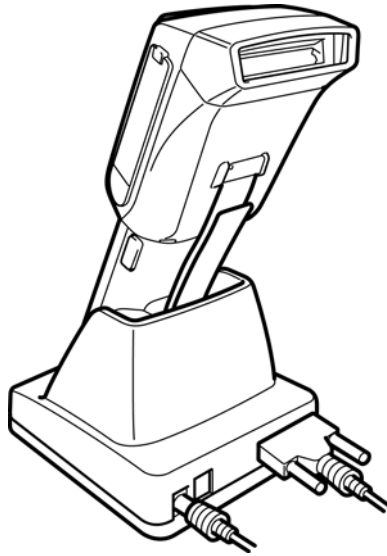

NOTE Shield the IrDA interface from direct sunlight, ambient intense lighting (inverter-driven fluorescent lighting, in particular), and other potential sources of infrared radiation. Sources to watch out for include remote control units for television sets and the like.

Loading the Battery Cartridge

Before the first use of the BHT, be sure to load the battery cartridge as shown below. The battery cartridge is not loaded in the BHT when shipped from the factory.

- (1) Turn the BHT upside down.
- (2) Slide the release buttons in the direction shown below and remove the battery cartridge cover.
- (3) Push the battery cartridge into the BHT.
(To remove it, first make sure that the BHT is turned off. Slide the release buttons, remove the battery cartridge cover, and pull up the battery pull strap.)
- (4) Set the battery cartridge cover back into place and slide the release buttons to the original position.
- (5) Place the BHT on the CU-400 to charge the rechargeable battery cartridge.

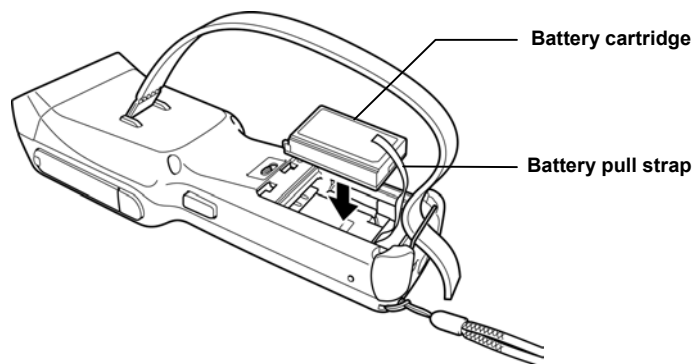
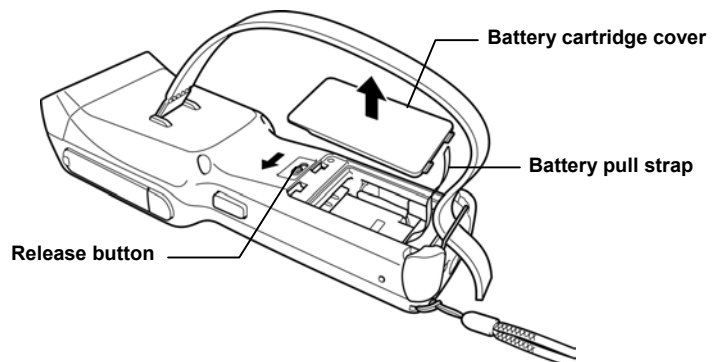

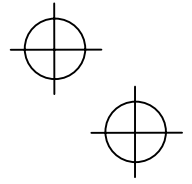
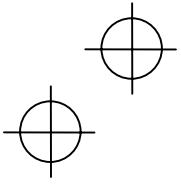

NOTE

- The BHT integrates a rechargeable backup power source which backs up the memory and calendar clock in the BHT when no battery cartridge is loaded or the voltage level of the battery cartridge drops below the specified level. The backup power source is automatically charged by the battery cartridge.

When you first load the battery cartridge after purchase or you load it after leaving the BHT unused for a long time, do not remove the battery cartridge for at least 48 hours after that loading. This is for charging the memory backup source integrated in the BHT.

- For handling notes to be observed at the time of battery replacement, refer to the "Battery Replacement Notes" on page 23.

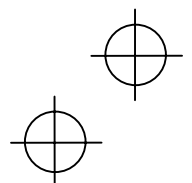
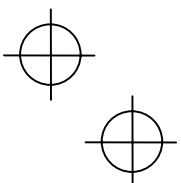

Calibrating the Touch Screen

At the first use of the BHT, you need to calibrate the touch screen and set up the calendar clock. Press the **power** key to turn on the BHT. The calibration screen appears, so follow the on-screen instructions. If nothing appears, first perform a "cold boot" (described on the "Warm and Cold Booting" on page 24).

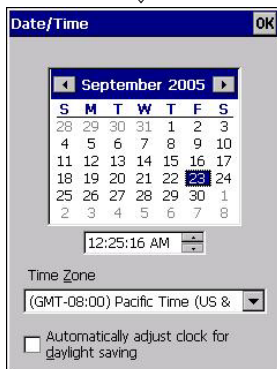
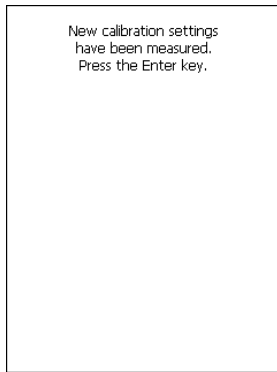
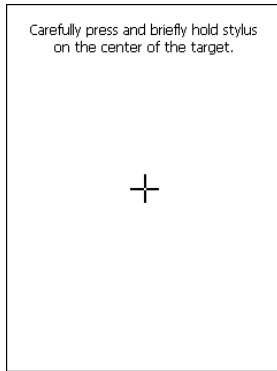

Calibration screen

The "+" appears first at the center of the screen as shown at left.

Tap the center of the "+" with the stylus for one second, and the "+" moves to the upper left. Tap its center, and it moves to the bottom left.

This way, tapping the center of the "+" moves it, starting from the center of the screen to the upper left, bottom left, bottom right and upper right in this sequence.

NOTE During calibration, the **power** key is disabled. After completing the calibration, press the **power** key.

After completion of the above calibration, press the **ENT** key or tap the screen. The calendar clock setup screen will appear below at left.

Set the date, time, and time zone. Then tap the **OK** button.

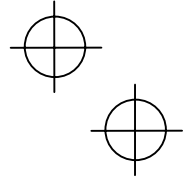
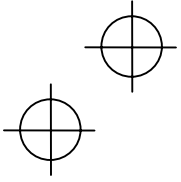

BHT Turning-off Notes

If you press the **power** key to turn off the BHT, the BHT displays the following message and starts preparation for shutdown.

Shutdown
in progress.
Do not remove
the battery.

When the above message is displayed, do not remove the battery cartridge.

If you do so, the data stored in the BHT may be lost.

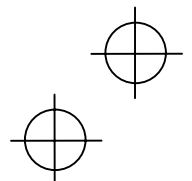
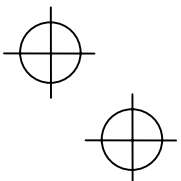

Battery Replacement Notes

■ When is battery replacement needed?

If the "Charge the battery!" appears on the LCD, replace the rechargeable battery cartridge with a fully charged one.

If you leave the BHT without replacing the rechargeable battery cartridge, the integrated calendar clock and data stored in the BHT's RAM can no longer be backed up. The calendar clock may stop and RAM data may be lost.

NOTE

- Be sure to turn the BHT off before battery replacement.
- Replace the battery cartridge quickly. Load a charged battery cartridge within 3 minutes after the removal to avoid data loss.
- After battery replacement, turn the BHT on and check the BHT operation.
- If you leave the BHT with no battery cartridge loaded for a long time, the contents of the memory may no longer be backed up so that the data stored in the BHT's RAM may be lost. It is recommended that important data be saved into the FLASH folder or uploaded to the host computer.
- The battery cartridge will gradually deteriorate during the repeated cycles of charging and discharging due to its properties. When the battery operation period becomes shortened due to its deterioration even if it has been charged for the specified hours, replace the battery cartridge with a new one.
- Use only DENSO WAVE-authorized battery cartridges and chargers.
- Never dispose of battery cartridges into a fire. They should be recycled properly. Do not throw them in a trash.

Warm and Cold Booting

■ Warm-booting the BHT

In any of the following cases, warm-boot the BHT:

- The BHT makes no response to entry from the touch screen or keys.
- The programs in the BHT malfunction due to any problems.

NOTE Warm-booting the BHT will not erase data stored in the RAM, but it will erase data being edited and not be saved.

Warm booting procedure

When the BHT is turned on, press the reset button with the stylus.

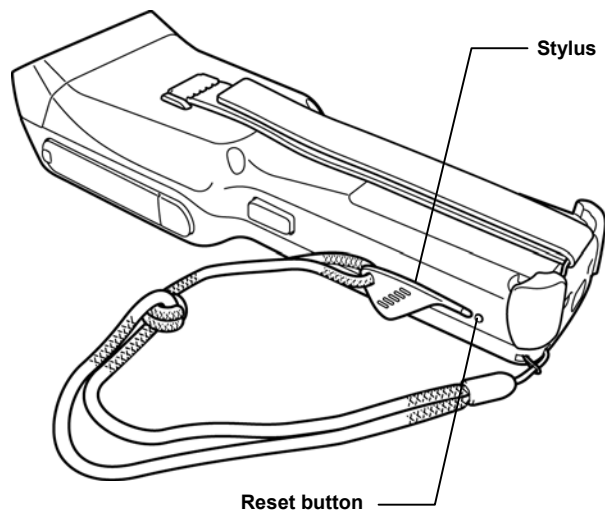

■ **Cold-booting the BHT**

If a problem persists even after warm-booting the BHT, cold-boot the BHT.

NOTE Cold-booting the BHT will erase all data stored in the RAM. It is recommended that important data be saved into the FLASH folder or uploaded to the host computer.

Cold booting procedure

Turn the BHT off. While holding down the reset button with the stylus, press the **power** key and then release both buttons. Press the **power** key again, and the BHT cold-boots.

■ **Contents of the memory after warm-/cold-booting the BHT**

	After warm booting	After cold booting
Data in the FLASH folder	Retained	Retained
Data in other folders	Retained	Erased
Contents of the Registry	Retained	Erased (Note)
Data being edited	Erased	Erased

(Note) If the Registry has been backed up*, that backup will apply after cold booting.

*When the BHT is on, pressing the **power** key with the **SF** key held down displays the screen shown at right and starts backing up the Registry.

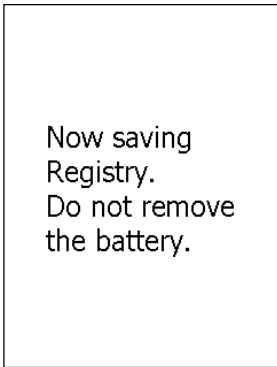



About Status Indicators



Battery voltage level



Shows the current battery voltage level.

-  Displays when the voltage level is high.
-  Displays when the voltage level is low.

TIP The displayed battery level shows the terminal voltage of the battery cartridge, not how much power is left.



The battery voltage level varies depending upon the operation of the BHT, so the displayed level also may vary.

Wireless Zero Configuration radio status

-  Indicates that the Wireless Zero Configuration (WZC) radio is connected to a wireless network.
-  Indicates that the Wireless Zero Configuration (WZC) radio is not connected to a wireless network.

Synchronization state (Provided on the BHT-400BW-CE)

Displays the open state of the wireless device and the radio field intensity.

-  Displays when the wireless device is open.
-  Shows the radio field intensity with the number of bars.

Keypad shift state

-  Displays when the keypad is shifted.

Function key mode state

-  Displays when the function key is pressed.

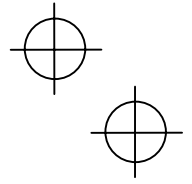
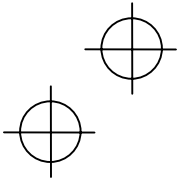

ActiveSync



Displays when the BHT is communicating with the PC via Microsoft ActiveSync.

Alphabet input state



Displays when the alphabet input function is activated.

(Pressing the **ALP** key switches between the numeric entry and alphabet entry modes.)



The ALP window appears when the alphabet input function is activated. Pressing any numeric key displays the alphabet letter assigned to that key in this ALP window.

Desktop display



Tapping this icon when an application program is running switches the screen to the desktop display. Tapping it again returns to the application execution screen.

Software keyboard display/hide

Shows whether the software keyboard is displayed or hidden.

(Tapping this icon toggles the software keyboard on and off.)



Displays when the software keyboard is displayed.



Displays when the software keyboard is hidden.

Standby state



Appears when the CPU comes to be on standby.

(This icon does not appear by default. You can display it by changing the setting in System Menu or in user programs.)

Caps Lock state



Appears when the Caps Lock switch is pressed on the software keyboard.

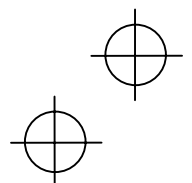
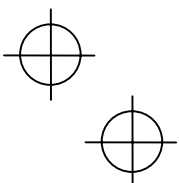

Setting the Backlight

31-key pad

Pressing the right-hand trigger switch (**M4** key) with the **SF** key held down activates or deactivates the backlight function.

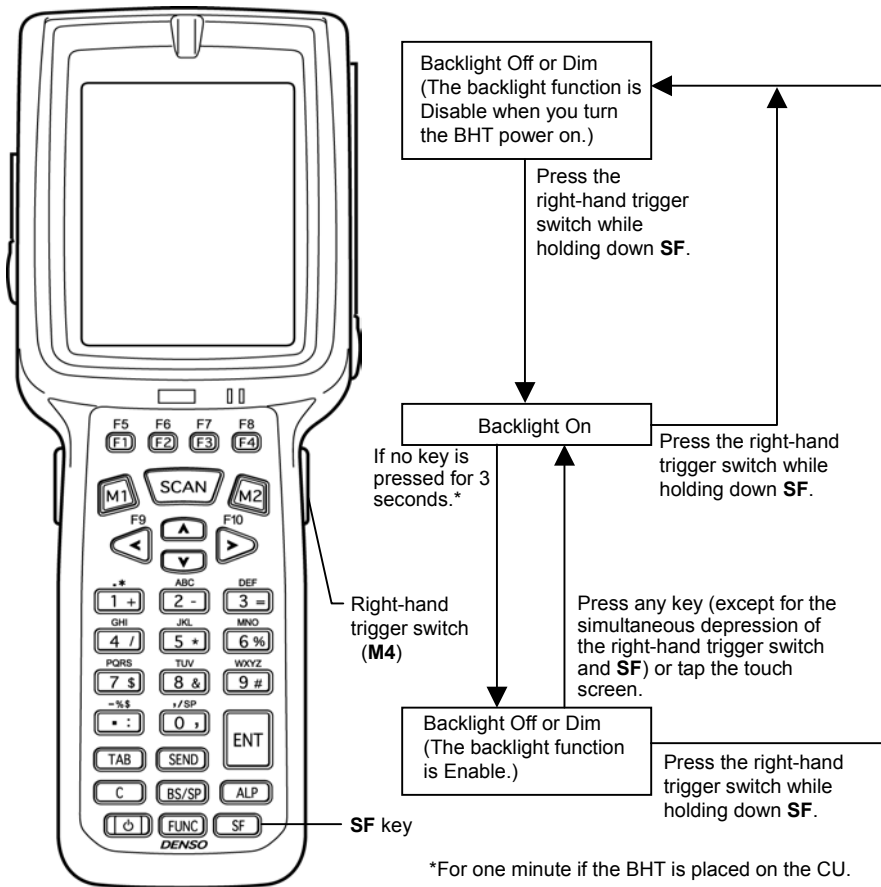

NOTE In user programs, you can select the key to be used for activating or deactivating the backlight function (instead of the initial setting: combination of **SF** key and right-hand trigger switch (**M4**)), as well as modifying the ON-duration of the backlight before the automatic turning-off.

TIP You can enable or disable the backlight function on the Backlight menu, instead of pressing the backlight function on/off key. (For details, refer to page 35.)

50-key pad (Phone-type key layout)

Pressing the right-hand trigger switch (**M4** key) with the **SF** key held down activates or deactivates the backlight function.

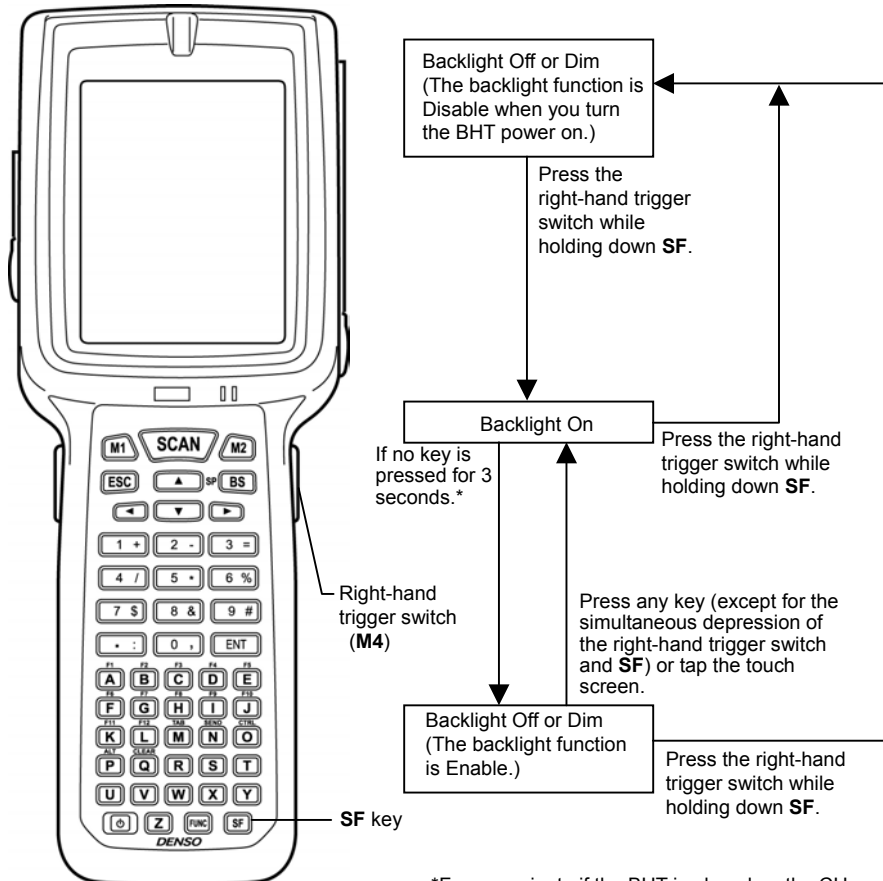

*For one minute if the BHT is placed on the CU.

NOTE In user programs, you can select the key to be used for activating or deactivating the backlight function (instead of the initial setting: combination of **SF** key and right-hand trigger switch (**M4**)), as well as modifying the ON-duration of the backlight before the automatic turning-off.

TIP You can enable or disable the backlight function on the Backlight menu, instead of pressing the backlight function on/off key. (For details, refer to page 35.)

50-key pad (Calculator-type key layout)

Pressing the right-hand trigger switch (**M4** key) with the **SF** key held down activates or deactivates the backlight function.

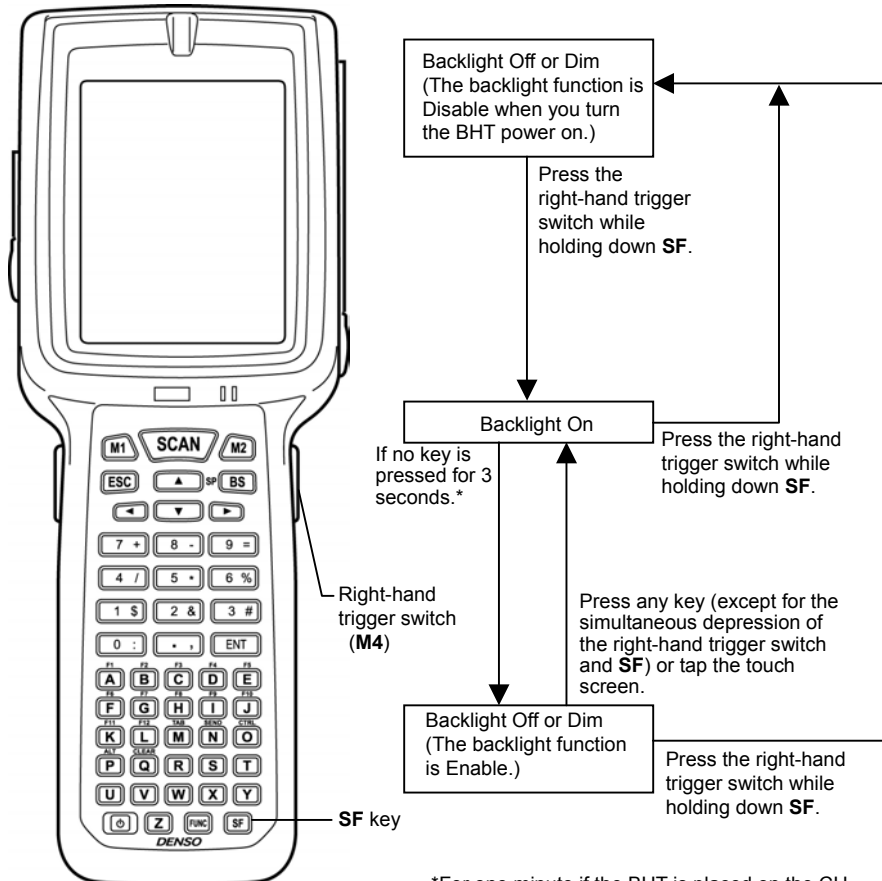

*For one minute if the BHT is placed on the CU.

NOTE In user programs, you can select the key to be used for activating or deactivating the backlight function (instead of the initial setting: combination of **SF** key and right-hand trigger switch (**M4**)), as well as modifying the ON-duration of the backlight before the automatic turning-off.

TIP You can enable or disable the backlight function on the Backlight menu, instead of pressing the backlight function on/off key. (For details, refer to page 35.)

Adjusting the Beeper Volume, Switching the Beeper & Vibrator, Calibrating the Touch Screen, and Setting the Backlight

You can adjust the beeper volume, switch the beeper and vibrator on and off, calibrate the touch screen, and set the backlight according to the procedure below.



Double-tap **BHTSHELL** on the desktop to call up the System Menu.

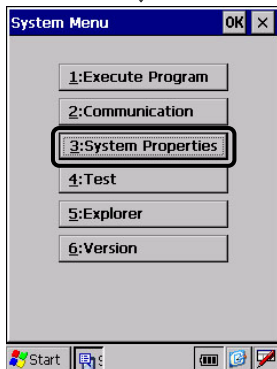

Choose "3: System Properties."

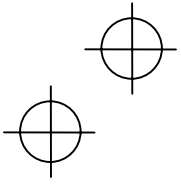

32

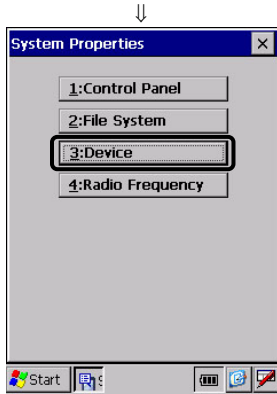

Choose "3:Device."

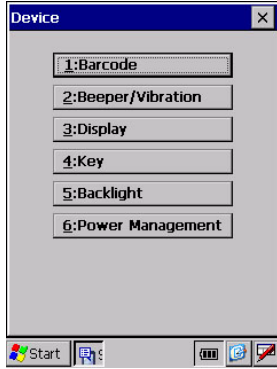

The Device setting menu appears as shown at left.

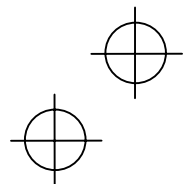
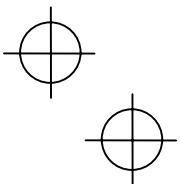
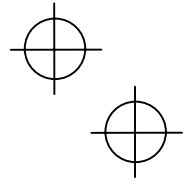

Adjusting the beeper and switching the beeper and vibrator

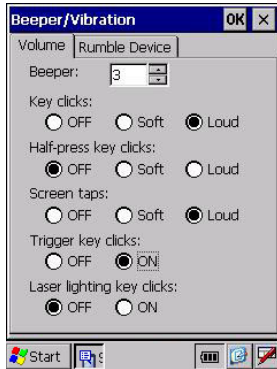

Choosing "2:Beeper/Vibration" on the Device setting menu calls up the screen shown at left.

On this menu, you can adjust the beeper volume and switch the beeper and vibrator.

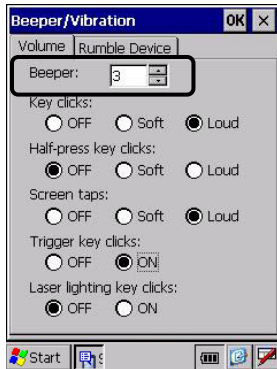

Choosing the Volume tab calls up the screen shown at left.

You can adjust the beeper volume to six levels from 0 to 5. The greater the value, the higher the beeper volume.

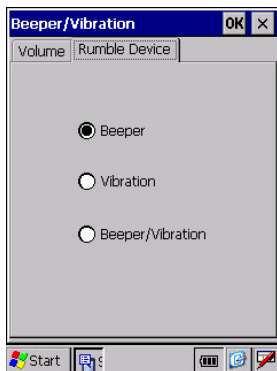

Choosing the Rumble Device tab calls up the screen shown at left.

You may select any of three ways--beeping only, vibrating only, and combination of beeping and vibrating as a confirmation of completion of bar code reading.

Beeper: Beeping only
 Vibration: Vibrating only
 Beeper/Vibration: Beeping and vibrating

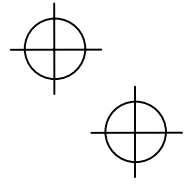
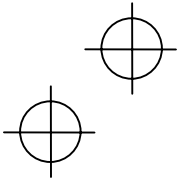

Calibrating the touch screen

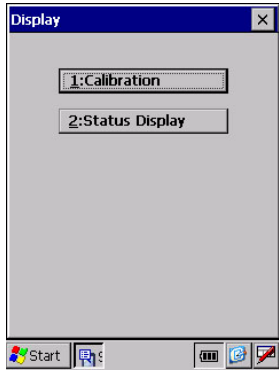

Choosing "3:Display" on the Device setting menu calls up the screen shown at left.

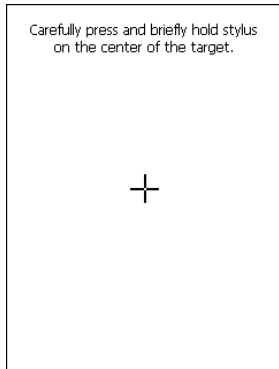

Choosing "1:Calibration" on the Display setting menu calls up the screen shown at left.

Follow the instructions on the screen. Refer to the "Calibrating the Touch Screen."

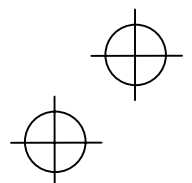
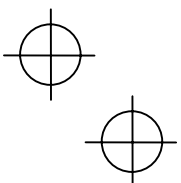

Setting the backlight

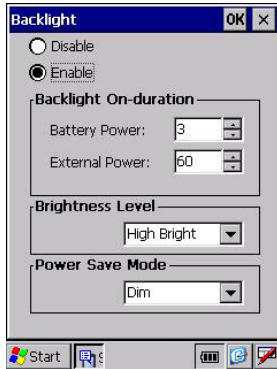

Choosing "5:Backlight" on the Device setting menu calls up the screen shown at left.

- Backlight function^(*)

Enable or disable the backlight function. If it is enabled, the backlight comes on when you press any key or tap the touch screen.

- Backlight On-duration

Set the ON-duration of the backlight that comes on when you press any key or tap the touch screen.

Battery Power: ON-duration when the BHT is not placed on the CU.

External Power: ON-duration when the BHT is placed on the CU.

- Brightness Level

Select the desired brightness level from the following four choices:

	(Dark)
Off	↑
Low Bright	
Mid Bright	
High Bright	↓
(*)	(Bright)

Pressing the backlight function on/off key (the initial setting: the simultaneous depression of the **SF** key and right-hand trigger switch (**M4** key)) toggles between enabled and disabled states, regardless of the backlight function setting made on this screen.

- Power Save Mode

Change the settings for turning off the backlight after the BHT has not been used for a specified period of time.

Off: The backlight turns off immediately.

Dim: The backlight remains on very dimly.

Error Messages

If some error occurs when the power is turned on or during program execution, one of the following error messages will appear on the LCD.

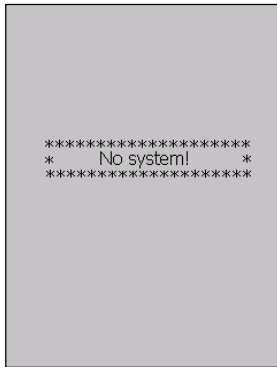

System Program error

■ Problem

A System Program error has occurred.

■ Solution

Contact your system administrator.

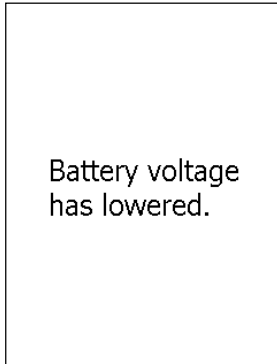

Low battery warning

■ Problem

When the BHT is turned on or off or during execution of program, the battery output level has dropped below a specified lower limit.

NOTE

If low battery is detected, the BHT displays this message for approx. 2 seconds and beeps three times (for 0.1 second per beep). After that, it will resume previous regular operation.

■ Solution

The battery cartridge will need to be recharged before long. Replace or recharge the battery cartridge.

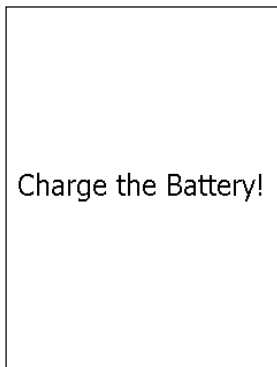
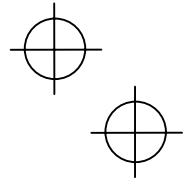
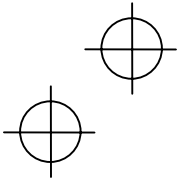

Shutdown due to low battery

■ Problem

When the power is turned on or off or during execution of programs, the battery output level has lowered to the extent the BHT can no longer operate.

NOTE

If lower battery is detected, the BHT beeps five times (for 0.1 second per beep) and then turns itself off. Depending upon the battery level, the beeper may not sound five times.

■ Solution

Replace or recharge the battery cartridge.

Service life warning for backup battery

■ Problem

The backup battery has been charged/discharged by the specified number of times so that the battery capacity lowers below the specified level.

■ Solution

Replace the backup battery. For the replacement procedure, refer to the BHT-400B-CE/400BW-CE User's Manual.

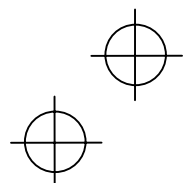
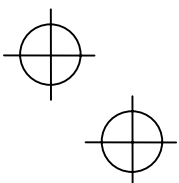

Proper Care of the BHT

Wipe the BHT's charge terminals and battery cartridge terminals with a cotton swab or the like periodically. Clean the BHT housing with a dry, soft cloth. Before cleaning, be sure to turn the BHT off.

- Never use benzene, alcohol, or other organic solvents. The housing may be marred or the paint may come off.
- Never rub or strike the liquid crystal display (LCD) with anything hard. The LCD surface will be easily scratched or broken.
- When cleaning the keypad, do not scrub the surface too hard or pull on the keys. Doing so may break the keys.



- If the BHT becomes smudged, wipe it with a soft cloth that has been moistened in soapy water (always use neutral detergent) and wrung out thoroughly.

Dust or dirt accumulating on the clear plate of the bar-code reading window will affect reading performance. If you use the BHT in dusty areas, therefore, periodically check the clear plate of the bar-code reading window and clean it if dusty.

- To clean the plate, first blow the dust away with an airbrush. Then wipe the plate with a cotton swab or the similar soft one gently.
- If sand or hard particles have accumulated, never rub the plate; doing so will scratch or damage it. Blow the particles away with an airbrush or a soft brush.

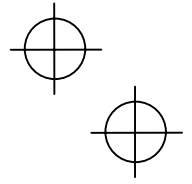
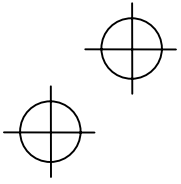

Handling Notes

- An early upload of gathered data is recommended, since the data stored in the RAM might be affected by the so-called "soft error" or other environmental phenomena.
- Do not use the BHT in the vicinity of radio equipment. The BHT may malfunction.
- Avoid storing the battery cartridge in a hot place. The battery capacity may be decreased.
- Do not touch the battery cartridge terminals or BHT's charge terminals by hand or stain them. Doing so could result in BHT's malfunction or cartridge charging failure.
- When connecting or disconnecting cables, do not plug or unplug at an angle and do not pull them strongly. Doing so will result in a machine failure.
- If the BHT has been stored in a hot (50°C to 60°C, 122°F to 140°F) and humid place, allow it to sit at room temperature and humidity for at least one day before use. Using the BHT with its inside being hot will fail to scan or result in a machine failure.
- If the stylus wears so that its tip becomes sharpened, replace it.
- In environments where static electricity can build into significant charges, do not operate the BHT. Doing so will result in malfunction or machine failure.
- Avoid dropping the BHT or letting it undergo any shock or impact. Doing so will break or damage the BHT.
- If the "Charge the battery!" message appears after the BHT undergoes any shock or impact, turn the BHT off and on and then check the battery output level. The battery may not have run out.
- Battery cartridges should be recycled properly in conformity with local codes and regulations.

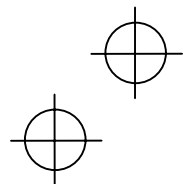
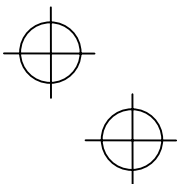

US and Canada Regulations

BHT-400BW-CE contains Wireless LAN module (type WM-G-MR-01) that complies with Part 15 of FCC rules and RSS-Gen of IC rules.

For Wireless LAN module

This device complies with Part 15 of FCC rules and RSS-Gen of IC rules.

Operation is subject to the following two conditions:

- (1) this device may not cause harmful interference, and
- (2) this device must accept any interference received, including interference that may cause undesired operation.

FCC WARNING: Changes or modifications not expressly approved by the party responsible for compliance could void the user's authority to operate the equipment.

CAUTION: Radio Frequency Radiation Exposure

The available scientific evidence does not show that any health problems are associated with using low power wireless devices. There is no proof, however, that these low power wireless devices are absolutely safe. Low power Wireless devices emit low levels of radio frequency energy (RF) in the microwave range while being used. Whereas high levels of RF can produce health effects (by heating tissue), exposure to low-level RF that does not produce heating effects causes no known adverse health effects. Many studies of low-level RF exposures have not found any biological effects. Some studies have suggested that some biological effects might occur, but such findings have not been confirmed by additional research. This Barcode Handy Terminal that is installed WM-G-MR-01 (FCC ID: PZWWMGMR01) has been tested and found to comply with FCC radiation exposure limits set forth for an uncontrolled equipment and meets the FCC radio frequency (RF) Exposure Guidelines in Supplement C to OET65. Please refer to the SAR test report that was uploaded at FCC website.

Do not place hands or body near the antenna section to avoid RF exposure.

This transmitter must not be co-located or operated in conjunction with any other antenna or transmitter.

This handy scanner is intended exclusively for hand held use.

Do not use while wearing the scanner on the body.

There is no accessory for body worn purpose.

Do not place hands or body near the antenna area.

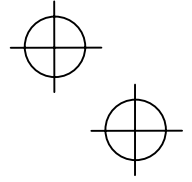
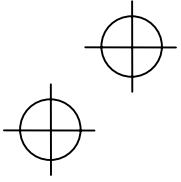

BHT-400B-CE and BHT-400BW-CE comply with Part 15 of FCC rules and ICES-003 of IC rules.

For Barcode Handy Terminal

This device complies with Part 15 of FCC rules and ICES-003 of IC rules.

Operation is subject to the following two conditions:

- (1) this device may not cause harmful interference, and
- (2) this device must accept any interference received, including interference that may cause undesired operation.

NOTE: This equipment has been tested and found to comply with the limits for a Class A digital device, pursuant to Part 15 of the FCC Rules. These limits are designed to provide reasonable protection against harmful interference when the equipment is operated in a commercial environment. This equipment generates, uses, and can radiate radio frequency energy and, if not installed and used in accordance with the instruction manual, may cause harmful interference to radio communications. Operation of this equipment in a residential area is likely to cause harmful interference in which case the user will be required to correct the interference at his own expense.

NOTE: This Class A digital device apparatus complies with Canadian ICES-003. Cet appareil numérique de la classe A est conforme à la norme NMB-003 du Canada.

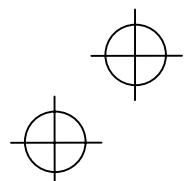
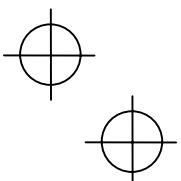

Declaration of Conformity (For European Union)

The radio frequency module that complies with the Directive 99/5/EC(R&TTE) is mounted on this device (BHT-400BW-CE).

DECLARATION OF CONFORMITY

Directive 99/5/EC (R&TTE)

Manufacturer or

Authorized representative : **DENSO WAVE INCORPORATED**

Address : **1-1 Showa-cho, Kariya-shi, Aichi-ken, 448-8661, Japan**

We declare on our sole responsibility, that the following product :

- Kind of equipment : **Radio frequency module**
- Type-designation : **WM-G-MR-01**

is compliance with the essential requirement of §3 of the R&TTE.

- Health and safety requirements pursuant to §3(1)a :
Applied Standard(s) or other means of providing conformity :
EN60950-1
- Protection requirements concerning EMC §3(1)b :
Applied Standard(s) or other means of providing conformity :
EN301 489-1
EN301 489-17
- Measures for the effective use of the Radio frequency spectrum §3(2) :
Applied Standard(s) or other means of providing conformity :
EN300 328

CE marking



Labeling

■ BHT-400B-CE

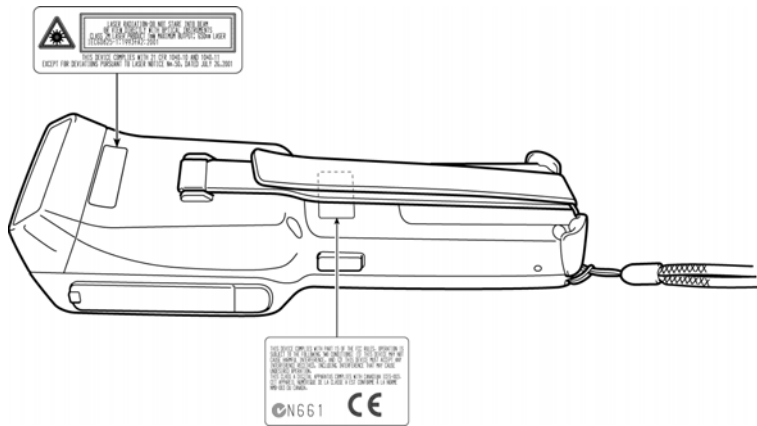

■ BHT-400BW-CE

For USA and Canada For European Union

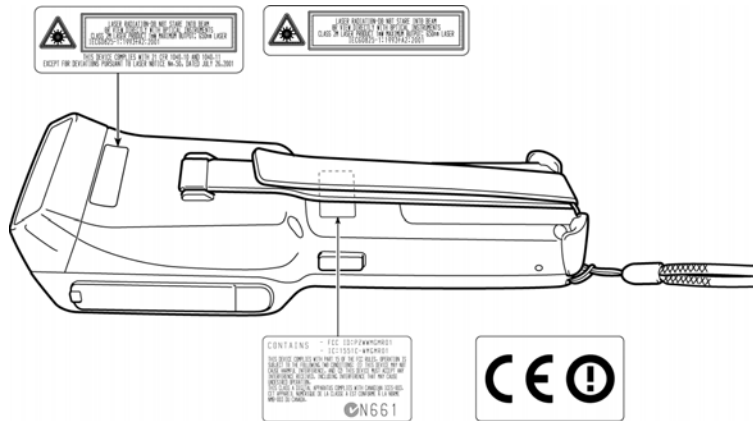

For USA and Canada For European Union

Declaration of Conformity (For European Union)

The radio frequency module that complies with the Directive 99/5/EC(R&TTE) is mounted on this device (BHT-400BW-CE).

DECLARATION OF CONFORMITY

Directive 99/5/EC (R&TTE)

Manufacturer or

Authorized representative : **DENSO WAVE INCORPORATED**

Address : **1-1 Showa-cho, Kariya-shi, Aichi-ken, 448-8661, Japan**

We declare on our sole responsibility, that the following product :

- Kind of equipment : **Radio frequency module**
- Type-designation : **WM-G-MR-01**

is compliance with the essential requirement of §3 of the R&TTE.

- Health and safety requirements pursuant to §3(1)a :
Applied Standard(s) or other means of providing conformity :
EN60950-1
- Protection requirements concerning EMC §3(1)b :
Applied Standard(s) or other means of providing conformity :
EN301 489-1
EN301 489-17
- Measures for the effective use of the Radio frequency spectrum §3(2) :
Applied Standard(s) or other means of providing conformity :
EN300 328

CE marking



Customer Registration

Thank you for purchasing our product. We would like to offer you the following support and assistance for your more convenient use of our products when you fill out and submit the customer registration form.

Privileges of customer registration

1. Free upgrade information
2. Free exhibition and event information of new products
3. Free web-information service "QBnet."

"QBnet" Contents

- Information searching
- Download service
- Inquiry with email

※These are subject to change without notice.

How to Register

Through Internet at the following address

<http://www.denso-wave.com/en/adcd/support/>

After going into Internet, please access the above-mentioned URL address.

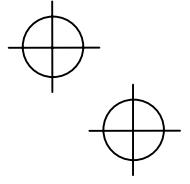
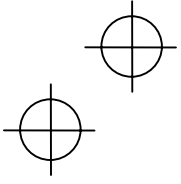

DENSO WAVE INCORPORATED

4-2-12, Toranomom, Minato-ku, Tokyo, Japan 105-0001

<http://www.denso-wave.com/>

496487-5123

