

# **DeVILBISS AIR POWER COMPANY**

## **Pressure Washers**

---

## **OPERATOR'S MANUAL**

---

SAFETY • ASSEMBLY • OPERATION • MAINTENANCE • STORAGE •  
TROUBLESHOOTING • QUICK FACTS



Register your product on line at  
[www.devap.com](http://www.devap.com)

---

### **▲ WARNING**

Read Operator's Manual. Do not operate equipment until you have read this Operator's Manual for **Safety, Assembly, Operation, and Maintenance Instructions**.

---

# TABLE OF CONTENTS

SAFETY GUIDELINES - DEFINITIONS . . . . .	2	Quick Connect . . . . .	11
IMPORTANT SAFETY INSTRUCTIONS . . . . .	3-4	How to Siphon Chemicals/Cleaning Solvents . .	12
FREQUENTLY ASKED QUESTIONS . . . . .	5	Starting . . . . .	12
OWNER'S RESPONSIBILITIES . . . . .	6	Shutting Down Your Pressure Washer . . . . .	13
PRESSURE WASHER SERVICE POLICY . . . . .	6	<b>MAINTENANCE</b> . . . . .	13-15
BOX CONTENTS . . . . .	7	Engine . . . . .	13
ASSEMBLY . . . . .	8	Pump . . . . .	13
OPERATION . . . . .	9-13	Pump Maintenance Chart . . . . .	14
Basic Elements of a Pressure Washer . . . . .	9	Nozzle Cleaning . . . . .	14
Basic Elements of Engine . . . . .	9	Water Inlet Screen Cleaning . . . . .	15
Pressure Washer Terminology . . . . .	9	To Change Oil in Pump . . . . .	15
Pressure Washer Operating Features . . . . .	9-10	DAPC Axial Cam . . . . .	15
Bypass Mode . . . . .	9	Annovi Reverberi . . . . .	15
Chemical Flow Adjustment . . . . .	9	CAT . . . . .	15
Thermal Relief Valve . . . . .	10	<b>STORAGE</b> . . . . .	16
Pressure Adjustment . . . . .	10	<b>TROUBLESHOOTING GUIDE</b> . . . . .	17-18
How to Use Wand . . . . .	10	<b>WARRANTY STATEMENT</b> . . . . .	19
Multi-Reg . . . . .	10	<b>QUICK FACTS</b> . . . . .	Back Cover

**⚠ WARNING** Read Operator's Manual. Do not operate equipment until you have read Operator's Manual for **Safety, Assembly, Operation, and Maintenance Instructions.**

**⚠ WARNING** This product may not be equipped with a spark arresting muffler. If the product is not equipped and will be used around flammable materials, or on land covered with materials such as agricultural crops, forest, brush, grass, or other similar items, then an approved spark arrester must be installed and is legally required in the state of California. It is a violation of California statutes section 130050 and/or sections 4442 and 4443 of the California Public Resources Code, unless the engine is equipped with a spark arrester, as defined in section 4442, and maintained in effective working order. Spark arresters are also required on some U.S. Forest Service land and may also be legally required under other statutes and ordinances.

Engine exhaust contains chemicals known, in certain quantities, to cause cancer, birth defects or other reproductive harm.

## SAFETY GUIDELINES - DEFINITIONS

This manual contains information that is important for you to know and understand. This information relates to protecting **YOUR SAFETY** and **PREVENTING EQUIPMENT PROBLEMS**. To help you recognize this information, we use the symbols below. Please read the manual and pay attention to these sections.



<p><b>⚠ DANGER</b> indicates an imminently hazardous situation which, if not avoided, <u>will</u> result in <b>death or serious injury</b>.</p>	<p><b>⚠ CAUTION</b> indicates a potentially hazardous situation which, if not avoided, <u>may</u> result in <b>minor or moderate injury</b>.</p>
<p><b>⚠ WARNING</b> indicates a potentially hazardous situation which, if not avoided, <u>could</u> result in <b>death or serious injury</b>.</p>	<p><b>CAUTION</b> used without the safety alert symbol indicates a potentially hazardous situation which, if not avoided, <u>may</u> result in <b>property damage</b>.</p>





10/2/97

# IMPORTANT SAFETY INSTRUCTIONS

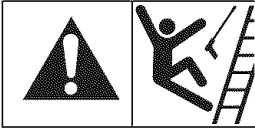
## ⚠ WARNING

**IMPROPER OPERATION OR MAINTENANCE OF THIS PRODUCT COULD RESULT IN SERIOUS INJURY AND PROPERTY DAMAGE. READ AND UNDERSTAND ALL WARNINGS AND OPERATING INSTRUCTIONS BEFORE USING.**

HAZARD	WHAT CAN HAPPEN	HOW TO PREVENT IT
<div style="text-align: center; background-color: black; color: white; padding: 5px; margin-bottom: 5px;"> <b>⚠ DANGER</b>  <b>RISK OF EXPLOSION OR FIRE</b> </div> 	<ul style="list-style-type: none"> <li>Spilled gasoline and its vapors can become ignited from cigarette sparks, electrical arcing, exhaust gases, and hot engine components such as the muffler.</li> <li>Heat will expand fuel in the tank which could result in spillage and possible fire explosion.</li> <li>Operating the pressure washer in an explosive environment could result in a fire.</li> <li>Materials placed against or near the pressure washer can interfere with its proper ventilation features causing overheating and possible ignition of the materials.</li> <li>Muffler exhaust heat can damage painted surfaces, melt any material sensitive to heat (such as siding, plastic, rubber, or vinyl), and damage live plants.</li> <li>Improperly stored fuel could lead to accidental ignition. Fuel improperly secured could get into the hands of children or other unqualified persons.</li> <li>Use of acids, toxic or corrosive chemicals, poisons, insecticides, or any kind of flammable solvent with this product could result in serious injury or death.</li> </ul>	<ul style="list-style-type: none"> <li>Shut off engine and allow it to cool before adding fuel to the tank.</li> <li>Use care in filling tank to avoid spilling fuel. Move pressure washer away from fueling area before starting engine.</li> <li>Keep maximum fuel level 1/2" below top of tank to allow for expansion.</li> <li>Operate and fuel equipment in well ventilated areas free from obstructions. Equip areas with fire extinguishers suitable for gasoline fires.</li> <li>Never operate pressure washer in an area containing dry brush or weeds.</li> <li>Always keep pressure washer a minimum of four feet away from surfaces (such as houses, automobiles, or live plants) that could be damaged from muffler exhaust heat.</li> <li>Store fuel in an OSHA approved container, in a secure location away from work area.</li> <li>Do not spray flammable liquids</li> </ul>
<div style="text-align: center; background-color: black; color: white; padding: 5px; margin-bottom: 5px;"> <b>⚠ DANGER</b>  <b>RISK TO BREATHING</b> </div> 	<ul style="list-style-type: none"> <li>Breathing exhaust fumes will cause serious injury or death.</li> <li>Some cleaning fluids contain substances which could cause injury to skin, eyes, or lungs.</li> </ul>	<ul style="list-style-type: none"> <li>Operate pressure washer in a well ventilated area. Avoid enclosed areas such as garages, basements ,etc.</li> <li>Never operate unit in a location occupied by humans or animals.</li> <li>Use only cleaning fluids specifically recommended for high pressure washers. Follow manufacturers recommendations. Do not use chlorine bleach or any other corrosive compound</li> </ul>
<div style="text-align: center; background-color: black; color: white; padding: 5px; margin-bottom: 5px;"> <b>⚠ WARNING</b>  <b>RISK OF UNSAFE OPERATION</b> </div> 	<ul style="list-style-type: none"> <li>Unsafe operation of your pressure washer could lead to serious injury or death to you or others.</li> <li>If proper starting procedure is not followed, engine can kickback causing serious hand and arm injury.</li> <li>The spray gun/wand is a powerful cleaning tool that could look like a toy to a child.</li> <li>Reactive force of spray will cause gun/wand to move, and could cause the operator to slip or fall, or misdirect the spray. Improper control of gun/wand can result in injuries to self and others.</li> </ul>	<ul style="list-style-type: none"> <li>Become familiar with the operation and controls of the pressure washer.</li> <li>Keep operating area clear of all persons, pets, and obstacles.</li> <li>Do not operate the product when fatigued or under the influence of alcohol or drugs. Stay alert at all times.</li> <li>Never defeat the safety features of this product.</li> <li>Do not operate machine with missing, broken, or unauthorized parts.</li> <li>Never leave wand unattended while unit is running.</li> <li>If engine does not start after two pulls, squeeze trigger of gun to relieve pump pressure. Pull starter cord slowly until resistance is felt. Then pull cord rapidly to avoid kickback and prevent hand or arm injury.</li> <li>Keep children away from the pressure washer at all times.</li> <li>Do not overreach or stand on an unstable support. Grip gun/wand firmly with both hands. Expect the gun to kick when triggered.</li> </ul>

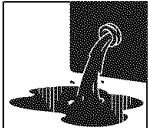
HAZARD	WHAT CAN HAPPEN	HOW TO PREVENT IT
<p><b>⚠ WARNING</b></p> <p><b>RISK OF ELECTRICAL SHOCK</b></p> 	<ul style="list-style-type: none"> <li>• Spray directed at electrical outlets or switches, or objects connected to an electrical circuit, could result in a fatal electrical shock.</li> </ul>	<ul style="list-style-type: none"> <li>• Unplug any electrically operated product before attempting to clean it. Direct spray away from electric outlets and switches.</li> </ul>
<p><b>⚠ WARNING</b></p> <p><b>RISK TO FLUID INJECTION</b></p> 	<ul style="list-style-type: none"> <li>• Your washer operates at fluid pressures and velocities high enough to penetrate human and animal flesh, which could result in amputation or other serious injury. Leaks caused by loose fittings or worn or damaged hoses can result in injection injuries. <b>DO NOT TREAT FLUID INJECTION AS A SIMPLE CUT!</b> See a physician immediately!</li> <li>• Relieve system pressure before attempting maintenance or disassembly of equipment.</li> </ul>	<ul style="list-style-type: none"> <li>• Never place hands in front of nozzle.</li> <li>• Direct spray away from self and others.</li> <li>• Make sure hose and fittings are tightened and in good condition. Never hold onto the hose or fittings during operation.</li> <li>• Do not allow hose to contact muffler.</li> <li>• Never attach or remove wand or hose fittings while system is pressurized.</li> <li>• Use only hose and high pressure accessories rated for pressure higher than your pressure washer's p.s.i.</li> <li>• To relieve system pressure, shut off engine, turn off water supply, and pull gun trigger until water stops flowing.</li> </ul>
<p><b>⚠ WARNING</b></p> <p><b>RISK OF CHEMICAL BURN</b></p> 	<ul style="list-style-type: none"> <li>• Use of acids, toxic or corrosive chemicals, poisons, insecticides, or any kind of flammable solvent with this product could result in serious injury or death.</li> </ul>	<ul style="list-style-type: none"> <li>• Do not use acids, gasoline, kerosene, or any other flammable materials in this product. Use only household detergents, cleaners and degreasers recommended for use in pressure washers.</li> <li>• Wear protective clothing to protect eyes and skin from contact with sprayed materials.</li> <li>• Do not use chlorine bleach or any other corrosive compound.</li> </ul>
<p><b>⚠ WARNING</b></p> <p><b>RISK OF HOT SURFACES</b></p> 	<ul style="list-style-type: none"> <li>• Contact with hot surfaces, such as engines exhaust components, could result in serious burn.</li> </ul>	<ul style="list-style-type: none"> <li>• During operation, touch only the control surfaces of the pressure washer. Keep children away from the pressure washer at all times. They may not be able to recognize the hazards of this product.</li> </ul>
<p><b>⚠ DANGER</b></p> <p><b>RISK OF INJURY AND PROPERTY DAMAGE WHEN TRANSPORTING OR STORING</b></p> 	<ul style="list-style-type: none"> <li>• Fuel or oil can leak or spill and could result in fire or breathing hazard, serious injury or death can result. Fuel or oil leaks will damage carpet, paint or other surfaces in vehicles or trailers.</li> </ul>	<ul style="list-style-type: none"> <li>• If pressure washer is equipped with a fuel shut-off valve, turn the valve to the off position before transporting to avoid fuel leaks. If pressure washer is not equipped with a fuel shut-off valve, drain the fuel from tank before transporting. Only transport fuel in an OSHA approved container. Always place pressure washer on a protective mat when transporting to protect against damage to vehicle from leaks. Remove pressure washer from vehicle immediately upon arrival at your destination.</li> </ul>

**⚠ CAUTION** The powerful spray from your pressure washer is capable of causing damage to surfaces such as wood, glass, automobile paint, auto striping and trim, and delicate objects such as flowers and shrubs. Before spraying, check the item to be cleaned to assure yourself that it is strong enough to resist damage from the force of the spray. Avoid the use of the concentrated spray stream except for very strong surfaces like concrete and steel.

Operating without flow of water will result in equipment damage. Operating the pressure washer with water supply shutoff will void your warranty. You should never run this pressure washer for more than 2 minutes without pulling the trigger to allow cool water to enter the pump and the heated (recirculated) water to exit.

# FREQUENTLY ASKED QUESTIONS

## ***What kind of oil do I use?***

- Engine: Refer to Engine manual for oil recommendations.
- Pump: See page 12 and 13.

## ***My Pressure Washer won't start..(See Engine manual for starting instructions)***

- Has gasoline been added to the engine?
- Is engine on/off switch in "on" position? (If applicable)
- Has engine been primed or choked?
- Adequate amount of oil in engine? (Some models are equipped with a "Low Oil Shut Down" switch)
- Is fuel valve in the "Open" position. (if applicable)
- Pull trigger on spray gun to release pressure.

## ***How do I apply chemicals?***

- Wand must be in the low pressure setting. See page 10 and 11.
- Chemical hose must be attached to pump and fully submerged in chemical/soap-See page 11.
- Chemical adjustment knob (if equipped) must be in open position. See page 9.

## ***How do I adjust the pressure?***

### ***(only on models equipped with an adjustable pressure regulator)***

- The pressure unloader is factory pre-set at the maximum pressure and should not be increased. The pressure can be lowered by following the instructions on page 10. **Do not** attempt to increase the engine speed to achieve a higher pressure. Excessive pressure will damage the pump.

## ***I don't have enough pressure...***

- Do you have an adequate water supply (5 gallons per minute at 20 p.s.i.)?
- All hoses free of kinks and leaks?
- Is wand in high pressure setting? See page 10 and 11.
- Is spray nozzle blocked or partially obstructed? If so, clear and replace. See page 14.
- Do not use a high pressure hose longer than 100 feet?
- Has unit ran for a long period of time without pulling the spray gun trigger? If so see an Authorized Warranty Service Center

## ***What type of chemicals/soaps can I use?***

- Use only chemicals/soap designed for use in pressure washers.
- Do not use chlorine bleach or any other corrosive compound; this will cause damage to the pump.

## ***Who can I call if I have questions or any problems?***

- Call us at 1-800-888-2468, Extension 2, Monday through Saturday, 8:00 a.m. to 6:00 p.m., C.S.T.

## ***How do I drain the oil?***

- Engine: Refer to the Engine manual for this information.
- Pump: See page 13.

## ***Where can I purchase parts and/or accessories?***

- Service parts can be obtained through our many Authorized Warranty Service Centers. For the location of the nearest Authorized Warranty Service Center call 1-800-888-2468, Ext. 2, 24 hours a day, 7 days a week or visit our web site @ devap.com.
- Accessories can be purchased at an Authorized Warranty Service Center or at one of the many local retailers.

## OWNER'S RESPONSIBILITIES

- **DO NOT RETURN THIS PRODUCT TO THE RETAILER! Call 1-800-888-2468, Ext. 2.**
- Read and understand all safety warnings.
- Read this Owner's Manual.
- Do not operate this unit until you have read this Owners Manual for Safety, Operation, and Maintenance Instructions.
- Read the Engine Owner's Manual supplied with this unit.
- Do not operate this unit until you have read the Engine Owners Manual for Safety, Operation, and Maintenance Instructions.
- Check for visible shipping damage. Shipping damage will cause problems in operation of this unit.
- If you experience any problems and need assistance, please call us at our toll free number 1-800-888-2468, Ext 2, 8:00 a.m. to 8:00 p.m. C.S.T.
- If you need warranty repair or service part purchase, you can locate an Authorized Warranty Service Center nearest you by calling us at 1-800-888-2468, Ext 2, 1, 24 hours a day, 7 days a week.

## PRESSURE WASHER SERVICE POLICY

- Congratulations! You have purchased a high quality product from America's leading manufacturer of pressure washers. This pressure washer, when properly used and maintained, will provide trouble free service. Please read and follow these instructions for proper use and maintenance.
- All sales of pressure washers are final. Do not return this product to the retailer.
- If you experience any problems and need assistance, please call us at our toll free number **1-800-888-2468, Ext 2. Monday through Saturday, 8:00 a.m. To 6:00 p.m. C.S.T.**
- If repair or service part purchase is required, our many Authorized Warranty Service Centers are conveniently located and equipped to handle all in-warranty and out-of-warranty service.
- For the location of the nearest Authorized Warranty Service Center call 1-800-888-2468, Ext. 2, 24 hours a day, 7 days a week or visit our web site @ devap.com.
- All pressure washers carry a manufacturer's one year warranty from date of purchase for consumer use and a 90 day warranty for commercial use.
- Retain sales receipt as proof of purchase for warranty service.

# BOX CONTENTS

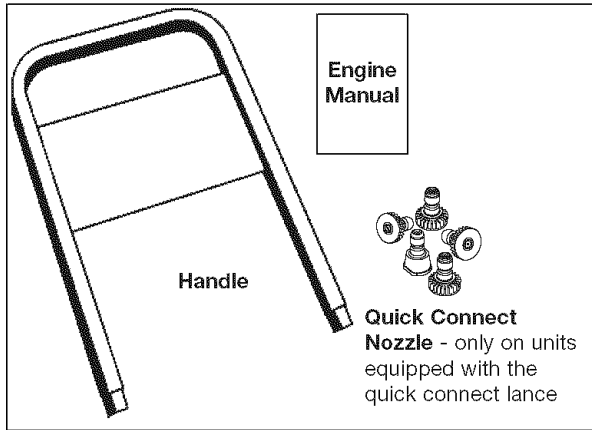

Bagged Handle

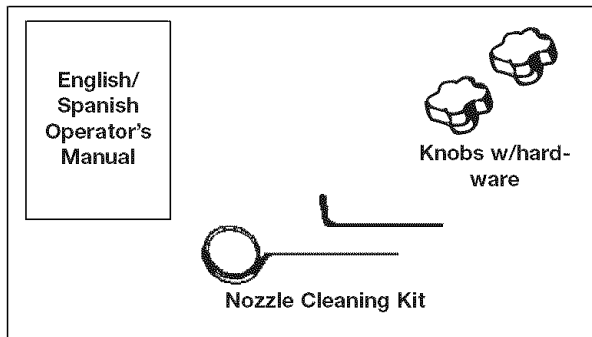
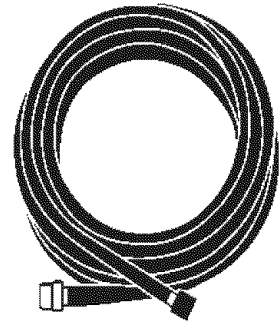
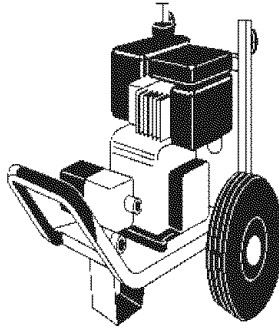

Bagged Parts

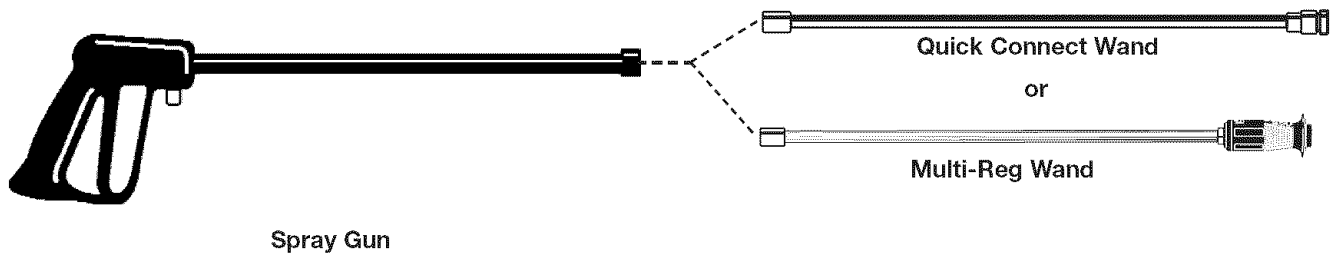
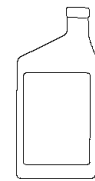
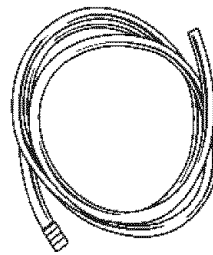

# ASSEMBLY

1. Connect handle to frame.

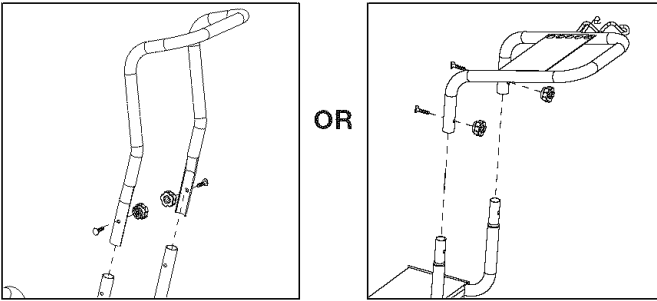

2. Connect wand to gun. Tighten securely.

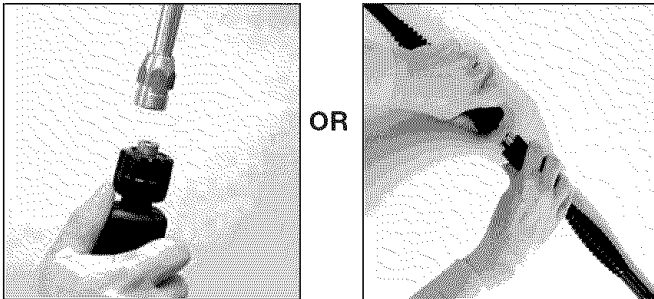

3. Attach high pressure hose to gun. **NOTE:** The point of attachment for the high pressure hose will differ depending on the model purchased. Tighten securely.

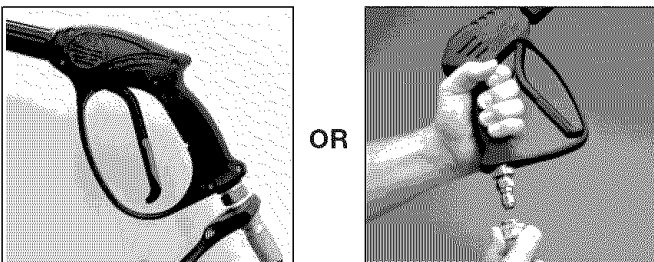

4. Add engine oil (supplied) to engine. Refer to engine manual supplied by engine manufacturer for procedure. Do not overfill. Use of a funnel is recommended.

**NOTE:** There will be a slight amount of oil in the engine from factory testing.

**NOTE:** The pump was filled with oil at the factory. There is no need to add oil at this time, see the Maintenance section of this manual to perform maintenance on this pump.

## TO ASSEMBLE ACCESSORIES PANEL (if equipped)

1. Remove top screws on handle assembly.
2. Loosen bottom screws on handle assembly.

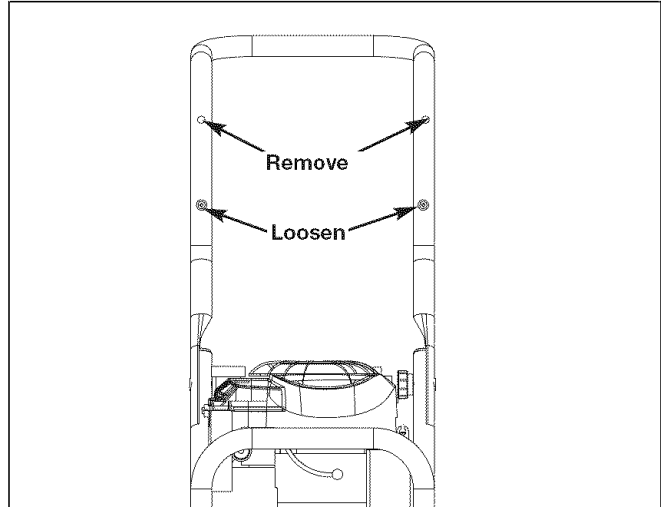

3. Place grooves in accessories panel assembly onto screws and slide panel assembly into place.
4. Place screws (removed earlier) into the top holes and secure accessories panel assembly to handles. Do not overtighten.

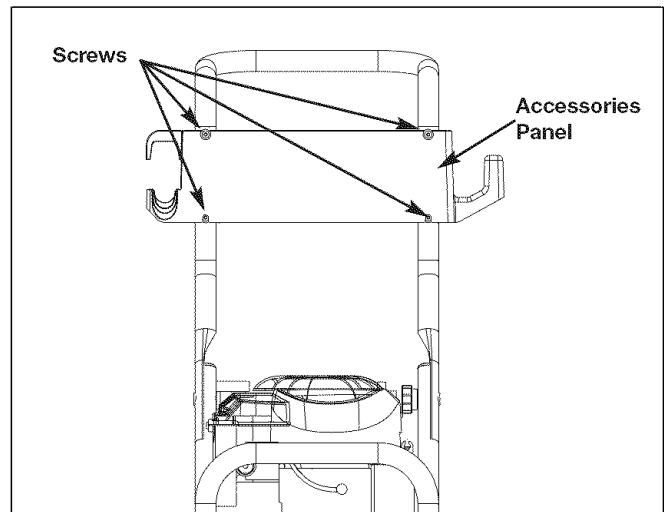



# OPERATION

## BASIC ELEMENTS OF A PRESSURE WASHER

**High Pressure Pump:** Increases the pressure of the water supply.

**Engine:** Drives the high pressure pump.

**High Pressure Hose:** Carries the pressurized water from the pump to the gun and wand.

**Spray Gun:** Connects with wand to control water flow rate, direction, and pressure.

**Wand:**

**Multi-Reg wand:** Has a spray nozzle which adjust from a pencil stream (0°) to a wide angle fan spray (60°). The spray can be adjusted by twisting the nozzle clockwise and/or counterclockwise. Also, the high and low pressure settings can be controlled by moving the nozzle in and out. See Operation section.

**Quick Connect:** This type of lance is equipped with a female quick connect coupler on the end. This allows the user to quickly change out high-pressure nozzles for different spray patterns and change to the soap nozzle for low pressure and chemical/soap applications. See Operation section.

**Chemical Hose:** Allows cleaners or cleaning solvents to be mixed with the pressurized water stream. See How To Siphon Chemicals/Cleaning Solvents in Operation section of this manual.

## BASIC ELEMENTS OF ENGINE

**Choke Control (if equipped):** Opens and closes the choke valve in carburetor.

**Primer Button (if equipped):** Primes carburetor with fuel.

**Throttle Control Lever:** Controls engine speed.

**Starter Grip:** Pulling starter grip operates recoil starter to crank engine.

**Fuel Valve Lever (if equipped):** Opens and closes connection between fuel tank and carburetor.

**Engine Switch (if equipped):** Enables and disables ignition system.

## PRESSURE WASHER TERMINOLOGY

**PSI:** Pounds per Square Inch. The unit of measure for water pressure. Also used for air pressure, hydraulic pressure, etc.

**GPM:** Gallons Per Minute. The unit of measure for the flow rate of water through the pressure washer.

**CU:** Cleaning Units. GPM multiplied by PSI.

**Bypass Mode:** In Bypass Mode, the pump is recirculating water because the trigger of the spray gun is not pulled.

**Chemical Injection:** Feeds cleaning agents into the pump to mix with the pressurized water and help in cleaning.

**Water Supply:** All pressure washers must have a source of water. The minimum requirements for a water supply are 20 PSI and 5 gallons per minute.

### CAUTION

Any supply pressure or delivery rate less than this will not allow the pressure washer to operate at its full potential and may cause damage to the pump.

## PRESSURE WASHER OPERATING FEATURES

### Bypass Mode

During normal operation the water supply is turned on, engine is running, spray gun trigger is depressed, and the cold water supply circulates inside the pressure washer pump allowing pump to maintain a safe operating temperature. When you release spray gun trigger and engine is still running, you are in bypass mode.

When unit is in bypass mode, water circulating inside the pump begins to heat up. If unit is left in bypass mode for more than two (2) minutes, the water temperature will rise to a dangerous level and damage internal components of the pump.

If pressure washer is operated without an adequate water supply or operated for more than two (2) minutes without depressing the spray gun trigger, the pump will overheat and be seriously damaged. Any damage to pump due to these causes will not be covered under warranty.

### Chemical Flow Adjustment

Some pumps are equipped with an adjustable chemical injector as shown here. Turn the chemical adjustment knob counterclockwise to increase the amount of chemical used and clockwise to decrease the

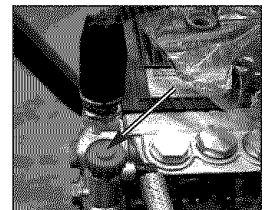

amount of chemical used. If the knob is turned clockwise until it stops, the chemical injector will close and will not draw any chemicals/soaps.

## Thermal Relief Valve

In an effort to prevent damage, pumps are equipped with a thermal relief valve. This valve will open when the temperature inside the pump rises too high. This valve will then release a gush of water in an effort to lower the temperature inside the pump. Immediately after this occurs, the valve will close.

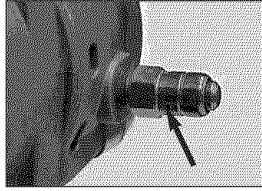
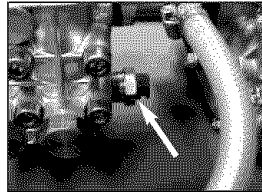

### **CAUTION** DO NOT

allow your unit to operate in bypass mode for more than two minutes at any time. Overheating of pump will cause damage to pump.

## Pressure Adjustment

The pressure setting is preset at the factory to achieve optimum pressure and cleaning. If you need to lower the pressure, it can be accomplished by these methods.

1. Back away from the surface to be cleaned. The further away you are, the less the pressure will be on the surface to be cleaned.
2. Reduce the speed of the gasoline engine (RPM). Slow the engine down and the water pressure will go down with it.

Step 3 is only for models without an automatic pressure regulator.

3. Adjust the pressure regulator on the pump. Turn the pressure regulator knob counterclockwise to lower pressure. Refer to the illustrations to identify your pressure regulator.

Once you have finished using your pressure washer, return the pressure regulator to its original position by turning it clockwise.

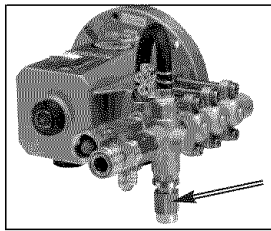
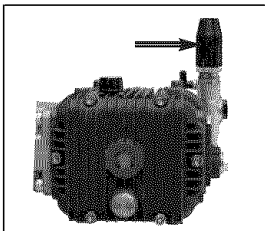

**CAUTION** DO NOT attempt to increase pump pressure. A higher pressure setting than the factory set pressure may damage pump.

**CAUTION** DO NOT try to turn pressure regulator knob past the built-in stop or damage to pump will result.

## HOW TO USE WAND

See the Box Contents to determine if your unit is equipped with a multi-reg or quick connect wand.

### For Multi-Reg Wands:

Your pressure washer is equipped with a multi-reg wand with both high and low pressure settings. The high pressure setting is for cleaning and rinsing, the low pressure setting is for applying chemicals or cleaning solutions to surfaces.

**WARNING** RISK OF INJECTION OR INJURY TO PERSON. DO NOT DIRECT DISCHARGE STREAM TOWARD PERSONS.

**DANGER** WHEN USING THE HIGH PRESSURE SETTING, DO NOT ALLOW THE JET-LIKE SPRAY TO COME IN CONTACT WITH UNPROTECTED SKIN, EYES, OR WITH ANY PETS OR ANIMALS. SERIOUS INJURY CAN OCCUR.

For high pressure operation, pull back the nozzle of the multi-reg wand as shown.

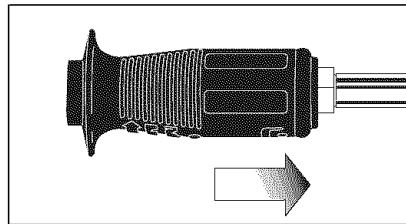

The nozzle at the end of the multi-reg wand can be rotated to change the high pressure spray pattern from a narrow jet to a 40° fan shape, as shown. Markings have been placed on the nozzle to help you select the spray pattern.

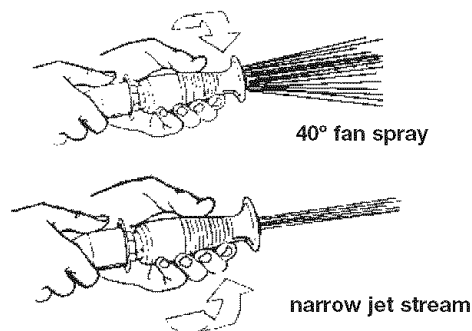

For low pressure operation, extend the nozzle of the multi-reg wand as shown.

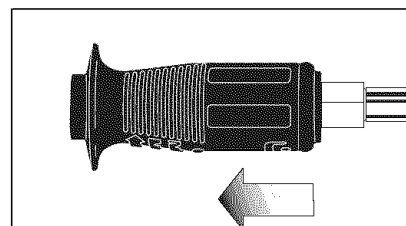

## For Quick-Connect Wands:

### Spray Nozzles

Your pressure washer is equipped with up to five spray nozzles. Each nozzle is color coded and delivers a specific spray pattern for a particular cleaning purpose. The size of the nozzle determines the size of the fan spray and the pressure out of the nozzle. The 0°, 15°, 25°, and 40° nozzles are high pressure nozzles. The chemical nozzle is a low pressure nozzle.

The nozzles are housed in receptacles on the panel of the pressure washer handle. Color squares on the panel identify nozzle location and spray pattern.

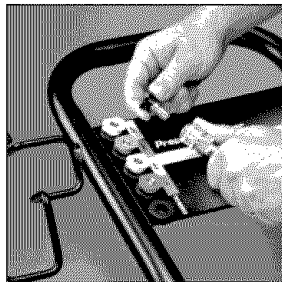

**⚠ DANGER** WHEN USING THE HIGH PRESSURE NOZZLES, DO NOT ALLOW THE JET-LIKE SPRAY TO COME IN CONTACT WITH UNPROTECTED SKIN, EYES, OR WITH ANY PETS OR ANIMALS. SERIOUS INJURY CAN OCCUR.

**0° nozzle - Red.** This nozzle delivers a pinpoint stream and is extremely powerful. It covers a very small area of cleaning. This nozzle should only be used on surfaces that can withstand this high pressure such as metal or concrete. Do not use on wood.

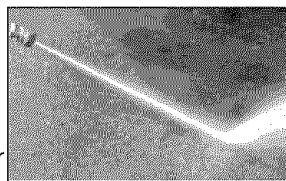

**15° nozzle - Yellow.** This nozzle delivers a powerful 15 degree spray pattern for intense cleaning of small areas. This nozzle should only be used on areas that can withstand the high pressure from this nozzle.



**25° nozzle - Green.** This nozzle delivers a 25 degree spray pattern for intense cleaning of larger areas. This nozzle should only be used on areas that can withstand the pressure from this nozzle.

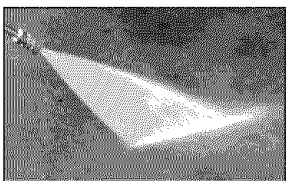

**40° nozzle - White.** This nozzle delivers a 40 degree spray pattern and a less powerful stream of water. It covers a wide area of cleaning. This nozzle should be used for most general cleaning jobs.

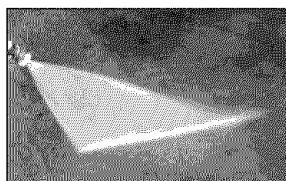

**Chemical nozzle - Black.** This nozzle is used to apply chemicals or cleaning solutions. It has the least powerful stream.

### Changing Nozzles

**⚠ CAUTION** DO NOT attempt to change nozzles while pressure washer is running. Turn engine off before changing nozzles.

1. Pull quick connect coupler back and insert nozzle.
2. Release quick connect coupler and twist nozzle to make sure it is secure in coupler.

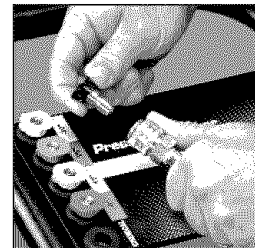

## HOW TO SIPHON CHEMICALS/CLEANING SOLVENTS

Siphoning chemicals or cleaning solvents is a low pressure operation.

**NOTE:** Use only soaps and chemicals designed for pressure washer use. Do not use bleach.

To siphon chemicals:

1. Press chemical hose onto barbed fitting located near high pressure hose connection of pump as shown.
2. Place other end of chemical hose with filter on it into container holding chemical/cleaning solution.

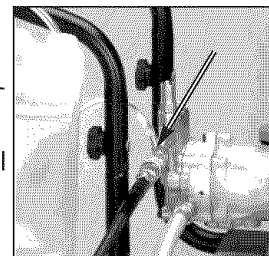

3. **On multi-reg:**

Set multi-reg nozzle to low pressure setting, see **How To Use Wand** paragraph in this section.

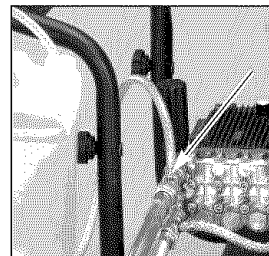

**On quick connect wand:**

Install low pressure (black) nozzle into quick connect fitting of wand, see **How To Use Wand** paragraph in this section.

4. After use of chemical, siphon clean water through chemical hose to rinse it and pump clean. Chemicals which remain in pump can damage it. Damage to pump due to chemicals will not be covered under warranty.

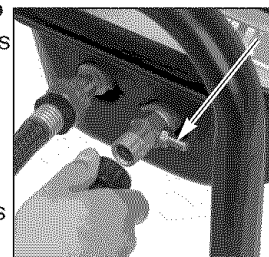

**NOTE:** Chemicals and soap will not siphon when using high pressure nozzles.

# STARTING

1. Add fresh high quality unleaded gasoline.

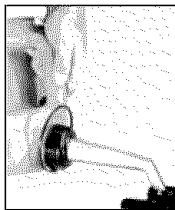

**⚠ WARNING** Never fill fuel tank indoors. Never fill fuel tank when engine is running or hot. Do not smoke when filling fuel tank.

**⚠ WARNING** Never fill fuel tank completely. Fill tank to 1/2" below bottom of filler neck to provide space for fuel expansion. Wipe any fuel spillage from engine and equipment before starting engine.

2. Check engine oil level. See Engine Operator's Manual for correct procedure.

**NOTE:** Some engines are equipped with a low oil sensor and the correct amount of oil must be added or the engine will not start.

3. Verify the filter screen is in water inlet of pump, as shown.

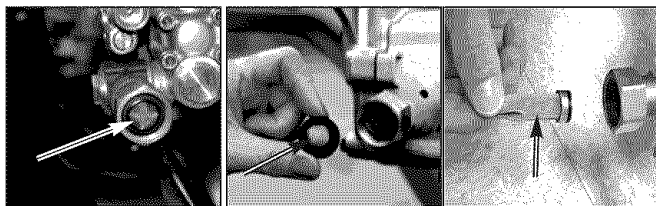

4. Check pump oil level (if applicable—See Maintenance Section.)
5. Connect high pressure hose to pump outlet.

**⚠ CAUTION** Never pull water supply hose to move pressure washer. This could damage hose and/or pump inlet.

6. Connect water source to pump inlet.

**NOTE:** Water source must provide a minimum of 5 gallons per minute at 20 p.s.i.

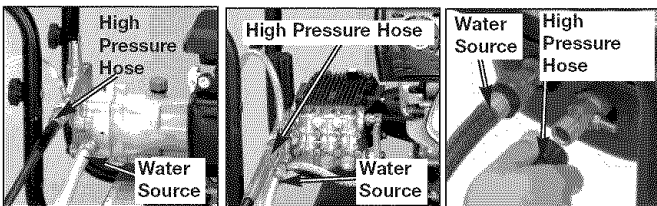

7. If you are applying a chemical or cleaning solution, See **How To Siphon Chemicals/Cleaning Solvents** in Operation section of this manual.

8. Turn water source on.

**NOTE:** Make sure water supply is turned on.

**⚠ CAUTION** DO NOT use hot water, use cold water only.



**⚠ CAUTION** Never turn water supply off while pressure washer engine is running or damage to pump will result.

9. Start engine, see Engine Operator's Manual for correct procedure.

**⚠ WARNING** SOME UNITS ARE NOT EQUIPPED WITH AN E-Z START VALVE. ON THESE UNITS PRESSURE WILL BUILD IN THE HOSE IF THE ENGINE DOES NOT START AFTER TWO PULLS. IF THE ENGINE DOES NOT START AFTER TWO PULLS, PULL THE TRIGGER TO RELIEVE THE PRESSURE. FAILURE TO DO SO MAY CAUSE DAMAGE TO THE STRAIN RECOIL MECHANISM.

**⚠ WARNING** NEVER RUN ENGINE INDOORS OR IN ENCLOSED, POORLY VENTILATED AREAS. ENGINE EXHAUST CONTAINS CARBON MONOXIDE, AN ODORLESS AND DEADLY GAS.

**⚠ WARNING** DO NOT LET HOSES COME IN CONTACT WITH VERY HOT ENGINE MUFFLER DURING OR IMMEDIATELY AFTER USE OF YOUR PRESSURE WASHER. DAMAGE TO HOSES FROM CONTACT WITH HOT ENGINE SURFACES WILL NOT BE COVERED BY WARRANTY.

10. Depress trigger on gun to start water flow. Release trigger to stop water flow.

**⚠ WARNING** STAND ON A STABLE SURFACE AND GRIP GUN/WAND FIRMLY WITH BOTH HANDS. EXPECT THE GUN TO KICK WHEN TRIGGERED.

11. Adjust nozzle spray for the task being performed. See **How To Use Wand** instructions in this section.

**⚠ CAUTION** DO NOT STOP SPRAYING WATER FOR MORE THAN TWO MINUTES AT A TIME. PUMP OPERATES IN BYPASS MODE WHEN SPRAY GUN TRIGGER IS NOT PRESSED. IF PUMP IS LEFT IN BYPASS MODE FOR MORE THAN TWO MINUTES INTERNAL COMPONENTS OF THE PUMP CAN BE DAMAGED.

**⚠ DANGER** WHEN USING THE HIGH PRESSURE SETTING, DO NOT ALLOW THE HIGH PRESSURE SPRAY TO COME IN CONTACT WITH UNPROTECTED SKIN, EYES, OR WITH ANY PETS OR ANIMALS. SERIOUS INJURY CAN OCCUR.

## SHUTTING DOWN

1. If you have siphoned chemicals, siphon a bucket of clean water through the chemical hose. **NOTE:** Failure to do so will cause damage to the pump.
2. Turn engine off. See Engine Owner's Manual.

**NOTE: NEVER turn the water off with the engine running.**

**⚠ CAUTION** Never turn water supply off while pressure washer engine is running or damage to pump will result.

3. Turn water source off.
4. Pull trigger on spray gun to relieve any water pressure in hose or spray gun.
5. See Storage section in this manual for proper storage procedures.

## MAINTENANCE

**⚠ DANGER** WHEN PERFORMING MAINTENANCE, YOU MAY BE EXPOSED TO HOT SURFACES, WATER PRESSURE, MOVING PARTS, OR FIRE RESULTING IN DEATH. BEFORE PERFORMING ANY MAINTENANCE OR REPAIR, DISCONNECT SPARK PLUG WIRE, LET ENGINE COOL AND RELEASE ALL WATER PRESSURE. THE ENGINE CONTAINS FLAMMABLE FUEL. DO NOT SMOKE OR WORK NEAR OPEN FLAMES WHILE PERFORMING MAINTENANCE.

To ensure efficient operation and longer life of your pressure washer, a routine maintenance schedule should be prepared and followed. If the pressure washer is used in unusual conditions, such as high-temperatures or dusty conditions, more frequent maintenance checks will be required.

## ENGINE

1. Consult the Engine Owners Manual for the manufacturer's recommendations for any and all maintenance.

DAPC Axial Cam

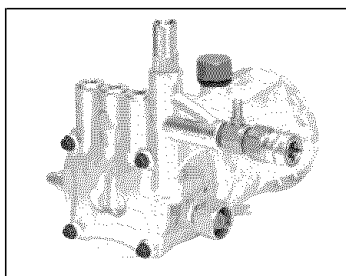

Annovi Reverberi

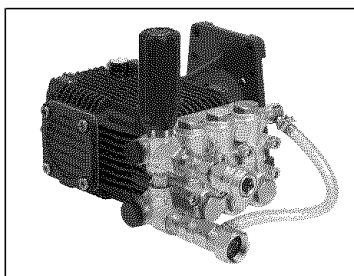

## PUMP

1. Pump oil (checking and changing). Refer to the following illustrations to identify which pump is on your pressure washer. Refer to the chart for oil type, oil capacity, and maintenance schedule (if applicable).

DAPC Radial

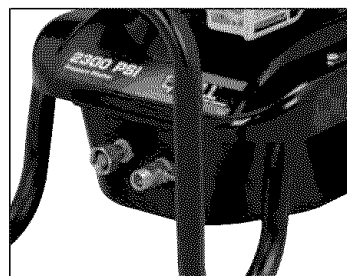

Cat

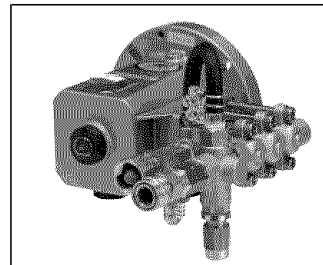

# PUMP MAINTENANCE CHART

PUMP TYPE	OIL TYPE	OIL CAPACITY	CHANGE OIL	
			First 10 hours	after every 50 hours
Annovi Reverberi (XMV)	30W non detergent	13.5 oz.	x	x
Annovi Reverberi (XRV)	30W non detergent	18.54 oz.	x	x
Annovi Reverberi (XTV)	30W non detergent	9.92 oz.	x	x
Annovi Reverberi (RKV)	30W non detergent	18.54 oz.	x	x
DAPC (axial cam)	* R&O 150	8 oz.	x	x
DAPC (radial)	** none	n/a	n/a	n/a
Cat	30W non detergent	bottom of sight glass	x	x

\* If unable to find use 30 W non detergent  
 \*\* This pump requires no oil, it is an oilfree pump

## NOZZLE CLEANING

If the nozzle becomes clogged with foreign materials, such as dirt, excessive pressure may develop. If the nozzle becomes partially clogged or restricted, the pump pressure will pulsate. Clean the nozzle immediately using the nozzle kit supplied and the following instructions:

### Multi-Reg:

1. Shut off the pressure washer and turn off the water supply.
2. Disconnect spark plug wire.
3. Pull trigger on gun handle to relieve any water pressure.
4. Disconnect the wand from the gun.
5. Remove the nozzle from the end of the wand with the 2mm allen wrench provided as shown.

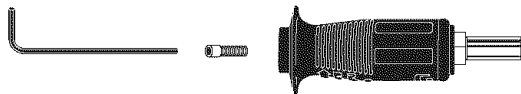

6. Clean the nozzle using the nozzle cleaner provided or a straightened paper clip. Insert into the nozzle end and work back and forth until obstruction is removed.

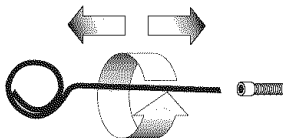

7. Direct water supply into nozzle end to backflush loosened particles for 30 seconds.

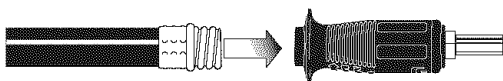

8. Reassemble the nozzle to the wand. Tighten securely to prevent leaks.
9. Reconnect wand to gun and turn on water supply.
10. Start pressure washer and place wand into high pressure setting to test.

### Quick Connect:

1. Shut off the pressure washer and turn off the water supply.
2. Disconnect spark plug wire.
3. Pull trigger on gun handle to relieve any water pressure.
4. Disconnect the wand from the gun.
5. Remove the high-pressure nozzle from the wand. Remove any obstructions with the nozzle cleaning tool provided and backflush with clean water.

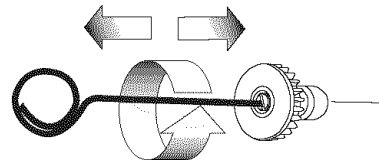

6. Direct water supply into nozzle end to backflush loosened particles for 30 seconds.

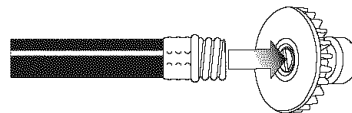

7. Reassemble the nozzle to the wand.
8. Reconnect wand to gun and turn on water supply.
9. Start pressure washer and place wand into high pressure setting to test.

## HOW TO CLEAN THE WATER INLET FILTER

This screen filter should be checked periodically and cleaned if necessary.

1. Remove filter by grasping end and removing it from water inlet of pump as shown.
2. Clean filter by flushing it with water on both sides.
3. Install filter into water inlet of pump

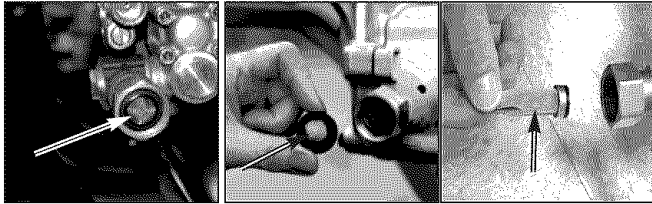

## HOW TO CHANGE PUMP OIL

1. Loosen oil fill cap.
2. Place a container under the oil drain plug.
3. Remove oil drain plug.
4. After oil is drained replace oil drain plug. Tighten securely.
5. Remove oil fill cap and fill with recommended oil. See the Pump Maintenance Chart for the correct amount and type of oil.
6. Replace oil fill cap and tighten securely.

DAPC Axial Cam

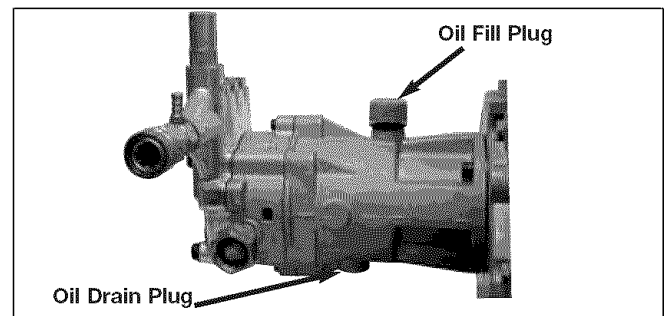

Annovi Reverberi

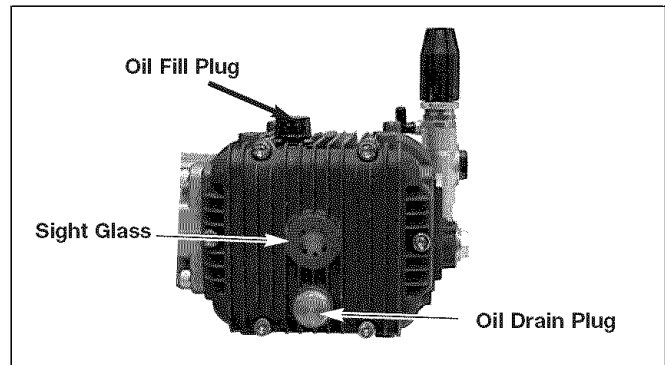

CAT

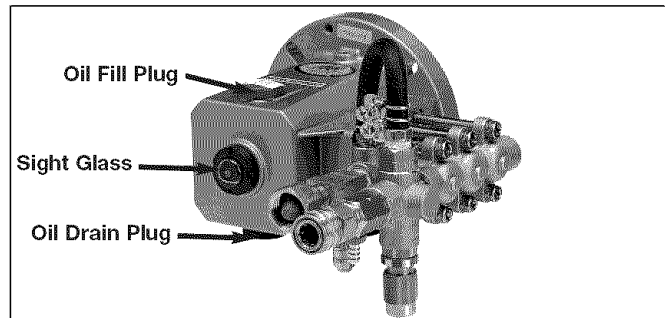

## STORAGE

It is recommended that you follow these steps to protect the internal seals of the pressure washer when **storing the unit for an extended period and WHEN FREEZING TEMPERATURES ARE EXPECTED.**

### ENGINE

1. Consult the Engine Owners Manual for the manufacturer's recommendations for storage.

### PUMP

**NOTE: If storing the unit for more than 30 days RV antifreeze needs to be run through the pump. This helps prevent damage within the pump head. RV antifreeze is not only added for winterizing, but for proper lubrication regardless of temperature or environment. Storing the pump less than 30 days does not require the RV antifreeze.**

1. Obtain a funnel, six ounces of RV antifreeze, and approximately 12 inches of garden hose with a male hose connector attached to one end.

**CAUTION** Use only RV antifreeze. Any other antifreeze is corrosive and can damage pump.

2. Disconnect spark plug wire.
3. Disconnect high pressure hose from pump and from spray gun.
4. Connect 12 inch length of hose to water inlet of pump.

5. Add RV antifreeze to hose as shown.

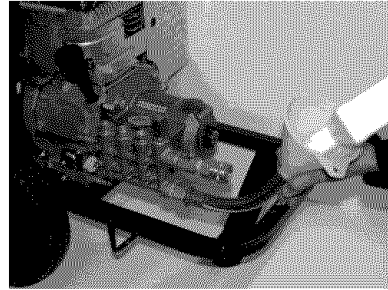

6. Pull engine starter rope slowly several times until antifreeze comes out of high pressure hose connection of pump.
7. Remove short hose from water inlet of pump.
8. Install spark plug into spark plug hole and tighten securely, then reconnect spark plug wire.
9. Drain all water from high pressure hose, coil it, and store it in cradle of the pressure washer handle.
10. Drain all water from spray gun and wand by holding spray gun in a vertical position with nozzle end pointing down and squeezing trigger. Store in gun/hose holder.
11. Store chemical hose, high pressure hose, spray gun, and wand so they are protected from damage, such as being run over.



## TROUBLESHOOTING GUIDE

PROBLEM	CAUSE	CORRECTION
<p>Engine will not start (see Engine Manual for further engine troubleshooting)</p>	<ol style="list-style-type: none"> <li>1. No fuel.</li> <li>2. Low oil (if equipped with low oil shutdown).</li> <li>3. Pressure builds up after two pulls on the recoil starter or after initial use.</li> <li>4. Not primed or choked.</li> <li>5. Spark plug wire not attached.</li> <li>6. Engine <b>ON/OFF</b> switch in <b>OFF</b> position (If equipped.)</li> <li>7. Choke lever in the "Choke" position on a "hot" engine or an engine that has been exposed to thermal heat for a long period of time.</li> <li>8. Fuel valve closed (if equipped)</li> </ol>	<ol style="list-style-type: none"> <li>1. Add Fuel.</li> <li>2. Add required amount of oil.</li> <li>3. Squeeze gun trigger to relieve pressure.</li> <li>4. Push primer bulb 3 times or choke engine.</li> <li>5. Attach spark plug wire.</li> <li>6. Place engine ON/OFF switch in <b>ON</b> position.</li> <li>7. Move choke to the "No Choke" position.</li> <li>8. Move the fuel valve lever to the "Open" position.</li> </ol>
<p>No or low pressure (initial use)</p>	<ol style="list-style-type: none"> <li>1. Wand not in high pressure.</li> <li>2. Low water supply.</li> <li>3. Leak at high pressure hose.</li> <li>4. Nozzle obstructed.</li> <li>5. Water filter screen clogged.</li> <li>6. Defective E-Z start valve. (If applicable)</li> <li>7. Air in hose.</li> <li>8. Choke lever in the "Choke" position.</li> <li>9. Throttle control lever is not in the "Fast" position.</li> <li>10. High pressure hose is too long.</li> </ol>	<ol style="list-style-type: none"> <li>1. See How to Use Wand paragraph in the Operation Section.</li> <li>2. Water supply must be at least 5 GPM @ 20 PSI.</li> <li>3. Repair leak. Apply Teflon tape if necessary.</li> <li>4. Clean nozzle with paper clip or nozzle cleaning tool, pour water into nozzle end to flush out obstruction.</li> <li>5. Remove and clean filter.</li> <li>6. Check with Authorized Warranty Service Center (AWSC.)</li> <li>7. Turn off the engine, then the water source. Disconnect the water source from the pump inlet and turn the water source on to remove all air from the hose. When there is a steady stream of water present, turn water source off. Reconnect water source to pump inlet and turn on water source. Squeeze trigger to remove remaining air.</li> <li>8. Move choke to the "No Choke" position.</li> <li>9. Move throttle control lever to the "Fast" position.</li> <li>10. Use high pressure hose under 100 feet.</li> </ol>
<p>Will not draw chemicals</p>	<ol style="list-style-type: none"> <li>1. Wand not in low pressure.</li> <li>2. Chemical filter clogged.</li> <li>3. Chemical screen not in chemical</li> <li>4. Chemical adjustment knob closed.</li> <li>5. Chemical too thick</li> <li>6. Pressure hose is too long</li> <li>7. Chemical build up in chemical injector.</li> </ol>	<ol style="list-style-type: none"> <li>1. See How to Use Wand paragraph in the Operation Section.</li> <li>2. Clean filter.</li> <li>3. Insure end of chemical hose is fully submerged into chemical.</li> <li>4. Turn knob fully counterclockwise to open.</li> <li>5. Dilute chemical. Chemical should be the same consistency as water.</li> <li>6. Lengthen water supply hose instead of pressure hose.</li> <li>7. Have parts cleaned or replaced by AWSC.</li> </ol>

<b>PROBLEM</b>	<b>CAUSE</b>	<b>CORRECTION</b>
No or low pressure (after period of normal use.)	<ol style="list-style-type: none"> <li>1. Worn seal or packing.</li> <li>2. Worn or obstructed valves.</li> <li>3. Worn unloader piston.</li> <li>4. Worn E-Z start valve.</li> </ol>	<ol style="list-style-type: none"> <li>1. Have replaced by AWSC.</li> <li>2. Have replaced by AWSC.</li> <li>3. Have replaced by AWSC.</li> <li>4. Have replaced by AWSC.</li> </ol>
Water leaking at gun/wand connection	<ol style="list-style-type: none"> <li>1. Worn or broken o-ring.</li> <li>2. Loose hose connection.</li> </ol>	<ol style="list-style-type: none"> <li>1. Check and replace.</li> <li>2. Tighten.</li> </ol>
Water leaking at pump	<ol style="list-style-type: none"> <li>1. Loose connections.</li> <li>2. Piston packings worn.</li> <li>3. Worn or broken o-rings.</li> <li>4. Pump head or tubes damaged from freezing.</li> </ol>	<ol style="list-style-type: none"> <li>1. Tighten.</li> <li>2. Have replaced by AWSC.</li> <li>3. Have replaced by AWSC.</li> <li>4. Have replaced by AWSC.</li> </ol>
Oil leaking at pump (if applicable)	<ol style="list-style-type: none"> <li>1. Oil seals worn.</li> <li>2. Loose drain plug.</li> <li>3. Worn drain plug, o-ring (if applicable).</li> <li>4. Worn fill plug o-ring.</li> <li>5. Pump overfilled.</li> <li>6. Incorrect oil used.</li> <li>7. Vent plug is clogged.</li> </ol>	<ol style="list-style-type: none"> <li>1. Have replaced by AWSC.</li> <li>2. Tighten.</li> <li>3. Check and replace.</li> <li>4. Check and replace.</li> <li>5. Check for correct amount.</li> <li>6. Drain and fill with correct amount and type of oil.</li> <li>7. Clean vent plug; blow air through it to remove any blockage. If problem persists, replace plug.</li> </ol>
Engine will not idle down (if equipped with Idle down assembly)	<ol style="list-style-type: none"> <li>1. Cable is loose from idle down assembly.</li> <li>2. Piston is separated from stem in piston/stem assembly.</li> <li>3. Piston Stem is bent.</li> <li>4. Lack of water supply.</li> </ol>	<ol style="list-style-type: none"> <li>1. Reattach cable.</li> <li>2. Have replaced by AWSC.</li> <li>3. Have replaced by AWSC.</li> <li>4. Water supply must be at least 5 GPM @ 20 PSI</li> </ol>
Water leaking from stem on idle down assembly (if equipped)	<ol style="list-style-type: none"> <li>1. O-rings damaged in idle body assembly.</li> <li>2. Damaged stem.</li> </ol>	<ol style="list-style-type: none"> <li>1. Have replaced by AWSC.</li> <li>2. Have replaced by AWSC.</li> </ol>

## LIMITED WARRANTY

DeVilbiss Air Power Company warrants to the original purchaser that each new pressure washer, service part, and accessory is free from defects in material and workmanship, and agrees to repair or replace under this warranty any defective product or part as follows from the original date of purchase.

1 Year - Consumer applications (i.e. personal residential household usage only).

90 Day - Commercial applications (income producing).

Engine warranties are the responsibility of the engine manufacturer.

**WARRANTY SERVICE** is available by delivering or shipping the defective product or part to any DeVilbiss Air Power authorized warranty service location. To determine the nearest authorized warranty service location, call the toll free number, 1-800-888-2468, Ext 2, 24 hours a day, 7 days a week or visit our web-site at [www.devap.com](http://www.devap.com). Specific instructions regarding servicing arrangements and scheduling may vary depending on the type and size of the product and the availability of repair parts.

- DO NOT return the defective product to the retailer.
- Retain the original cash register receipt as proof of purchase for warranty work.
- Purchasers should contact DeVilbiss Air Power Company directly if they do not receive satisfactory results from the authorized warranty service center.

### **THIS WARRANTY IS NOT TRANSFERABLE AND DOES NOT COVER**

- Products sold damaged or incomplete, sold "as is", sold reconditioned, or used as rental equipment.
- Delivery, installation, or normal adjustments explained in the owner's manual.
- Damage or liability caused by shipping, improper handling, improper installation, improper maintenance, improper modification, or the use of accessories and/or attachments not specifically recommended by DeVilbiss Air Power Company for the product.
- Repairs necessary because of operator abuse or negligence, or the failure to install, operate, maintain, and store the product according to the instructions in the owner's manual.
- Damage caused by cold, heat, rain, excessive humidity, corrosive environments and materials, or other contaminants.
- Cosmetic defects that do not interfere with product functionality.
- Freight costs from customer to DeVilbiss Air Power Company.
- Repair and transportation costs of products or parts determined not to be defective.
- **ANY INCIDENTAL, INDIRECT OR CONSEQUENTIAL LOSS, DAMAGE, OR EXPENSE THAT MAY RESULT FROM ANY DEFECT, FAILURE OR MALFUNCTION OF THIS PRODUCT.** Some states do not allow the exclusion or limitation of incidental or consequential damages, so the above limitation or exclusion may not apply to you.
- **IMPLIED WARRANTIES, INCLUDING THOSE OF MERCHANTABILITY AND FITNESS FOR A PARTICULAR PURPOSE, ARE LIMITED TO ONE YEAR FROM DATE OF ORIGINAL PURCHASE.** Some states do not allow limitations on how long an implied warranty lasts, so the above limitations may not apply to you.



DeVilbiss Air Power Company  
213 Industrial Drive \* Jackson, TN 38301-9615  
Telephone: 1-800-888-2468  
Fax: 1-800-888-9036  
[www.devap.com](http://www.devap.com)

## QUICK FACTS

**CALL 1-800-888-2468 EXT. 2  
TO FIND A LOCAL AUTHORIZED SERVICE CENTER NEAR YOU  
FOR REPAIRS AND SERVICE PART PURCHASES.**

GAS	Use fresh high quality gas. Add stabilizer to fuel tank and run engine for 5 minutes before storage.
OIL	Pump oil: Refer to owners manual supplied with this unit. Engine oil: Refer to engine manual supplied with this unit. Some units are equipped with a low oil sensor and adequate oil must be added or the unit will not start. Some units do not require oil.
WATER	Use only cold water. Don't operate unit with clogged or missing water filter/screen. Don't operate unit without adequate water supply to pump. Adequate water supply is a minimum of 20 psi and 5 gpm.
PRESSURE ADJUSTMENT	The pressure setting is preset at the factory to achieve optimum cleaning. If you need to lower the pressure setting, refer to the owners manual for proper procedure.
PUMP	Pull gun trigger every 2 minutes while engine is running. Don't allow water to freeze in pump. Siphon RV antifreeze into pump for cold weather storage or long term storage.
BY-PASS MODE	Never leave unit running for more than 2 minutes without pulling gun trigger; doing so will destroy pump and void warranty.
THERMAL RELIEF VALVE	Pump is equipped with a thermal relief valve. If the water overheats, this valve will open and allow a gush of water to escape. Once the water is released, the valve closes allowing the pump to operate normally.
HOSE	Don't allow hoses to contact the HOT engine muffler during or after use. Never pull the hose to move the unit.
ENGINE	Do not adjust or attempt maintenance without consulting engine manual or an authorized engine service center. Add stabilizer to fuel tank and run engine for 5 minutes before storage. Always turn on the water before starting the engine.
SOAP CHEMICALS	Use only soaps and chemicals designed for pressure washer use.
NOZZLE	Keep nozzle unclogged. Refer to manual for cleaning procedures. Chemical/soap cannot be siphoned in high pressure setting. Only in low setting.
MAINTENANCE SCHEDULE	Follow recommended maintenance schedule for engine & pump. Refer to manuals.
STORAGE OR WIN- TER STORAGE	Draw clean water through chemical inlet. Add stabilizer to fuel tank and run engine for 5 minutes before storage. Don't allow water to freeze in pump, gun, wand or hoses. Siphon RV antifreeze into pump for cold weather storage or long term storage.

**ALWAYS REFER TO THE MANUALS SUPPLIED WITH THIS UNIT**