

LCD

LCD

LCD

LCD

LCD



LCD

LCD

LCD

LCD

User's Manual
TFT LCD DISPLAY

	<table border="1"><tr><td>WARNING</td></tr><tr><td>RISK OF ELECTRICAL SHOCK, DO NOT OPEN</td></tr></table>	WARNING	RISK OF ELECTRICAL SHOCK, DO NOT OPEN	
WARNING				
RISK OF ELECTRICAL SHOCK, DO NOT OPEN				
<p>Operating precaution</p> <ul style="list-style-type: none">- Do not expose the unit to water or moisture.- Do not disturb the heat radiation from the rear, top and side of the unit.- Do not display for a long time such as a fixed pattern including PIP. It causes the Image Sticking.- Do not open the cabinet which has potentially dangerous high voltage components inside. There is a serious risk of electric shock.				



The lightning flash with the arrowhead symbol, within an equilateral triangle, is intended to alert the user to the presence of uninsulated "dangerous voltage" within the product's enclosure that may be of sufficient magnitude to constitute an electric shock to persons.



The exclamation point within an equilateral triangle is intended to alert the user to the presence of important operating and maintenance (servicing) instructions in the literature accompanying the appliance.

Contents

Manual Contents	03
Features and Package Contents	- Features 04
	- Packages Contents 04
I/O Definitions	- Front Panel Control 05
	- Rear Cabinet IO's 05
Remote Control	- Remote Control Basic(NTSC only) 06
	- Remote Control Basic(PAL only) 07
Basic Operation	- AV Input / Output Terminal 08
	- TV 08
	- Video (Composite) 09
	- S-VHS 09
	- SCART connection (PAL only) 10
	- VIDEO Output connection (NTSC only) 10
	- DTV/HD component video 11
	- Analog RGB / DVI 11
Screen Division	- Screen Layout Menu Setting 12
	- Watching Picture in Picture 13
Picture	- Picture Adjustment 14
	- Preferable Channel Memory (PAL only) 15
Screen	- Screen Setting 16
Audio	- Audio Mode Setting 17
Option	- Closed Caption Setting (NTSC only) 18
	- Teletext 19
	- Source Select 20
TV setting	- TV Setting (PAL only) 21
	- TV Setting (NTSC only) 22
	- Contents Blocking 23
	- Password 24
Troubleshooting	25

Features and Package

Features

- Menu driven On Screen Display(OSD) for Brightness and Contrast, Sharpness, Hue and Saturation, NTSC / PAL, Channel, PIP(Picture in Picture), Aspect Ratio, Input Source, Audio, Audio Adjust, Language, Functions.
- Cable TV ready (NTSC system)
- IR Remote control for all functions
- Built-in Television Tuner(option)
- Zoom-in (up to 500%)
- Speaker output : 2channel- Left, Right (Built-in speaker-26inch only/External speaker-30inch only)
- Selectable Aspect Ratio (fill all-16:9, normal-4:3, anamorphic, wide, Zoom, video game zoom)
- PIP(Picture in Picture), Spilt Screen, POP3, POP12, Grid
- Multiple Mounting Options : Wall mounting or Stand
- Monitor Composite Video Output
- Large Viewing Angle (170 °)
- Input Video sources :
 - 1 RGB (Analog RGB)
 - 1 DVI (Digital RGB)
 - 1 RS-232C(SoftWare Upgrade)
 - 1 Composite Video Inputs (or 1 composite A/V & 1 Scart Input)
 - 1 Composite Video Outputs (or 1 composite A/V & 1 Scart Output)
 - 1 S-VHS Input
 - 1 DVD/DTV/HD Component Video Input
 - 1 RF(Tuner TV)

Package Contents

- LCD TV set
- User's Manual
- IR Remote control unit
- 2 "AAA " size batteries
- AV cable
- AC power cord

I/O Definitions

Front Panel Controls

- Main Power ON/OFF
- Standby Power ON/OFF
- Channel UP
- Channel DOWN
- Volume UP
- Volume DOWN
- MENU
- Select

Rear cabinet I/O's

- AC POWER Input
- RF(TV) connector for antenna Input
- Monitor Composite Video Output
- Monitor Line Level Audio Output
- S-VHS Input
- S-VHS Line Level Audio Input
- Composite Video Input
- Composite Line Level Audio Input
- SCART Input/Output
- DTV/HD Component Video Input
- DTV/HD Line Level Audio Input
- RGB D-sub connector Input
- RGB Audio Input
- DVI(digital RGB) Input
- IR Remote Control
- Speaker Output : Left, Right
Built-in Speaker(26inch only)
- RS-232(SoftWare Upgrade)

Remote Control

NTSC system remote controller

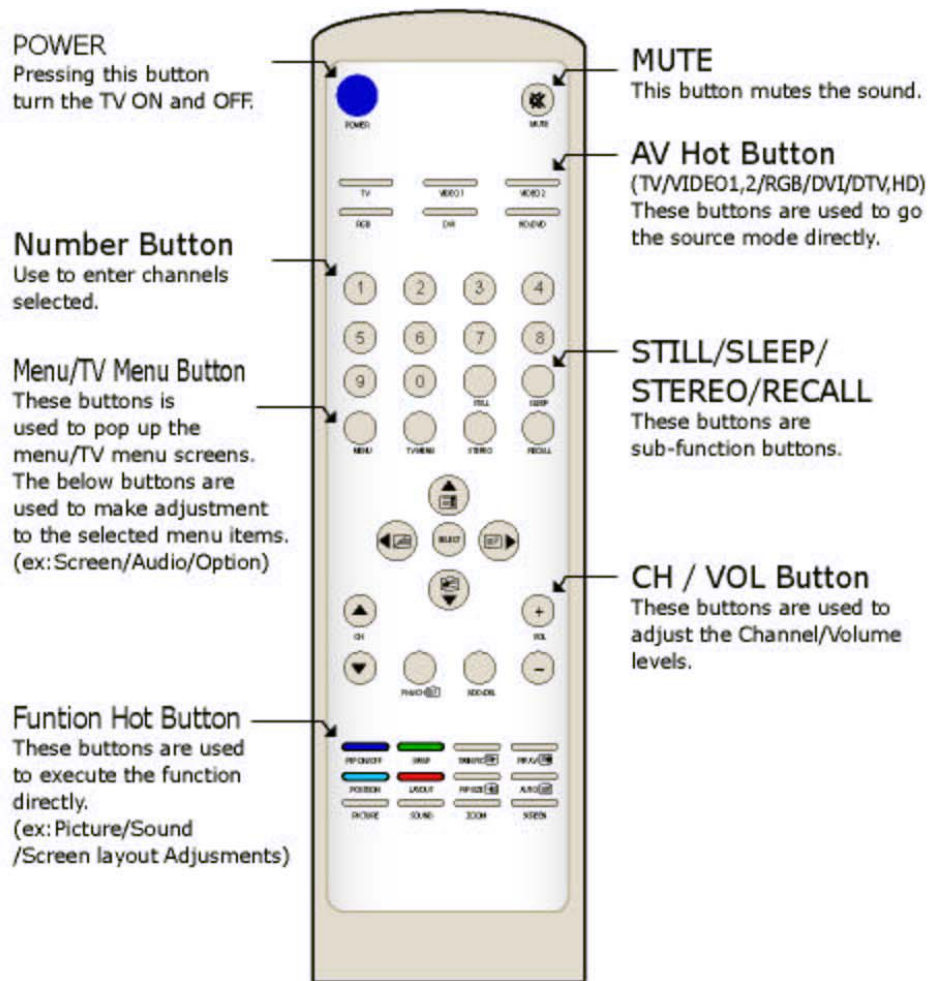

Remote Control

PAL system remote controller

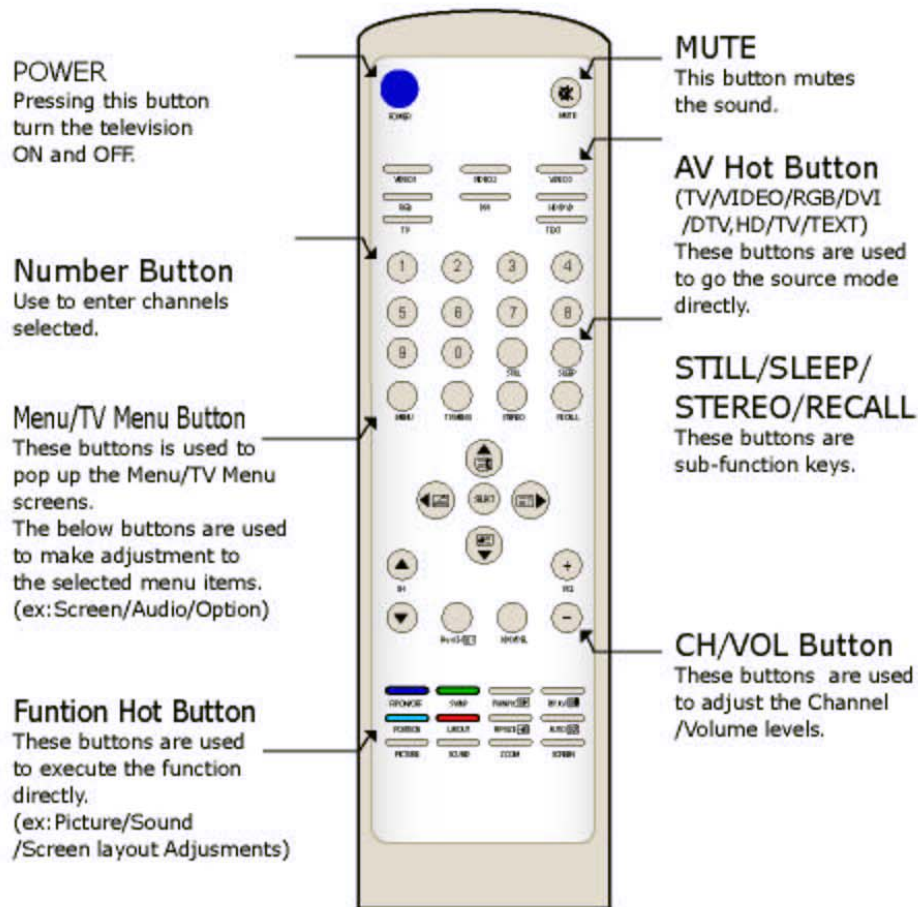

Basic Operation

3. VIDEO

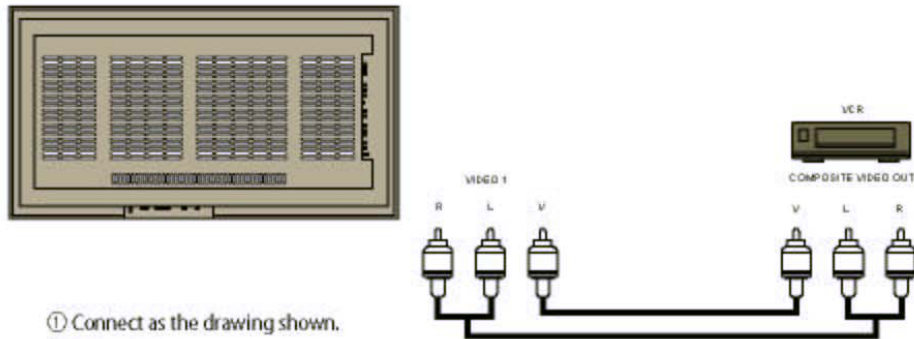

- ① Connect as the drawing shown.
- ② Power on.
- ③ Press the [VIDEO 1] button, ([VIDEO3] button for PAL System)

4. S-VHS

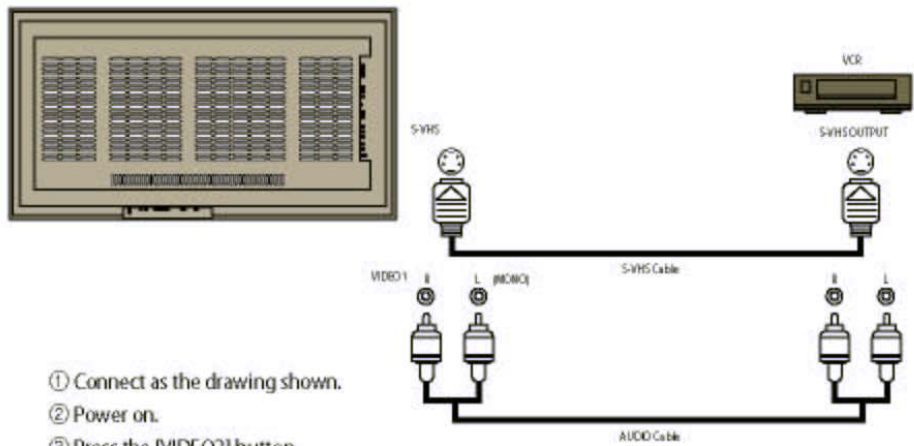

- ① Connect as the drawing shown.
- ② Power on.
- ③ Press the [VIDEO2] button.

Basic Operation

5. SCART connection(PAL only)

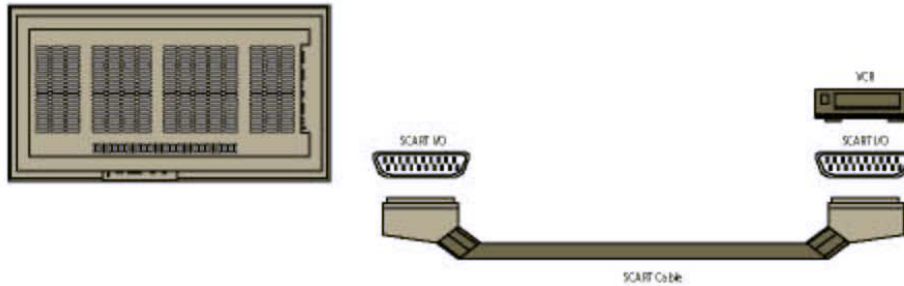

- ① Connect as the drawing shown.
- ② Power on.
- ③ Press the [VIDEO1] button.

6. VIDEO Output connection(NTSC only)

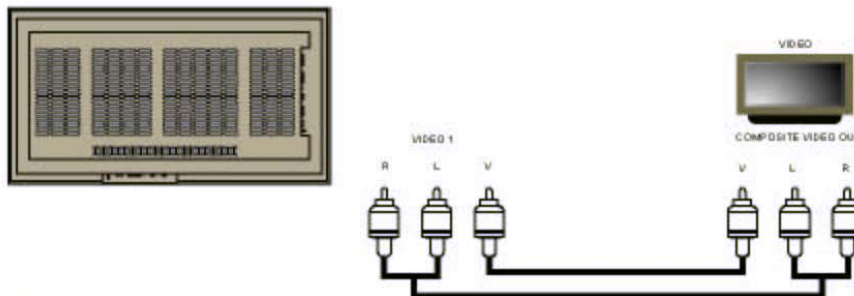

- ① Connect as the drawing shown.
- ② Power on.

Basic Operation

6. DTV/HD component video(Progressive DVD, DTV 480p to 1080i) DVD component video(Interlaced DVD)

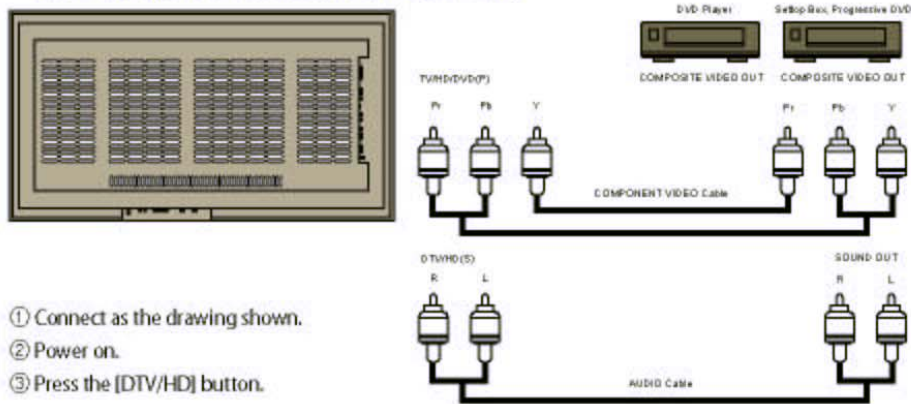

- ① Connect as the drawing shown.
- ② Power on.
- ③ Press the [DTV/HD] button.

7. Analog RGB/DVI(option)

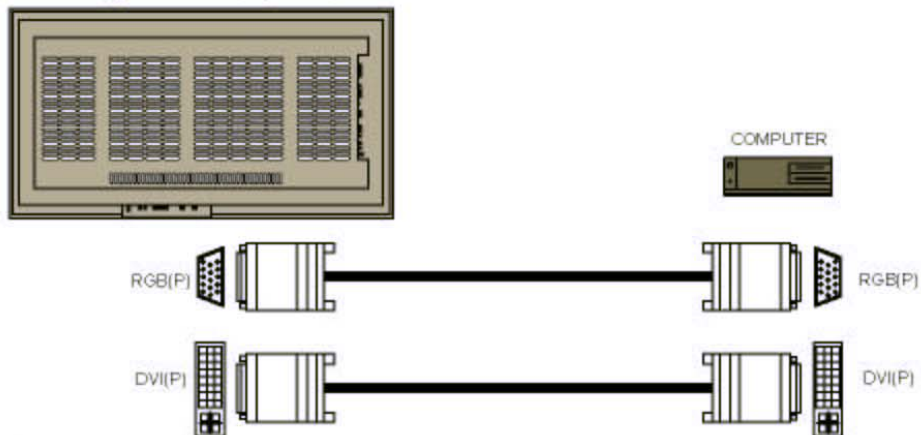

- ① Connect as the drawing shown.
- ② Power on.
- ③ Press the [RGB] button for analog RGB.
- ④ Press the [DVI] button for Digital RGB (DVI).

Screen division

Screen Layout Menu Setting

Follow these steps below to set Screen Layout Menu Setting :



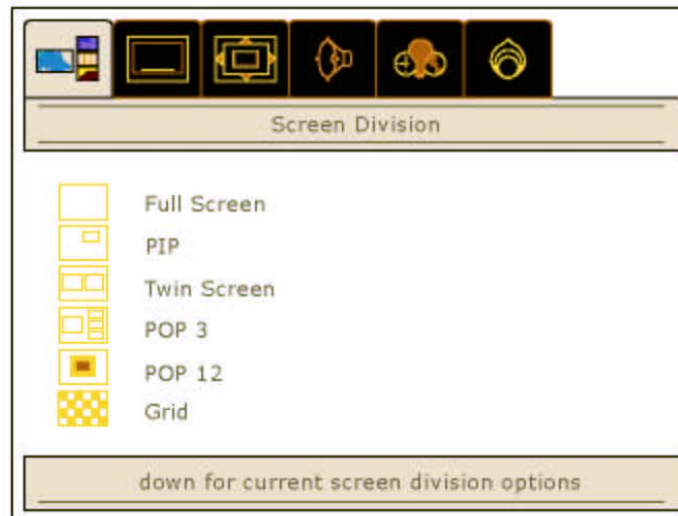

- ① Press the [MENU] button.
- ② Select PIP mode by using the [◀▶]/[▲▼] button.
- ③ Select [SELECT]/[◀▶] buttons to execute screen.
- ④ After screen is displayed th PIP screen.
- ⑤ Select for one source of two sounds [◀▶] button.
- ⑥ Select for one source of two screens [▲▼]button.
- ⑦ Select Full Screen mode for return the screen.



Screen division

Watching Picture in Picture

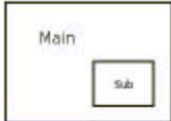
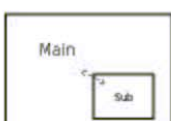

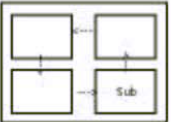
Watching PIP	Press the [PIP ON/OFF] button. 
Changing the Sub Picture to Main	Press the [SWAP] button. 
Watching TWIN PIP	Press the [TWIN PIP] button. 
Changing the Sub Picture Position	Press the [POS] button. 
Resizing Sub Picture	Press the [PIP SIZE] button. 