

RP500

Integrated Effects Switching System



Digitech
by HARMAN

Owner's Manual

Safety Information



CAUTION
RISK OF ELECTRIC SHOCK
DONOT OPEN



ATTENTION: RISQUE DE CHOC ELECTRIQUE - NE PAS OUVRI

WARNING: TO REDUCE THE RISK OF FIRE OR ELECTRIC SHOCK, DO NOT EXPOSE THIS EQUIPMENT TO RAIN OR MOISTURE

The symbols shown above are internationally accepted symbols that warn of potential hazards with electrical products. The lightning flash with arrowpoint in an equilateral triangle means that there are dangerous voltages present within the unit. The exclamation point in an equilateral triangle indicates that it is necessary for the user to refer to the owner's manual.

These symbols warn that there are no user serviceable parts inside the unit. Do not open the unit. Do not attempt to service the unit yourself. Refer all servicing to qualified personnel. Opening the chassis for any reason will void the manufacturer's warranty. Do not get the unit wet. If liquid is spilled on the unit, shut it off immediately and take it to a dealer for service. Disconnect the unit during storms to prevent damage.

ELECTROMAGNETIC COMPATIBILITY

This device complies with part 15 of the FCC Rules and the Product Specifications noted on the **Declaration of Conformity**. Operation is subject to the following two conditions:

- this device may not cause harmful interference, and
- this device must accept any interference received, including interference that may cause undesired operation.

Operation of this unit within significant electromagnetic fields should be avoided.

- use only shielded interconnecting cables.

If you want to dispose this product, do not mix it with general household waste. There is a separate collection system for used electronic products in accordance with legislation that requires proper treatment, recovery and recycling.

Private household in the 25 member states of the EU in Switzerland and Norway may return their used electronic products free of charge to designated collection facilities or to a retailer (if you purchase a similar new one).

For countries not mentioned above, please contact your local authorities for a correct method of disposal. By doing so you will ensure that your disposed product undergoes the necessary treatment, recovery and recycling and thus prevent potential negative effects on the environment and human health.

WARNING FOR YOUR PROTECTION READ THE FOLLOWING:

KEEP THESE INSTRUCTIONS

HEED ALL WARNINGS

FOLLOW ALL INSTRUCTIONS

THE APPARATUS SHALL NOT BE EXPOSED TO DRIPPING OR SPLASHING LIQUID AND NO OBJECT FILLED WITH LIQUID, SUCH AS VASES, SHALL BE PLACED ON THE APPARATUS

CLEAN ONLY WITH A DRY CLOTH.

DO NOT BLOCK ANY OF THE VENTILATION OPENINGS. INSTALL IN ACCORDANCE WITH THE MANUFACTURER'S INSTRUCTIONS.

DO NOT INSTALL NEAR ANY HEAT SOURCES SUCH AS RADIATORS, HEAT REGISTERS, STOVES, OR OTHER APPARATUS (INCLUDING AMPLIFIERS) THAT PRODUCE HEAT.

ONLY USE ATTACHMENTS/ACCESSORIES SPECIFIED BY THE MANUFACTURER.

UNPLUG THIS APPARATUS DURING LIGHTNING STORMS OR WHEN UNUSED FOR LONG PERIODS OF TIME.

Do not defeat the safety purpose of the polarized or grounding-type plug. A polarized plug has two blades with one wider than the other. A grounding type plug has two blades and a third grounding prong. The wide blade or third prong are provided for your safety. If the provided plug does not fit your outlet, consult an electrician for replacement of the obsolete outlet.

Protect the power cord from being walked on or pinched particularly at plugs, convenience receptacles, and the point where they exit from the apparatus.

Refer all servicing to qualified service personnel. Servicing is required when the apparatus has been damaged in any way, such as power-supply cord or plug is damaged, liquid has been spilled or objects have fallen into the apparatus, the apparatus has been exposed to rain or moisture, does not operate normally, or has been dropped.

MAINS DISCONNECT: The plug shall remain readily operable. For rack-mount or installation where plug is not accessible, an all-pole mains switch with a contact separation of at least 3 mm in each pole shall be incorporated into the electrical installation of the rack or building.

DECLARATION OF CONFORMITY

Manufacturer's Name: DigiTech
Manufacturer's Address: 8760 S. Sandy Parkway
Sandy, Utah 84070, USA

declares that the product:

Product name: RP 500
Product option: all (requires Class II power adapter that conforms to the requirements of EN60065, EN60742, or equivalent.)

conforms to the following Product Specifications:

Safety: IEC 60065 -01+Amd I
EMC: EN 55022:2006
EN 55024:1998
FCC Part 15

Supplementary Information:

The product herewith complies with the requirements of the:
Low Voltage Directive 2006/95/EC
EMC Directive 2004/108/EC.
RoHS Directive 2002/95/EC
WEEE Directive 2002/96/EC

With regard to Directive 2005/32/EC and EC Regulation 1275/2008 of 17 December 2008, this product is designed, produced, and classified as Professional Audio Equipment and thus is exempt from this Directive.

With regard to Directive 2005/32/EC and EC Regulation 278/2009 of 6 April 2009, this regulation applies to Class A (single output) external power supplies. The external power supply used with this product is a multi-output power supply and thus is exempt from this Directive.

Roger Johnsen
Vice-President of Engineering
8760 S. Sandy Parkway
Sandy, Utah 84070, USA
Date: January 12, 2011

European Contact: Your local DigiTech Sales and Service Office or

Harman Music Group
8760 South Sandy Parkway
Sandy, Utah
84070 USA
Ph: (801) 566-8800
Fax: (801) 568-7583

Table of Contents

Section One - Introduction

Getting Acquainted.....	1
Included Items	1
About the RP500	1
Pedalboard Mode	1
Preset mode and Pedalboard Mode	1
Bypass Mode	1
Amp/Cabinet Bypass Mode	1
Tuner Mode.....	2
Tone Library (Knob 1).....	2
Effects Library (Knob 2).....	2
Effects Level (Knob 3).....	2
Amp Gain/Effect Parameter (Knob 4).....	2
Amp Level/Effect Parameter (Knob 5)	2
Master Level (Knob 6).....	3
X-Edit™ Editor/Librarian.....	3
Presets	3
Create Your Sound in Three Easy Steps	3
A Guided Tour of the RP500	4
Front Panel	4
Rear Panel.....	7
Getting Started.....	8
Making Connections.....	8
Amp/Cabinet Bypass	8
Mono Operation - Amplifier	8
Stereo Operation.....	8
Applying Power	10

Section Two - Editing Functions

Editing/Creating Presets	11
Storing/Copying/Naming a Preset.....	12

Section Three - Effects and Parameters

About the Effects	13
Effects Definitions	13
Pickup	13
Wah.....	13
Compressor	14
Distortion	14
Amplifier.....	15
Cabinet.....	16
EQ.....	17
Noise Gate/Auto Swell.....	17
Chorus/FX.....	18
Chorus.....	18
Flanger	18
Phaser	19
Vibrato.....	19
Rotary Speaker	19
VibroPan.....	20
Unicord Uni-Vibe™	20
Tremolo/Panner.....	20
Envelope Filter	21
DOD FX25.....	21
AutoYa™	21
Ya Ya™	21
SynthTalk™.....	22
Step Filter.....	22
Sample Hold.....	22
DigiTech Whammy™.....	23
Pitch Shift.....	23
Detune.....	23
Harmony Pitch Shifting (HPS)	24

Boss® OC-2 Octaver.....	24
Delay.....	24
Reverb	25

Section Four - Other Functions

CD/MP3 Input.....	26
Expression Pedal	26
LFOs.....	26
Wah Min/Max.....	26
Expression Update.....	27
Factory Reset.....	27
Expression Pedal Calibration	27

Section Five - Appendix

Specifications	28
Tone Library	29
Effects Library	29

Warranty

We at **DigiTech**[®] are very proud of our products and back up each one we sell with the following warranty:

1. The warranty registration card must be mailed within ten days after purchase date to validate this warranty.
2. DigiTech warrants this product, when used solely within the U.S., to be free from defects in materials and workmanship under normal use and service.
3. DigiTech liability under this warranty is limited to repairing or replacing defective materials that show evidence of defect, provided the product is returned to DigiTech WITH RETURN AUTHORIZATION, where all parts and labor will be covered up to a period of one year. A Return Authorization number may be obtained from DigiTech by telephone. The company shall not be liable for any consequential damage as a result of the product's use in any circuit or assembly.
4. Proof-of-purchase is considered to be the burden of the consumer.
5. DigiTech reserves the right to make changes in design, or make additions to, or improvements upon this product without incurring any obligation to install the same on products previously manufactured.
6. The consumer forfeits the benefits of this warranty if the product's main assembly is opened and tampered with by anyone other than a certified DigiTech technician or, if the product is used with AC voltages outside of the range suggested by the manufacturer.
7. The foregoing is in lieu of all other warranties, expressed or implied, and DigiTech neither assumes nor authorizes any person to assume any obligation or liability in connection with the sale of this product. In no event shall DigiTech or its dealers be liable for special or consequential damages or from any delay in the performance of this warranty due to causes beyond their control.

NOTE: The information contained in this manual is subject to change at any time without notification. Some information contained in this manual may also be inaccurate due to undocumented changes in the product or operating system since this version of the manual was completed. The information contained in this version of the owner's manual supersedes all previous versions.

Section I - Introduction

Getting Acquainted

Congratulations on your purchase of the RP500. You now own a very powerful integrated effects switching system allowing you extra control over stompboxes, effects, amplifiers and cabinets. The RP500 combines the simplicity of a stompbox with the control of an effects switching system for control the way you want it. Armed with DigiTech®'s patented AudioDNA2® custom audio DSP chip, the RP500 gives you a huge selection of tones and effects, right at your fingertips. Easily dial up a sound using the Tone and Effects Library knobs. You will appreciate the tone and dynamic interaction of each of the amps, stompboxes, and effects with your system. Add USB support for computer recording and you have the RP500: the key to unlock your creative potential.

Included Items

Before you get started, please make sure that the following items have been included:

- RP500
- Installer DVD: Cubase LE4 Recording Suite, X-Edit™ Editor/Librarian Software, and RP500 Windows Drivers
- PS0913B Power Supply
- Warranty Card

The utmost care was taken while your RP500 was being manufactured. Everything should be included and in perfect working order. If anything is missing, contact the factory at once. Please help us become acquainted with you and your needs by sending us your completed warranty card or registering online at www.digitech.com. It is your safeguard should a problem arise with your RP500.

About the RP500

Pedalboard Mode

When you first apply power to the RP500, it powers up in Pedalboard mode. Pedalboard mode provides access to all of the presets within the RP500 via the **Up** and **Down Footswitches**. **Knob 1** selects a tone from the Tone Library, **Knob 2** selects an effects chain from the Effects Library, **Knob 3** adjusts the Effects Level, **Knob 4** adjusts the Amp Gain, **Knob 5** adjusts the Amp Level, and **Knob 6** adjusts the Master Level (volume).

Preset Mode and Pedalboard Mode

Since the RP500 has two different footswitch modes of operation (Preset Mode and Pedalboard Mode), presets can be selected in two different ways:

Pedalboard Mode

Pedalboard mode is the default mode, where each numbered footswitch turns on and off the effect labeled above it. Use the **Up/Down Footswitches** to select presets in Pedalboard mode. When the Pedalboard button is on (lit), Pedalboard mode is active.

Preset Mode

In Preset mode, the numbered footswitches recall presets in the active bank. Use the **Up/Down Footswitches** to select preset banks in Preset mode. When the Pedalboard button is off (not lit), Preset mode is active.

Bypass Mode

The RP500 presets can be bypassed via an analog bypass circuit for a clean, unprocessed guitar signal. To bypass the RP500, press the **Bypass Footswitch**. The Display reads **BYPASS** indicating the preset is bypassed. Press any **Footswitch** to exit Bypass and return the RP500 to the last preset used.

Amp/Cabinet Bypass Mode

The RP500 has the unique feature of being able to turn off amp and cabinet modeling globally in all presets. This is extremely useful when you just want to add effects processing to your own core amplifier sound. The RP500 effectively becomes a straight multi-effects box at this point where only Wah, Compressor, Distortion, Equalizer, Noise Gate, Chorus/FX, Delay, and Reverb are being used.

To bypass amp/cabinet modeling in all presets, press the **Amp/Cabinet Bypass** button. When

it is lit, amp/cabinet modeling is globally bypassed in all presets.

Amp/Cabinet Bypass can be used in either Preset or Pedalboard modes.

Tuner Mode

The Tuner in the RP500 allows you to quickly tune or check the tuning on your guitar. Enter Tuner mode by pressing and holding the **Bypass Footswitch** for 2 seconds. The Display briefly shows **TUNER** indicating that you are in Tuner mode. To begin tuning, play a note on your guitar (a harmonic at the 12th fret usually works best). The Numeric Display shows the note being played. Arrows on the right indicate the note is sharp and should be tuned down. Arrows on the left indicate the note is flat and should be tuned up. A left and a right arrow in the center indicate the note is in tune. The output is muted in Tuner mode. The Expression Pedal controls the guitar volume while tuning. Exit tuner mode by pressing any **Footswitch**.

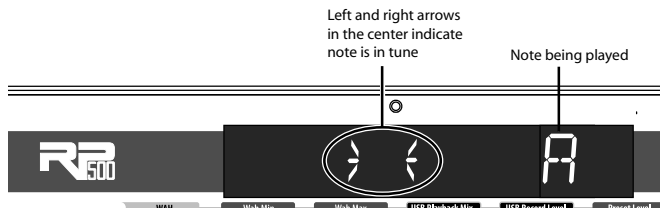

In Tuner mode, you can change your tuning reference. The default factory setting is A=440 Hz (displayed as $A=440$). Rotating **Knob 1** selects alternate dropped tunings and tuning references. Alternate tunings are $A = A\flat$, $A = G$, $A = G\flat$, and tuning references $A=427$ - $A=453$. The display window briefly flashes the current tuning reference.

Tone Library (Knob 1)

In Pedalboard and Preset modes, this knob selects a variety of genre-based amp tone defaults ranging from Blues to Metal to Country. Behind the scenes, the Compressor, Distortion, Amp/Cabinet types, EQ, and Noise Gate are configured to create a specified tone with a single click of this knob. You can further refine the sound by editing the preset (see *Editing/Creating Presets* on page 11). Changing between different Tone Library defaults does not change the Chorus/FX, Delay or Reverb, letting you experiment with different amp styles quickly in the context of the current effect chain. When in Amp/Cabinet Bypass Mode, the amplifiers are defeated leaving distortion and overdrive stompboxes as the only means of distortion.

Effects Library (Knob 2)

In Pedalboard and Preset modes, this knob selects a variety of post-amplifier effect chains (Chorus, Chorus + Delay, Delay + Reverb, etc.). You can further refine the sound by editing the preset (see *Editing/Creating Presets* on page 11). Changing between different Effects Library defaults does not change the Compressor, Distortion, Amp/Cabinet types, EQ, and Noise Gate settings, letting you experiment with different effect chains quickly in the context of the current amp tone.

Effects Level (Knob 3)

In Pedalboard and Preset modes, this knob changes the relative level of the post-amp effects (Chorus/FX, Delay, and Reverb). This can be thought of as an effects mix control, where turning this knob clockwise increases the level of these effects and turning it counter-clockwise decreases the level of these effects.

Amp Gain/Effect Parameter (Knob 4)

This knob adjusts the Gain (distortion) for the selected Amp (not available for Acoustic) and is also used to adjust parameters of other effects in the matrix. The amplifier and cabinets cannot be adjusted when the Amp/Cabinet Bypass button is enabled.

Amp Level/Effect Parameter (Knob 5)

This knob adjusts the Level (volume) of the selected amp and is used to adjust other effect parameters in the matrix. Amp Level cannot be adjusted when the Amp/Cabinet Bypass button is enabled.

Master Level (Knob 6)

This knob controls the overall output volume of all of the RP500's presets and is used to adjust other effect parameters in the matrix.

X-Edit™ Editor/Librarian

You can edit your RP500 with your computer, using the X-Edit™ Editor/Librarian, found on the included DVD.

Presets

Presets are named and numbered locations of programmed sounds which reside in the RP500. Presets are recalled with the Footswitches. The active effects in each preset are indicated by lighted LEDs in the Effect Matrix. The RP500 comes with 100 User presets (I-00) and 100 Factory presets (F1-F00). The User presets are locations where your creations may be stored. The Factory presets do not allow you to store any changes to them. From the factory, the 100 User presets are exact duplicates of the 100 Factory presets. This allows you to create your own presets without losing the sounds that came with the RP500.

Create Your Sound in Three Easy Steps

1.

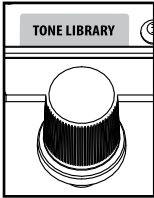

Tone Library

Select one of 40 different tones from rock, metal, blues, country, and more. The tones consist of a combination of Compressor, Distortion Stompbox, Amplifier/Cabinet, EQ, and Noise Gate.

For a complete list of available tones, see page 29.

2.

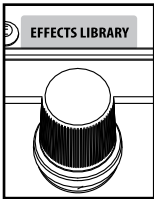

Effects Library

Select one of 40 different effects chains. The effects consist of a combination of Chorus/FX, Delay, and Reverb.

For a complete list of available effects chains, see page 29.

3.

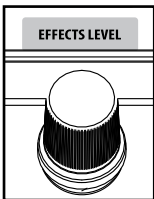

Effects Level

Adjust the overall level of the post-amp effects to your liking.

To make further edits, refer to page 11.

To store the preset, refer to page 12.

A Guided Tour of the RP500

Front Panel

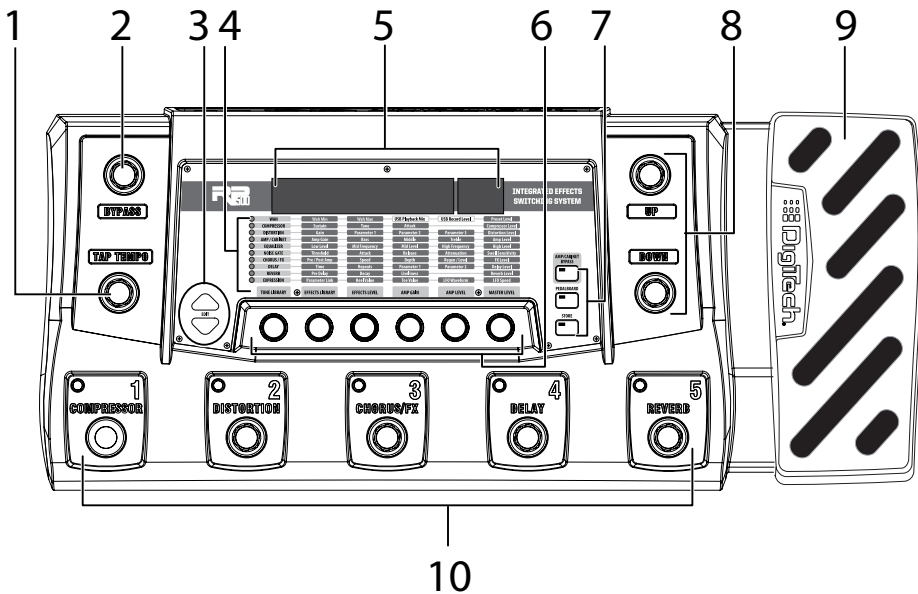

1. Tap Tempo Footswitch

This footswitch is used for setting the delay time in the current preset. By pressing this footswitch repeatedly you can set the delay to repeat in time with your music.

2. Bypass/Tuner Footswitch

This footswitch bypasses all of the RP500's effects sending an unprocessed signal out all of the outputs. Pressing and holding the Bypass footswitch accesses the RP500's chromatic tuner. The Displays will provide feedback for the tuning function (see page 2 for more info on using the Tuner).

3. Edit Up/Down Buttons

These buttons navigate up and down the rows of the matrix for editing presets.

4. Effects Matrix

The matrix provides information regarding the current preset and parameter edit functions. In Pedalboard and Preset modes, the LEDs running down the left side of the Matrix provide a visual indication of which effects are in use for the selected preset. While editing a preset, the LEDs light individually to indicate which Effect row is selected for editing.

5. Displays

The RP500 has two sets of displays. The 8 character alpha-numeric display shows preset names, bank names, and effects names while editing. The 2 character numeric display shows preset numbers and effects parameters while editing and shows the note being tuned when the Tuner is enabled.

6. Knobs 1-6 (From left to right)

These six knobs perform various functions, depending on which mode is currently active and what (if anything) is being edited. The functions are listed below:

Tone Library (Knob 1)

1. In Pedalboard and Preset modes, this knob selects from a library of preset amp tones.
2. When editing a preset, this knob changes the Amp or Effect for the selected row and

pressing the knob will turn the effect row on or off. When editing an Effect row, press this knob to turn the effect on or off. When editing the Amp/Cabinet row, pressing this knob will switch between editing the amp or the cabinet.

3. When the Expression row is selected, this knob selects the Expression, LFO 1, LFO 2, and Wah parameter links, and pressing this knob has the same effect as turning it.

Effects Library (Knob 2)

1. In Pedalboard and Preset modes, this knob selects from a library of preset effect chains.
2. When editing a preset, this knob modifies the parameter listed in the column directly above it for the selected Effect row.
3. When the Expression row is selected, this knob selects which parameter is assigned to the Expression Pedal, LFO1 or LFO2.

Effects Level (Knob 3)

1. In Pedalboard and Preset modes, this knob adjusts the overall level of post amp effects (Chorus/FX, Delay, and Reverb).
2. When editing a preset, this knob modifies the parameter listed in the column directly above it for the selected Effect row.
3. When the Expression row is selected, this knob selects the heel (minimum) value for the parameter or Wah linked to the Expression Pedal.

Amp Gain (Knob 4)

1. In Pedalboard and Preset modes, this knob adjusts the Amp Gain (distortion) for the selected Amp model.
2. When editing a preset, this knob modifies the parameter listed in the column directly above it for the selected Effect row. This knob also is used to adjust the RP/USB mix when the RP500 is connected to a computer and using recording software. Just select the Wah row to adjust this parameter when USB is connected to the RP500.
3. When the Expression row is selected, this knob selects the toe (maximum) value for the parameter or Wah linked to the Expression Pedal.

Amp Level (Knob 5)

1. In Pedalboard and Preset modes, this knob adjusts the Amp Level (volume) of the selected Amp model.
2. When editing a preset, this knob modifies the parameter listed in the column directly above it for the selected Effect row. This knob is also used to adjust the USB Record Level when the RP500 is connected to a computer and using recording software. Just select the Wah row to adjust this parameter when USB is connected to the RP500.
3. When the Expression row is selected, this knob selects the LFO waveform. LFO 1 or LFO 2 must first be selected with Knob 1 for this parameter to be available.

Master Volume (Knob 6)

1. In Pedalboard and Preset modes, this knob adjusts the output level of the RP500.
2. When editing a preset, this knob modifies the parameter listed in the column directly above it for the selected Effect row.
3. When the Expression row is selected, this knob sets the LFO speed. LFO 1 or LFO 2 must first be selected with Knob 1 for this parameter to be available.

7. System Buttons

There are three system buttons: AMP/CABINET BYPASS, PEDALBOARD, and STORE.

- AMP/CABINET BYPASS – When this button is lit, the internal amplifiers and cabinets are bypassed in all RP500 presets
- PEDALBOARD – When this button is lit, the 5 numbered footswitches turn the effects labeled above them on and off. When this button is not lit, these footswitches select the five presets in the active bank.
- STORE – Press this button to begin the store/copy procedure.

8. Up/Down Footswitches

These Up/Down footswitches select preset banks or they select individual presets when Pedalboard mode is active.

9. Expression Pedal

The Expression Pedal provides real-time control of the RP500's Volume, Wah, or any assigned effect parameter. Almost every parameter is available for Expression Pedal control. The Expression Pedal also turns on and controls the Wah effect when you apply extra pressure to the toe.

10. 1-5 / Effects Footswitches

In Preset Mode, these 5 footswitches select between 5 different presets in the active bank. The footswitch LED will light to indicate which preset is active. In Pedalboard mode, these footswitches are used to turn Compressor, Distortion, Chorus/FX, Delay, and Reverb effects on and off. Effects that are on will have their footswitch LED lit.

Rear Panel

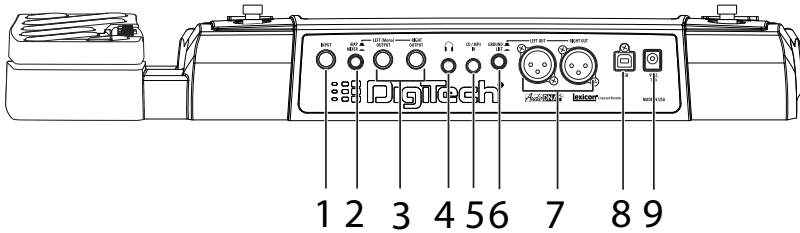

1. Input

High impedance 1/4" instrument input.

2. Amp/Mixer Switch

This switch optimizes the 1/4" Line Outputs for connecting to either a guitar amp system or directly into the inputs of a mixer.

3. 1/4" Line Outputs

These 1/4" outputs can be plugged into a guitar amplifier or into inputs of a mixer or recording device. The front panel Master Level controls the level of these outputs.

4. Headphone Output

Connect headphones here. Output optimized for use with headphones having 60 Ohms of impedance or less.

5. CD/MP3 Input

Connect the headphone output of an MP3 or CD player using a stereo 1/8" cable to this 1/8" stereo TRS jack for rehearsing with your favorite pre-recorded material. Adjust the output level of your playback device and the RP500's Master Level knob for the proper volume balance.

6. Ground Lift Switch

This switch lifts pin 1 from the XLR Mixer Outputs from all ground references. This may be necessary to help solve troublesome ground loops that can cause hum in the system, especially when both XLR and 1/4" outputs are used with a mixer and a guitar amplifier.

7. XLR Mixer Outputs

The XLR outputs are designed for connecting to a recording device or mixing console. These outputs always have speaker compensation active as they are intended to be sent into full a range audio system.

8. USB Jack

The USB jack connects the RP500 to a computer and provides two purposes. First it is used to provide communication between the RP500 and the X-Edit editor librarian software. Second, it is used to stream four channels of audio (2 up / 2 back) to and from the computer when using the RP500 to record with the included Cubase LE4 recording software. Refer to the RP500 Software Installation Guide and Cubase LE4 online documentation on proper setup for this use.

9. AC Jack

The AC Jack allows you to connect a Digitech recommended power supply for supplying AC power to the unit.

Getting Started

Making Connections

There are several different connection options available with the RP500. Before connecting the RP500, make sure that the power to your amplifier and the RP500 is turned off. There is no power switch on the RP500. To turn the RP500 on or off, connect or disconnect the included PS0913B power supply from the **Power Input** jack.

Amp/Cabinet Bypass

The RP500 lets you bypass its amp and cabinet tones so you can apply its effects to your own amp/cabinet tone. To bypass the RP500 amp and cabinet tones in all presets, enable the **Amp/Cabinet Bypass** button. To utilize the RP500 amp and cabinet tones, disable the **Amp/Cabinet Bypass** button.

Mono Operation - Amplifier

Connect your guitar to the **Input** of the RP500. Connect a single mono instrument cable from the **Left (Mono)** output of the RP500 to the instrument input or effect return on your amplifier. Set the $\frac{1}{4}$ " **Amp/Mixer** switch to **Amp**. This setup usually uses the **Amp/Cabinet Bypass**.

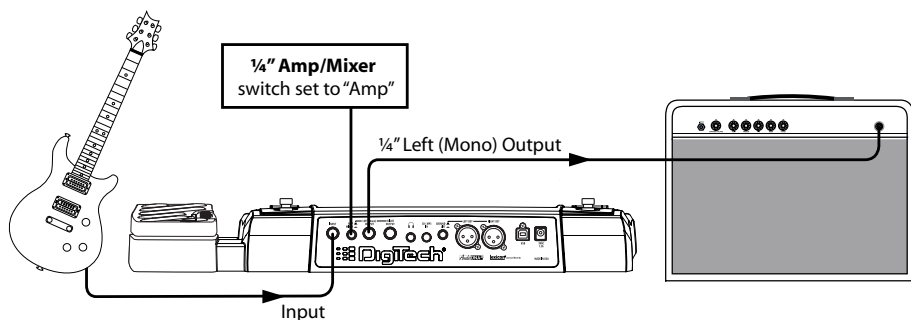

Stereo Operation

For stereo operation connect the guitar to the **Input** of the RP500. Connect one cable to the RP500's **Left (Mono)** output, and another cable to the RP500's **Right** output. Connect one cable to the input of one amplifier, channel of a mixer, or power amp. Connect the second cable to a second amplifier, second channel of a mixer, or power amp. If connecting to a mixing console, set the pan controls of the mixer channels hard left and right in order to retain stereo separation. If connecting to a mixer, set the $\frac{1}{4}$ " **Amp/Mixer** switch to **Mixer**. If connecting to two amplifiers, set the $\frac{1}{4}$ " **Amp/Mixer** switch to **Amp**. This setup usually uses the **Amp/Cabinet Bypass**.

Stereo Amp Setup

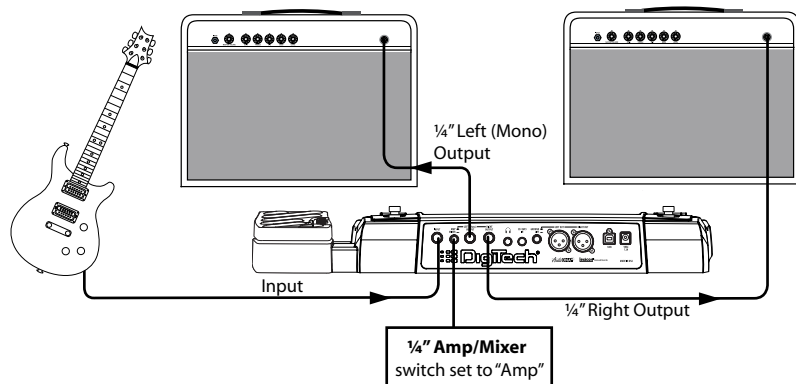

Stereo Mixer Setup

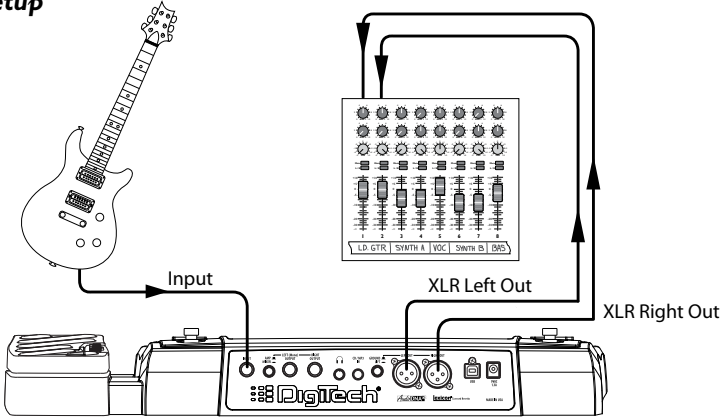

Computer Recording Setup

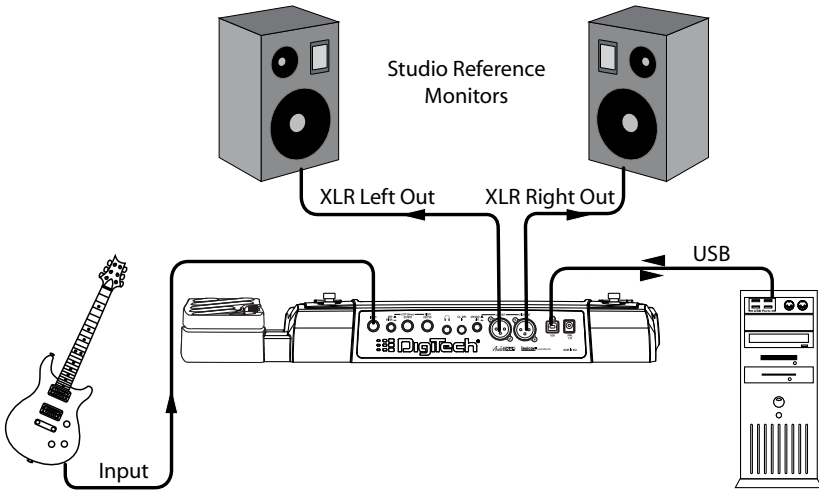

Power Amp/Mixer Setup

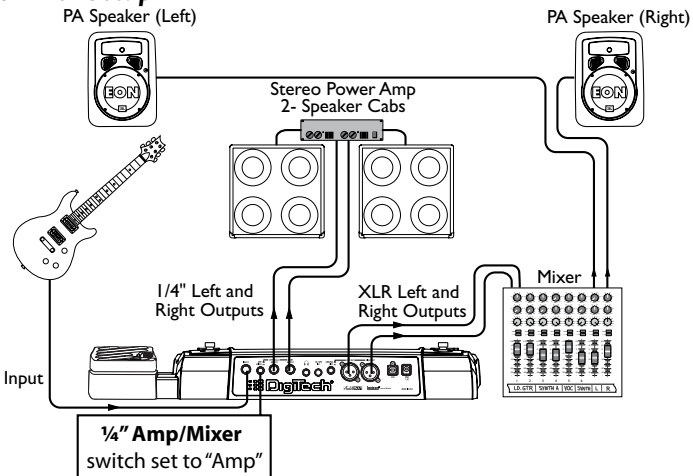

Applying Power

Before applying power to anything, set your amp(s) to a clean tone and set the tone controls to a flat EQ response (on most amps, this should be set to 5 on EQ's to obtain the amp's natural voicing). Then follow the steps listed below.

1. Turn the amp volume all the way down.
2. Connect the plug of the PS0913B power supply to the power jack on the rear panel of the RP500.
3. Connect the other end of the PS0913B power supply to an AC outlet. Turn the RP500's **Master Level** knob (**Knob 6**) down to "0".
4. Turn the power of your amplifier(s) to the on position and adjust the volume(s) to a normal playing level.
5. Gradually increase the RP500's **Master Level** knob to achieve the desired volume.

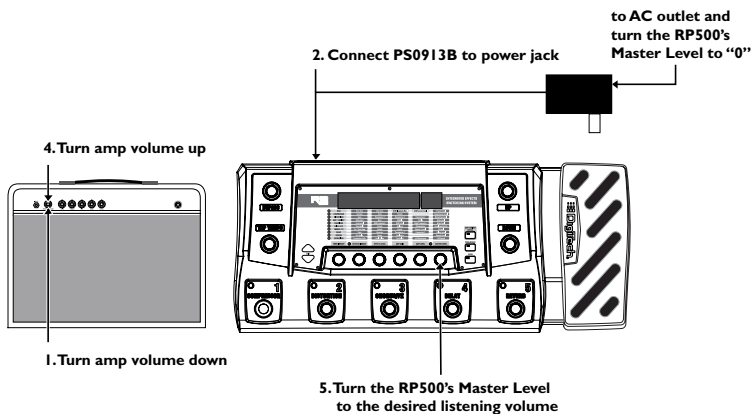

Section Two - Editing Functions

Editing/Creating Presets

The RP500 is designed to make preset editing and creation easy and intuitive. When creating your own sound, you must first start with an existing preset. Note that the preset you begin with doesn't have to be in the memory location you intend to have it reside, since you can store it to any User preset location during the store procedure.

The easiest way to start is by using the **Tone Library** and **Effects Library** knobs. The **Tone Library** knob will let you select from a variety of pre-programmed amp/distortion tones (see page 29) based on different musical styles. The **Effects Library** knob will then let you select from a palette of effects chains (see page 29), from simple delays to full multi-effect signals with modulation, delay and reverb. Use the **Effects Level Knob** to increase or decrease the overall Chorus/FX, Delay and Reverb levels if desired. Using these three controls should get you close to a sound you are after. From there you can then use the **Edit** buttons to navigate through the individual effects for some fine tune edits.

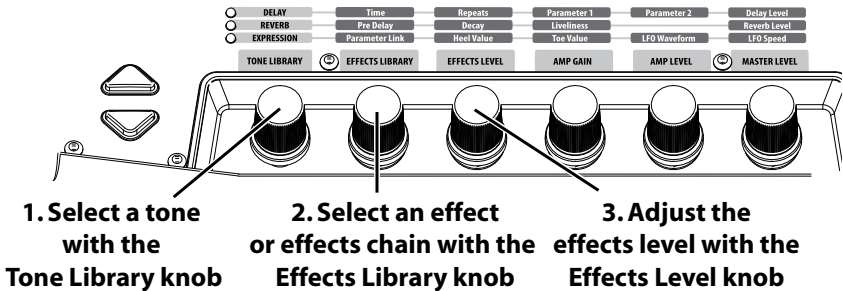

To edit and create a preset:

1. Use the **Up** and **Down Footswitches** to select the preset you wish to edit.
2. If you find a preset close to what you want, you can begin editing the effect parameters by pressing the **Edit Up/Down** buttons and selecting the Effect row you want to edit.
3. If you are trying to find something different from the existing presets, begin by using the **Tone Library**, **Effects Library** and **Effects Level** knobs to get close to a sound you want.
4. Press the **Edit Up/Down** buttons to begin selecting the individual Effects rows to edit their parameters.
5. To bypass or enable an Effect row, press the **Tone Library** knob.
6. Use the **Knobs 2-6** to modify the effects' parameter settings.

Note: Anytime a stored value within a preset is changed, the **Store** button LED lights up. This indicates that you need to store the changes. Changing presets, or turning the power off before storing any changes, erases any changes made and the RP500 will revert to the stored values for the preset.

Also, if you are using the RP500 with the Amp/Cabinet Bypass button enabled (effects only), Tone Libraries that use amps only will not provide distortion or tone changes since amps and cabinets are globally disabled.

Storing/Copying/Naming a Preset

Once the preset has been modified to your liking, you may store your settings to any of the 100 User preset locations (presets 1-00). The following steps outline the procedure for storing changes to a preset or copying a preset to a different location:

1. Press the **Store** button once. The **Store** button LED blinks and the first character in the Display flashes, indicating that you can now name your custom creation.
2. Use **Knob 1** to select the alpha-numeric character and **Knob 2** to select the next character location.

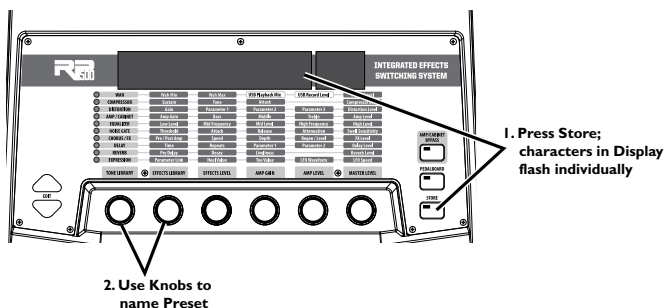

3. Once the desired name is shown in the display, press the **Store** button again to enter the second stage of the storing process. The red Display begins to flash.
4. Select the User preset location where your new sound will reside using the **Up** and **Down Footswitches**. The displays show the preset name and User preset number about to be overwritten.

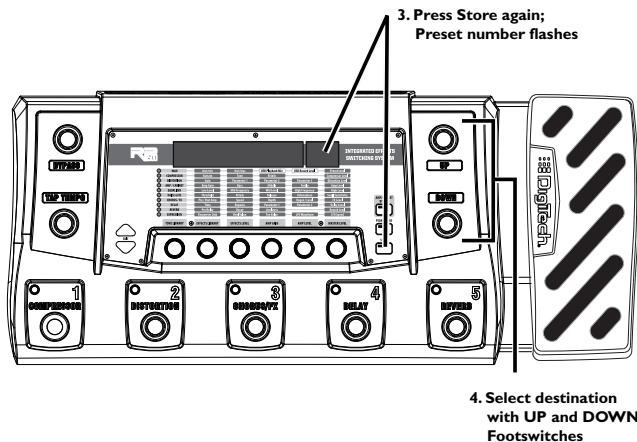

5. Press the **Store** button again to save the changes.

The procedure for copying one preset to another preset location is the same. Use the **Footswitches** to select the preset that you want to copy, then follow steps 1-4 for storing a preset as described above. Press either **Edit** button at any time to abort the Store procedure.

Section Three - Effects and Parameters

About the Effects

The RP500 can be thought of as an assortment of “virtual” amplifiers and individual, high-tech stompboxes in a single programmable package. With stompboxes, the order in which they are connected affects the overall sound. The RP500 has placed the Amps and Effects in an order for optimum results. The following diagram shows the order in which they are connected.

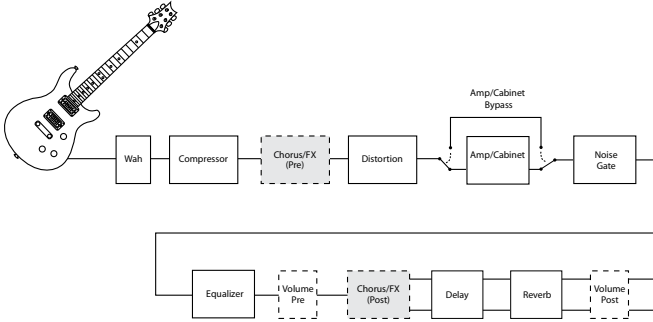

Effect Definitions

Each Amp and Effect within the RP500 can be programmed to suit your personal taste and application. Understanding how these components alter the sound, and how each parameter alters the effect, will help you achieve the sound you are looking for. The following overview of the RP500’s effects outlines what each effect and parameter does.

Wah

Wah is an effect controlled by an Expression Pedal making the guitar sound as if it’s saying “Wah.”

Wahs - Knob 1 selects the Wah type. Values include: *CRY WAH* (Cry Wah is a traditional sounding Wah), *CLYDEWAH* based on a Vox® Clyde McCoy™ Wah), and *FULLRANG* (DigiTech® Full Range Wah sweeps the entire spectrum of audible frequencies). Press this knob to turn Wah on and off.

Wah Level - Knob 2 adjusts the Wah Level. Ranges from 0dB to +12dB.

Compressor

A **Compressor** is used to increase sustain, tighten up guitars, and prevent the signal from clipping the input of other effects. It sets a maximum boundary for the strength of a signal.

Comp - Knob 1 selects one of three Compressors: *DIGICOMP* (DigiTech® Compressor), *CS COMP* (Based on a Boss® CS-2 Compressor/Sustainer), or *DYNOCOMP* (Based on an MXR® Dynacomp). Press this knob to turn the selected Compressor on and off.

Knobs 2-6 have the following functions for the various Compressors:

Compressor	Knob 2 (Sustain)	Knob 3 (Tone)	Knob 4 (Attack)	Knob 5	Knob 6 (Compressor Level)
<i>DIGICOMP</i>	Sustain	Tone	Attack	--	Level
<i>CS COMP</i>	Sustain	--	Attack	--	Level
<i>DYNOCOMP</i>	Sensitivity	--	--	--	Output

Distortion

The RP500 includes the tones of many popular distortion stompboxes, each of which can be fully dialed in.

Distortion - Knob 1 selects a Distortion. Press this knob to turn the selected Distortion on and off.

SCREAMER - Based on an Ibanez® TS-9	DS DIST - Based on a Boss® DS-1™ Distortion
808 - Based on an Ibanez TS-808 Tube Screamer	GRUNGE - DigiTech® Grunge®
SPARK DRV - Based on a Voodoo Lab Sparkle Drive	ZONE - Based on a Boss MT-2 Metal Zone®
GUY DRV - Based on a Guyatone® Overdrive OD-2	DEATH - DigiTech Death Metal™
DOD 250 - Based on a DOD® 250 Overdrive/Preamp	GONKULTR - Based on a DOD Gonkulator
REDLINE - DigiTech® Redline Overdrive	BATAVIA - Based on a Roger Mayer Octavia™
RODENT - Based on a Pro Co RAT™	FUZZLATR - Based on a Demeter Fuzzulator
MX DIST - Based on an MXR® Distortion +	CLASSFUZ - Based on a DOD Classic Fuzz
	FUZZYFAC - Based on an Arbiter® Fuzz Face™
	BIG PI - Based on an Electro-Harmonix® Big Muff Pi®

Knobs 2-6 have the following functions for the various Distortions:

Distortion	Knob 2 (Gain)	Knob 3 (Param. 1)	Knob 4 (Param. 2)	Knob 5 (Param. 3)	Knob 6 (Distortion Level)	P7 (X-Edit™ only)
SCREAMER	Drive	Tone	--	--	Level	--
808	Overdrive	Tone	--	--	Level	--
SPARK DRV	Gain	Tone	Clean	--	Volume	--
GUY DRV	Drive	--	--	--	Level	--
DOD 250	Gain	--	--	--	Level	--
REDLINE	Gain	Low	High	--	Level	--
RODENT	Distortion	Filter	--	--	Level	--
MX DIST	Distortion	--	--	--	Output	--
DS DIST	Gain	Tone	--	--	Level	--
GRUNGE	Grunge	Butt	Face	--	Loud	--
ZONE	Gain	Low	Mid	High	Level	Mid Freq
DEATH	--	Low	Mid	High	Level	--
GONKULTR	Gunk	Smear	Suck	--	Heave	--
BATAVIA	Drive	--	--	--	Volume	--
FUZZLATR	Fuzz	Tone	Loose/Tight	--	Volume	--
CLASSFUZ	Fuzz	Tone	--	--	Volume	--
FUZZYFAC	Fuzz	--	--	--	Volume	--
BIG PI	Sustain	Tone	--	--	Volume	--

Disclaimer: DigiTech®, RP500™, DigiTech Whammy®, MultiChorus®, AutoYa™, YaYa™, SynthTalk™, Grunge®, DOD®, Lexicon®, and AudioDNA® are trademarks of Harman International Industries, Incorporated. Ibanez Tube Screamer, Voodoo Labs Sparkle Drive, Guyatone Overdrive, ProCo Rat, MXR, Boss Metal Zone, Roger Mayer Octavia, Demeter Fuzzulator, Arbiter Fuzz Face, EH Big Muff Pi, Dunlop Cry Baby, Vox, Clyde McCoy Wah, MXR DynaComp, TC Electronic, EH Electric Mistress, EH Small Stone, Boss Octaver, Unicorn Univibe, Fender Opto Tremolo, Vox Bias Tremolo, Maestro Echoplex, Fender Twin Reverb, EMT, Fender Tweed Deluxe, Fender Bassman, Fender Blackface, Twin Reverb, Marshall Super Lead, Mesa/Boogie, Hiwatt, Fender Tweed Champ, Soldano, Jensen Blue Backs, Celestion, Johnson Amplification, VHT Amplification, Sunn, Orange, Gibson, Laney, Roland, Peavey, 5150, and Randall are trademarks of their respective companies and are not associated or affiliated with DigiTech or Harman International Industries, Incorporated. These trademarks of other manufacturers are used to identify products whose sounds were reviewed in the making of this product. ©2008 Harman International Industries, Inc. All Rights Reserved.

Amplifier

The amplifiers are an assortment of popular vintage and modern amp tones. The amplifiers also include acoustic guitar simulations.

Amp - By default, **Knob 1** selects one of the classic, modern, and DigiTech custom Amp types. Note that when you select an Amp, the default cabinet is automatically selected. You can, however, change the cabinet after selecting an Amp to achieve different tones. Press this knob and turn it to select a cabinet. Press this knob again to return to the Amp types and parameters.

57 CHAMP	Based on a '57 Fender® Tweed Champ®	SLDND100	Based on an '88 Soldano SLO-100
57DELUXE	Based on a '57 Fender Tweed Deluxe	SUPERGRP GA-40	Based on a Laney Supergroup. Based on a Gibson® GA-40
59BASSMN	Based on a '59 Fender Tweed Bassman®	OR-120	Based on an Orange OJ120.
62BASSMN	Based on a '62 Fender Brown Bassman	PV 5150	Based on a Peavey® 5150 II®
65 TWIN	Based on a '65 Fender Blackface Twin Reverb®	RG100	Based on a Randall RG100
65DLUXRV	Based on a '65 Fender Blackface Deluxe Reverb®	JAZZ 120	Based on a Roland JC120
45 JTM	Based on a '65 Marshall® JTM-45	SOLAR100	Based on a Sunn Solar 100S
68 PLEXI	Based on a '68 Marshall 100 Watt Super Lead (plexi)	DIG SOLO	80s shred guitar.
JUMPPANL	Based on a '68 Marshall Jump Panel	DIGMETAL	Heavy.
MASTRVOL	Based on a '77 Marshall Master Volume	DIGBRIGHT	Sparkle clean.
800 JCM	Based on an '83 Marshall JCM800	DIGCHUNK	Beefy high gain with tight bottom end.
900 JCM	Based on a '93 Marshall JCM900	DIGCLEAN	Sparkle clean.
2000 JCM	Based on an '01 Marshall JCM2000	DIG GAIN	Punchy high gain that cleans up.
AC15	Based on a '62 Vox® AC15	DIGBLUES	Tube combo at the sweet spot.
AC30 TB	Based on a '63 Vox AC30 Top Boost	DIG FUZZ	Fuzz Face + Orange Amp
HIWATTAG	Based on a '69 Hiwatt® Custom 100 DR103	DIGSPANK	Cool rhythm tone with spanky top end.
MARK IIC	Based on an '81 Mesa Boogie® Mark II C	2101 CLN	DigiTech 2101 Clean Tube
MARK IV	Based on a '94 Mesa Boogie® Mark IV	2101 SAT	DigiTech 2101 Saturated Tube
DUALRECT	Based on an '01 Mesa Boogie Dual Rectifier	DIGCRNCH	Based on a modified Plexi.
TRIPRECT	Based on an '04 Mesa Boogie Triple Rectifier	DIGMNSTR	Maxed out gain.
99LEGACY	Based on a 99 Legacy VL-100	DIGTWEED	Based on a Tweed front Blackface power hybrid.
MATCHC30	Based on a '96 Matchless™ HC30	DIGBLACK	Based on a '65 Blackface into a '58 Bassman.
		DIGSTONR	DigiTech stoner rock.
		DIGDKMTL	DigiTech dark metal.
		DIGTRANS	Based on a transistor amp - "Deacy" from Brian May.
		DIGBROWN	Brown sound.
		DIG MOSH	DigiTech mosh.
		DREAD AC	Dreadnaught acoustic
		JUMBO AC	Jumbo acoustic
		DIRECT	No amp

Disclaimer: DigiTech®, RP500™, DigiTech Whammy®, MultiChorus®, AutoYa™, YaYa™, SynthTalk™, Grunge®, DOD®, Lexicon®, and AudioDNA® are trademarks of Harman International Industries, Incorporated. Ibanez Tube Screamer, Voodoo Labs Sparkle Drive, Guyatone Overdrive, ProCo Rat, MXR, Boss Metal Zone, Roger Mayer Octavia, Demeter Fuzzulator, Arbiter Fuzz Face, EH Big Muff Pi, Dunlop Cry Baby, Vox, Clyde McCoy Wah, MXR DynaComp, TC Electronic, EH Electric Mistress, EH Small Stone, Boss Octaver, Unicord Univibe, Fender Opto Tremolo, Vox Bias Tremolo, Maestro Echoplex, Fender Twin Reverb, EMT, Fender Tweed Deluxe, Fender Bassman, Fender Blackface, Twin Reverb, Marshall Super Lead, Mesa/Boogie, Hiwatt, Fender Tweed Champ, Soldano, Jensen Blue Backs, Celestion, Johnson Amplification, VHT Amplification, Sunn, Orange, Gibson, Laney, Roland, Peavey, 5150, and Randall are trademarks of their respective companies and are not associated or affiliated with DigiTech or Harman International Industries, Incorporated. These trademarks of other manufacturers are used to identify products whose sounds were reviewed in the making of this product. ©2008 Harman International Industries, Inc. All Rights Reserved.

Cabinet - Knob 1 also selects cabinets. Pressing this knob alternates between selecting amps and cabinets

CHAMP1X8 - Based on a 1x8 '57 Fender® Tweed Champ®	GRN4X12 - Based on a 4x12 Marshall 1969 Slant w/ Celestion 25W Greenbacks
DLUX1X12 - Based on a 1x12 '57 Fender Tweed Deluxe®	FANE4X12 - Based on a 4x12 Hiwatt® Custom w/ Fane Speakers
DRV1X12 - Based on a 1x12 '65 Fender Blackface Deluxe Reverb	BOTQ4X12 - Based on a 4x12 '96 VHT® Slant w/ Celestion Vintage 30's
BRIT1X12 - Based on a 1x12 '62 Vox® AC15 w/20W Vox Speaker	VNTG4X12 - Based on a 4x12 Johnson® Straight w/ Celestion Vintage 30's
GIBSN1X12 - Based on a '60 Gibson® GA- 40 Jensen Speaker	RECT4X12 - Based on a 4x12 Mesa/Boogie Rectifier V30 speakers
BMAN2X12 - Based on a 2x12 '57 Fender Blonde Bassman®	SOLO4X12 - 4x12 DigiTech® Solo
TWIN2X12 - Based on a 2x12 '65 Fender Blackface Twin Reverb®	BRGT2X12 - 2x12 DigiTech Bright
BRIT2X12 - Based on a 2x12 '63 Vox® AC30 Top Boost w/ Jensen® Blue Backs	METL4X12 - 4x12 DigiTech Metal
JAZZ2X12 - Based on a 2x12 '84 Roland® Jazz Chorus	ROCK4X12 - 4x12 DigiTech Rock
BMAN4X10 - Based on a 4x10 '59 Fender Tweed Bassman®	ALTR4X12 - 4x12 DigiTech Alt Rock
CLAS4X12 - Based on a 4x12 Marshall® 1969 Straight w/ Celestion® G12-T70	VTG4X12 - 4x12 DigiTech Vintage
	CHNK4X12 - 4x12 DigiTech Chunk
	SPNK4X12 - 4x12 DigiTech Spank
	DIGISPKR - DigiTech Speaker Compensa- tion
	DIRECT - No cabinet

Amp Gain - Knob 2 adjusts the Gain (distortion) for the selected Amp (not available for Acoustic). The Gain parameter ranges from 0 to 99.

Bass - Knob 3 adjusts the low frequencies of the amp's tone. Ranges from 1.0 to 10.

Middle - Knob 4 adjusts the mid frequencies of the amp's tone. Ranges from 1.0 to 10.

Treble - Knob 5 adjusts the high frequencies of the amp's tone. Ranges from 1.0 to 10.

Amp Level - Knob 6 adjusts the Level (volume) of the selected Amp. The Level parameter ranges from 0 to 99.

EQ

The RP500's EQ helps further shape your tone with Low, Mid, and High controls.

Knob 1 - Press **Knob 1** to turn the EQ on and off.

Low Level - Knob 2 adjusts the Low EQ level. Ranges from -12dB to 12dB.

Mid Frequency - Knob 3 selects the frequency that the Mid parameter adjusts. Range is from 300 Hz to 4000 Hz.

Mid Level - Knob 4 adjusts the Mid EQ level. Range is from -12dB to 12dB.

High Frequency - Knob 5 adjusts the High EQ frequency. Range is from 2000 Hz to 8000 Hz

High Level - Knob 6 adjusts the High EQ level. Range is from -12dB to 12dB.

Low Frequency (X-Edit™ only) - This parameter selects the Low EQ frequency. Ranges from 60 Hz to 500 Hz.

Low, Mid, and High Bandwidth (X-Edit only) - This parameter selects the frequency bandwidth for each frequency band. Range is from Narrow to Wide.

Noise Gate/Auto Swell

A **Noise Gate** is designed to eliminate noise while you are not playing, or provide an auto volume swell effect.

Gate Type - Knob 1 selects between the DigiTech® noise gate or the volume swell effect. Values include: **GATE** (Selects the Noise Gate) and **SWELL** (Selects the Auto Swell effect.) Press this knob to turn the Noise Gate/Auto Swell on and off.

Threshold (Noise Gate only) - Knob 2 sets the signal strength (Threshold) required to open or close the Noise Gate. Parameters range from 0 (opens easily) to 99 (requiring strong signals to open).

Attack Time - Knob 3 sets the attack time. Ranges from 0 (shorter attack time) to 99 (longer attack time).

Release - Knob 4 sets the Release parameter. Ranges from 0 to 99.

Attenuation - Knob 5 sets the Attenuation parameter. Ranges from 0 to 99.

Swell Sensitivity (Auto Swell only) - Knob 6 sets the Swell Sensitivity parameter of the Auto Swell. Ranges from 0 to 99.

Chorus/FX

The Chorus/FX row in the RP500 is a multi-function module, allowing you to select Effect types such as Chorus, Flanger, Phaser, Vibrato, Rotary Speaker, Tremolo, Panner, Envelope Filter, Detune, Whammy™, Pitch Shift, Detune, IPS, OC Octaver and more. When the Chorus/FX row is selected, **Knob 1** is used to choose the Effect type. Press this knob to turn these Effects on and off. Only one of the effects in this row can be used at a time. After selecting the type of effect in this module, **Knobs 2-6** can then be used to adjust the individual parameters associated with the selected effect. The following list describes each Effect and its parameters in more detail:

Chorus

A Chorus adds a short delay to your signal. The delayed signal is modulated in and out of tune and then mixed back with the original signal to create a thicker sound. The RP500 includes the following Chorus Effects: *CECHORUS* (based on the classic Boss® CE-2 Chorus), *TCCHORUS* (based on the TC Electronic Chorus), *CHORUS* (DigiTech®'s Dual Chorus), *GLISCHRS* (Digi-Tech's Glistening Chorus) and *MULTCHRS* (DigiTech's famous Multi Chorus®).

Knobs 2-6 have the following functions for the various Chorus types:

Chorus	Knob 2 (Pre/Post Amp)	Knob 3 (Speed)	Knob 4 (Depth)	Knob 5 (Regenera- tion)	Knob 6 (FX Level)
<i>CECHORUS</i>	Pre/Post Amp	Speed	Depth	--	--
<i>TCCHORUS</i>	Pre/Post Amp	Speed	Width	--	Intensity
<i>CHORUS</i>	Pre/Post Amp	Speed	Depth	Waveform	Level
<i>GLISCHRS</i>	Pre/Post Amp	Speed	Depth	--	Level
<i>MULTCHRS</i>	Pre/Post Amp	Speed	Depth	Waveform	Level

Flanger

A Flanger uses the same principle as a Chorus but uses a shorter delay time and adds regeneration (or repeats) to the modulating delay. This results in an exaggerated up and down sweeping motion to the effect. The RP500 includes the following Flanger Effects: *FLANGER* (the Digi-Tech® Flanger), *TRIGFLNG* (the DigiTech Triggered Flanger), *MX FLNGR* (based on an MXR® Flanger), *EH FLNGR* (based on an Electro-Harmonix® Electric Mistress), and *AD FLNGR* (based on an A/DA Flanger).

Knobs 2-6 have the following functions for the various Flanger types:

Flanger	Knob 2 (Pre/Post Amp)	Knob 3 (Speed)	Knob 4 (Depth)	Knob 5 (Regenera- tion)	Knob 6 (FX Level)
<i>FLANGER</i>	Pre/Post Amp	Speed	Depth	Regen	Level
<i>TRIGFLNG</i>	Pre/Post Amp	Speed	Sensitivity	LFO Start	Level
<i>MX FLNGR</i>	Pre/Post Amp	Speed	Width	Regen	Manual
<i>EH FLNGR</i>	Pre/Post Amp	Rate	Range	Color	--
<i>AD FLNGR</i>	Pre/Post Amp	Speed	Enhance	Range	Manual

Phaser

A phaser splits the incoming signal, and then changes the phasing of the signal. This signal is then taken in and out of phase and mixed back in with the original signal. As the phasing changes, different frequencies get canceled resulting in a warm sort of twisting sound. The RP500 includes the following Phaser types: *PHASER* (the DigiTech Phaser), *TRIGPHAS* (the DigiTech Triggered Phaser), *MX PHASR* (based on an MXR Phase 100), and *EH PHASR* (based on an Electro-Harmonix Small Stone).

Knobs 2-6 have the following functions for the various Phaser Effects:

Phaser	Knob 2 (Pre/Post Amp)	Knob 3 (Speed)	Knob 4 (Depth)	Knob 5 (Regenera- tion)	Knob 6 (FX Level)
<i>PHASER</i>	Pre/Post Amp	Speed	Depth	Regen	Level
<i>TRIGPHAS</i>	Pre/Post Amp	Speed	Sensitivity	LFO Start	Level
<i>MX PHASR</i>	Pre/Post Amp	Speed	Intensity	--	--
<i>EH PHASR</i>	Pre/Post Amp	Rate	--	Color	--

Vibrato (*VIBRATO*)

The DigiTech Vibrato effect modulates the pitch of the incoming signal at an even rate.

Pre/Post Amp - Knob 2 determines where the effect appears in the effects chain. Turn counter-clockwise for Pre (appears before the Distortion effect), or clockwise for Post (appears after the Noise Gate effect).

Speed - Knob 3 adjusts the rate (Speed) at which the pitch modulates. Ranges from 0 to 99.

Depth - Knob 4 adjusts the intensity (Depth) of the modulating pitch. Ranges from 0 to 99.

Rotary Speaker (*ROTARY*)

The Rotary Speaker emulates a device that included a spinning horn and woofer. The rotation of these two speakers produced an interesting combination of the sound panning from side to side. This produced a slight pitch change due to the speed of the sound coming towards, and then going away from the listener.

Pre/Post Amp - Knob 2 determines where the effect appears in the effects chain. Turn counter-clockwise for Pre (appears before the Distortion effect), or clockwise for Post (appears after the Noise Gate effect).

Speed - Knob 3 adjusts the rate (Speed) of the spinning speakers. Ranges from 0 to 99.

Intensity - Knob 4 controls the intensity of the effect. Ranges from 0 to 99.

Doppler - Knob 5 controls the Pitch Shift effect that is the ratio between the horn and the rotor positions. Ranges from 0 to 99.

Crossover - Knob 6 selects the crossover frequency between the horn and rotor. Ranges from 0 (200 Hz) to 99 (1600 Hz).

VibroPan (*VIBROPAN*)

A vibrato is an effect that modulates the pitch of the incoming signal. This will take the whole signal slightly in and out of tune at a steady pace. The DigiTech® VibroPan also incorporates an automatic panner with the vibrato effect that creates a lush chorus-like sound.

Pre/Post Amp - Knob 2 determines where the effect appears in the effects chain. Turn counter-clockwise for Pre (appears before the Distortion effect), or clockwise for Post (appears after the Noise Gate effect).

Speed - Knob 3 adjusts how fast the signal is being modulated.

Depth - Knob 4 adjusts the amount of pitch change.

Vibrato/Pan- Knob 5 adjusts the amount of panning incorporated with the vibrato effect. When set at 0, this effect is a standard vibrato. As the parameter is turned up, the phase difference of the vibrato signal sent to the two channels is changed until a full stereo image is obtained at 99.

Waveform - Knob 6 selects a waveform: *TRIANGLE*, *SINE*, or *SQUARE*.

Unicord Uni-Vibe™ (*UNOVIBE*)

Based on the Unicord® Uni-Vibe™ pedal, Uni-Vibe adds a lush chorus or rotary speaker (vibrato) effect to your tone.

Pre/Post Amp - Knob 2 determines where the effect appears in the effects chain. Turn counter-clockwise for Pre (appears before the Distortion effect), or clockwise for Post (appears after the Noise Gate effect).

Speed - Knob 3 adjusts the rate (Speed) of the chorus modulation or spinning speaker (vibrato) effect. Ranges from 0 to 99.

Intensity - Knob 4 controls the intensity of the effect. Ranges from 0 to 99.

Chorus/Vibrato - Knob 5 selects either the chorus or vibrato effect. Turn counter-clockwise for Chorus, or clockwise for Vibrato.

Volume - Knob 6 adjusts the volume of the effect.

Tremolo/Panner

A Tremolo effect modulates the volume of the signal at an even rate. The RP500 includes the following Tremolo types: *TREMLO* (the DigiTech® Tremolo), *SCATTREEM* (DigiTech Scattertrem (dual asynchronous tremolos)), *OPTOTREM* (based on the Fender® Opto Tremolo), *BIAS TREM* (based on the Vox® Bias Tremolo), and *PANNER* (the DigiTech Panner).

Pre/Post Amp - Knob 2 determines where the effect appears in the effects chain. Turn counter-clockwise for Pre (appears before the Distortion effect), or clockwise for Post (appears after the Noise Gate effect).

Speed - Knob 3 adjusts the rate (Speed) at which the volume modulates. Ranges from 0 to 99.

Depth - Knob 4 adjusts the intensity (Depth) of the modulating volume. Ranges from 0 to 99.

Waveform (DigiTech Tremolo and Panner only) - Knob 5 selects a waveform: *TRIANGLE*, *SINE*, or *SQUARE*.

Envelope Filter (ENV FILTER)

The DigiTech Envelope Filter is a dynamic Wah effect that alters your sound based upon how hard you play.

Pre/Post Amp - Knob 2 determines where the effect appears in the effects chain. Turn counter-clockwise for Pre (appears before the Distortion effect), or clockwise for Post (appears after the Noise Gate effect).

Sensitivity - Knob 3 adjusts the sensitivity or the input signal required to trigger the Wah effect. Ranges from 0 to 99.

Range - Knob 4 controls the range of the Envelope effect. Ranges from 0 to 99.

DOD FX25 (FX25 ENV)

This envelope filter is based on the DOD FX25.

Pre/Post Amp - Knob 2 determines where the effect appears in the effects chain. Turn counter-clockwise for Pre (appears before the Distortion effect), or clockwise for Post (appears after the Noise Gate effect).

Blend - Knob 3 adjusts the balance between effect signal and dry signal.

Sensitivity - Knob 4 adjusts the sensitivity or the input signal required to trigger the Wah effect. Ranges from 0 to 99.

Range - Knob 5 controls the range of the envelope effect. Ranges from 0 to 99.

AutoYa™ (AUTO YA)

An AutoYa™ combines the characteristics of a Wah and a Flanger together creating an almost human vowel characteristic as if the guitar were saying "Yah." The AutoYa automatically provides this animation to the sound at an even rate.

Pre/Post Amp - Knob 2 determines where the effect appears in the effects chain. Turn counter-clockwise for Pre (appears before the Distortion effect), or clockwise for Post (appears after the Noise Gate effect).

Speed - Knob 3 adjusts the speed of the AutoYa sweep. Ranges from 0 to 99.

Intensity - Knob 4 adjusts the intensity of the AutoYa effect. Ranges from 0 to 99.

Range - Knob 5 adjusts the throaty quality of the AutoYa effect. Ranges from 0 to 49.

YaYa™ (YA YA)

The YaYa™ is another effect exclusive to DigiTech products. Like the AutoYa, it combines the characteristics of a wah and a flanger together providing a unique talk box type of effect, but is controlled by the Expression Pedal.

Pre/Post Amp - Knob 2 determines where the effect appears in the effects chain. Turn counter-clockwise for Pre (appears before the Distortion effect), or clockwise for Post (appears after the Noise Gate effect).

Pedal - Knob 3 adjusts the Ya pedal position. Ranges from 0 to 99.

Intensity - Knob 4 adjusts the intensity of the YaYa effect. Ranges from 0 to 99.

Range - Knob 5 adjusts the throaty quality of the YaYa effect. Ranges from 0 to 49.

SynthTalk™ (SYNTHTLK)

SynthTalk™ is another effect exclusive to DigiTech®. It makes your guitar appear to speak based upon the dynamics of your playing style.

Pre/Post Amp - Knob 2 determines where the effect appears in the effects chain. Turn counter-clockwise for Pre (appears before the Distortion effect), or clockwise for Post (appears after the Noise Gate effect).

Attack - Knob 3 adjusts the attack of the synthesized voice. Ranges from 0 to 99.

Release - Knob 4 adjusts the release of the synthesized voice. Ranges 0 to 99, and ∞ (infinity).

Vox - Knob 5 changes the characteristics of the various synth voices. Ranges from 0 to 99.

Sensitivity - Knob 6 adjusts the sensitivity of the input signal required to trigger the SynthTalk effect. Ranges from 0 to 99.

Balance (X-Edit™ only) - adjusts the left to right balance of the wet signal, Ranges from LEFT 99 to RIGHT 99.

Step Filter (STEPFLTR)

The DigiTech Step Filter is like an automatic “random wah” with a square waveform.

Pre/Post Amp - Knob 2 determines where the effect appears in the effects chain. Turn counter-clockwise for Pre (appears before the Distortion effect), or clockwise for Post (appears after the Noise Gate effect).

Speed - Knob 3 adjusts the speed of the Wah effect. Ranges from 0 to 99.

Intensity - Knob 4 controls the intensity of the Wah effect. Ranges from 0 to 99.

Sample Hold (SAMPLHOLD)

The DigiTech Sample Hold randomly shifts the pitch of the note you’re playing, creating an “electronic” or “robotic” sound.

Pre/Post Amp - Knob 2 determines where the effect appears in the effects chain. Turn counter-clockwise for Pre (appears before the Distortion effect), or clockwise for Post (appears after the Noise Gate effect).

Speed - Knob 3 adjusts the speed of the Sample Hold effect. Ranges from 0 to 99.

Intensity - Knob 4 controls the intensity of the Sample Hold effect. Ranges from 0 to 99.

DigiTech Whammy® (WHAMMY)

The DigiTech Whammy® is an effect that uses an Expression Pedal to bend the pitch of the incoming signal, or add a bendable harmony with the original signal. As the Pedal is moved, the note bends either up or down. When DigiTech Whammy is selected, it is automatically placed before the internal amplifiers as shown in the block diagram on page 13.

Pre/Post Amp - Knob 2 determines where the effect appears in the effects chain. Turn counter-clockwise for Pre (appears before the Distortion effect), or clockwise for Post (appears after the Noise Gate effect).

Shift Amount - Knob 3 selects the interval and direction of the pitch bend. Choices are as follows:

Whammy™ (no Dry Signal)

1 OCT UP (1 octave above)
 2 OCT UP (2 octaves above)
 2ND DOWN (a second below)
 REV 2ND (a second below reversed pedal action)
 4TH DOWN (a fourth below)
 1 OCT DN (an octave below)
 2 OCT DN (2 octaves below)
 DIVE BOMB (Dive Bomb)

Harmony Bends (Dry Signal Added)

M3>M3 (a minor third to a Major third)
 2ND>M3 (a second above to a Major third above)
 3RD->4TH (a third above to a fourth above)
 4TH->5TH (a fourth above to a fifth above)
 5THOCTUP (a fifth above to an octave above)
 H OCT UP (one octave above)
 H OCT DN (one octave down)
 OCTUP:DN (octave up/down)

Pedal Position - Knob 5 provides a manual control of the Whammy pedal position. Ranges from 0 to 99.

Mix - Knob 6 adjusts the Whammy mix. Ranges from 0 to 99.

Pitch Shift (PITCH)

A Pitch Shifter copies the incoming signal, then shifts the pitch of the copy to a different note. The shifted note is then mixed back with the original signal, sounding as if two guitars were playing different notes.

Pre/Post Amp - Knob 2 determines where the effect appears in the effects chain. Turn counter-clockwise for Pre (appears before the Distortion effect), or clockwise for Post (appears after the Noise Gate effect).

Shift Amount - Knob 3 selects the interval of the shifted pitch. Ranges from -24 (2 octaves below) to 24 (2 octaves above).

Mix - Knob 6 controls the mix level of the shifted pitch. Ranges from 0 to 99.

Detune (DETUNE)

A Detuner makes a copy of your incoming signal, takes the copied signal slightly out of tune from the original, then mixes the two signals together. The result is a doubling type of effect as if two guitars were playing the same part together.

Pre/Post Amp - Knob 2 determines where the effect appears in the effects chain. Turn counter-clockwise for Pre (appears before the Distortion effect), or clockwise for Post (appears after the Noise Gate effect).

Shift Amount - Knob 3 adjusts the amount of detune shift. Ranges from -24 to 24 cents.

Level - Knob 6 controls the mix of the detuned note. Ranges from 0 to 99.

Harmony Pitch Shifting (HARMONY)

Harmony Pitch Shifting makes a copy of the incoming signal, and then changes the pitch of the copied note to a diatonically correct interval specified by the Amount parameter. A Harmony Pitch Shifter sharpens or flattens the shifted pitch in order to keep the specified interval within the selected key and scale creating a true harmony.

Pre/Post Amp - Knob 2 determines where the effect appears in the effects chain. Turn counter-clockwise for Pre (appears before the Distortion effect), or clockwise for Post (appears after the Noise Gate effect).

Shift Amount - Knob 3 selects the *amount* or *harmony interval* for the Harmony Pitch Shifter. Interval choices include:

OCT DN (octave down)	2ND UP (a second above)
7TH DN (a seventh below)	3RD UP (a third above)
6TH DN (a sixth below)	4TH UP (a fourth above)
5TH DN (a fifth below)	5TH UP (a fifth above)
4TH DN (a fourth below)	6TH UP (a sixth above)
3RD DN (a third below)	7TH UP (a seventh above)
2ND DN (a second below)	OCT UP (an octave above)

Key - Knob 4 selects the musical key that the HPS uses. Key choices range from the Key of E (KEY E) through the Key of E_b (KEY E_b).

Scale - Knob 5 selects the scale the HPS will use. Scale choices include: Major (MAJOR), Minor (MINOR), Dorian (DORIAN), Mixolydian (MIXOLYDIN), Lydian (LYDIAN), and Harmonic Minor (HARMMINR).

Level - Knob 6 adjusts the HPS Level of all the pitch-altering effects in this module. Ranges from 0 to 99.

Boss® OC-2 Octaver™ (OCTAVER)

Based on the Boss® OC-2 Octaver™, this adds two signals to your original guitar signal. The first is one octave below your guitar, and the second is two octaves below your guitar. Each additional signal has its own volume control.

Pre/Post Amp - Knob 2 determines where the effect appears in the effects chain. Turn counter-clockwise for Pre (appears before the Distortion effect), or clockwise for Post (appears after the Noise Gate effect).

Octave 1 - Knob 3 adjusts the the volume of the signal 1 octave below the input signal. Ranges from 0 to 99.

Octave 2 - Knob 4 controls the volume of the signal 2 octaves below the input signal. Ranges 0 to 99.

Dry Level - Knob 6 controls the volume of the dry signal. Ranges from 0 to 99.

Delay

Delay is an effect that records a portion of the incoming signal, and then plays it back a short time later. The recording can repeat just once or several times.

Delay - Knob 1 selects one of the 7 different Delay types. Values include: ANALOG (DigiTech® Analog Delay), DM DELAY (Based on the Boss DM-2 Analog Delay), DIGITAL (DigiTech Digital Delay), MODULATE (DigiTech Modulated Delay), PINGPONG (DigiTech Pong Delay), TAPE (DigiTech Tape Delay), ECHOPLEX (Based on the Maestro™ EP-2 Echoplex® Tape Echo), and REVERSE (DigiTech Reverse Delay). Press this knob to turn the Delays on and off.

Knobs 2-6 have the following functions for the various Delay Effects:

Delay	Knob 2 (Time)	Knob 3 (Repeats)	Knob 4 (Param. 1)	Knob 5 (Param. 2)	Knob 6 (Delay Level)
ANALOG	Time	Repeats	--	--	Delay Level
DM DELAY	Repeat Rate	Echo	Intensity	--	--
DIGITAL	Time	Repeats	Ducker Threshold	Ducker Level	Delay Level
MODULATE	Time	Repeats	Depth	--	Delay Level
PINGPONG	Time	Repeats	Ducker Threshold	Ducker Level	Delay Level
TAPE	Time	Repeats	Wow	Flutter	Delay Level
ECHOPLEX	Time	Repeats	--	--	Volume
REVERSE	Time	Repeats	--	--	Delay Mix

Note: The **Repeats** parameter (Knob 3) ranges from 0 to Repeat Hold (HOLD) for all delays except the Echoplex® and DM-2. Repeat Hold is one click past 99, and acts as an infinite repeat.

Reverb

Using reverb in recorded program material gives the listener a sense that the material is being performed in an actual room or hall. It is this similarity to actual acoustic spaces that makes reverberation a useful tool in recorded music. The RP500 features genuine Lexicon® reverbs, whose rich, lush effects have been heard in countless songs, soundtracks, and live performances for decades.

Reverb Types

Knob 1 selects the Reverb Effect or acoustic space. Press this knob to turn the Reverb on and off. The following types are available:

TWNSPRNG - Based on a Fender® Twin Reverb LEX ROOM - Lexicon Room
 LEXAMBNC - Lexicon® Ambience LEX HALL - Lexicon Hall
 LEXSTUDD - Lexicon Studio EMTPLATE - Based on an EMT240 Plate

Knobs 2-6 have the following functions for the various Reverb Effects:

Reverb	Knob 2 (Pre Delay)	Knob 3 (Decay)	Knob 4 (Liveliness)	Knob 6 (Reverb Level)
TWNSPRNG	--	--	--	Reverb
LEXAMBNC	Pre Delay	Decay	Liveliness	Reverb Level
LEXSTUDD	Pre Delay	Decay	Liveliness	Reverb Level
LEX ROOM	Pre Delay	Decay	Liveliness	Reverb Level
LEX HALL	Pre Delay	Decay	Liveliness	Reverb Level
EMTPLATE	Pre Delay	Decay	Liveliness	Reverb Level

Section Four - Other Functions

CD/MP3 Input

The CD/MP3 Input allows you to connect an MP3 or CD player to the RP500 and jam with your favorite artists. The signal from your MP3 or CD player is output through the left, right, and headphone outputs of the RP500. To use the Aux Input, connect the headphone output of your MP3 or CD player to the **CD/MP3 Input** on the rear panel of the RP500 using an 1/8" stereo cable, and press play on your MP3 or CD player. Use the playing device's volume control and the RP500's **Master Level** knob to balance the levels.

Expression Pedal

The Expression Pedal on the RP500 can be linked to control the RP500's Volume, Wah, Whammy™, YaYa™, or almost any of the RP500's other parameters in real time with your foot. When a parameter has been linked to the Expression Pedal, a minimum (heel) and maximum (toe) value can also be specified. Apply extra pressure to the toe of the Expression Pedal to activate the V-switch, and the Expression Pedal switches between the linked parameter and the Wah. The procedure for linking a parameter to the Expression Pedal is as follows:

1. Press either **Edit** button until the Expression row has been selected (indicated by the LED lighting on the Expression row).
2. Rotate **Knob 1** until *EXP PEDL* appears in the Display.
3. Rotate **Knob 2** until the desired parameter to be linked appears in the Display. 4. Rotate **Knob 3** to select the minimum (heel) value the assigned parameter will reach with the Expression Pedal in the toe up position.
5. Rotate **Knob 4** to select the maximum (toe) value the assigned parameter will reach with the Expression Pedal in the toe down position.
6. Store your Expression Pedal assignment to your preset. See page 12 for more information on the storing procedure.

LFOs

The RP500 includes two assignable low frequency oscillators (LFO 1 and LFO 2) which can be assigned to any of the same parameters available for assignment to the **Expression Pedal**. A low frequency oscillator will automatically vary the value of the assigned parameter at a steady rate. A minimum and maximum value each LFO will reach may be also be assigned. For instance, if the Amp Gain was assigned to LFO 1, and the minimum value was set at 1 and the maximum value was set at 99, the RP500 would automatically sweep the amount of distortion from a clean sound to a distorted sound. Individual LFO speeds are also available for assignment. In the previous example, the LFO speed would determine the length of time it took the LFO to sweep from the clean to the distorted sound. The procedure for assigning the LFOs in the RP500 is as follows:

1. Press the **Edit** button until the Expression row has been selected (indicated by the LED lighting on the Expression row).
2. Rotate **Knob 1** to select one of the two LFO links, LFO 1 (*LFO 1*) or LFO 2 (*LFO 2*).
3. Rotate **Knob 2** to select the parameter you want linked to the LFO 1 or LFO 2.
4. Rotate **Knob 5** to select which waveform you want the LFO to use, Triangle (*TRIANGLE*), Sine (*SINE*), or Square (*SQUARE*).
5. Rotate **Knob 6** to select the speed you want the parameter to be controlled at.

Wah Min/Max

The Wah effect's minimum and maximum values can be edited via the Expression row. The procedure is as follows:

1. Press the **Edit** button until the Expression row has been selected (indicated by the LED lighting on the Expression row).
2. Rotate **Knob 1** to select *WAH PEDL*.
3. Rotate **Knob 3** to adjust the Wah effect's minimum value.
4. Rotate **Knob 4** to adjust the Wah effect's maximum value.

Expression Update

The RP500's Expression pedal has the option to update its position each time a preset change is made. The default behavior for the Expression pedal is to only update its position on a preset change when the Volume Pre or Volume Post parameter is linked within a preset. This lets the Expression pedal behave like a real volume pedal between preset changes. When Expression Update is enabled (ON), the Expression pedal will update its position regardless of the parameter linked, giving it more of an "analog" feel like a real expression pedal would behave.

To enable the Expression Update function, follow these steps:

1. Press the **Edit** button until the Expression row has been selected (indicated by the LED lighting on the Expression row).
2. Rotate **Knob 1** to select *EXPUPDRT*. The default setting is for Expression Update is *OFF*.
3. Press **Knob 1** to enable or disable Expression Update.

Expression Update is a global function that affects the behavior for all presets. You do not need to save this change to each preset.

Factory Reset

This function resets the RP500 to its original factory settings. This procedure erases all custom User presets, and recalibrates the Expression Pedal.

ATTENTION: Performing this function will erase all user-programmed data. All such data will be lost forever! Be sure you want to erase the memory and start fresh before continuing with this procedure.

The procedure for performing a Factory Reset is as follows:

1. Press and hold the **Store** button while powering up the RP500.
2. When the display prompts you with *FACT RST*, release the **Store** button, which is now flashing.
3. Press and hold the flashing **Store** button for 3 seconds until *RESTORE* appears in the display and release. The Restore procedure takes several seconds to complete; during the procedure, the display will count up. After the Restore procedure is complete, the Expression Pedal calibration procedure will begin.

Expression Pedal Calibration

The Expression Pedal on the RP500 needs to be recalibrated for use after a factory reset has been performed. This calibration procedure is automatically entered after a factory reset procedure. (You can also initiate the calibration procedure by pressing and holding the BYPASS footswitch for approximately 5 seconds.) In the event the Pedal's calibration fails, or if the Pedal does not function properly, it can be re-calibrated using the Pedal Calibration procedure. This will not erase the User presets. The procedure for Calibrating the Expression Pedal is as follows:

1. Press and hold the **Bypass Footswitch** until *PEDCALCAL* appears in the display (*BYPASS*, *TUNER*, and *EXIT* will be displayed before *PEDCALCAL* is accessed, after about 5 seconds).
2. When the Display prompts you with *TOE DOWN*, rock the Expression Pedal forward (toe down) and press **Footswitch 5 (Reverb)**.
3. When the Display prompts you with *TOE UP*, rock the Expression Pedal back (toe up) and press **Footswitch 5 (Reverb)**.
4. The Display now prompts you to calibrate the V-Switch sensitivity (*VSWITCHXXX*), where XXX is the current V-Switch threshold. Rock the Expression Pedal forward and press firmly on the toe once to turn the V-Switch on (*WASH ON*), and again to turn the V-Switch off (*WASH OFF*).
5. If the V-Switch is too sensitive, press the **Up Footswitch** to raise the threshold (range is 0-199). The **Down Footswitch** decreases sensitivity. Keep testing the V-Switch sensitivity and adjust the threshold until it only engages when you want it to (too sensitive a setting will lead to the V-Switch falsely triggering on or off when using the Expression Pedal).
6. When the V-Switch sensitivity is set to your satisfaction, press **Footswitch 5 (Reverb)** to exit.

Note: If the Display shows ERROR, an error has occurred and steps 2 through 5 should be repeated.

Section Five - Appendix

Specifications

General Specifications

A/D/A Converter:	24-bit high performance audio
Sampling Frequency:	44.1 kHz
DSP Section:	AudioDNA2™ DSP Processor
Simultaneous Effects:	10
Preset Memory:	100 User Presets (1-00) / 100 Factory Presets (F1-F00)
Dimensions:	19.5" Length x 8.625" Width x 2.75" Height
Unit Weight:	6.6 lbs.

Analog Input Connections:

Guitar Input:	1/4" Unbalanced (TS)
Input Impedance:	500k Ohms
CD/MP3 Input:	1/8" Stereo (TRS)

Analog Output Connections:

1/4" Outputs

Left/Right Outputs:	1/4" Impedance Unbalanced
Left/Right Output Impedance:	500 Ohms per side
Maximum Output:	+10 dBu

XLR Outputs

Left/Right Outputs:	Balanced
Left/Right Output Impedance:	1 kohm per side
Maximum Output:	+16 dBu

Headphones: 1/8" Stereo (TRS) – 13.6mW per channel @ 50 Ohms

Digital Connections:

Universal Serial Bus (USB): Type B, supports USB1.1 Full Speed (12 Mbps Bandwidth USB 2.0 compatible)

RP500 USB Recording Specifications:

Sample Rate:	44.1 kHz
Bit depth:	supports 16-bit or 24-bit (depends on setup in Recording Software)

Power Requirements:

US and Canada:	120 VAC, 60 Hz Adapter: PS0913B-120
Japan:	100 VAC, 50/60 Hz Adapter: PS0913B -100
Europe:	230 VAC, 50 Hz Adapter: PS0913B -230
UK:	240 VAC, 50 Hz Adapter: PS0913B -240

Minimum Windows® PC Computer System Requirements:

Vista Home/Premium, XP Home/Professional (SP 2 installed, .NET Framework 2.0* installed)
800 MHz processor speed (1.2 GHz recommended)
512MB RAM (1GB recommended)

*.NET 2.0 will be installed during installation of X-Edit software if required on XP systems

Minimum Mac Computer System Requirements:

OS 10.4.x, 10.5
PowerPC or Intel® G4, G5 processor 800 MHz (1.2 GHz recommended)
512MB RAM (1GB recommended)

Tone Library

OVERDRIVE
DISTORTION
HOT RAT
SUSTAINER
FUZZOH
OVEREASY
DIRTY TUBES
ROCK 1
ROCK 2
BLUES 1
BLUES 2
METAL 1
METAL 2
COUNTRY 1

COUNTRY 2
WARM DRIVE
CRUNCH
TEXAS TONE
ROCKABILLY
SOLO 1
SOLO 2
ROCK WAH
CHUNKY
SMOOTH
HEAVY
CLEAN 1
CLEAN 2
BRITISH 1

BRITISH 2
AMERICAN 1
AMERICAN 2
TUBE DRIVE
SCOOPED
PUNCHY
BRIGHT CLEAN
BIG PUNCH
SUPER GAIN
GRINDER
BAD BOY
LEGACY LEAD

Effects Library

CUSTOM/CHORUS
PHASER
FLANGER
PITCH
TREMOLO
ROTARY
ENVELOPE FILTER
DIGITAL DELAY
ANALOG DELAY
PONG DELAY
MODULATED DELAY
TAPE DELAY
HALL REVERB
PLATE REVERB

SPRING REVERB
CHORUS-DELAY
CHORUS-DELAY-REVERB
FLANGER-DELAY
PHASER-DELAY
PHASER-MOD DELAY
PHASER-REVERB
DIGITAL DELAY-REVERB
DELAY-SPRING REVERB
CHORUS-REVERB
PONG DELAY-HALL RE-
VERB
TAPE DELAY-SPRING RE-
VERB

TREMOLO-TAPE DELAY
PITCH-DELAY
MOD DELAY-PLATE REVERB
ROTARY-DELAY
ENVELOPE-REVERB
VIBRO-DELAY
ROTARY-DELAY-SPRING
SLOW SWEEP
VIBROPAN
VIBE-DELAY
OCTAVE ROOM
A MAJOR
TRIPLET DELAY
SPACIOUS

DigiTech®
8760 South Sandy Parkway
Sandy, Utah 84070
PH (801) 566-8800
FAX (801) 566-7005
<http://www.digitech.com>

DigiTech® is a registered trademark
of Harman

Copyright - Harman

Printed in China

RP500 Owner's Manual I8-0710-B

Disclaimer: DigiTech®, RP500™, DigiTech Whammy®, MultiChorus®, AutoYa™, YaYa™, SynthTalk™, Grunge®, DOD®, Lexicon®, and AudioDNA® are trademarks of Harman. Ibanez Tube Screamer, Voodoo Labs Sparkle Drive, Guyatone Overdrive, ProCo Rat, MXR, Boss Metal Zone, Roger Mayer Octavia, Demeter Fuzzulator, Arbiter Fuzz Face, EH Big Muff Pi, Dunlop Cry Baby, Vox, Clyde McCoy Wah, MXR DynaComp, TC Electronic, EH Electric Mistress, EH Small Stone, Boss Octaver, Unicord Univibe, Fender Opto Tremolo, Vox Bias Tremolo, Maestro Echoplex, Fender Twin Reverb, EMT, Fender Tweed Deluxe, Fender Bassman, Fender Blackface, Twin Reverb, Marshall Super Lead, Mesa/Boogie, Hiwatt, Fender Tweed Champ, Soldano, Jensen Blue Backs, Celestion, Johnson Amplification, VHT Amplification, Sunn, Orange, Gibson, Laney, Roland, Peavey, 5150, and Randall are trademarks of their respective companies and are not associated or affiliated with DigiTech or Harman International Industries, Incorporated. These trademarks of other manufacturers are used to identify products whose sounds were reviewed in the making of this product. Copyright - Harman. All rights reserved.