

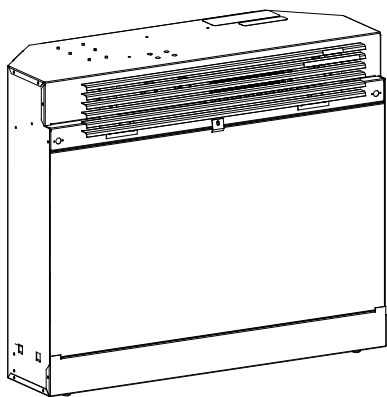

Better solutions through innovation



Owner's Manual

Model

DF3003

DFB6016









IMPORTANT SAFETY INFORMATION: Always read this manual first before attempting to install or use this fireplace. For your safety, always comply with all warnings and safety instructions contained in this manual to prevent personal injury or property damage.

To view the full line of Dimplex products, please visit www.dimplex.com

7205450200R12



Table of Contents

 Welcome & Congratulations	3
 IMPORTANT INSTRUCTIONS.	4
 Site Selection and Preparation.	7
 Fireplace Installation	10
 Operation	10
 Maintenance	13
 Warranty.	16
 Replacement Parts	19

Always use a qualified technician or service agency to repair this fireplace.

! NOTE: Procedures and techniques that are considered important enough to emphasize.

⚠ CAUTION: Procedures and techniques which, if not carefully followed, will result in damage to the equipment.

⚠ WARNING: Procedures and techniques which, if not carefully followed, will expose the user to the risk of fire, serious injury, or death.

Welcome & Congratulations

Thank you and congratulations for choosing to purchase an electric fireplace from Dimplex, the world leader in electric fireplaces.

Please carefully read and save these instructions.

⚠ CAUTION: Read all instructions and warnings carefully before starting installation. Failure to follow these instructions may result in a possible electric shock, fire hazard and will void the warranty.

Please record your model and serial numbers below for future reference: model and serial numbers can be found on the Model and Serial Number Label of your fireplace.

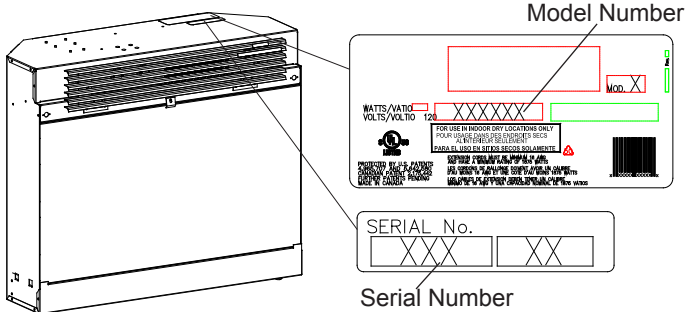

NO NEED TO RETURN TO THE STORE

Questions with operation or assembly? Require Parts Information?
Product Under Manufacturer's Warranty?

Contact us at:  www.dimplex.com/customer_support
For Troubleshooting and Technical Support

OR  **Toll-Free 1-888-DIMPLEX (1-888-346-7539)**
Monday to Friday 8:00 a.m. to 4:30 p.m. EST
Please have your model number and product serial number ready. (See above)

IMPORTANT INSTRUCTIONS

When using electrical appliances, basic precautions should always be followed to reduce the risk of fire, electric shock, and injury to persons, including the following:

- ① Read all instructions before using this appliance.
- ② The heater is hot when in use. To avoid burns, do not let bare skin touch hot surfaces. The trim around the heater outlet becomes hot during heater operation. Keep combustible materials, such as furniture, pillows, bedding, papers, clothes, and curtains at least 3 feet (0.9m) from the front of the unit.
- ③ Extreme caution is necessary when any heater is used by or near children or invalids and whenever the unit is left operating and unattended.
- ④ Always unplug the fireplace when not in use.
- ⑤ Do not operate any unit with a damaged cord or plug, or if the heater has malfunctioned, or if the fireplace has been dropped or damaged in any manner. Return heater to authorized service facility for examination, electrical or mechanical adjustment or repair.
- ⑥ Do not use outdoors.
- ⑦ The fireplace is not intended for use in bathrooms, laundry areas and similar indoor locations. Never locate heater where it may fall into a bathtub or other water container.
- ⑧ Do not run the cord under carpeting. Do not cover cord with throw rugs, runners or the like. Arrange cord away from traffic area and where it will not be tripped over.
- ⑨ To disconnect the unit, turn the controls off, then remove the plug from the outlet.
- ⑩ Do not insert or allow foreign objects to enter any ventilation or exhaust opening as this may



CAUTION
RISK OF ELECTRIC SHOCK
DO NOT OPEN
NO USER-SERVICEABLE PARTS INSIDE





IMPORTANT INSTRUCTIONS

cause an electric shock or fire, or damage to the heater.

⑪ To prevent a possible fire, do not block air intake or exhaust in any manner. Do not use on soft surfaces, like a bed, where openings may become blocked.

⑫ All electrical heaters have hot and arcing or sparking parts inside. Do not use in areas where gasoline, paint, or flammable liquids are used or stored or where the unit will be exposed to flammable vapours.

⑬ Do not modify the fireplace. Use it only as described in this manual. Any other use not recommended by the manufacturer may cause fire, electric shock or injury to persons.

⑭ Avoid the use of an extension cord. Extension cords may overheat and cause a risk of fire. If you must use an extension cord, the cord must be No. 14 AWG minimum size and rated no less than 1875 Watts.

⑮ Do not burn wood or other materials in the fireplace.

⑯ Do not strike the fireplace glass.

⑰ Always use a certified electrician should new circuits or outlets be required.

⑱ Always use properly grounded, fused and polarized outlets.

⑲ Disconnect all power supply before performing any cleaning, maintenance or relocation of the unit.

⑳ When transporting or storing the unit and cord, keep in a dry place, free from excessive vibration and store so as to avoid damage.

⚠ WARNING: To prevent overheating, do not cover heater.

SAVE THESE INSTRUCTIONS



IMPORTANT INSTRUCTIONS

⚠ WARNING: Remote control contains small batteries. Keep away from children. If swallowed, seek medical attention immediately.

⚠ WARNING: Do not install battery backwards, charge, put in fire or mix with used or other battery types - may explode or leak causing injury.

! NOTE: Changes or modifications not expressly approved by the party responsible for compliance could void user's authority to operate the equipment.

⚠ CAUTION: This equipment has been tested and found to comply with the limits for Class B digital device, pursuant to part 15 of the FCC Rules. These limits are designed to provide reasonable protection against harmful interference in a residential installation. This

equipment generates, uses and can radiate radio frequency energy and, if not installed and used in accordance with the instructions, may cause harmful interference to radio or television reception, which can be determined by turning the equipment off and on, the user is encouraged to try to correct the interference by one or more of the following measures:

- Reorient or relocate the receiving antenna.
- Increase the separation between the equipment and the receiver.
- Connect the equipment into an outlet on a circuit different from that to which the receiver is connected.
- Consult the dealer or an experienced radio/TV technician for help.

Operation is subject to the following two conditions: (1) this device may not cause interference and (2) this device must accept any interference, including interference that may cause undesired operation of the device.



Site Selection and Preparation

This section provides easy step by step instructions for selecting a location and preparing the site to install the fireplace into:

- **Existing fireplace**
- **New wall construction**
- **Dimplex mantel surround kit or custom made mantel surround**

! NOTE 1: A 15 Amp, 120 Volt circuit is required. A dedicated circuit is preferred but not essential in all cases. A dedicated circuit will be required if, after installation, the circuit breaker trips or fuse blows on a regular basis when the heater is operating. Additional appliances on the same circuit may exceed the current rating of the circuit breaker.

⚠ WARNING: Ensure the power cord is not installed so that it is pinched or against a sharp edge and ensure that the power cord is stored or secured to avoid tripping or snagging to reduce the risk of fire, electric shock or injury to persons.

Construction and electrical

outlet wiring must comply with local building codes and other applicable regulations to reduce the risk of fire, electric shock and injury to persons.

Do not attempt to wire your own new outlets or circuits. To reduce the risk of fire, electric shock or injury to persons, always use a licensed electrician.

! NOTE: The fireplace insert comes completely assembled and wired. Some tools may be required to prepare the site and assembly/install the trim.

The dimensions of the fireplace insert are 30 ¼ inch (76.8 cm) wide X 25 ½ inch (64.8 cm) high X 11 ½ inch (29.2 cm) deep (Figure 1).

You should allow 1/4 inch (6.4 mm) around the fireplace insert for ease of installation. This fireplace does not require any venting.

⚠ CAUTION: Clearance for air circulation beneath the fireplace insert is provided by four (4) rubber feet (Figure 1). **Do not install the fireplace insert directly on carpet or similar surfaces which may**



Site Selection and Preparation

Figure 1

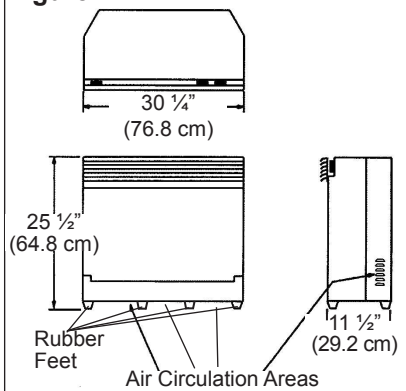

restrict air circulation. If installing the fireplace in a carpeted area, place a one-piece, solid, flat surface under the fireplace insert. Ensure that all four of the insert's feet rest securely on this surface.

Existing Fireplace Installation

1. Seal all drafts and vents with non-fibrous insulation materials to prevent chimney debris from falling into the fireplace insert. Do not install into an existing fireplace that is prone to leaks or dampness.
2. Cap the top of the chimney flue to prevent rain from entering.
3. Plan your electrical power supply (refer to NOTE 1).
4. The power cord can run along the front of the hearth to an outlet near the fireplace.

⚠ WARNING: To prevent personal injury you should hire a professional to cap the chimney flue or cut a hole in the existing fireplace for wiring. If you return your existing fireplace to its original use (example: wood burning), it should be inspected by the local building department prior to use to reduce the risk of fire and personal injury.

New Wall Construction

1. Select a suitable location that is not susceptible to moisture and is away from drapes, furniture and high traffic.
2. Place the fireplace in the desired location to see how it will look in the room.
3. Mark the desired location on the floor and store the fireplace in a safe, dry and dust free location.
4. Use studs to frame an opening of 30 3/4 inch (78.1 cm) wide X 25 3/4 inch (65.4

Site Selection and Preparation

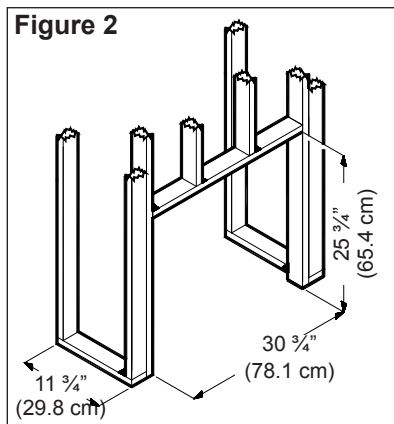

cm) high X 11 3/4 inch (29.8 cm) deep (Figure 2).

5. Plan your electrical power supply (refer to NOTE 1).

Option #1 - The power cord can be lead from behind the trim and along the wall to an outlet near the fireplace.

Option #2 - A new outlet can be installed inside the new frame construction.

Dimplex Mantel Surround Kit or Custom Made Mantel Surround

1. Select a suitable location that is not susceptible to moisture and is away from drapes, furniture and high traffic.

2. Place the fireplace in the desired location to see how it will look in the room.
3. For ease of electrical hook up you may wish to locate the fireplace near an existing outlet (refer to NOTE 1).
4. Store the fireplace in a safe dry and dust free location.
5. Assemble the mantel surround kit (refer to the mantel assembly instructions) or construct the custom surround with an opening of 30 3/4 inch (78.1 cm) wide X 25 3/4 inch (65.4 cm) high X 11 3/4 inch (29.8 cm) deep (Figure 2).

⚠ WARNING: Do not attempt to wire your own new outlets or circuits. To reduce the risk of fire, electric shock or injury to persons, always use a licensed electrician.

Fireplace Installation

1. Make sure the unit's Main On/Off switch is switched Off (refer to operating instruction section).
 2. Plug the unit into a 15 Amp/120 Volt outlet. If the cord does not reach, you may use an extension cord rated for a minimum of 1875 Watts.
 3. Push the fireplace into the opening being careful not to damage the base of the mantel or cabinet so that the fireplace is flush with the mantel or cabinet.
 4. Level the unit with shims if necessary (not provided).
 5. Install the trim onto the fireplace (refer to trim installation instructions).
- ⚠ WARNING:** Ensure the power cord is not installed so that it is pinched or against a sharp edge and ensure that the power cord is stored or secured to avoid tripping or snagging to reduce the risk of fire, electric shock or injury to persons.

Operation

Figure 3

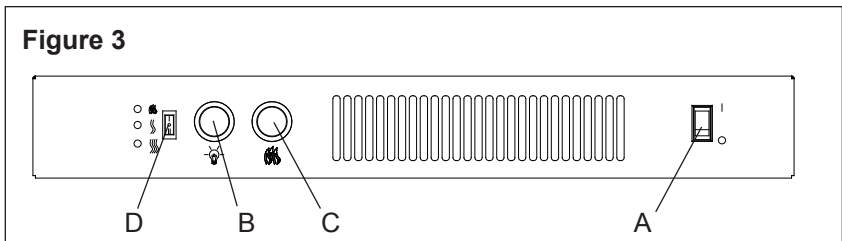

A. Manual On/Off Switch

The fireplace has a manual power On/Off switch located on the control panel of the fireplace. Toggle the switch to turn the fireplace on and off.

B. Light Dimmer

Turn the flame brightness control knob to increase or decrease the brightness of the flame and embers.

Operation

C. Flame Action Control

Turn the flame action control knob to adjust the flame speed control to the desired level.

D. Manual Selection Switch

Operates the electric fireplace manually. Pressing the switch up (“” position) once turns on the electric fireplace and activates Level 1, twice activates Level 2, three times activates Level 3.

Pressing the switch down (“” position) turns the electric fireplace OFF.

Level 1 : The flame effect is turned on and the first red indicator light illuminates.

Level 2 : The flame effect remains on, the heater is activated to the low heat setting, and the first and second red indicator lights illuminate.

Level 3 : The flame effect remains on, the heater is set to the high heat setting, and all three red indicators illuminate.

Resetting the Temperature Cutoff Switch

Should the heater overheat, an automatic cut out will turn the heater off and it will not come back on without being reset. It can be reset by switching the Main On/Off Switch to Off and waiting five (5) minutes before switching the unit back on.

⚠ CAUTION: If you need to continuously reset the heater, unplug the unit and call Dimplex North America Limited at 1-888-346-7539.

Remote Control

The fireplace is supplied with a radio frequency remote control. This remote control has a range of approximately 50 feet (15.25 m), it does not have to be pointed at the fireplace and can pass through most obstacles (including walls). It is supplied with one of 2,178 independent frequencies to prevent interference with other units. The frequency designation is indicated on the back of the transmitter.

Remote Control Initialization/ Reprogramming

Follow steps 1 through 6 to

Operation

initialize your fireplace for the first time. This procedure is also required every time there is a loss of power to the remote control in the fireplace (I.E. power failure, breaker tripped, main power switch is turned off).

1. Ensure that power is supplied through the main service panel.
2. Access the manual controls, (remove glass doors or pull grill down if applicable) pull the right side steel curtain to the outside of the unit (if applicable).
3. Locate manual controls.
4. Activate main power switch.
5. Press and hold the ON switch marked “” for five (5) seconds (red indicator light will flash).
6. Press the ON button located on the remote control transmitter.

This will synchronize the remote control transmitter and receiver.

Remote Control Usage

The remote control operates the fireplace levels sequentially. The level is increased every time the ON button on the transmitter is

Figure 4

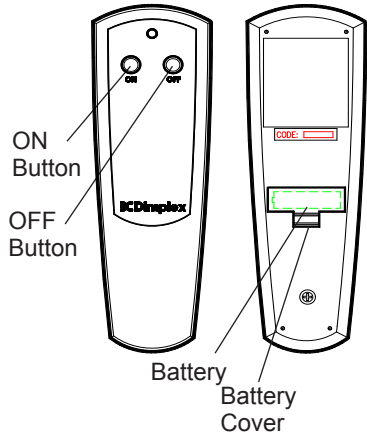

pressed.

The fireplace can be turned off at any point by pressing the OFF button on the remote control transmitter.

Level 1 : The flame effect is turned on and the first red indicator light illuminates.

Level 2 : The flame effect remains on, the heater is activated to the low heat setting, and the first and second red indicator lights illuminate.

Level 3 : The flame effect remains on, the heater is set to the high heat setting, and all

Operation

three red indicators illuminate.

Battery Replacement

(Figure 4)

To replace the battery:

1. Slide battery cover open on the hand held transmitter.
2. Correctly install one (1) 12 Volt (A23) battery in the battery holder.

3. Close the battery cover.



Battery must be recycled or disposed of properly.

Check with your Local Authority or Retailer for recycling advice in your area.



Maintenance

⚠ WARNING: Disconnect power before attempting any maintenance or cleaning to reduce the risk of fire, electric shock or damage to persons.

Light Bulb Replacement

Allow at least five (5) minutes for light bulbs to cool off before touching bulbs to avoid accidental burning of skin. Light bulbs need to be replaced when you notice a dark section of the flame or when the clarity and detail of the log exterior disappears. There are four (4) bulbs under the log set which generate the flames and embers and two (2) bulbs up, in behind the grill that illuminate the interior of the fireplace.

Required Tools: Phillips #2 screw driver, Slot screw driver.

Approximate time: 15 minutes to change upper and lower light bulbs.

Helpful Hints

It is a good idea to replace all light bulbs at one time if they are close to the end of their rated life. Group replacement will reduce the number of times you need to open the unit to replace light bulbs.

To open the light bulb area:

1. Remove the trim by turning the retaining fasteners counterclockwise 1/4 turn until the trim releases from



Maintenance

- the firebox using a slotted screwdriver (Figure 5).
 - Hold the glass in place while removing the retaining clip from the upper center of the firebox (Figure 6A, B).
 - Lift glass out and store in a safe place.
- Examine the bulbs to determine which bulbs require replacement.
 - Hold the socket while unscrewing the bulb.
 - Hold the socket while screwing in the new bulb.
 - Replace the log ember bed by placing the back lip of the log ember bed under the mirror then push the front of the log ember bed down into the recess (Figure 7).

Lower Light Bulb Requirements

Quantity of four (4) clear chandelier or candelabra bulbs with an E-12 (small) socket base, 60 Watt rating.

To replace the bottom light bulbs:

- Lift up the front edge of the log until it clears the front tabs. Pull out until the rear tab clears the back ledge, then lift out (Figure 7).

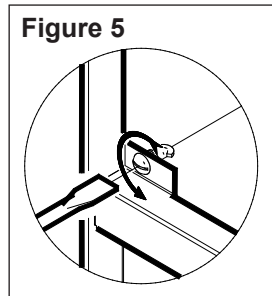
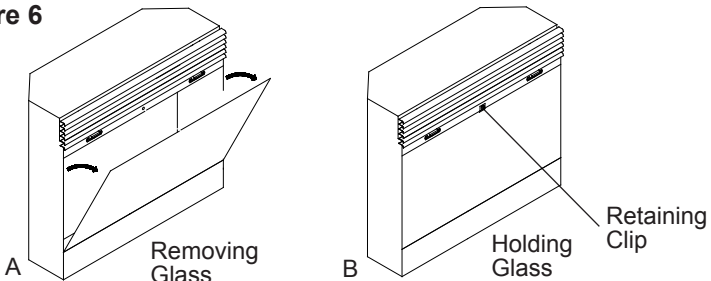

Figure 6





Maintenance

Figure 7

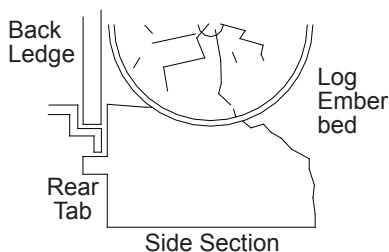
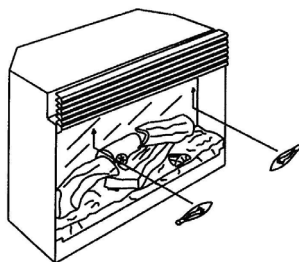

Figure 8



Upper Light Bulb Requirements

Quantity of two (2) clear chandelier or candelabra bulbs with an E-12 (small) socket base, 15 Watt rating.

To replace the top light bulbs:

1. Locate the two upper bulbs inside the firebox at the top (Figure 8).
2. Examine the bulbs to determine which bulbs require replacement.
3. Hold the socket while unscrewing the bulb.
4. Hold the socket while screwing in the new bulb.

Glass Cleaning

The glass is cleaned in the factory during the assembly operation. During shipment, installation, handling, etc., the clear door may

collect dust particles, these can be removed by dusting lightly with a clean dry cloth.

To remove fingerprints or other marks, the clear door can be cleaned with a damp cloth. The clear door should be completely dried with a lint free cloth to prevent water spots. To prevent scratching, do not use abrasive cleaners or spray liquids on the clear door surface.

Fireplace Surface Cleaning

Use a cloth dampened with warm water only to clean painted surfaces of the electric fireplace. Do not use abrasive cleaners.

Warranty

Products to which this limited warranty applies

This limited warranty applies to the following applicable models of your newly purchased Dimplex electric fireplace **DF3003, DFB6016** and to newly purchased Dimplex fireplace surrounds (mantels) and trims. This limited warranty applies only to

purchases made in any province of Canada except for Yukon Territory, Nunavut, or Northwest Territories or in any of the 50 States of the USA (and the District of Columbia) except for Hawaii and Alaska. This limited warranty applies to the original purchaser of the product only and is not transferable.

Products excluded from this limited warranty

Light bulbs are not covered by this limited warranty and are the sole responsibility of the owner/purchaser. Products purchased in Yukon Territory, Nunavut, Northwest Territories, Hawaii, or Alaska are not covered by this limited warranty. Products purchased in these States, provinces, or territories are sold AS IS without warranty or condition of any kind (including, without limitation, any implied warranties or conditions of merchantability or fitness for a particular purpose) and the entire risk of as to the quality and performance of the products is with the purchaser, and in the event of a defect the purchaser assumes the entire cost of all necessary servicing or repair.

What this limited warranty covers and for how long

Products, other than fireplace surrounds (mantels) and trims, covered by this

limited warranty have been tested and inspected prior to shipment. Subject to the provisions of this warranty, Dimplex warrants such products to be free from defects in material and workmanship for a period of 5 years from the date of the first purchase of such products as follows: (a) a repair or replacement warranty on defective products or parts, including in-home services, for the first year following the date of first purchase; and (b) thereafter, a replacement of parts warranty on defective products and parts (with no in-home services) for the 4 year period commencing on the first anniversary of first purchase and ending on the fifth anniversary of the date of first purchase.

Dimplex fireplace surrounds (mantels) and trims covered by this limited warranty have been tested and inspected prior to shipment and, subject to the provisions of this warranty, Dimplex warrants such products to be free from defects in material and workmanship for a period of 1 year from the date of first purchase of such products. Warranty services do not include in-home services.

The above section is a summary only of your warranty rights. Please review the remaining provisions of this warranty for your specific rights.

The limited 5 year warranty period for products other than fireplace surrounds (mantels) and trims and the limited 1 year warranty period for fireplace surrounds (mantels) and trims also applies to any implied warranties that may exist under applicable law. Some jurisdictions do not allow limitations on how long an implied warranty lasts, so the above limitation may not apply to the purchaser.



Warranty

What this limited warranty does not cover

This limited warranty does not apply to products that have been repaired (except by Dimplex or its authorized service representatives) or otherwise altered. This limited warranty does further not apply to defects resulting from misuse, abuse, accident, neglect, incorrect installation, improper maintenance or handling, or operation with an incorrect power source.

What you must do to get service under this limited warranty

Defects must be brought to the attention of Dimplex Technical Service by contacting Dimplex at 1-888-DIMPLEX (1-888-346-7539), or 1367 Industrial Road, Cambridge Ontario, Canada N1R 7G8. Please have proof of purchase, catalogue/model and serial numbers available when calling. Limited warranty service requires a proof of purchase of the product.

What Dimplex will do in the event of a defect

In the event a product or part covered by this limited warranty is proven to be defective in material or workmanship during (i) the 5 year limited warranty period for products other than fireplace surrounds (mantels) and trims, and (ii) the 1 year limited warranty period for surrounds (mantels) and trims, you have the following rights:

- Limited warranty service will be performed solely by dealers or service agents of Dimplex authorized to provide limited warranty services.
- **For products (other than surrounds (mantels) and trims) for the period ending at midnight on the first anniversary of the date of first**

purchase, Dimplex will in its sole discretion either repair or replace such defective product or part without charge. If Dimplex is unable to repair or replace such product or part, or if repair or replacement is not commercially practicable or cannot be timely made, Dimplex may, in lieu of repair or replacement, choose to refund the purchase price for such product or part. This limited warranty entitles the purchaser to on-site or in-home warranty services. Accordingly, Dimplex will be responsible for all labour and transportation costs associated with the repair or replacement of the product or part, except as follows: (i) charges may be levied for travel costs incurred to travel to the purchaser's site where the product is located if the purchaser's site is beyond 30 miles (48 km) from the closest service depot of Dimplex's dealer or service agent; and (ii) the purchaser is solely responsible for providing clear access to all serviceable parts of the product.

- **For products (other than surrounds (mantels) and trims) for the period commencing at 12:01 a.m. on the day after the first anniversary of the first purchase and ending at midnight on the fifth anniversary of the date of first purchase**, this limited warranty entitles the purchaser to replacement parts only without charge. If Dimplex is unable to replace such part, or if replacement is not commercially practicable or cannot be timely made, Dimplex may, in lieu of replacement, choose to refund the purchase price for such part. The



Warranty

purchaser shall not be entitled to on-site or in-home warranty services. The purchaser shall be responsible for all expenses incurred for the removal of the part and installation of the replacement part including, without limitation, all shipping costs and transportation costs to and from the authorized dealer's or service agent's place of business and all labour costs. Such costs shall not be the responsibility of Dimplex.

- **For surrounds (mantels) and trims for the period ending at midnight on the first anniversary of the date of first purchase.** Dimplex will in its sole discretion either repair or replace such defective surrounds (mantels) and trims or part thereof without charge. If Dimplex is unable to repair or replace such product or part, or if repair or replacement is not commercially practicable or cannot be timely made, Dimplex may, in lieu of repair or replacement, choose to refund the purchase price for such product or part. The purchaser shall not be entitled to on-site or in-house services. The purchaser is responsible for all expenses incurred for repair or replacement of such product or part including, without limitation, all shipping costs and transportation costs to and from the authorized dealer's or service agent's business and all labour costs. Such costs shall not be the responsibility of Dimplex.
- On-site or in-home services not provided under this warranty may be performed at the purchaser's specific request and expense at Dimplex's then-current rates for such services.

What Dimplex and its dealers and service agents are also not responsible for

IN NO EVENT WILL DIMPLEX, OR ITS DIRECTORS, OFFICERS, OR AGENTS, BE LIABLE TO THE PURCHASER OR ANY THIRD PARTY, WHETHER IN CONTRACT, IN TORT, OR ON ANY OTHER BASIS, FOR ANY INDIRECT, SPECIAL, PUNITIVE, EXEMPLARY, CONSEQUENTIAL, OR INCIDENTAL LOSS, COST, OR DAMAGE ARISING OUT OF OR IN CONNECTION WITH THE SALE, MAINTENANCE, USE, OR INABILITY TO USE THE PRODUCT, EVEN IF DIMPLEX OR ITS DIRECTORS, OFFICERS, OR AGENTS HAVE BEEN ADVISED OF THE POSSIBILITY OF SUCH LOSSES, COSTS OR DAMAGES, OR IF SUCH LOSSES, COSTS, OR DAMAGES ARE FORESEEABLE. IN NO EVENT WILL DIMPLEX, OR ITS OFFICERS, DIRECTORS, OR AGENTS BE LIABLE FOR ANY DIRECT LOSSES, COSTS, OR DAMAGES THAT EXCEED THE PURCHASE PRICE OF THE PRODUCT.

SOME JURISDICTIONS DO NOT ALLOW THE EXCLUSION OR LIMITATION OF INCIDENTAL OR CONSEQUENTIAL DAMAGES, SO THE ABOVE LIMITATION OR EXCLUSION MAY NOT APPLY TO THE PURCHASER.

How State and Provincial law apply

This limited warranty gives you specific legal rights, and you may also have other rights which vary from jurisdiction to jurisdiction. The provisions of the United Nations Convention on Contracts for the Sale of Goods shall not apply to this limited warranty or the sale of products covered by this limited warranty.



Replacement Parts

30" Log Set Assembly	0438550100RP
Heater/Motor Assembly 1200W,980RPM	2200490900RP
Lower Wire Assy, Lampholder 4 Socket	2500190500RP
Upper Wire Assy, Lampholder 2 Socket	4200090100RP
ON/OFF Switch	2800070200RP
Remote Control Receiver, 3-Stage	3000430800RP
Remote Control Sender, 3-Stage	3000370600RP
Flame Speed Controller Board w Potentiometer	3000240100RP
Flicker Motor Kit	3000240200KIT
Light Dimmer Control board with Potentiometer	3000250100RP
Cord Set	4100040500RP
Reflector Assembly	5900080700RP
Mirror - DFB6016	5900300400RP
DF3003	5900300300RP
Front Glass	5900310300RP
Flat Black Control Knob	8800000200RP
ON/OFF Heater Switch	2800070500RP
Front Grill (Controls Cover)	1009070159RP
Fireplace Foot	8800090100RP



Dimplex North America Limited
1367 Industrial Road
Cambridge ON
Canada N1R 7G8

© 2011 Dimplex North America Limited