



# GPSMAP® 500 series owner's manual

© 2007 Garmin Ltd. or its subsidiaries

Garmin International, Inc.  
1200 East 151<sup>st</sup> Street,  
Olathe, Kansas 66062, USA  
Tel. (913) 397.8200 or (800) 800.1020  
Fax (913) 397.8282

Garmin (Europe) Ltd.  
Liberty House  
Hounslow Business Park,  
Southampton, Hampshire, SO40 9RB UK  
Tel. +44 (0) 870.8501241 (outside the UK)  
0808 2380000 (within the UK)  
Fax +44 (0) 870.8501251

Garmin Corporation  
No. 68, Jangshu 2<sup>nd</sup> Road,  
Shijr, Taipei County, Taiwan  
Tel. 886/2.2642.9199  
Fax 886/2.2642.9099

All rights reserved. Except as expressly provided herein, no part of this manual may be reproduced, copied, transmitted, disseminated, downloaded or stored in any storage medium, for any purpose without the express prior written consent of Garmin. Garmin hereby grants permission to download a single copy of this manual onto a hard drive or other electronic storage medium to be viewed and to print one copy of this manual or of any revision hereto, provided that such electronic or printed copy of this manual must contain the complete text of this copyright notice and provided further that any unauthorized commercial distribution of this manual or any revision hereto is strictly prohibited.

Information in this document is subject to change without notice. Garmin reserves the right to change or improve its products and to make changes in the content without obligation to notify any person or organization of such changes or improvements. Visit the Garmin Web site ([www.garmin.com](http://www.garmin.com)) for current updates and supplemental information concerning the use and operation of this and other Garmin products.



Garmin® is a trademark of Garmin Ltd. or its subsidiaries, registered in the USA and other countries. GPSMAP®, AutoLocate®, BlueChart®, BlueChart® g2 Vision™, TracBack®, BlueChart®, MapSource®, and Ultrascroll™ are trademarks of Garmin Ltd. or its subsidiaries. These trademarks may not be used without the express permission of Garmin. XM WX Weather and XM Radio are trademarks of XM Satellite Radio, Inc.

## INTRODUCTION

This manual includes information for the following products:

GPSMAP® 520/520s	GPSMAP® 525/525s
GPSMAP® 530/530s	GPSMAP® 535/535s
GPSMAP® 540/540s	GPSMAP® 545/545s
GPSMAP® 550/550s	GPSMAP® 555/555s

### Tips and Shortcuts

- Press **HOME** from any screen to return to the Home screen.
- Press **MENU** from any of the main screens to access advanced settings.
- Press and release the **POWER** key to adjust the display settings.

### Manual Conventions

In this manual, when you are instructed to select an item, small arrows (>) appear in the text. They indicate that you should highlight a series of items on the screen using the **ROCKER**, and press the **SELECT** key after each item. For example, if you see “select **Charts** > **Navigation Chart**,” you should highlight **Charts**, and press **SELECT**. Then highlight **Navigation Chart**, and press **SELECT** again.

### Quick Links

- Turning the Unit On or Off: [page 2](#).
- Acquiring GPS Satellite Signals [page 4](#).
- Inserting and Removing SD Cards: [page 5](#).
- Restoring Factory Settings: [page 5](#).
- Using the Navigation Chart: [page 7](#).
- Changing the Chart Settings: [page 16](#).
- Navigating to a Destination: [page 19](#).
- Creating a Waypoint: [page 21](#).
- Configuring System Settings: [page 29](#).
- Using Sonar: [page 35](#).
- Installing the Unit: [page 39](#).
- Alarms and Messages: [page 55](#).

## TABLE OF CONTENTS

<b>Introduction</b> .....	i	<b>Using BlueChart g2 Vision</b> .....	11
<b>Tips and Shortcuts</b> .....	i	<b>Using Mariner's Eye 3D</b> .....	12
<b>Manual Conventions</b> .....	i	<b>Using Fish Eye 3D</b> .....	13
<b>Quick Links</b> .....	i	<b>Using Fishing Charts</b> .....	13
<b>Warnings</b> .....	iv	<b>Enabling High Resolution Satellite Imagery</b> .....	14
<b>Important Information</b> .....	iv	<b>Viewing Aerial Photos</b> .....	15
<b>Getting Started</b> .....	1	<b>Viewing Current Station Information</b> .....	16
<b>Unit Overview</b> .....	1	<b>Detailed Road and POI Data</b> .....	16
<b>Turning the Unit On or Off</b> .....	2	<b>Using Automatic Guidance</b> .....	16
<b>Adjusting the Backlight</b> .....	2	<b>Changing the Chart Settings</b> .....	16
<b>Using the Keypad</b> .....	3	<b>Using the Chart/Sonar Screen</b> .....	18
<b>Acquiring GPS Satellite Signals</b> .....	4	<b>Where To</b> .....	19
<b>Using Simulator Mode</b> .....	4	<b>Navigating to a Destination</b> .....	19
<b>Viewing System Information</b> .....	5	<b>Creating and Using Waypoints</b> .....	21
<b>Restoring Factory Settings</b> .....	5	<b>Creating and Using Routes</b> .....	23
<b>Inserting and Removing SD Cards</b> .....	5	<b>Viewing Information</b> .....	25
<b>Understanding the Home Screen</b> .....	6	<b>Viewing Numbers</b> .....	25
<b>Using Charts</b> .....	7	<b>Viewing Tide Station Information</b> .....	26
<b>Using the Navigation Chart</b> .....	7	<b>Viewing Current Information</b> .....	26
<b>Using the Split Navigation Chart</b> .....	11	<b>Viewing Celestial Information</b> .....	27
		<b>Viewing User Data</b> .....	27
		<b>Viewing Other Boats</b> .....	28

**Configuring the Unit.....29**  
    Configuring System Settings ..... 29  
    Changing Units of Measure ..... 29  
    Configuring Communications Settings..... 30  
    Setting Alarms ..... 31  
    Configuring My Boat ..... 32  
    Configuring Other Boats ..... 34  
    Configuring XM Audio..... 34

**Using Sonar .....35**  
    Understanding the Full Screen ..... 35  
    Understanding the Flasher..... 35  
    Understanding the Split Freq Screen ..... 36  
    Understanding The Split Zoom Screen ..... 36  
    Understanding the Temp Log Screen..... 37  
    Setting Up Sonar ..... 37  
    Advanced Sonar Settings..... 38

**Installing The Unit .....39**  
    Step 1: Select a Location ..... 39  
    Step 2: Mount the Unit ..... 40  
    Step 3: Install the Transducer ..... 42  
    Step 4: Install the Wiring Harness ..... 48  
    Step 5: Test the Installation ..... 51

**Appendix .....53**  
    Specifications ..... 53  
    Product Registration ..... 54  
    Caring for the Unit..... 54  
    Alarms and Messages..... 55  
    Weather Data Warranty ..... 59  
    XM Satellite Radio Service Agreement..... 60  
    Software License Agreement ..... 60  
    Limited Warranty ..... 61  
    FCC Compliance..... 62  
    Industry Canada Compliance ..... 62  
    Declaration of Conformity (DoC) ..... 62  
    Optional Accessories ..... 62

**Index .....63**



## Warnings

**Failure to avoid the following potentially hazardous situations could result in an accident or collision resulting in death or serious injury.**

- When navigating, carefully compare information displayed on the unit to all available navigation sources, including information from visual sightings, and maps. For safety, always resolve any discrepancies or questions before continuing navigation.
- Use the electronic chart in the unit only to facilitate, not to replace, the use of authorized government charts. Official government charts and notices to mariners contain all information needed to navigate safely.
- Use this unit only as a navigational aid. Do not attempt to use the unit for any purpose requiring precise measurement of direction, distance, location, or topography.

**WARNING:** This product, its packaging, and its components contain chemicals known to the State of California to cause cancer, birth defects, or reproductive harm. This Notice is provided in accordance with California's Proposition 65. See [www.garmin.com/prop65](http://www.garmin.com/prop65) for more information.

**(Hg)** - LAMPS INSIDE THIS PRODUCT CONTAIN MERCURY AND MUST BE RECYCLED OR DISPOSED OF ACCORDING TO LOCAL, STATE, OR FEDERAL LAWS.

For more information go to:

[www.garmin.com/aboutGarmin/environment/disposal.jsp](http://www.garmin.com/aboutGarmin/environment/disposal.jsp).

## Important Information

**MAP DATA INFORMATION:** One of the goals of Garmin is to provide customers with the most complete and accurate cartography that is available to us at a reasonable cost. We use a combination of governmental and private data sources, which we identify in product literature and copyright messages displayed to the consumer. Virtually all data sources contain some inaccurate or incomplete data. In some countries, complete and accurate map information is either not available or is prohibitively expensive.

The **California Electronic Waste Recycling Act of 2003** requires the recycling of certain electronics. For more information on the applicability to this product, see [www.ecycle.org](http://www.ecycle.org).

## GETTING STARTED

## Unit Overview

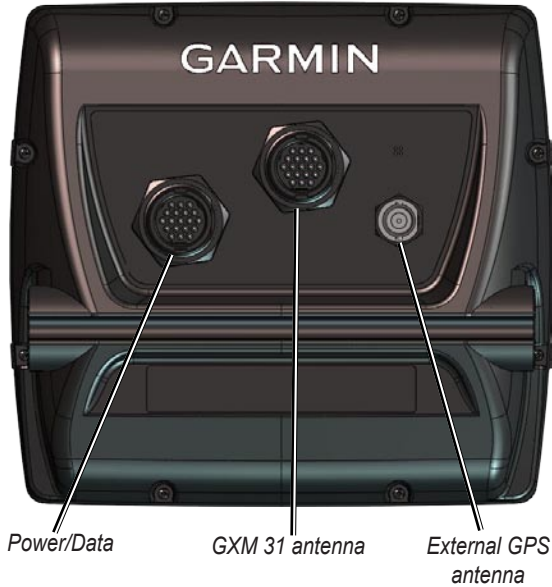

GPSMAP 545s shown



## Turning the Unit On or Off

Press and hold the **POWER** key until the unit beeps and the Garmin screen appears. When the Warning screen appears, press **SELECT** to open the Home screen.



**NOTE:** The first time you power on your unit, you must go through a setup sequence. See [page 51](#) for details.



Warning Screen



Home Screen

## Adjusting the Backlight

1. Press and release the **POWER** key.
2. Select **Backlight** and press left or right on the **ROCKER** to manually adjust the backlight.

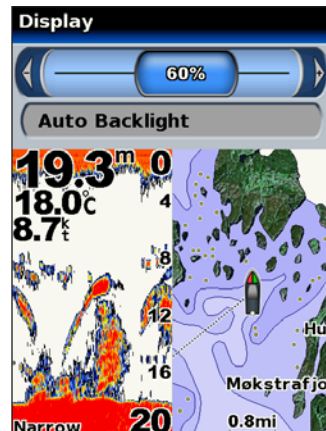



### To switch between Day and Night mode:

1. Press and release the  **POWER** key.
2. Select **Day/Night Mode**.
3. Press left or right on the **ROCKER** to switch between modes.

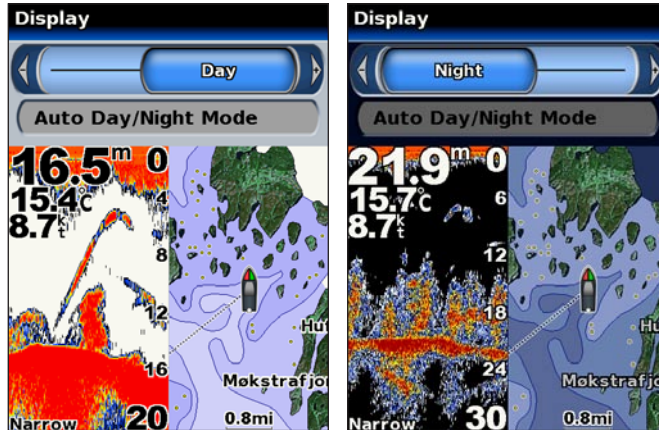

### Using the Keypad



**POWER/BACKLIGHT**—Press and hold to turn the unit on or off; press and release to adjust the backlight and day/night modes.

**RANGE (-/+)**—Press to adjust the range of the sonar; zoom in or out on a chart.

**ROCKER**—Press up, down, left, or right to move through menus, highlight fields, and enter data.

**MARK**—Press to mark a waypoint.

**SELECT**—Press to select highlighted items and confirm on-screen messages.



**HOME**—Press to return to the Home screen.

**MENU**—Press to access additional settings and configuration options; press to return to the previous screen when indicated.

## Acquiring GPS Satellite Signals

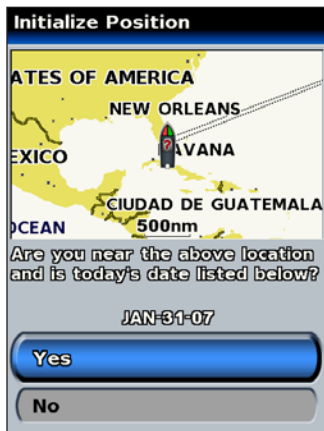
When you turn on the unit, the GPS receiver must collect satellite data and establish its current location. If the unit cannot establish a location, the Initialize Position screen appears.



When the unit acquires satellite signals, the signal strength bars at the top of the Home screen are green . When the unit loses satellite signals, the green bars disappear .

For more information about GPS, visit the Garmin Web site at [www.garmin.com/aboutGPS](http://www.garmin.com/aboutGPS).

## Using Simulator Mode

Simulator Mode turns the GPS receiver off for use indoors or for practice. The unit does not track satellites in Simulator Mode.



**CAUTION:** Do not try to navigate using Simulator Mode because the GPS receiver is turned off. Any satellite signal strength bars shown are only simulations and do not represent the strength of actual satellite signals.

### To turn on Simulator Mode

1. From the Home screen select **Configure > System > Simulator**.
2. Select **Setup** to set speed, track control, and position.

## Viewing System Information

You can view your unit's software version, basemap version, and unit ID number. You may need this information to update the system software or purchase additional map data information.

From the Home screen, select **Configure** > **System** > **System Information**.

## Restoring Factory Settings

You can restore your unit to the original factory settings.



**CAUTION:** This procedure deletes any information you have entered.

### To restore factory settings:

1. From the Home screen, select **Configure** > **System** > **System Information**.
2. Select **Factory Settings**.
3. Select **Yes** to restore all factory settings. Otherwise, select **No** to cancel.

## Inserting and Removing SD Cards

Your unit supports Secure Digital (SD) cards. Insert optional BlueChart® g2 Vision™ SD cards to view high-resolution satellite imagery, and aerial reference photos of ports, harbors, marinas and other points of interest. Insert blank SD cards to transfer data such as waypoints, routes, and tracks to another compatible Garmin unit or a PC. The SD card slot is located on the bottom-right corner of the unit.

To insert the SD card, press it in until it clicks.



To remove the SD card, press in on the SD card. The card pops out.



**NOTE:** If using a new, blank SD card to transfer waypoints from MapSource, insert it in your GPSMAP 400/500 series unit before copying the files from your PC. This prepares the card.

## Understanding the Home Screen

Use the Home screen to access all other screens.



**NOTE:** Options on this screen vary based on the unit type.



**NOTE:** On the GPSMAP 520/520s, 540/540s, 525/525s, and 545/545s units, you must insert an optional preprogrammed BlueChart® g2 Vision™ SD card to access the Fishing and Fish Eye 3D charts.



**NOTE:** The GPSMAP 530/530s, and 535/535s can use the Fish Eye 3D (on certain lakes) without additional cards. These units do not use the Fishing chart.



- **Sonar**—access sonar information ([page 35](#)).

**NOTE:** This option is available only if you have a unit with a built-in sounder or a Garmin sonar module connected.

- **Chart/Sonar**—set up the screen to view a chart and sonar in a split screen ([page 18](#)).
- **Where To?**—access navigation features ([page 19](#)).
- **Information**—view information including tides, currents, celestial data, user data, and information about other boats ([page 25](#)).
- **Configure**—access unit and system settings ([page 29](#)).

## USING CHARTS

Your unit has a worldwide imagery map, a built-in detailed map of US inland lakes, or BlueChart g2 cartography for either the US shoreline or a specific country.

- **Navigation Chart**—displays all relevant navigation data available on your preloaded maps, including buoys, lights, cables, depth soundings, marinas, and tide stations in an overhead view.
- **Mariner's Eye**—a bird's eye view from above and behind your boat, for a visual navigation aid.



**NOTE:** If you are using a GPSMAP 520/520s or 525/525s, you must insert an optional BlueChart g2 Vision preprogrammed SD card to view detailed Navigation and Mariner's Eye charts.

Fishing Charts and Fish Eye 3D views are available when using optional Blue Chart® g2 Vision™ preprogrammed SD cards.

- **Fishing Chart**—removes navigational data from the preloaded map, while leaving the bottom contours and depth soundings. (This is not available on the 530/530s and 535/535s - all contour lines and depth soundings appear on the Navigation chart.)
- **Fish Eye 3D**—an underwater view that visually represents the sea floor or lake bottom according to the chart's information. (This is available for select lakes on 530/530s and 535/535s units without an additional card).

## Using the Navigation Chart

Use the navigation chart to plan your course, view map information, and as a navigational aid.



**NOTE:** For GPSMAP 520/525 units, you must insert an optional BlueChart g2 Vision preprogrammed SD card for your region to view detailed navigation charts.

To access a navigation chart, from the Home screen, select **Charts > Navigation Chart**.

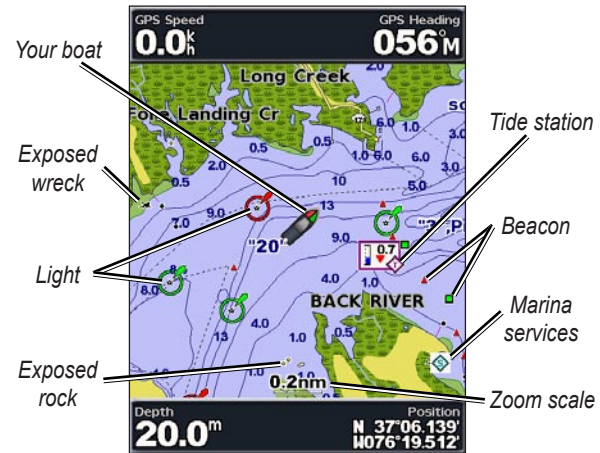

Navigation Chart with g2 Vision

## Navigation Chart Settings

To access additional settings or options for the navigation chart, press **MENU**.

**Full Screen Map (Show Numbers)**—view the navigation or fishing chart in full-screen mode, without numbers. Select **Show Numbers** to view numbers again.



Full Screen Map



Show Numbers

**WEATHER**—turn NEXRAD weather data on or off.



**NOTE:** You must plug the optional GXM 31 antenna into the XM port on the back of the unit and have a subscription to XM Satellite WX Weather to view NEXRAD data. XM is not available on the GPSMAP 520/520s, 525/525s, 550/550s, or 555/555s units. For more information on XM WX Weather, see the *GXM 31 Owner's Manual*.

**Overlay Numbers**—show or hide cruising, sailing, navigation, and fishing numbers on the navigation or fishing chart.

**Chart Setup**—customize the navigation chart. See [page 16](#).

**Chart Notes**—access detailed chart information.

## Understanding Chart Data

BlueChart g2 Vision and the US inland lake electronic charts use graphic symbols to denote map features. These symbols follow the standards of US and international charts. Other features common to most charts include depth contour lines (with deep water represented in white), intertidal zones, spot soundings (as depicted on the original paper chart), navigational aids and symbols, and obstructions and cable areas.

## Panning the Navigation Chart

Use the map pointer (🖱️) to pan away from your current location, and scroll to other areas on the navigation chart. As you pan past the edge of the current map display, the screen scrolls forward to provide continuous map coverage. The position icon (📍) stays at your present location.

As you move the map pointer, you can view the distance and bearing from your current location, and the map pointer's location coordinates in the lower-right corner of the map.

To pan the map, press up, down, right, or left on the **ROCKER**.

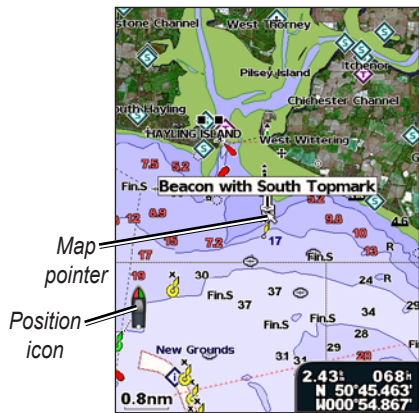

To stop panning, press **MENU**, and then select **Stop Panning**.

## Zooming In and Out on the Map

The **Range (+/-)** keys control the zoom level, indicated by the scale at the bottom of the navigation chart (**500ft**). The bar under the number represents that distance on the map.

## Accessing Additional Object Information

Use the map pointer (🖱️) to view information about on-screen map items and waypoints.

**To access additional object information:**

1. On the navigation chart, highlight an item with the map pointer, and press **SELECT**.

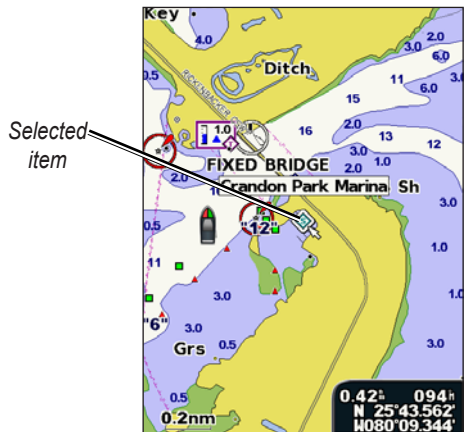



- Select the item. If more than one item is in the area, select **Review**, and then select the item.



## Viewing Tide Station Information

Tide station information appears on the chart with a detailed icon (when animated, see [page 17](#)) showing the relevant tide level. You can view an in-depth graph for a tide station to help predict the tide level at different times or different days.

Use the map pointer (☞) to highlight a tide station icon (⬠), and press **SELECT**.

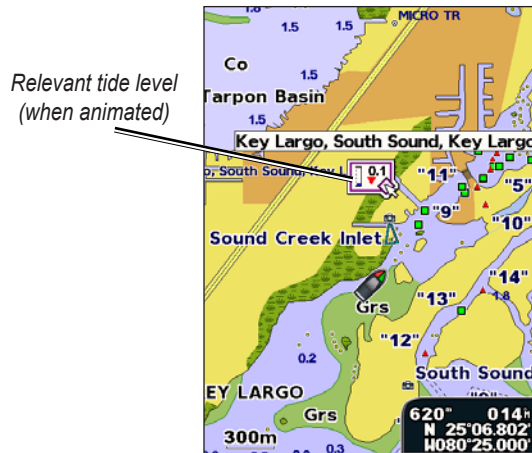

For more information about tides, see [page 26](#).



## Using the Split Navigation Chart

Use the Split Navigation Chart to view two different zoom levels of the Navigation Chart at the same time.

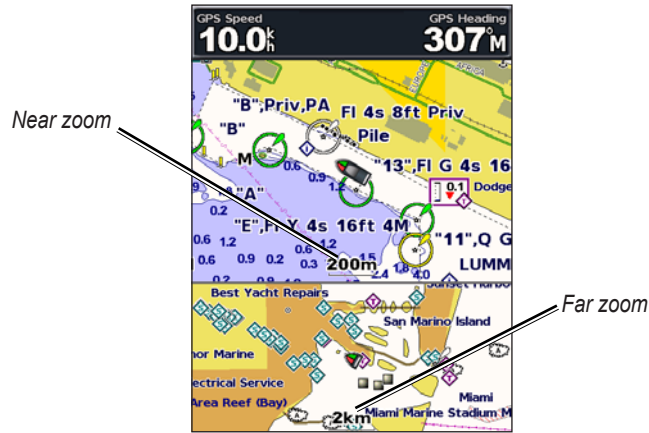

**Split Navigation Chart  
(with a BlueChart g2 Vision card)**

The top half of the screen is zoomed in 10 times closer than the bottom half of the screen. The **Range (+/-)** keys control the zoom level.

Press **MENU** to view additional settings. See [page 8](#).

## Using BlueChart g2 Vision

Optional BlueChart g2 Vision preprogrammed SD cards allow you to get the most out of your unit. In addition to detailed marine charting, BlueChart g2 Vision has the following features:

- **Mariner's Eye 3D**—a bird's eye view from above and behind the boat, for a more visual navigation aid. The BlueChart g2 Vision Mariner's Eye 3D is more detailed than the preloaded data.
- **Fish Eye 3D**—an underwater view that visually represents the sea floor according to the chart's information.
- **Fishing Charts**—view the chart without navigational data, leaving only the bottom contours and depth soundings. This chart works best for offshore deep-sea fishing.
- **High Resolution Satellite Imagery**—high resolution satellite images are provided for a realistic view of the land and water on the Navigation chart.
- **Aerial Photos**—view marinas and other navigationally significant aerial photos to help you visualize your surroundings.
- **Detailed Roads and POI data**—view roads, restaurants, and other points of interest (POIs) along the shore.
- **Current Data**—view current station information.
- **Auto Guidance**—automatic passage planning software that helps you determine the best course to your destination.

## Using Mariner's Eye 3D

Mariner's Eye 3D provides a bird's eye view from above and behind the boat (according to your course), and provides a visual navigation aid. This view is helpful when navigating tricky shoals, reefs, bridges, or channels, and is beneficial when trying to identify entry and exit routes in unfamiliar harbors or anchorages.

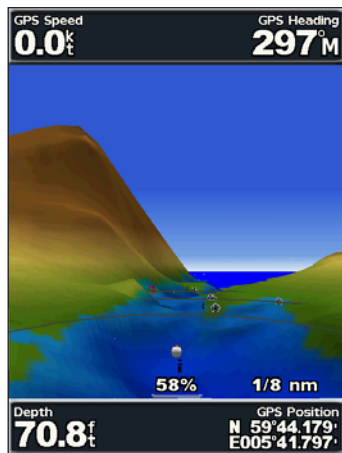

Mariner's Eye 3D

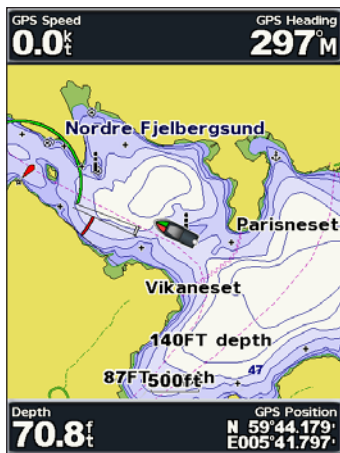

Navigation Chart

The **RANGE (+)** key moves the view closer to your boat and lower to the water, while the **RANGE (-)** key moves the view away from the boat. When adjusting the range, a scale (**58%**) appears at the bottom of the screen.

## Mariner's Eye 3D Settings

To access additional settings or options from the Mariner's Eye 3D screen, press **MENU**.

**Colors**—choose between **Normal** (Default), **Water Hazard**, and **All Hazard**. The **Normal** setting indicates land in greens and browns, and the **Water Hazard** setting indicates shallow water and land with a color scale. Blue indicates deep water, yellow and orange for shallow water, and red for very shallow water. **All Hazard** setting shows land as dark red.

**Rings**—toggle the range rings on or off.

**Tracks**—turn the track log on or off.

**Safe Depth**—adjust the depth at which red indicates shallow water.

**Nav Lane Width**—adjust the width of the course line drawn when navigating.

**Overlay Numbers**—show or hide cruising, navigation, fishing, and sailing numbers.

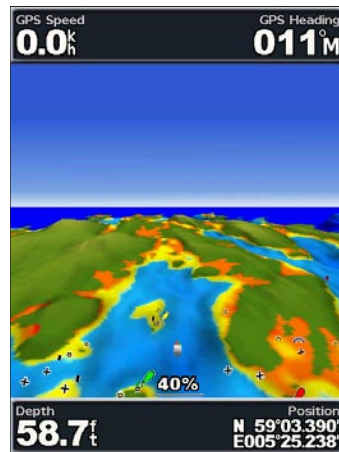

Mariner's Eye 3D  
(Water Hazard Colors)

## Using Fish Eye 3D

Using the depth contour lines of the BlueChart g2 Vision cartography, Fish Eye 3D provides an underwater view of the sea floor or lake bottom. The **RANGE** keys adjust the view in the same way as the Mariner's Eye 3D.

### Fish Eye 3D Settings

To access additional settings or options for the Fish Eye 3D, screen, press **MENU**.

**Sonar Cone**—turn a cone on or off that shows the area covered by your transducer.

**Sonar Data**—visually show the sonar readings received by your transducer for the best combination of sonar and mapping. The setting is either on or off.

**Tracks**—turn the track log on or off.

**Overlay Numbers**—show or hide cruising, navigation, or fishing numbers on the chart.



Fish Eye 3D

## Using Fishing Charts

Use the Fishing chart for a detailed, unobstructed view of the bottom contours and depth soundings on the chart.

The Fishing chart uses detailed bathymetric data on a preprogrammed BlueChart g2 Vision SD card, and is best for offshore deep-sea fishing.

To view the Fishing chart, from the Home screen select

**Charts > Fishing Chart.**



**NOTE:** You need an optional preprogrammed BlueChart g2 Vision SD card for your region to view detailed fishing charts.



**NOTE:** Because the detailed bathymetric information used by the Fishing Chart is recorded specifically for off-shore applications, the Fishing Chart is not available on Inland Lakes Vision SD cards.

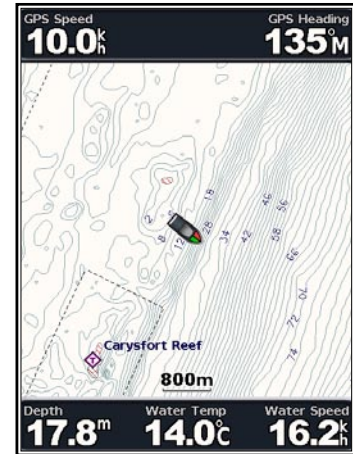

## Enabling High Resolution Satellite Imagery

You can overlay high-resolution satellite images on the land, sea, or both portions of the Navigation chart when using a preprogrammed BlueChart g2 Vision SD card.



**NOTE:** This feature is preloaded on the GPSMAP 530/530s and 535/535s units. You do not need an additional SD card.

### To enable satellite imagery:

1. While viewing the **Navigation Chart**, press **MENU**.
2. Select **Chart Setup > Appearance > Photos**.
3. Select one of the following:
  - **Off**—standard chart information is shown on the map.
  - **Land Only**—standard chart information is shown on water with photos overlaying the land.
  - **On**—photos overlay both the water and the land at a specified opacity. The higher you set the percentage, the more the satellite photos will cover both land and water.



**NOTE:** When enabled, the high resolution satellite images are only present at lower zoom levels. If you cannot see the high resolution images in your BlueChart g2 Vision region, either zoom in further using the **RANGE (+)** key, or set the detail level higher (see [page 17](#)).

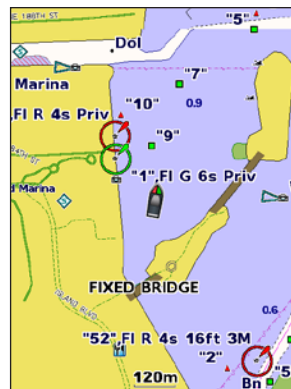

Photo Overlay Off



Land Only Photo Overlay

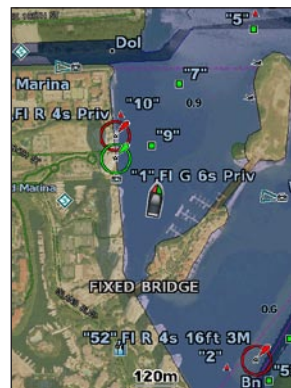

Photo Overlay at 50%

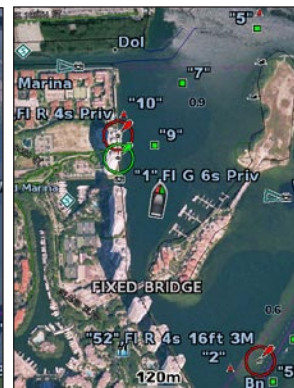

Photo Overlay at 100%

## Viewing Aerial Photos

Preprogrammed BlueChart g2 Vision SD cards contain aerial photographs of many landmarks, marinas, and harbors. Use these photos to help orient yourself to your surroundings or to help acquaint yourself with a marina or harbor prior to arrival.

- A perspective cone attached to the camera icon shows the angle at which the aerial photo was taken
- A camera icon without a perspective cone indicates an overhead photo.



**Aerial Photo**



**NOTE:** Use the RANGE (+/-) keys to zoom in and out while viewing the aerial photo on the full screen.

To access aerial photos from the navigation chart:

- 1 Use the **ROCKER** to highlight a camera with the pointer.

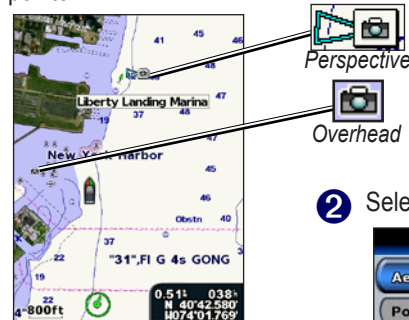

- 2 Select **Aerial Photo**.



- 3 Select **View Fullscreen**.



## Viewing Current Station Information

If current stations are available in your g2 Vision region, they appear on the navigation chart as a highlighted arrow. This detailed icon shows the current's speed and direction at a glance.



Current Station  
icon

## Detailed Road and POI Data

BlueChart g2 Vision contains detailed road and POI data, which includes highly detailed coastal roads and points of interest (POIs) such as restaurants, lodging, local attractions and more. For instructions on searching for and navigating to these POIs, see the “Where To” section beginning on [page 19](#).

## Using Automatic Guidance

Automatic Guidance automatically creates and suggests passage based on available BlueChart g2 Vision chart information. See [page 32](#) for instructions on setting up Automatic Guidance for your boat. The “Where To” section on [page 19](#) has more information on how to use Automatic Guidance.

## Changing the Chart Settings

To change chart settings, from the Home screen, select **Charts > Chart Setup**.

**Orientation**—change the perspective of the map display:

- **North Up**—sets the top of the map display to a north heading.
- **Track Up**—sets the map display to the current track heading.
- **Course Up**—sets the map so the direction of navigation is always up and turns the course line vertical on the screen.

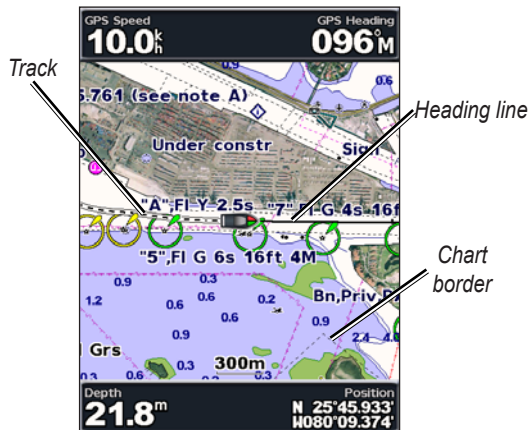



**Heading Line**—draws an extension from the bow of the boat in the direction of travel.

- **Off**—turn off the heading line.
- **Distance**—sets the distance to the end of the heading line.
- **Time**—sets the amount of time until you reach the end of the heading line.

**Chart Borders**—turn on chart borders if you load BlueChart g2 Vision maps and you want to see what areas the maps cover.

**Tracks**—hide (off) or show (on) tracks on the chart.

**Appearance**—customize how items are shown on the map.

### Changing the Chart Appearance

From the Home screen, select **Charts > Chart Setup > Appearance**.

**Detail**—adjust the amount of detail shown on the map.



**Photos**—set optional high resolution satellite images. (page 14)

**Spot Depths**—turn on spot soundings and set a dangerous depth.

**Light Sectors**—adjust the drawing of light sectors on the map.

**Symbols**—select the navaid symbol set (NOAA or IALA).

**Symbol Size**—adjust the size of the symbols shown on the map.

**Animate Tides**—turn on a detailed icon that shows the relevant tide level on the Navigation chart. If **Off**, tide stations appear only as an icon (Ⓣ) on the Navigation chart.

## Using the Chart/Sonar Screen

Use the Chart/Sonar screen to view the Navigation Chart, Fishing Chart, Mariner's Eye 3D, or Fish Eye 3D and sonar at the same time.

### To view a split chart/sonar screen:

1. From the Home screen, select **Chart/Sonar**.
2. Select the type of chart on the split screen.

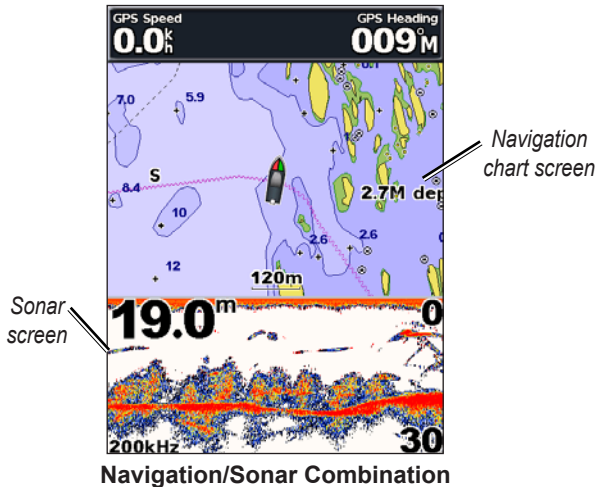

To access additional settings or options for the chart/sonar screen, press **MENU**.

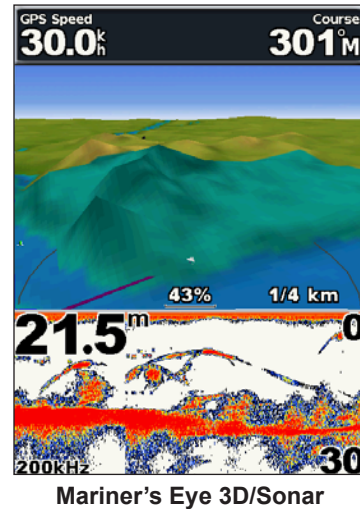

**NOTE:** The **Chart/Sonar** screen, like the **Sonar** screen, is only available when using a sonar capable unit with a transducer attached.



## WHERE TO

Use the **Where To** option on the Home screen to search for, and navigate to, nearby fuel, repairs, marinas, ramps, waypoints, and routes.



**NOTE:** You have to create waypoints and routes before you can navigate to them.

You can navigate to a destination using one of three methods: Go To, Route To, or Guide To.

- **Go To**—takes you directly to the destination.
- **Route To**—creates a route from your location to a destination, allowing you to add turns to the route.
- **Guide To**—searches BlueChart g2 Vision chart data to suggest the best path to your destination.



**CAUTION:** Guide To does not assure obstacle and bottom clearance. For safety, always resolve any discrepancies or questions before continuing navigation.

## Navigating to a Destination

You can search for, and navigate to, nearby destinations including fuel, repairs, marinas, waypoints, and routes.

### To begin navigating:

1. From the Home screen, select **Where To**.
2. Select the marine service category to which you want to navigate. The unit shows the list of the 50 nearest locations and the distance to each.



“Where To” Categories

Nearest “Fuel” Search Results

## WHERE TO

3. Select the marine service item to which you want to navigate.  
A screen containing information about the selected marine service appears.
4. Select **Navigate To**.
5. Select **Go To** or **Route To**.  
OR  
Select **Guide To** when using a preprogrammed BlueChart g2 Vision card to use Auto Guidance.
6. Follow the colored line on the screen to the destination.

**Grove Key Marina**  
Coconut Grove, FL 305-858-6527  
Services:  
Open Year Round  
Repairs  
Fuel:  
Gas  
Diesel  
Provisions:  
Ice  
Credit Cards Accepted:  
MasterCard  
Visa  
American Express  
Miscellaneous:  
<Prev 1/2 Next>

**Navigate To**

Back MENU

GPS Speed **10.0** <sup>k</sup>t  
Arrival **06:54** <sup>a</sup>m  
Course **280** <sup>o</sup>M  
Arrive In **2.02** <sup>n</sup>m  
Bearing **280** <sup>o</sup>M  
Depth **14.2** <sup>m</sup>  
Position **N 25°43.585'**  
**W 080°11.766'**

**SELECT** Press SELECT to accept changes.  
**MENU** Press MENU to cancel changes.

## To stop navigating:

Press **MENU**, and then select **Stop Navigating**.

## To search for a destination by name:

1. From the Home screen, select **Where To > Search by Name**.
2. Press up or down on the **ROCKER** to select a number or character; press left or right to move fields.
3. Press **SELECT** to view the 50 nearest destinations that contain your search criteria.

**Search by Name**

**SELECT** Press SELECT to accept changes.  
**MENU** Press MENU to cancel changes.

**Search Results 20.8"**

**Beginning**

- Grove Isle Ma 1,214'  
303h
- Rickenbacker 1,776'  
054h
- Monty Train 1,826'  
286h
- Miami Marine 1,834'  
061h
- Grove Key Ma 1,846'  
280h

**Next Page**

Back MENU

## Creating and Using Waypoints

You can store up to 1,500 alphanumeric waypoints with a user-defined name, symbol, depth, and water temp for each waypoint.

When you create a waypoint, you can designate it as a Man Overboard. This marks the point and sets a course back to the marked location. When Man Overboard is activated, an MOB waypoint with an international Man Overboard symbol is created and the unit navigates to that point.

### To mark your location:

1. From any screen, press **MARK**.
2. Select **Back** to return to the chart, or select **Man Overboard** to designate the waypoint as an MOB.



**NOTE:** Pressing the **MARK** key only creates a waypoint at your present location.

### To create a new waypoint:

1. On the Navigation or Fishing chart, move the map pointer to the location you want, and press **SELECT**.
2. Select **Create Waypoint**.



3. Select one of the following:
  - **Edit Waypoint**—customize the waypoint attributes.
  - **Delete**—delete the waypoint.
  - **Navigate To**—go to the waypoint.
  - **Back**—return to the navigation chart.

**To edit a waypoint:**

1. Create a new waypoint or select a waypoint on the navigation chart.
2. Select **Edit Waypoint**.
3. Select the waypoint attribute you want to change (**Name**, **Symbol**, **Depth**, **Water Temp**, or **Position**).



**To move the waypoint on the navigation chart:**

1. Select **Edit Waypoint** > **Position** > **Use Chart**.
2. Use the **ROCKER** to move the waypoint to a different location, and press **SELECT**.

**To view a list of all waypoints:**

From the Home screen, select **Information** > **User Data** > **Waypoints**.

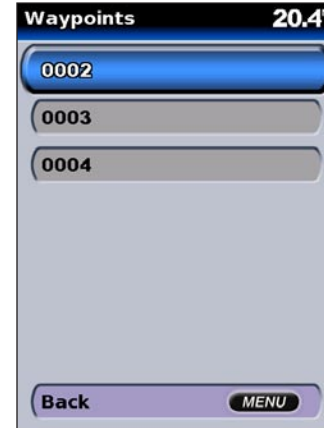

## Creating and Using Routes

You can create and store up to 20 routes, with up to 250 waypoints each.

### To create a route from your present location:

1. Move the map pointer to a destination, and press **SELECT**.
2. Select **Navigate To > Route To**.

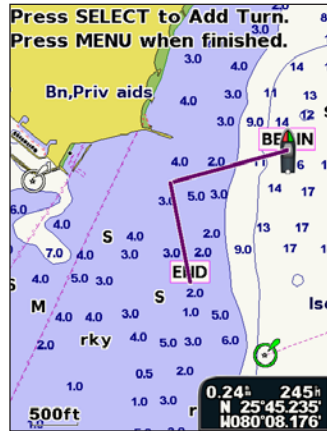

Adding a Turn to a Route

3. Use the **ROCKER** to add a turn, and press **SELECT**. Repeat this step to add additional turns.
4. Press **MENU** to cancel, undo the last turn, or to begin navigating the route.

### To create a route in another location:

1. From the Home screen, select **Information > User Data > Routes > New Route**.

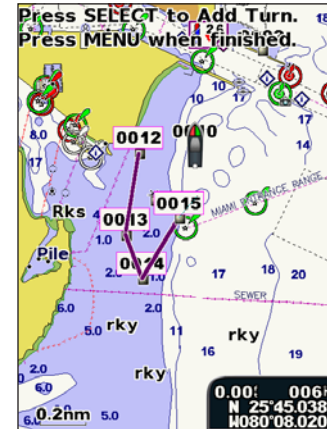

Creating a New Route

2. Use the **ROCKER** to select the route's starting point, and press **SELECT**.
3. Use the **ROCKER** and **SELECT** keys to add additional turns.
4. Press **MENU** to cancel, edit, or navigate the route.

### To edit a route

1. From the Home screen, select **Information > User Data > Routes**.
2. Select the route to edit.



3. Select **Edit Route**. You can edit the route name, turns, or delete the route.

### To delete a route:

1. From the Home screen, select **Information > User Data > Routes**.
2. Select the route to delete, and then select **Edit Route**.
3. Select **Delete**.



## VIEWING INFORMATION

Use the Information screen to access information about user data, tides, currents, celestial data, and other boats.

### Viewing Numbers

You can view and customize numerical data including depth, GPS information, and navigation information. You can customize the number of fields shown and the type of information shown in each field. You can **view** up to six fields of numerical information.

To view the numbers screen, from the Home screen, select **Information > Numbers**.

Depth	
<b>67.9<sup>f</sup></b>	
Position	
<b>N 40°31.590'</b> <b>W 073°56.683'</b>	
GPS Heading	GPS Speed
<b>083<sup>M</sup></b>	<b>10.0<sup>k<sub>t</sub></sup></b>

To customize the numbers screen:

1. From the Home screen, select **Information > Numbers**.
2. Press **Menu** and select **Configure**.
3. Select the number of fields to show (**3**, **4**, **5**, or **6**).
4. Select information to show in each field.

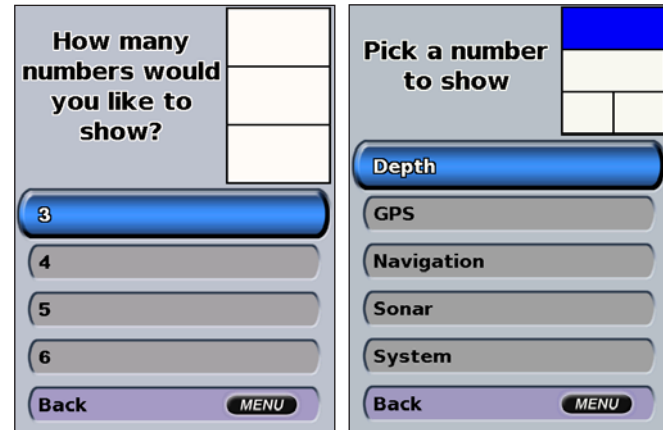

**NOTE:** The first time you use the numbers screen, you are asked to complete steps 3 and 4 for the initial setup.

## Viewing Tide Station Information

To view tide information, select **Tides** from the Information screen, then select a tide station from the list.

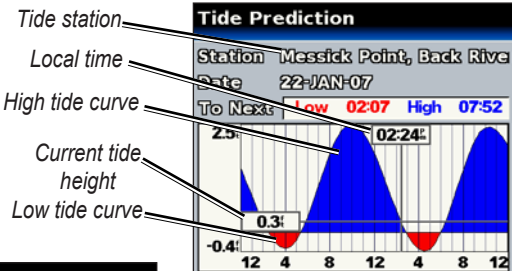
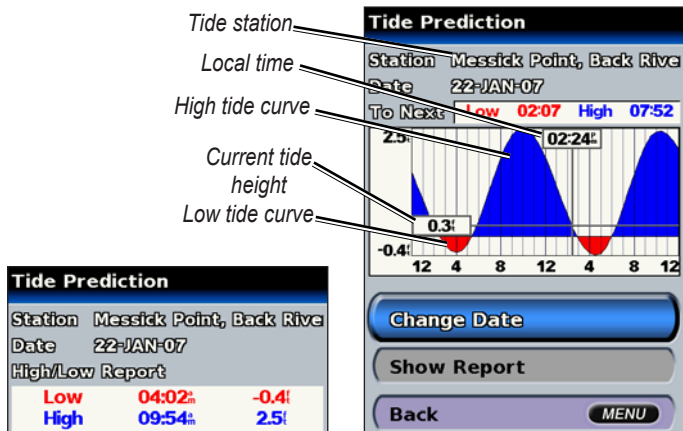

Tide Prediction Chart

- To view the Tide Prediction Report, select **Show Report**.
- To return to the Tide Prediction Chart, select **Show Tide Chart**.

Tide Prediction Report

## Viewing Current Information

Use the Current Prediction screen to view information for currents.

To view current prediction information, select **Currents** from the Information screen, then select a Current Station from the list.

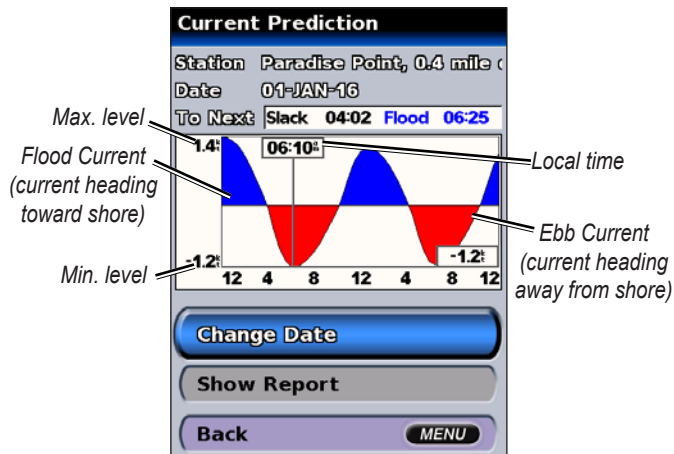

**NOTE:** You can select both tide and current station information directly from the Navigation chart. See [pages 10 and 16](#) for more information.



## Viewing Celestial Information

Use the Celestial screen to view celestial data for sun and moon rise/set, moon phase, and approximate sky view location of the sun and moon.

To view celestial information, on the Information screen, select **Celestial**.

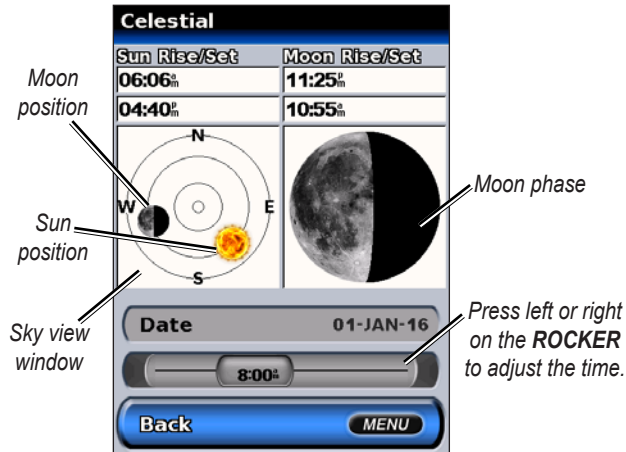

## Viewing User Data

To view user data, from the Home screen, select **Information > User Data**.

**Waypoints**—view a list of all saved waypoints.

**Routes**—view a list of saved routes.

**Tracks**—view a list of saved tracks.

**Data Transfer**—transfer waypoints, routes, and tracks to and from an SD card.

**Clear User Data**—erase all user waypoints, routes, and tracks.

### To transfer data to or from an SD card:

1. Insert an SD card into the SD card slot on the front of the unit. (See [page 5](#).)
2. From the Home screen, select **Information > User Data > Data Transfer**.
3. Complete one of the following:
  - Select **Save To Card** to save waypoints, routes, and tracks to the SD card.
  - Select **Merge From Card** to transfer data from the SD card to the unit and combine it with existing GPS data.
  - Select **Replace From Card** to overwrite items on your unit.

## Viewing Other Boats

To view information about other boats, from the Home screen, select **Information > Other Boats**.



**NOTE:** To view information about other boats, your unit must be connected to an external AIS (Automatic Identification System) or DSC (Digital Selective Calling) device. See [page 30](#) for more information.

**AIS List**—view information about all of the boats your unit is monitoring. The AIS list shows the MMSIs or (if the boat is broadcasting it) names of the AIS boats, and is sorted by range. The boat nearest to your boat appears at the top of the list.

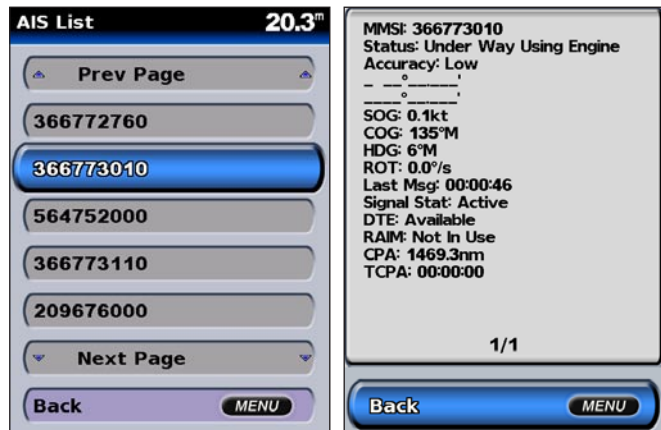

**DSC Log**—view a list of all DSC calls, sorted by most recent, sender, or by type (distress calls or position reports).

- **View by Time**—view the seven most recent DSC calls received, sorted and displayed chronologically by time and date. Calls with identical time and date information show the same information in the list.
- **View By Sender**—view an alphanumerical list of senders.
- **View By Type**—view the seven most recent distress calls or position reports, sorted chronologically.

**DSC Call List**—view the 100 most recent calls. The DSC Call List shows the most recent call from a boat. If a second call is received from the same boat, it replaces the first call in the Call List.

**Directory**—view a list of all DSC entries. You can view by name or by MMSI. You can also add an entry.

**Setup**—turn AIS and DSC on or off and set a safe zone for your boat.

## CONFIGURING THE UNIT

Use the Configure screen to configure unit settings.

### Configuring System Settings

To change general system settings, from the Home screen, select **Configure > System**.

**Simulator**—turn Simulator Mode on or off and set Simulator Mode options. (If you set the unit into a Store Demonstration mode during the initial unit setup, this setting will be named **Demo**.)

**Language**—select the on-screen language.

**Beeper/Display**—select **Beeper** to set when the unit makes audible sounds. The three settings are **Off**, **Alarms Only** (default), and **On** (keys and alarms). Select **Display** to switch between Day or Night modes and brighten or darken the backlight.

**GPS**—view GPS satellites, turn WAAS/EGNOS on or off, and initialize the GPS receiver.

**System Information**—view system information and restore factory settings.

**Event Log**—shows a list of system events.

**Overlay Numbers**—set the styles for Wind and Next Turn numbers.

## Changing Units of Measure

To change units of measure, from the Home screen, select **Configure > Units**.

**System Units**—this is a quick global setting that defines most of the individual units of measure listed below at once. **Statute (mh, ft, °F)**, **Metric (kh, m, °C)**, or **Nautical (kt, ft, °F)**.

**Depth**—individually set the units of measure for depth to **Feet (ft)**, **Fathoms (fa)**, or **Meters (m)**.

**Temperature**—individually set units of measure for temperature to **Fahrenheit (°F)** or **Celsius (°C)**.



**NOTE:** You must be receiving NMEA Sonar depth data or using a Garmin sounder module to view depth and temperature information.

**Dist, Spd, Elev**—individually set the units of measure for distance, speed, and elevation readings.

**Heading**—set the reference used in calculating heading information.

**Position**—change the coordinate system in which a given location reading appears. The default format is **hddd°mm.mmm'**. Only change the position format if you are using a map or chart that specifies a different position format.

**Time**—set the time format (**12 hour**, **24 hour**, or **UTC** time format), time zone, and indicate whether to use daylight saving time.

## Configuring Communications Settings

To change the communications settings, from the Home screen, select **Configure > Communications**.

**Serial Port 1**—select the input/output format to use when connecting your unit to external NMEA devices, a personal computer, or other Garmin devices.

- **Garmin Data Transfer**—the proprietary format used to upload, download, or exchange data with a computer or another Garmin unit.
- **Garmin Remote Sonar**—allows you to connect a Garmin GSD 21 or GSD 22 serially.
- **NMEA In/NMEA Out**—supports the input or output of standard NMEA 0183 data, DSC, and sonar NMEA input support for the DPT, MTW, and VHW sentences.
- **NMEA High Speed**—supports the input or output of standard 0183 data for most AIS receivers.
- **None**—provides no interfacing capabilities.

**NMEA Setup**—enable or disable NMEA output sentences for sounder, route, system, and Garmin NMEA settings.

### To enable or disable NMEA output sentences:

1. From the Home screen, select **Configure > Communications > NMEA Setup**.

2. Select a setting (**Sounder, Route, System, or Garmin**).
3. Select a NMEA output sentence.



4. Select **Off** to disable, or select **On** to enable the NMEA output sentence.

**Posn. Precision**—adjust the number of digits (**Two Digits, Three Digits, or Four Digits**) to the right of the decimal point for transmission of NMEA output.

**Waypoint**—select how the unit outputs waypoint identifiers (**Names or Numbers**).

# Setting Alarms

You can set the unit to sound an audible alarm when certain conditions are met. By default, all alarms are turned off.

### To set an alarm:

1. From the Home screen, select **Configure > Alarms**.
2. Select an alarm category (**Navigation, System, Sonar, or Weather Warnings**).
3. Select an alarm.
4. Select **On** to turn the alarm on, and then use the **ROCKER** to specify alarm information.

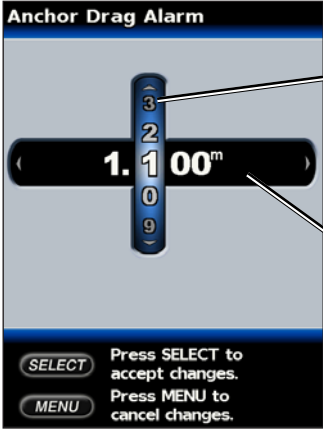

Press up or down on the **ROCKER** to increase or decrease.

Press left or right on the **ROCKER** to move fields.

## Setting Navigation Alarms

To set a navigation alarm, from the Home screen, select **Configure > Alarms > Navigation**.

**Anchor Drag**—set an alarm to sound when you exceed a specified drift distance.

**Arrival**—set an alarm to sound when you are within a specified distance or time from a destination waypoint.

**Off Course**—set an alarm to sound when you are off course by a specified distance.

## Setting System Alarms

To set a system alarm, from the Home screen, select **Configure > Alarms > System**.

**Clock**—set an alarm using the system clock. The unit must be on for the clock alarm to work.

**Battery**—set an alarm to sound when the battery reaches a user-determined low voltage.

**GPS Accuracy**—set an alarm to sound when the GPS location accuracy falls outside the user-determined value.

## Setting Sonar Alarms

To set a sonar alarm, from the Home screen, select **Configure** > **Alarms** > **Sonar**.

**Shallow Water/Deep Water**—set an alarm to sound when the depth is less than or greater than the specified value.

**Water Temp**—set an alarm to sound when the transducer reports a temperature that is 2° F (1.1° C) above or below the specified temperature.

**Fish**—set an alarm to sound when the unit detects a suspended target of the specified symbols.



---

**NOTE:** You must have a transducer connected. If your unit does not have a built-in sounder, then you must install a GSD 21 or GSD 22 sounder module to receive sonar information.

---

## Setting Weather Alarms

To set a weather alarm, from the Home screen, select **Configure** > **Alarms** > **Weather Alarms**.



---

**NOTE:** You must have a subscription to XM WX Weather and the optional GXM 31 antenna plugged into the XM port on the back of your unit to view weather information. XM Weather is available only on GPSMAP 530/535/540/545 units. See the *GXM 31 Owner's Manual* for more information.

---

## Configuring My Boat

To configure settings for your boat, from the Home screen, select **Configure** > **My Boat**.

**Auto Guidance**—set the Auto Guidance parameters for your boat:

- **Safe Depth**—set the minimum depth (referred to the chart depth datum) to allow when calculating an auto guidance path.
- **Safe Height**—set the minimum height (referred to the chart height datum) of a bridge that your boat can safely travel under.

**Keel Offset**—offset the surface reading for the depth of a keel. This makes it possible to measure depth from the bottom of your keel instead of from the transducer's location. Enter a positive number to offset for a keel. You can enter a negative number to compensate for a large vessel that may draw several feet of water.

### To adjust the Keel Offset:

1. From the Home screen, select **Configure** > **My Boat** > **Keel Offset**.
2. Use the **ROCKER** to set the value of the keel offset.
3. Press **SELECT** to accept the number.



---

**NOTE:** Press **MENU** to cancel your changes and return to the My Boat screen.

---

**Transducer at Surface**

Enter a (+) positive number to show depth from the bottom of the keel.

**Transducer at Bottom of Keel**

Enter a (-) negative number to show depth from the surface.

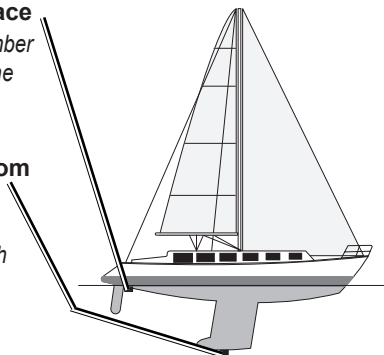
**Keel Offset**

**Transducer**—select the transducer type (**Dual Frequency** or **Dual Beam**), set the temperature source, sonar cone angles, and calibrate water speed.

- **Temp Source**—set the temperature source (**Transducer** or **NMEA**).
- **Sonar Cone Angles**—when using a transducer other than the standard Garmin transducer, you can set the angle, in degrees, of the sonar cone so it is accurately depicted on the Fish Eye 3D screen.



**NOTE:** The Sonar Cone Angles setting does not affect a standard Garmin transducer, and should only be used to match the specifications of a non-standard transducer.

- **Calibrate Water Speed**—to use a speed sensing transducer, use this menu to calibrate the speed sensor. If you do not have a speed sensing transducer, this menu does not appear.

**To calibrate the speed sensor:**

1. From the Home screen, select **Configure** > **My Boat** > **Transducer** > **Calibrate Water Speed**.
2. Bring the boat to cruising speed. Note your top speed, and then stop the boat.
3. Highlight **OK**, and press **SELECT**.
4. Use the **ROCKER** to enter your top speed, and press **SELECT**.



**NOTE:** If the boat is not moving fast enough or the speed sensor is not registering a speed, a “**Speed Too Low**” message appears. Highlight **OK**, press **SELECT**, and safely increase boat speed. If you get the message again, stop the boat and make sure the speed sensor wheel is not stuck. If the wheel turns freely, check the cable connections. If you continue to get the message, contact Garmin Product Support.

## Configuring Other Boats

To configure settings for boats other than your own, from the Home screen, select **Configure > Other Boats**.

**AIS**—turn AIS (Automatic Identification System) on or off. AIS alerts you to area traffic by providing boat IDs, position, course, and speed for boats equipped with a transponder within range.

**DSC**—turn DSC (Digital Selective Calling) on or off.



**NOTE:** To configure AIS or DSC information for other boats, your unit must be connected to an external AIS or DSC device. See [page 30](#) for more information.

**Safe Zone**—turn a safe zone around your boat on or off. This is used for collision avoidance, and can be customized:

- **Ring**—show or hide a ring on the map showing the safe zone for your boat.
- **Range**—change the measured radius of the safe zone ring to a specified distance from 0.1 to 2.0 nm (or .02 to 5.0 km, or 0.1 to 2.0 mi).
- **Time to**—sounds an alarm if AIS determines that a target will intersect the Safe Zone within the defined time interval (ranging from 3 to 24 minutes).

## Configuring XM Audio

To configure XM audio, from the Home screen, select **Configure > XM Audio**. You can delete a preset channel, select a category, enter a specific channel, and adjust the volume level.



**NOTE:** You must plug the optional GXM 31 antenna into the XM port on the back of the unit, and have a subscription to XM Radio to use XM audio features. XM Radio is available only on GPSMAP 530/535/ 540/545 units. For more information, see the *GXM 31 Owner's Manual*.





## USING SONAR

When connected to a transducer, your unit becomes a powerful fishfinder/flasher. If your unit does not have a built-in sounder, you can connect a Garmin GSD 21 or GSD 22 sounder module to your unit to use the sonar features.

### Understanding the Full Screen

Select the Full Screen option to view a full-screen graph of the transducer’s sonar readings.

From the Home screen, select **Sonar > Full Screen**.

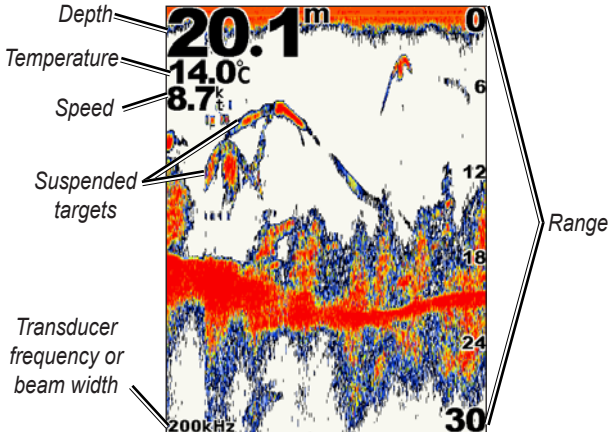

### Understanding the Flasher

The Flasher screen (dual beam transducer only) provides an almost instantaneous return of what is below your boat. The depth scale is organized as a ring that starts at the top, or 12:00, and progresses clockwise. Sonar information flashes on the ring when it is received at the depth indicated on the inside ring. Like the regular graph, the colors indicate different strengths of the sonar return.

To open the flasher, from the Home screen, select **Sonar > Flasher**.

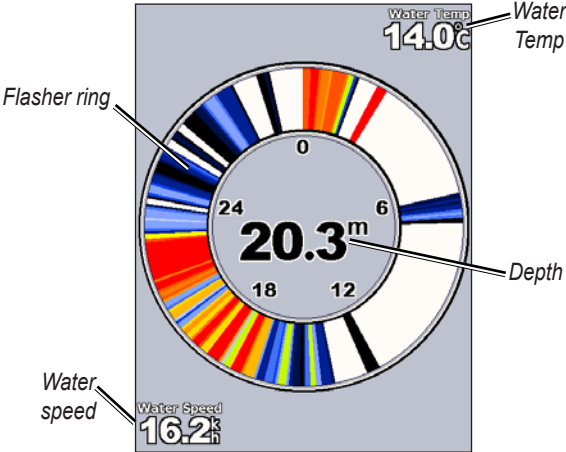

## Understanding the Split Freq Screen

Use the Split Freq screen (dual frequency transducer only) to view both the 50kHz and 200kHz frequencies on the same screen. A 50kHz frequency graph appears on the left; a 200kHz frequency graph appears on the right.

To open the Split Freq screen, from the Home screen, select **Sonar** > **Split Freq**.

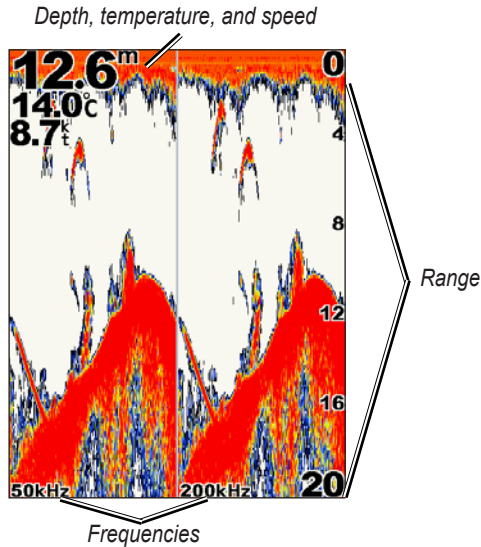

## Understanding The Split Zoom Screen

Use the Split Zoom screen to view the full sonar data from the graph and a zoomed in portion on the same screen.

From the Home screen, select **Sonar** > **Split Zoom**.

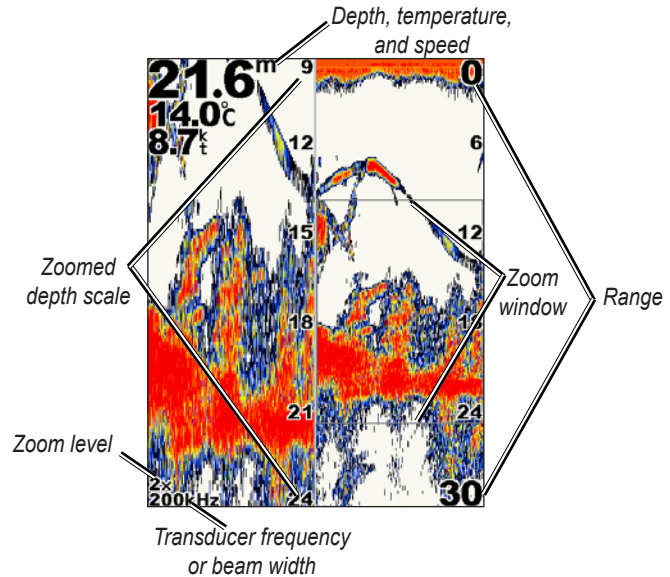

# Understanding the Temp Log Screen

If you are using a temperature-capable transducer, the Temp Log screen keeps a graphic log of temperature readings over time. The current temperature and depth are shown in the top-left corner.

From the Home screen, select **Sonar > Temp Log**.

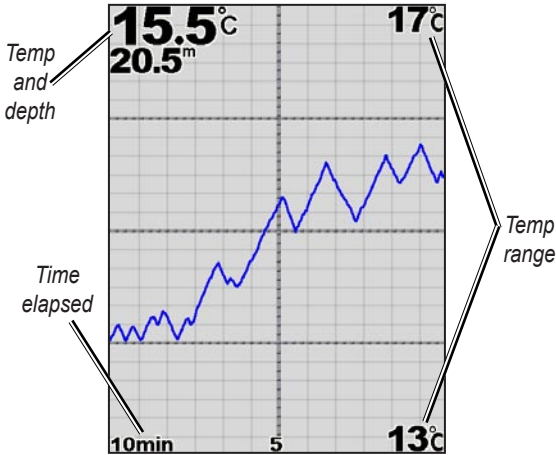

The temperature appears along the right side and the time elapsed appears along the bottom. The graph scrolls to the left as information is received.





# Setting Up Sonar

Use the Sonar Setup screen to define and adjust settings universal to all sonar screens.

From the Home screen, select **Sonar > Sonar Setup**.

**Color Scheme**—choose white or blue. This affects the background on all sonar screens, but does not change the Temp Log screen.

**Fish Symbols**—set how the sonar interprets suspended targets.

-  The unit does not interpret the sonar return data (default).
-  Suspended targets appear as symbols. Background sonar information appears, making the distinction between fish and structure easier.
-  Suspended targets appear as symbols with background information shown. The target depth of each symbol is also indicated.
-  Suspended targets appear as symbols. No background information appears.
-  Suspended targets appear as symbols with no background information shown. The target depth of each symbol is indicated.

**Scroll Speed**—adjust the rate at which the sonar scrolls from right to left (**Ultrasroll**, **Fast**, **Medium**, or **Slow**). If using a speed-capable transducer, select **Auto** to have the scroll speed automatically adjust to your boat's water speed.

**Surface Noise**—show or hide the sonar returns near the surface of the water. Hide surface noise to help reduce clutter.

**Whiteline**—highlights the strongest signal from the bottom to help identify its hardness or softness.

- **Off**—(default) Whiteline is disabled.
- **High**—the most sensitive setting. Almost all strong returns are highlighted in white.
- **Medium**—many strong returns are highlighted in white.
- **Low**—the least sensitive setting. Only the strongest returns are highlighted in white.

**Overlay Numbers**—show or hide battery voltage, water temperature, water speed (if your transducer is capable), cruising, and navigation.



---

**NOTE:** To show water temperature or water speed, change the setting to **Auto**. If the connected transducer is capable, the data is shown.

---

## Advanced Sonar Settings

To adjust advanced sonar settings, press MENU while viewing a sonar screen.

**Range**—the range of the depth scale on the right side of the screen (**Auto** or **Manual Range**).

**Gain**—controls the sensitivity of the sonar receiver (**Auto** or **Manual Gain**). To see more detail, increase the Gain. If the screen is cluttered, decrease the Gain.

**Beam**—when using a dual beam transducer, select a **Wide** or **Narrow** beam.

**Frequency**—when using a dual frequency transducer, select how the frequencies appear on screen (**200kHz**, **50kHz**, **Dual**, or **Auto**).

**Zoom**—zoom in to a section of the Full Screen. The zoom is off, or set to **No Zoom** by default. Four options are available:

- **2x Zoom**—twice the magnification.
- **4x Zoom**—four times the magnification.
- **Bottom Lock**—locks the zoom window to the bottom.
- **Split Zoom**—opens the Split Zoom screen.

**Depth Line**—quickly reference a specific depth (**On** or **Off**).

**A-Scope**—(dual frequency only) a vertical flasher along the right side of the screen (**On** or **Off**).

## INSTALLING THE UNIT

To successfully operate your unit, you must properly install the unit and all of its related parts. Compare the contents of this package with the packing list on the box. If any pieces are missing, contact your Garmin dealer immediately. Before you begin the installation:

- Read and follow the instructions to install the unit.
- Gather the appropriate fasteners and tools.
- Verify that all cables can reach the unit mounting location and the transducer.
- Wear safety goggles and a dust mask when drilling, cutting, or sanding.

**If you experience difficulty installing the unit, contact Garmin Product Support or contact a professional installer.**



**NOTE:** References to a transducer in this section apply only to units with an 's' suffix (i.e. 545s). If you do not have an 's' unit, disregard instructions on installing a transducer.

### To install and use your unit:

1. Select a location.
2. Mount the unit.
3. Install the transducer.
4. Install the wiring harness.
5. Test the installation.

## Step 1: Select a Location

Consider the following when you select an installation location:

- Provides optimal viewing as you operate your boat.
- Allows easy access to the unit's keypad.
- Is strong enough to support the weight of the unit and protect it from excessive vibration or shock.
- Allows room for the routing and connection of the power/data and transducer cables. There should be at least a 3-inch (8 cm) clearance behind the case.

DO NOT mount the unit in an area that is exposed to extreme temperature conditions.



**NOTE:** The temperature range for the unit is 5°F to 131°F (-15°C to 55°C). Extended exposure to temperatures exceeding this range (in storage or operating conditions) may cause failure of the LCD screen. This type of failure and related consequences are NOT covered by the manufacturer's limited warranty.

## Step 2: Mount the Unit

You can mount your unit in one of two ways:

- **Surface Mount**—mount the unit onto a bracket (included) that attaches to the console or overhead.
- **Flush Mount**—use the optional flush mount kit to mount the unit into a flat panel. See the “Appendix” for more information.

### *Surface Mounting the Unit*

The unit’s compact, waterproof case is suitable for mounting in exposed locations or at the navigation station. The unit comes with a tilt/swivel mounting bracket that can be used for console mounting.

Note: Be sure to mount the unit 95cm (37 1/2")

### **Mounting the Bracket Assembly**

**Tools (not included)**—drill, screwdriver (Phillips or standard), and one of the following:

- Three #8 (4 mm) pan-head machine bolts with matching nuts and washers and a  $5/32$ " (5 mm) drill bit.
- Three #8 pan-head self-tapping screws and a  $1/16$ " drill bit for drilling starter holes.

Use a pan-head machine bolt or self-tapping screw to secure the swivel base. If you use a screw with a countersunk head, you risk damaging the mounting bracket.

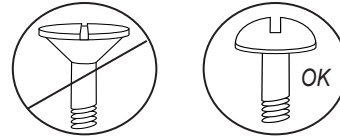

**To mount the bracket assembly:**

- Using the swivel base as a template, mark the location of the three holes that secure the bracket to the mounting surface.
- Drill the mounting holes.
  - If you secure the base with machine bolts, drill three  $\frac{5}{32}$ " (5 mm) holes at the locations you marked.
 OR
  - If you secure the base with self-tapping screws, drill starter holes at the locations you marked. Do not make the starter holes deeper than half the screw length.



- Secure the swivel base with three bolts or screws. **DO NOT OVERTIGHTEN.**
- Place the swivel mount bracket over the swivel base and secure it with the short knob.

**To install the unit on the mounting bracket:**

- Align the slot on the back of the unit with the long mounting knob, and slide the unit into place. If necessary, adjust the long knob to spread the bracket arms apart. (Turn counter-clockwise to widen the bracket arms and clockwise to tighten.)
- Adjust the unit angle, and tighten the long mounting knob until snug.



- Rotate the swivel mount bracket by twisting it left or right. The bracket clicks as you turn it. Select a good viewing angle, and then tighten all knobs.
- Connect the power/data and transducer cables to the back of the unit, making sure the locking rings are fully tightened on both connectors.

### Step 3: Install the Transducer

Proper transducer installation is key to getting the best performance from your unit. If the transducer lead is too short, extension cables are available from your Garmin dealer. Coil and secure any excess cable.



**CAUTION:** DO NOT cut the transducer lead or any part of the transducer cable. Cutting the transducer cable voids your warranty. The cable cannot be spliced and connected to any existing (Garmin or non-Garmin) transducer cables.

The following pages contain tips and basic installation instructions for some popular transducers. Detailed installation instructions are provided in the transducer kits. Some transducers might have to be installed by a professional marine installer.

#### To assemble the transducer:

1. Insert the rubber washer and plastic spacer into the transducer at the same time. DO NOT lubricate the rubber washer.
2. Route the cable toward the back of the transducer. Slide the transducer into the transducer mount.
3. Place a 5 mm flat washer on the 10-32 x 1 3/4" screw, and insert the screw through the transducer mount, spacer, and rubber washer.
4. Place the remaining 5 mm flat washer on the exposed end. Install the 10-32 lock nut finger tight. You can tighten the transducer further after installation on the boat.

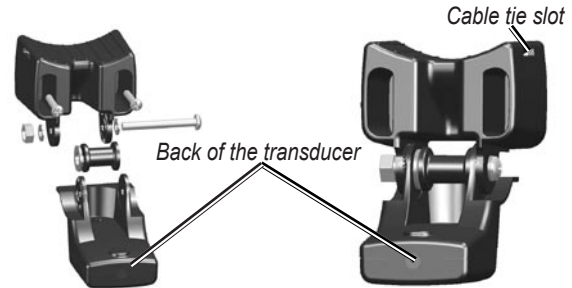



### To mount the dual beam transducer on a trolling motor:

1. Slide the large cable tie through the slot on the transducer mount with the ridges of the band facing up until equal lengths extend on both sides of the mount.



**NOTE:** For cold water and heavy timber or debris areas, a metal 4-5" (10-12 cm) worm gear clamp is recommended.

2. Position the mount gasket on the curved top of the transducer mount.
3. Place the transducer assembly against the motor body of the trolling motor, with the front of the transducer pointed away from the trolling motor propeller.
4. Wrap the two ends of the cable tie around the motor body. Place the pointed end of the cable tie through the fastener hole on the opposite end and pull it through until it is snug but not tight. (The cable tie clicks when you pull it.)
5. Position the transducer so that it is parallel with the bottom when in use, and make sure the gasket is aligned properly. Pull the cable tie end until tight. Trim off the excess if necessary. Tighten the 10-32 locking nut until it touches the mounting bracket, and then tighten 1/4 turn more. (Do not overtighten.)

6. Route the 30-foot (9 m) transducer cable using the supplied cable ties to secure the cable to the motor shaft. You can fill the forward-facing portion (except the cable tie pocket) of the transducer mount with sealant to avoid accumulating debris.



**NOTE:** Leave slack in the cable to avoid damage to the cable while using the trolling motor.

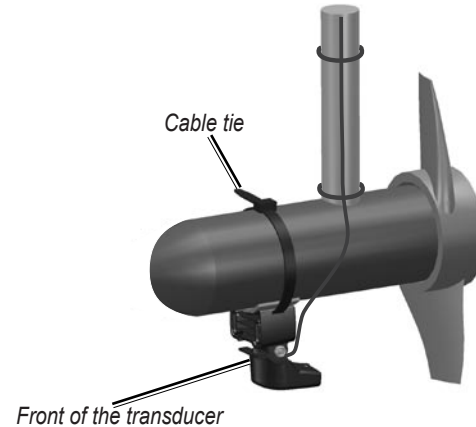

## Mounting the Transducer on a Transom

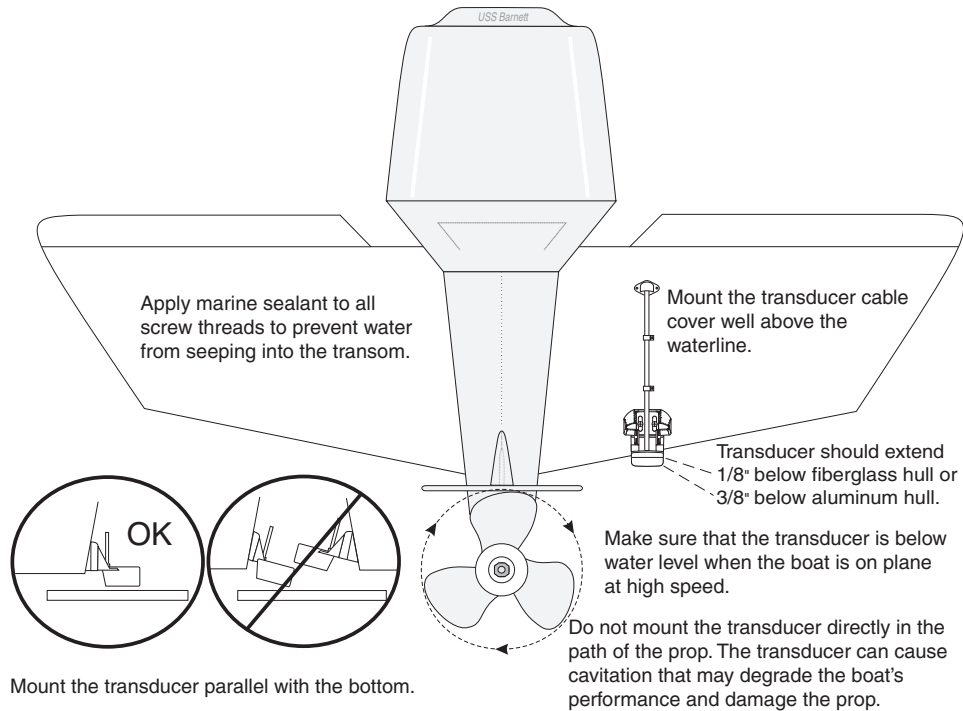

When selecting a transom mount location, consider the following for optimal performance:

- For your sonar to operate properly, the transducer must be located in calm water. DO NOT mount the transducer behind strakes, rivet lines, struts, fittings, water intake, discharge ports, eroding paint, or anything that creates turbulence.
- Mount the transducer as close to the center of the boat as possible.
- DO NOT cut the transducer lead. (This voids your warranty.)
- DO NOT mount the transducer in locations where it might be jarred when launching, hauling, trailering, or storing.
- DO NOT mount the transducer in the path of the prop on single-drive boats. The transducer can cause cavitation that can degrade the boat's performance and damage the prop. On twin-drive boats, mount the transducer between the drives, if possible.



---

**NOTE:** DO NOT mount the transducer behind strakes, struts, fittings, water intake or discharge ports, or anything that creates air bubbles or causes the water to become turbulent. The transducer must be in clean (non-turbulent) water for optimal performance.

---

**Tool List** (not included)—drill,  $\frac{3}{8}$ " wrench or socket,  $\frac{5}{32}$ " and  $\frac{1}{8}$ " drill bits, masking tape, #2 Phillips screwdriver, and marine sealant.

### To mount the transducer on a transom:

1. Position the transducer mount at the selected transom location. Make sure the transducer is parallel with the water line. Mark the center locations of each hole on the transducer mount.
2. Using a  $\frac{5}{32}$ " bit, drill the pilot holes approximately 1" (25 mm) deep at the marked locations. To avoid drilling the holes too deep, wrap a piece of tape around the bit at 1" from the point of the bit.
3. Apply marine sealant to the 5 x 30 mm screws. Attach the transducer assembly to the transom using the 5 x 30 mm screws. Adjust the transducer assembly to extend beyond the bottom of the transom approximately  $\frac{1}{8}$ " (3 mm) on fiberglass hulls or  $\frac{3}{8}$ " (10 mm) on aluminum hulls. Adjust the transducer assembly to be aligned parallel with the water.
4. Tighten the 10-32 locking nut until it touches the mounting bracket, and then tighten  $\frac{1}{4}$  turn more. (Do not overtighten.)
5. Place the first cable clamp on the transducer cable approximately one third of the distance between the transducer and the top of the transom.

6. Mark the location. Using a 1/8" bit, drill a pilot hole approximately 3/8" (10 mm) deep.
7. Attach the cable clamp using a 4 x 12 mm screw. Coat the screw with marine sealant before installation. Repeat steps 5 and 6 using the other cable clamp.
8. Route the transducer cable, as needed, to the unit. DO NOT CUT THE CABLE. Avoid routing the cable with electrical wires or other sources of electrical interference.

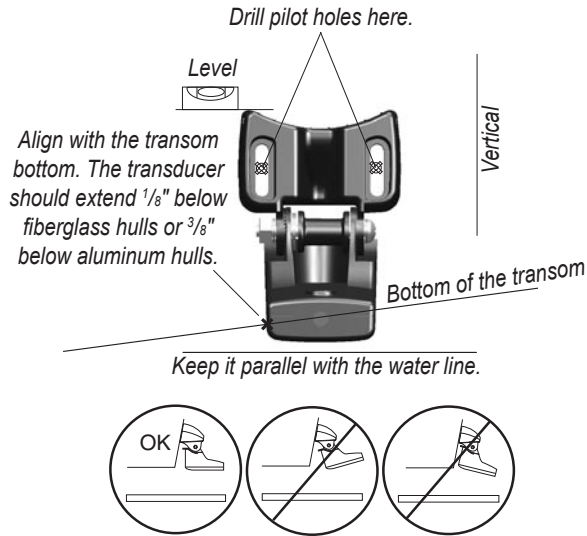

### Shoot-Thru-Hull Installation

To avoid drilling a hole to mount a thru-hull transducer, a transducer can be secured with epoxy inside a boat (shoot-thru-hull installation). This type of installation can provide better noise reduction and allow you to use a higher Gain setting. For a transducer to be mounted inside the hull (shoot-thru, not thru-hull), the boat must be fiberglass, with no core. Contact your boat manufacturer if you are unsure. Professional installation might be necessary.

Some transducers are specifically designed to be mounted inside a fiberglass hull. The standard plastic transom mount transducer can also be mounted using this method. If using a temperature sensing transducer, the temperature shown reflects the hull temperature.



**NOTE:** A solid fiberglass hull can be no more than 5/8" (9.53 mm) thick when using a 500 W transducer, and no more than 1" (25.4 mm) thick when using a 1 kW transducer.

## Selecting a Location for a Shoot-Thru-Hull Installation

When installing a transducer, the installation location must be the following:

- Solid fiberglass, without any air bubbles, laminates, fillers, or dead air space.
- In an area of clean (non-turbulent) water at all speeds.
- The location must not be over any strakes or behind any obstruction on the hull that would create turbulence.



**NOTE:** Many modern hulls have a dedicated pocket for shoot-thru-hull transducer installation. If you are unsure if your hull is equipped with a pre-located pocket, contact your hull manufacturer.

### To test the location:

1. Fabricate a test device from a section of PVC pipe or a can, as shown in the following illustration.
2. Temporarily seal the test device to the hull with caulking or RTV sealer, and fill with water or light mineral oil.
3. Place the transducer in the water, pointed directly at the bottom and weight it down. Set the unit for optimum performance. If the sonar performance is significantly degraded, another location must be tested.

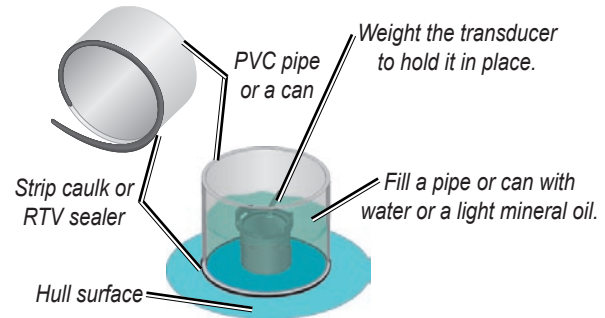

### Testing the Location

#### To permanently install the transducer:

1. Lightly sand the surface of the hull and face of the transducer with 400 grit wet or dry sandpaper.
2. Build a dam using strip caulk about 1/4" (6 mm) tall. Pour about 1/8" (3 mm) of two-part, slow-cure epoxy into the dam.
3. Place the transducer in the epoxy, turning the transducer to work out any air bubbles.
4. Weight the transducer in place, and allow it to cure for 24 hours.

## Step 4: Install the Wiring Harness

The unit comes with a wiring harness that connects the unit to power and the transducer with one easy-to-remove connection and provides interface capabilities for connecting external devices.

The color code in the diagram (see [page 49](#)) indicates the appropriate harness connections. The replacement fuse is a AGC/ 3AG - 3 Amp fuse. If it is necessary to extend the power wires, use 22 AWG wire. DO NOT cut the transducer cable, because this voids your warranty. You can wire the unit directly to the battery. If your boat has an electrical system, you might be able to wire the unit directly to an unused holder on your current fuse block. If you are using the boat's fuse block, remove the in-line fuse holder supplied with the unit.



**CAUTION:** The maximum unit input voltage is 35 Volts DC. Do not exceed this voltage, because this can damage the unit and void the warranty.



**NOTE:** During a typical installation, use only the Red and Black wires. The other wires do not have to be connected for normal operation of the unit. For information on connecting to a NMEA or CANet compatible device, see [page 50](#).

### To install the wiring harness:

1. Use a test light or voltmeter to determine the polarity of the voltage source.
2. Connect the Red (+ or positive) wire to the positive voltage terminal. (If you use the boat's fuse block, route the positive connection through the fuse, as shown on the diagram.)
3. Connect the Black (- or ground) wire to the negative voltage terminal.
4. Install or check the 3-Amp fuse (on the boat's fuse block or in the in-line holder).
5. Align the notches on the cable plug and on the back of the unit. Insert the cable into the connector, and turn the lock ring counter-clockwise until it stops.

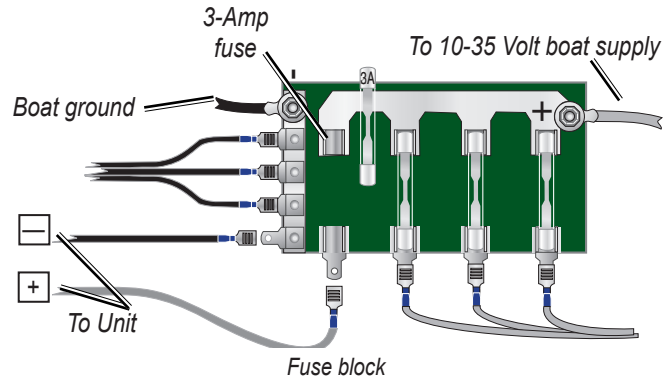

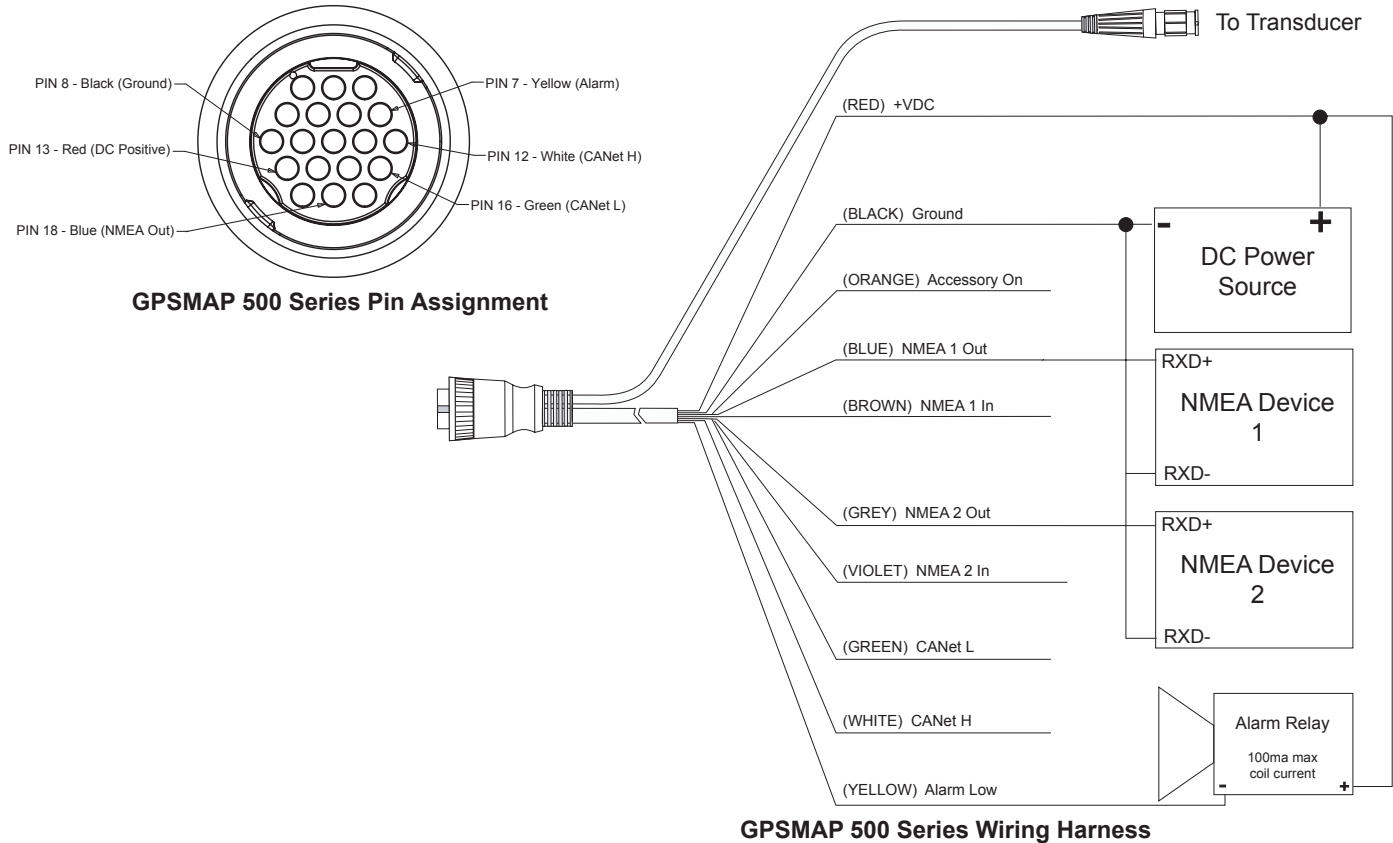

## Connecting to a NMEA device

You can connect the unit to other NMEA compatible equipment, such as a DSC or AIS device. Refer to the wiring diagram on [page 49](#) for connecting the unit to NMEA compatible devices.

### To install the wiring harness to a GPS or other NMEA device:

1. Follow the voltage source installation steps (see [page 48](#)). For Garmin units, the ground (Black) wires serve as NMEA ground and must be attached together or on the same terminal. Refer to the wiring diagram of your GPS unit for wire identification.
2. Connect the Blue (NMEA Out 1) wire from the unit to the NMEA In wire on the NMEA unit's wiring harness, and the brown (NMEA In 1) wire to the NMEA Out wire on the NMEA unit's wiring harness.
3. Repeat step 2 using the Grey and Violet wires for an additional NMEA unit.
4. Set the unit's serial port(s) to use **NMEA In/NMEA Out** ([page 30](#)).

## Interfacing with NMEA

The unit allows for NMEA 0183, Version 3.01 output with a compatible GPS or navigation device. You must set the unit's serial port(s) to **NMEA In/NMEA Out** to send data and receive data ([page 30](#)).

The SDDBT, SDDPT, SDMTW, SDVHW, SDWPL sentences are sent and received in NMEA 0183, Version 3.01.

You can purchase complete information about National Marine Electronics Association (NMEA) format and sentences from:  
NMEA

Seven Riggs Avenue  
Severna Park, MD 21146 USA  
[www.nmea.org](http://www.nmea.org)

## Installing the Unit to a Garmin CANet

The unit is a CANet-compatible Garmin device, and can send or receive sonar information from another CANet-compatible Garmin device. Using the CANet optimizes the performance of CANet-compatible units, allowing sonar information from a Sounder or Fishfinder to be shared with up to two CANet compatible Garmin GPS units. A standard NMEA connection only allows depth, temperature, and speed information to be sent to a single GPS device, whereas a CANet connection provides full sonar readings, including Ultrascroll™, so you can view and control the same information on your compatible Garmin GPS unit(s) as you can on your compatible Garmin Sounder or Fishfinder.



---

**NOTE:** To use the Garmin CANet with your unit, you must obtain a CANet Kit. Contact your Garmin dealer, or visit [www.garmin.com](http://www.garmin.com).

---



## Step 5: Test the Installation

To turn on your unit for the first time, press and hold the **POWER** key until the unit beeps and turns on. Use the **ROCKER** and the **SELECT** keys and follow the screens to configure your unit.



---

**NOTE:** Although it is possible to perform some checks with the boat trailered, the boat should be in the water to properly test the installation.

---

### To configure your unit for the first time:

1. Select the **Language**.
2. Select attached **NMEA Devices**.
3. Select the **Transducer** type (if applicable).
4. Select the **Position Format** (the default is hddd°mm.mmm').
5. Select the **Time Format** (the default is 12 Hour).
6. Select your **Time Zone**.
7. Select your preferred **Units** of measure.
8. Select a **Minimum Depth**.
9. Select the **Overhead Clearance** of your boat.

The Home screen appears (see [page 6](#)) after you select your configuration options.



---

**NOTE:** You can adjust these options in the future from the Configure screen.

---

Because water is necessary to carry the sounder's sonar signal, the transducer must be in the water to work properly. You cannot get a depth or distance reading when out of the water.

When you place your boat in the water, check for leaks around any screw holes that were added below the water line. **DO NOT** leave your boat in the water for an extended period of time without checking for leaks.

**To test the transom mount transducer installation:**

1. Begin testing the installation at a slow speed. If the sonar appears to be working properly, gradually increase the boat's speed while observing the sonar's operation. If the sonar signal suddenly is lost or the bottom return is severely degraded, note the speed at which this occurs.
2. Return the boat to the speed at which the signal was lost. Make moderate turns in both directions, and see if the signal improves.
3. If the signal strength improves while turning, adjust the transducer so that it extends another  $\frac{1}{8}$ " below the transom of the boat. It might take several adjustments to eliminate the degradation.
4. If the signal does not improve, you might have to move the transducer to a different location.



---

**NOTE:** When adjusting the depth of the transducer, make the adjustments in small increments. Placing the transducer too deep can adversely affect the boat's performance and put the transducer at greater risk of striking underwater objects.

---

## APPENDIX

### Specifications

#### *Physical Specifications*

**Size:** 6.4" H x 5.9" W x 2.9" D (16.3 cm x 15.0 cm x 7.4 cm)

**Weight:** less than 1.75 lbs (0.8 kg)

**Display:** **GPSMAP 525/535/545/555:** 5.0" diagonal (12.7 cm), Full VGA display with adjustable brightness, 640 x 480 pixels, capable of 4,096 colors.

**GPSMAP 520/530/540/550:** 5.0" diagonal (12.7 cm), QVGA display with adjustable brightness, 320 x 240 pixels.

**Case:** Fully gasketed, high-impact plastic alloy, waterproof to IEC 529 IPX7 standards.

**Temp. Range:** 5°F to 131°F (-15°C to 55° C)

**Compass Safe Distance:** 95 cm

#### *Performance*

**Receiver:** Differential-ready 12-parallel channel WAAS-capable receiver

#### **Acquisition Times:**

Warm: Approx. 15 seconds

Cold: Approx 45 seconds

AutoLocate: Approx 2 minutes

**Update Rate:** 1/second, continuous

#### **GPS Accuracy:**

**Position:** <49 feet (15 meters), 95% typical\*

**Velocity:** 0.05 meters/sec steady state

#### **WAAS Accuracy:**

**Position:** <10 feet (3 meters), 95% typical\*

**Velocity:** 0.05 meters/sec steady rate

**Dynamics:** 6gs

\* Subject to accuracy degradation to 100 m 2DRMS under the U.S. DOD-imposed Selective Availability Program.

#### **Power**

**Power Source:** 10-35 VDC

**Usage:** 15 Watts max at 13.8 VDC

**Fuse:** AGC/3AG - 3.0 Amp

#### **Sonar**

**Power:** 1kW Transducer, 1,000 watts (RMS), 8,000 watts (peak to peak)\*;  
Dual Frequency, 500 Watts (RMS), 4,000 Watts (peak to peak);  
Dual Beam, 400 Watts (RMS), 3,200 Watts (peak to peak)

**Frequency:** 50/200 kHz (dual frequency and 1kW), 80/200 kHz (dual beam)

**Depth:** 2,500 ft (762 M) (1kW), 1,500 ft (457 M) (dual frequency),  
900 ft (274M) (dual beam)\*\*

\* 1kW transducers are supported by the GPSMAP 525s/535s/545s/555s units only.

\*\* Depth capacity is dependent on water salinity, bottom type, and other water conditions.

## Product Registration

Help us better support you by completing our online registration today! Connect to our Web site at <http://my.garmin.com>.

Keep the original sales receipt, or a photocopy, in a safe place.

### **Contact Garmin**

Contact Garmin if you have any questions while using your unit. In the USA contact Garmin Product Support by phone: (913) 397-8200 or (800) 800-1020, Monday–Friday, 8 AM–5 PM Central Time; or go to [www.garmin.com/support/](http://www.garmin.com/support/), and click **Product Support**.

In Europe, contact Garmin (Europe) Ltd. at +44 (0) 870.8501241 (outside the UK) or 0808 2380000 (within the UK).

## Caring for the Unit

The case is constructed of high-quality materials and does not require user maintenance, except cleaning.

### **Cleaning the Case**

Clean the unit's outer casing (except for the screen) using a cloth dampened with a mild detergent solution and then wipe dry. Avoid chemical cleaners and solvents that may damage plastic components.

### **Cleaning the Screen**

The unit's lens is coated with a special anti-reflective coating that is sensitive to skin oils, waxes and abrasive cleaners. Cleaners containing ammonia, alcohol, abrasives, or anti-grease detergents will harm the anti-reflective coating. It is important to clean the lens using an eyeglass lens cleaner (that is specified as safe for anti-reflective coatings) and a clean, lint-free cloth.

### **Water Immersion**

The unit is waterproof to IEC Standard 60529 IPX7. It can withstand immersion in 1 meter of water for 30 minutes. Prolonged submersion can cause damage to the unit. After submersion, be certain to wipe and air dry the unit before reuse.

## Alarms and Messages

The unit uses an on-screen message system to alert you to unit operating characteristics. When a message appears, press **MENU** to acknowledge the message.

**Accuracy Alarm**—the GPS accuracy has fallen outside of user-set value.

**AIS: Dangerous Target**—shows the MMSI (Maritime Mobile Service Identity) of the dangerous target.

**Alarm Clock**—the alarm clock has sounded.

**Anchor Drag Alarm**—you have drifted out of the specified distance range.

**Antenna Input is Shorted**—some part of the antenna wiring is contacting the chassis.

**Arriving At [Waypoint Name]**—you arrived at the destination waypoint. You can **Stop Navigation** when this message appears.

**Battery Alarm**—battery voltage has fallen below the value entered in the Battery Alarm setup.

**Battery Voltage Is Too High**—too much input voltage; the unit shuts off in 10 seconds. Decrease the input voltage to 35 Volts or less.

**Boat Is Not Moving Fast Enough to Calibrate**—the boat is not moving fast enough for the speed wheel to provide a valid speed.

**Can't Read User Card**—error reading card; remove and reinsert. Contact your dealer or Garmin Product Support if the problem persists.

**Can't Read Voltages That High, Limited To Top Of Range**—the voltage value in the Battery Alarm setup is higher than the unit can read.

**Can't Read Voltages That Low, Limited To Bottom Of Range**—voltage value in the Battery Alarm setup is lower than the voltage where the unit automatically turns off.

**Can't Unlock Maps**—data on data card is not unlocked for the unit. Contact your dealer or Garmin Product Support.

**Can't Write User Card, Card May Be Full**—error reading card; remove and reinsert. Contact your dealer or Garmin Product Support if the problem persists.

**Can't Write User Card, Card Is Read-Only**—the SD card in your unit contains data copy protection.

**Check XM Antenna\***—internal problem with your GXM 31 antenna. Contact Garmin Product Support.

**DSC Position Report Received From**—shows the MMSI or name associated with an MMSI.

**Database Error**—internal problem with the unit. Contact your dealer or Garmin Product Support to have the unit serviced.

**Deep Water Alarm**—the Deep Water Alarm depth has been reached.

**Directory Item With This MMSI Already Exists**—the MMSI number is already in DSC directory. Use a different number.

**Directory Memory is Full, Can't Create Entry**—the DSC directory has reached maximum of 100 contacts. Delete unneeded contacts to add new ones.

**Distress Call**—a DSC distress call has been received. Take appropriate action.

**Entering (Leaving) target water temperature**—the target water temperature is 2° F (1.1° C) above or below the temperature specified by the Water Temperature Alarm. These messages appear when you enter or leave that zone.

**Fish Alarm**—a beep sounds (if enabled) when a fish is detected. This alarm does not show a message banner.

**Flash Flood Warning\***—a flash flood warning was issued for the area by the National Weather Service.

**Flood Warning\***—a flood warning was issued for the area by the National Weather Service.

**Invalid MMSI**—enter a Valid MMSI.

**Lost Satellite Reception**—the unit has lost satellite signals. Check antenna connections or try moving to a location with a clear view of the sky.

**Marine Warning\***—a marine warning was issued by the National Weather Service.

**NMEA Depth Is Below Transducer**—you must enter an appropriate Keel Offset for the transducer.

**No Waypoints/Routes/Tracks/User Waypoints Found**—attempted to transfer user data from an SD card that does not contain the specified type of data. Make sure there is data to transfer on the SD card.

**No XM Signal\***—the GXM 31 antenna is not receiving an XM signal.

**Off Course Alarm**—you are off course the distance set in the “Off Course” alarm.

**Route Already Exists**—you entered a route name that already exists in memory. Modify the route name or delete the previous route name.

**Route Full**—you attempted to add more than 250 points to a route. Reduce the number of points or create a second route.

**Route Truncated**—uploaded route from another device has more than 250 waypoints and was truncated to fit.

**Route Waypoint Memory Full**—no additional route waypoints can be saved.

**Severe Storm Warning\***—a severe storm warning has been issued for the area by the National Weather Service.

**Shallow Water Alarm**—the Shallow Water Alarm depth has been reached.

**Sonar Service Incompatible**—the external sonar device you are connected to needs a software update.

**Sonar Timeout**—there is an internal problem with the unit. Contact your dealer or Garmin Product Support to have the unit serviced.

**Sonar Service Lost**—the external sonar device you were connected to has either been disconnected or the unit has lost communication with the sonar device for some other reason.

**Tornado Warning\***—a tornado warning was issued for the area by the National Weather Service.

**Track Already Exists [Track Name]**—you entered a saved track name that already exists in memory. Modify the track name or delete the existing track.

**Track Log Full**—the track log is full and track recording has been turned off. To record more track points, you need to clear the track log and turn track recording on. This only appears when the track recording setting is set to “Stop When Full.”

**Track Memory is Full, Can’t Create Track**—the track log memory is full. No additional track log data can be stored without deleting old data to create memory space.

**Track Truncated**—a complete uploaded track does not fit into memory. The oldest track log points were deleted to make space for the most recent data.

**Transducer Disconnected, Sonar Turned Off**—there is not a transducer attached, bad cable/transducer, or the transducer cable was disconnected. If the transducer cable is removed while the unit is on, reconnect and cycle power.

**Transfer Complete**—the unit has finished uploading or downloading information to the connected device.

**User Card Not Found, Please Insert Card**—attempted to transfer user data without an SD card containing user data being present in the SD card slot.

**Water Speed Sensor Is Not Working**—the speed sensor is not detected. Check the connections.

**Water Temperature Alarm**—sonar has reported a temperature above, below, inside, or outside the specified value(s).

**Waypoint Already Exists**—you entered a waypoint name that already exists in memory. Modify the waypoint name or delete the existing waypoint.

**Waypoint Memory Full**—you have used all 1,500 waypoints available. Delete unwanted waypoints to make space for new entries.

**Weather Service Lost\***— the external weather you were connected to has either been disconnected or the unit has lost communication with the device for some other reason.

**XM Service Incompatible\***— the external XM antenna you are connected to needs a software update.

\* This message appears only if you have a GXM 31 antenna connected and a subscription to XM WX Weather.



## Weather Data Warranty

THE WEATHER DATA SOFTWARE PRODUCT IS PROVIDED “AS IS.” ALL OTHER WARRANTIES, EXPRESSED OR IMPLIED, INCLUDING ANY WARRANTY OF MERCHANTABILITY OR FITNESS FOR A PARTICULAR PURPOSE OR OF NON-INFRINGEMENT ARE HEREBY EXCLUDED.

### USER SAFETY

If you use XM Services it is your responsibility to exercise prudent discretion and observe all safety measures required by law and your own common sense. You assume the entire risk related to your use of the Services. XM and Garmin assume no responsibility for accidents resulting from or associated with use of the Services. Your Radio Service includes traffic and weather information, and you acknowledge that such information is not for “safety for life”, but is merely supplemental and advisory in nature, and therefore cannot be relied upon as safety-critical in connection with any aircraft, sea craft or automobile usage. This information is provided “as is” and XM and Garmin disclaim any and all warranties, express and implied, with respect thereto or the transmission or reception thereof. XM and Garmin further do not warrant the accuracy, reliability, completeness or timeliness of the traffic and weather information disclosed on the Radio Service. In no event will XM and Garmin, their data suppliers, service providers, marketing/distribution, software or Internet partners or hardware manufacturers be liable to you or to any third party for any direct, indirect, incidental, consequential, special, exemplary or punitive damages or lost profits resulting from use of or interruptions in the transmission or reception of the Services.

### LIMITS ON OUR RESPONSIBILITY

#### a) DISCLAIMERS.

EXCEPT AS EXPRESSLY PROVIDED HEREIN, WE MAKE NO WARRANTY OR REPRESENTATION, EITHER EXPRESS OR IMPLIED, REGARDING THE RADIO SERVICE. YOUR USE OF THE SERVICE IS AT YOUR SOLE

RISK. THE CONTENT AND FUNCTIONALITY OF THE SERVICE IS PROVIDED “AS IS” WITHOUT ANY WARRANTY OF ANY KIND, EXPRESS OR IMPLIED. ALL SUCH WARRANTIES OR REPRESENTATIONS (INCLUDING, WITHOUT LIMITATION, THE IMPLIED WARRANTIES OF MERCHANTABILITY, FITNESS FOR A PARTICULAR PURPOSE, TITLE AND NON-INFRINGEMENT) ARE HEREBY DISCLAIMED.

#### b) LIMITATIONS OF LIABILITY.

WE ARE NOT RESPONSIBLE FOR ANY SPECIAL, INCIDENTAL, OR CONSEQUENTIAL DAMAGES OR LOSSES RELATING TO THE USE OF THE RADIO SERVICE, WHETHER BASED ON NEGLIGENCE OR OTHERWISE. OUR TOTAL LIABILITY TO YOU AND ANY OTHER PERSONS RECEIVING OUR SERVICES, REGARDLESS OF THE CAUSE, WILL IN NO EVENT EXCEED THE AMOUNTS THAT YOU HAVE PAID TO US FOR THE SERVICE THAT YOU RECEIVED DURING THE SIX (6) MONTH PERIOD IMMEDIATELY PRIOR TO THE SPECIFIC EVENT THAT GAVE RISE TO THE APPLICABLE DAMAGE OR LOSS. THIS ALLOCATION OF RISK IS REFLECTED IN OUR PRICES. YOU MAY HAVE GREATER RIGHTS THAN DESCRIBED ABOVE UNDER YOUR STATE’S LAWS

This product was developed using DAFIF™, a product of the National Geospatial-Intelligence Agency.

This product has not been endorsed or otherwise approved by the National Geospatial-Intelligence Agency, or the United States Department of Defense (10 U.S.C. 425)

a. Under 10 U.S.C. 456, no civil action may be brought against the United States on the basis of the content of a navigational aid prepared or disseminated by either the former Defense Mapping Agency (DMA), National Imagery and Mapping Agency (NIMA), or the National Geospatial-Intelligence Agency (NGA).

b. The DAFIF™ product is provided “as is,” and no warranty, express or implied, including, but not limited to the implied warranties of merchantability and fitness for particular purpose or arising by statute or otherwise in law or from a course of dealing or usage in trade, is made by NGA as to the accuracy and functioning of the product.

c. Neither NGA nor its personnel will be liable for any claims, losses, or damages arising from or connected with the use of this product. The user agrees to hold harmless the United States National Geospatial-Intelligence Agency. The user’s sole and exclusive remedy is to stop using the DAFIF product.

## **XM Satellite Radio Service Agreement**

### ***XM Satellite Radio Inc.***

Hardware and required monthly subscription sold separately. Subscription fee is consumer only. Other fees and taxes, including a one-time activation fee may apply. All programming fees and weather data subject to change. XM WX weather data displays and individual product availability vary by hardware equipment. Reception of the XM signal may vary depending on location. Subscriptions subject to Customer Agreement included with the XM Welcome Kit and available at xmradio.com. Available only in the 48 contiguous United States. XM WX is a trademark of XM Satellite Radio Inc.

## **Software License Agreement**

BY USING THE UNIT, YOU AGREE TO BE BOUND BY THE TERMS AND CONDITIONS OF THE FOLLOWING SOFTWARE LICENSE AGREEMENT. PLEASE READ THIS AGREEMENT CAREFULLY.

Garmin grants you a limited license to use the software embedded in this device (the “Software”) in binary executable form in the normal operation of the product. Title, ownership rights, and intellectual property rights in and to the Software remain in Garmin.

You acknowledge that the Software is the property of Garmin and is protected under the United States of America copyright laws and international copyright treaties. You further acknowledge that the structure, organization, and code of the Software are valuable trade secrets of Garmin and that the Software in source code form remains a valuable trade secret of Garmin. You agree not to decompile, disassemble, modify, reverse assemble, reverse engineer, or reduce to human readable form the Software or any part thereof or create any derivative works based on the Software. You agree not to export or re-export the Software to any country in violation of the export control laws of the United States of America.

## Limited Warranty

This Garmin product is warranted to be free from defects in materials or workmanship for one year from the date of purchase. Within this period, Garmin will, at its sole option, repair or replace any components that fail in normal use. Such repairs or replacement will be made at no charge to the customer for parts or labor, provided that the customer shall be responsible for any transportation cost. This warranty does not cover failures due to abuse, misuse, accident, or unauthorized alteration or repairs.

THE WARRANTIES AND REMEDIES CONTAINED HEREIN ARE EXCLUSIVE AND IN LIEU OF ALL OTHER WARRANTIES EXPRESS, IMPLIED, OR STATUTORY, INCLUDING ANY LIABILITY ARISING UNDER ANY WARRANTY OF MERCHANTABILITY OR FITNESS FOR A PARTICULAR PURPOSE, STATUTORY OR OTHERWISE. THIS WARRANTY GIVES YOU SPECIFIC LEGAL RIGHTS, WHICH MAY VARY FROM STATE TO STATE.

IN NO EVENT SHALL GARMIN BE LIABLE FOR ANY INCIDENTAL, SPECIAL, INDIRECT, OR CONSEQUENTIAL DAMAGES, WHETHER RESULTING FROM THE USE, MISUSE, OR INABILITY TO USE THIS PRODUCT OR FROM DEFECTS IN THE PRODUCT. Some states do not allow the exclusion of incidental or consequential damages, so the above limitations may not apply to you. Garmin retains the exclusive right to repair or replace the unit or software or offer a full refund of the purchase price at its sole discretion. SUCH REMEDY SHALL BE YOUR SOLE AND EXCLUSIVE REMEDY FOR ANY BREACH OF WARRANTY.

To obtain warranty service, contact your local Garmin authorized dealer or call Garmin Product Support for shipping instructions and an RMA tracking number. Securely pack the unit and a copy of the original sales receipt, which is required as the proof of purchase for warranty repairs. Write the tracking

number clearly on the outside of the package. Send the unit, freight charges prepaid, to any Garmin warranty service station.

**Online Auction Purchases:** Products sold through online auctions are not eligible for rebates or other special offers from Garmin. Online auction confirmations are not accepted for warranty verification. To obtain warranty service, an original or copy of the sales receipt from the original retailer is required. Garmin will not replace missing components from any package purchased through an online auction.

**International Purchases:** A separate warranty is provided by international distributors for units purchased outside the United States. This warranty is provided by the local in-country distributor and this distributor provides local service for your unit. Distributor warranties are only valid in the area of intended distribution. Units purchased in the United States or Canada must be returned to the Garmin service center in the United Kingdom, the United States, Canada, or Taiwan for service.

Garmin International, Inc.  
1200 East 151st Street,  
Olathe, Kansas 66062, USA  
Tel. (913) 397-8200 or  
(800) 800-1020  
Fax (913) 397-8282

Garmin (Europe) Ltd.  
Liberty House,  
Hounslow Business Park,  
Southampton, Hampshire, SO40 9RB UK  
Tel. +44 (0) 870.8501241 (outside the UK)  
0808.2380000 (within the UK)  
Fax +44 (0) 870.8501251

Garmin Corporation  
No. 68, Jangshu 2nd Road,  
Shijr, Taipei County, Taiwan  
Tel. 886/2.2642.9199  
Fax 886/2.2642.9099

## FCC Compliance

This product has been tested and found to comply with Part 15 of the FCC interference limits for Class B digital devices FOR HOME OR OFFICE USE. These limits are designed to provide more reasonable protection against harmful interference in a residential installation, and are more stringent than “outdoor” requirements.

Operation of this device is subject to the following conditions: (1) this device may not cause harmful interference, and (2) this device must accept any interference received, including interference that may cause undesired operation.

This equipment generates, uses, and can radiate radio frequency energy and may cause harmful interference to radio communications if not installed and used in accordance with the instructions. However, there is no guarantee that interference will not occur in a particular installation. If this equipment does cause harmful interference to radio or television reception, which can be determined by turning the equipment off and on, the user is encouraged to try to correct the interference by one of the following measures:

- Reorient or relocate the receiving antenna.
- Increase the separation between the equipment and the receiver.
- Connect the equipment into an outlet that is on a different circuit from the GPS unit.
- Consult the dealer or an experienced radio/TV technician for help.

This product does not contain any user-serviceable parts. Repairs should only be made by an authorized Garmin service center. Unauthorized repairs or modifications could result in permanent damage to the equipment, and void your warranty and your authority to operate this device under Part 15 regulations.

## Industry Canada Compliance

Category I radiocommunication devices comply with Industry Canada Standard RSS-210. Category II radiocommunication devices comply with Industry Canada Standard RSS-310.

## Declaration of Conformity (DoC)

Hereby, Garmin, declares that this unit is in compliance with the essential requirements and other relevant provisions of Directive 1999/5/EC.

To view the full Declaration of Conformity, see the Garmin Web site for your Garmin product: [www.garmin.com/products/](http://www.garmin.com/products/). Click **Manuals**, and then select the **Declaration of Conformity** link.

## Optional Accessories

For more information about optional accessories, go to the Garmin Web site at [www.garmin.com/products/](http://www.garmin.com/products/). You can also contact your Garmin dealer to purchase accessories. Optional accessories include:

- Flush Mount Kit
- CANet Connection Kit
- GXM 31 XM Antenna
- Preprogrammed BlueChart g2 Vision SD cards

# INDEX

## A

A-Scope 38  
 accessories 62  
 aerial photos 15  
 AIS 28, 34  
 alarms 55–58  
   battery 31  
   deep water 32  
   fish 32  
   navigation 31  
   setting 31–32  
   shallow water 32  
   sonar 32  
   system 31  
   water temp 32  
 arches 37  
 automatic guidance 16

## B

backlight  
   adjusting 2  
 beam 38  
 BlueChart g2 Vision  
   using 11–15  
 bottom lock 38  
 bracket assembly 40

## C

CANet 50  
 celestial information 27  
 Chart/Sonar screen  
   using 18  
 chart borders 17  
 charts  
   fish eye 3D 13  
   fishing 13  
   mariner's eye 3D 12  
   navigation 7  
   settings 16  
 communications settings 30  
 current stations 26  
 customizing  
   chart settings 16

## D

Declaration of Conformity 62  
 depth 29  
 depth line 38  
 DSC 28, 34

## E

event log 29

## F

fish eye 3D 13  
   settings 13  
 fishing chart 13

fish symbols 37  
 flush mount 40  
 frequency 38  
 fuse 48, 53

## G

gain 38  
 go to 19  
 GPS, wiring to a 50  
 guide to 19

## H

heading 29  
 HOME key 3

## I

input voltage 48  
 installing 39–48  
   selecting a location 39  
   testing 51  
   the mount 40  
   the transducer 42  
   the wiring harness 48  
   to a Garmin CANet 50  
 interfacing with NMEA 50

## K

keel offset  
   adjusting 32

## L

language  
   changing 29  
 LCD screen 39  
 light sectors 17  
 limited warranty 61

## M

MENU key 3  
 messages 55  
 mounting  
   bracket assembly 40  
   transducer on a transom 45  
 my boat 32

## N

navigating 19  
   go to 19  
   guide to 19  
   route to 19  
 NEXRAD 8  
 NMEA 50  
 NMEA device  
   connecting to 50  
 NMEA output sentences  
   enabling 30  
 numbers 38  
   customizing 25  
   overlay numbers 8  
   viewing 25

**O**

- object information
  - accessing 9
- obstruction 8
- optional accessories 62
- orientation 16
- other boats
  - configuring 34
  - viewing 28
- overlay numbers 8

**P**

- physical specifications 53
- position 29
- POWER/BACKLIGHT key 3
- power/data and transducer cables 39, 41

**Q**

- quick links i

**R**

- Range (sonar) 38
- RANGE keys 3
- ROCKER key 3
- routes
  - creating 23
  - deleting 24
  - viewing 27
- route to 19

**S**

- safe depth 32
- safe zone 34
- satellite imagery 11
  - enabling 14
- scroll speed 38
- SD cards
  - inserting 5
  - removing 5
- SELECT key 3
- settings
  - chart 16
  - system 29
- shoot-thru-hull installation 46
- simulator mode
  - using 4
- software license agreement 60
- sonar
  - advanced settings 38
  - setting up 37–38
  - specifications 53
- specifications 53
- speed sensor 33
- spot depths 17
- surface mounting the unit 40
- surface noise 38
- suspended targets 37
- swivel base 41
- swivel mount bracket 41
- symbols 8

**T**

- system information
  - viewing 5
- temperature 29
- test the installation 51
- tide stations 26
  - viewing information 10
- time 29
- transducer 46
  - cables 39
  - dual beam 33, 35
  - dual frequency 33, 36, 38
  - installing 42–45
- transom 45
- transom, mounting on a 44
- transom mount installation 52

**U**

- Ultrasroll 50
- units of measure
  - changing 29
- user data
  - clearing 27
  - transferring 27
  - viewing 27

**V**

- viewing
  - celestial information 27
  - currents 26

- other boats 28
- tide stations 26
- user data 27
- voltage 48

**W**

- water speed
  - calibrate 33
- water temperature 56
- waypoints
  - creating 21
  - editing 22
  - viewing 27
- weather data warranty 59
- Where To 19
- whiteline 38
- wiring harness
  - installing 48–50

**X**

- XM audio 34
- XM Satellite Radio service
  - agreement 60

**Z**

- zoom 38
  - 2x 38
  - 4x 38
- split 38



**For the latest free software updates (excluding map data) throughout the life of your  
Garmin products, visit the Garmin Web site at [www.garmin.com](http://www.garmin.com).**



© 2007 Garmin Ltd. or its subsidiaries

Garmin International, Inc.  
1200 East 151<sup>st</sup> Street, Olathe, Kansas 66062, USA

Garmin (Europe) Ltd.  
Liberty House, Hounsdown Business Park, Southampton, Hampshire, SO40 9RB UK

Garmin Corporation  
No. 68, Jangshu 2<sup>nd</sup> Road, Shijr, Taipei County, Taiwan

[www.garmin.com](http://www.garmin.com)

Part Number 190-00758-00 Rev. C