

# Owner's Manual & Safety Instructions

**Save This Manual** Keep this manual for the safety warnings and precautions, assembly, operating, inspection, maintenance and cleaning procedures. Write the product's serial number in the back of the manual near the assembly diagram (or month and year of purchase if product has no number). Keep this manual and the receipt in a safe and dry place for future reference.

REV 15h

# CENTRALPNEUMATIC®

## air punch/flange tool



Visit our website at: <http://www.harborfreight.com>  
Email our technical support at: [productsupport@harborfreight.com](mailto:productsupport@harborfreight.com)

**ITEM 01110**

When unpacking, make sure that the product is intact and undamaged. If any parts are missing or broken, please call 1-888-866-5797 as soon as possible.

Copyright© 2003 by Harbor Freight Tools®. All rights reserved.  
No portion of this manual or any artwork contained herein may be reproduced in any shape or form without the express written consent of Harbor Freight Tools. Diagrams within this manual may not be drawn proportionally. Due to continuing improvements, actual product may differ slightly from the product described herein.  
Tools required for assembly and service may not be included.

### **⚠ WARNING**

**Read this material before using this product.  
Failure to do so can result in serious injury.  
SAVE THIS MANUAL.**

# Table of Contents





Safety .....	2	Maintenance .....	12
Specifications .....	6	Parts List and Diagram .....	14
Setup .....	6	Warranty .....	16
Operation.....	9		

SAFETY

# CENTRALPNEUMATIC®

SETUP

## WARNING SYMBOLS AND DEFINITIONS

	This is the safety alert symbol. It is used to alert you to potential personal injury hazards. Obey all safety messages that follow this symbol to avoid possible injury or death.
	Indicates a hazardous situation which, if not avoided, will result in death or serious injury.
	Indicates a hazardous situation which, if not avoided, could result in death or serious injury.
	Indicates a hazardous situation which, if not avoided, could result in minor or moderate injury.
	Addresses practices not related to personal injury.

OPERATION

## IMPORTANT SAFETY INSTRUCTIONS

### INSTRUCTIONS PERTAINING TO A RISK OF FIRE, ELECTRIC SHOCK, OR INJURY TO PERSONS

**WARNING** – When using tools, basic precautions should always be followed, including the following:

#### General



To reduce the risks of electric shock, fire, and injury to persons, read all the instructions before using the tool.

#### Work Area

- Keep the work area clean and well lighted.** Cluttered benches and dark areas increase the risks of electric shock, fire, and injury to persons.
- Do not operate the tool in explosive atmospheres, such as in the presence of flammable liquids, gases, or dust.** The tool is able to create sparks resulting in the ignition of the dust or fumes.
- Keep bystanders, children, and visitors away while operating the tool.** Distractions are able to result in the loss of control of the tool.

MAINTENANCE

# Personal Safety

1. **Stay alert. Watch what you are doing and use common sense when operating the tool. Do not use the tool while tired or under the influence of drugs, alcohol, or medication.**  
A moment of inattention while operating the tool increases the risk of injury to persons.
2. **Dress properly. Do not wear loose clothing or jewelry. Contain long hair. Keep hair, clothing, and gloves away from moving parts.** Loose clothes, jewelry, or long hair increases the risk of injury to persons as a result of being caught in moving parts.
3. **Avoid unintentional starting. Be sure the switch is off before connecting to the air supply.**  
Do not carry the tool with your finger on the switch or connect the tool to the air supply with the switch on.
4. **Remove adjusting keys and wrenches before turning the tool on.** A wrench or a key that is left attached to a rotating part of the tool increases the risk of personal injury.
5. **Do not overreach. Keep proper footing and balance at all times.**  
Proper footing and balance enables better control of the tool in unexpected situations.
6.  **Use safety equipment.**  
A dust mask, non-skid safety shoes and a hard hat must be used for the applicable conditions.
7.  **Always wear eye protection.**  
Wear ANSI-approved safety goggles.
8.  **Always wear hearing protection when using the tool.**  
Prolonged exposure to high intensity noise is able to cause hearing loss.
9. **Risk of Electric Shock. This tool is not provided with an insulated gripping surface.**  
Contact with a "live" wire will also make exposed metal parts of the tool "live" and shock the operator.
10. **Avoid body contact with grounded surfaces such as pipes, radiators, ranges and refrigerators.** There is an increased risk of electric shock if your body is grounded.
11. **Explore the workpiece to avoid contact with hidden wiring.** Thoroughly investigate the workpiece for possible hidden wiring before performing work. Contact with live wiring will shock the operator.

# Tool Use and Care

1. **Use clamps or another practical way to secure and support the workpiece to a stable platform.**  
Holding the work by hand or against the body is unstable and is able to lead to loss of control.
2. **Do not force the tool.** Use the correct tool for the application. The correct tool will do the job better and safer at the rate for which the tool is designed.
3. **Do not use the tool if the switch does not turn the tool on or off.** Any tool that cannot be controlled with the switch is dangerous and must be repaired.
4. **Disconnect the tool from the air source before making any adjustments, changing accessories, or storing the tool.** Such preventive safety measures reduce the risk of starting the tool unintentionally. Turn off and detach the air supply, safely discharge any residual air pressure, and release the throttle and/or turn the switch to its off position before leaving the work area.
5. **Store the tool when it is idle out of reach of children and other untrained persons.**  
A tool is dangerous in the hands of untrained users.
6. **Maintain the tool with care.** Keep a cutting tool sharp and clean. A properly maintained tool, with sharp cutting edges reduces the risk of binding and is easier to control.
7. **Check for misalignment or binding of moving parts, breakage of parts, and any other condition that affects the tool's operation.** If damaged, have the tool serviced before using. Many accidents are caused by poorly maintained tools. There is a risk of bursting if the tool is damaged.
8. **Use only accessories that are identified by the manufacturer for the specific tool model.** Use of an accessory not intended for use with the specific tool model, increases the risk of injury to persons.

## Service

1. *Tool service must be performed only by qualified repair personnel.*
2. **When servicing a tool, use only identical replacement parts. Use only authorized parts.**
3. **Use only the lubricants supplied with the tool or specified by the manufacturer.**

## Air Source





1.  **Never connect to an air source that is capable of exceeding 200 psi.** Over pressurizing the tool may cause bursting, abnormal operation, breakage of the tool or serious injury to persons. Use only clean, dry, regulated compressed air at the rated pressure or within the rated pressure range as marked on the tool. Always verify prior to using the tool that the air source has been adjusted to the rated air pressure or within the rated air-pressure range.
2. **Never use oxygen, carbon dioxide, combustible gases or any bottled gas as an air source for the tool.** Such gases are capable of explosion and serious injury to persons.



**SAVE THESE INSTRUCTIONS.**

## Symbols and Specific Safety Instructions

### Symbol Definitions

Symbol	Property or statement	Symbol	Property or statement
<b>n<sub>o</sub></b>	No-load speed	<b>NPT</b>	National pipe thread, tapered
<b>.../min</b>	Revolutions or reciprocation per minute	<b>NPS</b>	National pipe thread, straight
<b>PSI</b>	Pounds per square inch of pressure		WARNING marking concerning Risk of Eye Injury. Wear ANSI-approved eye protection.
<b>ft-lb</b>	Foot-pounds of torque		WARNING marking concerning Risk of Hearing Loss. Wear hearing protection.
<b>BPM</b>	Blows per minute		WARNING marking concerning Risk of Respiratory Injury. Wear NIOSH-approved dust mask/respirator.
<b>CFM</b>	Cubic Feet per Minute flow		WARNING marking concerning Risk of Explosion.
<b>SCFM</b>	Cubic Feet per Minute flow at standard conditions		

## Specific Safety Instructions

1. **Do not remove the Plate Guard (8).**
2. **Wear heavy-duty gloves and keep hands away from moving parts.**
3. **Do not try to punch or flange material thicker than 16 gauge.**
4. The warnings and precautions discussed in this manual cannot cover all possible conditions and situations that may occur. It must be understood by the operator that common sense and caution are factors which cannot be built into this product, but must be supplied by the operator.
5. **WARNING:** Some dust created by power sanding, sawing, grinding, drilling, and other construction activities, contains chemicals known to the State of California to cause cancer and birth defects or other reproductive harm. Some examples of these chemicals are:
  - Lead from lead-based paints
  - Crystalline silica from bricks and cement or other masonry products
  - Arsenic and chromium from chemically treated lumberYour risk from these exposures varies, depending on how often you do this type of work. To reduce your exposure to these chemicals: work in a well ventilated area, and work with approved safety equipment, such as those dust masks that are specially designed to filter out microscopic particles. (California Health & Safety Code § 25249.5, *et seq.*)
6. **WARNING:** The brass components of this product contain lead, a chemical known to the State of California to cause cancer and birth defects or other reproductive harm. (California Health & Safety Code § 25249.5, *et seq.*)
7. **WARNING:** This product contains di (2-ethylhexyl) phthalate (DEHP), a chemical known to the State of California to cause cancer and birth defects or other reproductive harm. (California Health & Safety Code § 25249.5, *et seq.*)
8. Only use with accessories rated to handle the forces exerted by this tool during operation. Other accessories not designed for the forces generated may break and forcefully launch pieces.
9. Attach all accessories properly to the tool before connecting the air supply. A loose accessory may detach or break during operation.
10. Obey the manual for the air compressor used to power this tool.
11. Install an in-line shutoff valve to allow immediate control over the air supply in an emergency, even if a hose is ruptured.
12. Use this tool with both hands only. Using tools with only one hand can result in loss of control.
13. Do not lay the tool down until it has come to a complete stop. Moving parts can grab the surface and pull the tool out of your control.

## Vibration Precautions

This tool vibrates during use. Repeated or long-term exposure to vibration may cause temporary or permanent physical injury, particularly to the hands, arms and shoulders. To reduce the risk of vibration-related injury:

1. Anyone using vibrating tools regularly or for an extended period should first be examined by a doctor and then have regular medical check-ups to ensure medical problems are not being caused or worsened from use. Pregnant women or people who have impaired blood circulation to the hand, past hand injuries, nervous system disorders, diabetes, or Raynaud's Disease should not use this tool. If you feel any symptoms related to vibration (such as tingling, numbness, and white or blue fingers), seek medical advice as soon as possible.
2. Do not smoke during use. Nicotine reduces the blood supply to the hands and fingers, increasing the risk of vibration-related injury.
3. Wear suitable gloves to reduce the vibration effects on the user.
4. Use tools with the lowest vibration when there is a choice.
5. Include vibration-free periods each day of work.
6. Grip tool as lightly as possible (while still keeping safe control of it). Let the tool do the work.
7. To reduce vibration, maintain tool as explained in this manual. If abnormal vibration occurs, stop immediately.



**SAVE THESE INSTRUCTIONS.**

## Functional Description

## Specifications

Maximum Air Pressure	90 PSI
Air Inlet	1/4" -18 NPT
Average Air Consumption	4 CFM @ 90 PSI
Maximum Capacity	16 Gauge Mild Steel
Throat Depth	5/8"

Crimp Width	7/8"
Punch Size	.19"
Hole Placement	.287 (Hole Center to Edge of Workplace)
Head Rotation	360°

## Initial Tool Set Up/Assembly



Read the **ENTIRE IMPORTANT SAFETY INFORMATION** section at the beginning of this manual including all text under subheadings therein before set up or use of this product.

**Note:** For additional information regarding the parts listed in the following pages, refer to the Assembly Diagram near the end of this manual.

**Note:** This air tool may be shipped with a protective plug covering the air inlet. Remove this plug before set up.

## Air Supply

### ⚠ WARNING



**TO PREVENT SERIOUS INJURY FROM EXPLOSION:**

Use only clean, dry, regulated, compressed air to power this tool.

Do not use oxygen, carbon dioxide, combustible gases, or any other bottled gas as a power source for this tool.

1. Incorporate a filter, regulator with pressure gauge, oiler, in-line shutoff valve, and quick coupler for best service, as shown on Figure A on page 7 and Figure B on page 8. **An in-line shutoff ball valve is an important safety device because it controls the air supply even if the air hose is ruptured. The shutoff valve should be a ball valve because it can be closed quickly.**
2. Attach an air hose to the compressor's air outlet. Connect the air hose to the air inlet of the tool. Other components, such as a coupler plug and quick coupler, will make operation more efficient, but are not required.
3. Turn the tool's throttle or switch to the off position; refer to Operation section for description of controls.
4. Close the in-line shutoff valve between the compressor and the tool.
5. Turn on the air compressor according to the manufacturer's directions and allow it to build up pressure until it cycles off.
6. Adjust the air compressor's output regulator so that the air output is enough to properly power the tool, but the output will not exceed the tool's maximum air pressure at any time. Adjust the pressure gradually, while checking the air output gauge to set the right pressure range.
7. Inspect the air connections for leaks. Repair any leaks found.
8. If the tool will not be used at this time, turn off and detach the air supply, safely discharge any residual air pressure, and release the throttle and/or turn the switch to its off position to prevent accidental operation.
9. Residual air pressure should not be present after the tool is disconnected from the air supply. However, it is a good safety measure to attempt to discharge the tool in a safe fashion after disconnecting to ensure that the tool is disconnected and not powered.

**Note:** If an automatic oiler system is not used, add a few drops of Pneumatic Tool Oil to the airline connection before operation. Add a few more drops after each hour of continual use.

### ⚠ WARNING! TO PREVENT SERIOUS INJURY FROM ACCIDENTAL OPERATION:

**Do not install a female quick coupler on the tool.** Such a coupler contains an air valve that will allow the air tool to retain pressure and operate accidentally after the air supply is disconnected.

**Note:** Air flow, and therefore tool performance, can be hindered by undersized air supply components. The air hose must be long enough to reach the work area with enough extra length to allow free movement while working.

Figure A: Portable Air Supply Setup

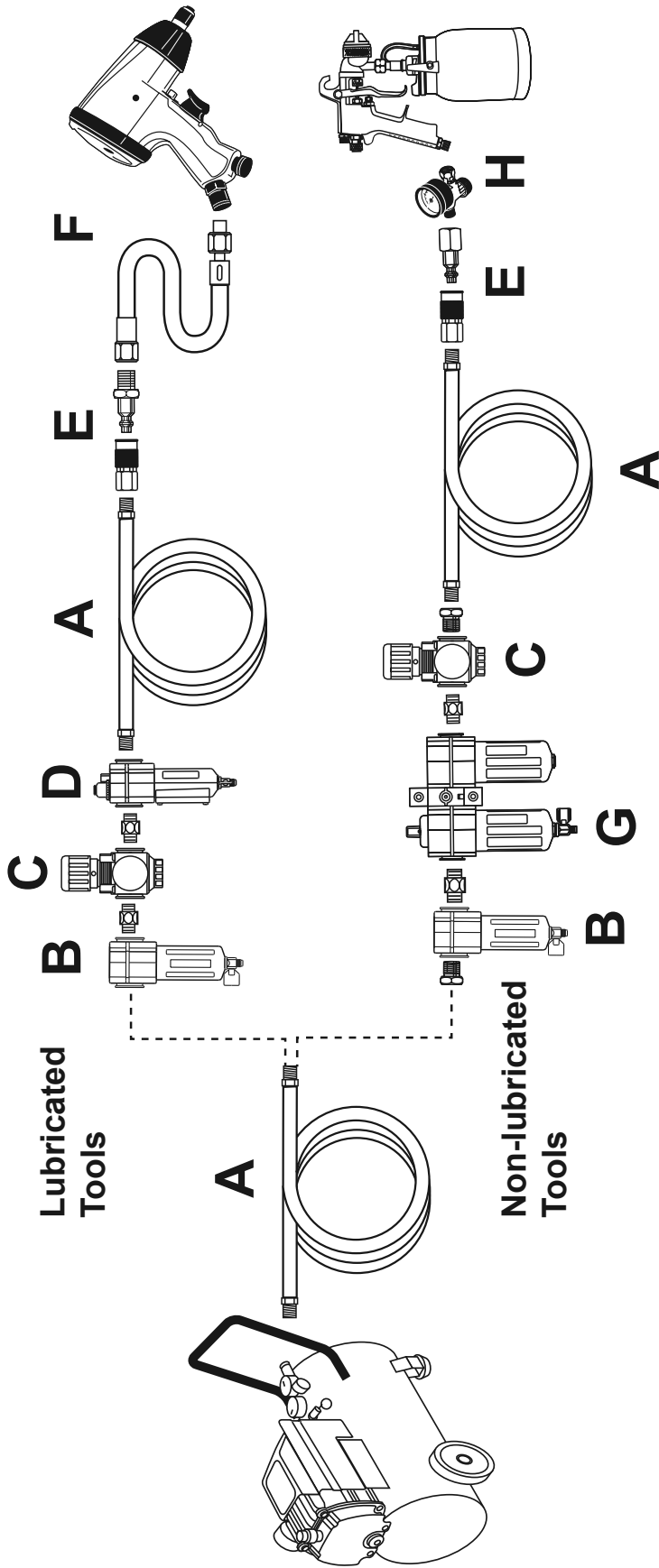

	Description	Function
A	Air Hose	Connects air to tool
B	Filter	Prevents dirt and condensation from damaging tool or workpiece
C	Regulator	Adjusts air pressure to tool
D	Lubricator (optional)	For air tool lubrication
E	Coupler and Plug	Provides quick connection and release
F	Leader Hose (optional)	Increases coupler life
G	Air Cleaner / Dryer (optional)	Prevents water vapor from damaging workpiece
H	Air Adjusting Valve (optional)	For fine tuning airflow at tool

Figure B: Stationary Air Supply Setup

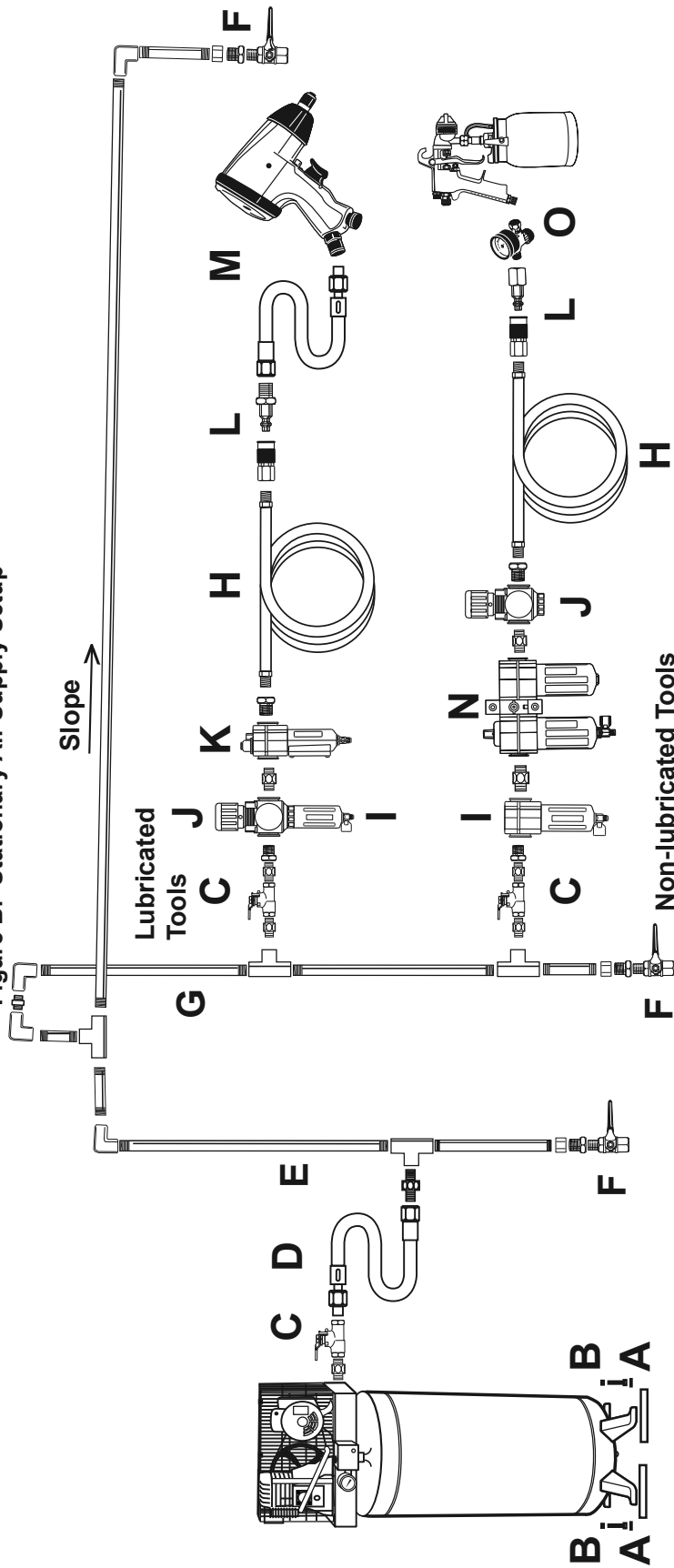

	Description	Function
A	Vibration Pads	For noise and vibration reduction
B	Anchor Bolts	Secures air compressor in place
C	Ball Valve	Isolates sections of system for maintenance
D	Isolation Hose	For vibration reduction
E	Main Air Line - 3/4" minimum recommended	Distributes air to branch lines
F	Ball Valve	To drain moisture from system
G	Branch Air Line - 1/2" minimum recommended	Brings air to point of use
H	Air Hose	Connects air to tool
I	Filter	Prevents dirt and condensation from damaging tool or workpiece
J	Regulator	Adjusts air pressure to tool
K	Lubricator (optional)	For air tool lubrication
L	Coupler and Plug	Provides quick connection and release
M	Leader Hose (optional)	Increases coupler life
N	Air Cleaner / Dryer (optional)	Prevents water vapor from damaging workpiece
O	Air Adjusting Valve (optional)	For fine tuning airflow at tool



## Operating Instructions



Read the **ENTIRE IMPORTANT SAFETY INFORMATION** section at the beginning of this manual including all text under subheadings therein before set up or use of this product.

Inspect tool before use, looking for damaged, loose, and missing parts. If any problems are found, do not use tool until repaired.

### **⚠️ WARNING**

#### **TO PREVENT SERIOUS INJURY FROM ACCIDENTAL OPERATION:**

Turn off the tool, detach the air supply, safely discharge any residual air pressure in the tool, and release the throttle and/or turn the switch to its off position before performing any inspection, maintenance, or cleaning procedures.

#### **TO PREVENT SERIOUS INJURY:**

Do not adjust or tamper with any control or component in a way not specifically explained within this manual. Improper adjustment can result in tool failure or other serious hazards.

## Workpiece and Work Area Set Up

1. Designate a work area that is clean and well-lit. The work area must not allow access by children or pets to prevent distraction and injury.
2. Route the air hose along a safe route to reach the work area without creating a tripping hazard or exposing the hose to possible damage. The hose must be long enough to reach the work area with enough extra length to allow free movement while working.
3. Secure loose workpieces using a vise or clamps (not included) to prevent movement while working.
4. There must not be hazardous objects (such as utility lines or foreign objects) nearby that will present a hazard while working.

# CENTRALPNEUMATIC®

# General Operating Instructions

## Punching

1. **WARNING: Always wear heavy-duty leather gloves when handling sheet metal.** Sharp edges can cause severe injury. Always wear ANSI-approved safety goggles.

2. Pre-mark the desired location of each hole you wish to punch on the workpiece.

**NOTE:** If the workpiece is to be both punched and flanged, flange it first, then measure for the hole placement. Flanging will change the dimensions of the workpiece.

3. Connect the Air Punch/Flange Tool to your air supply. Do not exceed 90 PSI.

4. Insert the edge of the workpiece between the Punch Die (3) and the Punch (6). Make sure your marks are aligned with the Punch Die (3).

5. Squeeze the Throttle Lever (20) and the Punch (6) will pierce the workpiece.

6. Align the tool with the next mark on the workpiece and repeat step 5 until the job is finished.

7. Disconnect the air supply.

8. **WARNING: After disconnecting the Air Punch/Flange Tool from the air supply there could still be enough air pressure to fire the Punch/Flange.** After making sure the air supply is disconnected, ALWAYS fire the Punch/Flange repeatedly to make sure all air is bled from the tool.

# CENTRALPNEUMATIC®

## Flanging

---

1. **WARNING: Always wear heavy-duty leather gloves when handling sheet metal.** Sharp edges can cause severe injury. Always wear ANSI-approved safety goggles.
2. Measure and cut the workpiece to the correct dimensions.
3. Connect the Air Punch/Flange Tool to your air supply. Do not exceed 90 PSI.
4. Secure the workpiece in a vise or use another appropriate clamping method.
5. Insert the workpiece into the flanging jaw between the Anvil (9) and the Clamp (1). Make sure the workpiece is all the way flush against the back of both the Anvil (9) and the Clamp (1). Squeeze the Throttle Lever (20) and the Anvil (9) will be driven against the Clamp (1) forming a flange.
6. Release the Throttle Lever (20). Slide the tool along the edge of the workpiece to where the Anvil (9) and the Clamp (1) overlap part of the workpiece you just flanged. Repeat step 5.
7. Repeat steps 5 and 6 until the entire length you wanted to flange is finished.
8. Disconnect the air supply.
9. **WARNING: After disconnecting the Air Punch/Flange Tool from the air supply there could still be enough air pressure to fire the Punch/Flange.** After making sure the air supply is disconnected, ALWAYS fire the Punch/Flange repeatedly to make sure all air is bled from the tool.

SAFETY

SETUP

OPERATION

MAINTENANCE

# CENTRALPNEUMATIC®

## User-Maintenance Instructions



Procedures not specifically explained in this manual must be performed only by a qualified technician.

### **WARNING**

#### **TO PREVENT SERIOUS INJURY FROM ACCIDENTAL OPERATION:**

Turn off the tool, detach the air supply, safely discharge any residual air pressure in the tool, and release the throttle and/or turn the switch to its off position before performing any inspection, maintenance, or cleaning procedures.

#### **TO PREVENT SERIOUS INJURY FROM TOOL FAILURE:**

Do not use damaged equipment. If abnormal noise, vibration, or leaking air occurs, have the problem corrected before further use.



#### **TO PREVENT SERIOUS INJURY FROM EXPLOSION:**

Lubricate the tool only with specified lubricants. Lubricate the air inlet using only pneumatic tool oil. Other lubricants may damage the mechanism and may be highly flammable, causing an explosion.

## Cleaning, Maintenance, and Lubrication

**Note:** These procedures are in addition to the regular checks and maintenance explained as part of the regular operation of the air-operated tool.

- BEFORE EACH USE**, inspect the general condition of the tool. Check for:
  - loose hardware or housing,
  - misalignment or binding of moving parts,
  - cracked or broken parts, and
  - any other condition that may affect its safe operation.
- Daily - Air Supply Maintenance:**  
Every day, maintain the air supply according to the component manufacturers' instructions. Maintain the lubricator's oil level. Drain the moisture filter regularly. Performing routine air supply maintenance will allow the tool to operate more safely and will also reduce wear on the tool.
- Quarterly (every 3 months) – Tool Disassembly, Cleaning, and Inspection:**  
Have the internal mechanism cleaned, inspected, and lubricated by a qualified technician.
- WHEN NECESSARY**, fill the hydraulic system with a high quality hydraulic oil. Remove the Oil Plug (13), refill and then replace the Oil Plug (13). See Figure C.

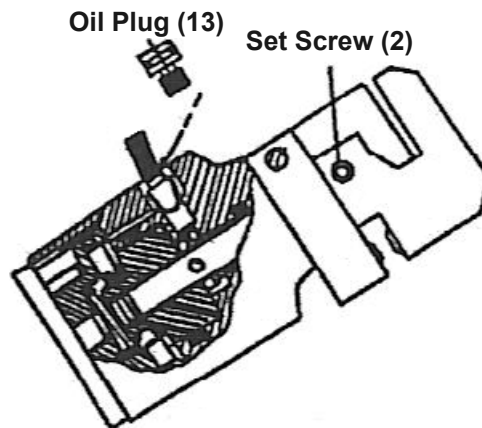



Figure C

- To adjust the Punch, loosen the Set Screw (2) and rotate the tool head. After making needed adjustment, tighten the Set Screw (2). See Figure C.

# Troubleshooting

Problem	Possible Causes	Likely Solutions
Decreased output.	<ol style="list-style-type: none"> <li>1. Not enough air pressure and/or air flow.</li> <li>2. Obstructed trigger.</li> <li>3. Incorrect lubrication or not enough lubrication.</li> <li>4. Blocked air inlet screen (if equipped).</li> <li>5. Air leaking from loose housing.</li> <li>6. Mechanism contaminated.</li> </ol>	<ol style="list-style-type: none"> <li>1. Check for loose connections and make sure that air supply is providing enough air flow (CFM) at required pressure (PSI) to the tool's air inlet. <b>Do not exceed maximum air pressure.</b></li> <li>2. Clean around trigger to ensure free movement.</li> <li>3. Lubricate using air tool oil according to directions.</li> <li>4. Clean air inlet screen of buildup.</li> <li>5. Make sure housing is properly assembled and tight.</li> <li>6. Have qualified technician clean and lubricate mechanism. Install in-line filter in air supply as stated in Setup: Air Supply.</li> </ol>
Severe air leakage. (Slight air leakage is normal, especially on older tools.)	<ol style="list-style-type: none"> <li>1. Cross-threaded housing components.</li> <li>2. Loose housing.</li> <li>3. Damaged valve or housing.</li> <li>4. Dirty, worn or damaged valve.</li> </ol>	<ol style="list-style-type: none"> <li>1. Check for incorrect alignment and uneven gaps. If cross-threaded, disassemble and replace damaged parts before use.</li> <li>2. Tighten housing assembly. If housing cannot tighten properly, internal parts may be misaligned. Technician needs to disassemble tool, align parts and reassemble.</li> <li>3. Replace damaged components.</li> <li>4. Clean or replace valve assembly.</li> </ol>
Housing heats during use.	<ol style="list-style-type: none"> <li>1. Incorrect lubrication or not enough lubrication.</li> <li>2. Worn parts.</li> </ol>	<ol style="list-style-type: none"> <li>1. Lubricate using air tool oil according to directions.</li> <li>2. Have qualified technician inspect internal mechanism and replace parts as needed.</li> </ol>
 <p><b>Follow all safety precautions whenever diagnosing or servicing the tool. Disconnect air supply before service.</b></p>		

**PLEASE READ THE FOLLOWING CAREFULLY**

THE MANUFACTURER AND/OR DISTRIBUTOR HAS PROVIDED THE PARTS LIST AND ASSEMBLY DIAGRAM IN THIS MANUAL AS A REFERENCE TOOL ONLY. NEITHER THE MANUFACTURER OR DISTRIBUTOR MAKES ANY REPRESENTATION OR WARRANTY OF ANY KIND TO THE BUYER THAT HE OR SHE IS QUALIFIED TO MAKE ANY REPAIRS TO THE PRODUCT, OR THAT HE OR SHE IS QUALIFIED TO REPLACE ANY PARTS OF THE PRODUCT. IN FACT, THE MANUFACTURER AND/OR DISTRIBUTOR EXPRESSLY STATES THAT ALL REPAIRS AND PARTS REPLACEMENTS SHOULD BE UNDERTAKEN BY CERTIFIED AND LICENSED TECHNICIANS, AND NOT BY THE BUYER. THE BUYER ASSUMES ALL RISK AND LIABILITY ARISING OUT OF HIS OR HER REPAIRS TO THE ORIGINAL PRODUCT OR REPLACEMENT PARTS THERETO, OR ARISING OUT OF HIS OR HER INSTALLATION OF REPLACEMENT PARTS THERETO.

**Parts List**

Part	Description	Qty
1	Clamp	1
2	Set Screw	1
3	Punch Die	1
4	Guide Bushing	1
5	Cup Spring	13
6	Punch	1
7	Screw	2
8	Plate Guard	1
9	Anvil	1
10	Oil Seal	1
11	Support Ring	1
12	O-ring	1
13	Oil Plug	1
14	O-ring	1
15	Hydraulic Cylinder	1
16	Air Cylinder	1
17	Sleeve	1
18	Valve Body	1
19	Air Inlet	1

Part	Description	Qty
20	Throttle Lever	1
21	Spring Pin	1
22	O-ring	1
23	Push Rod	1
24	Spring	1
25	Valve	1
26	Spring	1
27	O-ring	1
28	Screw	1
29	O-ring	1
30	Support Ring	1
31	Hydraulic Piston	1
32	O-ring	1
33	Support Ring	2
34	Spring	1
35	Piston	1
36	O-ring	1
37	Spring Washer	1

**Record Product's Serial Number Here:** \_\_\_\_\_

**Note:** If product has no serial number, record month and year of purchase instead.

**Note:** Some parts are listed and shown for illustration purposes only, and are not available individually as replacement parts.

# Assembly Diagram

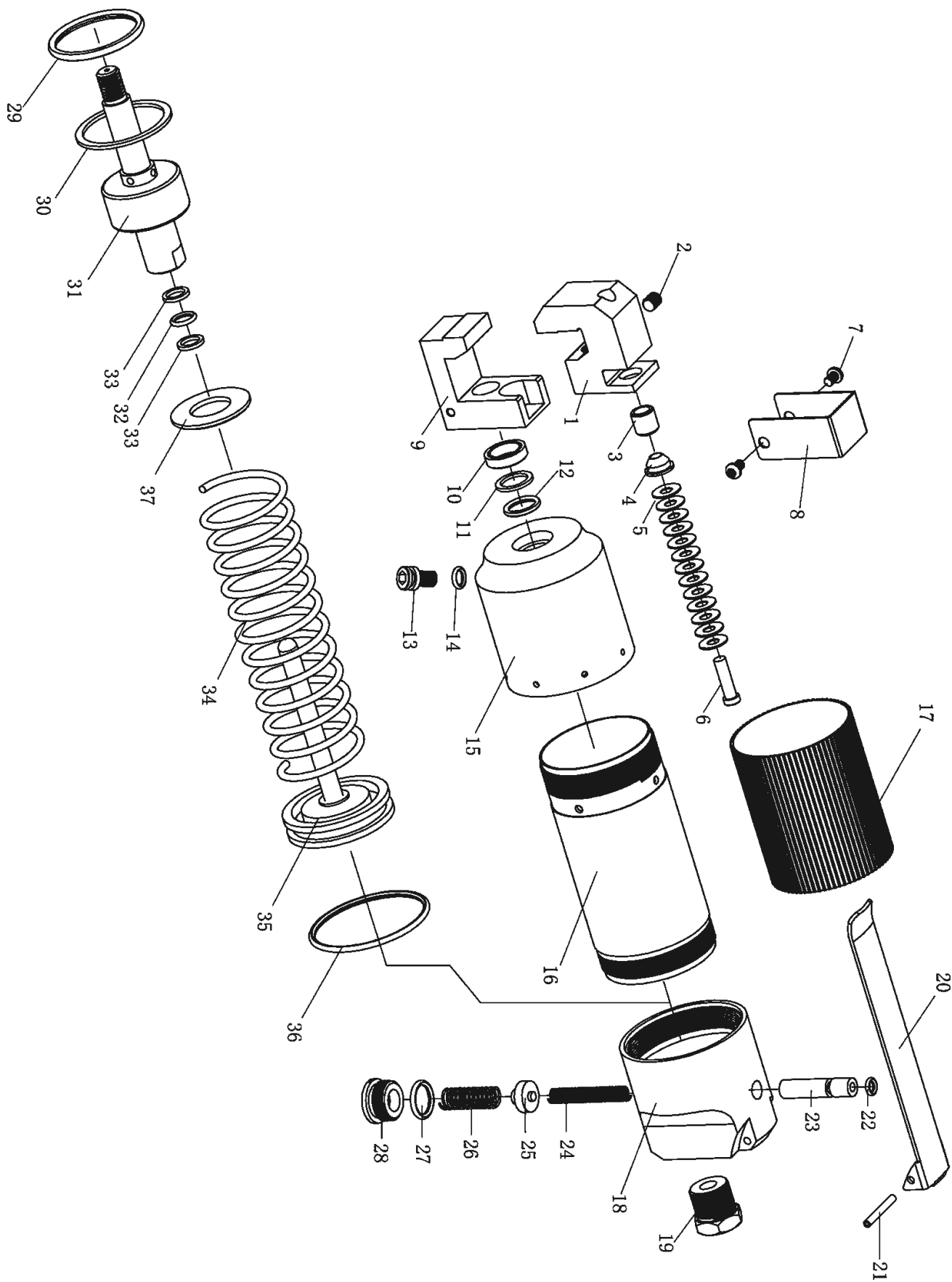

## Limited 90 Day Warranty

Harbor Freight Tools Co. makes every effort to assure that its products meet high quality and durability standards, and warrants to the original purchaser that this product is free from defects in materials and workmanship for the period of 90 days from the date of purchase. This warranty does not apply to damage due directly or indirectly, to misuse, abuse, negligence or accidents, repairs or alterations outside our facilities, criminal activity, improper installation, normal wear and tear, or to lack of maintenance. We shall in no event be liable for death, injuries to persons or property, or for incidental, contingent, special or consequential damages arising from the use of our product. Some states do not allow the exclusion or limitation of incidental or consequential damages, so the above limitation of exclusion may not apply to you. THIS WARRANTY IS EXPRESSLY IN LIEU OF ALL OTHER WARRANTIES, EXPRESS OR IMPLIED, INCLUDING THE WARRANTIES OF MERCHANTABILITY AND FITNESS.

To take advantage of this warranty, the product or part must be returned to us with transportation charges prepaid. Proof of purchase date and an explanation of the complaint must accompany the merchandise. If our inspection verifies the defect, we will either repair or replace the product at our election or we may elect to refund the purchase price if we cannot readily and quickly provide you with a replacement. We will return repaired products at our expense, but if we determine there is no defect, or that the defect resulted from causes not within the scope of our warranty, then you must bear the cost of returning the product.

This warranty gives you specific legal rights and you may also have other rights which vary from state to state.

# CENTRALPNEUMATIC®

3491 Mission Oaks Blvd. • PO Box 6009 • Camarillo, CA 93011 • 1-888-866-5797