



# **Administration for the Avaya G450 Media Gateway**

03-602055  
Issue 1  
January 2008

© 2008 Avaya Inc.  
All Rights Reserved.

#### **Notice**

While reasonable efforts were made to ensure that the information in this document was complete and accurate at the time of printing, Avaya Inc. can assume no liability for any errors. Changes and corrections to the information in this document may be incorporated in future releases.

**For full legal page information, please see the complete document, Avaya Legal Page for Software Documentation, Document number 03-600758.**

**To locate this document on the website, simply go to <http://www.avaya.com/support> and search for the document number in the search box.**

#### **Documentation disclaimer**

Avaya Inc. is not responsible for any modifications, additions, or deletions to the original published version of this documentation unless such modifications, additions, or deletions were performed by Avaya. Customer and/or End User agree to indemnify and hold harmless Avaya, Avaya's agents, servants and employees against all claims, lawsuits, demands and judgments arising out of, or in connection with, subsequent modifications, additions or deletions to this documentation to the extent made by the Customer or End User.

#### **Link disclaimer**

Avaya Inc. is not responsible for the contents or reliability of any linked websites referenced elsewhere within this documentation, and Avaya does not necessarily endorse the products, services, or information described or offered within them. We cannot guarantee that these links will work all of the time and we have no control over the availability of the linked pages.

#### **Warranty**

Avaya Inc. provides a limited warranty on this product. Refer to your sales agreement to establish the terms of the limited warranty. In addition, Avaya's standard warranty language, as well as information regarding support for this product, while under warranty, is available through the following website:

<http://www.avaya.com/support>

#### **Copyright**

Except where expressly stated otherwise, the Product is protected by copyright and other laws respecting proprietary rights. Unauthorized reproduction, transfer, and or use can be a criminal, as well as a civil, offense under the applicable law.

#### **Avaya support**

Avaya provides a telephone number for you to use to report problems or to ask questions about your product. The support telephone number is 1-800-242-2121 in the United States. For additional support telephone numbers, see the Avaya website:

<http://www.avaya.com/support>

# Contents

<b>About this book</b> . . . . .	<b>23</b>
Overview . . . . .	23
Audience . . . . .	23
Downloading this book and updates from the web . . . . .	23
Downloading this book . . . . .	23
Related resources . . . . .	24
Technical assistance . . . . .	25
Within the US. . . . .	25
International . . . . .	25
Trademarks. . . . .	25
Sending us comments. . . . .	26
<b>Chapter 1: Introduction</b> . . . . .	<b>27</b>
G450 contents . . . . .	28
G450 support information. . . . .	28
G450 with media modules. . . . .	28
<b>Chapter 2: Supported LAN deployments</b> . . . . .	<b>31</b>
Basic configuration . . . . .	31
Port redundancy configuration . . . . .	32
Port and switch redundancy configuration . . . . .	33
STP configuration . . . . .	34
STP and switch redundancy configuration . . . . .	35
<b>Chapter 3: Configuration overview.</b> . . . . .	<b>37</b>
Defining the Console interface . . . . .	37
Defining the Services interface . . . . .	37
Defining the USB-modem interface. . . . .	38
Defining other interfaces . . . . .	38
Configuration using CLI. . . . .	39
Configuration using GUI applications . . . . .	39
Saving configuration changes . . . . .	40
Summary of configuration changes CLI commands . . . . .	40
Firmware version control . . . . .	41
<b>Chapter 4: Accessing the Avaya G450 Media Gateway</b> . . . . .	<b>43</b>
Accessing the CLI . . . . .	43

## Contents

Logging into the CLI. . . . .	43
CLI contexts . . . . .	44
CLI help. . . . .	44
Accessing CLI via local network . . . . .	45
Accessing CLI with a console device . . . . .	45
Connecting a console device to the Services port . . . . .	45
Accessing the CLI via modem . . . . .	46
Accessing the CLI via a USB modem . . . . .	46
Accessing the CLI via a serial modem . . . . .	47
G450 serial modems. . . . .	47
Accessing the CLI via a modem connection to the S8300 . . . . .	48
Accessing Avaya IW. . . . .	48
Access and run the Avaya IW using a laptop computer . . . . .	49
Accessing GIW. . . . .	51
Access the GIW . . . . .	51
Accessing PIM . . . . .	52
Accessing Avaya Communication Manager . . . . .	53
Managing login permissions . . . . .	53
Security overview . . . . .	53
Managing users and passwords . . . . .	54
Privilege level . . . . .	54
Configuring usernames . . . . .	54
Authenticating service logins with Access Security Gateway (ASG) authentication . . . . .	55
Enabling ASG authentication . . . . .	56
Replacing the ASG authentication file . . . . .	56
Configuring ASG authentication . . . . .	58
Displaying ASG authentication information . . . . .	59
Summary of ASG authentication CLI Commands . . . . .	60
SSH protocol support . . . . .	61
RSA authentication process . . . . .	61
Password authentication process . . . . .	62
SSH configuration . . . . .	62
Summary of SSH configuration commands . . . . .	63
SCP protocol support . . . . .	63
SCP configuration . . . . .	64
Summary of SCP configuration commands . . . . .	64
RADIUS authentication . . . . .	64
Using RADIUS authentication. . . . .	64
Configuring RADIUS authentication . . . . .	64

Changing RADIUS parameters . . . . .	65
Disabling RADIUS authentication. . . . .	65
Displaying RADIUS parameters. . . . .	65
Summary of RADIUS authentication configuration commands . . . . .	66
Special security features . . . . .	66
Enabling and disabling recovery password . . . . .	67
Summary of recovery password commands. . . . .	67
Enabling and disabling telnet access . . . . .	67
Summary of Telnet access configuration commands. . . . .	68
Managing gateway secrets . . . . .	68
Configuring the Master Configuration Key. . . . .	69
Summary of Master Configuration Key configuration commands . . . . .	69
Enabling SYN cookies. . . . .	69
Configuring SYN cookies . . . . .	70
Maintaining SYN cookies . . . . .	71
Summary of SYN cookies configuration commands . . . . .	71
Managed Security Services (MSS) . . . . .	71
MSS reporting mechanism . . . . .	72
Configuring MSS. . . . .	72
DoS attack classifications. . . . .	74
Defining custom DoS classifications. . . . .	75
Example . . . . .	77
Summary of MSS configuration CLI commands. . . . .	78
<b>Chapter 5: Basic device configuration. . . . .</b>	<b>79</b>
Defining an interface . . . . .	79
Configuring the Primary Management Interface (PMI) . . . . .	80
Setting the PMI of the G450 . . . . .	80
Summary of PMI configuration CLI commands . . . . .	81
Defining the default gateway . . . . .	82
Summary of default gateway configuration CLI commands . . . . .	82
Configuring the Media Gateway Controller (MGC) . . . . .	82
Survivability and migration options . . . . .	83
Configuring the MGC list . . . . .	84
Setting the G450's MGC . . . . .	84
Determining results . . . . .	85
Showing the current MGC list. . . . .	85
Removing one or more MGCs. . . . .	86
Changing the MGC list. . . . .	86
Setting reset times. . . . .	86

## Contents

Accessing the registered MGC . . . . .	87
Monitoring the ICC or LSP . . . . .	87
Summary of MGC list configuration commands. . . . .	88
DNS resolver . . . . .	88
DNS resolver features . . . . .	89
Typical DNS resolver application – VPN failover . . . . .	89
Configuring DNS resolver . . . . .	90
DNS resolver configuration example . . . . .	93
Using DNS resolver to resolve a hostname . . . . .	93
Maintaining DNS resolver . . . . .	93
Showing DNS resolver information. . . . .	93
Clearing DNS resolver counters . . . . .	94
Viewing DNS resolver logging . . . . .	94
Summary of DNS resolver configuration commands . . . . .	94
Viewing the status of the device . . . . .	95
Summary of device status commands . . . . .	97
Software and firmware management . . . . .	98
File transfer . . . . .	98
Software and firmware upgrades . . . . .	98
Managing the firmware banks. . . . .	99
Upgrading software and firmware using FTP/TFTP . . . . .	100
Upgrading software and firmware using a USB mass storage device . . . . .	101
Uploading software and firmware from the gateway . . . . .	102
Summary of software and firmware management commands . . . . .	104
Backing up and restoring the G450 using a USB mass storage device . . . . .	105
Backing up administration and configuration files using a USB mass storage device . . . . .	106
Restoring backed up configuration and administration files to a gateway using a USB mass storage device. . . . .	108
Replicating a G450 using a USB mass storage device . . . . .	108
Replacing/adding/upgrading media modules using a USB mass storage device . . . . .	111
Additional USB commands . . . . .	112
Summary of USB backup, restore, and replication commands . . . . .	112
Backing up and restoring configuration files . . . . .	113
Backing up/restoring a configuration file using FTP/TFTP/SCP . . . . .	114
Backing up/restoring a configuration file using a USB mass storage device . . . . .	114
Summary of configuration file backup and restore commands . . . . .	115
Listing the files on the Avaya G450 Media Gateway . . . . .	116
Summary of file listing commands . . . . .	116

<b>Chapter 6: Configuring Standard Local Survivability (SLS)</b> . . . . .	<b>117</b>
Media module compatibility with SLS . . . . .	117
SLS service. . . . .	118
Avaya phones supported in SLS . . . . .	119
Call processing in SLS mode . . . . .	120
Call processing not supported by SLS. . . . .	121
Provisioning data . . . . .	122
PIM configuration data . . . . .	123
Entering SLS mode . . . . .	123
Unregistered state . . . . .	123
Setup state . . . . .	124
Registered state . . . . .	124
Teardown . . . . .	124
SLS interaction with specific G450 features . . . . .	125
Direct Inward Dialing in SLS mode . . . . .	125
Multiple call appearances in SLS mode . . . . .	125
Hold in SLS mode . . . . .	126
Call Transfer in SLS mode . . . . .	127
Using contact closure in SLS mode . . . . .	129
IP Softphone shared administrative identity in SLS mode . . . . .	130
SLS logging activities . . . . .	130
Example of CDR log entries and format . . . . .	131
Example of CDR log with contact closure . . . . .	132
Configuring SLS . . . . .	132
Configuring Communication Manager for SLS . . . . .	133
Using PIM to manage SLS administration on the gateway . . . . .	138
Enabling and disabling SLS. . . . .	143
Activating changes in SLS . . . . .	144
Using the CLI to manually configure SLS administration on the gateway. . . . .	144
Prerequisites . . . . .	144
Planning and preparing the SLS data set . . . . .	144
Configuring the SLS data through the CLI. . . . .	159
Administering Station parameters . . . . .	163
Administering DS1 parameters . . . . .	166
Administering BRI parameters . . . . .	171
Administering trunk-group parameters . . . . .	173
Administering signaling-group parameters . . . . .	180
Administering dial-pattern parameters. . . . .	181
Administering incoming-routing parameters . . . . .	182
Summary of SLS configuration commands . . . . .	184

<b>Chapter 7: Configuring Ethernet ports</b> . . . . .	<b>193</b>
Ethernet ports on the G450. . . . .	193
Ethernet ports on the G450 Media Gateway switch . . . . .	193
Ethernet ports on the G450 Media Gateway router . . . . .	193
Cables used for connecting devices to the fixed router . . . . .	193
Configuring switch Ethernet ports . . . . .	194
Switch Ethernet port commands . . . . .	194
Summary of switch Ethernet port configuration CLI commands. . . . .	195
Configuring the WAN Ethernet port . . . . .	196
Configuring additional features on the WAN Ethernet port. . . . .	196
WAN Ethernet port traffic shaping . . . . .	197
Backup interfaces . . . . .	197
WAN Ethernet port commands . . . . .	197
Summary of WAN Ethernet port configuration CLI commands . . . . .	198
Configuring DHCP client . . . . .	199
DHCP client applications . . . . .	199
DHCP client configuration . . . . .	200
Releasing and renewing a DHCP lease. . . . .	202
Maintaining DHCP client . . . . .	203
Configuring DHCP client logging messages. . . . .	203
Summary of DHCP client configuration CLI commands . . . . .	204
Configuring LLDP . . . . .	205
Supported TLVs . . . . .	206
Mandatory TLVs . . . . .	206
Optional TLVs . . . . .	206
802.1 TLVs (optional) . . . . .	206
LLDP configuration . . . . .	206
Displaying LLDP configuration . . . . .	207
Supported ports for LLDP. . . . .	207
Summary of LLDP configuration CLI commands . . . . .	208
<b>Chapter 8: Configuring logging</b> . . . . .	<b>209</b>
Configuring a Syslog server . . . . .	210
Defining Syslog servers. . . . .	210
Disabling Syslog servers . . . . .	211
Deleting Syslog servers . . . . .	211
Displaying the status of the Syslog server. . . . .	212
Syslog sink default settings. . . . .	212
Syslog message format . . . . .	212
Configuring a log file . . . . .	213



Disabling logging system messages to a log file . . . . .	213
Deleting current log file and opening an empty log file . . . . .	213
Displaying log file messages . . . . .	214
Displaying conditions defined for the file output sink . . . . .	214
Log file message format. . . . .	215
Configuring a session log. . . . .	215
Discontinuing the display of system messages . . . . .	215
Displaying how the session logging is configured . . . . .	216
Session logging message format. . . . .	216
Configuring logging filters . . . . .	217
Setting the logging filters . . . . .	217
Severity levels . . . . .	218
Sinks default severity levels . . . . .	218
Applications to be filtered. . . . .	219
Syslog server example . . . . .	220
Log file example . . . . .	221
Session log example. . . . .	222
Summary of Logging configuration CLI commands . . . . .	222
<b>Chapter 9: Configuring VoIP QoS . . . . .</b>	<b>225</b>
Configuring RTP and RTCP . . . . .	225
Configuring header compression . . . . .	225
Header compression configuration options . . . . .	226
Configuring IPHC . . . . .	227
Summary of IPHC header compression CLI commands . . . . .	228
Configuring VJ header compression . . . . .	229
Summary of Van Jacobson header compression CLI commands . . . . .	231
Displaying and clearing header compression statistics . . . . .	231
Configuring QoS parameters . . . . .	232
Configuring RTCP QoS parameters . . . . .	232
RSVP parameters . . . . .	233
Summary of QoS, RSVP, and RTCP configuration CLI commands . . . . .	233
Weighted Fair VoIP Queuing (WFVQ). . . . .	234
Configuring Weighted Fair VoIP Queueing (WFVQ). . . . .	234
Summary of WFVQ configuration CLI commands. . . . .	235
Priority queueing . . . . .	235
Configuring priority queueing . . . . .	236
Summary of priority queueing configuration CLI commands . . . . .	237

- Chapter 10: Configuring the G450 for modem use . . . . . 239**
  - Configuring the USB-modem interface. . . . . 239
  - Configuring the USB port for modem use . . . . . 239
    - Summary of CLI commands for configuring the USB port for modem use . . . . . 241
  - Configuring the Console port for modem use. . . . . 242
    - Summary of CLI commands for configuring the Console port for modem use . . . . . 243
    - Configuring the console device to connect to the Console port . . . . . 244
  
- Chapter 11: Configuring WAN interfaces . . . . . 245**
  - Serial interface overview . . . . . 246
    - Layer 1 T1 port with two channel groups . . . . . 246
    - E1/T1 port channel group . . . . . 247
    - USP port using PPP protocol . . . . . 247
    - USP port using frame relay protocol . . . . . 247
  - Frame Relay multipoint topology support . . . . . 248
  - Initial WAN configuration . . . . . 248
    - Configuring the Avaya MM340 E1/T1 WAN media module . . . . . 249
      - E1/T1 default settings . . . . . 252
      - Resetting and displaying controller counters . . . . . 252
      - Activating loopback mode on an E1/T1 line . . . . . 252
      - Summary of E1/T1 ports configuration commands . . . . . 253
    - Configuring the Avaya MM342 USP WAN media module . . . . . 254
      - USP default settings. . . . . 256
      - Summary of USP port configuration commands . . . . . 256
  - Configuring PPP . . . . . 257
    - Summary of PPP configuration commands . . . . . 258
  - PPPoE overview . . . . . 258
    - Configuring PPPoE . . . . . 259
    - Summary of PPPoE commands. . . . . 262
  - Configuring frame relay . . . . . 263
    - Resetting and displaying frame relay interface counters. . . . . 265
    - Summary of frame relay commands . . . . . 265
  - Verifying the WAN configuration and testing connectivity . . . . . 266
    - Summary of WAN configuration verification commands . . . . . 267
  - Backup interfaces . . . . . 268
    - Configuring backup delays . . . . . 269
    - Interface backup relations rules . . . . . 269
    - Backup commands . . . . . 270
    - Summary of backup interfaces commands . . . . . 270

Modem dial backup . . . . .	271
Typical installations . . . . .	273
Prerequisites for configuring modem dial backup . . . . .	273
Configuring modem dial backup . . . . .	274
Modem dial backup interactions with other features . . . . .	278
Configuration example . . . . .	279
Command sequence. . . . .	281
Command sequence explanation. . . . .	282
Modem dial backup maintenance. . . . .	284
Activating session logging . . . . .	284
Setting the severity level of the logging session . . . . .	284
Summary of modem dial backup commands . . . . .	291
ICMP keepalive. . . . .	292
Enabling the ICMP keepalive feature . . . . .	294
Defining the ICMP keepalive parameters. . . . .	294
Example of configuring ICMP keepalive . . . . .	295
Summary of ICMP keepalive configuration commands. . . . .	295
Dynamic CAC . . . . .	296
Enabling dynamic CAC and setting maximum bandwidth . . . . .	297
Displaying bandwidth information . . . . .	297
Summary of dynamic CAC configuration commands. . . . .	298
Object tracking. . . . .	298
Object tracking configuration. . . . .	299
Configuring RTR . . . . .	300
Configuring object tracking . . . . .	302
Object tracking maintenance . . . . .	304
Viewing RTR and object trackers logging . . . . .	305
Example of tracking a single remote device . . . . .	306
Example of tracking a group of devices . . . . .	307
Typical object tracking applications . . . . .	308
Typical application – VPN failover using object tracking . . . . .	309
Typical application – backup for a WAN FastEthernet interface . . . . .	309
Typical application – interface backup via policy-based routing. . . . .	312
Typical application – tracking the DHCP client default route. . . . .	313
Summary of object tracking configuration commands . . . . .	314
Frame relay encapsulation features . . . . .	316
Frame relay traffic shaping and FRF.12 fragmentation . . . . .	316
Configuring map classes . . . . .	317
Displaying configured map classes . . . . .	317
Summary of frame relay traffic shaping commands . . . . .	317

## Contents

Priority DLCI . . . . .	318
Summary of priority DLCI commands . . . . .	319
PPP VoIP configuration . . . . .	319
Site A connection details . . . . .	320
Site B connection details . . . . .	320
Configuration Example for Site A. . . . .	321
Configuration Example for Site B. . . . .	322
<b>Chapter 12: Configuring Emergency Transfer Relay (ETR). . . . .</b>	<b>325</b>
Setting ETR state . . . . .	325
Viewing ETR state . . . . .	326
Summary of ETR commands . . . . .	326
<b>Chapter 13: Configuring SNMP . . . . .</b>	<b>327</b>
Agent and manager communication . . . . .	327
SNMP versions. . . . .	328
SNMPv1. . . . .	329
SNMPv2c . . . . .	329
SNMPv3. . . . .	329
Users . . . . .	330
SNMP security levels . . . . .	330
SNMP-server user command . . . . .	330
Groups . . . . .	331
Creating an SNMPv3 group . . . . .	332
Views . . . . .	332
Creating an SNMPv3 view . . . . .	332
Configuring SNMP traps . . . . .	333
Notification types . . . . .	334
Summary of SNMP trap configuration commands . . . . .	335
Configuring SNMP access . . . . .	336
Summary of SNMP access configuration commands. . . . .	337
Configuring dynamic trap manager . . . . .	338
Summary of dynamic trap manager configuration commands. . . . .	339
SNMP configuration examples . . . . .	340
<b>Chapter 14: Configuring contact closure . . . . .</b>	<b>343</b>
Contact closure hardware configuration. . . . .	343
Contact closure software configuration . . . . .	344
Showing contact closure status . . . . .	345

Summary of contact closure commands. . . . .	345
<b>Chapter 15: Transferring and managing announcement files . . . . .</b>	<b>347</b>
Announcement file operations . . . . .	347
Summary of announcement files commands . . . . .	350
<b>Chapter 16: Configuring advanced switching. . . . .</b>	<b>351</b>
Configuring VLANs . . . . .	351
VLAN Tagging . . . . .	351
Multi VLAN binding . . . . .	352
G450 VLAN table. . . . .	353
Ingress VLAN Security . . . . .	353
ICC-VLAN. . . . .	353
VLAN CLI commands . . . . .	354
VLAN configuration examples . . . . .	354
Summary of VLAN commands . . . . .	357
Configuring port redundancy . . . . .	358
Secondary port activation. . . . .	358
Switchback. . . . .	359
Port redundancy CLI commands . . . . .	359
Port redundancy configuration examples . . . . .	359
Summary of port redundancy commands . . . . .	360
Configuring port mirroring . . . . .	361
Port mirroring constraints . . . . .	361
Port mirroring CLI commands . . . . .	361
Port mirroring configuration examples . . . . .	361
Summary of port mirroring commands . . . . .	362
Configuring spanning tree . . . . .	362
Spanning tree protocol . . . . .	362
Spanning tree per port. . . . .	363
Rapid Spanning Tree Protocol (RSTP) . . . . .	363
Spanning tree CLI commands . . . . .	365
Spanning tree configuration examples. . . . .	366
Summary of spanning tree commands. . . . .	368
Port classification . . . . .	369
Port classification CLI commands . . . . .	369
Port classification configuration examples . . . . .	369
Summary of port classification commands . . . . .	370

<b>Chapter 17: Configuring monitoring applications.</b> . . . . .	<b>371</b>
<b>Configuring RMON.</b> . . . . .	<b>371</b>
RMON CLI commands . . . . .	372
RMON configuration examples . . . . .	372
Summary of RMON commands . . . . .	374
<b>Configuring and analyzing RTP statistics</b> . . . . .	<b>374</b>
<b>Configuring the RTP statistics application</b> . . . . .	<b>375</b>
Viewing RTP statistics thresholds . . . . .	376
Configuring RTP statistics thresholds . . . . .	378
Enabling and resetting the RTP statistics application . . . . .	379
Viewing application configuration . . . . .	380
Configuring QoS traps. . . . .	382
Configuring QoS fault and clear traps . . . . .	383
Configuring the trap rate limiter . . . . .	384
<b>Analyzing RTP statistics output</b> . . . . .	<b>384</b>
Viewing RTP statistics summary reports . . . . .	384
Viewing RTP session statistics . . . . .	385
Viewing QoS traps, QoS fault traps, and QoS clear traps. . . . .	392
Analyzing QoS trap output . . . . .	393
Analyzing QoS fault and clear trap output . . . . .	396
Viewing automatic traceroute results . . . . .	398
<b>RTP statistics examples.</b> . . . . .	<b>399</b>
Configuring the RTP statistics application for a sample network . . . . .	399
A call over the WAN from an analog phone to an IP phone. . . . .	403
A local call between an IP and an analog phone . . . . .	405
A remote call over the WAN from an IP phone to an IP phone . . . . .	407
A conference call . . . . .	410
Summary of RTP statistics commands . . . . .	412
<b>Configuring and analyzing packet sniffing</b> . . . . .	<b>413</b>
<b>What can be captured</b> . . . . .	<b>414</b>
Streams that can always be captured . . . . .	414
Streams that can never be captured . . . . .	414
Streams that can sometimes be captured . . . . .	414
<b>Configuring packet sniffing.</b> . . . . .	<b>415</b>
Enabling packet sniffing. . . . .	415
Limiting packet sniffing to specific interfaces. . . . .	415
Creating a capture list . . . . .	416
Defining rule criteria for a capture list . . . . .	416
Viewing the capture list . . . . .	423
Applying a capture list. . . . .	423

Configuring packet sniffing settings . . . . .	424
Starting the packet sniffing service . . . . .	425
Analyzing captured packets . . . . .	426
Stopping the packet sniffing service . . . . .	426
Viewing packet sniffing information . . . . .	426
Uploading the capture file . . . . .	427
Analyzing the capture file . . . . .	429
Simulating packets . . . . .	431
Summary of packet sniffing commands . . . . .	432
Reporting on interface status . . . . .	434
Summary of interface status commands. . . . .	435
Configuring and monitoring CNA test plugs. . . . .	436
CNA test plug functionality . . . . .	436
Test plug actions. . . . .	436
CNA tests. . . . .	437
Configuring the G450 test plug for registration . . . . .	437
CNA test plug configuration example . . . . .	439
Resetting the CNA test plug counters . . . . .	441
Summary of CNA test plug commands . . . . .	441
<b>Chapter 18: Configuring the router. . . . .</b>	<b>443</b>
Configuring interfaces. . . . .	443
Router interface concepts. . . . .	444
Physical router interfaces . . . . .	444
Layer 2 virtual interfaces . . . . .	444
Layer 2 logical interfaces . . . . .	445
IP Interface configuration commands . . . . .	445
Configuring interface parameter commands . . . . .	445
Interface configuration examples. . . . .	446
Displaying interface configuration . . . . .	446
Summary of basic interface configuration commands . . . . .	446
Configuring unnumbered IP interfaces . . . . .	448
Configuring unnumbered IP on an interface. . . . .	449
Unnumbered IP examples . . . . .	449
Summary of unnumbered IP interface configuration commands . . . . .	450
Routing sources . . . . .	451
Configuring the routing table . . . . .	451
Configuring next hops. . . . .	452
Static route types . . . . .	452
Configuring multiple next hops. . . . .	452

## Contents

Deleting a route and its next hops . . . . .	453
Via-interface static route . . . . .	453
Permanent static route . . . . .	454
Discard route. . . . .	454
Routing table commands . . . . .	455
Summary of routing table commands . . . . .	456
Configuring GRE tunneling . . . . .	456
Routing packets to a GRE tunnel. . . . .	457
Preventing nested tunneling in GRE tunnels . . . . .	458
Reasons for nested tunneling in a GRE tunnel . . . . .	458
Recommendations on avoiding nested tunneling. . . . .	459
Optional GRE tunnel features. . . . .	460
Keepalive . . . . .	460
Dynamic MTU discovery. . . . .	461
Setting up a GRE tunnel. . . . .	462
Additional GRE tunnel parameters . . . . .	463
GRE tunnel application example . . . . .	464
Summary of GRE tunneling commands . . . . .	466
Configuring DHCP and BOOTP relay. . . . .	467
DHCP . . . . .	467
BOOTP . . . . .	467
DHCP/BOOTP relay . . . . .	468
DHCP/BOOTP relay commands. . . . .	469
Summary of DHCP and BOOTP relay commands . . . . .	469
Configuring DHCP server . . . . .	470
Typical DHCP server application . . . . .	471
DHCP server CLI configuration . . . . .	472
Configuring Options. . . . .	473
Configuring vendor-specific options . . . . .	474
Optional DHCP server CLI commands . . . . .	474
DHCP pool configuration examples . . . . .	475
Displaying DHCP server information. . . . .	477
Summary of DHCP Server commands . . . . .	478
Configuring broadcast relay . . . . .	480
Directed broadcast forwarding . . . . .	480
NetBIOS rebroadcast . . . . .	481
Summary of broadcast relay commands. . . . .	481
Configuring the ARP table . . . . .	482
Overview of ARP. . . . .	482
The ARP table . . . . .	482



ARP table commands . . . . .	484
Summary of ARP table commands . . . . .	484
Enabling proxy ARP . . . . .	485
Summary of Proxy ARP commands . . . . .	485
Configuring ICMP errors . . . . .	486
Summary of ICMP errors commands . . . . .	486
Configuring RIP . . . . .	486
RIPv1 . . . . .	487
RIPv2 . . . . .	487
Preventing routing loops in RIP . . . . .	487
RIP distribution access lists . . . . .	488
RIP limitations . . . . .	489
RIP commands . . . . .	489
Summary of RIP commands . . . . .	490
Configuring OSPF . . . . .	492
OSPF dynamic Cost . . . . .	493
OSPF limitations . . . . .	493
OSPF commands . . . . .	493
Summary of OSPF commands . . . . .	495
Route redistribution . . . . .	497
Export default metric . . . . .	497
Summary of route redistribution commands . . . . .	498
Configuring VRRP . . . . .	498
VRRP configuration example . . . . .	499
VRRP commands . . . . .	500
Summary of VRRP commands . . . . .	501
Configuring fragmentation . . . . .	502
Fragmentation commands . . . . .	503
Summary of fragmentation commands . . . . .	503
<b>Chapter 19: Configuring IPsec VPN . . . . .</b>	<b>505</b>
Overview of IPsec VPN configuration . . . . .	506
Overview of IPsec VPN components . . . . .	506
Summary of configuration steps . . . . .	508
Configuring a site-to-site IPsec VPN . . . . .	510
Installing the VPN license file . . . . .	510
Configuring IPsec VPN . . . . .	510
Prerequisites . . . . .	510
IPsec VPN configuration overview . . . . .	511

## Contents

Coordinating with the VPN peer . . . . .	511
Configuring ISAKMP policies . . . . .	512
Configuring transform-sets . . . . .	513
Configuring ISAKMP peer information . . . . .	514
Configuring an ISAKMP peer-group . . . . .	518
Configuring crypto maps . . . . .	519
Configuring crypto lists . . . . .	520
Deactivating crypto lists to modify IPsec VPN parameters. . . . .	523
Configuring and assigning an access control list. . . . .	524
Configuring global parameters . . . . .	524
Configuring NAT Traversal . . . . .	524
Assigning a crypto list to an interface . . . . .	525
IPsec VPN maintenance. . . . .	527
Displaying IPsec VPN configuration . . . . .	527
Displaying IPsec VPN status . . . . .	527
IPsec VPN intervention . . . . .	528
IPsec VPN logging. . . . .	528
Typical installations . . . . .	530
Simple VPN topology – VPN hub and spokes . . . . .	530
Configuring the simple VPN topology . . . . .	531
Configuration example . . . . .	533
Using dynamic local peer IP . . . . .	536
Enabling continuous channel. . . . .	539
Full or partial mesh . . . . .	540
Full solution: hub and spoke with VPN . . . . .	552
Typical failover applications . . . . .	559
Introduction to the failover mechanism . . . . .	559
Failover using GRE . . . . .	560
Failover using DNS . . . . .	567
Failover using a peer-group. . . . .	575
Checklist for configuring site-to-site IPsec VPN . . . . .	583
Summary of VPN commands . . . . .	586
<b>Chapter 20: Configuring policy. . . . .</b>	<b>591</b>
Types of policy lists . . . . .	591
Access control lists . . . . .	591
Access control list rule specifications . . . . .	591
Network security using access control lists . . . . .	592
QoS lists . . . . .	593
Policy-based routing . . . . .	593

Managing policy lists . . . . .	594
Defining policy lists . . . . .	594
Creating and editing a policy list . . . . .	594
Defining list identification attributes . . . . .	595
Default actions . . . . .	596
Deleting a policy list . . . . .	596
Attaching policy lists to an interface . . . . .	596
Packets entering the interface . . . . .	596
Packets exiting the interface . . . . .	597
Device-wide policy lists . . . . .	598
Defining global rules . . . . .	599
Defining rules . . . . .	599
Editing and creating rules . . . . .	600
Policy lists rule criteria . . . . .	600
IP protocol . . . . .	601
Source and destination IP address . . . . .	601
Source and destination port range . . . . .	602
ICMP type and code . . . . .	603
TCP establish bit (access control lists only) . . . . .	604
Fragments . . . . .	604
DSCP . . . . .	604
Composite Operation . . . . .	604
Composite operations . . . . .	605
Pre-configured composite operations for access control lists . . . . .	605
Pre-configured composite operations for QoS lists . . . . .	606
Configuring composite operations . . . . .	607
Adding composite operation to an ip rule . . . . .	607
Composite operation example . . . . .	608
DSCP table . . . . .	608
Changing an entry in the DSCP table . . . . .	609
Displaying and testing policy lists . . . . .	610
Displaying policy lists . . . . .	610
Simulating packets . . . . .	611
Summary of access control list commands . . . . .	612
Summary of QoS list commands . . . . .	615
<b>Chapter 21: Configuring policy-based routing . . . . .</b>	<b>619</b>
Applications . . . . .	620
Separate routing of voice and data traffic . . . . .	620

## Contents

Backup . . . . .	620
Configuring policy-based routing . . . . .	621
PBR rules. . . . .	624
Modifying rules . . . . .	625
PBR rule criteria . . . . .	625
Next hop lists . . . . .	625
Modifying next hop lists. . . . .	626
Adding entries to a next hop list . . . . .	626
Deleting an entry from a next hop list . . . . .	626
Canceling tracking and keeping the next hop . . . . .	626
Changing the object tracker and keeping the next hop. . . . .	627
Editing and deleting PBR lists . . . . .	627
Displaying PBR lists. . . . .	627
Application example. . . . .	628
Configuration for the sample policy-based routing application . . . . .	630
Simulating packets in PBR . . . . .	633
Summary of policy-based routing commands. . . . .	633
<b>Chapter 22: Setting synchronization. . . . .</b>	<b>637</b>
Synchronization status . . . . .	638
Displaying synchronization status . . . . .	639
Summary of synchronization commands . . . . .	639
<b>Appendix A: Traps and MIBs . . . . .</b>	<b>641</b>
G450 traps . . . . .	641
G450 MIB files . . . . .	649
MIB files in the Load.MIB file . . . . .	651
MIB files in the RFC1315-MIB.my file . . . . .	652
MIB files in the Q-BRIDGE-MIB.my file . . . . .	654
MIB files in the ENTITY-MIB.my file. . . . .	655
MIB files in the IP-FORWARD-MIB.my file . . . . .	656
MIB files in the VRRP-MIB.my file . . . . .	657
MIB files in the UTILIZATION-MANAGEMENT-MIB.my file . . . . .	658
MIB files in the ENTITY-SENSOR-MIB.my file . . . . .	659
MIB files in the RSTP-MIB.my file. . . . .	659
MIB files in the APPLIC-MIB.my file . . . . .	660
MIB files in the DS1-MIB.my file . . . . .	660
MIB files in the PPP-IP-NCP-MIB.my file . . . . .	663
MIB files in the RFC1213-MIB.my file . . . . .	664

MIB files in the AVAYA-ENTITY-MIB.my file . . . . .	668
MIB files in the Rnd-MIB.my file . . . . .	668
MIB files in the XSWITCH-MIB.my file . . . . .	669
MIB files in the CROUTE-MIB.my file . . . . .	670
MIB files in the RS-232-MIB.my file . . . . .	673
MIB files in the RIPv2-MIB.my file . . . . .	675
MIB files in the IF-MIB.my file . . . . .	676
MIB files in the DS0BUNDLE-MIB.my file . . . . .	678
MIB files in the RFC1406-MIB.my file . . . . .	678
MIB files in the DS0-MIB.my file . . . . .	680
MIB files in the POLICY-MIB.my file . . . . .	681
MIB files in the BRIDGE-MIB.my file . . . . .	687
MIB files in the CONFIG-MIB.my file . . . . .	689
MIB files in the G700-MG-MIB.my file. . . . .	693
MIB files in the FRAME-RELAY-DTE-MIB.my file . . . . .	697
MIB files in the IP-MIB.my file . . . . .	699
MIB files in the Load12-MIB.my file. . . . .	700
MIB files in the PPP-LCP-MIB.my file. . . . .	702
MIB files in the WAN-MIB.my file . . . . .	703
MIB files in the SNMPv2-MIB.my file . . . . .	705
MIB files in the OSPF-MIB.my file. . . . .	706
MIB files in the TUNNEL-MIB.my file . . . . .	709
<b>Index . . . . .</b>	<b>711</b>

## **Contents**

# About this book

---

## Overview

*Administration for the Avaya G450 Media Gateway* describes how to configure and manage the Avaya G450 Media Gateway after it is already installed. For installation instructions, see *Installing and Upgrading the Avaya G450 Media Gateway*, 03-602054.

---

## Audience

The information in this book is intended for use by Avaya technicians, provisioning specialists, business partners, and customers.

---

## Downloading this book and updates from the web

You can download the latest version of the *Administration for the Avaya G450 Media Gateway* from the Avaya website. You must have access to the Internet, and a copy of Acrobat Reader must be installed on your personal computer.

Avaya makes every effort to ensure that the information in this book is complete and accurate. However, information can change after we publish this book. Therefore, the Avaya website might contain new product information and updates to the information in this book. You can also download these updates from the Avaya website.

---

## Downloading this book

1. Access the Avaya website at <http://www.avaya.com/support/>.
2. Click **FIND DOCUMENTATION** and **TECHNICAL INFORMATION** by **PRODUCT NAME**.
3. Type this book's document number (03-602055) in the **Search** box.
4. Click **GO**.

The search results appear.

## About this book

5. Locate the latest version of the book.
6. Click the book title. Your browser downloads the book.

---

## Related resources

Title	Number
Overview for the Avaya G450 Media Gateway	03-602058
Quick Start for Hardware Installation for the Avaya G450 Media Gateway	03-602053
Installing and Upgrading the Avaya G450 Media Gateway	03-602054
Avaya G450 CLI Reference	03-602056
Maintenance Alarms for Avaya Communication Manager, Media Gateways and Servers	03-300430
Maintenance Commands for Avaya Communication Manager, Media Gateways and Servers	03-300431
Maintenance Procedures for Avaya Communication Manager, Media Gateways and Servers	03-300432



---

## Technical assistance

Avaya provides the following resources for technical assistance.

---

### Within the US

For help with:

- Feature administration and system applications, call the Avaya DEFINITY Helpline at 1-800-225-7585
- Maintenance and repair, call the Avaya National Customer Care Support Line at 1-800-242-2121
- Toll fraud, call Avaya Toll Fraud Intervention at 1-800-643-2353

---

### International

For all international resources, contact your local Avaya authorized dealer for additional help.

---

## Trademarks

All trademarks identified by the ® or ™ are registered trademarks or trademarks, respectively, of Avaya Inc. All other trademarks are the property of their respective owners.

## Sending us comments

Avaya welcomes your comments about this book. To reach us by:

- Mail, send your comments to:  
Avaya Inc.  
Product Documentation Group  
Room B3-H13  
1300 W. 120th Ave.  
Westminster, CO 80234 USA
- E-mail, send your comments to:  
*document@avaya.com*
- Fax, send your comments to:  
1-303-538-1741

Mention the name and number of this book, *Administration for the Avaya G450 Media Gateway*, 03-602055.

# Chapter 1: Introduction

The Avaya G450 Media Gateway is a multipurpose media gateway that can be deployed in medium to large sized branch locations or in wiring-closets servicing buildings and floors, in a campus environment. It works in conjunction with Avaya Communication Manager IP telephony software running on Avaya S8XXX Servers to help deliver intelligent communications to enterprises of all sizes.

The G450 combines telephone exchange and data networking, by providing PSTN toll bypass and routing data and VoIP traffic over the WAN. The G450 features a VoIP engine, an optional WAN router, and Ethernet LAN connectivity. The G450 provides full support for Avaya IP and digital telephones, as well as analog devices such as modems, fax machines, and telephones.

The G450 can support up to 450 users when deployed as a branch gateway in a mid to large branch office of a large enterprise or a call center, and can serve up to 2400 users when deployed as a campus gateway. Both configurations require Avaya Communication Manager IP telephony software running on one or more Avaya S8XXX Servers. The 450 user capacity is reached when the Avaya S8300 server is used and the 2400 user capacity is reached when the Avaya S8500 Server is used.

Telephone services on a G450 are controlled by an Avaya S8XXX Server operating either as an External Call Controller (ECC) or as an Internal Call Controller (ICC). The G450 supports the Avaya S8300 Server as an ICC, or as an ECC when the S8300 is installed in another media gateway. The G450 also supports the Avaya S8710, S8720, S8730, S8500, and S8400 Servers as ECCs.

An ICC can be used in addition to an ECC with the ICC installed as a Local Survivable Processor (LSP) designed to take over call control in the event that the ECC fails or the WAN link between the branch office and main location breaks. The LSP provides full featured telephone service survivability for the branch office. The G450 itself also features Standard Local Survivability (SLS), which provides basic telephone services in the event that the connection with the primary ECC is lost.

The G450 is a scalable device with a basic configuration consisting of 1 power supply unit (PSU), 256 MB RAM, and a single DSP childboard supporting either 20 or 80 VoIP channels. This configuration can be enhanced by adding a redundant PSU, up to two RAM modules of 1 GB each, and up to three additional DSP childboards, increasing the number of VoIP channels to 240 channels.

## Introduction

The G450 is a modular device, adaptable to support different combinations of endpoint devices. While fixed front panel ports support the connection of external LAN switches, network data ports, Ethernet WAN lines and external routers, eight slots are provided for plugging in optional media modules. Pluggable media modules provide interfaces for different types of telephones, trunks, and WAN links. A combination is selected to suit the needs of the branch. A range of telephony modules provides full support for legacy equipment such as analog and digital telephones. A range of WAN modules provide support for Universal Serial Port and E1/T1 WAN links. IP phones are supported via an external LAN switch.

The G450 chassis features field replaceable RAM, DSPs, PSUs, fan tray, and main board module for enhanced reliability.

---

## G450 contents

- An advanced router
- A Voice over IP (VoIP) engine
- A fax and modem over IP engine
- Preservation of calls in progress when switching from one server to another (applicable to all connections except ISDN BRI)
- Support for contact closure
- Virtual Private Networks (VPN)
- Emergency Transfer Relay (ETR)

---

## G450 support information

The G450 device supports various telephones, trunks, and ports. You can add plug-in media modules to the G450 for additional support.

---

## G450 with media modules

When you add plug-in media modules to the G450, the G450 also supports:

- IP telephones via an external LAN switch
- DCP digital telephones
- Analog telephones and trunks

- E1/T1 trunks
- ISDN PRI trunks
- ISDN BRI trunks
- E1/T1 and USP WAN data lines
- On board ports



# Chapter 2: Supported LAN deployments

There are five supported LAN configurations for the Avaya G450 Media Gateway.

---

## Basic configuration

The G450 can be deployed in the LAN with a basic configuration that includes no redundancy. The G450 is connected to an external LAN switch using one of the two Ethernet LAN ports located on the G450's front panel.

---

**Figure 1: Basic LAN deployment**

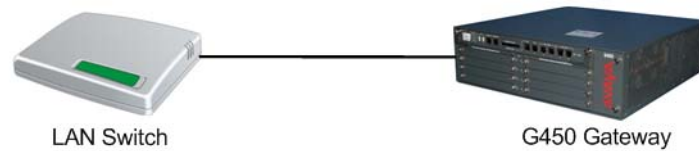

## Port redundancy configuration

The G450 can be deployed in the LAN using port redundancy to provide redundancy. The G450 is connected to an external LAN switch using both of the Ethernet LAN ports located on the G450's front panel.

One of the Ethernet LAN ports is configured to be the active primary link, and the other Ethernet LAN port is configured to be on standby (disabled). For information on configuring the Ethernet LAN ports in a port redundancy pair, refer to [Configuring port redundancy](#) on page 358.

When the G450 senses a link down failure on the primary port, it automatically enables the secondary link. Both ports need to be administratively enabled on the LAN switch peer.

---

**Figure 2: Port redundancy LAN deployment**

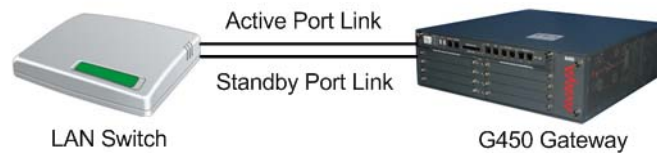



---

## Port and switch redundancy configuration

The G450 can be deployed in the LAN using port and switch redundancy to provide redundancy. The G450 is connected to two external LAN switches. Each of the Ethernet LAN ports located on the G450's front panel is connected to one of the switches.

One of the Ethernet LAN ports is configured to be the active primary link, and the other Ethernet LAN port is configured to be on standby (disabled). For information on configuring the Ethernet LAN ports in a port redundancy pair, refer to [Configuring port redundancy](#) on page 358.

When the G450 senses a link down failure on the primary port or failure of the switch to which the primary link is attached, it automatically enables the secondary link to the backup switch. Both ports need to be administratively enabled on their respective LAN switch peers.

---

**Figure 3: Port and switch redundancy LAN deployment**

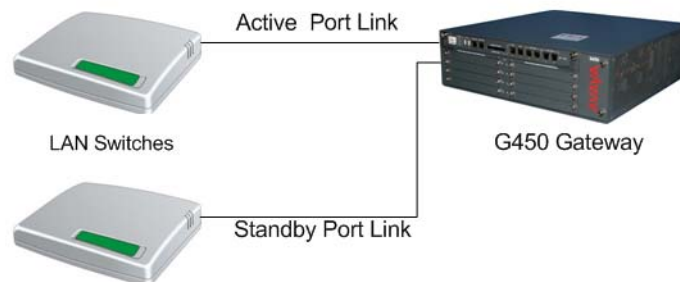

---

## STP configuration

The G450 can be deployed in the LAN using STP to provide redundancy. The G450 is connected to an external LAN switch using both of the Ethernet LAN ports located on the G450's front panel.

Spanning tree protocol blocks one of the links from the G450 to the external LAN switch. Spanning tree protocol must be configured on both the external LAN switch and the Ethernet LAN ports on the G450. For information on configuring spanning tree on the Ethernet LAN ports, refer to [Configuring spanning tree](#) on page 362.

When the G450 senses a link down failure on the active port, it automatically enables the second link. Both ports need to be administratively enabled on the LAN switch peer.

The advantage of fast STP over port redundancy is that it controls the link state based on the best LAN topology using the links' cost. However, an STP convergence time penalty is incurred.

---

**Figure 4: STP LAN deployment**

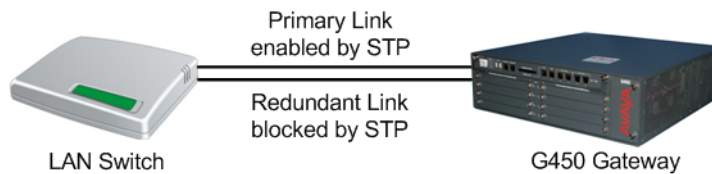

---

## STP and switch redundancy configuration

The G450 can be deployed in the LAN using STP and switch redundancy to provide redundancy. The G450 is connected to two external LAN switches. Each of the Ethernet LAN ports located on the G450's front panel is connected to one of the switches.

Spanning tree protocol blocks one of the links from the G450 to the external LAN switch. Spanning tree protocol must be configured on both the external LAN switch and the Ethernet LAN ports on the G450. For information on configuring spanning tree on the Ethernet LAN ports, refer to [Configuring spanning tree](#) on page 362.

When the G450 senses a link down failure on the active port or failure of the switch to which the active link is attached, it automatically enables the blocked link to the backup switch. Both ports need to be administratively enabled on the LAN switch peer.

The advantage of fast STP over port redundancy is that it controls the link state based on the best LAN topology using the links' cost. However, an STP convergence time penalty is incurred.

---

**Figure 5: STP and switch redundancy LAN deployment**

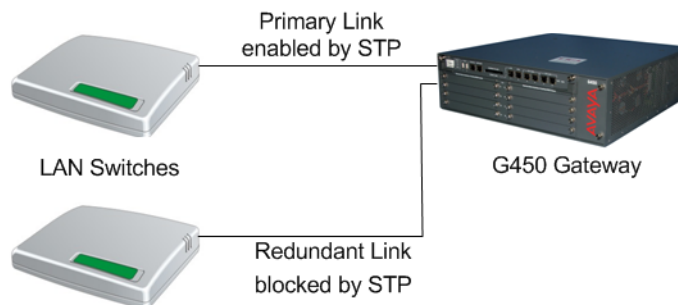

## Supported LAN deployments

# Chapter 3: Configuration overview

A new Avaya G450 Media Gateway comes with default configuration settings. There are certain items that you must configure, according to your system specifications, before using the G450. Configuration of other items depends on the specifications of your network.

A new G450 has three IP interfaces for management (SNMP, telnet). These are the Console interface, the Services interface, and the USB-modem interface.

You must also ensure that the G450 is properly configured for whichever methods you intend to use for accessing the G450. For information on accessing the G450, see [Accessing the Avaya G450 Media Gateway](#) on page 43.

---

## Defining the Console interface

The first thing you should do when configuring a new G450 is to assign an IP address to the Console interface. It is not necessary to include a subnet mask.

1. Enter **interface console** to enter the `Console` context.
2. Use the **ip address** command to define an IP address for the Console interface.

**Note:**

For more detailed installation instructions, including information on obtaining IP addresses, refer to *Installing and Upgrading the Avaya G450 Media Gateway*, 03-602054.

The following example assigns an IP address of 10.3.3.1 to the Console interface:

```
G450-001(super)# interface console
G450-001(super-if:Console)# ip address 10.3.3.1
Done!
```

---

## Defining the Services interface

No configuration of the Services interface is necessary. The Services interface has the fixed IP address 192.11.13.6. However, the console device you connect to the Services port requires a specific configuration of its network settings, as explained in [Connecting a console device to the Services port](#) on page 45.

---

## Defining the USB-modem interface

If you intend to use a USB modem to connect to the G450, you should also assign an IP address to the USB-modem interface. It is not necessary to include a subnet mask.

1. Enter **interface usb-modem** to enter the USB-modem context.
2. Use the **ip address** command to define a new IP address for the USB-modem interface.

The following example assigns an IP address of 10.3.3.2 to the USB-modem interface:

```
G450-001(super)# interface usb-modem
G450-001(super-if:USB-modem)# ip address 10.3.3.2
Done!
```

---

## Defining other interfaces

Your next step should be to define the other interfaces required by your system specifications. See [Defining an interface](#) on page 79.

Once you have defined your interfaces, you can define a Primary Management IP address (PMI). The PMI is the IP address which the G450 uses to identify itself when communicating with other devices, particularly the Media Gateway Controller (MGC). Management data intended for the G450 is routed to the interface defined as the PMI. You can use any interface as the PMI. For instructions on how to define the PMI, see [Configuring the Primary Management Interface \(PMI\)](#) on page 80.

Once you have defined a PMI, you must register the G450 with an MGC. The MGC is a call controller server that controls telephone services on the G450. The MGC can be internal or external. See [Configuring the Media Gateway Controller \(MGC\)](#) on page 82.

Once you have performed these steps, the G450 is ready for use. Other configuration tasks may also have to be performed, but these steps depend on the individual specifications of your G450 and your network.

Most G450 configuration tasks are performed using the G450 CLI. Avaya also provides several GUI applications that are designed to perform the basic configuration tasks described in this section. See [Configuration using GUI applications](#) on page 39.

---

## Configuration using CLI

You can use the Avaya G450 Media Gateway CLI to manage the G450. The CLI is a command prompt interface that enables you to type commands and view responses. For instructions on how to access the G450 CLI, see [Accessing the CLI](#) on page 43.

This guide contains information and examples about how to use CLI commands to configure the Avaya G450 Media Gateway. For more information about the G450 CLI and a complete description of each CLI command, see the *Avaya G450 CLI Reference, 03-602056*.

---

## Configuration using GUI applications

Several Avaya GUI applications enable you to perform some configuration tasks on the Avaya G450 Media Gateway. It is recommended to use these applications whenever possible, particularly for initial installation and provisioning.

The Avaya Installation Wizard (Avaya IW) is a web-based installation wizard that leads the user through the key configuration steps of a G450 installation. The Avaya IW can be used for initial configuration of a G450 with an S8300 installed as the G450's primary (ICC) or backup (LSP) call controller. For instructions on how to access the Avaya IW, see [Accessing Avaya IW](#) on page 48. For step-by-step instructions on how to configure the G450 using the Avaya IW, see *Installing and Upgrading the Avaya G450 Media Gateway, 03-602054*.

The Gateway Installation Wizard (GIW) is a standalone application that allows the user to perform certain basic G450 configuration tasks. The GIW can be used for initial configuration of a G450 that does not have an S8300 installed as either the G450's primary (ICC) or backup (LSP) call controller. For instructions on how to access the GIW, see [Accessing GIW](#) on page 51. For step-by-step instructions on how to configure the G450 using the GIW, see *Installing and Upgrading the Avaya G450 Media Gateway, 03-602054*.

The Avaya Provisioning and Installation Manager (PIM) is an application that allows the user to perform initial installation and provisioning of multiple gateways. It provides integrated network system views that ease centralized configuration tasks, especially provisioning and installing large numbers of gateways simultaneously. One of the primary functions of PIM is to provision and configure Standard Local Survivability (SLS). For instructions on how to access PIM, see [Accessing PIM](#) on page 52. For instructions on configuring SLS, see [Configuring Standard Local Survivability \(SLS\)](#) on page 117.

You can also use the Avaya G450 Manager to configure most features of the G450. The Avaya G450 Manager is a GUI application. You can access the Avaya G450 Manager from Avaya Integrated Management software or from a web browser. Most of the commands that are available through the G450 CLI are also available through the Avaya G450 Manager. For more information about the Avaya G450 Manager, see the *Avaya G450 Manager User Guide, 650-100-709*.

## Saving configuration changes

When you make changes to the configuration of the Avaya G450 Media Gateway, you must save your changes to make them permanent. The G450 has two sets of configuration information:

- Running configuration
- Startup configuration

The G450 operates according to the running configuration. When the G450 is reset, the G450 erases the running configuration and loads the startup configuration as the new running configuration. When you change the configuration of the G450, your changes affect only the running configuration. Your changes are lost when the G450 resets if you do not save your changes.

Enter **copy running-config startup-config** to save changes to the configuration of the G450. A copy of the running configuration becomes the new startup configuration.

You can back up either the running configuration or the startup configuration to an FTP or TFTP server on your network, or to a USB flash drive. You can restore a backup copy of the configuration from the FTP or TFTP server or the USB flash drive. When you restore the backup copy of the configuration, the backup copy becomes the new running configuration on the G450. For more information, see [Backing up and restoring configuration files](#) on page 113.

## Summary of configuration changes CLI commands

Table 1: Configuration changes CLI commands

Command	Description
<b>copy running-config startup-config</b>	Commit the current configuration, including Standard Local Survivability (SLS) data, to NVRAM



---

## Firmware version control

Firmware is the software that runs the Avaya G450 Media Gateway. The Avaya G450 Media Gateway has two firmware banks:

- Bank A
- Bank B

Each firmware bank contains a version of the G450 firmware. These may be different versions. The purpose of this feature is to provide redundancy of firmware. You can save an old version of the firmware in case you need to use it later. If it becomes necessary to use the older version, you can enter **set boot bank bank-x** and then reset the G450 to use the older version. This is particularly important when uploading new versions.

For more information on firmware version control, see [Software and firmware upgrades](#) on page 98.



# Chapter 4: Accessing the Avaya G450 Media Gateway

You can access the Avaya G450 Media Gateway using the CLI, the IW, the GIW, the PIM, and the Avaya Communication Manager. You can manage login permissions by using and configuring usernames and passwords, and by configuring the G450 to use SSH, SCP, RADIUS authentication. There are special security features that enable and disable the recovery password, establish incoming and outgoing telnet connections, and configure SYN cookies for preventing SYN attacks.

---

## Accessing the CLI

The CLI is a textual command prompt interface that you can use to configure the Avaya G450 Media Gateway and media modules. You can access the CLI with any of the following:

- Telnet through the network
- A console device
- Telnet through dialup:
  - Telnet through a serial modem
  - Telnet through a USB modem
  - Telnet through a USB modem via the S8300

If the G450 is under service contract with Avaya Services, remote service providers can connect remotely to service the G450 with telnet and SSH sessions. You can configure the G450 to authenticate remote service logins using Access Security Gateway (ASG) authentication instead of password authentication, for higher security.

---

## Logging into the CLI

Log in to the CLI with a username and password that your system administrator provides. Use RADIUS authentication if your network has a RADIUS server. For more information, see [Managing login permissions](#) on page 53.

**Note:**

Disconnect a telnet session by typing **<Ctrl>+]**. This is particularly useful if the normal telnet logout does not work.

## CLI contexts

The CLI is divided into various contexts from which sets of related commands can be entered. Contexts are nested in a hierarchy, with each context accessible from another context, called the parent context. The top level of the CLI tree is called the general context. Each command has a context in which the command must be used. You can only use a command in its proper context.

For example, in order to configure the Loopback interface, you must first enter the `Loopback` interface context from general context. You can enter the `Loopback` interface context using the **interface loopback 1** command. Once you are in the `Loopback` interface context, you can enter `Loopback` interface commands.

You can use the **tree** command to view the available commands in each context.

---

## CLI help

You can display a list of commands for the context you are in by typing **help** or **?**. The **help** command displays a list of all CLI commands that you can use within the current context, with a short explanation of each command.

If you type **help** or **?** before or after the first word or words of a command, the CLI displays a list of all commands in the current context that begin with this word or words. For example, to display a list of IP commands available in general context, enter **help ip**, **ip help**, **? ip**, or **ip ?**.

If you type **help** or **?** before or after a full command, the CLI displays the command's syntax and parameters, and an example of the command. You must be in the command's context in order to use the **help** command to display information about the command.

In the following example, the user enters the `vlan 1` interface context and displays help for the **bandwidth** command.

```
G450-001(super)# interface vlan 1
G450-001(super-if:VLAN 1)# bandwidth ?
Bandwidth commands:
-----
Syntax: bandwidth <kilobytes size>
           <kilobytes size> : integer (1-10000000)
Example: bandwidth 1000
```

---

## Accessing CLI via local network

Access the CLI from a computer on the same local network as the Avaya G450 Media Gateway by using SSH or, if telnet is active, any standard telnet program. Use the IP address of any G450 interface for the host address.

---

## Accessing CLI with a console device

Use any of the following types of console devices to access the CLI:

- Serial terminal
- Laptop with serial cable and terminal emulator software

Connect the console device to the CONSOLE or the SERVICES port on the front panel of the Avaya G450 Media Gateway. Use only an approved Avaya serial cable. For more information about approved Avaya serial cables, see *Overview for the Avaya G450 Media Gateway*, 03-602058.

For more information about the Console port, see [Configuring the Console port for modem use](#) on page 242. For more information about the Services port, see [Connecting a console device to the Services port](#) on page 45.

## Connecting a console device to the Services port

A console device connected directly to the Services port of the G450 or S8300 Server requires a specific configuration of its network settings.

**Note:**

Make a record of any IP addresses, DNS servers, or WINS entries that you change when you configure your services laptop. Unless you use the NetSwitcher program or an equivalent, you will need to restore these entries to connect to other networks.

- **Configure TCP/IP properties.** Set the TCP/IP properties of the console device as follows:
  - IP address = 192.11.13.5
  - Subnet mask = 255.255.255.252
  - Disable DNS service
  - Disable WINS Resolution
- **Configure browser settings.** Configure the browser of the console device for a direct connection to the Internet. Either disable/bypass proxy servers, or enter **192.11.13.6** in the **Exceptions** box.

- **Server address.** Access the G450 or S8300 Server using the URL `http://192.11.13.6`.

**Note:**

The names of the dialog boxes and buttons vary on different operating systems and browser releases. Use your computer's help system if needed to locate the correct place to enter the configuration information.

---

## Accessing the CLI via modem

You can use any standard telnet program to access the CLI from a remote location. This is done by using a dialup PPP network connection from a modem at the remote location. You can use either a USB modem connected to the USB port on the front panel of the G450 or a serial modem connected to the Console port on the front panel of the G450. You must only use an approved Avaya serial cable. For more information about approved Avaya serial cables, see *Overview for the Avaya G450 Media Gateway*, 03-602058.

**Note:**

You can disconnect a telnet session by typing `<Ctrl>+]`. This is particularly useful if the normal telnet logout does not work.

---

## Accessing the CLI via a USB modem

1. Connect a modem to the USB port on the front panel of the Avaya G450 Media Gateway. Use a USB cable to connect the modem. The G450 supports the Multitech MultiModem USB, MT5634ZBA-USB-V92.
2. Make sure the USB port is properly configured for modem use. For details, see [Configuring the USB port for modem use](#) on page 239.
3. From the remote computer, create a dialup network connection to the Avaya G450 Media Gateway. Use the TCP/IP and PPP protocols to create the connection. Configure the connection according to the configuration of the COM port of the remote computer. By default, the G450 uses PAP authentication. If your network has a RADIUS server, you can use RADIUS authentication for the PPP connection. For more information, see [Managing login permissions](#) on page 53.
4. Open any standard telnet program on the remote computer.
5. Open a telnet session to the IP address of the USB port on the G450. For instructions on how to set the IP address of the USB port (i.e., the USB-modem interface), see [Configuring the USB port for modem use](#) on page 239.

- Configure the serial connection on the remote computer to match the configuration of the USB port on the G450 (see [Table 2](#)).

**Table 2: The USB port settings**

Port setting	Value
Baud	-
Data bits	8
Parity	none
Stop bits	1
flow control	hardware

---

## Accessing the CLI via a serial modem

- Connect a modem to the Console port on the front panel of the Avaya G450 Media Gateway. Use an RJ-45 serial cable to connect the modem.
- Make sure the Console port is properly configured for modem use.
- From the remote computer, create a dialup network connection to the Avaya G450 Media Gateway. Use the TCP/IP and PPP protocols to create the connection. Configure the connection according to the configuration of the COM port of the remote computer. By default, the G450 uses PAP authentication. If your network has a RADIUS server, you can use RADIUS authentication for the PPP connection.
- Open any standard telnet program on the remote computer.
- Open a telnet session to the IP address of the Console port on the G450.
- Configure the serial connection on the remote computer to match the configuration of the Console port on the G450. The Console settings are the same as the USB port settings in [Table 2](#) except for the baud parameter, which uses the highest possible setting.

## G450 serial modems

The G450 supports the following serial modems:

- Multitech MultiModem ZBA, MT5634ZBA-V92.
- Multitech BRI-NT1 ISDN Modem w/ POTS, MTA128NT, for use in US/Canada.
- Multitech ISDN Modem w/ POTS, MTA128STBRI, for use in Europe and the rest of the world. The ISDN modems require DB-25 termination as well as the RJ-45 cable.

---

## Accessing the CLI via a modem connection to the S8300

If the Avaya G450 Media Gateway includes an S8300 Server, you can access the CLI from a remote location. This is done by establishing a PPP network connection from a modem at the remote location to a USB modem connected to one of the USB ports on the front panel of the S8300. The G450 supports the Multitech MultiModem USB, MT5634ZBA-USB-V92.

**Note:**

In order to access the CLI via the S8300, the PMI of the G450 must be configured. See [Configuring the Primary Management Interface \(PMI\)](#) on page 80.

1. Connect a USB modem to either of the two USB ports on the Avaya S8300 Server.
2. Use the Avaya Maintenance Web Interface (MWI) to configure the USB port on the S8300 for modem use. For instructions, see *Installing and Upgrading the Avaya G450 Media Gateway*, 03-602054.
3. From a remote computer, create a dialup network connection to the S8300. Use the TCP/IP and PPP protocols to create the connection.
4. Open any standard telnet program on the remote computer.
5. Enter the command `telnet`, followed by the IP address of the S8300 USB port to which the modem is connected.
6. Enter the command `telnet`, followed by the PMI of the G450.

---

## Accessing Avaya IW

The Avaya Installation Wizard (Avaya IW) is a web-based installation wizard that is used with the Avaya G450 Media Gateway to perform initial configuration tasks and to upgrade software and firmware. The Avaya IW is designed for use with systems that include an S8300 Server, operating in either ICC or LSP mode. See [Configuring the Media Gateway Controller \(MGC\)](#) on page 82.

Specifically, you can perform the following tasks with the Avaya IW:

- Configure PMI and SNMP information, Ethernet interfaces, primary and secondary Media Gateway Controllers, G450 telephony and trunk parameters, and alarms
- Install license and password files, software, and firmware upgrades
- Enable and configure the USB ports of the S8300 and G450 for modem use
- Change your password



---

## Access and run the Avaya IW using a laptop computer

1. Connect a laptop computer to the Services port of the S8300, using a crossover cable.
2. Make sure the laptop is configured as described in [Connecting a console device to the Services port](#) on page 45.
3. Launch Internet Explorer on the laptop and enter the following URL to access the S8300 Server Home Page: **http://192.11.13.6**.

The welcome screen for Avaya Integrated Management appears.

4. Click **Continue**. The Logon screen for Integrated Management appears.
5. Enter the appropriate login name and password.
6. Ask a customer representative for a login name and password that the customer would like for the superuser login. If you are a business partner, you can also repeat this procedure to add the dadmin login.

**Note:**

Make sure the customer can change this login, its password, or its permissions later.

7. From the Integrated Management main menu, select Launch Maintenance Web Interface.
8. From the navigation menu of the Maintenance Web Pages, select **Security > Administrator Accounts**.  
The **Administrator Accounts** screen appears.
9. Select **Add Login**.
10. Select **Privileged Administrator** and click **Submit**.  
The **Administrator Logins -- Add Login: Privileged Administrator** screen appears.
11. Type a login name for the account in the **Login name** field.
12. Verify the following:
  - **susers** appears in the **Primary group** field.
  - **prof18** appears in the **Additional groups (profile)** field. *prof18* is the code for the customer superuser.
  - **/bin/bash** appears in the **Linux shell** field.
  - **/var/home/login name** appears in the **Home directory** field, where *login name* is the name you entered in step 11.
13. Skip the fields **Lock this account** and **Date on which account is disabled-blank to ignore**.
14. For the **Select type of authentication** option, select **password**.

**Note:**

Do not lock the account or set the password to be disabled.

15. Enter the password in the **Enter password or key** field and the **Re-enter password or key** field.
16. In the section **Force password/key change on next login** select **no**.
17. Click **Submit**.  
The system informs you the login is added successfully.
18. Click the **Launch Installation Wizard** link on the home page. The **Avaya IW Overview** screen appears.

**Figure 6: Avaya IW Overview screen**

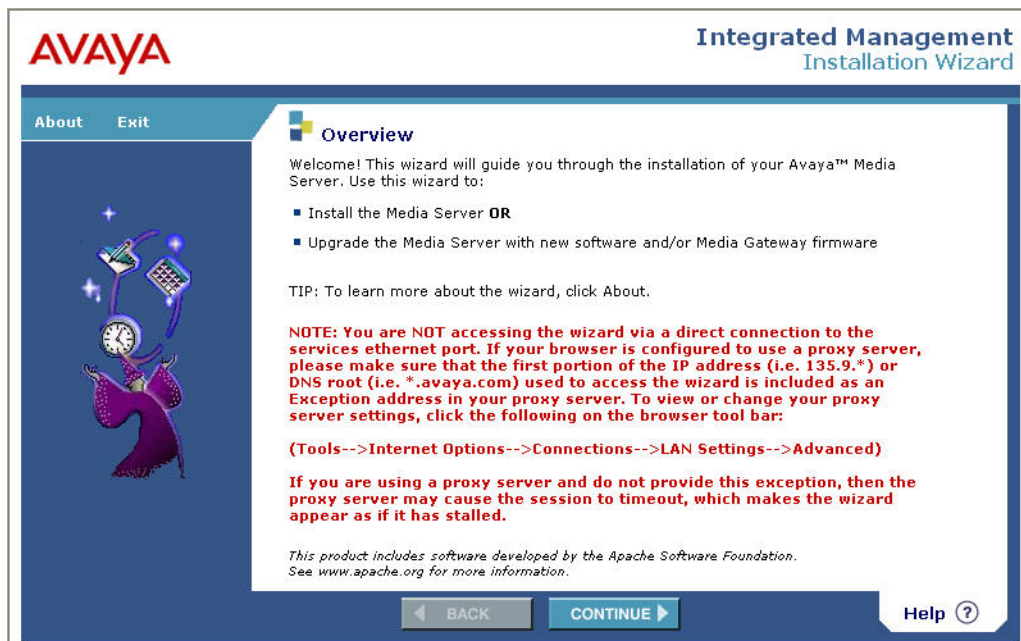

For step-by-step instructions on how to configure the G450 using the Avaya IW, see *Installing and Upgrading the Avaya G450 Media Gateway*, 03-602054.

---

## Accessing GIW

The Gateway Installation Wizard (GIW) is an automated tool that allows you to perform a streamlined installation and configuration of a G450 that does not include an S8300 Server. You can use the GIW to perform initial configuration of the G450 and to upgrade software and firmware. Specifically, you can perform the following tasks with the GIW:

- Configure PMI information (see [Configuring the Primary Management Interface \(PMI\)](#) on page 80)
- Configure SNMP information (see [Configuring SNMP](#) on page 327)
- Configure primary and secondary Media Gateway Controllers (see [Configuring the Media Gateway Controller \(MGC\)](#) on page 82)
- Check connectivity between the G450 and its Media Gateway Controller
- Display information on the G450 and media modules installed on the G450
- Enable the G450 for modem use (see [Configuring the G450 for modem use](#) on page 239)
- Install software and firmware upgrades (see [Software and firmware upgrades](#) on page 98)

---

## Access the GIW

1. Install GIW on a laptop computer from the CD provided by Avaya. The laptop should be running Windows 2000 or Windows XP.
2. Plug one end of an RJ-45 to RJ-45 cable into a DB-9 adapter.
3. Plug the RJ-45 connector at the other end of the cable into the Console port or Services port of the G450.
4. Plug the DB-9 end of the cable into the COM port of the laptop computer.
5. From your laptop computer, double-click the **GIW** icon to run GIW.

Figure 7: GIW Overview screen

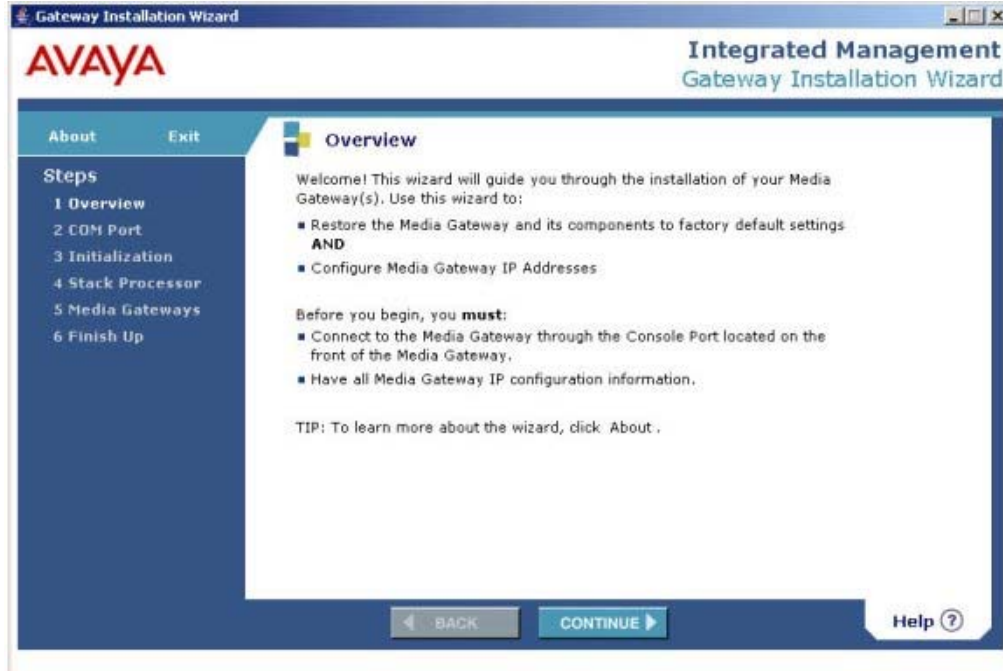

For step-by-step instructions on how to configure the G450 using the GIW, see *Installing and Upgrading the Avaya G450 Media Gateway*, 03-602054.

## Accessing PIM

The Provisioning and Installation Manager (PIM) enables you to remotely configure devices, primarily Avaya media gateways, on a network-wide basis. PIM provides integrated network system views that ease centralized configuration tasks, especially provisioning and installing large numbers of gateways simultaneously.

One of PIM's primary functions is to provision and configure Standard Local Survivability (SLS) on the G450. See [Configuring Standard Local Survivability \(SLS\)](#) on page 117.

PIM is launched from the Avaya Network Management Console. The Avaya Network Management Console is the central infrastructure application that discovers and monitors enabled network devices and runs Avaya Integrated Management applications.

PIM must be installed on the same Windows server as Avaya Network Management Console with System View and Avaya Secure Access Administration.

For detailed information about installing and launching PIM, see *Avaya Integrated Management Enterprise Network Management Installation and Upgrade*, 14-300444.

---

## Accessing Avaya Communication Manager

Use Avaya Communication Manager software to control telephone services that the Avaya G450 Media Gateway provides. Run the Avaya Communication Manager software on a server. There might be several servers on your network that can control the Avaya G450 Media Gateway. Access Avaya Communication Manager on any server that is a Media Gateway Controller (MGC) for the Avaya G450 Media Gateway. For more information, see [Configuring the Media Gateway Controller \(MGC\)](#) on page 82.

Access Avaya Communication Manager with any of the following:

- **Avaya Site Administration (ASA)**. ASA provides wizards and other tools that help you to use Avaya Communication Manager effectively. For more information, see *Administrator Guide for Avaya Communication Manager*, 03-300509.
- **SSH to port 5023 on the MGC**. For more information, see *Administrator Guide for Avaya Communication Manager*, 03-300509.
- **Avaya G450 Media Gateway CLI**. See [Accessing the registered MGC](#) on page 87.

---

## Managing login permissions

You can manage login permissions to enable different privilege levels for each user and to operate the security mechanism.

---

## Security overview

The Avaya G450 Media Gateway includes a security mechanism through which the system administrator defines users and assigns each user a username and password. Each user is assigned a privilege level. The user's privilege level determines which commands the user can perform.

In addition to its basic security mechanism, the G450 supports secure data transfer via SSH and SCP.

The G450 can be configured to work with an external RADIUS server to provide user authentication. When RADIUS authentication is enabled on the G450, the RADIUS server operates in conjunction with the G450 security mechanism. When the user enters a username, the G450 first searches its own database for the username. If the G450 does not find the username in its own database, it establishes a connection with the RADIUS server, and the RADIUS server provides the necessary authentication services.

## Managing users and passwords

You must provide a username and password when you perform any of the following actions:

- When you access the CLI. For more information, see [Accessing the CLI](#) on page 43.
- When you connect a modem with dialup PPP. For more information, see [Accessing the CLI via modem](#) on page 46.
- When you open Avaya G450 Manager.

When you use Avaya G450 Manager or the CLI, your username determines your privilege level. The commands that are available to you during the session depend on your privilege level.

If your network has a RADIUS server, you can use RADIUS authentication instead of a username and password. A RADIUS server provides centralized authentication service for many devices on a network.

## Privilege level

When you start to use Avaya G450 Manager or the CLI, you must enter a username. The username that you enter sets your privilege level. The commands that are available to you during the session depend on your privilege level. If you use RADIUS authentication, the RADIUS server sets your privilege level.

The G450 provides the following three privilege levels:

- **Read-only.** You can use Read-only privilege level to view configuration parameters.
- **Read-write.** You can use Read-write privilege level to view and change all configuration parameters except those related to security. For example, you cannot change a password with Read-write privilege level.
- **Admin.** You can use Admin privilege level to view and change all configuration parameters, including parameters related to security. Use Admin privilege level only when you need to change configuration that is related to security, such as adding new user accounts and setting the device policy manager source.

The default username has Admin privilege level. For security reasons, the network administrator usually changes the password of the default username. For more information about privilege levels, see *Avaya G450 CLI Reference*, 03-602056.

## Configuring usernames

To create a username, use the **username** command. To remove a username, use the **no username** command. To change the password or the privilege level for a username, remove the username and add it again. You need an Admin privilege level to use the **username** and **no username** commands.

**Note:**

When ASG authentication is enabled on the gateway, all password user accounts with usernames similar to the reserved Avaya Services logins are deactivated. The logins are "rasaccess", "sroot", "init", "inads", and "craft". The login "dadmin" is reserved for an Avaya business partner remote services account, which can be defined for ASG authentication. For information about ASG authentication, refer to [Authenticating service logins with Access Security Gateway \(ASG\) authentication](#) on page 55.

When you create a new user, you must define the user's password and privilege level.

The following example creates a user named John with the password johnny69 and a Read-write privilege level:

```
g450-001(super)# username john password johnny69 access-type
read-write
```

---

## Authenticating service logins with Access Security Gateway (ASG) authentication

The gateway supports ASG authentication for remote service logins. Direct remote connection of services to the gateway is needed for gateways that are under service contract, do not have LSPs, and are controlled by external MGCs. ASG is a more secure authentication method than password authentication and does not require a static password.

ASG uses one-time tokens for authentication, in which a unique secret key is associated with each login. ASG authentication is a challenge-response system, in which the remote user receives a challenge from the gateway and returns an ASG authenticated response, which the gateway verifies before permitting access. A new challenge is used for each access attempt.

ASG authentication is supported for remote services connecting to the gateway using telnet or SSH protocols via any of the following:

- Dial-up modem connected to the USB, Console, or Services port
- Frame relay or leased line
- Secure gateway VPN
- Direct connection to the front panel Console port or Services port using the "craft" login

When ASG authentication is enabled on the G450, the G450 recognizes any login attempts using Avaya Services reserved usernames as service logins, and requests ASG authentication from the user, instead of a static user password.

The following usernames are reserved for Avaya Services usage: **rasaccess**, **sroot**, **init**, **inads**, and **craft**.

## Accessing the Avaya G450 Media Gateway

When ASG authentication is enabled on the G450, all password user accounts with usernames similar to the reserved service logins are deactivated.

## Enabling ASG authentication

ASG authentication can be enabled and disabled on the gateway and requires an ASG authentication file. The ASG authentication file contains Avaya Services accounts for authenticating users at login as members of Avaya Services. The G450 is shipped with an ASG authentication file. For information about replacing the authentication file, refer to [Replacing the ASG authentication file](#) on page 56.

- For connection to Avaya Services via modem dial-up, enable the RASaccess operation mode for modem operation, using **ppp authentication ras**. The G450 must also be configured for remote modem access and enabled, as described in *Installing and Upgrading the Avaya G450 Media Gateway*, 03-602054.
- For connection to Avaya Services via embedded VPN service, set up the VPN service for Services to connect.

### Note:

By default, Avaya Services login access is enabled. If Avaya Services login access was blocked using **no login authentication services-logins**, you can reactivate it using **login authentication services-logins**.

## Replacing the ASG authentication file

In case of any problems with the ASG authentication file, you can download a newer authentication file from the Authentication File System (AFS). You cannot install an authentication file with a different authentication file ID to that of the authentication file currently installed in the gateway.

### Note:

If there is a need to install an authentication file with a different ID, you must first delete the current authentication file using the command **erase auth-file**. This command requires Supervisor level access and can only be used when directly connecting to the Console or Services port. If you do delete the authentication file and replace it with an authentication file with a new ID, the authentication file label on the gateway chassis must also be replaced.

1. Optionally display the current ASG authentication file version, using the **show auth-file info** command. For example:

```
G450-001(super)# show auth-file info
Authentication File (AF) information:
AF-ID :7000012345
Date/time : 15:02:27 27-SEP-2005
Major release : 4
```



2. Use Windows File Explorer or another file management program to create a directory on an FTP, SCP or TFTP server for storing authentication files (for example, C:\licenses).
3. Access the Internet and go to rfa.avaya.com.
4. Login using your SSO login and password. The AFS and RFA information home page appears.
5. Start the AFS application from the **RFA information** page. Follow the instructions outlined in the *Authentication File System (AFS) Guide*, 03-601703 to create and download the authentication file.
6. Download the authentication file from an FTP, SCP or TFTP server or USB mass storage device to the G450. To install the authentication file, use one of the following commands:
  - To download an authentication file from a remote FTP server: **copy ftp auth-file filename ip**, where **filename** is the name of the authentication file, including the full path and **ip** is the IP address of the host. The G450 prompts you for a username and password after you enter the command.
  - To download an authentication file from a remote SCP server: **copy scp auth-file filename ip**, where **filename** is the name of the authentication file, including the full path and **ip** is the IP address of the host. The G450 prompts you for a username and password after you enter the command.
  - To download an authentication file from a remote TFTP server: **copy tftp auth-file filename ip**, where **filename** is the name of the authentication file, including the full path and **ip** is the IP address of the host. The G450 prompts you for a username and password after you enter the command.
  - To download an authentication file from a USB mass storage device: **copy usb auth-file source-usb-device source-filename**, where **source-usb-device** is the source USB mass storage device and **source-filename** is the full name and path of the authentication file.

The authentication file is downloaded. You can view the download status using **show download auth-file status**.

**Note:**

You can also upload the authentication file from the gateway for troubleshooting. To upload the authentication file, use **copy auth-file ftp** to upload it to an FTP server, **copy auth-file scp** to upload it to an SCP server, **copy auth-file tftp** to upload it to a TFTP server, or **copy auth-file USB** to upload it to a USB mass storage device. To display the upload status, use **show upload auth-file status**.

## Configuring ASG authentication

You can perform the following ASG configurations:

- Block Avaya Services login access, using **no login authentication services-logins**. This deactivates all Avaya Services logins, including local craft password-based authenticated login. To reactivate, use **login authentication services-logins**.
- Set the time the gateway waits for user response to authentication requests before timing out a connection, using **login authentication response-time time**, where **time** is the time, in seconds, after which the gateway aborts the connection if no response is received.

For example, to timeout connections if no response arrives within 180 seconds after an authentication request:

```
G450-001(super)# login authentication response-time 180
```

Use **no login authentication response-time** to return the response time value to the factory default of 120 seconds. The time value you enter is used for both:

- The response time interval between the username prompt and the username entry
- The response time interval between the challenge prompt and the challenge response
- Deactivate password authentication and activate ASG authentication of Avaya Services local connections to the Console port and Services port. To do this, use **no login authentication local-craft-password**. To enable password authentication of Avaya Services local connections to the Console port and Services port, use **login authentication local-craft-password** (default).
- Set a policy for locking out access to the gateway after successive failed login attempts. To do this, use **login authentication lockout time attempt count**, where **time** is the interval of time for which lockout is enforced and **count** is a number of failed attempts after which lockout is enforced. Use **no login authentication lockout** to return the lockout time and lockout attempt threshold to their default values (180 and 3).

For example, to lockout Avaya Services access to the device for 360 seconds following five failed login attempts:

```
G450-001(super)# login authentication lockout 360 attempt 5
```

This lockout affects all users locally stored in the gateway, including locally defined user accounts and Avaya Services logins defined in the ASG authentication file. Remote users maintained centrally in a Radius server are not subject to the lockout sanction.

- Switch between modem operation modes, including rasaccess and ppp modes, using **ppp authentication {pap|chap|none|ras}**. ASG authentication is enabled when **ras** is selected. For example:

```
G450-001(super)# ppp authentication ras
```

## Displaying ASG authentication information

- Display login authentication settings and information, using **show login authentication**. For example:

```
G450-001(super)# show login authentication
Services logins: On
Local craft: On
Lockout time: 180 seconds
Lockout attempt threshold: 3
Authentication response time: 120 seconds
CLI logout timeout: Off
```

- Display ASG authentication file information, using **show auth-file info**. For example:

```
G450-001(super)# show auth-file info
Authentication File (AF) information:
AF-ID :7000012345
Date/time : 15:02:27 27-SEP-2005
Major release : 4
```

- Display all locally defined user accounts, including services accounts and account type information such as authentication method, using **show username**. For example:

```
G450-001(super)# show username
User account  Access level  Account type  Active  Authent. method
-----
sroot         dev           Services     yes     challenge
init          dev           Services     yes     challenge
inads         tech          Services     yes     challenge
craft         admin         Services     yes     challenge
dadmin        admin         local        yes     challenge
rasaccess     read-only    Services     yes     challenge
root          admin         local        yes     password
```

## Summary of ASG authentication CLI Commands

For more information about these commands, see *Avaya G450 CLI Reference*, 03-300437.

**Table 3: ASG authentication CLI command**

Command	Description
<code>copy auth-file ftp</code>	Upload the authentication file from the gateway to an FTP server
<code>copy auth-file scp</code>	Upload the authentication file from the gateway to an SCP server
<code>copy auth-file tftp</code>	Upload the authentication file from the gateway to a TFTP server
<code>copy auth-file usb</code>	Upload the authentication file from the gateway to a USB mass storage device
<code>copy ftp auth-file</code>	Download an ASG authentication file from a remote FTP server
<code>copy scp auth-file</code>	Download an ASG authentication file from a remote SCP server
<code>copy tftp auth-file</code>	Download an ASG authentication file from a remote TFTP server
<code>copy usb auth-file</code>	Download an ASG authentication file from a USB mass storage device
<code>erase auth-file</code>	Erase the gateway's ASG authentication file
<code>login authentication local-craft-password</code>	Enable password authentication of Avaya Services local connections to the Console port and Services port with the "craft" login. Use the <b>no</b> form to disable password authentication for Avaya Services local connections to the Console port and Services port. When password authentication is disabled, ASG authentication is activated.
<code>login authentication response-time</code>	Set the time the gateway waits for user response to authentication requests before timing out a connection
<code>login authentication lockout</code>	Set a policy for locking out access to the gateway after successive failed login attempts

1 of 2

Table 3: ASG authentication CLI command (continued)

Command	Description
<code>login authentication services-logins</code>	Activate all Avaya Services logins, including local login to Console port and Services port with "craft" login. Use the <code>no</code> form to deactivate all Avaya Services logins.
<code>ppp authentication</code>	Set modem operation mode. Setting the mode to <code>ras</code> enables ASG authentication for Avaya Services remote logins through dial-up modem connection.
<code>show auth-file info</code>	Display ASG authentication file information
<code>show download auth-file status</code>	Display download status of ASG authentication file, after using <code>copy ftp scp tftp usb auth-file</code> to download an authentication file to the gateway
<code>show login authentication</code>	Display login authentication settings and information
<code>show upload auth-file status</code>	Display upload status of ASG authentication file, after using <code>copy auth-file ftp scp tftp</code> to upload an authentication file from the gateway

2 of 2

## SSH protocol support

Secure Shell (SSH) protocol is a security protocol that enables you to establish a remote session over a secured tunnel, also called a remote shell. SSH accomplishes this by creating a transparent, encrypted channel between the local and remote devices. In addition to the remote shell, SSH provides secure file transfer between the local and remote devices. SSH is used for telnet file transfers. The G450 supports two concurrent SSH users.

Establishing an SSH session can be done by RSA authentication, or password authentication. To determine which of these ways is used on your G450, enter `show ip ssh`.

## RSA authentication process

- The G450 generates a key of variable length (512-2048 bits) using the DSA encryption method. This is the private key.
- The G450 calculates an MD5 hash of the private key, called the public key (also called a fingerprint). The public key is always 16 bytes long. This public key is displayed.
- The G450 sends the public key to the client computer. This public key is used by the client to encrypt the data it sends to the G450. The G450 decrypts the data using the private key.

## Accessing the Avaya G450 Media Gateway

- Both sides negotiate and must agree on the same chipper type. The G450 only supports 3DES-CBC encryption. The user on the client side accepts the public key. The client maintains a cache containing a list of fingerprints per server IP address. If the information in this cache changes, the client notifies the user.
- The client chooses a random number that is used to encrypt and decrypt the information sent.
- This random number is sent to the G450, after encryption based on the G450's public key.
- When the G450 receives the encrypted random number, it decrypts it using the private key. This random number is now used with the 3DES-CBC encryption method for all encryption and decryption of data. The public and private keys are no longer used.

## Password authentication process

Before any data is transferred, the G450 requires the client to supply a username and password. This authenticates the user on the client side to the G450.

## SSH configuration

- To enable SSH on the G450:
  - a. To execute the SSH protocol, the G450 must first be assigned hostname identification. Use the **hostname** command to assign hostname identification.
  - b. To enable SSH to be used, you must also configure the server host key. Use the **crypto key generate dsa** command to generate an SSH host key pair.
  - c. Enter **ip ssh** to enable SSH authentication. Note that SSH is enabled by default.
- To disable SSH on the G450:
  - Use the **disconnect ssh** command to disconnect an existing SSH session.
  - Enter **no ip ssh** to disable the SSH server which disconnects all active SSH sessions.
- Enter **show ip ssh** to display SSH configuration information and information about any active SSH sessions.

## Summary of SSH configuration commands

For more information about these commands, see *Avaya G450 CLI Reference*, 03-300437.

**Table 4: SSH configuration commands**

Command	Description
<code>crypto key generate dsa</code>	Generate an SSH host key pair
<code>disconnect ssh</code>	Disconnect an existing SSH session
<code>hostname</code>	Assign hostname identification to the G450
<code>ip ssh</code>	Enable or disable the Secure Shell (SSH) service
<code>show ip ssh</code>	Display general SSH information and information about the currently active connections that are using SSH

---

## SCP protocol support

In addition to data transfer via an SSH session, the SSH protocol is used to support SCP for secure file transfer. When using SCP, the G450 is the client, and an SCP server must be installed on the management station. After users are defined on the SCP server, the G450 acts as an SCP client.

The process of establishing an SCP session is the same process as described in [SSH protocol support](#) on page 61, except that the roles of the G450 and the client computer are reversed.

To perform file transfers secured by SCP, the G450 launches a local SSH client via the CLI. This establishes a secured channel to the secured file server. The G450 authenticates itself to the server by providing a username and password. With a Windows-based SSH server (WinSSHD), the username provided must be a defined user on the Windows machine with read/write privileges. The files transferred via SCP are saved in the `C:\Documents and Settings\username` directory.

The network element performs file transfer in unattended mode.

## SCP configuration

Enter `clear ssh-client known-hosts` to clear the client's list of SCP server fingerprints. Each SCP client maintains a list of server fingerprints. If a key changes, the client's verification of the server's fingerprint will fail, thereby preventing the client's access to the SCP server. If this happens, you can enter `clear ssh-client known-hosts` to erase the client's server fingerprint list. This enables the client to access the server and begin to recreate its list of fingerprints with the SCP server's new fingerprint.

## Summary of SCP configuration commands

For more information about these commands, see *Avaya G450 CLI Reference*, 03-300437.

**Table 5: SCP configuration commands**

Command	Description
<code>clear ssh-client known-hosts</code>	Clear the SSH known-host file content

---

## RADIUS authentication

If your network has a RADIUS server, you can configure the G450 to use RADIUS authentication. A RADIUS server provides centralized authentication service for many devices on a network. When you use RADIUS authentication, you do not need to configure usernames and passwords on the G450. When you try to access the G450, the G450 searches for your username and password in its own database first. If it does not find them, it activates RADIUS authentication.

For additional information on RADIUS configuration and authentication, go to the Avaya website at <http://www.avaya.com/support>, and perform a search for the document *Avaya G700/G350 RADIUS Configuration Overview*, 104207.

## Using RADIUS authentication

1. Configure your RADIUS server with the usernames, passwords, and privilege levels that you want to use on the G450.
2. Configure RADIUS authentication on the G450.

## Configuring RADIUS authentication

1. Enter `set radius authentication enable` to enable RADIUS authentication.



2. Use the **set radius authentication secret** command to set the shared secret for the authentication. This command must be followed by a text string. For example:

```
set radius authentication secret hush
```

3. Use the **set radius authentication server** command to set the IP address of the primary or secondary RADIUS Authentication server.

For more information about these commands, see *Avaya G450 CLI Reference*, 03-602056.

## Changing RADIUS parameters

The following commands are optional:

- Use the **set radius authentication retry-number** command to set the number of times to resend an access request when there is no response.
- Use the **set radius authentication retry-time** command to set the time to wait before resending an access request.
- Use the **set radius authentication udp-port** command to set the RFC 2138 approved UDP port number. Normally, the UDP port number should be set to its default value of 1812. Some early implementations of the RADIUS server used port number 1645.

## Disabling RADIUS authentication

Enter **set radius authentication disable** to disable RADIUS authentication on the G450.

## Displaying RADIUS parameters

Enter **show radius authentication**. Shared secrets are not displayed.

## Summary of RADIUS authentication configuration commands

For more information about these commands, see *Avaya G450 CLI Reference*, 03-300437.

**Table 6: RADIUS authentication configuration command**

Command	Description
<code>clear radius authentication server</code>	Clear the primary or secondary RADIUS server IP address
<code>set radius authentication</code>	Enable or disable RADIUS authentication
<code>set radius authentication retry-number</code>	Set the number of times to resend an access request when there is no response
<code>set radius authentication retry-time</code>	Set the time to wait before resending an access request
<code>set radius authentication secret</code>	Set the shared secret for RADIUS authentication
<code>set radius authentication server</code>	Set the IP address of the primary or secondary RADIUS authentication server
<code>set radius authentication udp-port</code>	Set the RFC 2138 approved UDP port number
<code>show radius authentication</code>	Display all RADIUS authentication configurations (shared secrets are not displayed)

---

## Special security features

Special security features allow you to enable and disable the recovery password, establish incoming and outgoing telnet connections, copy gateway configurations while keeping configuration secrets, and configure SYN cookies for preventing SYN attacks.

---

## Enabling and disabling recovery password

The G450 includes a special recovery password. The purpose of the recovery password is to enable the system administrator to access the G450 in the event that the regular password is forgotten. You can only use the recovery password when accessing the G450 via a direct connection to the Console port or Services port.

Use the **set terminal recovery password** command to enable or disable the recovery password. Use this command only when accessing the G450 via a direct connection to the Console port or Services port.

## Summary of recovery password commands

For more information about these commands, see *Avaya G450 CLI Reference*, 03-300437.

**Table 7: Master Configuration Key configuration commands**

Command	Description
<b>set terminal recovery password</b>	Enable or disable the recovery password

---

## Enabling and disabling telnet access

You can enable and disable the G450's ability to establish incoming and outgoing telnet connections, using the following commands. You can only use these commands when accessing the G450 via a direct connection to the Console port.

- Use the **ip telnet** command to enable the G450 to establish an incoming telnet connection. Use the **no** form of this command to disable the G450's ability to establish an incoming telnet connection.
- Enter **ip telnet-client** to enable the G450 to establish an outgoing telnet connection. Use the **no** form of this command to disable the G450's ability to establish an outgoing telnet connection.
- Use the **ip telnet-services** command to enable the telnet server on the Services interface.

**Note:**

These commands are secured commands and are not displayed together with the running configuration (using the **show running-config** command). To see the status of these commands, use the **show protocol** command.

- Use the `show ip telnet` command to display the status of the Telnet server and the current Telnet connections.

## Summary of Telnet access configuration commands

For more information about these commands, see *Avaya G450 CLI Reference*, 03-300437.

**Table 8: Telnet access configuration commands**

Command	Description
<code>ip telnet</code>	Enable the G450 to establish an incoming telnet connection, or disable its ability to establish an incoming telnet connection
<code>ip telnet-client</code>	Enable the G450 to establish an outgoing telnet connection, or disable its ability to establish an outgoing telnet connection
<code>ip telnet-services</code>	Enable the telnet server on the Services interface
<code>show ip telnet</code>	Display the status of the Telnet server and the current Telnet connections
<code>show protocol</code>	Display the status of the telnet or telnet-client protocol
<code>telnet</code>	Initiate a login session via telnet to a network host

---

## Managing gateway secrets

The G450 provides a mechanism for storage, backup, and restore of sensitive materials (passwords and keys) maintained in the Media Gateways.

All sensitive materials are encrypted using a Master Configuration Key (MCK), derived from a passphrase entered by an administrator. The secrets are then stored in the configuration file in an encrypted format. This enables copying configurations, including secrets, from one device to another. The only requirement is that the administrator must generate an identical MCK (by using the same passphrase) in the target device before executing the copy operation.

**Note:**

All gateways have the same default MCK. For security reasons, it is recommended to configure a new MCK immediately upon gateway installation.

## Configuring the Master Configuration Key

1. Enter `key config-key password-encryption` followed by a phrase of 13-64 printable ASCII characters.
2. Copy the running configuration to the start-up configuration using the `copy running-config startup-config` command.

The new MCK is now in effect.

## Summary of Master Configuration Key configuration commands

For more information about these commands, see *Avaya G450 CLI Reference*, 03-300437.

**Table 9: Master Configuration Key configuration commands**

Command	Description
<code>key config-key password-encryption</code>	Set the default Master Configuration Key of the gateway

## Enabling SYN cookies

The G450 provides various TCP/IP services and is therefore exposed to a myriad of TCP/IP based DoS attacks.

*DoS (Denial of Service) attacks* refers to a wide range of malicious attacks that can cause a denial of one or more services provided by a targeted host. Specifically, a *SYN attack* is a well-known TCP/IP attack in which a malicious attacker targets a vulnerable device and effectively denies it from establishing new TCP connections.

*SYN cookies* refers to a well-known method of protection against a SYN attack.

### SYN attack (SYN flood attack)

The SYN (TCP connection request) attack is a common DoS attack characterized by the following pattern:

Using a spoofed IP address, an attacker sends multiple SYN packets to a listening TCP port on the target machine (the victim). For each SYN packet received, the target machine allocates resources and sends an acknowledgement (SYN-ACK) to the source IP address. The TCP connection is called a “half-open” connection at this point since the initiating side did not yet send back an acknowledgment (termed the 3rd ACK).

Because the target machine does not receive a response from the attacking machine, it attempts to resend the SYN-ACK, typically five times, at 3-, 6-, 12-, 24-, and 48-second intervals, before de-allocating the resources, 96 seconds after attempting the last resend. Altogether, the target machine typically allocates resources for over three minutes to respond to a single SYN attack.

When an attacker uses this technique repeatedly, the target machine eventually runs out of memory resources since it holds numerous half-open connections. It is unable to handle any more connections, thereby denying service to legitimate users.

Moreover, flooding the victim with TCP SYN at a high rate can cause the internal queues to fill up, also causing a denial of service.

### SYN cookies

SYN cookies protect against SYN attacks by employing the following strategies:

- Not maintaining any state for half-open inbound TCP sessions, thus preventing the SYN attack from depleting memory resources.

SYN cookies are able to maintain no state for half-open connections by responding to SYN requests with a SYN-ACK that contains a specially crafted initial sequence number (ISN), called a cookie. The value of the cookie is not a pseudo-random number generated by the system, but the result of a hash function. The hash result is generated from the source IP, source port, destination IP, destination port, and some secret values. The cookie can be verified when receiving a valid 3rd ACK that establishes the connection. The verification ensures that the connection is a legitimate connection and that the source IP address was not spoofed.

- Employing the SYN cookies method at a lower point in the network stack than regular TCP handling, closer to the start point of packet handling. This reduces the chances that a SYN attack will fill up the internal queues.
- Performing SYN attack fingerprinting and alerting an administrator about a SYN attack as it occurs. This is implemented by keeping track of the rate at which half-open TCP connections are created, and sending an alert when the rate exceeds a certain threshold.

In addition, when the SYN cookies mechanism is active, a hostile port scan might be misled into concluding that all TCP ports are open.

### Configuring SYN cookies

1. Enter `tcp syn-cookies`.
2. Copy the running configuration to the start-up configuration using the `copy running-config startup-config` command.
3. Reset the device using the `reset` command.

SYN cookies are now enabled on the device.

## SYN attack notification

When the SYN cookies feature is enabled, the G450 alerts the administrator to a suspected SYN attack as it occurs by sending the following syslog message:

```
SYN attack suspected! Number of unanswered SYN requests is greater
than 20 in last 10 seconds.
```

## Maintaining SYN cookies

Use the following commands to show and clear SYN cookies statistics:

- Enter **show tcp syn-cookies** to show SYN cookies statistics.

**Note:**

For an example and explanation of SYN cookies statistics, see *Avaya G450 CLI Reference*, 03-602056.

- Enter **clear tcp syn-cookies counters** to clear the SYN cookies counters.

## Summary of SYN cookies configuration commands

For more information about these commands, see *Avaya G450 CLI Reference*, 03-300437.

**Table 10: Master Configuration Key configuration commands**

Command	Description
<b>clear tcp syn-cookies counters</b>	Clear the SYN cookies counters
<b>show tcp syn-cookies</b>	Show SYN cookies statistics for inbound TCP connections
<b>tcp syn-cookies</b>	Enable or disable the TCP SYN cookies defense mechanism against SYN attacks

---

## Managed Security Services (MSS)

Media Gateway IP interfaces and gateway applications such as WAN routers, PoE switches, and VPN devices can be at risk for DoS attacks. The G450 identifies predefined or custom-defined traffic patterns as suspected attacks and generates SNMP notifications, referred to as Managed Security Services (MSS) notifications.

## MSS reporting mechanism

MSS notifications are sent to the active MGC by the dynamic trap manager. MSS notifications sent to the active MGC by the dynamic trap manager are converted to syslog messages by the SNMP trap manager on the MGC. For general information about configuring and enabling syslog messages and syslog message format, refer to [Configuring a Syslog server](#) on page 210.

MSS notifications are intercepted and, if certain conditions are met, may be forwarded to the Avaya Security Operations Center (SOC) as INADS alarms. The SOC is an Avaya service group that handles DoS alerts, responding as necessary to any DoS attack or related security issue.

**Note:**

The syslog messages on the active MGC are stored in the messages file on the MGC hard disk. You can view the syslog messages through the Avaya Maintenance Web Interface (MWI) if you want to debug security issues directly. For information about how to view syslog messages, see [Viewing QoS traps, QoS fault traps, and QoS clear traps](#) on page 392.

**Note:**

Any additional SNMP recipients defined with the security notification group enabled also receive the MSS notifications.

## Configuring MSS

The MSS feature is automatically enabled and monitors all IP interfaces, including WAN data interfaces, IPSEC tunnels, Ethernet LAN and WAN ports, VoIP engine interfaces, and Dialer and Serial PPP interfaces.

1. Verify that the dynamic trap manager, which automatically sets the IP address of the active MGC SNMP trap manager, is configured so that security notifications are sent to the active MGC. By default, all types of notifications are enabled. You can enter `show snmp` to check which notification groups are configured to be sent to the active MGC. You can modify the dynamic trap manager configuration using the `snmp-server dynamic-trap-manager` command, setting the notification type to `all` or `security`.



2. If required, define additional notification recipients using the **snmp-server group**, **snmp-server host**, and **snmp-server user** commands, and activating the security notification filter. For example:

```

//define an SNMP group:
G450-001(super)# snmp-server group MSS_group v3 noauth read iso write iso
notify iso
Done!
//create a new snmp user belonging to the SNMP group:
G450-001(super)# snmp-server user MSS MSS_group v3
Done!
//identify an SNMP trap recipient, activating the security notification
filter:
G450-001(super)# snmp-server host 5.5.5.2 traps v3 noauth MSS security
Done!
//view the SNMP configuration
G450-001(super)# show snmp
Authentication trap disabled
Community-Access Community-String
-----
read-only *****
read-write *****

SNMPv3 Notifications Status
-----
Traps: Enabled
Informs: Enabled Retries: 3 Timeout: 3 seconds
SNMP-Rec-Address Model Level Notification Trap/Inform User name
-----
5.5.5.2 v3 noauth all trap MSS
UDP port: 162

```

3. Use the **set mss-notification rate** command to modify the MSS reporting rate, if necessary. The default is 300 seconds. The G450 counts events for each DoS class for the duration of the interval. At the end of each interval, if the count of each class of DoS events surpasses a defined threshold, the G450 generates an MSS notification, reporting on the event type, event parameters, and the number of occurrences. To display the current MSS reporting rate, use the **show mss-notification rate** command.
4. Ensure that INADS reporting is configured on the active MGC. For information about configuring INADS reporting in Avaya Communication Manager, see Avaya Communication Manager documentation.

## DoS attack classifications

Traffic patterns meeting the DoS attack classifications are automatically reported in MSS notifications.

**Table 11: DoS attack classifications**

DoS Attack	Description
LAND_ATTACK	Land attack packets with the source IP the same as an IP address
TCP_URGENT_ATTACK	TCP packets with the URGENT option set
ICMP_RATE_LIMIT	ICMP (echo) requests exceeding a pre-defined rate
SMURF_ATTACK	ICMP echo packets with limited broadcast destination address
FRAGGLE_ATTACK	UDP packets with limited broadcast destination address
SYN-FLOOD	The number of unacknowledged TCP SYN-ACK exceeds a predefined rate
UNREACHABLE_PORT_ATTACK	TCP/UDP IP packets sent to unreachable ports
MALFRAGMENTED_IP	Malfragmented IP packets on TO-ME interfaces
MALFORMED_IP	Malformed IP packets. The G450 reports malformed IP packets when: <ul style="list-style-type: none"> <li>• The IP version in the IP header is a value other than 4</li> <li>• The IP header length is smaller than 20</li> <li>• The total length is smaller than the header length</li> </ul>
MALFORMED_ARP	ARP messages with bad opcode
SPOOFED_IP	For all routable packets, the Gateway report reception of IP spoofed packets
UNKNOW_L4_IP_PROTOCOL	Packets with unknown (unsupported or administratively closed) protocol in IP packet with TO-ME interface as a destination
UNAUTHENTICATED_ACCESS	Failure to authenticate services

## Defining custom DoS classifications

You can define custom DoS attack classifications using access control list (ACL) rules. ACL rules control which packets are authorized to pass through an interface. A custom DoS class is defined by configuring criteria for an ACL rule and tagging the ACL with a DoS classification label.

### Note:

For general information about configuring policy rules, refer to [Configuring policy](#) on page 591.

### Defining a DoS class using ACLs

1. Use the **ip access-control-list** command to enter the configuration mode of an ACL. For example:

```
G450-001(super)# ip access-control-list 301
```

2. Use the **ip-rule** command to enter the configuration mode of an ACL rule. For example:

```
G450-001(super)# ip-rule 1
```

3. Use the **dos-classification** command to configure the name of the DoS attack classification. Possible values are: `fraggle`, `smurf`, `ip-spoofing`, `other-attack-100`, `other-attack-101`, `other-attack-102`, `other-attack-103`, `other-attack-104`, and `other-attack-105`. For example:

```
G450-001(super-ACL 301/ip rule 1)# dos-classification smurf
Done!
```

4. Define the packet criteria to which the ACL rule should apply. See [Policy lists rule criteria](#) on page 600.

For example, you can use **destination-ip** to specify that the rule applies to packets with a specific destination address and you can use **ip-protocol** to specify that the rule applies to packets with a specific protocol:

```
G450-001(super-ACL 301/ip rule 1)# destination-ip 255.255.255.255 0.0.0.0
Done!
G450-001(super-ACL 301/ip rule 1)# ip-protocol icmp
Done!
```

5. Use the **composite-operation** command to associate the ACL rule with the predefined operation “deny-notify,” which tells the gateway to drop any packet received that matches the ACL rule, and send a trap upon dropping the packet. For example:

```
G450-001(super-ACL 301/ip rule 1)# composite-operation deny-notify
Done!
```

## Accessing the Avaya G450 Media Gateway

6. Exit the ACL rule. For example:

```
G450-001(super-ACL 301/ip rule 1)# exit
```

7. Exit the ACL. For example:

```
G450-001(super-ACL 301)# exit
```

8. Enter the configuration mode of the interface on which you want to activate the ACL. For example:

```
G450-001(super)# interface vlan 203
```

9. Activate the configured ACL for incoming packets on the desired interface. For example:

```
G450-001(super-if:vlan 203)# ip access-group 301 in
Done!
```

## Example

The following example demonstrates the configuration of MSS notifications using ACL rules. In this example, smurf packets (ICMP packets that are sent to a limited broadcast destination) arriving at interface VLAN 203 are defined as a DoS attack to be reported in MSS notifications.

```
//create and enter the configuration mode of access control list 301:
G450-001(super)# ip access-control-list 301
//create and enter the configuration mode of ip rule 1:
G450-001(super-ACL 301/ip rule 1)# ip-rule 1
//set the rule criteria for the custom DoS classification:
//use dos-classification command to specify to report on receiving smurf
//packets (ICMP echo packets with limited broadcast destination address )
G450-001(super-ACL 301/ip rule 1)# dos-classification smurf
Done!
//apply predefined composite-operation deny-notify, which drops the packet and
//causes the gateway to send a trap when it drops the packet
G450-001(super-ACL 301)# composite-operation Deny-Notify
Done!
//specify that the ip rule applies to packets with this destination ip address.
G450-001(super-ACL 301/ip rule 1)# destination-ip 255.255.255.255 0.0.0.0
Done!
//Specify that the ip rule applies to ICMP packets
G450-001(super-ACL 301/ip rule 1)# ip-protocol icmp
Done!
G450-001(super-ACL 301/ip rule 1)# exit
G450-001(super-ACL 301)# show ip-rule
```

Index	Protocol	IP	Wildcard	Port	Operation
	DSCP				Fragment rule
1	icmp	Src Any		Any Type	Deny-Notify
		Dst 255.255.255.255	Host	Any Code	No

```

Dos classification: smurf
Deflt Any Src Any Any Permit
Any Dst Any Any No

G450-001(super-ACL 301)# exit
G450-001(super)# interface vlan 203
//activate Access Control list 301 for incoming packets on interface vlan 203:
G450-001(super-if:VLAN 203)# ip access-group 301 in
Done!
```

## Summary of MSS configuration CLI commands

For more information about these commands, see *Avaya G450 CLI Reference*, 03-300437.

**Table 12: MSS configuration CLI commands**

Command	Description
<code>composite-operation</code>	Edit the specified composite operation. If the composite operation does not exist, it is created
<code>destination-ip</code>	Specify the destination IP address of packets to which the current rule applies
<code>dos-classification</code>	Set a label for a user-defined DoS attack classification to be reported in MSS notifications
<code>ip access-control-list</code>	Enter configuration mode for the specified policy access control list. If the specified list does not exist, the system creates it and enters its configuration mode.
<code>ip-rule</code>	Enter configuration mode for the specified rule. If the specified rule does not exist, the system creates it and enters its configuration mode.
<code>ip-protocol</code>	Specify that the current rule applies to packets having the specified IP protocol
<code>set mss-notification rate</code>	Set the rate at which the gateway sends Managed Security Services (MSS) notifications
<code>show mss-notification rate</code>	Show the interval time, in seconds, between MSS notifications
<code>show snmp</code>	Display SNMP configuration information
<code>snmp-server dynamic-trap-manager</code>	Modify the SNMP settings of the dynamic trap manager
<code>snmp-server group</code>	Define a new SNMPv3 group, or configure settings for the group
<code>snmp-server host</code>	Identify an SNMP management server, and specify the kind of messages it receives
<code>snmp-server user</code>	Configure settings for an SNMPv3 user

# Chapter 5: Basic device configuration

Basic device configuration lets you:

- Define a new interface and its IP address
- Configure parameters that identify the G450 to other devices
- Define a G450 interface as the G450's default gateway
- Configure an MGC to work with the G450
- Configure DNS resolver for resolving hostnames to IP addresses
- View the status of the G450
- Manage and upgrade software, firmware, configuration, and other files on the G450
- Backup and restore the G450

---

## Defining an interface

All interfaces on the G450 must be defined by the administrator, after installation of the G450.

1. Use the **interface** command to enter the interface context. Some types of interfaces require an identifier as a parameter. Other types of interfaces require the interface's module and port number as a parameter. For example:

```
interface vlan 1
interface serial 3/1
interface fastethernet 10/2.0
```

For more information on the various types of interfaces, see [Router interface concepts on page 444](#).

2. Use the **ip address** command, followed by an IP address and subnet mask, to assign an IP address to the interface.
3. Use the **load-interval** command to set the load calculation interval for the interface.

For a list and descriptions of other interface configuration commands, see [Configuring interfaces](#) on page 443. For interface configuration examples, see [Configuration example on page 279](#).

---

## Configuring the Primary Management Interface (PMI)

The Primary Management Interface (PMI) address is the IP address of an interface that you can specify on the Avaya G450 Media Gateway. The first IP address you configure on the G450 automatically becomes the PMI. You can subsequently assign any IP interface to be the PMI.

The PMI is used as the IP address of the G450 for the following management functions:

- Registration of the G450 to an MGC
- Sending SNMP traps
- Opening telnet sessions from the G450
- Sending messages from the G450 using FTP and TFTP protocol

You can designate any of the G450's interfaces to serve as the G450's PMI. The PMI must be an IP address that the MGC recognizes. If you are not sure which interface to use as the PMI, check with your system administrator.

---

## Setting the PMI of the G450

1. Use the **interface** command to enter the context of the interface to which you want to set the PMI. For example, to use the VLAN 1 interface as the PMI, enter **interface vlan 1**.

**Note:**

If the interface has not been defined, you must define it now.

2. Enter **pmi**.
3. Enter **exit** to return to general context.
4. Enter **copy running-config startup-config**. This saves the new PMI in the startup configuration file.
5. Use the **reset** command to reset the G450.

**Note:**

Most configuration changes take effect as soon as you make the change, but must be saved to the startup configuration file in order to remain in effect after you reset the G450. The PMI address is an exception. A change to the PMI does not take effect at all until you reset the G450.

6. To verify the new PMI, enter **show pmi** in general context. If you use this command before you reset the G450, it displays two different PMIs:
  - **Active PMI.** The PMI that the G450 is currently using, as defined in the running configuration file



- **Configured PMI.** The PMI that the G450 is configured to use after reset, as defined in the startup configuration file

If you use this command after you reset the G450, both the Active and the Configured PMI should be the same IP address.

7. Use the following commands to configure other identification information:
  - Use the **set system contact** command to set the contact information for the G450
  - Use the **set system location** command to set the location information for the G450
  - Use the **set system name** command to specify the name of the G450

---

## Summary of PMI configuration CLI commands

For more information about these commands, see *Avaya G450 CLI Reference*, 03-300437.

**Table 13: PMI configuration CLI commands**

Root level command	Command	Description
<code>interface (fastethernet   serial   tunnel   vlan   loopback   dialer)</code>		Enter configuration mode for the FastEthernet, Serial, Tunnel, VLAN, Loopback, or Dialer interface
	<code>pmi</code>	Set the current interface as the Primary Management Interface for the system
<code>set system contact</code>		Set the contact information for this media gateway system
<code>set system location</code>		Set the location information for this media gateway system
<code>set system name</code>		Set the name of the media gateway system
<code>show pmi</code>		Display the current Primary Management Interface

---

## Defining the default gateway

The G450 uses a default gateway to connect to outside networks that are not listed on the G450's routing table. To define a default gateway, use the `ip default-gateway` command, followed by either the IP address or name (type and number) of the interface you want to define as the default gateway.

The following example defines the interface with the IP address 132.55.4.45 as the default gateway:

```
ip default-gateway 132.55.4.45
```

The following example defines Serial interface 3/1:1 as the default gateway:

```
ip default-gateway serial 3/1:1
```

---

## Summary of default gateway configuration CLI commands

For more information about these commands, see *Avaya G450 CLI Reference*, 03-300437.

**Table 14: PMI configuration CLI commands**

Command	Description
<code>ip default-gateway</code>	Set a default gateway for connecting to outside networks that are not listed on the G450's routing table

---

## Configuring the Media Gateway Controller (MGC)

The Media Gateway Controller (MGC) controls telephone services on the Avaya G450 Media Gateway. You can use a server with Avaya Communication Manager software as an MGC. The G450 supports both External Call Controllers (ECC) and Internal Call Controllers (ICC). An ICC is an Avaya S8300 Server that you install in the G450 as a media module. An ECC is an external server that communicates with the G450 over the network.

When the G450 uses an ECC, it can use a local S8300 as a backup controller for Enhanced Local Survivability (ELS). The S8300 functions in Local Survivable Processor (LSP) mode. If the ECC stops serving the G450, the S8300 takes over the service.

To register the G450 with an MGC, you need the G450's serial number. You can find this serial number in either of the following ways:

- Use the `show system` command

- Look for a 12-character string located on a label on the back panel of the G450

**Table 15: Servers supported by the Avaya G450 Media Gateway**

Server	Type	Usage
Avaya S8300 Server	Media module	ECC, ICC, or LSP
Avaya S8400 Server	External	ECC
Avaya S8500 Server	External	ECC or LSP
Avaya S8710 Server	External	ECC
Avaya S8720 Server	External	ECC
Avaya S8730 Server	External	ECC

---

## Survivability and migration options

Several options exist to minimize network disruption in the event that connectivity between the G450 and the server or media gateway controller (MGC) is lost.

- **MGC list.** You must register the G450 with at least one, and up to four, MGCs. The first MGC on the list is the primary MGC. If the G450 cannot connect with, or loses its connection with, the primary MGC, it attempts to connect with the other MGCs on the list. See [Configuring the MGC list](#) on page 84.

**Note:**

When Standard Local Survivability (SLS) is enabled, the MGC list includes the SLS module as a fifth entry in the MGC list. For details about SLS, see [Configuring Standard Local Survivability \(SLS\)](#) on page 117.

- **Standard Local Survivability (SLS).** SLS consists of a module built into the G450 to provide partial backup MGC functionality in the event that the connection with the primary MGC is lost. This feature allows a local G450 to provide a degree of MGC functionality when no link is available to an external MGC. It is configured on a system-wide basis using the Provisioning and Installation Manager (PIM) (see [Accessing PIM](#) on page 52). Alternatively, it can be configured on an individual G450 using the CLI. For more information and instructions on configuring SLS, see [Configuring Standard Local Survivability \(SLS\)](#) on page 117.
- **Enhanced Local Survivability (ELS).** ELS is available for the G450 using a local S8300 or S8500 functioning in LSP mode. If the ECC stops serving the G450, the S8300 takes over the service.

## Basic device configuration

- **Auto fallback to primary MGC.** This feature provides a means by which a G450 being serviced by its LSP can return to its primary MGC automatically when the connection is restored between the G450 and the MGC. By migrating the G450 to the MGC automatically, a fragmented network can be made whole faster, without the need for human intervention. Auto fallback is configured via the Avaya Communication Manager. For details, see the *Administrator Guide for Avaya Communication Manager*, 03-300509.

### Note:

Auto fallback does not include survivability. Therefore, there is a short period during registration with the MGC during which calls are dropped and service is not available. This problem can be minimized using the connection preservation feature described below.

- **Connection preservation.** This feature enables the G450 to preserve the bearer paths of stable calls in the event that the G450 migrates to another MGC (including an LSP), including migration back from an LSP to the primary MGC. A call for which the talk path between parties in the call has been established is considered stable. A call consisting of a user listening to announcements or music is not considered stable and is not preserved. Any change of state in the call prevents the call from being preserved. For example, putting a call on hold during MGC migration will cause the call to be dropped. Special features, such as conference and transfer, are not available on preserved calls. Connection preservation preserves all types of bearer connections except BRI. PRI trunk connections are also preserved. Connection preservation is configured via the Avaya Communication Manager. For details, see the *Administrator Guide for Avaya Communication Manager*, 03-300509.
- **Modem dial-backup.** This feature can be used to provide redundant WAN connectivity between a G450 and its primary MGC using a serial modem. This connection uses a virtual interface called the Dialer interface. This feature recognizes that even if the G450 is configured for survivability via SLS or ELS, the best solution is to maintain the gateway's connection with its primary MGC whenever possible. For details on configuring a backup Dialer interface, see [Modem dial backup](#) on page 271.

---

## Configuring the MGC list

The G450 must be registered with an MGC in order to provide telephone service. You can set the G450's MGC, and show the current MGC list used to determine the results.

### Setting the G450's MGC

Use the `set mgc list` command to set the G450's MGC. You can enter the IP addresses of up to four MGCs with the `set mgc list` command. The first MGC on the list is the primary MGC. The G450 searches for the primary MGC first. If it cannot connect to the primary MGC, it searches for the next MGC on the list, and so on.

When SLS is enabled, the MGC list includes the SLS module as a fifth entry on the MGC list. For details about SLS, see [Configuring Standard Local Survivability \(SLS\)](#) on page 117.

### Note:

If the MGC is an S8700-series server, the first server on the list will normally be the primary C-LAN board connected to the server. If the MGC is an S8400 or S8500, the first server on the list will be either the primary C-LAN board connected to the server, or an Ethernet port on the server that has been enabled for processor Ethernet connections. If the MGC is an S8300, the first server on the list will be the IP address of the S8300. The remaining servers will be either alternate C-LAN boards connected to the S8400, S8500, or S8700-series servers, or an S8300 configured as an LSP, or the port enabled as the Ethernet processor port on an S8500 configured as an LSP.

In the following example of the `set mgc list` command, if the MGC with the IP address 132.236.73.2 is available, that MGC becomes the G450's MGC. If that server is not available, the G450 searches for the next MGC on the list, and so on.

```
g450-001(super)# set mgc list 132.236.73.2, 132.236.73.3,  
132.236.73.4, 132.236.73.5  
Done!
```

## Determining results

To determine the result of the `set mgc list` command, use the `show mgc` command. This command has the following output:

- **Registered.** Indicates whether or not the G450 is registered with an MGC (YES or NO)
- **Active Controller.** Displays the IP address of the active MGC. If there is no active MGC (that is, if the `set mgc list` command failed to configure an MGC), this field displays 255.255.255.255.
- **H248 Link Status.** Indicates whether the communication link between the G450 and the MGC is up or down
- **H248 Link Error Code.** If there is a communication failure between the G450 and the MGC, this field displays the error code

## Showing the current MGC list

To show the current MGC list, use the `show mgc list` command. This command shows the IP addresses of the MGCs on the MGC list. It also shows whether or not SLS is enabled.

## Removing one or more MGCs

To remove one or more MGCs from the MGC list, use the **clear mgc list** command. Type the IP address of the MGC you want to remove as an argument to remove that MGC. You can remove more than one MGC with one command by typing the IP addresses of all the MGCs you want to remove, separated by commas. To remove all the MGCs on the list, enter **clear mgc list** with no arguments.

## Changing the MGC list

1. Enter **clear mgc list** with no arguments to clear the MGC list.
2. Enter **set mgc list** with a different set of IP addresses.

**Note:**

If you use the **set mgc list** command without first clearing the MGC list, the G450 simply adds the new MGCs to the end of the MGC list.

---

## Setting reset times

If the connection between the G450 and its registered MGC is lost, the G450 attempts to recover the connection. Use the **set reset-times primary-search** command and the **set reset-times total-search** command to set the timeout for the G450's search for the primary MGC and the other MGCs on its MGC list, respectively. Use the **set reset-times transition-point** command to configure the point at which the primary MGCs in the list end and the LSPs begin. For example, if there are three IP addresses in the MGC list and the third address is the LSP, the transition point should be 2.

The default time for the primary search is one minute. The default time for the total search is 30 minutes. The default transition point is 1.

For example:

```
G450-001(super)# set reset-times primary-search 20
Done!
G450-001(super)# set reset-times total-search 40
Done!
G450-001(super)# set reset-times transition-point 1
Done!
```

In this example, in the event of a connection loss with the registered MGC, the G450 searches for the primary MGC on its MGC list for 20 minutes. If the G450 does not establish a connection with the primary MGC within this time, it searches for the other MGCs on the list for a total of 40 minutes.

Use the **show recovery** command to display the reset times.

---

## Accessing the registered MGC

Access the MGC according to the following:

- If the MGC is an S8300 Server, enter **session mgc**
- If the MGC is an S8400, S8500, or S8700-series server, use the **set mediaserver** command to manually define the MGC's IP address, and then enter **session mgc** to access the MGC

If the G450 includes a local S8300, enter **session icc** to access the S8300. You can use this command whether or not the local S8300 is the G450's registered MGC.

**Note:**

Both the **session mgc** command and the **session icc** command open a telnet connection to the MGC.

To open a connection directly to the Avaya Communication Manager System Access Terminal (SAT) application in the MGC, add **sat** to the command. For example:

```
G450-001(super)# session mgc sat
```

To open a connection to the MGC's LINUX operating system, do not add **sat** to the command. For example:

```
G450-001(super)# session mgc
```

---

## Monitoring the ICC or LSP

When a local MGC controls telephone services on the Avaya G450 Media Gateway in ICC or LSP mode, the G450 monitors the connection with the MGC. If the connection with the MGC is lost, the G450 starts a recovery process.

- Use the **set icc-monitoring** command to control heartbeat monitoring of an ICC or LSP. The **enable** parameter enables heartbeat monitoring. The **disable** parameter disables heartbeat monitoring.
- Use the **show icc-monitoring** command to display the status of the ICC/LSP monitoring process.

---

## Summary of MGC list configuration commands

For more information about these commands, see *Avaya G450 CLI Reference*, 03-300437.

**Table 16: MGC list configuration commands**

Command	Description
<code>clear mgc list</code>	Remove one or more MGCs from the MGC list
<code>session</code>	Open a telnet connection to the MGC
<code>set icc-monitoring</code>	Enable or disable heartbeat monitoring of an MGC in ICC or LSP mode
<code>set mediaserver</code>	Set the MGC management address and ports
<code>set mgc list</code>	Create a list of valid Media Gateway Controller(s)
<code>set reset-times</code>	Set the timeout for the G450's search for the primary MGC, or search for the other MGC's on the MGC list, or configure the point at which the primary MGCs in the list end and the LSPs begin
<code>show icc-monitoring</code>	Display the status of the ICC/LSP monitoring process
<code>show mediaserver</code>	Display MGC configuration information
<code>show mgc</code>	Display the state and setup parameters of the currently active MGC
<code>show mgc list</code>	Display the IP addresses of the MGCs on the MGC list
<code>show recovery</code>	Show the media gateway connection recovery setup

---

## DNS resolver

A DNS resolver resolves hostnames to IP addresses by querying DNS servers according to an ordered list. The list of DNS servers is compiled using either DNS servers entered manually by the user, or DNS servers gathered automatically by means of DHCP or PPP protocols, or both.

The user can also optionally aid the DNS resolver by specifying a list of domain names that the DNS resolver adds as a suffix to non-Fully Qualified Domain Name (FQDN) names, to help resolve them to an IP address.



The DNS resolver feature is intended to provide a backup mechanism for VPN hubs using DNS. For more information about VPNs on the G450, see [Configuring IPsec VPN on page 505](#).

---

## DNS resolver features

The G450 supports the following DNS resolver features:

- Fully compliant with RFC1034, RFC1035, and RFC1123
- Maintains a global DNS database for all interfaces. The database is compiled using:
  - Static (user-defined) DNS servers
  - Automatically-learned DNS servers. DNS servers can be automatically learned by the FastEthernet 10/2 interface when it is configured as a DHCP client or configured for PPP. For more information on DHCP Client, see [Configuring DHCP client](#) on page 199.

### Note:

The following PPP interfaces can be configured to automatically learn the DNS servers in the system:

- FastEthernet with PPPoE
- Dialer interface
- Serial interface

The most common application of this configuration is for connecting the G450 to the Internet and getting the DNS server information from the ISP. Therefore, interfaces configured to automatically learn the DNS servers in the system are usually the FastEthernet with PPPoE interface and the Dialer interface.

---

## Typical DNS resolver application – VPN failover

In this typical application, the DNS resolver feature is used to provide a VPN failover mechanism between two main offices. The failover mechanism is implemented as follows.

The VPN branch office(s) connect to two main offices (the VPN remote peers) that are configured **with the same FQDN name**, but have different IP addresses. When a branch office makes a DNS query to resolve the VPN remote peer name to an IP address, it receives a list with the IP addresses of both main offices, selects the first one, and builds a VPN tunnel with it. If the first main office fails, the branch office sends another DNS query, and receives the IP address of the second main office in reply. It will then start a VPN tunnel with the second main office.

This typical application is described in full in [Failover using DNS](#) on page 567.

Figure 8: VPN DNS topology

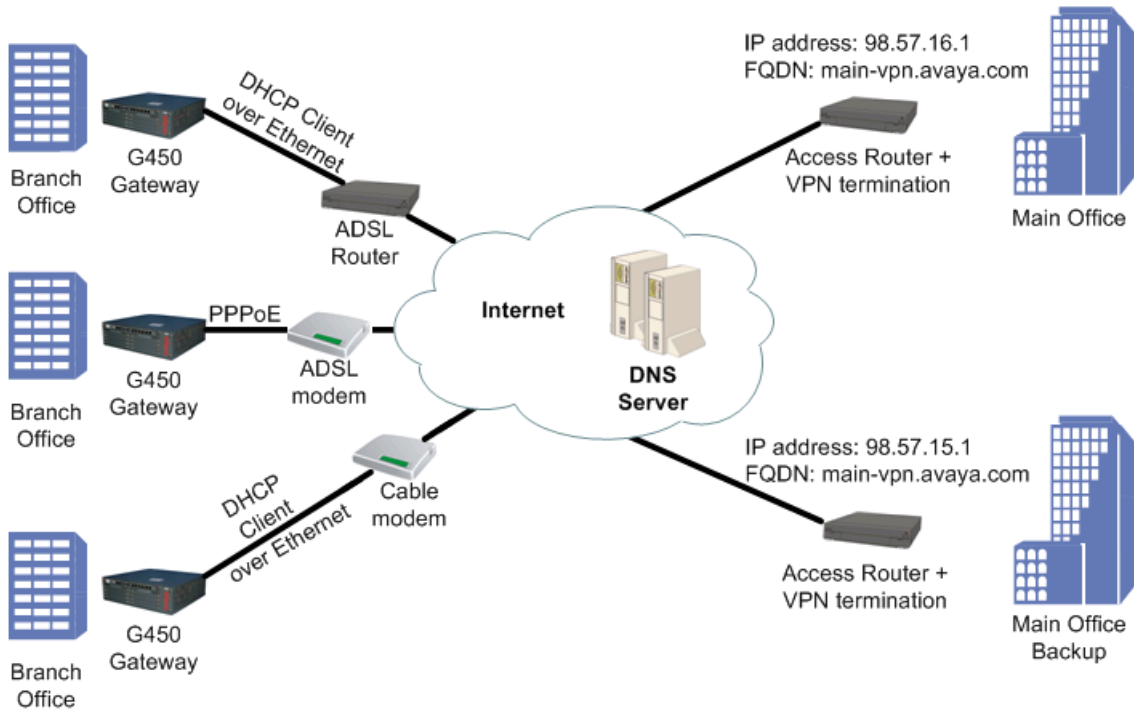

## Configuring DNS resolver

1. Enter **ip domain name-server-list 1** to create the DNS servers list.

```
G450-001(config)# ip domain name-server-list 1
G450-001(config-name-server-list:1)#
```

2. Use the **description** command to specify a description for the list.

```
G450-001(config-name-server-list:1)# description "All DNS servers"
Done!
G450-001(config-name-server-list:1)#
```

3. Add a DNS server to the DNS servers list using the **name-server** command. Configure the following:
  - Assign an index number that ranks the DNS server by priority
  - Specify the IP address of the DNS server

- Repeat Step 3 to configure additional DNS servers in the list. You can configure up to six DNS servers.

```
G450-001(config-name-server-list:1)# name-server 1 1.1.1.1
Done!
G450-001(config-name-server-list:1)# name-server 2 192.100.106.101
Done!
```

- Use the **ip domain list** command to configure a domain name. This domain name will be used as a suffix to complete non-FQDN names (hostnames that do not end with a dot). Configure the following:
  - Assign an index number that ranks the domain name by priority
  - Specify the domain name
- Repeat Step 5 to configure additional domain names. You can configure up to six domain names.

```
G450-001(config)# ip domain list 1 avaya.com
Done!
G450-001(config)# ip domain list 2 emea.avaya.com
Done!
```

- Optionally, configure the number of DNS query retries, using the **ip domain retry** command. The default value is 2.

```
G450-001(config)# ip domain retry 4
Done!
```

- Optionally, configure the timeout for a DNS query using the **ip domain timeout** command. The default value is 3 seconds.

```
G450-001(config)# ip domain timeout 4
Done!
```

- The DNS resolver is enabled by default. If it was disabled and you wish to re-enable it, enter **ip domain lookup**.

```
G450-001(config)# ip domain lookup
Done!
```

### Important:

If either DHCP Client or PPP are configured in the G450, you do not need to configure DNS resolver because the DNS resolver is enabled by default. In addition, the DHCP Client and PPP discover DNS servers automatically, so the list of DNS servers will include the automatically-learned DNS servers.

Instead:

- For DHCP Client, enable DHCP Client by entering **ip address dhcp**. For information about DHCP Client see [Configuring DHCP client](#) on page 199.
- For PPP, enable automatic discovery of DNS servers by entering **ppp ipcp dns request**.

---

**Figure 9: DNS resolver configuration workflow**

```
ip domain name-server-list
description
name-server 1
.
.
name-server 6

ip domain list 1
.
.
ip domain list 6

ip domain retry

ip domain timeout

show ip domain

ip domain lookup
```

---

## DNS resolver configuration example

The following example defines three DNS servers for the list of DNS servers, three domain names to add as suffixes to hostnames, a DNS query retry value, and a DNS query timeout value. The final command in the example enables the DNS resolver.

```
G450-001(config)# ip domain name-server-list 1
G450-001(config-name-server-list:1)# description "All DNS servers"
Done!
G450-001(config-name-server-list:1)# name-server 1 1.1.1.1
Done!
G450-001(config-name-server-list:1)# name-server 2 2.2.2.2
Done!
G450-001(config-name-server-list:1)# name-server 3 3.3.3.3
Done!
G450-001(config-name-server-list:1)# exit
G450-001(config)# ip domain list 1 support.avaya.com
Done!
G450-001(config)# ip domain list 2 global.avaya.com
Done!
G450-001(config)# ip domain list 3 avaya.com
Done!
G450-001(config)# ip domain retry 4
Done!
G450-001(config)# ip domain timeout 5
Done!
G450-001(config)# ip domain lookup
Done!
```

---

## Using DNS resolver to resolve a hostname

Use the **nslookup** command, followed by a hostname, to resolve the hostname to an IP address.

---

## Maintaining DNS resolver

There are various commands you can use to display DNS resolver information, clear DNS resolver counters, and display DNS resolver log messages.

### Showing DNS resolver information

You can use the following commands to display information about DNS resolver:

- Enter **show ip domain** to display the DNS resolver's configuration. The output shows the DNS servers that were statically configured and those which were gathered using DHCP or PPP protocols, as well as the list of domain suffixes.

## Basic device configuration

- Enter `show ip domain statistics` to display the DNS resolver's statistics counters
- Use the `show protocol` command to display the status of the DNS-client protocol

## Clearing DNS resolver counters

Enter `clear ip domain statistics` to clear the DNS resolver's statistics counters.

## Viewing DNS resolver logging

1. Enter `set logging session enable` to enable session logging to the terminal.

```
G450-001# set logging session enable
Done!
CLI-Notification: write: set logging session enable
```

2. Enter `set logging session condition DNSC` to view all DNS resolver messages of level Info and above.

```
G450-001# set logging session condition DNSC Info
Done!
CLI-Notification: write: set logging session condition DNSC Info
```

### Note:

You can also enable logging messages to a log file or a Syslog server. For a full description of logging on the G450, see [Configuring logging on page 209](#).

---

## Summary of DNS resolver configuration commands

For more information about these commands, see *Avaya G450 CLI Reference*, 03-300437.

Table 17: DNS resolver configuration commands

Root level command	Command	Description
	<code>clear ip domain statistics</code>	Clear the DNS resolver's statistics counters
	<code>interface {dialer serial console FastEthernet USB-modem}</code>	Enter the interface configuration mode for a Dialer, Serial, Console, FastEthernet, or USB-modem interface

1 of 2

Table 17: DNS resolver configuration commands (continued)

Root level command	Command	Description
	<code>ppp ipcp dns request</code>	Enable or disable requesting DNS information from the remote peer during the PPP/IPCP session
<code>ip domain list</code>		Specify static domain names (suffixes) to complete non-FQDN names (hostnames that do not end with a dot)
<code>ip domain lookup</code>		Enable or disable the DNS resolver
<code>ip domain name-server-list</code>		Enter the context of the DNS servers list, or set up the list
	<code>description</code>	Set a name for the DNS servers list
	<code>name-server</code>	Add a DNS server to the list of up DNS servers
<code>ip domain retry</code>		Set the number of retries for a DNS query
<code>ip domain timeout</code>		Set the timeout for a DNS query
<code>nslookup</code>		Resolve a hostname to an IP address
<code>show ip domain</code>		Display the DNS resolver's configuration
<code>show ip domain statistics</code>		Display the DNS resolver's statistics counters
<code>show protocol</code>		Display the status of a specific management protocol, or all protocols

2 of 2

## Viewing the status of the device

To view the status of the Avaya G450 Media Gateway, use the following commands: For more information about these commands, see *Avaya G450 CLI Reference*, 03-300437.

- Enter `show faults` to view information about currently active faults.
- Use the `show image version` command to display the software version of the image on both memory banks of the device.
- Enter `show mgc` to view information about the Media Gateway Controller with which the G450 is registered. For more information, see [Configuring the Media Gateway Controller \(MGC\)](#) on page 82.

## Basic device configuration

- Use the **show mm** command to view information about media modules that are installed on the G450. To view information about a specific media module, include the slot number of the media module as an argument. For example, to view information about the media module in slot 2, enter **show mm v2**. The output of the command shows the following information:
  - Slot number
  - Uptime
  - Type of media module
  - Description
  - Serial number and other hardware identification numbers
  - Firmware version
  - Number of ports
  - Fault messages
- Use the **show module** command or enter **show mg list\_config** to view brief information about media modules that are installed in the G450. To view brief information about a specific media module, include the slot number of the media module as an argument. For example, to view information about the media module in slot 2, enter **show module v2**. The output of the command shows the following information:
  - Slot number
  - Firmware version
  - Type of media module
  - Media module code
- Enter **show system** to display the serial number of the G450, the G450's uptime, the firmware version number, MAC addresses, and other system information.
- Enter **show restart-log** to view information about the last time the G450 was reset.
- Enter **show temp** to view the temperature of the G450 CPU. This command also displays the high and low temperatures that will trigger a temperature warning.
- Use the **show timeout** command to display the amount of time in minutes the terminal remains idle before timing out.
- Enter **show voltages** to view the power supply voltages of the G450.
- Use the **show utilization** command to display information about CPU and memory usage on the G450.

### Note:

Before using this command, you must first use the **set utilization cpu** command to enable CPU utilization measurements.

- Enter **test led** to test the system ALM, MDM and CPU LEDs on the front panel of the G450. The CPU and media module LEDs blink for five seconds.



---

## Summary of device status commands

For more information about these commands, see *Avaya G450 CLI Reference*, 03-300437.

**Table 18: Device status commands**

Command	Description
<b>set utilization cpu</b>	Enable CPU utilization measurements
<b>show faults</b>	Display information about currently active faults
<b>show image version</b>	Display the software version of the image on both memory banks of the device
<b>show mg list_config</b>	Display the current hardware and firmware configurations for the installed media gateway equipment
<b>show mgc</b>	Display information about the Media Gateway Controller with which the G450 is registered
<b>show mm</b>	Display information about media modules that are installed on the G450
<b>show module</b>	Display brief information about the media modules installed in the G450
<b>show restart-log</b>	Display information about the last time the G450 was reset
<b>show system</b>	Display information about the G450
<b>show temp</b>	Display the device temperature
<b>show timeout</b>	Display the amount of time in minutes the terminal remains idle before timing out
<b>show utilization</b>	Display information about CPU and memory usage on the G450
<b>show voltages</b>	Display power supply voltages
<b>test led</b>	Test the system ALM, MDM and CPU LEDs on the front panel of the G450

## Software and firmware management

You can manage G450 software and firmware, either:

- Remotely, using an FTP, TFTP, or SCP server

Or

- Locally, using a USB mass storage device connected to the G450 USB port

---

## File transfer

The Avaya G450 Media Gateway can be a client for the FTP and TFTP protocols. Use either a USB device or the FTP or TFTP protocols to transfer files between the Avaya G450 Media Gateway and other devices. You can use file transfer to:

- Install software and firmware upgrades on the G450
- Install firmware upgrades on media modules
- Back up and restore configuration settings

To use FTP/TFTP file transfer, you need to have an FTP server or TFTP server on your network.

**Note:**

If you use an FTP server, the G450 prompts you for a username and password when you enter a command to transfer a file. Also, when opening an FTP connection to the S8300, all anonymous FTP file transfers are restricted to the `/pub` directory. Permission for anonymous FTP users to create files in other directories is denied.

---

## Software and firmware upgrades

You can upgrade software on the Avaya G450 Media Gateway. Software used to control the Avaya G450 Media Gateway itself and media modules installed on the G450 is called firmware. Use a USB device or the FTP or TFTP protocol to download a new version of software or firmware. You can upgrade the following types of software and firmware:

- Firmware for the Avaya G450 Media Gateway
- Java applet for Avaya G450 Manager
- Firmware for media modules

**Note:**

You can also use the G450 to upgrade the firmware and configuration files for IP phones. For details, see *Installing and Upgrading the Avaya G450 Media Gateway*, 03-602054.

## Managing the firmware banks

The G450 has two firmware banks:

- Bank A
- Bank B

Each firmware bank contains a version of the G450 firmware. These may be different versions. The purpose of this feature is to provide software redundancy. If one of the versions becomes corrupted, you can reset the G450 using the other version. This is particularly important when downloading new versions.

### Displaying firmware versions in the banks

Use the **show image version** command to display the firmware version of the image on both memory banks of the device.

### Changing the default bank

By default, when you turn on or reset the G450, the G450 loads firmware from Bank B. To change the default bank from which firmware is loaded during startup, use the **set boot bank** command. For example, to configure the G450 to load firmware from Bank A on startup, enter **set boot bank bank-A**. Now, when you reset the G450, it will load firmware from Bank A.

To display the bank from which the G450 is currently set to load its firmware upon startup or reset, use the **show boot bank** command.

### Loading firmware from the non-default bank

You can use the **ASB** button on the G450 front panel to load firmware from a bank other than the default bank during startup:

1. Press and hold the **reset** button.
2. Press and hold the **ASB** button.
3. Release the **reset** button.
4. Release the **ASB** button.

For example, if the G450 is configured to load firmware from Bank B, use the steps listed above to reset the G450 to load the firmware from Bank A instead.

## Upgrading software and firmware using FTP/TFTP

To upgrade software or firmware, you must obtain an upgrade file from Avaya. Place the file on your FTP or TFTP server. Then, use one of the following commands to upload the file to the G450. For each of these commands, include the full path of the file and the IP address of the FTP or TFTP host as parameters. When you enter the command, the CLI prompts you for a username and password.

**Note:**

In addition to using the CLI to upgrade software and firmware, you can use the Avaya IW and the GIW. See [Accessing Avaya IW](#) on page 48 and [Accessing GIW](#) on page 51.

- Use the **copy ftp module** command, followed by the module number of the module you want to upgrade, to upgrade the firmware on a media module from an FTP server.
- Use the **copy ftp SW\_imageA** command to upgrade the G450 firmware into Bank A from an FTP server.
- Use the **copy ftp SW\_imageB** command to upgrade the G450 firmware into Bank B from an FTP server.
- Use the **copy ftp EW\_archive** command to upgrade the Java applet for Avaya G450 Manager software from an FTP server.
- Use the **copy tftp module** command, followed by the module number of the module you want to upgrade, to upgrade the firmware on a media module from a TFTP server.
- Use the **copy tftp SW\_imageA** command to upgrade the G450 firmware into Bank A from a TFTP server.
- Use the **copy tftp SW\_imageB** command to upgrade the G450 firmware into Bank B from a TFTP server.
- Use the **copy tftp EW\_archive** command to upgrade the Java applet for Avaya G450 Manager software from a TFTP server.

When using FTP or TFTP commands, you must use the specific path of the file on the FTP or TFTP server according to the home directory of the service (FTP or TFTP) that you are using. For example, to upgrade the firmware of an MM710 media module in slot 2 from a TFTP server with the IP address 192.1.1.10, where the home directory is `c:\home\ftp\` and the upgrade file is located in the directory `c:\home\ftp\version`, use the following command:

```
copy tftp module \version\mm710v3.fdl 192.1.1.10 2
```

**Note:**

When downloading firmware from the S8300, use only the file name, without the directory path, in the command line. Otherwise, the procedure will fail. For instance, in the example above, you must use the following command:

```
copy tftp module mm710v3.fdl 192.1.1.10 2
```

When downloading firmware from the S8300 using TFTP, you may need to enable the TFTP service in the Set LAN Security parameters of your web server.

The following example downloads a firmware version with the path and file name C:\g450.net from an FTP server with the IP address 149.49.134.153 to Bank A of the G450:

```
copy ftp SW_imageA C:\g450.net 149.49.134.153
```

## Upgrading software and firmware using a USB mass storage device

You can upgrade software and firmware using a USB mass storage device.

1. Obtain an upgrade file from Avaya and place it on your PC.
2. Insert the USB mass storage device into the PC's USB port, and copy the software or firmware file(s) to the USB mass storage device.
3. Remove the USB storage device from the PC, and insert it in the G450 USB port.
4. Copy the software or firmware file(s) to the G450 using one of the following commands:
  - Use the **copy usb SW\_imageA** command to upgrade the G450 firmware into Bank A from the USB mass storage device.
  - Use the **copy usb SW\_imageB** command to upgrade the G450 firmware into Bank B from the USB mass storage device.
  - Use the **copy usb EW\_archive** command to upgrade the Java applet for Avaya G450 Manager software from the USB mass storage device.
  - Use the **copy usb module** command, followed by the slot number of the module you want to upgrade, to upgrade the firmware on a media module from the USB mass storage device.
  - Use the **copy usb phone-imageA** (or **imageB**, or **imageC**, or **imageD**) to upgrade IP phone firmware from the USB mass storage device.
  - Use the **copy usb phone-scriptA** (or **phone-scriptB**) to upgrade IP phone scripts from the USB mass storage device.
  - Use the **copy usb announcement-file** to upgrade announcements files from the USB mass storage device.
  - Use the **copy usb auth-file** to upgrade the authentication file from the USB mass storage device.

## Basic device configuration

- Use the **copy usb license-file** to upgrade the VPN license file from the USB mass storage device.
  - Use the **copy usb startup-config** to upgrade the startup configuration file from the USB mass storage device.
5. Use the **show download software status** command to display the status of the firmware download process.

## Upgrading firmware using the USB mass storage device "restore" command

The primary use of the **restore usb** command is to restore the entire gateway. If you use the command to upgrade firmware, take care to follow instructions carefully.

1. Back up the gateway by entering **backup config usb usbdevice0 backup-name**, where **backup-name** is the backup directory path and file name you are creating on the USB mass storage device.

A backup directory is created on the USB mass storage device, with a directory structure as detailed in [Table 20](#).

2. Obtain the firmware upgrade file(s) from Avaya and place them on your PC.
3. Insert the USB mass storage device into the PC's USB port, and copy the firmware file(s) to the USB mass storage device as follows:
  - a. Copy G450 firmware files to the root directory.
  - b. Copy the G450 Device Manager firmware file to the root directory.
  - c. Copy media modules' firmware files to the **MM** subdirectory.
  - d. Copy IP phone firmware files to the **IPPHONE** subdirectory.
4. Remove the USB mass storage device from the PC, and insert it in the G450 USB port.
5. Enter **restore usb usbdevice0 backup-name**, where **backup-name** is the root directory path and name on the USB mass storage device.
6. Enter **show restore status** to check the status of the restore operation. The report lists the upgraded files.

## Uploading software and firmware from the gateway

### Copying files to a USB mass storage device

You can use a USB mass storage device inserted into the G450 USB port to copy individual files to a USB mass storage device.

Use the **copy file usb** command to upload a specific file from the gateway to the USB mass storage device, where **file** can be any of the following:

- **announcement-file**. Announcements files
- **auth-file**. Authentication file

- `phone-scriptA`. Phone script bank A in the gateway's TFTP directory
- `phone-scriptB`. Phone script bank B in the gateway's TFTP directory
- `license-file`. The VPN license file
- `startup-config`. The startup configuration file
- `capture-file`. The packet sniffing buffer
- `dhcp-binding`. The DHCP binding file
- `syslog-file`. The syslog file
- `cdr-file`. A Call Detail Recording (CDR) file

### Copying files to an FTP/SCP/TFTP server

- Use the **`copy file ftp`** command to upload a specific file from the gateway to an FTP server, where **`file`** can be any of the following:
  - `announcement-file`. Announcements files
  - `auth-file`. Authentication file
  - `capture-file`. The packet sniffing buffer
  - `cdr-file`. A Call Detail Recording (CDR) file
  - `dhcp-binding`. The DHCP binding file
- Use the **`copy file scp`** command to upload a specific file from the gateway to an SCP server, where **`file`** can be any of the following:
  - `announcement-file`. Announcements files
  - `auth-file`. Authentication file
  - `capture-file`. The packet sniffing buffer
  - `capture-file`. The packet sniffing buffer
  - `cdr-file`. A Call Detail Recording (CDR) file
  - `dhcp-binding`. The DHCP binding file
- Use the **`copy file tftp`** command to upload a specific file from the gateway to a TFTP server, where **`file`** can be any of the following:
  - `announcement-file`. Announcements files
  - `capture-file`. The packet sniffing buffer
  - `auth-file`. Authentication file
  - `capture-file`. The packet sniffing buffer
  - `cdr-file`. A Call Detail Recording (CDR) file
  - `dhcp-binding`. The DHCP binding file

## Summary of software and firmware management commands

For more information about these commands, see *Avaya G450 CLI Reference*, 03-300437.

**Table 19: Software and firmware management CLI commands**

Command	Description
<code>copy file ftp</code>	Upload a specific file from the gateway to an FTP server
<code>copy file scp</code>	Upload a specific file from the gateway to an SCP server
<code>copy file tftp</code>	Upload a specific file from the gateway to a TFTP server
<code>copy file usb</code>	Upload a specific file from the gateway to the USB mass storage device
<code>copy ftp EW_archive</code>	Upgrade the Java applet for Avaya G450 Manager software from an FTP server
<code>copy ftp module</code>	Upgrade the firmware on a media module from an FTP server
<code>copy ftp SW_imageA</code>	Upgrade the G450 firmware into Bank A from an FTP server
<code>copy ftp SW_imageB</code>	Upgrade the G450 firmware into Bank B from an FTP server
<code>copy tftp EW_archive</code>	Upgrade the Java applet for Avaya G450 Manager software from a TFTP server
<code>copy tftp module</code>	Upgrade the firmware on a media module from a TFTP server
<code>copy tftp SW_imageA</code>	Upgrade the G450 firmware into Bank A from a TFTP server
<code>copy tftp SW_imageB</code>	Upgrade the G450 firmware into Bank B from a TFTP server
<code>copy usb announcement-file</code>	Upgrade announcements files from the USB mass storage device
<code>copy usb auth-file</code>	Upgrade the authorization file from the USB mass storage device
<code>copy usb EW_archive</code>	Upgrade the Java applet for Avaya G450 Manager software from the USB mass storage device
<code>copy usb license-file</code>	Upgrade the VPN license file from the USB mass storage device
<code>copy usb module</code>	Upgrade the firmware on a media module from the USB mass storage device
<code>copy usb phone-image</code>	Upgrade phone images from the USB mass storage device
<code>copy usb phone-script</code>	Upgrade phone scripts from the USB mass storage device

1 of 2



Table 19: Software and firmware management CLI commands (continued)

Command	Description
<code>copy usb startup-config</code>	Upgrade the startup configuration file from the USB mass storage device
<code>copy usb SW_image</code>	Upgrade the G450 firmware into Bank A or into Bank B, from the USB mass storage device
<code>dir</code>	List all files in the USB mass storage device connected to the G450
<code>set boot bank</code>	Set the default bank from which firmware is loaded during startup
<code>show boot bank</code>	Display the bank from which the G450 is currently set to load its firmware upon startup or reset
<code>show download software status</code>	Display the status of the firmware download process
<code>show image version</code>	Display the firmware version of the image on both memory banks of the device

2 of 2

## Backing up and restoring the G450 using a USB mass storage device

The G450 USB ports support a USB flash drive and a USB externally powered hub. The ports also support USB 2.0 high speed (480 Mbits/sec) for faster file transfer between the media gateway and USB mass storage devices.

### Note:

An external USB hub is supported on G450 gateways with hardware suffix.vintage C . 1 or above.

To check the hardware suffix and vintage, enter `show system` and check the HW suffix and HW vintage values.

CLI commands for backing up and restoring files to or from a USB mass storage device enable you to use a USB port for efficient restoration or replication of a G450 media gateway and for replacing and upgrading media modules. Using the USB port you can back up or restore multiple files with one CLI command, which is simpler than the alternative TFTP/FTP/SCP method, in which files are copied and restored individually.

## Basic device configuration

A single CLI command backs up all the administration and configuration files of a gateway onto a USB mass storage device. Another single command restores all of the backed up files. If you need to completely replicate a media gateway, you can also download the G450 firmware, media modules' firmware, IP phone firmware, and Device Manager firmware to the USB mass storage device, and use the **restore usb** command to restore these files as well as the administration and configuration files.

### Note:

The CLI **backup config usb** and **restore usb** commands (for efficient backup/restore via a USB mass storage device) only run on gateways R4.0 and higher.

You can also use the USB mass storage device to copy individual gateway files to or from the gateway. Refer to [Upgrading software and firmware using a USB mass storage device](#) on page 101 and [Uploading software and firmware from the gateway](#) on page 102.

### Tip:

It is recommended to use a USB mass storage device with LED indication.

## Backing up administration and configuration files using a USB mass storage device

The following procedure backs up all the gateway configuration and administration files, but does not back up any firmware files.

Back up the gateway regularly to a USB mass storage device. This backup can be very helpful in restoring the gateway's configuration if it becomes faulty, or in restoring the entire gateway.

1. Connect a USB mass storage device to a G450 USB port.
2. Type **s** to commit the current configuration to NVRAM.
3. Enter **backup config usb usbdevice0 backup-name**, where **backup-name** is the backup directory path and file name you are creating on the USB mass storage device.

**Note:**

Before unplugging the USB mass storage device, use the **safe-removal usb** command to safely remove the USB mass storage device.

A backup directory is created on the USB mass storage device, with the following sample structure and file types:

**Table 20: Backup file and directory structure on a USB mass storage device**

Root directory	Sub-directory	Files	Comments
backup-25-Nov-2005			Backup directory name
		readme.txt	File with backup information
		startup_config.cfg	Configuration file
		audio.bin	Customer-specific VoIP parameters
		vpn_license.cfg	VPN license file
		auth-file.cfg	Authentication file
	IPPHONE		IP phone scripts and images directory
		46xxupgrade.scr	
		46xxsettings.txt	
	MM		Media modules file directory
	GWANNC		Gateway announcements and music-on-hold file
		GeorgeAnnouncement.wav	
		GeorgiaAnnouncement.wav	

**Note:**

It is recommended to use at least a 128MB USB mass storage device since it can hold two full backup directories with all images and configuration files. You can create multiple backup directories as long as there is space in the USB mass storage device.

## Basic device configuration

### Note:

You can use the **show backup status** command to display information regarding the status of a backup of the gateway configuration to a USB mass storage device.

## Restoring backed up configuration and administration files to a gateway using a USB mass storage device

1. Make sure you have a backup of the G450 on a USB mass storage device. Refer to [Backing up administration and configuration files using a USB mass storage device](#) on page 106.
2. Connect the USB mass storage device to a G450 USB port.
3. Enter **restore usb usbdevice0 backup-name**, where **backup-name** is the backup directory path and file name on the USB mass storage device.

### Note:

Before unplugging the USB mass storage device, use the **safe-removal usb** command to safely remove the USB mass storage device.

## Replicating a G450 using a USB mass storage device

The following procedure is useful for replicating a G450 that has become faulty. Since the **backup** command backs up all the gateway configuration files, but does not back up any firmware files, the main task is to add the various firmware files before running **restore**.

### Important:

When adding files to a backup directory on a USB mass storage device, follow the file and directory naming convention, detailed in [Table 21](#), to enable a successful restore.

1. Make sure you have a backup of the faulty G450 on a USB mass storage device. Refer to [Backing up administration and configuration files using a USB mass storage device](#) on page 106.
2. Transfer the media modules, including the S8300 if installed, from the faulty G450 into the corresponding slots of the new G450.
3. Connect the new G450 to a power source.
4. In the new G450, enter **show image version** to find out which of the two image banks holds the older gateway firmware version, and what version it is.
5. If the new G450 firmware version is below 26.x.y, you must replace it with firmware version 26.x.y or higher, in order to enable the **restore** option. To do so:
  - a. Download the G450 firmware from the Avaya support website (<http://www.avaya.com/support>) to an FTP/TFTP server.

- b. Download the G450 firmware from the FTP/TFTP server to the new G450. Assuming that Bank A holds the older firmware version, enter **copy ftp sw\_imageA filename ip**, where **filename** is the full path and file name of the firmware file, and **ip** is the IP address of the FTP server. Alternatively, enter **copy tftp sw\_imageA filename ip** if you are downloading from a TFTP server.
6. If the new G450 firmware version is 26.x.y or above, add a G450 firmware to the USB mass storage device, as follows:
  - a. From the Avaya support website, download to your PC the same version of G450 firmware as was running in the faulty G450.
  - b. Insert the USB mass storage device into the PC's USB port.
  - c. Copy the G450 firmware file to the root backup directory in the USB mass storage device.
7. Add the firmware files of the media modules to the USB mass storage device, as follows:
  - a. From the Avaya support website, download to your PC the firmware files of the media modules installed in the gateway. For each media module, download all firmware corresponding to the various hardware vintage/suffix versions available for that module. If you are not sure which media modules you have, you can download the firmware files of all media modules. The restore operation uses only the files needed.
  - b. Insert the USB mass storage device into the PC's USB port.
  - c. Copy the firmware files from the PC to the **MM** subdirectory in the USB mass storage device. Do not change the firmware file names.
8. You can optionally add the firmware files of the IP phones to the USB mass storage device, as follows:
  - a. From the Avaya support website, download to your PC the firmware files (booter and application) of up to two supported IP phones, as well as the **46xxupgrade.txt** or **46xxupgrade.scr** file.
  - b. Insert the USB mass storage device into the PC's USB port.
  - c. Copy the IP phone files from the PC to the USB mass storage device. Place them in the **IPPHONE** subdirectory under the root backup directory. Do not change the names of the downloaded files.

**Note:**

You will need to reset the IP phones after the restore operation on the gateway.

9. You can optionally restore or add the G450 Device Manager, as follows:
  - a. From the Avaya support website, download to your PC the firmware file of the Device Manager.
  - b. Insert the USB mass storage device into the PC's USB port.
  - c. Copy the Device Manager firmware file from the PC to the USB mass storage device. Place it in the root backup directory. Do not change the name of the firmware file.

## Basic device configuration

- View the backup directory on the USB mass storage device. The file types and directory structure should match the following convention:

**Table 21: Backup file and directory naming convention on a USB mass storage device**

Root directory	Sub-directory	Files	Comments
backup-25-Nov-2005			Backup directory name
		readme.txt	File with backup info
		startup_config.cfg	Configuration file
		audio.bin	Customer-specific VoIP parameters
		vpn_license.cfg	VPN license file
		auth-file.cfg	Authentication file
		g450_sw_24_21_1.bin	Gateway image
		g450_emweb_3_0_5.bin	Embedded web image
	IPPHONE		IP phone scripts and images directory
		46xxupgrade.scr	
		46xxsettings.txt	
		4601dape1_82.bin	
		4601dbte1_82.bin	
	MM		Media modules file directory
		mm722v2.fdl	
		mm714v67.fdl	
		mm711h20v67.fdl	
		mmanalogv67.fdl	
	GWANNC		Gateway announcements and music-on-hold file directory
		DanAnnouncement.wav	
		DanaAnnouncement.wav	

11. Delete the `vpn_license.cfg` file from the root backup directory. Since you are restoring the files from one gateway to another, and the VPN license is granted per gateway serial number, the restore operation will fail if you do not delete it.
12. Enter **key config-key password-encryption** followed by the same passphrase that was used to create the Master Configuration Key (MCK) in the faulty gateway. This creates on the new gateway an MCK identical to the MCK in the faulty gateway, which enables the restore operation to decrypt the secrets in the configuration file.  
  
The restored configuration file will include all the configuration of the gateway, including user's names and passwords, IKE pre-shared keys, etc.
13. Insert the USB mass storage device in the new G450 USB port.
14. Enter **restore usb usbdevice0 backup-name**, where *backup-name* is the backup directory path and file name on the USB mass storage device.
15. Enter **show restore status** to check the status of the restore operation. The report lists the files restored.
16. Obtain and install a VPN license. For information on obtaining a VPN license, see *Installing and Upgrading the Avaya G450 Media Gateway*, 03-602054.
17. Update the S8300 on the new G450 with the serial number of the new gateway, otherwise the gateway is not able to register in the Avaya Communication Manager. See *Administrator's Guide for Avaya Communication Manager*, 555-233-506.  
  
The new G450 is now a restored, fully-operational G450.

**Note:**

Before unplugging the USB mass storage device, use the **safe-removal usb** command to safely remove the USB mass storage device.

## Replacing/adding/upgrading media modules using a USB mass storage device

1. Backup the gateway by entering **backup config usb usbdevice0 backup-name**, where *backup-name* is the backup directory path and file name you are creating on the USB mass storage device.  
  
A backup directory is created on the USB mass storage device, with a directory structure as detailed in [Table 20](#).
2. From the Avaya support website, download to your PC the firmware files of the media modules you are adding or upgrading. For each media module, download all firmware corresponding to the various hardware vintage/suffix versions available for that module. If you are not sure which files you need, you can download the firmware files of all media modules. The restore operation uses only the files needed.
3. Insert the USB mass storage device into the PC's USB port, and copy the media modules' firmware files to the `MM` subdirectory under the root backup directory.

## Basic device configuration

### Important:

When adding files to a backup directory on a USB mass storage device, it is important to follow the file and directory naming convention, in order to enable a successful restore.

4. Insert the USB mass storage device into a G450 USB port.
5. Enter **restore usb usbdevice0 backup-name**, where **backup-name** is the backup directory path and file name on the USB mass storage device.
6. If you changed the placement of media modules in the slots, update the MGC managing the media gateway. See *Administrator's Guide for Avaya Communication Manager*, 555-233-506.

### Note:

Before unplugging the USB mass storage device, use the **safe-removal usb** command to safely remove the USB mass storage device.

## Additional USB commands

The following USB commands are available:

- Use the **erase usb** command to erase a file or directory on the USB mass storage device.
- Use the **show usb** command to display the USB devices connected to the gateway.

## Summary of USB backup, restore, and replication commands

For more information about these commands, see *Avaya G450 CLI Reference*, 03-300437.

**Table 22: USB backup, restore, and replication CLI commands**

Command	Description
<b>backup config usb</b>	Back up the gateway configuration to a USB mass storage
<b>copy ftp sw_imageA</b>	Download a software image from an FTP server into Bank A
<b>copy tftp sw_imageA</b>	Download a software image from a TFTP server into Bank A
<b>dir</b>	Display information regarding the status of a restore operation of gateway files from a USB mass storage device
<b>erase usb</b>	Erase a file or directory on the USB mass storage device
<b>key config-key password-encryption</b>	Change the default Master Key of the gateway, which is used to encrypt gateway secrets in the gateway configuration file

1 of 2



**Table 22: USB backup, restore, and replication CLI commands (continued)**

Command	Description
<code>restore usb</code>	Restore gateway files from a USB mass storage device
<code>safe-removal usb</code>	Safely remove the USB mass storage device
<code>show backup status</code>	Display information regarding the status of a backup of the gateway configuration to a USB mass storage device
<code>show image version</code>	Display the software version of the image on both memory banks of the device
<code>show system</code>	Display information about the device
<code>show usb</code>	Display the USB devices connected to the gateway
<b>2 of 2</b>	

---

## Backing up and restoring configuration files

A configuration file is a data file that contains a complete set of configuration settings for the Avaya G450 Media Gateway. You can use configuration files to back up and restore the configuration of the G450. You can back up either the running configuration or the startup configuration to the server as a configuration file. When you restore a configuration file from a server, it becomes the startup configuration on the G450. For more information about running configuration and startup configuration, see [Saving configuration changes](#) on page 40.

### Note:

The startup configuration file stores gateway secrets (passwords, etc.) in an encrypted format. Thus, secrets do not have to be re-entered if you are copying a configuration file from one G450 to another. For more information, see [Managing gateway secrets](#) on page 68.

You can:

- Use the FTP/TFTP/SCP copy commands to transfer a configuration file between the G450 and a server on the network.
- Use a USB mass storage device connected to a G450 USB port to upload or download the startup configuration file of the G450. You can use either the USB copy commands, or use the USB backup and restore commands for a full backup and restore of the gateway (refer to [Backing up and restoring the G450 using a USB mass storage device](#) on page 105).

## Backing up/restoring a configuration file using FTP/TFTP/SCP

- Use the **copy ftp startup-config** command to restore a configuration file from an FTP server. The configuration file becomes the startup configuration on the G450.
- Use the **copy tftp startup-config** command to restore a configuration file from a TFTP server. The configuration file becomes the startup configuration on the G450.
- Use the **copy scp startup-config** command to restore a configuration file from an SCP server. The configuration file becomes the startup configuration on the G450.

**Note:**

You can use the **show download status** command to display the status of the current configuration file download process, as the file is being loaded into the device.

- Use the **copy running-config ftp** command to back up the running configuration on the G450 to an FTP server.
- Use the **copy running-config tftp** command to back up the running configuration on the G450 to a TFTP server.
- Use the **copy running-config scp** command to back up the running configuration on the G450 to a SCP server.
- Use the **copy startup-config ftp** command to back up the startup configuration on the G450 to an FTP server.
- Use the **copy startup-config tftp** command to back up the startup configuration on the G450 to a TFTP server.
- Use the **copy startup-config scp** command to back up the startup configuration on the G450 to a SCP server.

## Backing up/restoring a configuration file using a USB mass storage device

- Use the **copy startup-config usb** command to back up the startup configuration from the G450 to the USB mass storage device.
- Use the **copy usb startup-config** command to restore the startup configuration from the USB mass storage device to the G450.

**Note:**

You can use the **show download status** command to display the status of the current configuration file download process, as the file is being loaded into the device.

## Summary of configuration file backup and restore commands

For more information about these commands, see *Avaya G450 CLI Reference*, 03-300437.

**Table 23: Configuration file backup and restore CLI commands**

Command	Description
<b>copy ftp startup-config</b>	Download a G450 configuration file from an FTP server to the Startup Configuration NVRAM
<b>copy scp startup-config</b>	Download a G450 configuration from an SCP server to the Startup Configuration NVRAM
<b>copy tftp startup-config</b>	Download a G450 configuration file from a TFTP server to the Startup Configuration NVRAM
<b>copy usb startup-config</b>	Download a G450 configuration file from a USB mass storage device to the Startup Configuration NVRAM
<b>copy running-config ftp</b>	Upload the current G450 running configuration to a file on an FTP server
<b>copy running-config scp</b>	Upload the current G450 running configuration to a file on an SCP server
<b>copy running-config tftp</b>	Upload the current G450 running configuration to a file on a TFTP server
<b>copy startup-config ftp</b>	Upload the current G450 startup configuration to a file on an FTP server
<b>copy startup-config scp</b>	Upload the current G450 startup configuration to a file on a SCP server
<b>copy startup-config tftp</b>	Upload the current G450 startup configuration to a file on a TFTP server
<b>copy startup-config usb</b>	Upload the current G450 startup configuration to a file on a USB mass storage device
<b>show download status</b>	Display the status of the current G450 configuration file download process, as the file is being loaded into the device

---

## Listing the files on the Avaya G450 Media Gateway

Use the `dir` command to list all G450 files. When you list the files, you can see the version numbers of the software components. The `dir` command also shows the booter file, which cannot be changed.

You can also use the `dir` command to list all files in the USB mass storage device connected to the G450.

### Summary of file listing commands

For more information about these commands, see *Avaya G450 CLI Reference*, 03-300437.

**Table 24: File listing CLI commands**

Command	Description
<code>dir</code>	List all G450 files or display files on the USB mass storage device

# Chapter 6: Configuring Standard Local Survivability (SLS)

Standard Local Survivability (SLS) provides a local G450 with a limited subset of MGC functionality when there is no IP-routed WAN link available to an MGC, or no MGC is available.

SLS is not a replacement for ELS or LSP survivability, which offer full call-feature functionality and full translations in the survivable mode. Instead, SLS is a cost-effective survivability alternative offering limited call processing in survivable mode. Although the G450 can host an S8300 Server in ICC or LSP mode, SLS offers both local survivability and call control.

In contrast to the server-based survivability features, SLS operates entirely from the media gateway and requires a data set comprised of Avaya Communication Manager translations (survivable ARS analysis and configuration data). This data set is compiled and distributed to a group of devices using the Provisioning and Installation Manager (PIM). In the absence of the PIM, the data set can be configured manually from individual media gateways using CLI commands. For instructions on configuring SLS, see [Configuring SLS](#) on page 132.

---

## Media module compatibility with SLS

SLS works on the G450 and its media modules only if they satisfy the minimum hardware vintage and firmware version requirements listed in [Table 25](#).

**Table 25: G450 media module firmware version required**

Media module	Minimum firmware version required
MM710	Vintage 16
MM711, hw v20+	Vintage 69
MM711, hw v30+	Vintage 84
MM712	Vintage 8
MM714, hw v1-v5	Vintage 69
MM714, hw v10+	Vintage 84
MM716	Vintage 84

*1 of 2*

**Table 25: G450 media module firmware version required (continued)**

Media module	Minimum firmware version required
MM717	Vintage 8
MM720	Vintage 7
MM722	Vintage 7
G450 gateway	MG 4.1, build 27_x
<b>2 of 2</b>	

---

## SLS service

- Call capability for analog, DCP, and IP phones
- ISDN BRI/PRI trunk interfaces
- Non-ISDN digital DS1 trunk interfaces
- Outbound dialing through the local PSTN (local trunk gateway) from analog, DCP, and IP phones
- Inbound calls from each trunk to pre-configured local analog or IP phones that have registered
- Direct inward dialing
- Multiple call appearances
- Hold and call transfer functions
- Contact closure feature
- Local call progress tones (dial tone, busy, etc.)
- Emergency Transfer Relay (ETR) in cases of power loss
- Auto fallback to primary MGC
- IP station registration

---

## Avaya phones supported in SLS

**Table 26: Avaya phones supported in SLS**

<b>Analog</b>	<b>DCP</b>	<b>IP</b>
2500	2402	4601
	2410	4602
	2420	4602sw
	6402	4610sw
	6402D	4612
	6408	4620
	6408+	4620sw (default)
	6408D (default)	4621
	6408D+	4622
	6416D+	4624
	6424D+	4625
	8403B	
	8405B	
	8405B+	
	8405D	
	8405D+	
	8410B	
	8410D	
	8411B	
	8411D	
	8434D	

## Configuring Standard Local Survivability (SLS)

The new Avaya 96xx IP phone family is not directly referenced in the G450 CLI. When you administer these phones via the CLI, use the following mapping:

**Table 27: Mapping Avaya 96xx IP phones for CLI administration**

Module name	CLI interface name
9610	4606
9620	4610
9630	4620
9640	4620
9650	4620

---

## Call processing in SLS mode

In survivable mode, SLS provides only a limited subset of Avaya Communication Manager call processing functionality:

- Limited call routing through a Survivable ARS Analysis Table (in the PIM application or through the CLI) and COR calling permissions
- Inbound calls are directed in one of three ways:
  - Using the **Incoming-Routing** form
  - Using the **Set Incoming-Destination** on the **Trunk group** form, which enables mapping to a given station
  - Inbound calls are directed to a previously-administered pool of available stations (the **Survivable Trunk Dest?** field is **y** on the **Station** form). The search algorithm is circular so that the incoming calls are fairly distributed.

 **Important:**

SLS permits 911 calls, but the specific location information is not transmitted to the Public Service Answering Point (PSAP). Only the general trunk-identifying information is transmitted. Emergency personnel will have a general location associated with the trunk (for example, a building address), but nothing more specific (for example, a room or office number). Also, if a 911 call disconnects for any reason, emergency personnel cannot reliably call the originator back. A small business office's address is sufficient from the perspective of emergency routing.

- Communication Manager Feature Access Codes for ARS, contact closure, and Hold



- Acts as an H.323 Gatekeeper that enables IP endpoints to register simultaneously
- Direct Inward Dialing
- Multiple call appearances
- Hold and Call Transfer functions
- Contact closure feature
- Call Detail Recording (CDR, see [SLS logging activities](#) on page 130)
- Trunk Access Code (TAC) dialing
- Non-ISDN DS1 trunks (with in-band signaling)
- ISDN PRI/BRI trunks:
  - **T1 robbed-bit.** All 24 channels serve as trunks without full 64 kbps transmission
  - **E1 CAS.** All 31 channels serve as trunks with full 64 kbps transmission

---

## Call processing not supported by SLS

- Many small business customers employ custom calling features such as call waiting, from the BOC/LEC, attempting a more PBX-like capability. These features are not supported by SLS.
- Non-ISDN signaling:
  - DMI BOS signaling for T1 and E1
  - R2-MFC signaling for E1
- Calling party name/number information to digital station displays
- Caller ID on outgoing analog station calls
- Caller ID on incoming analog loop-start trunk calls
- Three party conferences
- Last Number Redial
- Call Forwarding-Busy/Don't Answer
- No Music On Hold source or announcement playback
- Call Center features, including ASAI
- Connection Preserving Failover/Failback for H.248 Gateways

### Provisioning data

SLS requires that the G450 has connected to an MGC at least once and has received provisioning information, including:

- Avaya Communication Manager port information sent through the H.248 control channel:
  - Tone sources, including a distinctly different dial tone to inform users that the system is operating in survivable mode
  - Loss plan
- Avaya Communication Manager provisioning information for the options in the station and trunk media modules is sent through the CCMS channel
- Provisioning and Installation Manager (PIM) queries Avaya Communication Manager for station/trunk configuration and dial plan routing administration data through SNMP. Alternatively, the provisioning may be entered manually via an SNMP MIB browser or via the local gateway's CLI interface.

These data sources and communication links are illustrated in [Figure 10](#).

**Figure 10: Standard Local Survivability data sources and communication paths**

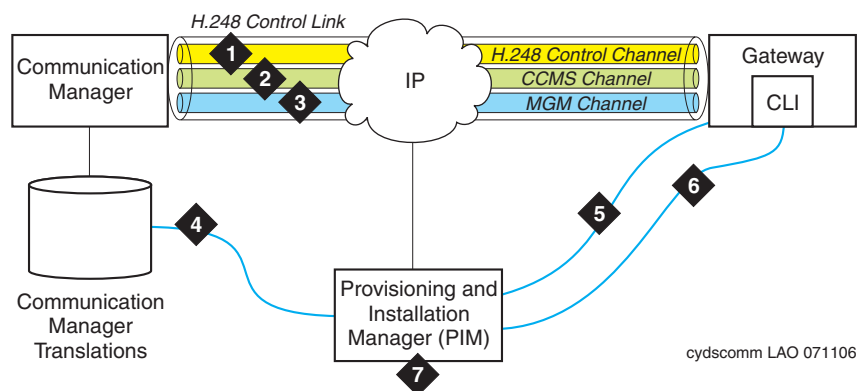

#### Figure notes:

1. H.248 call signaling and configuration data
2. CCMS messages through Clear Channel
3. Media Gateway Maintenance Channel
4. PIM extracts Communication Manager translation subset through OSSI
5. PIM data set and SLS MIB delivered to the gateway through SNMP
6. Security codes (passwords) sent over SSH connection to CLI
7. Provisioning and Installation Manager (PIM) for remotely provisioning gateways, network-wide. PIM is installed on an enterprise management server, not on the primary Communication Manager server.

**NOTE:** The SLS data must be configured manually in the gateway if the PIM is not available.

The required Communication Manager translations for SLS include fields on the **Station** and **Media Gateway** forms. See [Configuring Communication Manager for SLS](#) on page 133 for more information about the information types and how to administer Communication Manager for SLS.

---

## PIM configuration data

SLS also requires PIM configuration data, some of which the G450 extracts from the Avaya Communication Manager translations. PIM aggregates the required data and copies the provisioning data over a secure communication path to non-volatile RAM (NVRAM) on the G450. After the initial data collection, PIM retains a copy of the data set for each G450. This set is compared with subsequent data sets to determine if anything has changed:

- If the data set changes, the newer data set is pushed down to the media gateway
- If the data set does not change, the data set in NVRAM remains unchanged

Users can schedule when to collect and push data, perform scheduled and manual backups, and enable and disable SLS, as well as display (but not change) the data to ensure correct information. See [Using PIM to manage SLS administration on the gateway](#) on page 138.

If PIM is unavailable, the SLS data set can be manually configured in the G450 CLI. For information on configuring SLS, both manually and via PIM, see [Configuring SLS](#) on page 132.

---

## Entering SLS mode

When SLS is enabled, the MGC list displays a fifth element called *SLS*. This element is always past the Transition Point. After the Link Recovery search concludes for the primary MGC list (entries above the Transition Point), it searches the alternate MGC list (entries below the Transition Point), ending with *SLS*, the last choice for the G450.

When the Link Recovery search settles on the *SLS* entry in the MGC list, the G450 registers with SLS (resident on the G450) for its call control.

SLS transitions between four possible SLS states: Unregistered, Setup, Registered, and Teardown.

### Unregistered state

This is the normal state in which SLS waits for an H.248 registration request from the G450. When SLS receives the request, it registers the G450 and transitions to the Setup state.

### Setup state

In this transitional state, SLS performs the following activities:

1. Checks for proper provisioning data. If there is insufficient provisioning, the registration request is denied, and SLS returns to the Unregistered state.
2. Initializes SLS components, such as gatekeeper data (for example, IP endpoint's E.164 addresses and passwords), dial plan, and ARS routing.
3. Registers with the media gateway.
4. Creates the H.323 Gatekeeper socket after successful registration.

When Setup is complete, SLS transitions to the Registered state.

### Registered state

SLS can only process calls while it is in the Registered state in which it performs the following:

1. Constructs endpoint objects based on board insertion and IP registration.
2. Tears down endpoint objects based on board removal and IP unregistration.
3. Handles registration requests from H.323 endpoints that properly authenticate by using their extension number as a 'terminal alias', and the password as the registration encryption key.
4. Handles stimuli from all interfaces to establish and remove calls.

SLS remains in the Registered state as long as the socket to SLS is open.

### Teardown

SLS transitions to the Teardown state whenever the following occur:

- The G450 administrator uses the **set sls disable** command from the G450 CLI or manual MIB browser using the SNMP read/write attribute avSurvAdminState.
- The G450 closes the SLS socket after maintenance determines that it has completed an H.248 registration with the primary MGC.
- SLS determines that it needs to unregister with the G450 due to internal error conditions.

#### Teardown state activities

1. Tears down endpoint objects.
2. Sends unregistration requests to IP endpoints that are not on active calls. IP endpoints lose registration with SLS and display the discovered IP address during re-registration with an MGC.
3. Closes the H.323 Gatekeeper socket.

After Teardown is complete, SLS transitions to the Unregistered state and starts searching at the top of the MGC list for a controller.

---

## SLS interaction with specific G450 features

SLS interacts differently with the various G450 features.

### Direct Inward Dialing in SLS mode

Direct Inward Dial (DID) is a service offered by telephone companies that enables callers to dial directly into an extension on a PBX without the assistance of an operator or automated call attendant.

**Note:**

DID is a method of routing calls that applies to both analog and digital (T1/E1) lines. However, while the method is typically referred to as DID in the analog world, it is usually called Dialed Number Identification Service (DNIS) in the digital world. Despite the difference in names, the concept is the same.

The gateways support DID central office trunk interfaces, and the digit transmission from the central office is configurable when ordering the service:

- **Immediate.** The DID signaling starts immediately after the central office seizes the analog DID trunk by closing the loop (across tip and ring). In addition, analog DID trunk lines only support inbound calls. For this reason, Customer Premise Equipment (CPE) utilizing DID trunk lines for inbound routing may utilize loop-start lines for outbound transmission.
- **Wink.** The DID signaling starts after the gateway's analog trunk interface reverses the battery polarity and sends a "wink" to the central office.

 **WARNING:**

An analog two-wire DID trunk line is different from a standard analog loop-start line. With analog DID trunk lines, the battery (power feed) to the line is supplied by the gateway's analog trunk interface. With a standard loop-start line, the power is supplied by the central office, which is why damage can occur from connecting a loop-start PSTN trunk to the DID port.

The number of sent digits (3-4 typically) and signaling type (Pulse/DTMF) are also configurable at ordering time.

### Multiple call appearances in SLS mode

When a gateway is in SLS mode, three call appearances, each with limitations, are supported:

- The first two call appearances are for incoming or outgoing calls. The first call appearance is the default.

## Configuring Standard Local Survivability (SLS)

- The third call appearance is for outgoing calls only.

### Note:

"First", "second", and "third", refer to the order in which you use call appearances, not the order of the Call Appearance buttons on your phone.

For example, User A chooses the third call appearance to dial User B, and then User C calls User A, which is sent to the first call appearance. In this situation, a subsequent inbound call to User A will be denied (busy) because the first and third call appearances are in use, and the second call appearance is only available for outbound calls.

## Hold in SLS mode

Using the Hold feature differs by user and by phone type, and the same is true of the Hold feature in Standard Local Survivability (SLS) mode. Some users return to a call on Hold by pressing the Call Appearance button, however, Communication Manager has an administrable parameter that allows users to release a call on hold by pressing the Hold button a second time (if only one call is held). The Hold feature also works differently in [DCP and IP phones](#) and [Analog phones](#) in the survivable mode.

The Hold feature in SLS does not support:

- Music on Hold
- Local mute on analog phones
- Specialized treatment of E-911 calls
- Call Hold indicator tones

## DCP and IP phones

When a media gateway is in the survivable mode, you can release calls on Hold on all DCP and IP phones by either:

- Pressing the Hold button a second time (if only one call is held)
- Pressing the held Call Appearance button

## Analog phones

Newer analog phones (for example, Avaya 62xx series) have buttons with specific functions for placing a call on Hold:

- **Hold button.** A hold function that is local to the phone  
Pressing the Hold button causes the analog station to place a hold bridge in both directions at the telephone set. No signaling notification is sent to the SLS call-engine and, therefore, there is no ability to notify the other party that they have been placed on hold. Pressing the Hold button a second time causes the analog phone to remove the hold bridge and the call path is restored. In essence, this hold operation is equivalent to using the Mute button on station sets.
- **Flash button.** A function that sends a switchhook signal to the server
- **Switchhook** (receiver on/off hook). A function that sends a disconnect signal to the server

## Using the Flash button

1. Press the Flash button on the analog phone.

You hear a dial tone; the other party hears nothing.

You can leave the call on Hold or transfer the call. Press the Flash button twice to return to the call.

2. Dial the Feature Access Code (FAC) for Hold.

At this point you can leave the call on Hold or transfer the call.

3. To return to the call, press the Flash button again.

The call is re-established.

### Note:

Either party can put the call on Hold or return to the call.

## Using the switchhook button

1. Press the switchhook once.

You hear a dial tone.

2. Dial the FAC for Hold.

This places the call on Hard Hold which prevents you from transferring the call. To return to the call, dial the FAC for Hold.

3. Do one of the following:

- Return to the call by dialing the FAC for Hold.

The call is re-established.

- Dial a third party by dialing the number and flashing the switchhook once (you will hear a stutter dial tone). Dial the FAC for Hold (the second call is now on Hold and the first call is re-established). If you want to toggle between the first and second calls, press the switchhook and dial the FAC for Hold once each time you want to change calls.

- Hang up.

Your phone will ring to notify you that you have a call on Hold. When you lift the receiver you will hear a dial tone and can perform any of the activities listed in Step 3.

## Call Transfer in SLS mode

Using the Call Transfer feature differs by user and by phone type. The same is true of the Hold feature in Standard Local Survivability (SLS) mode. Call Transfer also works differently in DCP/IP phones and analog phones in the survivable mode. Some limitations of the Call Transfer feature are:

- The established call must be initiated from a local station (administered on this gateway) or from an incoming trunk. You can make only point-to-point call transfers to a phone that is local to the same gateway.

## Configuring Standard Local Survivability (SLS)

- Does not support E-911 calls
- Does not support the Conference button on any phone
- Does not support trunk-to-trunk transfer (for example, for voice messaging)

### Transferring a call on DCP and IP phones

1. While talking on a call or while you have a call on Hold, press the Transfer button on your phone.

You hear a dial tone; the other party hears nothing.

2. Dial the third party's number on your phone.
3. You can either:
  - Wait for the third party to answer and announce the call, then either press the Transfer button again or hang up.
  - Transfer the call before the third party answers by pressing the Transfer button again.

The person you were talking to is transferred to the third party.

A message appears on your phone display to indicate that the call transfer is complete.

#### Note:

If you do not completely dial the string or if you hear a fast-busy or re-order (French siren) tone, only a Hard Hold call connection (if present) remains at the station.

If the third party does not answer, the call does not ring back to the originating party. If a transfer does not complete, the event is logged.

### Transferring an established call from an analog phone

Newer analog phones (for example, Avaya 62xx series) have buttons with specific functions for transferring a call. The switchhook (receiver on/off hook) sends a disconnect signal to the server, and the Transfer/Flash button sends a transfer message to the server.

1. While on a call, press the switchhook once or press the Transfer/Flash button.

You hear a dial tone; the other party will hear nothing.

2. Dial the third party's number on your phone.
3. You can either:
  - Wait for the third party to answer and announce the call, then hang up.
  - Transfer the call before the third party answers by hanging up.

The person you were talking to is transferred to the third party.

A message appears on your phone display to indicate that the call transfer is complete. If the necessary call processing resources are not available, the transfer does not complete and the event is logged.



**Note:**

Displays are not supported on analog phones unless they are supported locally by an analog phone.

## Using contact closure in SLS mode

When the media gateway is in survivable mode, contact closure works as follows:

1. Lift the phone receiver and listen for the survivability dial tone.
2. Dial the appropriate contact closure FAC (open, close, or pulse) on the phone.
  - If you dial an invalid FAC code, then SLS plays an intercept tone and terminates the session.
  - If you dial a valid FAC code, then you will hear a standard dial tone and can proceed to Step 3.
3. Dial the media gateway number (three digits).
  - If you enter fewer than three digits, then SLS times out and you must restart this procedure from the beginning.
  - If the media gateway number matches the local media gateway number, then SLS plays a standard dial tone and you can proceed to Step 4.
  - If the media gateway number does not match the local media gateway number, SLS plays an intercept tone and terminates the session.
4. Dial the contact closure code, for example **1** for contact pair #1, and **2** for contact pair #2. You hear stutter tone and then silence, confirming these valid codes. If you dial an invalid contact closure number, you will hear an intercept tone.
  - Contact closure feature activations appear in the CDR log (see [Figure 12](#)).

**Note:**

If the contact closures are set to manual operation, the FAC operation will not work even though the confirmation tone is heard. However, an event will be logged.

### Contact closure / SLS feature interactions

- There is no screening to authorize the use of the contact closure feature in SLS mode. Security is provided by limiting the number of users who know the correct key sequence required for the contact closure feature.
- You cannot use the Hold or Transfer features while dialing the contact closure FAC key sequence.
- Contact closure will not work until you dial the full digit sequence and it is processed.
- If two users try to simultaneously use contact closure, whoever dials the full FAC key sequence first gets precedence.

## Configuring Standard Local Survivability (SLS)

- Interdigit timing rules apply to the contact closure feature, so if you pause too long during the FAC key sequence, the feature times out.
- Call appearances are not released (available for calls) until you hang up.
- You cannot use the contact closure feature from outside trunk lines.

**Note:**

For more information on contact closure, refer to [Configuring contact closure](#) on page 343.

## IP Softphone shared administrative identity in SLS mode

The SLS mode supports shared administrative identity with the Avaya Softphone application, but requires specific station administration.

1. Access the CM administrative SAT interface. For instructions on accessing the Avaya Communication Manager through the G450, see [Accessing the registered MGC](#) on page 87.
2. At the SAT interface, enter **change station extension** to display the **Station** form.
3. Set the **Terminal Type** field to a 46xx IP phone.
4. Save the changes.

**Note:**

If you administer the **Terminal Type** field as a DCP phone, shared administrative identity functionality in SLS mode is not supported.

---

## SLS logging activities

SLS exports call-recording data in survivability mode. The Call Detail Record (CDR) log contains detailed information about each outgoing call that uses a trunk. This information can be stored in flash NVRAM or directed to an external server for later processing. It includes data for:

- Merged outgoing Trunk Access Codes (TACs), indicating successfully completed dialing
- Successfully completed ARS calls, as shown in [Figure 11](#)
- Contact closure, as shown in [Figure 12](#)

## Example of CDR log entries and format

**Figure 11: CDR log example**

```
G450-SLS(super)# show logging cdr file content

02/18/2005,10:46:35:CDR-Informational: 10:46 00:00 A 700 50029555 52001 v301

02/18/2005,10:45:46:CDR-Informational: 10:45 00:00 A 700 50029 52001 v301

02/18/2005,10:45:14:CDR-Informational: 10:45 00:00 A 700 52 52001 v301

02/18/2005,10:44:35:CDR-Informational: 10:44 00:00 A 700 445200 52001 v301

02/10/2005,13:20:23:CDR-Informational: 13:20 00:00 A 700 50029 52001 v301

02/10/2005,13:20:15:CDR-Informational: 13:20 00:00 A 700 50029 52000 v301

02/10/2005,13:20:05:CDR-Informational: 13:20 00:00 A 700 44 52000 v301

02/10/2005,13:19:59:CDR-Informational: 13:19 00:00 A 700 44500 52000 v301
```

An interpretation of the first entry in [Figure 11](#) is:

- **02/18/2005** is the date of the log entry
- **10:46:35** is the time of the log entry
- **CDR-Informational** is the category (to aid sorting)
- **10:46** is the time the call was placed
- **00:00** is the duration of the call in hours and minutes or **99:99** if the duration is greater than 99 hours
- **A** is the condition code. Possible values are:
  - 7. Outgoing call
  - 9. Incoming call
  - A. Outgoing TAC call or emergency call
  - B. Used for contact closure
- **700** is the FAC or TAC number
- **50029555** is the dialed number
- **52001** is the extension that originated the call
- **v301** indicates the port through which the call was routed

### Example of CDR log with contact closure

---

**Figure 12: CDR log example, contact closure**

```
G450-SLS(super)# show logging cdr file content  
  
07/27/2005,03:59:24:(0 0 0:15:5)CDR-Informational: July 27 03:59 B 15840 PULSE 003 2
```

---

An interpretation of the entry in [Figure 12](#) is:

- Date (**07/27/2005**) and time (**03:59:24**) record when the feature was activated
- **B** is the condition code. Possible values are:
  - 7. Outgoing call
  - A. Outgoing TAC call or emergency call
  - B. Used for contact closure
- **15840** is the extension that activated the feature
- **PULSE** indicates the contact closure operation (could also be **OPEN** or **CLOSE**)
- **003** is the media gateway number
- **2** is the contact closure number

---

## Configuring SLS

SLS is included as part of the resident gateway firmware package that is installed as part of the G450 gateway firmware upgrade. However, for SLS to function correctly, the following conditions must be met:

- Avaya Communication Manager must be configured for SLS and Auto Fallback. For instructions on configuring SLS in Avaya Communication Manager, see [Configuring Communication Manager for SLS](#) on page 133.
- Provisioning data from the PIM tool must be gathered from Avaya Communication Manager and delivered to the G450 using PIM. For instructions on gathering and delivering the provisioning data, see [Using PIM to manage SLS administration on the gateway](#) on page 138.  
If PIM is not available, the G450 can be manually configured for SLS and Auto Fallback via the CLI. See [Using the CLI to manually configure SLS administration on the gateway](#) on page 144.
- SLS must be enabled on the G450. See [Enabling and disabling SLS](#) on page 143.

- To activate any saved changes within SLS, the disable and enable SLS commands must be used together. See [Activating changes in SLS](#) on page 144.

**Note:**

Exercise caution when using a CLI session and an SNMP manual browser session concurrently. Specifically, if the administrator has entered as SLS second level context for trunk-group to view command settings, then performs an SNMP write operation to change a give attribute, this will get overwritten back with the present CLI values in the process of exiting the second level CLI command area for trunk-group. It is recommended that a single admin interface be used for a given administration parameter update session.

## Configuring Communication Manager for SLS

You must configure the Avaya Communication Manager for SLS whether you will be using PIM provisioning or manual CLI entry of SLS administration. Perform the configuration during the initial administration of the host CM server.

1. Access the CM administrative SAT interface. For instructions on accessing the Avaya Communication Manager through the G450, see [Accessing the registered MGC](#) on page 87.
2. At the SAT, enter **change node-names ip** to display the **IP Node Names** form. For example:

```
change node-names ip                                     Page 1 of 1
                                                    IP NODE NAMES
      Name                IP Address                Name                IP Address
Denver Gateway1      192.168.1 .200
procr                192.168.1 .201                . . .
(X of X administered node-names were displayed )
Use 'list node-names' command to see all the administered node-names
Use 'change node-names ip xxx' to change a node-name 'xxx' or add a node-name
```

3. In the **Name** field, type the gateway name; that is, the name of the survivable gatekeeper node that corresponds to the IP address in Step 4.

**Note:**

Set the name of the media gateway consistently with the **Name** field on the **Media Gateway Administration** form in Communication Manager (**add media-gateway**) and with the name used in the **set system name** command (gateway CLI).

4. Type the IP address of the gateway in the **IP Address** field.
5. Submit the form.

## Configuring Standard Local Survivability (SLS)

- At the SAT, enter **change system-parameters mg-recovery-rule 1** to display the **System Parameters Media Gateway Automatic Recovery Rule** form. For example:

```
change system-parameters mg-recovery-rule 1                               Page 1 of 1
      SYSTEM PARAMETERS MEDIA GATEWAY AUTOMATIC RECOVERY RULE
Recovery Rule Number: 1
Rule Name: _____
Migrate H.248 MG to primary: immediately
Minimum time of network stability: 3
WARNING: The MG shall be migrated at the first possible opportunity. The MG may
be migrated with a number of active calls. These calls shall have their talk
paths preserved, but no additional processing of features shall be honored. The
user must hang up in order to regain access to all features.

NOTE: set 'Migrate H.248 MG to primary' to Blank to disable rule.
```

- Type a description of the rule in the **Rule Name** field.
- Set the **Migrate H.248 MG to primary** field to **immediately**.

**Note:**

The **immediately** field value is only one of the four possible choices. See the *Administrator Guide for Avaya Communication Manager*, 03-300509 for more information on the values for this field.

- Submit the form.

10. At the SAT, enter **display media-gateway 1** to display the **Media Gateway** form. For example:

```

display media-gateway 1
                                MEDIA GATEWAY
                                Registered? y
                                Type: g450           FW Version/HW Vintage: 27 .4 .0 /0
                                Name: hardy-gw        MGP IP Address: 135.9 .78 .201
                                Serial No: 06IS60111112  Controller IP Address: 135.9 .78 .202
                                Encrypt Link? y        MAC Address: 00:04:0d:ea:a9:f0
                                Network Region: 1
                                Location: 1           Site Data:
                                Recovery Rule: 1

                                DSP Type  FW/HW version
                                DAR1      1      0
Slot  Module Type              Name
V1:   S8300                   ICC MM
V2:
V3:   MM714                   ANA MM
V4:   MM710                   DS1 MM
V5:
V6:
V7:   MM712                   DCP MM
V8:   MM711                   ANA MM
V9:   gateway-announcements  ANN VMM
                                Max Survivable IP Ext: 8
                                Announcement board must also be enabled; use 'enable announcement-board'

Command:
F1=Cancel F2=Refresh F3=Submit F4=Clr Fld F5=Help F6=Update F7=Nxt Pg F8=Prv Pg

```

11. Verify the following fields:

- **Name** field (20 characters maximum) must match the administered name of the gateway (see Step 2 of [Configuring the SLS data through the CLI](#) on page 159).
- **Max Survivable IP Ext** field only appears when the Type field is **G450**. The current maximum product limits enforced by the SLS gateway's firmware module is 240.

These limits are enforced due to resource considerations in the given gateway.

 **Important:**

Since the VoIP resources on the gateway are limited, the **Max Survivable IP Ext** field should not exceed these values.

## Configuring Standard Local Survivability (SLS)

12. At the SAT, enter **change station extension** to display the **Station** form. For example:

```
change station 8003                                     Page 1 of 4
                                                         STATION
Extension: 8003                                         Lock Messages? n      BCC: 1
  Type: 4620                                           Security Code:        TN: 1
  Port: IP                                             Coverage Path 1:     COR: 1
  Name:                                                Coverage Path 2:     COS: 1
                                                         Hunt-to Station:
STATION OPTIONS
  Loss Group: 19                                       Personalized Ringing Pattern: 1
                                                         Message Lamp Ext: 8003
  Speakerphone: 2-way                                  Mute button enabled? y
  Display Language? English                            Expansion Module? n
Survivable GK Node Name:                               Media Complex Ext:
  Survivable COR: internal                             IP SoftPhone? N
  Survivable Trunk Dest? y
```

13. Verify the following fields:

- **Survivable GK Node Name.** Names the gatekeeper to register with when the gateway unregisters (loses call control) with the main server. The media gateway delivers the gatekeeper list to IP endpoints, allowing them to register and subsequently originate/receive calls from other endpoints in this survivable calling zone. This field must be set equal to the IP Node Name of the media gateway that will support this station in survivable mode.
- **Survivable COR.** Places a restriction level for stations to limit certain users to only certain types of calls:
  - **Emergency.** This station can only be used to place emergency calls which are defined
  - **Internal.** This station can only make intra-switch calls (default)
  - **Local.** This station can only make calls that are defined as **locl**, **op**, **svc**, or **hnpa** on the Survivable ARS Analysis Table
  - **Toll.** This station can place any national toll call which are defined as **fnpa** or **natl** on the Survivable ARS Analysis Table
  - **Unrestricted.** This station can place a call to any number defined in the Survivable ARS Analysis Table. Those strings administered as **deny** are also denied to these users as well.



[Figure 13](#) shows the hierarchical relationship among the calling-restriction categories.

**Figure 13: Inherited Class of Restriction (COR) permissions**

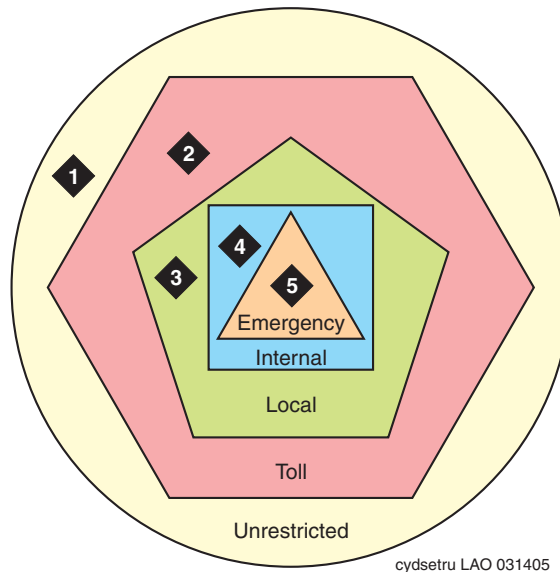

**Figure notes:**

1. **Unrestricted:** Users can dial any valid routable number, except an ARS pattern specifically administered as **deny** (see [Figure 14](#)). ETR functionality and calls through the CO are permitted in this class.
2. **Toll:** Users can only dial these call types:
  - **fnpa** (10-digit NANP call)
  - **natl** (non-NANP call)
3. **Local:** Users can only dial these call types:
  - **locl** (public-network local number call)
  - **op** (operator)
  - **svc** (service)
  - **hnpa** (7-digit NANP call)
4. **Internal:** Users can only dial other stations within the media gateway and the emergency external number (default)
5. **Emergency:** Users can only dial the emergency external number

- **Survivable Trunk Dest?** Enables stations to receive/not receive incoming trunk calls in survivable mode (default is receive). PIM extracts the Communication Manager information, pushes it to the media gateway, and stores it in NVRAM. This feature is an alternative technique for answering central office trunks (analog and digital non-ISDN) by routing directly to a station upon the action of inward trunk seizure. This operates equivalently to analog DID or ISDN trunk calls that have the ability to forward digit information regarding the called party.

14. Submit the form.

---

### Using PIM to manage SLS administration on the gateway

Before enabling SLS, you must gather provisioning data from PIM and deliver it to the G450. Run PIM's Device Profile Wizard to perform this task. The Device Profile Wizard gathers a subset of the Communication Manager translations (dial plan analysis and destination routing instructions) and delivers them to the G450. If PIM is not available, this translation subset (the SLS data set) can be created manually, using the procedure described in [Using the CLI to manually configure SLS administration on the gateway](#) on page 144.

PIM must be installed on and launched from the Avaya Network Management Console. For information about PIM, see [Accessing PIM](#) on page 52.

1. Ensure that the Network Management Console (NMC) has discovered the media gateway.
2. Before PIM's automatic scheduled SLS updates will work as expected, set the device parameters for both the server and the gateway in the NMC:
  - **Server.** Communication Manager login and password

**Note:**

The server must be the first listing in NMC's discovery output. If an ESS node is discovered and listed prior to the main server, the main server's login/password will not permit access to the ESS node.

- **Gateway.** SNMPv1/v3 access parameters
  - **Gateway.** NMC has discovered the gateway's IP address
3. Make sure the Communication Manager has been configured for SLS as described in [Configuring Communication Manager for SLS](#) on page 133.
  4. Click the **Device Profiles** icon/link in the top-level toolbar of the main PIM window. Alternatively, select **PIM Objects > Device Profiles** from the left panel.
  5. Click the **New** icon on the **Device Profile list** page that appears in the right panel of the main PIM window. If this is not a new profile, open the existing profile from the left panel or from the **Device Profile list** page.
  6. Proceed through the Device Profile Wizard to the **Details** page. Set the **CM version** field to 4.0.
  7. Proceed through the Device Profile Wizard to the **SLS / ARS** page ([Figure 14](#)) and perform the following:
    - a. Select the **Enable the SLS feature on this device?** checkbox to enable SLS on the G450. A cleared checkbox means that SLS is disabled.
    - b. Select the **Perform scheduled SLS updates on this device?** checkbox to send the SLS administration data set to the gateway according to the settings on the **SLS Update Schedule** form ([Figure 16](#)).

Figure 14: SLS / ARS page

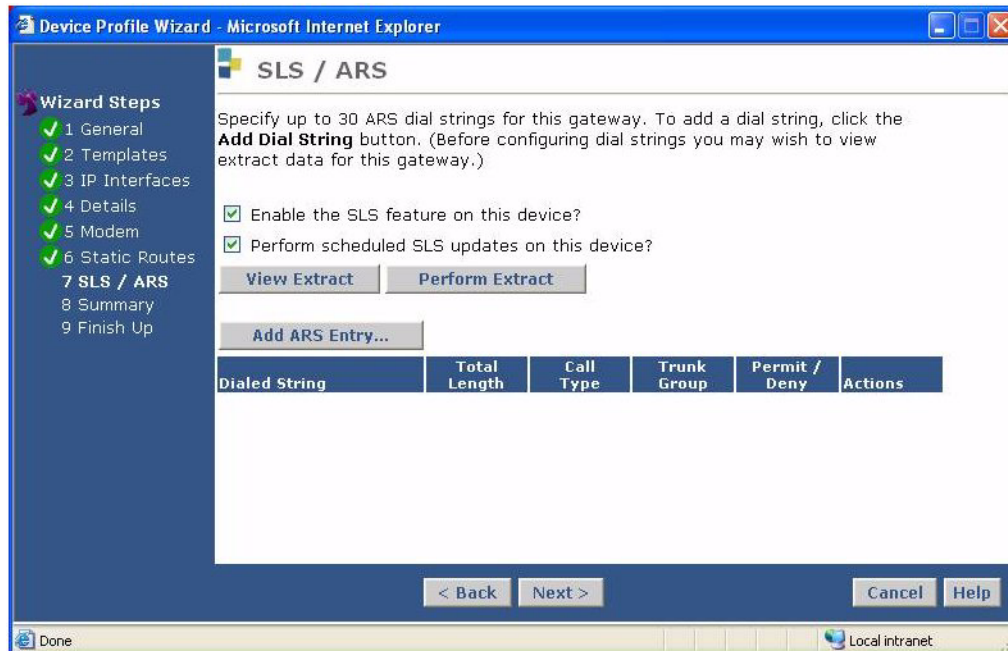

8. Optionally click the following buttons:
  - **View Extract** displays the current SLS administration data set for this gateway.
  - **Perform Extract** extracts the SLS information from the controlling Communication Manager server for this Media Gateway.
  - **Actions** enables you to edit or delete a previously-administered entry:
    - The paper/pencil icon is the **edit** icon, which opens the **ARS Entry** page ([Figure 15](#)).
    - The trash can icon is the **delete** icon, which removes the ARS Entry from the table. The **Add ARS Entry** option may be used to create/edit a maximum of 30 ARS dial pattern entries.
9. If this gateway has not been previously provisioned, click **Add ARS Entry** to open the **ARS Entry** page ([Figure 15](#)).

Figure 15: SLS ARS Entry page

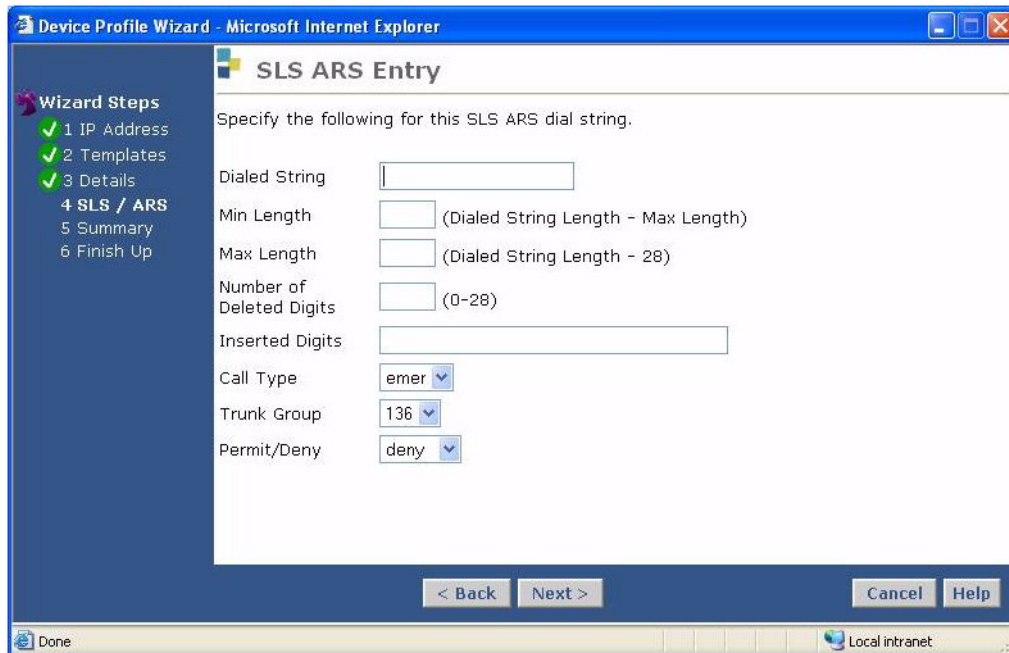

- Use the **SLS ARS Entry** page ([Figure 15](#)) to administer an Automatic Route Selection in SLS. Refer to [Table 29](#).

Table 29: SLS ARS Entry page field options

Field	Description
<b>Dialed String</b>	The maximum length of the dialed string is 18 characters. The allowed characters include 0-9, '*' and 'X' or 'x' as a pre-string or mid-string replacement. 'X' cannot be at the end of a dialed string.
<b>Min Length</b>	The minimum length of the user-dialed number that the SLS call engine collects to match to the dialed-string. The default is the length of the specified dialed-string element.
<b>Max Length</b>	The maximum length of the user-dialed number that the SLS call engine collects to match to the dialed-string. The default is the length of the specified dialed-string element.
<b>Number of Deleted Digits</b>	The number of dialed digits to be deleted from the beginning of the dialed string. Default: 0.
<b>Inserted Digits</b>	The digit string to be inserted at the beginning of the dialed string. Default: blank.

Table 29: SLS ARS Entry page field options (continued)

Field	Description
<b>Call Type</b>	Can be one of the following: <b>emer</b> (emergency call)* <b>fnpa</b> (10-digit NANP call) <b>hnpa</b> (7-digit NANP call) <b>intl</b> (public-network international number call) <b>iop</b> (international operator call) <b>locl</b> (public-network local number call) <b>natl</b> (non-NANP call) <b>op</b> (operator) <b>svc</b> (service)
<b>Trunk Group</b>	Trunk-group number (1-2000), which you can select from the drop-down choices of trunk groups found in the SLS extract from the controlling Communication Manager server
<b>Permit / Deny</b>	Indicates whether the call should be permitted or denied
<b>2 of 2</b>	

\* Any active, in-service station can dial the emergency access number while in survivable mode. Define the emergency access number on the **SLS / ARS** page ([Figure 14](#)).

 **Important:**

SLS permits 911 calls, but the specific location information is not transmitted to the Public Service Answering Point (PSAP). Only the general trunk-identifying information is transmitted. Emergency personnel will have a general location associated with the trunk (for example, a building address), but nothing more specific (for example, a room or office number). Also, if a 911 call disconnects for any reason, emergency personnel cannot reliably call the originator back.

## Configuring Standard Local Survivability (SLS)

11. Use the **SLS Update Schedule** page ([Figure 16](#)) to administer up to six SLS updates per day.

**Figure 16: SLS Update Schedule page**

**Survivability (G250 Only)**

Specify up to 15 ARS dial strings for this gateway. To add a dial string, click the **Add Dial String** button. (Before configuring dial strings you may wish to view extract data for this gateway.)

Enable the survivability feature on this device

Perform scheduled survivability updates on this device

Dialed String	Total Length	Call Type	Trunk Group	Permit/Deny	Actions
1	1	svc	3	Permit	
1	11	fnpa	3	Permit	
1	12-23	intl	4	Deny	

- a. Check the **Enable SLS Updates** box.
- b. Set as many as six Daily Updates.

**Note:**

The Daily Updates must be at least four hours apart.

- c. Click **Submit**.

12. Use the **Backup/Restore** page ([Figure 17](#)) to backup the PIM database backup schedule.

---

**Figure 17: Backup/Restore page**

### Backup/Restore

#### Backup

To backup all current device profiles, templates, groups, authorization sets, jobs, and system settings, click **Backup Now**.

Include System Log in backup

**Backup Now...**

#### Restore

To restore PIM data from a backup file, you must first exit PIM and then run the PIM Restore utility located on the PIM server:

**C: Program Files-->Avaya-->Provisioning-->PIM-->PIM Restore**



**Warning:** Running PIM Restore will replace all current PIM data with the data from the backup file.

---

#### Note:

Step 12 backs up the PIM database. Avaya encourages users to set a PIM backup schedule/policy independent of the SLS implementation.

#### Note:

If you require the use of the Incoming Call Handling Treatment option for adding/deleting the incoming dial pattern on incoming trunk calls, this route pattern must be modified using the CLI. There are NO equivalent commands in the PIM wizard screens.

---

## Enabling and disabling SLS

To enable SLS on the G450, enter **set sls enable**. The G450 responds with the message `Survivable Call Engine is enabled`.

To disable SLS on the G450, enter **set sls disable**. The G450 responds with the message `Survivable Call Engine is disabled`.

#### Note:

If you enable SLS and then performed additional administration, you must first disable SLS and then re-enable it. This will cause the SLS application to resynchronize its administrative database with the gateway's global CLI command database.

### Activating changes in SLS

To activate changes you make in SLS, you must use the disable and enable SLS commands together. Thus, to activate changes in SLS, perform the following steps:

1. Make any changes to SLS administration desired.
2. While still in SLS mode, enter **set sls disable**.  
The G450 responds with the message `Survivable Call Engine is disabled`.
3. Enter **set sls enable**.  
The G450 responds with the message `Survivable Call Engine is enabled`.

---

### Using the CLI to manually configure SLS administration on the gateway

It is recommended to use PIM to configure the SLS data. However, if PIM is unavailable, you can also configure the SLS data from the G450 itself.

#### Prerequisites

- The Communication Manager Release 4.1 is running on the host server
- PIM or configuration of the G450 through its CLI
- The G450 is registered with Avaya Communication Manager
- The SLS is enabled on the G450 through its CLI
- S8300 is not serving as an LSP
- G450 is not subtending to another external server (including ESS or another LSP in another gateway)

#### Planning and preparing the SLS data set

It is recommended to plan the SLS coverage and gather information from Avaya Communication Manager before creating the SLS administration data set at the gateway command line. Strategic selection of the stations and trunks that participate in SLS can ensure that vital communications are spared interruptions caused by network outages.



**⚠ Important:**

Since you can administer your system for SLS either from the SAT or from the gateway CLI, the two administration tasks must be synchronized with common data and port usage as well as system-defined capacities. For example, if a physical DCP station port number 10 is not administered on the Communication Manager server, even though the gateway's SLS engine has that port administered, the port is unusable during SLS operation on the gateway. This is because the hardware port configuration on the media modules is initially configured by CM in subtending gateway mode, by using the H.248 control channel to push information down to the gateway.

**SLS capacities**

The following table lists the SLS capacities:

**Table 30: SLS capacities**

Gateway model	IP stations	Analog stations	DCP stations	Analog trunks	BRI trunks	DS1 trunks
G450*	240	The maximum number of legacy stations/trunks that may be supported is dependent upon the slot-module configuration of what is installed.				

\* 340 stations maximum (all types)

You can collect the Communication Manager data using the CM administrative SAT interface. For instructions on accessing the Avaya Communication Manager through the G450, see [Accessing the registered MGC](#) on page 87.

**Collecting analog stations data**

1. At the SAT, enter `list media-gateway` to display a list of administered gateways.
2. Look for supported gateways in the **Type** field.
3. Once you know the media gateway of interest, match the gateway model with the analog station ports:

**Table 31: Matching the gateway with the analog station ports**

Gateway model	Media module (if applicable)	Slot configuration
G450	MM711 MM714 MM716	

## Configuring Standard Local Survivability (SLS)

4. At the SAT, enter **display port *port-number***, where *port-number* is the analog station port on the gateway.

The system displays the extension number assigned to the port.

5. Once you know the extension, enter **display station *extension*** to display the **Station** form for this extension.
6. Gather the necessary information from [Table 32](#).

**Table 32: Analog station form data to assemble for SLS**

Page *	Field Name	Notes
1	Extension	
1	Port	The port address correlates the analog stations that belong to a particular media gateway. If the port ID includes the media gateway number, then it is accepted. A new station slot/port entry must include the "V", as in "V305".
1	Type	Only 2500 is the accepted Type
1	Survivable COR	Class of Restriction while in SLS mode
1	Survivable Trunk Dest	Trunk destination while in SLS mode
2	Switchhook Flash	This field appears when Type is 2500
1	Name	This is the user's name

\* Page numbers might vary for your system.

### Collecting DCP stations data

1. At the SAT, enter **list media-gateway** to display a list of administered gateways.
2. Look for supported gateways in the **Type** field.
3. Once you know the media gateway of interest, match the gateway model with the digital station ports:

**Table 33: Matching the gateway with the digital station ports**

Gateway model	Media module (if applicable)	Slot configuration
G450	MM712 MM717	

4. At the SAT, enter **display port *port-number***, where *port-number* is the DCP station port on the gateway.

The system displays the extension number assigned to the port.

5. Once you know the extension, enter **display station extension** to display the **Station** form for this extension.
6. Gather the necessary information from [Table 34](#).

**Table 34: DCP station form data to assemble for SLS**

Page *	Field Name	Notes
1	Extension	
1	Port	The port address correlates the DCP stations that belong to a particular media gateway. If the port ID includes the media gateway number, then it is accepted. A new station slot/port entry must include the "V", as in "V401".
1	Security Code (Optional)	This value is the shared secret between Communication Manager and the media gateway, and is used for the registration of an IP Softphone (RoadWarrior)
1	Type	2402 2410 2420 6402 6402D 6408 6408+ 6408D 6408D+ 6416D+ 6424D+ 8403B 8405B 8405B+ 8405D 8405D+ 8410B 8410D 8411B 8411D 8434D
1	Survivable COR	Class of Restriction while in SLS mode
1	Survivable Trunk Dest	Trunk destination while in SLS mode

**1 of 2**

**Table 34: DCP station form data to assemble for SLS (continued)**

Page *	Field Name	Notes
1	Expansion Module	Determines if optional CA module is connected to this phone model
1	Name	This is the user's name
<b>2 of 2</b>		

\* Page numbers might vary for your system.

### Collecting IP stations data

1. At the SAT, enter **list media-gateway** to display a list of administered gateways.
2. Look for supported gateways in the **Type** field.
3. Enter **display media-gateway**.
4. Read the reported IP address for this gateway.
5. Enter **list node-name** and compare the IP address of the media gateway in the list with the IP address of the gateway that you are administering for SLS. When you find a match in the **node-name** form, read the assigned node-name. This will be used to do a pattern match with a field on the **IP Station** form in Step 6.
6. Enter **list station type type**, where **type** is one of the supported IP stations.  
 The report lists all IP phones that could have the **Survivable GK Node-Name** administered to the target media gateway. The **Survivable GK Node-Name** uniquely associates an IP phone with a particular media gateway.
7. Once a match is made between the station form's Survivable GK Node-Name and the target gateway's Node-Name, gather the values for the given IP station per [Table 35](#).

**Table 35: IP station form data to assemble for SLS**

Page *	Field Name	Notes
1	Extension	
1	Security Code (IP only)	This value is the shared secret between Communication Manager and the media gateway used for the registration of the IP endpoint
<b>1 of 2</b>		

Table 35: IP station form data to assemble for SLS (continued)

Page *	Field Name	Notes
1	Type	4601 4602 4602SW 4606 4610SW 4612 4620 4620SW 4621 4622 4624 4625
1	Survivable COR	Class of Restriction while in SLS mode
1	Survivable Trunk Dest	Trunk destination while in SLS mode
1	Expansion Module	Determines if optional CA module is connected to this phone model
1	Name	This is the user's name
		<b>2 of 2</b>

\* Page numbers might vary for your system.

### Collecting trunk groups data

1. At the SAT, enter **list media-gateway** to display a list of administered gateways.
2. Look for supported gateways in the **Type** field.
3. At the SAT, enter **display media gateway** to view the media modules that are assigned to the various slots. Use [Table 49](#) as a reference to identify how the particular media module has been configured for serving as a trunk port, and then use the various **list** commands on CM to look for physical port matches in the various trunk SAT forms in order to discover what translation information is needed.
4. Identify the analog trunk ports. Refer to [Table 50](#).
5. Identify the BRI trunk ports. Refer to [Table 51](#).
6. Identify the digital DS1 trunk ports. Refer to [Table 51](#).
7. Identify the G450 modules and check for provisioned trunk ports.

## Configuring Standard Local Survivability (SLS)

- At the SAT, enter `display port portid`, where `portid` is the trunks port on the target gateway.

The system reports the Trunk Group Number/Member Number for this particular port.

- Once you know the Trunk Group Number, gather trunk-group information according to [Table 36](#).

**Table 36: Trunk group data to assemble for SLS**

Page *	Field Name	Notes
1	Group Type	This field specifies the type of trunks associated with this trunk group
1	Outgoing Dial Type	The only acceptable values are <code>tone</code> and <code>rotary</code> . If the field is set to <code>automatic</code> or <code>mf</code> , then the value of <code>tone</code> is used instead. Note that this does not apply to DS1 PRI links.
1	Trunk Group Number	This value is used in the routing table
1	TAC	This value is only necessary if the <b>Dial Access?</b> field is set to <code>y</code> . If that field is set to <code>n</code> , the TAC value is not pushed down to the media gateway.
4	Port	There may be more than one port within a trunk group definition that pertains to a given media gateway
1	Digit Treatment	This only applies for DID analog trunks or for DS1 tie trunks. Note that this does not apply to DS1 PRI tie trunks.
1	Digits	This field contains a value only when the <b>Digit Treatment</b> field is set to <code>insert1</code> , <code>insert2</code> , <code>insert3</code> , or <code>insert4</code>

**1 of 3**

Table 36: Trunk group data to assemble for SLS (continued)

Page *	Field Name	Notes
1	Trunk Type	Depends on trunk signaling type: <ul style="list-style-type: none"> <li>● Analog trunks: <ul style="list-style-type: none"> <li>- Loop-start</li> <li>- Ground-start</li> <li>- DID</li> </ul> </li> <li>● In-Band DS1 trunks with CO Group-Type: <ul style="list-style-type: none"> <li>- Loop-start</li> <li>- Ground-start</li> </ul> </li> <li>● In-Band DS1 trunks with Tie Group-Type: <ul style="list-style-type: none"> <li>- Wink/wink</li> <li>- Wink/immediate</li> <li>- Wink/auto</li> <li>- Immediate/Immediate</li> <li>- Auto/auto</li> <li>- Auto/wink</li> </ul> </li> </ul>
1	Group Name	Customer identification of trunk group
1	Codeset to Send Display	Describes which Q.931 code-sets are allowed to send Display IEs
1	Codeset to Send National IEs	Describes which Q.931 code-sets are allowed to send National supported IEs
2	Outgoing Channel ID Encoding	Used for encoding Channel ID IE
1	Digit Handling (in/out)	Defines overlap receiving and transmitting rules
2	Network (Japan) Needs Connect Before Disconnect	Sends a CONNECT message before sending a DISCONNECT message, if enabled
2	Send Name	Specifies whether the Group Name is to be specified with the message sent while connecting to the network
2	Send Calling Number	Specifies whether the Trunk Group Number is to be specified with the message sent while connecting to the network
<b>2 of 3</b>		

**Table 36: Trunk group data to assemble for SLS (continued)**

Page *	Field Name	Notes
2	Incoming Calling Number - Format	Specifies how to fill the Calling Party Number and Called Party Number IEs
1	Incoming Destination	Sets a destination station for routing incoming trunk group calls
1	Trunk Hunt	Determines the method in which the survivable-call-engine selects an available trunk from the trunk group pool
6	Sig Grp	Specifies the Signaling Group Number that is the manager of this ISDN trunk member
<b>3 of 3</b>		

\* Page numbers might vary for your system.

### Collecting DS1 trunks data

1. At the SAT, enter **display ds1 location** to display the DS1 administration for a particular circuit pack **location**.
2. Gather DS1 information according to [Table 37](#) for each DS1 facility.

**Table 37: DS1 circuit pack data to assemble for SLS**

Page *	Field Name	Notes
1	Name	Descriptive name often of the Service Provider or destination of the DS1 facility
1	Bit-Rate	Selects the maximum transmission rate of the DS1 facility
1	Signaling Mode	Selects the signaling method deployed on the given DS1 facility
1	Channel Numbering	E1 interface for ETSI and QSIG require sequential encoding from 1 to 30 This field appears when <b>Signaling Mode = isdn-pri</b> <b>Bit Rate = 2.048</b> <b>Connect = pbx</b>
1	Connect	Specifies what is connected at the far-end of the DS1 facility
1	Interface	Determines glare handling
<b>1 of 2</b>		



Table 37: DS1 circuit pack data to assemble for SLS (continued)

Page*	Field Name	Notes
1	Side	Specifies QSIG glare handling when the <b>Interface</b> field is set to <b>peerslave</b>
1	Country Protocol	Specifies the Layer 3 signaling protocol used by the country-specific service provider
1	Protocol Version	Used in countries whose public networks allow multiple Layer 3 signaling protocols for ISDN PRI service
1	DCP/Analog Bearer Capability	Sets the Information Transfer capability in the Bearer Capability IE of the SETUP message
1	Interface Companding	Specifies the companding mode used by the far-end switch
1	ITN-C7 Long Timers	Specifies whether the duration of Q.931 timers (T302 and T302) is to be extended. This is only required for Russian telecom applications or if <b>Signaling Mode = isdn-pri</b> .
<b>2 of 2</b>		

\* Page numbers might vary for your system.

- Repeat the **display ds1 location** command and press **Enter** for each circuit pack that you want to included in the SLS data set.

### Collecting signaling groups data

Collect the information from the **Communication Manager Signaling Group** form ([Table 38](#)) for ISDN-PRI administration only.

Table 38: ISDN-PRI administration data to assemble for SLS

Page*	Field Name	Notes
1	Trunk Group for Channel Selection	Trunk group reference number association with trunk group table
1	Associated Signaling	Specifies whether the D-channel is physically associated in the DS1 facility. The 'enabled' setting is when there is a D-channel present.
1	Primary D-channel	Specifies the gateway port ID where the D-channel is located. For the gateways, the first component is the three digit gateway number, followed by a 'v', the slot number, and 24 (T1) or 16 (E1).
<b>1 of 2</b>		

**Table 38: ISDN-PRI administration data to assemble for SLS (continued)**

Page *	Field Name	Notes
1	Trunk Board	This is needed only if the Associated Signaling is set to <b>no</b> . Specifies the gateway port ID where the D-channel is located. For the gateways, the first component is the three digit gateway number, followed by a 'v', and one numeric character for the slot number.
1	Interface Id	This is needed only if the Associated Signaling is set to <b>no</b> . Specifies the channel of the DS1 circuit that carries the D-channel for ISDN signaling. This is an integer from <b>0</b> through <b>31</b> .

**2 of 2**

\* Page numbers might vary for your system.

### Collecting administered ISDN-BRI trunks data

1. At the SAT, enter **display bri-trunk-board location** to display the DS1 administration for a particular circuit pack **location**.
2. Gather ISDN-BRI administration information in [Table 39](#) for each **location**.

**Table 39: ISDN-BRI administration data to assemble for SLS**

Page *	Field Name	Notes
1	Name	Descriptive name often of the Service Provider or destination of BRI facility
1	Interface	Determines glare handling
1	Side	QSIG glare handling, when the <b>interface</b> field is peerSlave
1	Country Protocol	Specifies the Layer 3 signaling protocol used by the country-specific service provider
1	DCP/Analog Bearer Capability	Sets the Information Transfer capability in the Bearer Capability IE of the SETUP message
2	Companding Mode	Specifies the companding mode used by the far end switch
1	TEI	LAPD address assignment for the <b>TEI</b> field
2	Directory Number A	Channel B1's directory number
2	Directory Number B	Channel B2's directory number

**1 of 2**

Table 39: ISDN-BRI administration data to assemble for SLS (continued)

Page*	Field Name	Notes
2	SPID-A	Service Profile Identifier required for Country Code (USA)
2	SPID-B	Service Profile Identifier required for Country Code (USA)
2	Endpt Init	Determines whether the far end supports endpoint initialization
1	Layer 1 Stable	Determines whether to expect the network to drop BRI Layer 1 when no calls are active
		<b>2 of 2</b>

\* Page numbers might vary for your system.

### Collecting Feature Access Codes data

1. At the SAT, enter **display system-parameters customer-options** to display the **Customer Options** form.
2. Scroll to page 5 and determine how the **Multinational Locations** or **Multiple Locations** fields are set:
  - If either of these fields is set to **y** (enabled), then proceed to Step 3.
  - If these fields are set to **n** (disabled), at the SAT, enter **display feature-access-codes** and gather the FAC information listed in [Table 40](#).
3. Look up the location of the gateway, as follows:
  - a. At the SAT, enter **list media-gateway** to get the gateway's number.
  - b. At the SAT, enter **display media gateway number**, where **number** is the gateway number you obtained in Step a. This provides you with the **location** field value.
    - If the gateway has an administered location, at the SAT, enter **display locations number**, where **number** is the administered location number. If there is an ARS entry for the given location, you must use this value exclusively in the SLS data set.
    - If there is no administered location, at the SAT, enter **display feature-access-codes** and gather the FAC information listed in [Table 40](#).

**Table 40: Feature Access Codes to assemble for SLS**

Page	Field Name	Notes
1	Contact Closure Open Code	Used to open a contact closure relay
1	Contact Closure Close Code	Used to close a contact closure relay
1	Contact Closure Pulse Code	Used to pulse a contact closure relay
1	Auto Route Selection (ARS) Access Code1	Specifies the first access code for ARS table routing
1	Auto Route Selection (ARS) Access Code2	Specifies the second access code for ARS table routing
1-16	ARS FAC	This is used instead of the <b>Features</b> form ARS FAC entry if the “Loc No.” that correlates to the gateway has an entry in this form, which overrides the general ARS FAC(s)
1	CAS Remote Hold/ Answer Hold-Unhold Access Code	Specifies the dial access code to provision a hold bridge on the call involving this station user. Successive access to this dial code causes the feature to toggle between the Hold and the Unhold states

**Collecting System parameters data**

1. At the SAT, enter **list media-gateway** to display a list of administered gateways.
2. Look for supported gateways in the **Type** field.
3. Once you have determined the media gateway of interest, note its IP-Network-Region.
4. At the SAT, enter **display ip-network-region n**, where **n** is the gateway’s administered IP-Network-Region.  
Read the **Codec-set** field value from the **IP Network Region** form.
5. At the SAT, enter **display ip-codec-set n**, where **n** is the **Codec-set** field value from the **IP Network Region** form.  
The report lists the supported codes in the **Audio Codec** field (summarized in [Table 41](#)).

**Note:**

SLS only supports G.711 mu/A-law.

6. At the SAT, enter **display system-parameters features** to display the **Feature Related System Parameters** form.
7. Scroll to page 10 and read the value of the **Date Format on Terminals** field (summarized in [Table 41](#)).

8. At the SAT, enter **display media-gateway n**, where **n** is the administered number of the media gateway of interest, to display the **Media Gateway** form.
9. Read the **Max Survivable IP Ext** field value (summarized in [Table 41](#)).

**Table 41: General system parameters data to assemble for SLS**

CM Form	Page	Field Name	Notes
Ip-codec-set	All	All fields	There can be up to 7 distinct codec-sets in use in the system. However, only one codec set is active for the network region in which the gateway is located. SLS only supports two codecs: <ul style="list-style-type: none"> <li>● G.711 A-law</li> <li>● G.711 U-law</li> </ul>
System-parameter features	10	Date Format on Terminals	Applies to 64xx and 24xx DCP terminals, and to 46xx IP terminals
Media Gateway	1	Max Survivable IP Ext	Maximum IP phone registrations allowed

### Collecting ARS dial patterns data

To gather the route patterns and ARS analysis in Communication Manager, you must first know which trunk groups are assigned to the gateway of interest. After verifying this information, perform the following steps:

1. At the SAT, enter **list route-pattern trunk-group n**, where **n** is an administered trunk group, to display the administered route pattern(s).
2. For the first preference for this route-pattern entry, read the values of the following fields (described in [Table 42](#)):
  - **No Deleted Digits**
  - **Inserted Digits**
3. At the SAT, enter **list ars analysis** to search the ARS Analysis table for row entries whose **Route Pattern** field matches the route-pattern value(s) that were obtained in Step 1. Once you discover a match with **Route Pattern**, use the entries from this row in the ARS Analysis table to complete the following three entries for the SLS Dial-Pattern table (see [Table 42](#)):
  - **Min**
  - **Max**

## Configuring Standard Local Survivability (SLS)

- **Dialed String**

**Table 42: ARS Dial Patterns for SLS**

CM Form	Page	Field Name	Notes
Route-Pattern	1	No. Del Digits	Specifies the number of dialed digits to be deleted from the beginning of the dialed string. The default is 0.
Route-Pattern	1	Inserted Digits	Specifies the digit string to be inserted at the beginning of the dialed string. The default is blank.
ARS Analysis	1	Dialed String	Dial string entry that is used to match a pattern within the user-dialed number
ARS Analysis	1	Min	Minimum length of the user-dialed number that the SLS call engine collects to match to the dialed-string. The default is the length of the specified dialed-string element.
ARS Analysis	1	Max	Maximum length of the user-dialed number that the SLS call engine collects to match to the dialed-string. The default is the length of the dialed-string element.

### Collecting Incoming Call Handling data

To gather the Incoming Call Handling Treatment and ARS Digit Conversion information in Communication Manager, you must first know which trunk groups are assigned to the gateway of interest. After verifying this information, perform the following steps:

1. At the SAT, enter **display inc-call-handling-trmt trunk-group n**, where **n** is an administered trunk group.
2. For each entry, read the values of the following fields (see [Table 43](#)):
  - **Called Number**
  - **Called Length**
  - **Del**
  - **Insert**

Table 43: Incoming call handling data to gather for SLS

CM Form	Page	Field Name	Notes
Incoming Call Handling Treatment	1	Called Number	Dial string entry that is used to match a pattern on inbound trunk calls
Incoming Call Handling Treatment	1	Called Len	Maximum length of the user-dialed number that the SLS call engine collects to match to the dialed string. The default is that the minimum length is defined to be equal to the length of the dialed string.
Incoming Call Handling Treatment	1	Del	Specifies the number of dialed digits to be deleted from the beginning of the string. The default is 0.
Incoming Call Handling Treatment	1	Insert	Specifies the digit string to be inserted at the beginning of the dialed string. The default is blank.
Trunk Group	1	Digit Handling (In/Out)	Defines the overlap receiving rules. Needed to set the <b>mode</b> field in the IncomingRouting table. The default is enbloc.

## Configuring the SLS data through the CLI

The command line interface (CLI) has a root-level context of `s1s` for administering the SLS data set. After you enter `s1s` at the CLI prompt, the prompt changes to indicate that you are in the `s1s` context. Once in this context, seven additional sub-contexts provide for station and trunk administration, minimizing the need to type in a long command string:

- `station` context that is invoked by entering `station extension class` to enter a second-level sub-context for administering stations
- `trunk-group` context that is invoked by entering `trunk-group tgnum group-type` to enter the second-level sub-context for administering trunk groups
- `ds1` context that is invoked by entering `ds1 port-address` to enter the second-level sub-context for administering DS1 trunks
- `sig-group` context that is invoked by entering `sig-group sgnum` to enter the second-level sub-context for administering signaling groups

## Configuring Standard Local Survivability (SLS)

- `bri` context that is invoked by entering **`bri port-address`** to enter the second-level sub-context for administering ISDN BRI links
- `dial-pattern` context that is invoked by entering **`dial-pattern dialed-string`** to enter the second-level sub-context for administering dial pattern strings
- `incoming-routing` context that is invoked by entering **`incoming-routing tgnum mode pattern length`** to enter the second-level sub-context for administering incoming routing

Enter **`exit`** to leave the second-level sub-contexts and return to the `(super-sls) #` context. See [Table 52](#) for a complete hierarchical listing of all SLS CLI commands.

### Note:

Review [Table 52](#) in its entirety before proceeding with SLS administration. This summary of SLS commands guides you in understanding the various sub-commands of each sub-context.

## Creating the SLS administration data set on the media gateway

1. Log on to the gateway.
2. To administer the name, enter **`set system name name`**, where **`name`** is typed inside quotation marks(""). To remove the administered name, enter **`set system name`**, and then rename the gateway using the **`set system name`** command.

### Note:

The gateway's administered name must match the name in the Communication Manager administration.

3. At the gateway command prompt, enter **`sls`** to begin entering SLS data.  
The command line prompt changes to `(super-sls) #` to indicate that you are in SLS data entry mode. Entering **`exit`** ends the SLS data entry mode session, and the command line prompt returns to its original state.
4. Enter **`set pim-lockout yes`** to prevent Provisioning and Installation Manager (PIM) updates while you are working on SLS administration of the gateway.
5. If you want to change the maximum allowable IP registrations from the default, enter **`set max-ip-registrations n`**, where **`n`** is from 1 to 240.
6. Use the **`set date-format`** command to set a date format for the SLS data set.
7. Use the **`set ip-codec-set`** command to select the country-specific G.711 codec set within the SLS data set: `g.711mu` or `g.711a`.



8. Administer the slot configuration information by entering **set slot-config slot-number board-type**, where *slot-number* is the slot where the Media Module is located and *board-type* is the Media Module type (see [Table 44](#)).

**Table 44: Media Modules supporting SLS for the G450**

Media Module	Description	Permitted Slots
MM710	One T1/E1 trunk port	v1, v2, v3, v4, v5, v6, v7, v8
MM711	Eight universal analog ports	v1, v2, v3, v4, v5, v6, v7, v8
MM712	Eight DCP telephone ports	v1, v2, v3, v4, v5, v6, v7, v8
MM714	Four analog trunk ports and four analog station ports	v1, v2, v3, v4, v5, v6, v7, v8
MM716	24 analog telephone/DID trunk ports	v1, v2, v3, v4, v5, v6, v7, v8
MM717	24 high-density DCP telephone ports	v1, v2, v3, v4, v5, v6, v7, v8
MM720	Eight BRI trunk ports	v1, v2, v3, v4, v5, v6, v7, v8
MM722	Two BRI trunk ports	v1, v2, v3, v4, v5, v6, v7, v8

9. Administer the station information. Refer to [Administering Station parameters](#) on page 163.
10. Administer DS1 trunks as required. Refer to [Administering DS1 parameters](#) on page 166.
11. Administer BRI links as required. Refer to [Administering BRI parameters](#) on page 171.
12. Administer the trunk groups. Refer to [Administering trunk-group parameters](#) on page 173. Note that you can add members to the trunk group only after you administer the signaling group information.
13. Administer the signaling groups. Refer to [Administering signaling-group parameters](#) on page 180.
14. Administer ARS dial patterns for outgoing calls. Refer to [Administering dial-pattern parameters](#) on page 181.
15. Administer digit treatment for incoming routed calls. Refer to [Administering incoming-routing parameters](#) on page 182.
16. Optionally administer the attendant feature for the purpose of call routing by entering **set attendant access-code extension**, where *access-code* specifies the dial access code for the attendant feature, and *extension* specifies the station which serves as the branch office attendant position. Incoming trunk calls that have dialed strings that cannot be completely routed, will now be routed by SLS to this attendant position. In addition, stations in the branch office may directly dial the attendant using the *access-code*.

## Configuring Standard Local Survivability (SLS)

17. Administer the Feature Access Codes (FACs) by entering **set fac feature fac**, where **feature** is one of the following:

- `ars1`
- `ars2`
- `hold`
- `contact-open`
- `contact-close`
- `contact-pulse`

and **fac** is a 1-4 digit string that includes the digits 0 through 9 (excluding \* and # for analog rotary phones). The **fac** string must be unique and must not conflict with station extension numbers and Trunk Access Codes (TACs).

### Examples

- **set fac ars2 \*9**
- **set fac contact-close 8**

### Note:

The "\*" and "#" characters are not available on rotary-dial, analog phones.

18. Enter **set pim-lockout no** to allow Provisioning and Installation Manager (PIM) updates, since you finished SLS administration of the gateway.
19. At the gateway command prompt, enter **exit** to leave the `s1s` context.  
The gateway command prompt reverts to that of the original login.
20. After all of the SLS features are administered, at the gateway command prompt enter **set s1s enable** to enable SLS on the gateway.

### Note:

If you enabled SLS and then entered additional administration, you must first disable SLS by entering **set s1s disable**, and then re-enable it by entering **set s1s enable**. This will cause the SLS application to resynchronize its administrative database with the gateway's CLI command database.

21. At the gateway command prompt, enter **copy running-config startup-config** to save the changes.

## Administering Station parameters

1. At the gateway command prompt, enter **station extension class** to enter a second-level sub-context to administer each phone that you want covered by SLS. In this command, **extension** is a 1-13 digit numeric string that may begin with 0, and **class** is `analog`, `dcp`, or `ip`.

The command line prompt changes to `sls-station <extension>` to indicate that you are in the `station` context for SLS administration. Entering **exit** ends the station configuration mode, and the command line prompt returns to its original state. If you want to remove the station from the SLS administration, enter **clear extension extension** at the command line interface. Enter **exit** to leave the second-level `station` context to return to the `(super-sls)#` context.

### Example

- **station 1234567 ip** administers an IP phone with the extension "1234567".
2. Depending on the class (`analog`, `dcp`, or `ip`, set in Step 1), enter **set type model**, where **model** is a value from [Table 45](#).

**Table 45: Class values in SLS station context**

<b>analog</b>	<b>dcp</b>	<b>ip</b>
analog2500*	dcp2402	ip4601
	dcp2410	ip4602
	dcp2420	ip4602sw
	dcp6402	ip4610sw
	dcp6402D	ip4612
	dcp6408	ip4620
	dcp6408+	ip4620sw (default)
	dcp6408D (default)	ip4621
	dcp6408D+	ip4622
	dcp6416D+	ip4624
	dcp6424D+	ip4625
	dcp8403B	
	dcp8405B	
	dcp8405B+	
		<b>1 of 2</b>

**Table 45: Class values in SLS station context (continued)**

analog	dcp	ip
	dcp8405D	
	dcp8405D+	
	dcp8410B	
	dcp8410D	
	dcp8434D	
		<b>2 of 2</b>

\* Since there is just one entry, the *mode1* is optional; **analog2500** is the default value.

**Example**

- **set type ip4620** sets the previously-administered extension "1234567" as an Avaya 4620 IP phone.
3. For `analog` and `dcp` classes only (set in Step 1), enter **set port module-port** for this station, where *module-port* is a value in [Table 46](#).

**Note:**

This command is only required for stations that support physical media module ports.  
 If the class is `ip` (set in Step 1), you cannot run this command.

**Table 46: Module-port values in SLS station configuration mode**

Gateway	Media module	Analog station ports*	DCP
	MM711	8 possible ports	
	MM712		8 possible ports
G450	MM714	4 possible ports (ports 1-4)	
	MM716	24 possible ports	
	MM717		24 possible ports

\* You cannot select these modules/ports if they are already assigned as DID trunks.

## Examples

- If an MM711 is inserted into slot V3 and an analog station is to be administered for port #5, then **set port v305** sets the previously-administered analog station "1234567" to the fifth physical analog station port on the gateway's media module.
  - If an MM712 is inserted into slot V4 and a DCP station is to be administered for port #1, then **set port v401** sets the previously-administered dcp station "1234567" to the first physical DCP station port on the gateway's media module.
4. Enter **set cor cor** to set the class of restriction (COR) for this extension, where **cor** is one of the following:
- emergency
  - internal (default)
  - local
  - toll
  - unrestricted

There exists a hierarchical relationship among the calling-restriction categories. As you move from the most restricted COR (*emergency*) to the least restricted (*unrestricted*), each level increases the range of dialing abilities. For example, *toll* includes the dialing privileges of *local*, *internal*, and *emergency*. See [Figure 13](#) for the hierarchical relationship among the COR permissions.

### Example

- **set cor unrestricted** gives a station unrestricted dialing.
5. If this station is administered to be included into a pool of stations that are allowed to receive incoming analog loop-start trunk calls, enter **set trunk-destination yes**.
6. If this is an IP phone (set in Step 1), enter **set password password**, where **password** is from four to eight digits in length, to administer a password. The phone will automatically register to the gateway upon failure if the password and the extension number are the same as those administered in the CM.

### Note:

Passwords are not required for analog or DCP phones unless an IP Softphone is using the administrative identity of a DCP phone, in which case the password is required.

### Example

- **set password 53136** establishes the password "53136" on a previously-administered IP phone.
7. To enable DCP or IP phones (set in Step 1) to have an expansion module, enter **set expansion-module yes**.
8. For analog phones (set in Step 1) that you want SLS to recognize the switchhook flash signal (which offers subsequent transfer features), enter **set swhook-flash yes**.

## Configuring Standard Local Survivability (SLS)

9. Enter **set name name** to identify the user name for the station. Use the 1-27 character name as specified on the **Communication Manager** form. Type the name string inside double quotes.
10. Enter **show** to check the station administration of the station being programmed.

The report lists the station parameters. For example:

Extension	Type	Port	Cor	Trunk-Des	Exp-Mod	Flash	Password
49139	ip4620	IPaddr	local	y	n	-	*****
ip station registered at address 'aaa.bbb.ccc.ddd'							

### Note:

For currently-registered IP phones or IP Softphones, the IP address is displayed.

11. Enter **exit** to leave the `station` context in SLS.

## Administering DS1 parameters

1. Enter **ds1 slot-address**, where **slot-address** is any permitted port.

The command line prompt changes to `super-sls/ds1-<port-address>`. If you want to remove the ds1 trunk from the SLS administration, enter **exit** to leave the second-level `ds1` context and return to the `(super-sls) #` context, and then enter **clear ds1 slot-address**.

### Note:

If configuration changes affecting trunk provisioning (such as, signaling and bit-rate) are made to a DS1 trunk where the trunk and its associated signaling group have already been provisioned, an error message instructs you that the "Administrative change is in violation with existing trunk member provisioning", and the configuration change is rejected.

2. Enter **set name name** to identify the user name for the DS1 trunk. Use the 1-27 character name as specified on the **Communication Manager** form (**add trunk-group n**). Type the name string inside double quotes.
3. Enter **set bit-rate rate** to set the maximum transmission rate in Mbps for the DS1 facility. The rate can be either 1544 (T1) or 2048 (E1).
4. Enter **set signaling-mode mode-type** to set the signaling mode for the DS1 facility, where **mode-type** is one of the following values:
  - `cas`. Out-of-band signaling for E1 service, yielding thirty 64 kbps B-channels for voice transmission
  - `robbed bit`. In-band signaling for T1 service, yielding twenty-four 56 kbps B-channels for voice transmission
  - `isdnpri`. T1 or E1 ISDN Primary Rate service (supports both FAS and NFAS)

- *isdnext*. NFAS T1 or E1 ISDN service for:
  - T1 facility, in which all 24 channels are for bearer transport
  - E1 facility, in which all 31 channels are for bearer transport
- 5. Enter **set channel-numbering method** to select the channel-numbering method for B-channels on an E1 interface, where *method* is one of the following values:
  - *seq*. Sequential codes of B-channels 1-30 in the ISDN Channel Identification IE
  - *tslot*. Timeslot method
- 6. Enter **set connect far-end** to specify the equipment at the far-end of the DS1 link, where *far-end* is one of the following values:
  - *host*. Data application (computer or server)
  - *lineside*. Terminal equipment (video multiplexer)
  - *network*. Central office
  - *pbx*. Private communication system (another pbx)
- 7. If the far-end equipment is specified as *pbx* (set in Step 6), enter **set interface glare-mode** to specify the glare-handling convention, where *glare-mode* can be one of the following values:
  - For non-QSIG calls:
    - *network*. If the gateway is connected to a host computer and encounters glare, it overrides the far-end
    - *user*. If the gateway is connected to a public network and encounters glare, it releases the circuit
  - For QSIG calls:
    - *peerMaster*. SLS overrides the other end when glare occurs
    - *peerSlave*. SLS releases the circuit when glare occurs
- 8. If the DS1 link is employed with ISDN, and the glare-handling convention is specified as *peerMaster* or *peerSlave* for the ISDN link (set in Step 7), enter **set side side** to specify the glare mode: either a or b.

## Configuring Standard Local Survivability (SLS)

9. If the DS1 link is employed with ISDN, enter **set country-protocol country-code** to specify the ISDN Layer 3 country protocol type, where **country-code** is one of the values in [Table 47](#):

**Table 47: ISDN Layer 3 country codes**

<b>Country Code</b>	<b>Country</b>
1	United States (AT&T mode, also known as 5ESS)
2	Australia (Australia National PRI)
3	Japan
4	Italy
5	Netherlands
6	Singapore
7	Mexico
8	Belgium
9	Saudi Arabia
10	United Kingdom (ETSI)
11	Spain
12	France (ETSI)
13	Germany (ETSI)
14	Czech Republic
15	Russia
16	Argentina
17	Greece
18	China
19	Hong Kong
20	Thailand
21	Macedonia
22	Poland
23	Brazil

**1 of 2**



**Table 47: ISDN Layer 3 country codes (continued)**

Country Code	Country
24	Nordic countries
25	South Africa
etsi	ETSI (no use of RESTART message)
qsig	QSIG
<b>2 of 2</b>	

10. For countries whose public networks allow for multiple ISDN Layer 3 country protocols for ISDN Primary Rate service, enter **set protocol-version option** to specify the mode (see [Table 48](#)). Verify that the protocol version matches the country specified in **set country-protocol** (set in Step 9).

**Table 48: ISDN Layer 3 country protocols for ISDN Primary Rate service**

Country code	Description	Possible Values
Country 1 (United States)	AT&T mode (also known as 5ESS)	a
	National ISDN-1	b
	Nortel mode (also known as DMS)	c
	Telecordia (NI-2)	d
Country 2 (Australia)	Australia National PRI	a
	ETSI	b
	invalid	c
	invalid	d
Country 10 (United Kingdom)	DASS	a
	ETSI	b
	invalid	c
	invalid	d
Country 12 (France)	French National PRI	a
	ETSI	b
	invalid	c
	invalid	d
<b>1 of 2</b>		

**Table 48: ISDN Layer 3 country protocols for ISDN Primary Rate service (continued)**

Country code	Description	Possible Values
Country 13 (Germany)	German National PRI	a
	ETSI	b
	invalid	c
	invalid	d
ETSI	Full message set, including RESTART	a
	No RESTART message	b
	invalid	c
	invalid	d
		<b>2 of 2</b>

11. If the DS1 link is employed with ISDN, enter **set bearer-capability bearer** to set the **Information Transfer Rate** field of the Bearer Capability IE, where **bearer** is one of the following values:
  - 3khz. 3.1 kHz audio encoding
  - speech. Speech encoding
12. Enter **set interface-companding type** to set the interface to agree with the companding method used by the far-end of the DS1 circuit for SLS mode, where **type** is one of the following values:
  - alaw. A-law companding
  - ulaw. U-law companding
13. Enter **set long-timer yes | no** to increase the duration of the T303 (call establishment) timer, where:
  - yes. The T303 timer is extended from 4 seconds to 13 seconds
  - no. The T303 timer remains at 4 seconds
14. Enter **show** to check the DS1 administration.  
The report lists the DS1 parameters. For example:

```

Name = 'Willow Steet 2'
DS1  Rate Signaling Channel Connect Interface Side Protocol Ver Bearer Cmpd Ltm
-----
v4 1544 isdnpri      seq network      user      a country1  a speech ulaw no
```

15. Enter **exit** to leave the ds1 context in SLS.

## Administering BRI parameters

1. Enter **bri slot-address**, where *slot-address* is any permitted port.  
 The command line prompt changes to `sls-bri <slot-address>`. If you want to remove the BRI link from the SLS administration, enter **exit** to leave the second-level `bri` context and return to the `(super-sls) #` context, and then enter **clear bri slot-address**.
2. Enter **set name name** to identify the user name for the DS1 trunk. Use the 1-27 character name, as specified on the **Communication Manager** form (**add trunk-group n**). Type the name string inside double quotes.
3. Enter **set interface glare-mode** to specify the glare-handling convention. *glare-mode* can be one of the following values:
  - For non-QSIG calls:
    - *network*. If the gateway is connected to a host computer and encounters glare, it overrides the far-end
    - *user*. If the gateway is connected to a public network and encounters glare, it releases the circuit
  - For QSIG calls:
    - *peerMaster*. SLS overrides the other end when glare occurs
    - *peerSlave*. SLS releases the circuit when glare occurs
4. If the BRI link is employed with ISDN, and the glare-handling convention is specified as **peerMaster** or **peerSlave** for the ISDN link (set in Step 3), enter **set side side** to specify the glare mode: either a or b.
5. If the BRI link is employed with ISDN, enter **set country-protocol country-code** to specify the ISDN Layer 3 country protocol type, where *country-code* is any the values listed in [Table 47](#).
6. If the BRI link is employed with ISDN, enter **set bearer-capability bearer** to set the **Information Transfer Rate** field of the Bearer Capability IE, where *bearer* is one of the following values:
  - *3khz*. 3.1 kHz audio encoding
  - *speech*. Speech encoding
7. Enter **set interface-companding type** to set the far-end companding method, where *type* is one of the following values:
  - *alaw*. A-law companding
  - *ulaw*. U-law companding

## Configuring Standard Local Survivability (SLS)

8. If the BRI link is employed with ISDN, enter **set tei-assignment *tei*** to select the method by which the Layer 2 (LAPD) protocol obtains its Terminal Endpoint Identification (TEI) address. *tei* is one of the following values:
  - *auto*. TEI is assigned by the network provider
  - *zero*. TEI is fixed administratively
9. Enter **set directory-number-a *number*** to assign a directory number to the B1 channel of the BRI link. *number* is the provisioned number received from the network provider. The *number* value must be identical to the number the network provider has assigned to the circuit.
10. Enter **set directory-number-b *number*** to assign a directory number to the B2 channel of the BRI link. *number* is the provisioned number received from the network provider. The *number* value must be identical to the number the network provider has assigned to the circuit.
11. Enter **set spid-a *number*** to assign an SPID to the B1 channel of the BRI link.
12. Enter **set spid-b *number*** to assign an SPID to the B2 channel of the BRI link.

### Note:

All BRI links must have SPIDs properly configured for the link to function. SPIDs are received from the network service provider.

13. If the BRI link is employed with ISDN, enter **set-endpoint-init {*yes* | *no*}** to determine whether or not the far-end supports endpoint initialization.
14. If the BRI link is employed with ISDN, enter **set layer1-stable {*yes* | *no*}** to determine whether or not to keep the physical layer active (stable) between calls. Some European countries require that the physical layer is deactivated when there is no active call.
15. Enter **show** to check the BRI administration.

The report lists the BRI parameters. For example:

```
Name = BRI-SLS1
BRI   Interface   Side   Country   Bearer   Compand   Endpt-Init   Layer1-Stable
---   -
v401   user           a     country1  speech   ulaw      yes           yes

Dir-NumberA  Dir-NumberB  Spid-A           Spid-B
-----
3033234567  3033234568  30332345671111  30332345681111
```

16. Enter **exit** to leave the `bri` context in SLS.

## Administering trunk-group parameters

1. Enter **trunk-group *tgnum* group-type**, where *tgnum* is any number from 1 to 2000 and *group-type* can be one of the following:
  - loop-start (analog)
  - did (analog)
  - ground-start (analog)
  - bri (ISDN basic rate)
  - t1-isdn (ISDN primary rate on 1.544 Mbps facility)
  - e1-isdn (ISDN primary rate on 2.048 Mbps facility)
  - t1-inband (non-ISDN rate on 1.544 Mbps facility)
  - e1-inband (non-ISDN rate on 2.048 Mbps facility)

The command line prompt changes to `super-sls/trunk-group-<tgnum>`. If you want to remove the trunk group from the SLS administration, enter **exit** to leave the second-level `trunk-group` context and return to the `(super-sls) #` context, and then enter **clear trunk-group *tgnum***.

You can create a trunk group that does not have any assigned members. Once a valid port is assigned as a trunk group member, this trunk group then becomes active and may be employed by SLS call processing for incoming/outgoing trunk operation. The slot-configuration table is used, together with the port capacity for the given module, to determine the validity of a port assignment at administration time.

As a result, there may not be more active trunk groups than there are physical trunk members within a given gateway. In addition, a combo-port may only be used for one active assignment. For example, the analog station/DID trunk ports may be either allocated to serve as an analog station or as an analog DID trunk, but not both.

The maximum limits for a given trunk type are defined by the slot-configuration assignment for the G450. The maximum number of ports allowed per interface module is defined in [Table 49](#).

**Table 49: G450 SLS group type assignments**

Group type	Media module	Number of ports/channels	Description of trunks that may be assigned
loop-start ground-start did	MM711	8	Ports 1-8

1 of 2

**Table 49: G450 SLS group type assignments (continued)**

Group type	Media module	Number of ports/channels	Description of trunks that may be assigned
loop-start ground-start	MM714	4	Ports 5, 6, 7, 8
did	MM714	4	Ports 1, 2, 3, 4
did	MM716	24	Ports 1-24
bri	MM720	16	Eight physical ports, each offering B1 and B2 channels
bri	MM722	4	Two physical ports, each offering B1 and B2 channels
t1-isdn	MM710	23	D-channel is associated with this facility (FAS)
t1-isdn	MM710	24	D-channel is not associated with this facility (NFAS), and the DS1's signaling-mode is set to <b>isdnext</b>
e1-isdn	MM710	30	D-channel is associated with this facility (FAS)
e1-isdn	MM710	31	D-channel is not associated with this facility (NFAS), and the DS1's signaling-mode is set to <b>isdnext</b>
t1-inband	MM710	24	T1 Robbed-bit signaling application
e1-inband	MM710	30	E1 CAS signaling application

**2 of 2**

**Example**

- **trunk-group 1 loop-start** establishes an analog loop-start trunk group number 1.
2. Enter **set dial dial-type**, where **dial-type** is either `rotary` or `dtmf`.

**Example**

- **set dial dtmf** establishes that the trunk group uses DTMF signaling.
3. Enter **set tac tac**, where **tac** is a 1-4 digit numeric value (plus initial # and \* on all but rotary dial phones) for this trunk's access code (TAC). The TAC value must be unique among all trunk groups, extension numbers, and ARS Feature Access Code (FAC) strings.

**Example**

- **set tac 88** establishes access to this trunk group by dialing "88".

4. Enter **add port module port sig-group** to specify the G450 port or media module port that is compatible with the device and/or media module (see [Table 50](#) for G450 analog trunks, and [Table 51](#) for G450 digital trunks).  
The **sig-group** argument is necessary for a digital ISDN-PRI trunk. It is an integer number from 1 to 650 that specifies the signaling group associated with the management of this trunk member.

**Note:**

You must administer the signaling group and DS1 information before you can add any ports to the trunk group.

**Note:**

You can assign the following maximum number of members to a trunk group:

- **G450 analog trunks** = 255 members
- **G450 digital trunks** = 255 members

**Table 50: Media Module-port values in SLS trunk-group context for the G450 (Analog Trunks)**

Group Type	Media Module	Number of Ports/Channels	Description
loop-start did ground-start	MM711	8	ports 1-8
loop-start ground-start	MM714	4	ports 5,6,7,8
did	MM714	4	ports 1,2,3,4
did	MM716	24	ports 1-24

**Table 51: Trunk port values in SLS trunk-group context for the G450 (Digital Trunks)**

Group Type	Media Module	Maximum Ports/Channels
bri	MM720	16
bri	MM722	4
t1-isdn	MM710	23 (FAS) 24 (NFAS)

**1 of 2**

**Table 51: Trunk port values in SLS trunk-group context for the G450 (Digital Trunks) (continued)**

Group Type	Media Module	Maximum Ports/Channels
e1-isdn	MM710	30 (FAS) 31 (NFAS)
t1-inband	MM710	24
e1-inband	MM710	30
<b>2 of 2</b>		

**Example**

- If an MM711 is inserted into slot V3 and an analog loop-start trunk is to be administered for port 4, then `add port v304` administers an analog loop-start trunk through port V304.

**Example**

- If an MM722 is inserted into slot V4 and an ISDN BRI trunk is to be administered for port 1, then `add port v401` adds a BRI trunk for the first physical port of the gateway’s media module to a trunk group using one B-channel of the BRI link.

**Note:**

You cannot mix BRI and PRI trunks within the same trunk group. If you attempt to assign more than the maximum number of trunks to a trunk group, an error message instructs you to delete a trunk member before adding a new trunk. A physical trunk can be a member of only one trunk group.

5. For an analog DID trunk group, enter `set supervision sup-type` to set the incoming signaling supervision mode. `sup-type` can be either `immediate` or `wink`.

**Example**

- `set supervision wink` assigns wink-start incoming signaling supervision to a DID trunk group
6. For a non-ISDN digital trunk (t1-inband or e1-inband), enter `set supervision sup-type` to set the incoming signaling supervision mode, where `sup-type` can be one of the following:
    - `loop-start`
    - `ground-start`
    - `wink-wink`
    - `wink-immediate`
    - `wink-auto`
    - `immediate-immediate`



- auto-auto
  - auto-wink
7. For an analog DID trunk group or DS1 non-ISDN tie trunk group, enter **set digit-treatment *digit-treat***, where *digit-treat* can be one of the following values:
- blank (use this value to prevent any absorb or insert digit treatment from being applied)
  - absorb1
  - absorb2
  - absorb3
  - absorb4
  - absorb5
  - insert1
  - insert2
  - insert3
  - insert4

### Examples

- **set digit-treatment *absorb1*** removes the first digit from the incoming DID trunk
  - **set digit-treatment *blank*** removes any digit treatment from the trunk group
8. For analog DID trunk groups or DS1 tie trunk groups, enter **set digits *digits*** to define the inserted digit string, where *digits* is the number of digits.

### Note:

The number of digits must comply with the *digit-treat* parameter in the **set digit-treatment** command. If the digit-treat parameter is *insert3*, then the digits parameter for this command must be three digits in length.

9. Enter **set name *name*** to identify the user name for the trunk group. Use the 1-27 character name as specified on the **Communication Manager** form (**add trunk-group *n***). Type the name string inside double quotes.
10. For ISDN trunks, enter **set codeset-display *codeset*** to identify which Q.931 codesets are allowed to send display information to the user phone: *codeset0*, *codeset6*, or *codeset7*.
11. For ISDN trunks, enter **set codeset-national *codeset*** to identify which Q.931 codesets are allowed to send National Information Elements (IEs, or display information) to the user phone: *codeset6* or *codeset7*.
12. For ISDN trunks, enter **set channel-preference *type*** to define how the **Channel Identification IE** field is encoded, where *type* can be one of the following:

## Configuring Standard Local Survivability (SLS)

- **exclusive.** The central office must have the ability to grant a call on this channel or reject the call attempt
  - **preferred.** The central office might offer the call request on another available channel
13. For ISDN trunks, enter **set digit-handling method** to define the order of reception/transmission to be considered with the flow of inbound/outbound:
- `enbloc-enbloc`
  - `enbloc-overlap`
  - `overlap-enbloc`
  - `overlap-overlap`

Enbloc requires sending the entire collected digit string in one block. Overlap sends the digits one at a time as they are collected.

14. For ISDN trunks, enter **set japan-disconnect yes / no** to specify whether to perform a disconnect sequence (CONNECT message followed by a DISCONNECT message).
15. For ISDN trunks, enter **set send-name method** to define whether or not the calling, connected, called, or busy party's administered name is sent to the network on outgoing or incoming calls. **method** can be one of the following:
- `no`. The name is not sent to the network for incoming or outgoing calls
  - `yes`. The name is sent to the network for incoming or outgoing calls
  - `restricted`. The name is sent to the network as "Presentation restricted"

**Note:**

For this release, specify **method** as **no**, since sending a Calling Party Name is a future feature.

16. For ISDN trunks, enter **set send-number method** to define whether or not the calling, connected, called, or busy party's administered number is sent to the network on outgoing or incoming calls. **method** can be one of the following:
- `no`. The number is not sent to the network for incoming or outgoing calls
  - `yes`. The number is sent to the network for incoming or outgoing calls
  - `restricted`. The number is sent to the network as "Presentation restricted"

**Note:**

For this release, specify **method** as **no**, since sending a Calling Party Number is a future feature.

17. For ISDN trunks, enter **set numbering-format type** to specify the numbering plan for this trunk in Standard Local Survivability (SLS). The numbering plan encodes the **Numbering Plan Indicator** and **Type of Number** fields in the Calling/Connected Party Number IE in the ISDN protocol. **type** can be one of the following:
  - unknown. Both the Numbering Plan Indicator and Type of Number are unknown
  - public. The Numbering Plan Indicator meets the E.164 standard and the Type of Number is national

**Note:**

The SLS application is intended to operate into PSTN trunk interfaces. For this reason, the only two choices for network numbering plans identification are `public` (E.464) and `unknown` (no particular plan).

For this release, specify **type** as `unknown` since SLS does not currently support an administrative table to calculate the Calling Party Number that is consistent with the numbering plan of the PSTN service provider.

18. For non-ISDN digital trunks, analog loop-start and analog ground-start trunks, enter **set incoming-destination extension** to identify an extension to directly receive an incoming trunk call, for example, an attendant or a voice response/recording system.
19. For non-ISDN digital trunks, enter **set incoming-dialtone yes | no** to specify whether to provide a dial tone in response to far-end trunk group seizures.
20. For a DS1 circuit, enter **set trunk-hunt type** to specify the trunk-hunting search within a facility in an ISDN trunk group or through a non-ISDN digital trunk group, where **type** is one of the following:
  - ascend. A linear search from the lowest to the highest numbered available channels
  - circular. A circular search beginning with the point at which the search previously ended. When the search has reached the top of the channel list, it resumes at the bottom of the list in wrap-around fashion
  - descend. A linear search from the highest to the lowest numbered available channels
21. Enter **show** to check the trunk-group administration.

The report lists the trunk-group parameters.

- The following example shows a gateway that has all four trunk members assigned to one trunk-group:

Group	Type	Dial	Tac	Supervision	Treat	Insert			
1	bri	-	*99		-	-	-		
Name = Willow Street 2									
Ports = v401,v402,v417,v418									
Codeset	Codeset	Channel	Digit	Japan	Send	Send	Number	Trunk	
Display	National	Preference	Handling	Discon	Name	Number	Format	Hunt	
codeset6	codeset6	exclusive	enbloc-enbloc	no	yes	yes	public	ascend	

## Configuring Standard Local Survivability (SLS)

- The following example shows a gateway that has twelve port members assigned as t1-inband signaling:

Group	Type	Dial	Tac	Supervision	Treat	Insert
1	t1inband	dtmf	*96	wink/immediate	-	-
Name = Willow Street 2						
Ports = v401,v402,v403,v404,v405,v406,v407,v408,v409,v410,v411,v412						
Incoming-Dest Incoming-Dial Trunk-Hunt						
-----						
		-	no	ascend		

22. Enter **exit** to leave the trunk-group context in SLS.

## Administering signaling-group parameters

1. Enter **sig-group *sgnum***, where ***sgnum*** is any number from 1 to 650.  
The command line prompt changes to `sls-sig-group <sgnum>`. If you want to remove the signaling group from the SLS administration, enter **exit** to leave the second-level `sig-group` context and return to the `(super-sls) #` context, and then enter **clear sig-group *sgnum***.
2. Enter **set trunk-group-chan-select *tgnum*** to specify the trunk-group number that accepts incoming calls where the **Information Channel Selection** field does not specify a preferred channel for bearer transport. This is useful if the signaling group controls more than one trunk group (in cases where you wish to manage a DS1 facility with more than one trunk group).
3. Enter **set primary-dchannel *circuit-number***, where ***circuit-number*** is an identifier for a gateway, slot, or T1/E1 circuit, to select the primary D-channel number. For the value of ***circuit-number***, you can use a 3-digit gateway identifier (for example, 005), a 2-character slot identifier (for example, v4), or a 2-digit circuit number (24 for T1-ISDN, 16 for E1-ISDN).
4. If your trunk is provisioned without a D-channel for signaling, enter **set associated-signaling no** to use Non-Facility Associated Signaling (NFAS).

### Note:

NFAS is primarily a feature for ISDN-T1 connections offered by service providers in North America and Hong Kong. However, it can also be used on private-network connections, and in that context it is possible to set up NFAS using ISDN-E1 interfaces.

If you are using NFAS, enter **add nfas-interface gateway module *interface-id***, where ***gateway*** is the 3-digit gateway identifier, ***module*** is the 2-character slot identifier, and ***interface-id*** is the DS1 circuit number associated with the NFAS group. The value of ***interface-id*** is received from the network service provider.

**Note:**

The North American Public Network Service Providers do not allow any part of a T1 to be shared outside of this NFAS-trunk group. In other words, they do not allow one of the T1 interfaces (of this NFAS group) to be fractionalized into two or more uses. It must be dedicated to this given customer. Therefore, the following usage rules apply:

- All members of an NFAS DS1 (that are administered) must belong to the same trunk-group
  - All members of this trunk-group must belong to a single signaling group
5. Enter **show** to check the signaling groups administration.

The report lists the signaling groups parameters. For example:

Sig-group	Tg-Select	Assoc-Sig	Prime-Dchan	Nfas-Modules/Nfas-Id
10	98	yes	005v424	-

6. Enter **exit** to leave the `sig-group` context in SLS.

## Administering dial-pattern parameters

1. Enter **dial-pattern *dialed-string***, where ***dialed-string*** is a dial pattern to be used on outgoing calls.

The command line prompt changes to `super-sls/dial-pattern <dialed-string>`. If you want to remove the incoming routing treatment from the SLS administration, enter **exit** to leave the second-level `dial-pattern` context and return to the `(super-sls)#` context, and then enter **clear dial-pattern *dialed-string***.

2. Enter **set type *dial-type***, where ***dial-type*** specifies the type of outbound call and the dialing privileges available for outbound calls. The following call types are available:
- `emer.` Emergency calls only
  - `fnpa.` 10-digit North American Numbering Plan calls
  - `hnpa.` 7-digit North American Numbering Plan calls
  - `intl.` Public-network international number calls
  - `iop.` International operator calls
  - `locl.` Public-network local number calls
  - `natl.` Non-North American Numbering Plan calls
  - `op.` Operator calls
  - `svc.` Service calls

## Configuring Standard Local Survivability (SLS)

### Note:

Each level of call includes the previous level's dialing privileges. For example, *loc1* has the calling privileges of *iop*, *intl*, etc. See [Figure 13](#) for an illustration of the relationship between the various dial types and the COR permissions.

3. Enter **set max-length length** to define the maximum length of the dialed string. This must be set prior to the minimum length if the minimum length is larger than the default value.
4. Enter **set min-length length** to define the minimum length of the dialed string.
5. Enter **set tgnum tgnum** to designate a trunk-group for which this dialed string is assigned.
6. Enter **set deny no** to permit stations to originate outgoing trunk calls.
7. At the command-line enter **set insert-digits digits** to define the digits to insert into a dialed string, if required.
8. Enter **set delete-digits digits** to define the number of digits to be deleted from a dialed string, if required.

### Note:

You may either insert or delete digits, but not both.

9. Enter **show** to check the outbound dial-pattern string administration.

The report lists the dial-pattern parameters. For example:

Dialed-String/Deny	Min/Max Length	Type	Trunk Group	Delete/Insert Digits
5381000/n	9/9	loc1	2	1/303
5385000/n	9/9	loc1	3	1/720

10. Enter **exit** to leave the dial-pattern context in SLS.

## Administering incoming-routing parameters

The incoming-routing parameters are useful for mapping DNIS numbers directly into the station extension numbers when the Service Provider's DNIS plan does not directly reflect the station extension number length used in the gateway's dial plan.

### Note:

Since the PIM application does not automatically extract this information from the CM's **SAT** screen for Incoming-Digit-Treatment-Handling, you must enter this SLS information via the gateway CLI interface.

1. Enter **incoming-routing tgnum mode**, where *tgnum* is an existing ISDN trunk group number and *mode* is the protocol used for receiving incoming digits. *mode* can be either **enbloc** or **overlap**.

The command line prompt changes to `sls-incoming-routing <tgnum>`. If you want to remove the incoming routing treatment from the SLS administration, enter **exit** to leave the second-level `incoming-routing` context and return to the `(super-sls) #` context, and then enter **clear internal-routing tgnum mode**.

2. Enter **set match-pattern pattern** to define the beginning digit pattern of an incoming alphanumeric dial string to be matched against.
3. Enter **set length length** to define the length of the dialed string.
4. If the *mode* is set to **enbloc** (in Step 1), you must:
  - Enter **set delete-digits digits** to define the number of digits to be deleted from a dialed string.
  - Enter **set insert-digits digits** to define the number of digits to be inserted at the beginning of a dialed string.
5. (Optional) If the *mode* is set to **overlap** (in Step 1), you may configure only one of the following options:

- Enter **set delete-digits digits** to define the number of digits to be deleted from a dialed string.

Or

- Enter **set insert-digits digits** to define the number of digits to be inserted at the beginning of a dialed string.

Note that this action takes place after the deletion task has been completed for the **enbloc**-receiving mode.

6. Enter **exit** to leave the `incoming-routing` context in SLS.
7. Enter **show** to check the incoming-routing administration.

The report lists the incoming-routing parameters for all dial patterns that have been administered. For example:

Match_pattern	Length	Del	Insert-digits	Mode	tgnum
234	7	3	5381000	enbloc	98
235	7	3	5381001	enbloc	99

## Summary of SLS configuration commands

For more information about these commands, see *Avaya G450 CLI Reference*, 03-300437.

Table 52: SLS CLI command hierarchy

Root Level Commands	First Level Context Commands	Second Level Context Commands	Description
<b>set sls</b>			Enable or disable SLS
<b>show sls</b>			Display SLS status: enabled or disabled
<b>sls</b>			Enter the <code>sls</code> context
	<b>bri</b>		Administer an ISDN Basic Rate Interface (BRI) port for SLS
		<b>set bearer-capability</b>	Set the <b>Information Transfer Rate</b> field of the Bearer Capability IE in SLS
		<b>set country-protocol</b>	Specify the ISDN Layer 3 country protocol type in SLS
		<b>set directory-number-a</b>	Assign a directory number to the B1 channel of the BRI interface in SLS
		<b>set directory-number-b</b>	Assign a directory number to the B2 channel of the BRI interface in SLS
		<b>set endpoint-init</b>	Determine whether or not the far-end supports endpoint initialization in SLS
		<b>set interface</b>	Specify the glare-handling convention for a BRI link in SLS
		<b>set interface-companding</b>	Set the interface to agree with the companding method used by the far-end of the DS1 circuit for SLS mode
		<b>set layer1-stable</b>	Determine whether or not to keep the physical layer active (stable) between calls in SLS
		<b>set name</b>	Identify the user name for an ISDN facility in SLS
		<b>set side</b>	Specify the glare-handling conditions when the <b>set interface</b> command has been administered as <b>peerMaster</b> or <b>peerSlave</b> for the ISDN link in SLS
		<b>set spid-a</b>	Assign a Service Profile Identifier (SPID) to the B1 channel of the BRI link in SLS



Table 52: SLS CLI command hierarchy (continued)

Root Level Commands	First Level Context Commands	Second Level Context Commands	Description
		<b>set spid-b</b>	Assign a Service Profile Identifier (SPID) to the B2 channel of the BRI link in SLS
		<b>set tei-assignment</b>	Select the method by which the Layer 2 (LAPD) protocol obtains its Terminal Endpoint Identification (TEI) address in SLS
		<b>show</b>	List all BRI SLS parameters for this BRI port
	<b>clear attendant</b>		Delete the administered attendant provisioning in SLS
	<b>clear bri</b>		Delete the administration for a given BRI channel in SLS
	<b>clear dial-pattern</b>		Delete a single dialed string pattern entry in the SLS data set
	<b>clear ds1</b>		Delete the administration for a specific DS1 channel in SLS
	<b>clear extension</b>		Delete a particular extension number in the SLS data set. Note: It is preferable to use the <b>clear station</b> command.
	<b>clear fac</b>		Delete an administered Feature Access Code for SLS
	<b>clear incoming-routing</b>		Delete an entry for a particular incoming routed string that is associated with a given trunk group in SLS
	<b>clear sig-group</b>		Delete the administration for a given ISDN signaling group in SLS
	<b>clear slot-config</b>		Delete the slot and the board administration in the G450 for SLS
	<b>clear survivable-config</b>		Set the SLS parameters to their default values
	<b>clear station</b>		Delete a particular extension number in the SLS data set
	<b>clear trunk-group</b>		Delete a trunk group entry from the SLS data set
	<b>dial-pattern</b>		Administer ARS dial patterns for SLS

## Configuring Standard Local Survivability (SLS)

**Table 52: SLS CLI command hierarchy (continued)**

Root Level Commands	First Level Context Commands	Second Level Context Commands	Description
		<b>set delete-digits</b>	Specify the number of digits to be deleted from the beginning of the dialed string for an outbound call in SLS
		<b>set deny</b>	Permit or deny access to an outbound trunk in SLS
		<b>set insert-digits</b>	Specify the number of digits to be inserted at the beginning of the dialed string for an outbound call in SLS
		<b>set max-length</b>	Establish the maximum length of the dialed string in SLS
		<b>set min-length</b>	Establish the minimum length of the dialed string in SLS
		<b>set tgnum</b>	Designate the trunk-group number in SLS
		<b>set type</b>	Administer the type of outbound call in SLS
		<b>show</b>	List all dial-pattern SLS parameters
	<b>ds1</b>		Administer DS1 trunks for SLS
		<b>set bearer-capability</b>	Set the <b>Information Transfer Rate</b> field of the Bearer Capability IE in SLS
		<b>set bit-rate</b>	Set the maximum transmission rate for the DS1 facility in SLS
		<b>set channel-numbering</b>	Select the channel-numbering method for B-channels on an E1 interface in SLS
		<b>set connect</b>	Specify the equipment at the far-end of the DS1 link in SLS
		<b>set country-protocol</b>	Specify the ISDN Layer 3 country protocol type in SLS
		<b>set interface</b>	Specify the glare-handling convention for a DS1 link in SLS
		<b>set interface-companding</b>	Set the interface to agree with the companding method used by the far-end of the DS1 circuit for SLS mode
		<b>set long-timer</b>	Increase the duration of the T303 (call establishment) timer in SLS
			<b>3 of 8</b>

Table 52: SLS CLI command hierarchy (continued)

Root Level Commands	First Level Context Commands	Second Level Context Commands	Description
		<b>set name</b>	Identify the user name for a DS1 facility in SLS
		<b>set protocol-version</b>	Specify country protocol for countries whose public networks allow for multiple ISDN Layer 3 country protocols for ISDN Primary Rate service in SLS
		<b>set side</b>	Specify the glare-handling conditions when the <b>set interface</b> command has been administered as <b>peerMaster</b> or <b>peerSlave</b> for the ISDN link in SLS
		<b>set signaling-mode</b>	Set the signaling mode for the DS1 facility in SLS
		<b>show</b>	List all SLS parameters for this DS1 interface
	<b>Incoming-routing</b>		Administer digit-treatment for incoming routed calls in SLS
		<b>set delete-digits</b>	Specify number of digits to be deleted from the beginning of the dialed string for an inbound trunk call in SLS
		<b>set insert-digits</b>	Specify number of digits to be inserted at the beginning of the dialed string for an inbound trunk call in SLS
		<b>set length</b>	Specify the length of the dialed string in SLS
		<b>set match-pattern</b>	Specify the beginning digit pattern of the incoming alphanumeric dial string to be matched against in SLS
		<b>show</b>	List all incoming-routing SLS parameters
	<b>set attendant</b>		Specify the dial access code for the attendant feature, and specify the station which serves as the branch office attendant position
	<b>set date-format</b>		Set a date format for the SLS data set
	<b>set fac</b>		Administer the Feature Access Code for SLS
	<b>set ip-codec-set</b>		Configure an IP codec set within the SLS data set

## Configuring Standard Local Survivability (SLS)

**Table 52: SLS CLI command hierarchy (continued)**

Root Level Commands	First Level Context Commands	Second Level Context Commands	Description
	<b>set max-ip-registrations</b>		Configure the maximum number of IP registrations allowed in the SLS data set
	<b>set pim-lockout</b>		Prevent or enable PIM updates while working on SLS administration of the G450
	<b>set slot-config</b>		Define the slot and the board type in the G450 for SLS
	<b>show attendant</b>		Display the administered attendant provisioning
	<b>show bri</b>		List the administered BRI parameters for SLS
	<b>show date-format</b>		Display the current date format for the SLS data set
	<b>show dial-pattern</b>		List all dial-pattern strings in the SLS data set
	<b>show ds1</b>		List the administered DS1 parameters for SLS
	<b>show extension</b>		Display extension-specific SLS data parameters. Note: It is preferable to use the <b>show station</b> command
	<b>show fac</b>		List the administered Feature Access Codes for SLS
	<b>show incoming-routing</b>		Show all of the administered dial patterns in SLS for trunk groups
	<b>show ip-codec-set</b>		List the codec set entries for SLS
	<b>show last-pim-update</b>		Display when the last PIM update of SLS data occurred
	<b>show max-ip-registrations</b>		Display the maximum IP registration administration in the SLS data set
	<b>show pim-lockout</b>		Display the current status of the setting for the PIM lockout feature
	<b>show sig-group</b>		List all administered signaling groups in SLS
	<b>show slot-config</b>		Define the slot and the board administration in the G450 for SLS
	<b>show station</b>		Display extension-specific SLS data parameters

Table 52: SLS CLI command hierarchy (continued)

Root Level Commands	First Level Context Commands	Second Level Context Commands	Description
	<b>show trunk-group</b>		Display trunk group administration in SLS
	<b>sig-group</b>		Administer signaling groups for SLS
		<b>add nfas-interface</b>	Identify a list of DS1 modules that are controlled by the primary D-channel in SLS
		<b>remove nfas-interface</b>	Remove a member from a NFAS-managed DS1 group in SLS
		<b>set associated-signaling</b>	Specify whether the D-channel is physically present in the DS1 interface in SLS
		<b>set primary-dchannel</b>	Identify the D-channel number in SLS
		<b>set trunk-group-chan-select</b>	Specify the trunk-group number that can accept incoming calls in cases where the <b>Information Channel Selection</b> field does not specify a preferred channel for bearer transport in SLS
		<b>show</b>	List all SLS parameters for this signaling-group
	<b>station</b>		Administer stations for SLS
		<b>set cor</b>	Administer the class-of-restriction values for each station that uses SLS
		<b>set expansion-module</b>	Administer a DCP or IP station for an expansion module in SLS
		<b>set name</b>	Identify the user name for a station in SLS
		<b>set password</b>	Administer a station password in SLS for DCP and IP station sets
		<b>set port</b>	Administer the port on a station for SLS
		<b>set swhook-flash</b>	Enable SLS to recognize the switchhook flash signal from a particular analog station and to provide a subsequent transfer service
		<b>set trunk-destination</b>	Administer a station extension to be included in a pool of stations that can receive incoming analog loop-start trunk calls in circular queuing in SLS

## Configuring Standard Local Survivability (SLS)

**Table 52: SLS CLI command hierarchy (continued)**

Root Level Commands	First Level Context Commands	Second Level Context Commands	Description
		<b>set type</b>	Administer specific phone models for SLS
		<b>show</b>	List all Station SLS parameters for this station
	<b>trunk-group</b>		Administer trunks for SLS
		<b>add port</b>	Administer the port appropriate for SLS
		<b>clear tac</b>	Remove a trunk access code (TAC) assignment from a trunk group in SLS
		<b>remove port</b>	Remove the port assignment from a trunk group in SLS
		<b>set cbc</b>	Specify whether the ISDN trunk group will operate by declaring the service type explicitly on a call-by-call basis
		<b>set cbc-parameter</b>	Specify the type of service or feature being declared in the Network Services Facility information element
		<b>set cbc-service-feature</b>	Define what class of service is being specified, as part of the <b>scocs</b> service declared in the Network Services Facility information element
		<b>set channel-preference</b>	Define how the <b>Channel Identification IE</b> field is encoded in SLS
		<b>set codeset-display</b>	Specify which Q.931 codesets are allowed to send display information to the user phone in SLS
		<b>set codeset-national</b>	Specify which Q.931 codesets are allowed to send National Information Elements to the user phone in SLS
		<b>set dial</b>	Define the method for sending outbound digits in SLS
		<b>set digit-handling</b>	Define how the inbound/outbound calls handle the transmission/reception of the dialed pattern in SLS
			<b>7 of 8</b>

Table 52: SLS CLI command hierarchy (continued)

Root Level Commands	First Level Context Commands	Second Level Context Commands	Description
		<b>set digits</b>	Define the inserted dial string that is added to the beginning of the received DID incoming dial string for analog DID trunks or for DS1 TIE trunks using in-band signaling in SLS
		<b>set digit-treatment</b>	Define the incoming digit treatment for analog DID trunks or for DS1 TIE trunks using in-band signaling in SLS
		<b>set incoming-destination</b>	Identify an extension to directly receive an incoming trunk call in SLS
		<b>set incoming-dialtone</b>	Provide a dial tone in response to far-end trunk group seizures in SLS
		<b>set japan-disconnect</b>	Perform a disconnect sequence (CONNECT message followed by a DISCONNECT message) in SLS
		<b>set name</b>	Identify the user name for a trunk group in SLS
		<b>set numbering-format</b>	Specify the numbering plan for this trunk in SLS
		<b>set send-name</b>	Define whether or not the calling, connected, called, or busy party's administered name is sent to the network on outgoing or incoming calls in SLS
		<b>set send-number</b>	Define whether or not the calling, connected, called, or busy party's administered number is sent to the network on outgoing or incoming calls in SLS
		<b>set supervision</b>	Define the incoming signaling supervision mode for analog DID trunks or DS1 tie trunks only in SLS
		<b>set tac</b>	Administer the trunk-access codes for SLS
		<b>set trunk-hunt</b>	Specify the trunk-hunting search within a facility in an ISDN trunk group or through a non-ISDN digital trunk group in SLS
		<b>show</b>	List all trunk-group SLS parameters for this trunk-group

**8 of 8**





# Chapter 7: Configuring Ethernet ports

This chapter provides information about configuring Ethernet ports on the Avaya G450 Media Gateway.

---

## Ethernet ports on the G450

The switch and router on the Avaya G450 Media Gateway have various Ethernet ports.

---

### Ethernet ports on the G450 Media Gateway switch

- The 10/100/1000 Mbps fixed switch ports on the front panel (ports 10/5 and 10/6)

---

### Ethernet ports on the G450 Media Gateway router

- The 10/100 Mbps fixed router ports on the front panel (ports 10/2 and 10/4)

---

### Cables used for connecting devices to the fixed router

Use a standard network cable when you connect one of the following devices to the fixed router port:

- WAN endpoint device
- Switch
- Router

Use a crossover network cable when you connect a computer or other endpoint device to the fixed router port. For all other Ethernet ports on the G450, you can use either a standard network cable or a crossover network cable to connect any device.

## Configuring switch Ethernet ports

For basic configuration of a switch Ethernet port, use the commands listed below. You can also configure the following features on a switch Ethernet port:

- Advanced switching features, including VLANs. For more information, see [Configuring advanced switching](#) on page 351.
- VoIP queuing. To configure VoIP queuing on a switch port, configure a VLAN for the port. Then configure VoIP queuing on the VLAN. For more information about VoIP queuing, see [Configuring QoS parameters](#) on page 232.
- Access control policy lists and QoS policy lists. To configure policy lists on a switch port, configure a VLAN for the port. Then configure policy on the VLAN. For more information on policy lists, see [Configuring policy](#) on page 591.
- SNMP Link Up and Link Down traps. For more information, see [Configuring SNMP traps](#) on page 333.

---

## Switch Ethernet port commands

Use the following commands for basic configuration of switch Ethernet ports. For more information about these commands, see *Avaya G450 CLI Reference*, 03-300437.

- Use the **set port auto-negotiation-flowcontrol-advertisement** command to set the flow control advertisement for the specified port when performing auto-negotiation. This command is only applicable to the Gigabit Ethernet ports. Use the **show port auto-negotiation-flowcontrol-advertisement** command to display the flow control advertisement for a Gigabit port.
- Use the **set port disable** command to disable a port or range of ports.
- Use the **set port duplex** command to configure the duplex type of an Ethernet or Fast Ethernet port or range of ports. You can configure Ethernet and Fast Ethernet interfaces to either full-duplex or half-duplex. The duplex status of a port in auto-negotiation mode is determined by auto-negotiation. When auto-negotiation is enabled, an error message is generated if you attempt to set the transmission type of auto-negotiation Fast Ethernet ports to half-duplex or full-duplex mode.
- Use the **set port edge admin state** command to determine whether or not the port is an edge port. Edge port is a treatment assigned to ports for the purposes of RSTP (Rapid Spanning Tree Protocol). For more information about using this command and RSTP configuration in general, see [Rapid Spanning Tree Protocol \(RSTP\)](#) on page 363. Use the **show port edge state** command to display the edge state of one or all ports.
- Use the **set port enable** command to enable a port or a range of ports.

- Use the **set port flowcontrol** command to set the send/receive mode for flow control frames (IEEE 802.3x or proprietary) for a full-duplex port. Each direction (send or receive) can be configured separately. Use the **show port flowcontrol** command to display port flow control information.
- Use the **set port level** command to determine the default packet priority level for untagged packets. Packets traveling through a port set at normal priority should be served only after packets traveling through a port set at high priority are served.
- Use the **set port name** command to configure a name for a port.
- Use the **set port negotiation** command to enable or disable the link negotiation protocol on the specified port. This command applies to Fast Ethernet or Gigabit Ethernet ports. When negotiation is enabled, the speed and duplex of the Fast Ethernet ports are determined by auto-negotiation. If negotiation is disabled, the user can set the speed and duplex of the Fast Ethernet ports.
- Use the **set port point-to-point admin status** command, followed by the module and port number of the port, to manage the connection type of the port. Use one of the following arguments with this command:
  - **force-true**. The port is treated as if it were connected point-to-point
  - **force-false**. The port is treated as if it were connected to shared media
  - **auto**. The G450 tries to automatically detect the connection type of the port
- Use the **set port speed** command to configure the speed of a port or range of ports. In auto-negotiation mode, the port's speed is determined by auto-negotiation. An error message is generated if you attempt to set the speed when auto-negotiation is enabled.

---

## Summary of switch Ethernet port configuration CLI commands

For more information about these commands, see *Avaya G450 CLI Reference*, 03-300437.

**Table 53: Switch Ethernet port configuration CLI commands**

Command	Description
<b>set port auto-negotiation-flowcontrol-advertisement</b>	Set the flow control advertisement for the specified Gigabit Ethernet ports when performing auto-negotiation
<b>set port duplex</b>	Configure the duplex type (full or half-duplex) of an Ethernet or Fast Ethernet port or range of ports
<b>set port edge admin state</b>	Determine whether the port is an edge port, for the purposes of RSTP (Rapid Spanning Tree Protocol)

**1 of 2**

Table 53: Switch Ethernet port configuration CLI commands (continued)

Command	Description
<code>set port enable   disable</code>	Enable or disable a port or a range of ports
<code>set port flowcontrol</code>	Set the send/receive mode for flow control frames (IEEE 802.3x or proprietary) for a full-duplex port
<code>set port level</code>	Set the default packet priority level for untagged packets
<code>set port name</code>	Configure a name for a port
<code>set port negotiation</code>	Enable or disable auto-negotiation on the port
<code>set port point-to-point admin status</code>	Set the connection type of the port: <code>force-true</code> , <code>force-false</code> , or <code>auto</code>
<code>set port speed</code>	Set the speed of a port or range of ports
<code>show port auto-negotiation-flowcontrol-advertisement</code>	Display the flow control advertisement for a Gigabit port used to perform auto-negotiation
<code>show port edge state</code>	Display the edge state of a port
<code>show port flowcontrol</code>	Display port flow control information

2 of 2

## Configuring the WAN Ethernet port

1. Use the `interface fastethernet 10/2` or `interface fastethernet 10/4` command to enter the context of the port interface.
2. Perform basic configuration of the interface. For more information, see [Configuring interfaces](#) on page 443.
3. Use the Ethernet WAN port configuration commands in the context of the port interface. See [WAN Ethernet port commands](#) on page 197.

## Configuring additional features on the WAN Ethernet port

- Primary Management Interface (PMI). For more information, see [Configuring the Primary Management Interface \(PMI\)](#) on page 80.
- Advanced router features. For more information, see [Configuring the router](#) on page 443.

- VoIP queuing. For more information, see [Configuring QoS parameters](#) on page 232.
- Access control policy lists and QoS policy lists. For more information, see [Configuring policy](#) on page 591.
- SNMP Link Up and Link Down traps. For more information, see [Configuring SNMP traps](#) on page 333.

---

## WAN Ethernet port traffic shaping

You can use traffic shaping to determine the data transfer rate on the WAN Ethernet port. To set traffic shaping, use the **traffic-shape rate** command in the interface context. To disable traffic shaping, use the **no** form of the **traffic-shape rate** command. Traffic shaping works in tandem with the configured bandwidth. If you change the traffic shape rate, this automatically changes the bandwidth. Similarly, if you change the bandwidth, this automatically changes the traffic shape rate.

**Note:**

The traffic shape rate is determined in bits. The bandwidth is determined in kilobytes.

For information on traffic shaping in general, see [Configuring QoS parameters](#) on page 232.

---

## Backup interfaces

You can configure backup relations between a pair of any Layer 2 serial interfaces, including the FastEthernet interface. For instructions on how to configure backup interfaces, see [Backup interfaces](#) on page 268.

---

## WAN Ethernet port commands

Use the following commands in `FastEthernet 10/2` or `10/4` context for basic Ethernet configuration of the WAN Ethernet port:

- Enter **autoneg** to set the port speed and duplex to auto-negotiation mode for the external Fast Ethernet port. Use the **no** form of this command to disable the auto-negotiation mode.
- Use the **duplex** command to control the duplex setting for the interface.

## Configuring Ethernet ports

- Use the **keepalive-track** command to bind the interface status to an object tracker. When activated, the object tracker sends health check packets at defined intervals to the other side of the interface. If the configured number of consecutive keepalive requests are not answered, the interface track state changes to down. The object tracker continues monitoring the interface, and when its track state changes to up, the interface state changes to up.
- Enter **shutdown** to set the administrative status of the current interface to down. Use the **no** form of this command to restore the administrative status of the interface to up.
- Use the **speed** command to set the port speed.

---

## Summary of WAN Ethernet port configuration CLI commands

For more information about these commands, see *Avaya G450 CLI Reference*, 03-300437.

Table 54: WAN Ethernet port configuration CLI commands

Root level command	Command	Description
<b>interface fastethernet</b>		Enter interface fastethernet configuration mode
	<b>autoneg</b>	Set the port speed and duplex to auto-negotiation mode
	<b>duplex</b>	Set the duplex setting (full or half) for the interface
	<b>keepalive-track</b>	Bind an object tracker to the interface to check whether it is up
	<b>shutdown</b>	Set the administrative status of the current interface to down or up
	<b>speed</b>	Set the speed for the interface
	<b>traffic-shape rate</b>	Configure traffic shaping for outbound traffic on the current interface

---

## Configuring DHCP client

The Avaya G450 Media Gateway can be configured to function as a DHCP (Dynamic Host Configuration Protocol) client.

DHCP client enables the G450 to receive an IP address from a DHCP server, according to the DHCP client-server protocol. The DHCP server grants the G450 DHCP client an IP address for a fixed amount of time, called the lease. After the lease expires, the G450 DHCP client is required to stop using the IP address. The G450 DHCP client periodically sends requests to the server to renew or extend the lease.

In addition to receiving an IP address, a G450 DHCP client can optionally request to receive a domain name, a list of default routers, and a list of available DNS servers.

**Note:**

The Avaya G450 Media Gateway can function as both a DHCP server and a DHCP client simultaneously. That is, you can connect a cable modem for an Internet connection to the WAN Fast Ethernet in order to use the G450 as a DHCP client. At the same time, you can activate the DHCP server on the G450 for use by clients, such as, IP phones and PCs connected to the LAN ports. The DHCP server on the G450 does *not* serve Internet devices connected over the WAN Fast Ethernet ports.

For information on configuring the G450 as a DHCP server, see [Configuring DHCP server](#) on page 470.

---

## DHCP client applications

The typical application of DHCP client in the G450 involves requesting and receiving an IP address from the service provider's DHCP server, to enable a broadband Internet connection via cable modem.

---

**Figure 18: Fixed connection to broadband Internet using G450 as DHCP client**

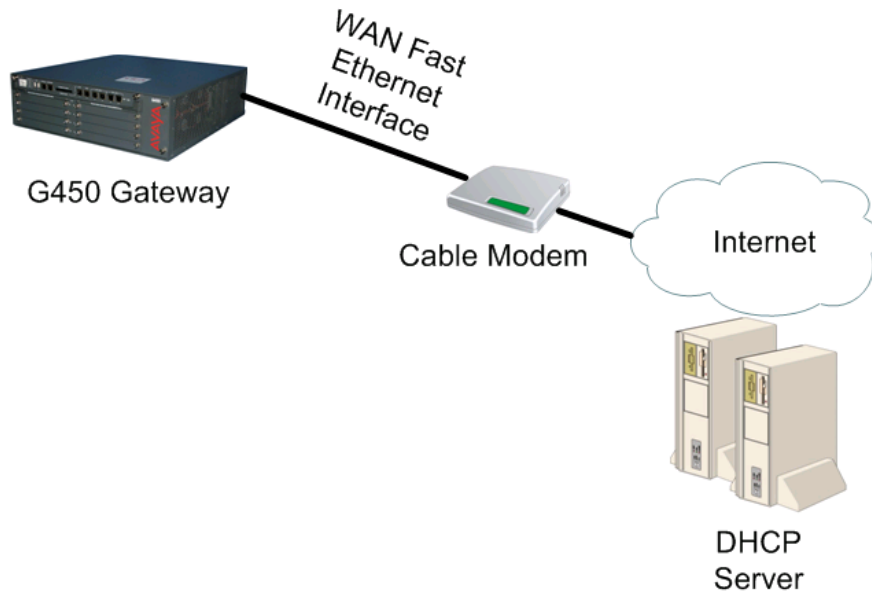

---

## DHCP client configuration

1. Enter the context of the FastEthernet interface. For example:

```
G450-001# interface fastethernet 10/2
G450-001(config-if:FastEthernet 10/2)#
```

2. Optionally, configure DHCP client parameters. If you do not configure these parameters, their default values are used:
  - Use the **ip dhcp client client-id** command to set the client identifier for the DHCP client. By default, the client identifier is usually the MAC address of the G450 FastEthernet interface.
  - Use the **ip dhcp client hostname** command to set the hostname for the DHCP client. By default, the DHCP client uses the G450's hostname.
  - Use the **ip dhcp client lease** command to set the lease requested by the DHCP client. The lease is the length of time that the IP address provided by the DHCP server remains in effect. By default, the client does not request a specific lease from the DHCP server and uses the lease set by the DHCP server.



- Use the **ip dhcp client request** command to determine which DHCP options the DHCP client requests from the DHCP server. By default, the DHCP client requests all DHCP options. For information on the specific options, see [Table 117](#).

For example:

```
G450-001(config-if:FastEthernet 10/2)# ip dhcp client client-id hex
01:00:04:0D:29:DC:68
Done!

G450-001(config-if:FastEthernet 10/2)# ip dhcp client hostname "G450-A"
Done!

G450-001(config-if:FastEthernet 10/2)# ip dhcp client lease 1 4 15
Done!
G450-001(config-if:FastEthernet 10/2)# no ip dhcp client request domain-name
Done!
```

3. Optionally, use the **ip dhcp client route track** command to apply an object tracker to monitor the DHCP client's default route. The object tracker continuously checks the validity of the default route, that is, whether data can be transmitted over the default route. Whenever the object tracker determines that the default route has become invalid, the route is dropped from the routing table and traffic is routed to alternate routes. If the default route becomes valid again, it is added back to the routing table.

To define an object tracker, see [Object tracking configuration](#) on page 299.

For an example of how to track the DHCP client default route, see [Typical application – tracking the DHCP client default route](#) on page 313.

Note that if several default routers are learned from a specific interface, the object tracker tracks only the first one.

For example:

```
G450-001(config-if:FastEthernet 10/2)#ip dhcp client route track 3
Done!
```

4. Enable the DHCP client by entering **ip address dhcp**.

A message appears, displaying the IP address and mask assigned by the DHCP server.

For example:

```
G450-001(config-if:FastEthernet 10/2)# ip address dhcp
Done!
Interface FastEthernet 10/2 assigned DHCP address 193.172.104.161, mask
255.255.255.0
```

**Note:**

Whenever you change the value of a DHCP client parameter (such as, client-id, or client hostname), enter **ip address dhcp** again to re-initiate DHCP address negotiation using the new values.

## Configuring Ethernet ports

5. You can use the **show ip dhcp-client** command to view the DHCP client parameters. For example:

```
G450-001(config-if:FastEthernet 10/2)# show ip dhcp-client

DHCP Client Mode      : Enable
Status                : Bound
IP Address            : 193.172.104.161
Subnet Mask           : 255.255.255.0
Default Router        : 193.172.104.162
DHCP Server           : 192.100.106.163
DNS Server            : 192.100.106.101
Domain Name           : avaya.com
Lease Received (D:H:M:S) : 0:0:10:0
Lease Remains (D:H:M:S)  : 0:0:9:32
Lease Rebind (D:H:M:S)   : 0:0:8:45
Lease Renew (D:H:M:S)    : 0:0:5:0
Lease Requested (D:H:M:S) : 1:3:4:0
Host Name              : G450-A
Client Identifier      : 01:00:04:0D:29:DC:68
Requested Options      :
                        subnet-mask (1)
                        routers (3)
                        domain-name (15)
                        domain-name-servers (6)
Track-id               : 3
```

---

## Releasing and renewing a DHCP lease

- Use the **release dhcp** command to release a DHCP lease for an interface. This effectively releases the client IP address, and no IP address is allocated to the specified interface. For example:

```
G450-001(super)# release dhcp FastEthernet 10/2
Done!
```

- Use the **renew dhcp** command to renew a DHCP lease for an interface. This is effectively a request to renew an existing IP address, or the start of a new process of allocating a new IP address. For example:

```
G450-001(super)# renew dhcp FastEthernet 10/2
Done!
```

A message appears displaying the IP address and mask assigned by the DHCP server.  
For example:

```
Interface FastEthernet 10/2 assigned DHCP address 193.172.104.161, mask  
255.255.255.0
```

---

## Maintaining DHCP client

For a full description of the commands and their output fields see *Avaya G450 CLI Reference*, 03-602056.

- Use the **show ip dhcp-client** command to show the configuration of the DHCP client.
- Enter **show ip dhcp-client statistics** to show the DHCP client statistics counters.
- Enter **clear ip dhcp-client statistics** to clear the DHCP client statistics counters.

---

## Configuring DHCP client logging messages

1. Enter **set logging session enable** to enable logging to the CLI terminal.

```
G450-001# set logging session enable  
Done!  
CLI-Notification: write: set logging session enable
```

2. Use the **set logging session condition dhcpc** command to view all DHCP client messages of level Info and above. For example:

```
G450-001# set logging session condition dhcpc Info  
Done!  
CLI-Notification: write: set logging session condition dhcpc Info
```

### Note:

You can also enable logging messages to a log file or a Syslog server. For a full description of logging on the G450, see [Configuring logging on page 209](#).

## Summary of DHCP client configuration CLI commands

For more information about these commands, see *Avaya G450 CLI Reference*, 03-300437.

**Table 55: DHCP client configuration CLI commands**

Root level command	Command	Description
<code>clear ip dhcp-client statistics</code>		Clear the DHCP client statistics counters
<code>interface fastethernet</code>		Enter interface fastethernet configuration mode
	<code>clear ip dhcp-client statistics</code>	Clear the DHCP client statistics counters
	<code>ip address dhcp</code>	Enable or disable IP address negotiation via DHCP (applies to WAN FastEthernet interfaces only)
	<code>ip dhcp client client-id</code>	Set the client identifier for the DHCP client
	<code>ip dhcp client hostname</code>	Set the client hostname for the DHCP client
	<code>ip dhcp client lease</code>	Set the lease requested by the DHCP client
	<code>ip dhcp client request</code>	Specify which DHCP options the DHCP client requests from the DHCP server
	<code>ip dhcp client route track</code>	Apply object tracking in order to monitor the DHCP client's default route
	<code>show ip dhcp-client</code>	Display the configuration of the DHCP client
	<code>show ip dhcp-client statistics</code>	Display the DHCP client statistics counters
<code>release dhcp</code>		Release a DHCP lease for an interface
<code>renew dhcp</code>		Renew a DHCP lease for an interface

1 of 2

Table 55: DHCP client configuration CLI commands (continued)

Root level command	Command	Description
<code>show ip dhcp-client</code>		Display the configuration of the DHCP client
<code>show ip dhcp-client statistics</code>		Display the DHCP client statistics counters
		<b>2 of 2</b>

## Configuring LLDP

IEEE 802.1AB Link Layer Discovery Protocol (LLDP) simplifies troubleshooting of enterprise networks and enhances the ability of network management tools to discover and maintain accurate network topologies in multi-vendor environments. It defines a set of advertisement messages, called TLVs, a protocol for transmitting and receiving the advertisements, and a method for storing the information contained in the received advertisements.

The LLDP protocol allows stations attached to a LAN to advertise information about the system (such as, its major capabilities and its management address) and information regarding the station's point of attachment to the LAN (port ID and VLAN information) to other stations attached to the same LAN. These can all be reported to management stations via IEEE-defined SNMP MIBs.

LLDP information is transmitted periodically. The IEEE has defined a recommended transmission rate of 30 seconds, but the transmission rate is adjustable. An LLDP device, after receiving an LLDP message from a neighboring network device, stores the LLDP information in an SNMP MIB. This information is valid only for a finite period of time after TLV reception. This time is defined by the LLDP "Time to Live" (TTL) TLV value that is contained within the received packet unless refreshed by a newly received TLV. The IEEE recommends a TTL value of 120 seconds, but you can change it if necessary. This ensures that only valid LLDP information is stored in the network devices and is available to network management systems.

LLDP information is associated with the specific device that sends it. The device itself is uniquely identified by the receiving party port via chassis ID and port ID values. Multiple LLDP devices can reside on a single port, using a hub for example, and all of the devices are reported via MIB. You can enable (Rx-only, TX-only, and Rx or Tx) or disable LLDP mode of operation on a per-port basis.

## Supported TLVs

### Mandatory TLVs

- End-of-LDPDU
- Chassis ID
- Port ID
- Time to Live

### Optional TLVs

- Port description
- System description
- System name
- System capabilities
- Management address

### 802.1 TLVs (optional)

- VLAN name
- Port VLAN

---

## LLDP configuration

1. Enable the LLDP agent globally using the `set lldp system-control` command. For example:

```
G450-001(super)# set lldp system-control enable
Done!
```

The device's global topology information, including all mandatory TLVs, is now available to neighboring devices supporting LLDP.

- Optionally, configure the administrative LLDP port status using the **set port lldp** command. The default value is rx-and-tx. For example:

```
G450-001(super)# set port lldp 10/3 rx-and-tx
Done!
```

The device now sends LLDP TLVs and accepts LLDP TLVs from neighboring devices supporting LLDP on the specified port.

- Optionally, configure additional TLVs transmission using the **set port lldp tlv** command. This allows you to advertise additional data about the device's and port's VLAN information, VLANs, and system capabilities. Additional TLVs are disabled by default. For example:

```
G450-001(super)# set port lldp tlv 10/3 enable all
Done!
```

The device now advertises all mandatory and optional TLVs to neighboring network devices supporting LLDP.

- If required, change any of the following timing parameters:
  - The interval at which the device transmits LLDP frames, using the command **set lldp tx-interval**. The default is 30 seconds.
  - The value of TxHoldMultiplier, using the command **set lldp tx-hold-multiplier**. TxHoldMultiplier is a multiplier on the interval configured by **set lldp tx-interval** that determines the actual TTL value sent in an LLDP frame. The default value is 30. The time-to-live value transmitted in TTL TLV is expressed by:  $TTL = \min(65535, TxInterval * TxHoldMultiplier)$ .
  - The minimal delay between successive LLDP frame transmissions, on each port, using the command **set lldp tx-delay**. The default is 30 seconds.
  - The delay from when a port is set to LLDP "disable" until re-initialization is attempted, using the command **set lldp re-init-delay**. The default is 2 seconds.
- Verify LLDP advertisements using the **show lldp** command.

## Displaying LLDP configuration

- Use the **show lldp config** command to display the global LLDP configuration.
- Use the **show port lldp config** command to display port-level LLDP configuration.
- Use the **show port lldp vlan-name config** command to show the statically bound VLANs that the port transmits in the VLAN Name TLV.

## Supported ports for LLDP

Only ports 10/5 and 10/6 can be configured to support LLDP.

## Summary of LLDP configuration CLI commands

For more information about these commands, see *Avaya G450 CLI Reference*, 03-300437.

**Table 56: LLDP configuration CLI commands**

Command	Description
<code>set lldp re-init-delay</code>	Set the delay from when a port is set to LLDP "disable" until re-initialization is attempted
<code>set lldp system-control</code>	Enable or disable the LLDP application globally per device or stack
<code>set lldp tx-delay</code>	Set the <b>TxDelay</b> , which is the minimal delay in seconds between successive LLDP frame transmissions, on each port
<code>set lldp tx-hold-multiplier</code>	Set the <b>TxHoldMultiplier</b> , which is a multiplier on the <b>TxInterval</b> that determines the actual TTL value sent in an LLDP frame
<code>set lldp tx-interval</code>	Set the <b>TxInterval</b> , the interval at which the device transmits LLDP frames
<code>set port lldp</code>	Change the administrative LLDP status of a port
<code>set port lldp tlv</code>	Enable or disable the transmission of the optional TLVs on a per port basis
<code>show lldp</code>	Display the LLDP information received on each port
<code>show lldp config</code>	Display the global LLDP configuration
<code>show port lldp config</code>	Display port-level LLDP configuration
<code>show port lldp vlan-name config</code>	Show the VLANs that are being transmitted on a specific port



# Chapter 8: Configuring logging

System logging is a method of collecting system messages generated by system events. The Avaya G450 Media Gateway includes a logging package that collects system messages in several output types. Each of these types is called a sink. When the system generates a logging message, the message can be sent to each sink that you have enabled.

**Table 57: Logging sinks**

Sink	Description
Syslog	Logging messages are sent to up to three configured servers, using Syslog protocol as defined in RFC 3164. Messages sent to the Syslog server are sent as UDP messages.
Log file	Logging data is saved in the flash memory. These compressed, cyclic files serve as the system logging database.
Session	Logging messages are sent to the terminal screen as follows: <ul style="list-style-type: none"><li>• For a local connection, messages appear online on the local terminal.</li><li>• For a remote Telnet/SSH connection, messages appear online on the remote terminal.</li></ul> This sink is deleted whenever a session ends.

System messages do not always indicate problems. Some messages are informational, while others may help to diagnose problems with communications lines, internal hardware, and system software.

By default, all sinks are disabled. When enabled, log file and Syslog sink settings can be saved by entering **copy running-config startup-config** to save the running configuration to the startup configuration. However, the Session sink and its settings are deleted when the session is terminated.

You can define filters for each sink to limit the types of messages the sink receives (see [Configuring logging filters](#) on page 217).

The logging facility logs configuration commands entered through the CLI or via SNMP, as well as system traps and informative messages concerning the behavior of various processes. However, a user enabling the log will only see entered commands with a user-level no higher than the user's privileges. For example, a user with read-only privileges will not see entered commands having a read-write user level. In addition, the log does not display entered information of a confidential nature, such as, passwords and VPN pre-shared-keys.

---

## Configuring a Syslog server

A Syslog server is a remote server that receives logging messages using the Syslog protocol. This enables storage of large log files, which you can use to generate reports.

### Defining Syslog servers

You can define up to three Syslog servers.

1. Define the Syslog server by entering **set logging server** followed by the IP address of the server. For example:

```
G450-001(super)# set logging server 147.2.3.66
Done!
```

2. Enable the Syslog server by entering **set logging server enable** followed by the IP address of the Syslog server. When you define a new Syslog server, it is defined as disabled, so you must use this command in order to enable the server. For example:

```
G450-001(super)# set logging server enable 147.2.3.66
Done!
```

3. Optionally, define an output facility for the Syslog server by typing the **set logging server facility** command, followed by the name of the output facility and the IP address of the Syslog server. If you do not define an output facility, the default local7 facility is used. For example:

```
G450-001(super)# set logging server facility auth 147.2.3.66
Done!
```

The following is a list of possible facilities:

- **auth.** Authorization
- **daemon.** Background system process
- **clkd.** Clock daemon
- **clkd2.** Clock daemon
- **mail.** Electronic mail
- **local0 – local7.** For local use
- **ftpd.** FTP daemon
- **kern.** kernel
- **alert.** Log alert
- **audi.** Log audit

- ntp. NTP subsystem
  - lpr. Printing
  - sec. Security
  - syslog. System logging
  - uucp. Unix-to-Unix copy program
  - news. Usenet news
  - user. User process
4. Optionally, limit access to the Syslog server output by typing the **set logging server access-level** command, followed by an access level (`read-only`, `read-write`, or `admin`) and the IP address of the Syslog server. If you do not define an access level, the default read-write level is used. For example:

```
G450-001(super)# set logging server access-level read-only 147.2.3.66
Done!
```

Only messages with the appropriate access level are sent to the Syslog output.

5. Optionally, define filters to limit the types of messages received (see [Configuring logging filters](#) on page 217).

## Disabling Syslog servers

Enter **set logging server disable** followed by the IP address of the Syslog server. For example:

```
G450-001(super)# set logging server disable 147.2.3.66
Done!
```

## Deleting Syslog servers

You can delete a Syslog server from the Syslog server table. Enter **clear logging server** followed by the IP address of the Syslog server you want to delete. For example:

```
G450-001(super)# clear logging server 147.2.3.66
Done!
```

### Displaying the status of the Syslog server

Enter **show logging server condition** followed by the IP address of the Syslog server. If you do not specify an IP address, the command displays the status of all Syslog servers defined for the G450.

As the following example illustrates, the command displays whether the server is enabled or disabled, and lists all filters defined on the server:

```
G450-001(super)# show logging server condition 147.2.3.66

*****
*** Message logging configuration of SYSLOG  sink ***

Sink Is Enabled
Sink default severity: Warning

Server name: 147.2.3.66
Server facility: auth
Server access level: read-only
```

### Syslog sink default settings

- **Severity.** Warning
- **Facility.** Local 7
- **Access level.** Read-write

---

### Syslog message format

Syslog messages are arranged chronologically and have the following format:

```
<34> Oct 11 22:14:15 host LINKDOWN SWICHFABRIC-Notification:Port 10/3 Link
```

The message provides the following information:

- A priority (<34> in this example), which is calculated based on the syslog facility and the severity level.
- A header (Oct 11 22:14:15 host LINKDOWN in this example), providing the date and time, the hostname, and a message mnemonic.
- A message (SWICHFABRIC-Notification: Port 10/3 Link in this example), detailing the application being logged, the severity level, and the message text.

---

## Configuring a log file

A log file is a file of data concerning a system event, saved in the flash memory. The log files serve as the system logging database, keeping an internal record of system events.

1. Enter **set logging file enable**.

```
G450-001(super)# set logging file enable
Done!
```

2. Optionally, define filters to limit the types of messages received (see [Configuring logging filters](#) on page 217).

## Disabling logging system messages to a log file

Enter **set logging file disable**.

```
G450-001(super)# set logging file disable
Done!
```

## Deleting current log file and opening an empty log file

Enter **clear logging file**.

```
G450-001(super)# clear logging file
Done!
```

## Configuring logging

### Displaying log file messages

Use the **show logging file content** command. Note that the user enabling the log will only see entered commands with a user-level no higher than the user's privileges. A user with read-only privileges will not see entered commands having a read-write user level. For example:

```
G450-001(super)# show logging file content

11/21/2004,15:45:43:CLI-Notification: root: nvram initialize

11/21/2004,15:43:08:CLI-Notification: root: exit

11/21/2004,15:42:20:ROUTER-Warning: Duplicate IP address: 3.3.3.1 from 00:00:021

11/18/2004,16:48:21:CLI-Notification: root: no track 20

11/18/2004,16:48:18:SAA-Debug: Response for ipIcmpEcho timed-out on rtr 6, echo.

11/18/2004,16:48:18:CLI-Notification: root: no rtr-schedule 6

11/18/2004,16:48:18:SAA-Informational: rtr 6 state changed to pending.

11/18/2004,16:48:18:TRACKER-Informational: track 6 state changed to pending.
```

### Displaying conditions defined for the file output sink

Enter **show logging file condition**. For example:

```
G450-001(super)# show logging file condition

*****
*** Message logging configuration of FILE      sink ***

Sink Is Enabled
Sink default severity: Informational
```

---

## Log file message format

Log file messages appear in first-in, last-out order. They have the following format:

```
01/18/2005,10:55:09:CLI-Notification: root:   set port disable 10/6

01/18/2005,10:49:03:SWITCHFABRIC-Notification: Port Connection Lost on Module 10
port 5
```

Each message provides the following information:

- The date and time (if available)
- The logging application
- The severity level
- The message text

---

## Configuring a session log

A session log is the display of system messages on the terminal screen. It is automatically deleted when a session ends.

1. Enter **set logging session enable**.

```
G450-001(super)# set logging session enable
Done!
```

**Note:**

If the device is connected to several terminals, a separate session log is established for each terminal.

2. Optionally, define filters to limit the types of messages received (see [Configuring logging filters](#) on page 217).

## Discontinuing the display of system messages

To discontinue the display of system messages to the terminal screen, enter **set logging session disable**.

```
G450-001(super)# set logging session disable
Done!
```

### Displaying how the session logging is configured

Enter **show logging session condition**. This command displays whether session logging is enabled or disabled, and lists all filters defined for session logging. For example:

```
G450-001(super)# show logging session condition

*****
*** Message logging configuration of SESSION sink ***

Sink Is Enabled
Sink default severity: Warning
Session source ip: 172.16.1.231
```

---

### Session logging message format

Session logging messages are arranged chronologically and have the format shown in the following example:

```
01/18/2005,10:49:03:SWITCHFABRIC-Notification: Port Connection Lost on Module 10
port 5 was cleared

01/18/2005,10:55:09:CLI-Notification: root: set port disable 10/6
```

Each message provides the following information:

- The date and time (if available)
- The logging application
- The severity level
- The message text

**Note:**

The user enabling the log will only see entered commands with a user-level no higher than the user's own privileges. For example, a user with read-write privileges will not see entered commands having an admin user level.



---

## Configuring logging filters

You can use filters to reduce the number of collected and transmitted messages. The filtering options are based on message classification by severity for each application. For a specified sink, you can define the threshold severity level for message output for each application. Messages pertaining to the specified applications, that have a severity level stronger than or equal to the defined threshold, are sent to the specified sink. Messages with a severity level weaker than the defined threshold are not sent.

### Setting the logging filters

For each sink, you can set logging filters by specifying a severity level per application, as follows:

- To create a filter for messages sent to a specified Syslog server, enter **set logging server condition application severity ip address**.
- To create a filter for messages sent to a log file, enter **set logging file condition application severity**.
- To create a filter for messages sent to a session log on a terminal screen, enter **set logging session condition application severity**.

where:

- **application** is the application for which to view messages (use **all** to specify all applications). For the list of applications see [Applications to be filtered](#) on page 219.
- **severity** is the minimum severity to log for the specified application (use **none** to disable logging messages for the specified application). For a list of the severity levels and the default severity settings, see [Severity levels](#) on page 218.
- **ip address** is the IP address of the Syslog server.

For example:

```
G450-001(super)# set logging server condition dialer critical 147.2.3.66
Done!
G450-001(super)# set logging file condition dhcp warning
Done!
G450-001(super)# set logging session condition ISAKMP Information
Done!
```

You can also filter the **show logging file content** command by severity for each application, using the same variables as in the **set logging file condition** command. In addition, you can limit the number of messages to display.

## Configuring logging

For example, to display the 50 most recent messages from the QoS application with a severity level of critical or higher, enter the following command:

```
G450-001(super)# show logging file content critical qos 50
```

## Severity levels

**Table 58: Severity levels**

Severity level	Code	Description
emergency	0	System is unusable
alert	1	Immediate action required
critical	2	Critical condition
error	3	Error condition
warning	4	Warning condition
notification	5	Normal but significant condition
informational	6	Informational message only
debugging	7	Message that only appears during debugging

## Sinks default severity levels

- **Syslog.** Warning
- **Log file.** Informational
- **Session**
  - **Session from terminal.** Informational
  - **Session from telnet/ssh.** Warning

## Applications to be filtered

Filters can be defined for any application listed in [Table 59](#).

**Table 59: Logging applications**

Application	Description
<b>boot</b>	System startup failures
<b>cascade</b>	Stack CASCADE mechanism
<b>cdr</b>	Call Detail Recording. Registers the active calls in SLS mode.
<b>cli</b>	CLI
<b>aan</b>	Application Assurance Networking. CNA test plugs report to AAN.
<b>config</b>	Configuration changes
<b>console</b>	Serial modem messages
<b>dhcpc</b>	DHCP client package
<b>dhcps</b>	DHCP server package
<b>dialer</b>	Dialer interface messages
<b>dnsc</b>	DNS client package
<b>fan</b>	Cooling system
<b>filesystem</b>	File system problem (flash)
<b>ids</b>	IDS events, specifically a SYN attack heuristic employed by the SYN cookies feature
<b>ipsec</b>	VPN IPSEC package
<b>isakmp</b>	VPN IKE package
<b>lag</b>	Link Aggregation package
<b>policy</b>	Policy package
<b>ppp</b>	PPP protocol
<b>pppoe</b>	PPP over Ethernet
<b>qos</b>	QoS messages
<b>router</b>	Core routing system failures

*1 of 2*

**Table 59: Logging applications (continued)**

<b>Application</b>	<b>Description</b>
<b>rtp-stat</b>	RTP MIB statistics
<b>saa</b>	RTR-probes messages
<b>security</b>	Secure logging (authentication failure)
<b>snmp</b>	SNMP agent
<b>stp</b>	Spanning tree package
<b>supply</b>	Power supply system
<b>switchfabric</b>	Switch fabric failures
<b>system</b>	Operating system failures
<b>tftp</b>	Internal TFTP server
<b>threshold</b>	RMON alarms
<b>tracker</b>	Object tracker messages
<b>usb-modem</b>	USB modem messages
<b>vlan</b>	VLAN package
<b>voice</b>	Voice failures
<b>wan</b>	WAN plugged-in expansion

**2 of 2**

## Syslog server example

The following example defines a Syslog server with the following properties:

- IP address 147.2.3.66
- Logging of messages enabled
- Output to the Kernel facility
- Only messages that can be viewed by read-write level users are received

- Filter restricts receipt of messages from all applications to those less severe than error

```
G450-001(super)# set logging server 147.2.3.66
Done!
G450-001(super)# set logging server enable 147.2.3.66
Done!
G450-001(super)# set logging server facility kern 147.2.3.66
Done!
G450-001(super)# set logging server access-level read-write 147.2.3.66
Done!
G450-001(super)# set logging server condition all error 147.2.3.66
Done!
```

## Log file example

The following example enables the logging of system messages to a log file in the flash memory and creates a filter to restrict the receipt of messages from the **boot** application to those with severity level of informational or more severe, and messages from the **cascade** application to those with severity level of alert or more severe.

```
G450-001(super)# set logging file enable
Done!
G450-001(super)# set logging file condition boot informational
Done!
G450-001(super)# set logging file condition cascade alert
Done!
```

## Session log example

The following example enables a session log for a user wishing to debug the ISAKMP application, while only receiving messages of severity level error or stronger for all other applications. Therefore, the user sets the default severity level for all applications to error, and then sets the severity of the ISAKMP application to informational. Finally, the user displays the filter settings.

```
G450-001(super)# set logging session enable
Done!
G450-001(super)# set logging session condition all Error
Done!
G450-001(super)# set logging session condition ISAKMP Informational
Done!
G450-001(super)# show logging session condition

*****
*** Message logging configuration of CLI sink ***

Sink Is Enabled
Sink default severity: Error
Application           ! Severity Override
-----
ISAKMP                ! Informational
```

---

## Summary of Logging configuration CLI commands

For more information about these commands, see *Avaya G450 CLI Reference*, 03-300437.

**Table 60: Logging configuration CLI commands**

Command	Description
<b>clear logging file</b>	Delete the message log file being stored in non-volatile memory (NVRAM), including the history log, and open a new, empty log file
<b>clear logging server</b>	Delete the specified Syslog message server from the Syslog server table
<b>set logging file</b>	Manage the logging of system messages to non-volatile memory (NVRAM)

**1 of 2**

Table 60: Logging configuration CLI commands (continued)

Command	Description
<code>set logging server</code>	Define a new Syslog output server for remote logging of system messages
<code>set logging server access-level</code>	Set the access level associated with a Syslog server sink
<code>set logging server condition</code>	Set a filter for messages sent to the specified Syslog server. Messages can be filtered by source system, severity, or both.
<code>set logging server enable   disable</code>	Enable or disable a specific Syslog server
<code>set logging server facility</code>	Define an output facility for the specified Syslog server
<code>set logging session</code>	Manage message logging for the current console session
<code>show logging file condition</code>	Display all conditions that have been defined for the file output sink
<code>show logging file content</code>	Output the messages in the log file to the CLI console
<code>show logging server condition</code>	Display the filter conditions defined for the Syslog output sink
<code>show logging session condition</code>	Display the filter conditions defined for message logging to the current console session
<b>2 of 2</b>	





# Chapter 9: Configuring VoIP QoS

The Avaya G450 Media Gateway provides voice services over IP data networks using VoIP. VoIP is a group of protocols for transmitting and receiving various types of voice data over an IP network. VoIP includes protocols for transmitting and receiving the following types of information:

- Digitally encoded voice data
- Call signalling information
- Call routing information
- QoS information

VoIP uses the RTP and RTCP protocols to transmit and receive digitally encoded voice data. For more information about configuring RTP and RTCP on the Avaya G450 Media Gateway, see [Configuring RTP and RTCP](#) on page 225.

You can use many types of telephones and trunks that do not directly support VoIP. The Avaya G450 Media Gateway translates voice and signalling data between VoIP and the system used by the telephones and trunks.

---

## Configuring RTP and RTCP

VoIP uses the RTP and RTCP protocols to transmit and receive digitally encoded voice data. RTP and RTCP are the basis of common VoIP traffic. RTP and RTCP run over UDP and incur a 12-byte header on top of other (IP, UDP) headers. Running on PPP or frame relay, these protocols can be compressed.

---

## Configuring header compression

Header compression reduces the size of packet headers, thus reducing the amount of bandwidth needed for data. The header compression method is based on the fact that most of the header fields remain constant or change in predictable ways throughout the session. Thus, instead of constantly retransmitting the header, each side keeps a context table of the sessions (the normal headers), and while sending and receiving packets it replaces the full-length headers with one or two bytes CID (context-id) plus unpredictable deltas from the last packet.

The G450 offers both RTP header compression, for reducing the amount of bandwidth needed for voice traffic, and TCP and UDP header compression, for reducing the amount of bandwidth needed for non-voice traffic.

For header compression purposes, any UDP packet with an even destination port within a user-configurable range of ports, is considered an RTP packet.

The G450 enables decompression whenever compression is enabled. However, when enabling header compression on a Frame Relay interface, you must first verify that the remote host is also employing header compression. Header compression on a Frame Relay interface does not check what the remote host is employing. Thus, it may compress headers even when the remote host is not configured to decompress headers.

You can configure how often a full header is transmitted, either as a function of time or of transmitted compressed packets.

---

## Header compression configuration options

The G450 offers two options for configuring header compression:

- IP Header compression (IPHC) method, as defined by RFC 2507. IPHC-type compression applies to RTP, TCP, and UDP headers.
- Van Jacobson (VJ) method, as defined in RFC 1144. VJ compression applies to TCP headers only.

**Note:**

VJ compression and IPHC cannot co-exist on an interface, and IPHC always overrides VJ compression. Thus, if you define both VJ compression and IPHC, only IPHC is enabled on the interface regardless of the order of definition.

**Table 61: Header compression support by interface**

Interface type	Supported compression methods
Serial	
PPP	IPHC and VJ
Sub-Frame-Relay with IETF encapsulation	IPHC only
Sub-Frame-Relay with non-IETF encapsulation	RTP header compression using the IPHC method, and TCP header compression using the VJ method
Dialer	IPHC and VJ

**Note:**

Non-IETF encapsulation is compatible with other vendors.

---

## Configuring IPHC

IHPC applies to RTP, TCP, and UDP headers.

**Note:**

You cannot specify IPHC for a Frame Relay non-IETF interface.

1. Optionally, configure header compression parameters. If you do not configure these parameters, their default values are used.
  - Use the **ip rtp compression-connections** command to control the number of RTP header compression connections supported on the interface. Use the **no** form of this command to restore the default value of 16. This command also sets the number of connections in the non-TCP space, not just RTP.
  - Use the **ip tcp compression-connections** command to control the number of TCP header compression connections supported on the interface. Use the **no** form of this command to restore the default value of 16.
  - Use the **ip rtp max-period** command to set the maximum number of compressed RTP headers that can be sent between full headers.
  - Use the **ip rtp max-time** command to set the maximum number of seconds between full RTP headers.
  - Use the **ip rtp non-tcp-mode** command to set the header compression mode. When set to **ietf**, the command performs IP header compression according to IPHC RFCs. When set to **non-ietf**, the command performs IP header compression compatible with other vendors, which do not strictly follow the RFCs. The default header compression mode is **non-ietf**.

**Note:**

IETF mode is not compatible with non-IETF mode.

## Configuring VoIP QoS

- Use the **ip rtp port-range** command to configure the range of UDP ports for RTP. For example:

```
G450-001(config-if:Serial 4/1:1)# ip rtp compression-connections 48
Done!
G450-001(config-if:Serial 4/1:1)# ip tcp compression-connections 48
Done!
G450-001(config-if:Serial 4/1:1)# ip rtp max-period 512
Done!
G450-001(config-if:Serial 4/1:1)# ip rtp max-time 20
Done!
G450-001(config-if:Serial 4/1:1)# ip rtp non-tcp-mode ietf
Done!
G450-001(config-if:Serial 4/1:1)# ip rtp port-range 40000 50000
Done!
```

2. Use the **ip rtp header-compression** command if you want to enable RTP, TCP, and UDP header compression on the current interface. The compression method employed is IPHC. Alternatively, you can use the following equivalent command:

**ip tcp header-compression iphc-format**

For example:

```
G450-001# interface dialer 1
G450-001(config-if:Serial 4/1:1)# ip rtp header-compression
Done
```

### Note:

Once header compression is enabled, any change to a header compression parameter is effective immediately.

To disable IPHC on an interface, use the **no** form of the command you employed (in the interface context): **no ip rtp header-compression** or **no ip tcp header-compression**.

## Summary of IPHC header compression CLI commands

For more information about these commands, see *Avaya G450 CLI Reference*, 03-300437.

Table 62: IPHC configuration CLI commands

Root level command	First level command	Description
<b>clear ip rtp header-compression</b>		Clear IP RTP header compression statistics for all enabled interfaces or for a specific interface
<b>clear ip tcp header-compression</b>		Clear TCP header compression statistics for all enabled interfaces or for a specific interface

1 of 2

Table 62: IPHC configuration CLI commands (continued)

Root level command	First level command	Description
<b>interface</b> ( <b>dialer serial</b> )		Enter the <code>Dialer</code> or <code>Serial</code> interface context
	<b>ip rtp</b> <b>compression-</b> <b>connections</b>	Control the number of Real-Time Transport Protocol (RTP) connections supported on the current interface
	<b>ip rtp</b> <b>header-compression</b>	Enable both RTP and TCP header compression on the current interface
	<b>ip rtp max-period</b>	Set the maximum number of compressed headers that can be sent between full headers
	<b>ip rtp max-time</b>	Set the maximum number of seconds between full headers
	<b>ip rtp</b> <b>non-tcp-mode</b>	Set the type of IP header compression: <b>ietf</b> or <b>non-ietf</b>
	<b>ip rtp port-range</b>	Set the range of UDP ports considered as RTP on the current interface
	<b>ip tcp</b> <b>compression-</b> <b>connections</b>	Set the total number of TCP header compression connections supported on the current interface
<b>show ip rtp</b> <b>header-compression</b>		Display header compression statistics for a specific interface
<b>show ip rtp</b> <b>header-compression</b> <b>brief</b>		Display a subset of header compression statistics in the form of a table
<b>show ip tcp</b> <b>header-compression</b>		Display TCP header compression statistics for a specific interface
<b>show ip tcp</b> <b>header-compression</b> <b>brief</b>		Display a subset of TCP header compression statistics in the form of a table

2 of 2

## Configuring VJ header compression

VJ header compression applies to TCP headers only.

**Note:**

You cannot specify VJ header compression for a Frame Relay IETF interface.

## Configuring VoIP QoS

1. Optionally, use the **ip tcp compression-connections** command to control the number of TCP header compression connections supported on the interface. Use the **no** form of this command to restore the default value of 16 connections.

For example:

```
G450-001(config-if:Dialer 1)# ip tcp compression-connections 24
Done!
```

2. Use the **ip tcp header-compression** command to enable TCP header compression on the current interface. The compression method employed is the VJ compression.

**Note:**

The **ip rtp header-compression** command always overrides the **ip tcp header-compression** command. Both commands enable TCP header compression, but they differ in the methods employed.

**Note:**

The **ip tcp header-compression iphc-format** command always overrides the **ip tcp header-compression** command, and activates IPHC-type compression.

For example:

```
G450-001# interface dialer 1
G450-001(config-if:Dialer 1)# ip tcp header-compression
Done!
```

**Note:**

Once header compression is enabled, any change to a header compression parameter is effective immediately.

3. To disable VJ TCP header compression on an interface, use the **no ip tcp header-compression** command in the interface context.

## Summary of Van Jacobson header compression CLI commands

For more information about these commands, see *Avaya G450 CLI Reference*, 03-300437.

**Table 63: Van Jacobson header compression CLI commands**

Root level command	First level command	Description
<b>clear ip tcp header-compression</b>		Clear TCP header compression statistics for all enabled interfaces or for a specific interface
<b>interface (dialer serial)</b>		Enter the Dialer or Serial interface context
	<b>ip tcp compression-connections</b>	Set the total number of TCP header compression connections supported on the current interface
	<b>ip tcp header-compression</b>	Enable TCP header compression on the current interface
<b>show ip tcp header-compression</b>		Display TCP header compression statistics for a specific interface
<b>show ip tcp header-compression brief</b>		Display a subset of TCP header compression statistics in the form of a table

## Displaying and clearing header compression statistics

For a full description of the commands and their output fields, see *Avaya G450 CLI Reference*, 03-602056.

- Use the **show ip rtp header-compression** command to display the RTP header compression statistics for a specific interface. If no interface is specified, statistics for all interfaces are displayed.
- Use the **show ip tcp header-compression** command to display the TCP header compression statistics for a specific interface. If no interface is specified, statistics for all interfaces are displayed. Use this command regardless of which compression method is employed.
- Use the **clear ip rtp header-compression** command to clear RTP header compression statistics either for all enabled interfaces or for a specific interface. To clear RTP compression statistics for all enabled interfaces, do not enter an interface type and number. Clearing the statistics does not cause renegotiation of parameters.

## Configuring VoIP QoS

- Use the **clear ip tcp header-compression** command to clear TCP header compression statistics either for all enabled interfaces or for a specific interface. To clear TCP compression statistics for all enabled interfaces, do not enter an interface type and number. Clearing the statistics does not cause renegotiation of parameters. Use this command regardless of which compression method is employed.

---

## Configuring QoS parameters

The G450 uses MGCP (H.248) protocol for call signalling and call routing information. Use the following commands to configure QoS for signalling and VoIP traffic.

- Use the **set qos control** command to define the source for QoS control parameters. The source can be either `local`, in which case the user configures the values locally on the G450, or `remote`, in which case the values are obtained from the G450's registered MGC.
- Use the **set qos signal** command to provide the means to set up QoS parameters for MGCP (H.248) communication with the MGC.
- Use the **show qos-rtcp** command to display the local and downloaded QoS parameters.
- Use the **set qos bearer** command to provide the means to set up QoS parameters for the VoIP bearer.

The parameters you define using the **set qos bearer** command may conflict with the default QoS list (400).

For more information about these commands, including parameters and default settings, see *Avaya G450 CLI Reference*, 03-602056.

---

## Configuring RTCP QoS parameters

Use the following commands to set the RTCP QoS parameters.

- Use the **set qos rtcp** command to permit the setup of RTCP parameters. The parameters that can be set are enabling or disabling RTCP reporting capability, setting the IP address of the monitor, setting the reporting period (the default is five seconds), and defining the listening port number.
- Use the **show qos-rtcp** command to display QoS, RSVP, and RTCP parameters.



---

## RSVP parameters

VoIP can use the RSVP protocol to reserve network resources for voice data while communicating with other media gateways and other VoIP entities, such as, IP phones and Softphones.

- Use the **set qos rsvp** command to set the current values for the RSVP parameters of the VoIP engines. The parameters that can be set are enabled/disabled, refresh rate (seconds), failure retry (y or n), and service profile (Guaranteed or Controlled).
- Use the **show qos-rtcp** command to display QoS, RSVP, and RTCP parameters.

---

## Summary of QoS, RSVP, and RTCP configuration CLI commands

For more information about these commands, see *Avaya G450 CLI Reference*, 03-300437.

**Table 64: QoS, RSVP and RTCP configuration CLI commands**

Command	Description
<b>set qos bearer</b>	Permit the setting of VoIP QoS-bearer related parameters for the Media Gateway Processor and VoIP engines
<b>set qos control</b>	Define the source for QoS control parameters: <code>local</code> or <code>remote</code>
<b>set qos rsvp</b>	Set values for the RSVP parameters of the VoIP engines
<b>set qos rtcp</b>	Set values for RTCP parameters
<b>set qos signal</b>	Set QoS signaling parameters (DSCP or 802.1Q) for the Media Gateway Processor
<b>show qos-rtcp</b>	Display QoS, RSVP, and RTCP parameters

## Weighted Fair VoIP Queuing (WFVQ)

Weighted Fair VoIP Queuing (WFVQ) combines weighted fair queuing (WFQ) for data streams and priority VoIP queuing to provide the real-time response time that is required for VoIP.

WFQ is applied to data streams to provide fair bandwidth distribution among different data streams, with faster response times for shorter packets that are typical for interactive applications, such as, telnet. Priority VoIP queuing is applied to VoIP bearer and signaling traffic.

WFVQ is the default queuing mode for all serial interfaces for which frame relay traffic-shaping is not enabled, and all FastEthernet interfaces for which traffic-shaping is enabled. It is also the only queuing mode available on a per-PVC basis for serial interfaces when frame relay traffic shaping is enabled.

---

## Configuring Weighted Fair VoIP Queueing (WFVQ)

- Use the **fair-queue-limit** command to specify the maximum number of packets that can be queued in the weighted fair queue. The upper and lower limits of this command depend on the amount of bandwidth configured for the interface.

**Note:**

This command should generally be used only for troubleshooting.

- Use either the **voip-queue** or the **priority-queue** command in interface context to disable WFVQ on an interface, by enabling another queuing mode.
- Use the **fair-voip-queue** command in interface context to re-enable WFVQ on an interface. WFVQ is the recommended queuing mode for interfaces.

**Note:**

The **no** form of the **fair-voip-queue** command does not exist. If you enter the command **no fair-voip-queue**, it will actually enable WFVQ if WFVQ is not already enabled.

- Use the **show queueing** command to display WFVQ configuration.
- Use the **show queue** command to display information about the real-time status of output queues for the current interface.

---

## Summary of WFVQ configuration CLI commands

For more information about these commands, see *Avaya G450 CLI Reference*, 03-300437.

**Table 65: WFVQ configuration CLI commands**

Root level command	Command	Description
<b>interface</b> ( <b>serial</b>   <b>fastethernet</b>   <b>dialer</b> )		Enter the Serial, FastEthernet, or Dialer interface configuration context
	<b>fair-queue-limit</b>	Set the maximum number of packets that can be queued in the weighted fair queue
	<b>fair-voip-queue</b>	Enable Weighted Fair VoIP Queuing (WFVQ) on the current interface
	<b>priority-queue</b>	Enable or disable priority queueing mode in a Serial or FastEthernet interface. If you disable priority queueing, WFVQ is re-enabled.
	<b>show queue</b>	Display information about the real-time status of output queues for the current interface
	<b>voip-queue</b>	Enable or disable custom queueing for VoIP traffic. If you disable custom queueing, WFVQ is re-enabled.
<b>show queueing</b>		Display the WFVG configuration

---

## Priority queueing

Priority queueing enables you to queue packets according to the priority of each packet. There are four levels of priority. The total number of packets in all queues cannot exceed 5000.

You can enable priority queueing on the following interfaces:

- Serial (DS1 PPP L2-L3, DS1 PPP L2, USP PPP L2, USP PPP L2-L3)
- FastEthernet (L2, L2-L3) - when Frame Relay Traffic Shaping is configured
- Serial (DS1 FR L2, USP FR L2) - when Frame Relay Traffic Shaping is not configured
- Dialer (L2, L2-L3)

## Configuring VoIP QoS

Priority queuing is disabled by default, since the default and recommended queuing method is WFVQ.

The high priority queue can be further split into two parts for voice traffic: control packets and bearer packets. This is called VoIP queuing. When VoIP queuing is enabled, the bearer queue size is calculated to meet the estimated queuing delay, which is 20 ms by default. You can reestimate the queuing delay, which results in a change in the bearer queue size.

---

## Configuring priority queuing

- Use the **priority-queue** command to enable priority queuing mode in a serial or FastEthernet interface. By default, priority queuing is off, and Weighted Fair VoIP Queuing (WFVQ) is enabled on all Serial interfaces and all FastEthernet interfaces for which traffic-shaping is enabled. If you disable priority queuing by using the **no** form of the **priority-queue** command, WFVQ is re-enabled.
- Use the **queue-limit** command to set the size of any of the four priority queues, in packets, for a given interface or interface type. The default sizes depend on the bandwidth of the interface. Use the **no** form of the command to restore the packet size to its default value, using the interface bandwidth.
- Use the **voip-queue** command to enable VoIP queuing. If you disable VoIP queuing by using the **no** form of the **voip-queue** command, WFVQ is re-enabled.
- Use the **voip-queue-delay** command to set the maximum queue delay for which to estimate the high priority queue size necessary to meet the queuing delay for a specific VoIP codec.
- Use the **show queueing** command to display the queuing configuration.

## Summary of priority queueing configuration CLI commands

For more information about these commands, see *Avaya G450 CLI Reference*, 03-300437.

**Table 66: Priority queueing configuration CLI commands**

Root level command	Command	Description
<b>interface</b> ( <b>serial</b>   <b>fastethernet</b>   <b>dialer</b> )		Enter the Serial, FastEthernet, or Dialer interface configuration context
	<b>priority-queue</b>	Enable or disable priority queueing mode in a Serial or FastEthernet interface. If you disable priority queueing, WFVQ is re-enabled.
	<b>queue-limit</b>	Set the size of any of the four priority queues, in packets, for a given interface or interface type
	<b>voip-queue</b>	Enable or disable custom queueing for VoIP traffic. If you disable custom queueing, WFVQ is re-enabled.
	<b>voip-queue-delay</b>	Set the maximum query delay for which to estimate the high priority queue size necessary to meet the queuing delay
<b>show queueing</b>		Display the priority queue configuration



# Chapter 10: Configuring the G450 for modem use

You can connect either a USB or a serial modem to the Avaya G450 Media Gateway. A USB modem must be connected to the USB port on the G450 chassis. A serial modem must be connected to the Console port (CONSOLE) on the G450 chassis.

Both the USB port and the Console port require configuration for modem use. You can configure the ports for modem use via the Avaya IW or the GIW. For details on using a modem with the G450, see *Installing and Upgrading the Avaya G450 Media Gateway*, 03-602054.

---

## Configuring the USB-modem interface

By default, the USB port is not enabled. To enable the USB port, you must enable the USB-modem interface. Enter **interface usb-modem** to enable the USB-modem interface. Use the **no** form of this command to disable the USB-modem interface. The **no** form of the **interface usb-modem** command also resets the interface to its default parameter values. These values are:

- **Interface status** = down
- **PPP timeout absolute** = 0

---

## Configuring the USB port for modem use

To set the USB port's parameters, use the following commands in the `usb-modem` interface context:

- Enter **async reset-modem** to reset the connected modem. You can use this command from within an active PPP session over the USB modem.
- Use the **async modem-init-string** command to change the default modem initialization string.

## Configuring the G450 for modem use

- Use the **ip address** command to assign an IP address to the USB port. This is the IP address to which a remote user can connect using telnet.

For example, to assign the IP address 192.168.22.33 to the USB port, use the following command:

```
G450-001(if:USB)# ip address 192.168.22.33 255.255.255.0
```

There is no default IP address for the USB port.

- Use the **ppp authentication** command to configure the authentication method used when starting a client session on the PPP server. Use this command with any of the following parameters:
  - **pap**. Password Authentication Protocol. An unencrypted password is sent for authentication.
  - **chap**. Challenge Handshake Authentication Protocol. An encrypted password is sent for authentication. To configure this password, use the **ppp chap-secret** command.

### Note:

If the G450 firmware is replaced by an earlier firmware version, the **ppp chap-secret** is erased, and must be re-configured.

- **ras**. Remote Access Service mode is being used for authentication
- **none**. No password is sent

### Note:

The **ppp authentication** command changes the PPP authentication parameters of the Console port as well as the USB port, even if you use the command in `USB-modem` interface context.

- Use the **ppp timeout authentication** command to set the maximum time to wait for an authentication response.
- Use the **speed** command to set the PPP baud rate to be used by the USB port.
- Enter **shutdown** to disconnect an active PPP session and shut down the modem.
- Use the **timeout absolute** command to set the number of minutes until the system automatically disconnects an idle PPP incoming session. By default, there is no timeout.
- Use the **ip peer address** command to change the IP address offered to a requesting calling host during PPP/IPCP connection establishment. By default, the interface offers its own IP address plus one.
- Use the **show interfaces usb-modem** command to display the USB-modem interface parameters, the current status of the USB port, and the identity of any USB modem connected to the USB port.



## Summary of CLI commands for configuring the USB port for modem use

For more information about these commands, see *Avaya G450 CLI Reference*, 03-300437.

**Table 67: USB port configuration for modem use, CLI commands**

Root level command	Command	Description
<b>interface usb-modem</b>		Enter USB-modem interface configuration context
	<b>async modem-init-string</b>	Change the default modem initialization string
	<b>async reset-modem</b>	Reset the connected modem
	<b>ip address</b>	Assign an IP address and mask to an interface
	<b>ip peer address</b>	Change the IP address offered to a requesting calling host during PPP/IPCP connection establishment
	<b>ppp authentication</b>	Configure the authentication method used when starting a client session on the PPP server
	<b>ppp chap-secret</b>	Configure the shared secret used in PPP sessions with CHAP authentication
	<b>ppp timeout authentication</b>	Set the maximum time to wait for an authentication response
	<b>show ppp authentication</b>	Display PPP authentication status
	<b>shutdown</b>	Disconnect an active PPP session and shut down the modem
	<b>speed</b>	Set the PPP baud rate to be used by the USB port
<b>show interfaces</b>		Display interface configuration and statistics for a particular interface or all interfaces

---

## Configuring the Console port for modem use

The Console port is labeled CONSOLE. The Console port is an RJ-45 socket that functions as a serial port. You can connect a console device or serial modem to the Console port to access the CLI. For more information, see [Accessing the CLI](#) on page 43.

You can set the Console port so that it automatically detects whether a console device or a modem is connected to it. Enter **async mode interactive** to set the Console port to use modem mode every time an Avaya proprietary modem cable is plugged into the Console port. If you do not want the Console port to automatically detect when a modem is connected to it, enter **async mode terminal** to disable interactive mode.

**Note:**

By default, async mode is set to *terminal*.

- Enter **interface console** to enter the Console interface configuration mode. Use the **no** form of this command to set the console parameters to their default values.
- Enter **async reset-modem** to reset the connected modem.
- Use the **async modem-init-string** command to change the default modem initialization string.
- Use the **speed** command to set the PPP baud rate to be used by the Console port when connected to a modem (in bps). Options are 9600, 19200, 38400, 57600, and 115200. The default baud rate is 38400.
- Use the **ip address** command to assign an IP address to the Console port. This is the IP address to which a remote user can connect using telnet. For example, to assign the IP address 192.168.22.33 to the Console port, use the following command:

```
G450-001(if:Console)# ip address 192.168.22.33 255.255.255.0
```

There is no default IP address for the Console port.

- Use the **ppp authentication** command to decide the authentication method used when starting a client session on the PPP server. Use this command with any of the following parameters:
  - **pap**. Password Authentication Protocol. An unencrypted password is sent for authentication.
  - **chap**. Challenge Handshake Authentication Protocol. An encrypted password is sent for authentication. To configure this password, use the **ppp chap-secret** command.

**Note:**

If the G450 firmware is replaced by an earlier firmware version, the **ppp chap-secret** is erased, and must be re-configured.

- **ras**. Remote Access Service mode is being used for authentication
- **none**. No password is sent

**Note:**

This command changes the PPP authentication parameters of the USB port as well as the Console port, even if you use the command in the `Console` interface context.

- Use the `ppp timeout authentication` command to set the maximum time to wait for an authentication response.
- Use the `timeout absolute` command to set the number of minutes until the system automatically disconnects an idle PPP incoming session. By default, there is no timeout.
- Use the `ip peer address` command to change the IP address offered to a requesting calling host during PPP/IPCP connection establishment. By default, the interface offers its own IP address plus one.
- Enter `shutdown` to disconnect an active PPP session and shut down the modem.
- Use the `load-interval` command to set the load calculation interval for the interface.

---

## Summary of CLI commands for configuring the Console port for modem use

For more information about these commands, see *Avaya G450 CLI Reference*, 03-300437.

**Table 68: Console port configuration for modem use, CLI commands**

Root level command	Command	Description
<code>interface console</code>		Enter Console interface configuration context
	<code>async mode interactive</code>	Enter modem mode every time the proprietary modem cable is plugged into the Console port
	<code>async mode terminal</code>	Disable interactive mode on the Console
	<code>async modem-init-string</code>	Change the default modem initialization string
	<code>async reset-modem</code>	Reset the connected modem
	<code>ip address</code>	Assign an IP address and mask to an interface
	<code>ip peer address</code>	Change the IP address offered to a requesting calling host during PPP/IPCP connection establishment
		<b>1 of 2</b>

**Table 68: Console port configuration for modem use, CLI commands (continued)**

Root level command	Command	Description
	<b>ppp authentication</b>	Configure the authentication method used when starting a client session on the PPP server
	<b>ppp chap-secret</b>	Configure the shared secret used in PPP sessions with CHAP authentication
	<b>ppp timeout authentication</b>	Set the maximum time to wait for an authentication response
	<b>show ppp authentication</b>	Display PPP authentication status
	<b>shutdown</b>	Disconnect an active PPP session and shut down the modem
	<b>speed</b>	Set the PPP baud rate to be used by asynchronous PPP ports
	<b>timeout absolute</b>	Set the number of minutes until the system automatically disconnects an idle PPP incoming session

**2 of 2**

## Configuring the console device to connect to the Console port

When you use a console device to access the CLI through the Console port, you must configure the serial connection on the console device to match the configuration of the Console port. The Console port uses the following settings:

- **baud** = 9600
- **data bits** = 8
- **parity** = none
- **stop bits** = 1
- **flow control** = hardware

# Chapter 11: Configuring WAN interfaces

You can use an MM340 E1/T1 media module or an MM342 USP media module as an endpoint for a WAN line on the G450. You can also use a Fast Ethernet port on the G450 chassis as the endpoint for a WAN line by configuring the FastEthernet interface for PPP over Ethernet (PPPoE). The G450 serves as a router, as well as the endpoint, for the WAN line. For more information about routing, see [Configuring the router](#) on page 443.

The G450 supports the following WAN features:

- **PPP over channeled and fractional E1/T1.** The G450 has the ability to map several PPP sessions to a single E1/T1 interface
- **PPP over USP**
- **PPPoE**
- **Unframed E1.** For enabling full 2.048 Mbps bandwidth usage
- **Point-to-Point frame relay encapsulation.** Over channelized, fractional, or unframed E1/T1 ports, or over a USP interface
- **Frame relay.** The G450 supports the following LMI types:
  - **ANSI** (Annex D)
  - **ITU-T:Q-933** (Annex A0)
  - **LMI-Rev1**
  - **No LMI**
- **Backup functionality.** Supported between any type of Serial Layer 2 interface. For more information, see [Backup interfaces](#) on page 268.
- **Dynamic CAC.** For FastEthernet, Serial, and GRE Tunnel interfaces. For more information, see [Dynamic CAC](#) on page 296.
- **Quality of Service (QoS).** The G450 uses Weighted Fair VoIP Queuing (WFVQ) as the default queuing mode for WAN interfaces. WFVQ combines weighted fair queuing (WFQ) for data streams and priority VoIP queuing to provide the real-time response time that is required for VoIP. The G450 also supports the VoIP Queue and Priority Queue legacy queuing methods. For more information, see [Configuring Weighted Fair VoIP Queueing \(WFVQ\)](#) on page 234.
- **Policy.** Each interface on the G450 can have four active policy lists:
  - **Ingress access control list**
  - **Ingress QoS list**
  - **Egress access control list**
  - **Egress QoS list**

## Configuring WAN interfaces

Access control lists define which packets should be forwarded or denied access to the network. QoS lists change the DSCP and 802.1p priority of routed packets according to the packet characteristics. For more information, see [Configuring policy](#) on page 591.

Each interface on the G450 can also have an active policy-based routing list. For more information, see [Configuring policy-based routing](#) on page 619.

- **Header Compression.** Use of header compression reduces the size of packet headers, thus reducing the amount of bandwidth needed for data. RTP header compression enhances the efficiency of voice transmission over the network by compressing the headers of Real Time Protocol (RTP) packets, thereby minimizing the overhead and delays involved in RTP implementation. TCP header compression reduces the amount of bandwidth needed for non-voice traffic. For more information, see [Configuring header compression](#) on page 225.

---

## Serial interface overview

A Serial interface is a virtual interface that is created over a portion of an E1/T1 or USP port on a WAN media module. Serial interfaces support PPP and frame relay encapsulation protocols.

The G450 supports multiple channel groups on the same E1/T1 interface.

### Layer 1 T1 port with two channel groups

[Figure 19](#) illustrates a Layer 1 T1 port with two channel groups defined. All data from each channel group is encapsulated using PPP protocol, and is distributed over the multiple IP interfaces defined for each channel group.

---

**Figure 19: Layer 1 T1 Port**

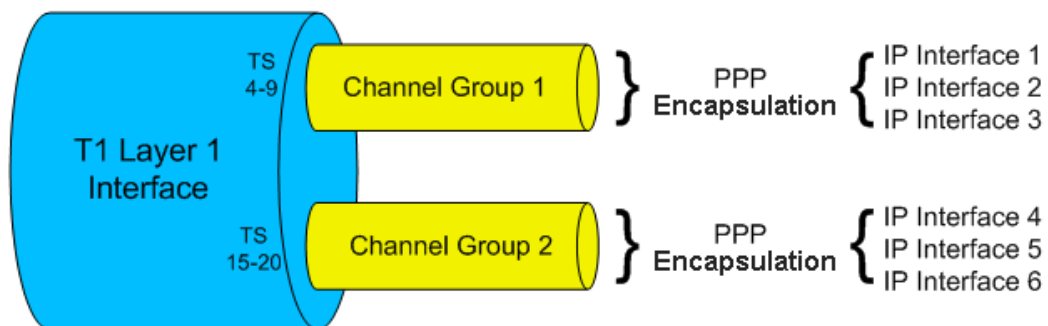

## E1/T1 port channel group

[Figure 20](#) illustrates an E1/T1 port channel group. All data from the channel group is encapsulated using frame relay protocol. The data is sent via a frame relay Serial interface and sub-interfaces over the multiple IP interfaces defined using Data Link Connection Identifier (DLCI).

**Figure 20: E1/T1 Port Channel Group**

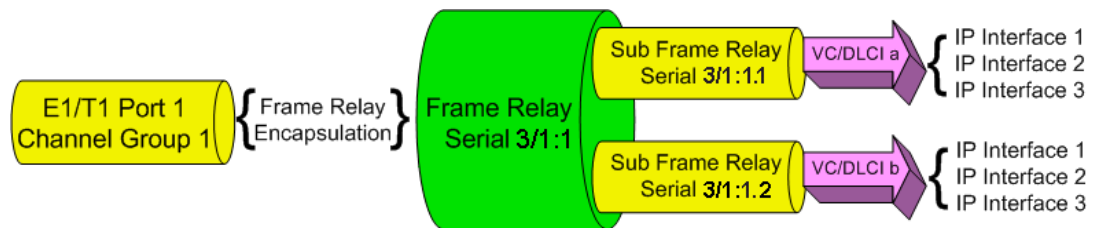

## USP port using PPP protocol

[Figure 21](#) illustrates a USP port. All data from the USP port is encapsulated using the PPP protocol, and is sent via a Serial interface over the multiple IP interfaces defined for the Serial interface.

**Figure 21: USP Port – PPP Protocol**

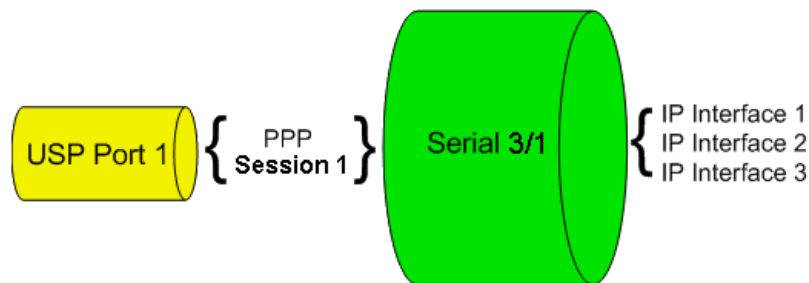

## USP port using frame relay protocol

[Figure 22](#) illustrates a USP port. All data from the USP port is encapsulated using the frame relay protocol, and is sent via a frame relay Serial interface and sub-interfaces over the single IP interfaces defined using DLCI.

Figure 22: USP Port – Frame Relay Protocol

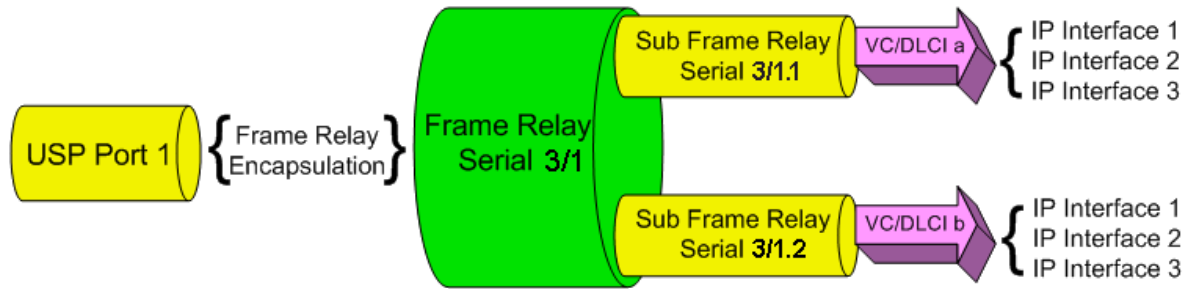

## Frame Relay multipoint topology support

The Avaya G450 Media Gateway supports point-to-point frame relay connections. To enable you to use the G450 as an endpoint in a Point to Multi-Point (PTMP) topology, the G450 supports inverse ARP replies. The G450 responds to inverse ARP queries received on frame relay sub-interfaces with the proper inverse ARP replies.

When you connect the G450 as an endpoint in a PTMP configuration, you need to increase the OSPF timers manually. Use the `ip ospf network point-to-multipoint` command in `Serial` interface context to increase the OSPF timers with the following values:

- Increase the OSPF Hello Interval to 30 seconds
- Increase the OSPF Dead Interval to 120 seconds

For more information on OSPF, see [Configuring OSPF](#) on page 492.

## Initial WAN configuration

1. Add one of the following WAN media modules:
  - Avaya MM340 E1/T1 media module
  - Avaya MM342 USP media module

**Note:**

You can also use a Fast Ethernet port on the G450 chassis as the endpoint for a WAN line by configuring this interface for PPPoE. See [Configuring PPPoE](#) on page 259.



2. Connect the WAN line to the media module. For more information, see *Installing and Upgrading the Avaya G450 Media Gateway*, 03-602054.
3. Configure the WAN interface on the WAN media module.
  - For the MM340, see [Configuring the Avaya MM340 E1/T1 WAN media module](#) on page 249.
  - For the MM342, see [Configuring the Avaya MM342 USP WAN media module](#) on page 254.
4. By default, a G450 WAN interface uses Point-to-Point Protocol (PPP). For instructions on changing the default PPP parameters, see [Configuring PPP](#) on page 257.
5. If you want frame relay encapsulation on the WAN, configure frame relay. See [Configuring frame relay](#) on page 263.
6. Test the WAN configuration. See [Verifying the WAN configuration and testing connectivity](#) on page 266.
7. Enter **copy running-config startup-config** to save the configuration.

---

## Configuring the Avaya MM340 E1/T1 WAN media module

For a list of G450 default settings, see [Table 69](#).

1. Optionally, use the **show controllers** command to display the current settings.
2. Enter **show ds-mode** to check whether the G450 is configured for E1 or T1 operation.
3. Use the **ds-mode** command to set the mode of the G450 to E1 or T1. Changing the line type requires resetting the module. The default value is T1.
4. Use the **controller {e1 | t1} module\_number/port\_number** command to enter Controller context for the port to be configured. The prompt changes to: `(super-if:Serial s/p)#`, where *s* is the slot number of the media module, and *p* is the port number.
5. Use the following commands to change the clock source, frame type, linecode, or cable length parameters from the default settings:
  - For T1 mode:
    - **clock source line|internal** (default is line)
    - **framing sf|esf** (default is sf)
    - **linecode ami|b8zs** (default is ami)
    - **cablelength long|short** (default is long, gain26, 0db)

## Configuring WAN interfaces

### Note:

Use the **cablelength** command to configure the cable's transmit and receive levels. If the cable is longer than 655 feet, use the command **cablelength long gain26 | gain36 -15db | -22.5db | -7.5db | 0db** (default is gain26, 0db). If the cable is 655 feet or less, use the command **cablelength short 133ft | 266ft | 399ft | 533ft | 655ft** (default is 133ft). When using the **cablelength short** form of the command, the transmit attenuation is configured using the loop length.

- **fdl ansi | att | both** (default is both)

### Note:

The **fdl** command defines the type of Facility Data Link loopback that the remote line is requested to enter. This command can only be used when ESF framing is defined.

- For E1 mode:

- **clock source line | internal** (default is line)
- **framing crc4 | no-crc4 | unframed** (default is crc4)
- **linecode ami | hdb3** (default is hdb3)

6. Use the **channel-group** command to specify the channel group and time slots to be mapped, as well as the DS0 speed. For example:

- For T1 mode:

```
channel-group 1 timeslots 1,3-5,7 speed 64
```

configures time slots numbered 1, 3-5, and 7 to be mapped in channel-group number 1, and sets the DS0 speed to 64 kbps. The default DS0 speed for T1 mode is 56.

- For E1 mode:

```
channel-group 1 timeslots 1,3-5,7 speed 64
```

configures time slots numbered 1, 3-5, and 7 to be mapped in channel-group number 1, and sets the DS0 speed to 64 kbps. The default DS0 speed for E1 mode is 64.

7. Enter **exit** to return to general context. The prompt returns to:

```
G450-001(super)#
```

8. Use the **interface serial** command to enter the Serial interface context. Specify the slot number of the media module, the port number, the channel group number, and optionally, the IP interface number.

If you do not specify an IP interface number for the first Serial interface that you define on a channel group, the G450 automatically assigns IP interface number 0. For each additional Serial interface that you define on the channel group, use a different IP interface number. For example:

- **interface serial 3/1:1**. Enter a serial interface on the media module in slot number 3, on port number 1, with channel group number 1.
- **interface serial 4/1:2.3**. Enter a serial interface on the media module in slot number 4, on port number 1, with channel group number 2, and with IP interface number 3.

**Note:**

If you use the **framing unframed** command in Step 5 for an E1 port, a channel group is automatically created on the entire E1 bandwidth. The channel group has the number 0. In Step 8, enter **interface serial s/p:0**, where *s* is the slot number and *p* is the port number.

**Note:**

After the Serial interface is created, its default encapsulation is PPP.

9. Configure the interface encapsulation. By default, the Serial interface uses PPP encapsulation.
10. Use the **ip address** command to configure the IP address and subnet mask of the interface.
11. Enter **exit** to return to general context. The prompt returns to:

```
G450-001 (super) #
```

12. If needed, repeat Step 8 through Step 10 to configure additional IP interfaces on the same channel group.
13. If needed, repeat Step 6 through Step 10 to configure additional channel groups on the same E1 or T1 port.
14. Test the WAN configuration. See [Verifying the WAN configuration and testing connectivity](#) on page 266.
15. Enter **copy running-config startup-config** to save the configuration.

## E1/T1 default settings

Table 69: E1/T1 default settings

Function	Default setting
DS mode	T1
E1 framing	CRC4
T1 framing	SF
E1 linecode	HDB3
T1 linecode	AMI
Clock source	Line
T1 cable length	Long, Gain 26,0 db
Speed	E1: 64kbps T1: 56kbps

## Resetting and displaying controller counters

You can use the following commands to reset counters on a controller interface:

- Use the **clear controller counters** command to reset a specific controller's counters.
- Use the **remote** command to reset the far end counters on a T1 controller interface.

You can use the following commands to display counters on a controller interface:

- Use the **show controllers** command to display a specific controller's status and counters.
- Use the **show controllers remote** command to display controller counters from a peer station.

## Activating loopback mode on an E1/T1 line

You can use the loopback command to activate or deactivate loopback mode for an E1 or T1 line.

- Use the **loopback diag** command to activate or deactivate an inward diagnostic loopback signal on the controller interface.
- Use the **loopback local** command to activate or deactivate a local line or payload loopback signal on the controller interface.

- Use the `loopback remote` command to request a remote station to activate or deactivate a line or payload loopback signal on the controller interface. This command is applicable only to a T1 line.

## Summary of E1/T1 ports configuration commands

For more information about these commands, see *Avaya G450 CLI Reference*, 03-300437.

**Table 70: E1/T1 port configuration CLI commands**

Root level command	Command	Description
<code>clear controller counters</code>		Reset the controller counters
<code>controller</code>		Enter configuration mode for a specific controller
	<code>cablelength long (T1)</code>	Set transmit and receive levels for a cable longer than 655 feet
	<code>cablelength short (T1)</code>	Set transmit levels for a cable of length 655 feet or shorter
	<code>channel-group</code>	Create a channel group logical interface for a PPP or Frame Relay session
	<code>clock source</code>	Set the clock source for an E1 or T1 controller
	<code>fdl</code>	Define the type of Facility Data Link loopback that the remote line is requested to enter
	<code>framing</code>	Set the frame type for an E1 or T1 data line
	<code>linecode</code>	Set the type of line-code transmission for the E1 or T1 line
	<code>loopback</code>	Put a T1 or E1 line into loopback mode or disable loopback mode
	<code>loopback remote</code>	Reset the far end counters on a T1 line
<code>ds-mode</code>		Set the mode of the controller: e1 or t1
<code>interface serial</code>		Enter <code>Serial</code> interface or sub interface configuration context

1 of 2

**Table 70: E1/T1 port configuration CLI commands (continued)**

Root level command	Command	Description
	<b>ip address</b>	Configure the IP address and subnet mask of the interface
<b>show controllers</b>		Display status information about a controller interface
<b>show controllers remote</b>		Display controller statistics from a peer station
<b>show ds-mode</b>		Display the current mode of the controller
		<b>2 of 2</b>

## Configuring the Avaya MM342 USP WAN media module

1. Use the **interface serial** command to enter the context of the interface. Specify the slot number of the media module, the port number, and optionally the IP interface number.

If you do not specify an IP interface number for the first Serial interface that you define on a port, the G450 automatically assigns IP interface number 0. For each additional Serial interface that you define on the port, use a different IP interface number. For example:

- **interface serial 3/1**. Enter a serial interface on the media module in slot number 3, on port number 1.
- **interface serial 4/1.2**. Enter a serial interface on the media module in slot number 4, on port number 1, with IP interface number 2.

For example:

```
G450-001(super)# interface serial 3/1
```

The prompt changes to:

```
G450-001(super-if:serial 3/1)#
```

2. Use the following commands to change the idle characters, transmitter delay, encoding type, bandwidth parameters, line monitoring, and from their default settings:
  - **idle character flags/marks**. Set the bit pattern used to indicate an idle line. Use the **no** form of this command to restore the default value (flags).

- **transmitter-delay number**. Set the minimum number of flags to be sent between successive packets. Use the **no** form of the command to restore the transmitter-delay value to the default (0).

**Note:**

The **transmitter-delay** command is usually used when the DCE equipment that is connected directly to the G450, or the router on the WAN have a receive buffer that is not large enough to hold the traffic sent by the G450. In this case, configure **transmitter-delay** on the DCE equipment or the remote router in order to preserve the high performance that you had when **transmitter-delay** was configured to 0 on the G450.

- **nrzi-encoding**. Enable the non-return-to-zero inverted (NRZI) line coding format on the specified interface. Use the **no** form of the command to disable NRZI encoding.
- **bandwidth kbps**. Set the bandwidth parameter manually for the interface. Use the **no** form of this command to restore the bandwidth parameter to its default value (2,048). The manually specified bandwidth value overrides the dynamically calculated bandwidth during route cost calculations.

**Note:**

If you are using the USP port as a clock source, configure the port's bandwidth to match the DCE clock rate.

- **ignore dcd**. Specify how the system monitors the line to determine if it is up or down. Specify **ignore dcd** to ignore DCD signals, and instead use DSR/CTS signals to determine the line's status. Use the **no** form of the command to specify that DCD signals are used to determine line status.
  - **invert txclock**. Invert the transmit clock signal from the data communications equipment (DCE). Use the **no** form of the command to restore the signal to not inverted.
3. Configure the interface encapsulation. See [Configuring frame relay](#) on page 263.
  4. Enter **exit** to return to general context. The prompt returns to:

```
G450-001 (super) #
```

5. Repeat Step 1 to configure additional Serial interfaces on the USP port.
6. Test the WAN configuration. See [Verifying the WAN configuration and testing connectivity](#) on page 266.
7. Enter **copy running-config startup-config** to save the configuration.

## USP default settings

Table 71: USP default settings

Function	Default setting
Encoding	NRZ
Bandwidth	2,048 kbps
Line-up indicator signal	DCD

## Summary of USP port configuration commands

For more information about these commands, see *Avaya G450 CLI Reference*, 03-300437.

Table 72: USP port configuration CLI commands

Root level command	Command	Description
<b>interface serial</b>		Enter <code>Serial</code> interface or sub interface configuration context
	<b>bandwidth</b>	Set the bandwidth parameter manually for this interface
	<b>idle-character</b>	Set the bit pattern used to indicate an idle line
	<b>ignore dcd</b>	Specify how the system monitors the line to determine if it is up or down
	<b>invert txclock</b>	Invert the transmit clock signal from the data communications equipment (DCE)
	<b>ip address</b>	Configure the IP address and subnet mask of the interface
	<b>nrzi-encoding</b>	Enable or disable the non-return-to-zero inverted (NRZI) line coding format on the interface
	<b>transmitter-delay</b>	Set the minimum number of flags to be sent between successive packets



---

## Configuring PPP

PPP is the default encapsulation on a WAN port. If the encapsulation has been changed to frame relay and you want to restore PPP encapsulation, or to change the PPP parameters:

1. Ensure that you are in the context of a serial interface that is defined on the port. If you are not in the context of a serial interface, use the **interface serial** command. To view all Serial interfaces that are defined, use the **show interfaces serial** command.
2. If the interface is not already configured to use PPP encapsulation, enter **encapsulation ppp** to change the encapsulation to PPP.
3. If you want to change the queuing mode of the interface, see [Weighted Fair VoIP Queuing \(WFVQ\)](#) on page 234 for instructions.
4. Use the following commands to change the interface parameters:
  - **ip address**. Configure the IP address and subnet mask of the interface.
  - **ppp timeout ncp**. Set the maximum time to wait for the network layer to negotiate. If this time is exceeded, the G450 restarts the PPP session.
  - **ppp timeout retry**. Set the maximum time to wait for a response during PPP negotiation.
  - **keepalive**. Enable keepalive or change the interval to which keepalive is set. When activated, keepalive performs the initial negotiation and sends health checks at defined intervals to the other side of the interface. To deactivate keepalive, use the **no** form of the command or set the health check interval to 0.
5. Enter **exit** to return to general context. The prompt returns to:

```
G450-001 (super) #
```

6. Test the WAN configuration. See [Verifying the WAN configuration and testing connectivity](#) on page 266.
7. Enter **copy running-config startup-config** to save the configuration.

## Summary of PPP configuration commands

For more information about these commands, see *Avaya G450 CLI Reference*, 03-300437.

**Table 73: PPP configuration CLI commands**

Root level command	Command	Description
<code>interface serial</code>		Enter <code>Serial</code> interface or sub interface configuration context
	<code>encapsulation</code>	Set the encapsulation mode for a <code>Serial</code> interface: <code>PPP</code> or <code>frame relay</code>
	<code>ip address</code>	Configure the IP address and subnet mask of the interface
	<code>keepalive</code>	Enable PPP keepalive, in order to maintain a persistent connection
	<code>ppp timeout ncp</code>	Set the maximum time, in seconds, that PPP allows for negotiation of a network layer protocol
	<code>ppp timeout retry</code>	Set the maximum time to wait for a response during PPP negotiation
<code>show interfaces</code>		Display interface configuration and statistics for a particular interface or all interfaces

## PPPoE overview

You can configure each ETH WAN Fast Ethernet port as a WAN port using PPPoE (PPP over Ethernet). PPPoE offers dialup style authentication and accounting and allows subscribers to dynamically select their ISP.

PPPoE is a client-server protocol used for carrying PPP-encapsulated data over Ethernet frames. A PPPoE client can establish a tunnel that carries PPP frames between a dialing host (the G450) and an access concentrator. This enables the use of PPP authentication protocols (CHAP and PAP). Unlike other tunneling protocols such as L2TP and PPTP, PPPoE works directly over Ethernet rather than IP.

A typical broadband access network is based on ADSL modems configured as transparent Ethernet bridges. ADSL modems use ATM protocol, and the transparent bridging is done to a well known ATM VC. On the other side of the telephone line is a device called a DSLAM. The DSLAM terminates the ADSL physical layer, collects the ATM cells from the various ADSL subscribers, and places them on the SP ATM infrastructure. The Ethernet frames from the customer's host device can reach one or more access concentrators, which are the remote access servers.

**Figure 23: Typical PPPoE Network Topology**

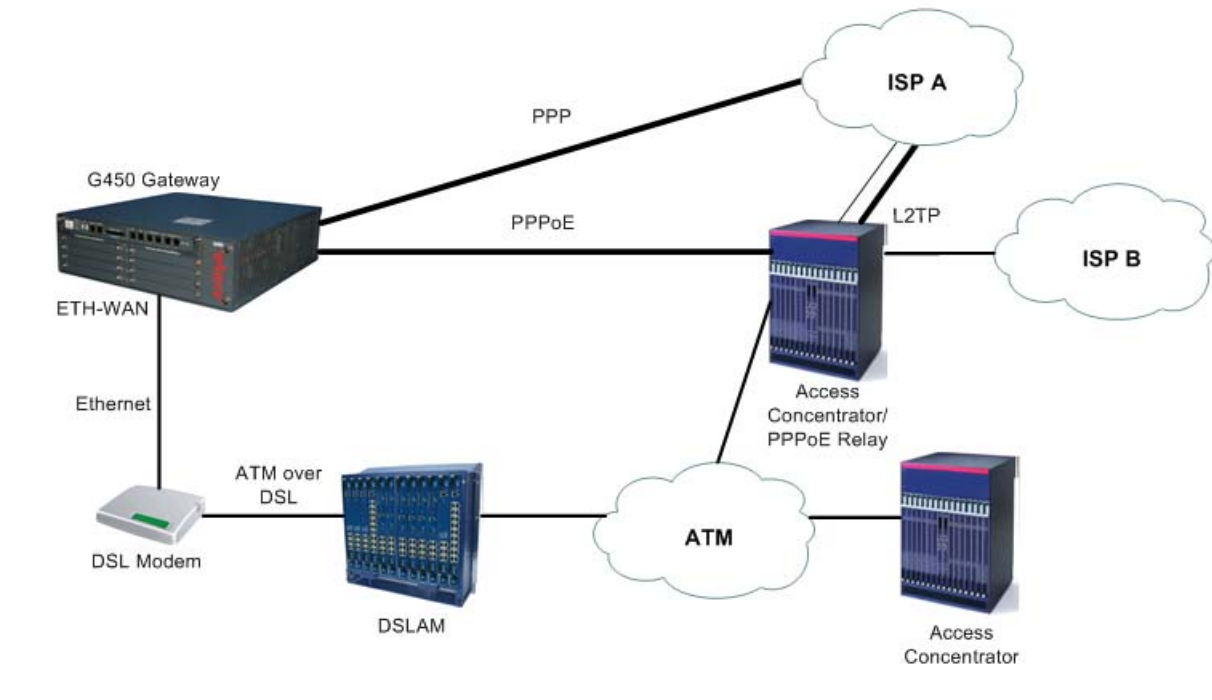

## Configuring PPPoE

1. Enter the `FastEthernet` interface context with the **`interface fastethernet 10/2`** command.
2. Enter **`encapsulation pppoe`** to change the encapsulation to PPPoE. You must change the encapsulation to PPPoE before configuring an IP address on the interface.

### Note:

You cannot use PPPoE if:

- An IP address must not be configured on the interface
- Dynamic CAC is not enabled on the interface. See [Dynamic CAC](#) on page 296.

## Configuring WAN interfaces

- The interface is not part of a primary-backup interface pair. See [Backup interfaces](#) on page 268.
3. Use the **ip address** command to configure an IP address and subnet mask for the interface. In most cases, PPPoE tunnels require a 32-bit subnet mask.

Alternatively, you can enter **ip address negotiated** to obtain an IP address via PPP/IPCP negotiation.

### Note:

You cannot configure PPP/IPCP address negotiation if DHCP address negotiation is already configured on the interface (see [Configuring DHCP client](#) on page 199).

4. Configure an authentication method and parameters:
  - For PAP authenticating, enter **ppp pap-sent username** followed by a user name and password. For example:

```
G450-001(super-if:FastEthernet 10/2)# ppp pap-sent username avaya32 password 123456
Done!
```

- For CHAP authentication, enter **ppp chap hostname** followed by a hostname, and **ppp chap password** followed by a password. For example:

```
G450-001(super-if:FastEthernet 10/2)# ppp chap hostname avaya32
Done!
G450-001(super-if:FastEthernet 10/2)# ppp chap password 123456
Done!
```

5. You can use the following commands to change the interface parameters:
  - **pppoe-client service-name**. Force the PPPoE client to connect only to access concentrators that support a specific service name.  
  
Use the **no** form of this command to deactivate connection to a specific service name. When connection to a specific service name is deactivated, the PPPoE client attempts to automatically discover the service name by initiating PADI frames with a blank service name.
  - **mtu**. Set the interface's MTU to 1492 which ensures that overall packet size for the PPPoE interface does not exceed 1500, which is the MTU for Ethernet.
  - **pppoe-client wait-for-ipc**. Set the amount of time (in seconds) between establishment of the PPPoE tunnel and establishment of the IPCP tunnel. If this time is exceeded, the PPPoE client terminates the PPPoE tunnel.
  - **pppoe-client persistent delay**. Set the interval between pppoe-client dial attempts.
  - **pppoe-client persistent max-attempts**. Limit the number of consecutive connection establishment retries

- **ppp chap refuse**. Prevent authentication with CHAP, even when a chap secret is configured.
- **ppp pap refuse**. Prevent authentication with PAP, even when a pap-sent secret is configured.
- **keepalive-track**. Bind the interface status to an object tracker. When activated, the object tracker sends health check packets at defined intervals to the other side of the interface. If the configured number of consecutive keepalive requests are not answered, the interface track state changes to down. The object tracker continues monitoring the interface, and when its track state changes to up, the interface state changes to up.
- **shutdown** followed by **no shutdown**. Resume trying to establish connections by shutting down and reopening the interface.

For example:

```
G450-001(super)# interface fastethernet 10/2
G450-001(super-if:FastEthernet 10/2)#
G450-001(super-if:FastEthernet 10/2)# shutdown

interface fastethernet 10/2, changed state to administratively down
Line protocol on FastEthernet 10/2, changed state to down
Done!
```

For more information on the PPOE commands, see [Table 74](#).

6. If the G450 is connected to the Internet via the FastEthernet interface configured for PPPoE, and you define a VPN tunnel which specifies remote hosts by name, it is recommended to use the **ppp ipcp dns request** command. The command requests the list of available DNS servers from the remote peer during the PPP/IPCP session. The DNS servers are used by the DNS resolver to resolve hostnames to IP addresses.
7. Enter **exit** to return to general context. The prompt returns to:
 

```
G450-001(super)#
```
8. Test the configuration. See [Verifying the WAN configuration and testing connectivity](#) on page 266.
9. Enter **copy running-config startup-config** to save the configuration.
10. Optionally, shut down the port and the PPPoE client (if configured) with the **shutdown** command in the interface context.

## Summary of PPPoE commands

For more information about these commands, see *Avaya G450 CLI Reference*, 03-300437.

**Table 74: PPPoE CLI commands**

Root level command	Command	Description
<b>interface fastethernet</b>		Enter the <code>FastEthernet</code> interface context
	<b>encapsulation pppoe</b>	Change the encapsulation to PPPoE
	<b>ip address</b>	Configure an IP address and subnet mask for the interface
	<b>ip address negotiated</b>	Obtain an IP address via PPP/IPCP negotiation
	<b>keepalive-track</b>	Bind interface status to an object tracker to check whether the interface is up
	<b>mtu</b>	Set the interface's MTU to 1492, which ensures that overall packet size for the PPPoE interface does not exceed 1500, which is the MTU for Ethernet
	<b>ppp chap hostname</b>	Override the device hostname for PPP CHAP authentication
	<b>ppp chap password</b>	Set the CHAP password for authentication with a remote peer
	<b>ppp chap refuse</b>	Prevent the device from authenticating with CHAP after the device is requested by the remote peer
	<b>ppp ipcp dns request</b>	Enable or disable requesting the list of available DNS servers from the remote peer during the PPP/IPCP session
	<b>ppp pap refuse</b>	Prevent the device from authenticating with PAP after the device is requested by the remote peer
	<b>ppp pap-sent username</b>	Set the Password Authentication Protocol (PAP) password for authentication with the remote peer
	<b>pppoe-client persistent delay</b>	Set the interval between pppoe-client dial attempts

1 of 2

Table 74: PPPoE CLI commands (continued)

Root level command	Command	Description
	<b>pppoe-client persistent max-attempts</b>	Limit the number of consecutive connection establishment retries
	<b>pppoe-client service-name</b>	Set the PPPoE Client service-name
	<b>pppoe-client wait-for-ipcp</b>	Set the amount of time (in seconds) between establishment of the PPPoE tunnel and establishment of the IPCP tunnel. If this time is exceeded, the PPPoE client terminates the PPPoE tunnel.
	<b>shutdown</b>	Shut down the port, and the PPPoE client, if configured

2 of 2

## Configuring frame relay

1. Ensure that the port is configured on the media module:
  - For an E1/T1 port, see [Configuring the Avaya MM340 E1/T1 WAN media module](#) on page 249
  - For a USP port, see [Configuring the Avaya MM342 USP WAN media module](#) on page 254
2. Ensure that you are in the context of a serial interface that is defined on the port. If you are not in the context of a serial interface, use the **interface serial** command. To view all Serial interfaces that are defined, use the **show interfaces serial** command.
3. Use the **encapsulation frame-relay** command to change the encapsulation to frame relay. You can optionally specify the encapsulation type: IETF (RFC1490/RFC2427) or non-IETF. The default encapsulation type is IETF.

**Note:**

Non-IETF encapsulation is compatible with other vendors.

4. If needed, use the **frame-relay lmi** commands to change the Local Management Interface (LMI) parameters from their default values, or enter **frame-relay traffic-shaping** to activate traffic shaping on the frame relay interface. For more information on traffic shaping, see [Frame relay traffic shaping and FRF.12 fragmentation](#) on page 316.

## Configuring WAN interfaces

5. Optionally, change the queuing mode of the interface. See [Weighted Fair VoIP Queuing \(WFVQ\)](#) on page 234 for instructions.
6. Enter **exit** to return to general context. The prompt returns to:

```
G450-001 (super) #
```

7. Enter **interface serial *if.fr-sub-if* point-to-point** to create a frame relay sub-interface and enter the context of the interface. For example:
  - **interface serial 3/1:2.1 point-to-point**. Create frame relay sub-interface number 1 on the E1/T1 media module in slot number 3, on port number 1, with channel group number 2
  - **interface serial 4/1:2.3.2 point-to-point**. Create frame relay sub-interface number 3 on the E1/T1 media module in slot number 4, on port number 1, with channel group number 2, and with IP interface number 2
  - **interface serial 3/1.2 point-to-point**. Create frame relay sub-interface number 2 on the USP media module in slot number 3, on port number 1
  - **interface serial 4/1.2.1 point-to-point**. Create frame relay sub-interface number 2 on the USP media module in slot number 4, on port number 1, with IP interface number 1

**Note:**

Currently only point-to-point frame relay sub-interfaces are supported.

8. Enter **frame-relay interface-dlci *DLCI-number*** to configure a Data Link Connection Identifier (DLCI) for the frame relay sub-interface. You can optionally specify the encapsulation type: `IETF` (RFC1490/RFC2427) or `non-IETF`. The default encapsulation type is `IETF`.

**Note:**

Non-IETF encapsulation is compatible with other vendors.

9. If required, use the **frame-relay priority-dlci-group** command to configure a Priority DLCI group. The arguments for this command are the DLCIs you want to assign to high, medium, normal, and low priority traffic, respectively. For example, the command **frame-relay priority-dlci-group 17 18 19** assigns DLCI 17 to high priority traffic, DLCI 18 to medium priority traffic, and DLCI 19 to normal and low priority traffic. For more information, see [Frame relay traffic shaping and FRF.12 fragmentation](#) on page 316.
10. Use the **ip address** command to configure an IP address and subnet mask for the frame relay sub-interface.
11. Enter **exit** to return to general context. The prompt returns to:

```
G450-001 (super) #
```

12. If needed, repeat Step 7 through Step 11 to configure additional frame relay sub-interfaces on the same Serial interface.



13. If needed, repeat Step 2 through Step 12 to configure frame relay encapsulation for other Serial interfaces on the same WAN port.
14. Test the WAN configuration. See [Verifying the WAN configuration and testing connectivity](#) on page 266.
15. Enter `copy running-config startup-config` to save the configuration.

## Resetting and displaying frame relay interface counters

Use the `clear frame-relay counters` command to reset counters on a specific frame relay interface.

Use the `show interfaces` command to display interface configuration and statistics for a specific interface or for all interfaces.

## Summary of frame relay commands

For more information about these commands, see *Avaya G450 CLI Reference*, 03-300437.

**Table 75: Frame relay CLI commands**

Root level command	Command	Description
<code>clear frame-relay counters</code>		Clear the frame relay counters
<code>interface serial</code>		Enter Serial interface or sub interface configuration mode
	<code>encapsulation</code>	Set the encapsulation mode for a Serial interface
	<code>frame-relay class-dlci</code>	Associate a Virtual Channel with a named QoS or Traffic shaping template (map-class)
	<code>frame-relay interface-dlci</code>	Associate a frame relay Virtual Channel with the current interface
	<code>frame-relay lmi-n391dte</code>	Set the number of status enquiry intervals that pass before issuing a full status enquiry message
	<code>frame-relay lmi-n392dte</code>	Set the maximum number of unanswered status enquiries the equipment accepts before declaring the interface down

1 of 2

**Table 75: Frame relay CLI commands (continued)**

Root level command	Command	Description
	<b>frame-relay lmi-n393dte</b>	Set the number of status polling intervals over which the error threshold is counted (the monitored event count)
	<b>frame-relay lmi-type</b>	Manually define the type of the Local Management Interface (LMI) to use
	<b>frame-relay priority-dlci-group</b>	Assign Virtual Channels to priority classifications, for supporting traffic separation
	<b>frame-relay traffic-shaping</b>	Turn on or off traffic shaping and frame relay fragmentation
	<b>ip address</b>	Configure an IP address and mask for the interface
<b>show interfaces</b>		Display interface configuration and statistics for a particular interface or all interfaces

2 of 2

## Verifying the WAN configuration and testing connectivity

After configuring the new interface, you can perform the following tests to verify that the new interface is operating correctly.

- For E1/T1 interfaces, use the **show controllers** command to view the status of the interface's controller. Verify that the controller is up, and that all error counters do not increase.

For all serial interfaces (E1/T1 and USB-modem), use the **show interfaces serial** command to verify that the interface and line protocol are both up. For example:

```
Serial x/y:z is up, line protocol is up
```

- For USB-modem interfaces only, use the **show interfaces serial** command to verify that all line signals are up. For example:

```
DCD = up DSR = up DTR = up RTS = up CTS = up
```

- Use the **show frame-relay pvc** command to view detailed PVC information, or **show frame-relay pvc brief** for a brief summary of PVC configuration.

- Use the following commands for more information about frame relay configuration:
  - **show frame-relay fragment**. Display frame relay fragmentation statistics and configuration on all PVCs associated with the interface.
  - **show frame-relay lmi**. Display LMI statistics for the interface.
  - **show frame-relay map**. Display a summary table of frame relay sub-interfaces and DLCIs associated with the sub-interfaces.
  - **show frame-relay traffic**. Display frame relay protocol statistics, including ARP requests and replies sent and received over the interface.
  - **show map-class frame-relay**. Display the map-class Frame Relay table.
- Use the **show traffic-shape** command to view traffic shaping and frame relay traffic shaping configuration parameters for all interfaces.
- Use the **show ip interface** command to display information about IP interfaces. To display information about a specific interface, include the name of the interface as an argument. To display information about the interface of a specific IP address, include the IP address as an argument.
- Enter **show running-config** to display the configuration running on the device.
- Enter **show startup-config** to display the configuration loaded at startup.
- Use the **ping** command to send ICMP echo request packets from the G450 to the interface Serial peer IP address and verify that it responds.
- Use the **ping** command to send ICMP echo request packets to another node on the network. Each node is periodically pinged and checked if an answer was received. This checks host reachability and network connectivity.

## Summary of WAN configuration verification commands

For more information about these commands, see *Avaya G450 CLI Reference*, 03-300437.

**Table 76: WAN configuration verification CLI commands**

Command	Description
<b>ping</b>	Check host reachability and network connectivity
<b>show controllers</b>	Display status information about a controller interface
<b>show frame-relay fragment</b>	Display frame relay fragmentation statistics and configuration on all PVCs, all PVCs associated with an interface, or a specific PVC
<b>show frame-relay lmi</b>	Display LMI statistics for a particular interface or for all interfaces. The output displayed differs depending on the type of interface.

1 of 2

Table 76: WAN configuration verification CLI commands (continued)

Command	Description
<code>show frame-relay map</code>	Display a summary table of Frame Relay sub-interfaces and DLCIs associated with the sub-interfaces
<code>show frame-relay pvc</code>	Display detailed PVC information
<code>show frame-relay pvc brief</code>	Display brief PVC information
<code>show frame-relay traffic</code>	Display frame relay protocol statistics, including ARP requests and replies sent and received over Frame Relay interfaces
<code>show interfaces</code>	Display interface configuration and statistics for a particular interface or all interfaces
<code>show ip interface</code>	Display information about an IP interface
<code>show map-class frame-relay</code>	Display the map-class Frame Relay table
<code>show traffic-shape</code>	Display traffic shaping and frame relay traffic shaping configuration information
<b>2 of 2</b>	

---

## Backup interfaces

You can configure backup relations between a pair of any Layer 2 Serial interfaces. A backup interface is activated when the primary interface fails. The backup interface is deactivated when the primary interface is restored. A PPP session, frame relay interface, frame relay sub-interface, Dialer interface, FastEthernet interface, or Loopback interface can serve as a backup interface to any other Serial interface on the same module, including interfaces on different serial ports.

**Note:**

A frame relay interface in a primary or backup role overrides the role of its sub-interfaces.

**Note:**

If the FastEthernet interface serving as a backup interface is configured as a DHCP client, it sends no DHCP packets. Therefore, its IP address is not renewed until it becomes the primary interface.

If the FastEthernet interface serving as a primary interface is configured as a DHCP client, the expiration of the leases on its IP address or no reception of an IP address does not cause activation of the backup interface.

---

## Configuring backup delays

Configurable activation and deactivation delays provide a damping effect on the backup interface pair. This eliminates primary-to-backup switching in case of fluctuating underlying Layer 2 interfaces. You can configure the following backup delays with the **backup delay** command:

- **failure delay.** The time in seconds between the primary interface going down and the backup interface activation. The default is 0 seconds. The maximum is 3600 seconds.
- **secondary disable delay.** The time in seconds between the primary interface restoration and the backup interface deactivation. The default is 0 seconds. The maximum is 3600 seconds. Both interfaces are active during this time to enable a smooth transition for the routing protocols. To keep the backup interface active indefinitely, use **never** as the secondary disable delay.

For example, you can use the following command to switch over immediately to the backup interface in case of failure, and pause 60 seconds before reverting to the primary interface:

```
G450-001(super)# interface fastethernet 10/2
G450-001(super-if:FastEthernet 10/2)# backup delay 0 60
Done!
G450-001(super-if:FastEthernet 10/2)#
```

---

## Interface backup relations rules

- Each interface can have only one backup interface.
- A backup interface can serve as a backup for only one other interface.
- Only one member of a primary and backup pair is active at any given time. An interface is automatically deactivated when configured as backup.
- The backup implementation does not protect against the failure of both interfaces. Therefore, if a backup interface fails while active, no switch to the primary interface is attempted.

## Configuring WAN interfaces

When using frame relay encapsulation, the frame relay interface is considered down when its primary DLCI is down. The switchover back to the main interface occurs when the primary Data Link Connection Identifier (DLCI) is restored.

**Note:**

The backup interface is not activated when the primary interface is administratively disabled.

---

## Backup commands

- Enter **backup interface**, followed by the interface type and number, to set a backup interface. You must use this command from the context of the interface for which you are setting a backup interface.
- Use the **backup delay** command to set the time to wait before switching over to the backup interface, in case of failure. You can also use this command to set a delay before reverting back to the primary interface.

For example, the following command causes the G450 to switch immediately to the backup interface in the event of primary interface failure, and to delay 60 seconds before reverting back to the primary interface once the primary interface is restored to service:

```
G450-001(super-if:FastEthernet 10/2)# backup delay 0 60
```

---

## Summary of backup interfaces commands

For more information about these commands, see *Avaya G450 CLI Reference*, 03-300437.

**Table 77: Backup interfaces CLI commands**

Root level command	Command	Description
<b>interface</b> ( <b>fastethernet</b>   <b>loopback</b>   <b>serial</b>   <b>tunnel</b> )		Enter FastEthernet, Loopback, Serial, or Tunnel interface configuration context
	<b>backup delay</b>	Set the time to wait before switching to the backup interface, in case of failure
	<b>backup interface</b>	Set a backup interface for the current interface

---

## Modem dial backup

The modem dial backup feature allows the Avaya G450 Media Gateway to utilize a modem to provide redundant connectivity between a G450 and IP phones in a small branch office and their primary Media Gateway Controller (MGC) at the headquarters or a regional branch office.

Even if the gateway has Standard Local Survivability (SLS), or Enhanced Local Survivability (ELS) using a local S8300 in LSP mode, it is always preferable to continue working with the primary MGC, since features are lost when the system is fragmented.

Analog modems have limited bandwidth and high latency, and are therefore unfit for carrying VoIP traffic. However, using Dynamic Call Admission Control (CAC), the G450 can be configured to report zero bandwidth for bearer traffic to the MGC when the primary WAN link fails. A matching configuration on the MGC allows it to block new calls, if their bearer is about to go over the modem dial backup interface, and to alert the user with a busy tone. In this case, the user is still able to place external calls manually if local PSTN trunks are available. Furthermore, Avaya Communication Manager 3.0 Inter-Gateway Alternate Routing (IGAR) may be configured to become active in such a case and to use the PSTN for transporting the voice bearer transparently between the sites, transparently to the user. For information about Dynamic CAC in the G450, see [Dynamic CAC](#) on page 296. For information about IGAR, see *Administrator Guide for Avaya Communication Manager*, 03-300509.

Modem dial backup is a generic data dial backup feature that can carry not only signalling but every type of IP traffic. However, the low bandwidth of an analog modem would be likely to cause congestion. The administrator must therefore ensure that VoIP signaling has priority over the Dialer interface. This can be performed using access control lists (ACL), QoS lists, and Weighted Fair Queuing (WFQ) priority schemes. The administrator should apply these tools in both the G450 and the Remote Access Server (RAS). For information on ACL and QoS lists, see [Configuring policy](#) on page 591. For information on WFQ, see [Weighted Fair VoIP Queuing \(WFVQ\)](#) on page 234.

You can configure modem dial backup to dial to an enterprise-owned RAS or to the Internet via an Internet Service Provider (ISP). Most ISPs mandate the use of the internal IPsec VPN gateway process to encrypt the traffic as it goes over the Internet.

**Note:**

IPsec VPN adds overhead to each packet, further reducing available bandwidth.

Under ideal conditions, the bandwidth of the analog modem can reach 56 kbps for downlink (53 kbps in the US) and 33.6 kbps for uplink. However, sub-optimal PSTN quality may degrade the downlink bandwidth to 33.6 kbps, or even 28 kbps. This may not be enough to carry a single ISDN-PRI 64 kbps D-Channel for signalling over H.248 to and from the MGC, even without considering the need to support IP phones and/or analog or DCP trunks.

VoIP signaling consumes bandwidth when setting up and tearing down calls. However, calculations, testing, and field experience show that an analog modem can easily support a small branch office when the expected Busy Hour Call Completion (BHCC) is limited.

## Configuring WAN interfaces

**Note:**

The low bandwidth and high Round-Trip-Time (RTT) of analog modems (~100 ms) may lead to acceptable changes in Post-Dial-Delay (PDD) and offhook-to-dialtone delays.

Modem dial backup uses the G450's backup interface functionality to activate the Dialer interface for modem dial backup when the primary interface fails and to deactivate the Dialer interface when the primary interface is up again. Currently, modem dial backup does not support such features as Dial On Demand Routing (DDR), callbacks, or RAS. Modem dial backup cannot receive backup calls. For more information about backup interfaces, see [Backup interfaces](#) on page 268.

**Note:**

You can only backup one interface with modem dialer backup.

Using the G450's backup interface functionality, you can designate the Dialer interface as the backup for the main WAN link. However, this method is not always available, since an 'up' WAN link status does not ensure connectivity, and the main WAN link may not even be directly connected to the G450.

The workaround is to use the G450's object tracking feature to verify connectivity to the primary MGC using Respond Time Reports (RTRs) and object trackers. Configure object tracking to change the state of the Loopback interface accordingly, and configure the Dialer interface as a backup to the Loopback interface. For more information about object tracking, see [Object tracking](#) on page 298.

Modem dial backup uses a modem connected directly to the G450's USB or Console port. The modem can also be used to access the G450 CLI from a remote location. The modem cannot do both at the same time. For information about remote access to the G450 via modem, see [Accessing the CLI via modem](#) on page 46.

Finally, IP routing must be configured so that traffic to and from the site uses the Dialer interface when the primary interface is down. The Dialer interface can work both with static and dynamic routing (OSPF and RIP). Note that the latter mandates the use of unnumbered IP interfaces. For information about unnumbered IP interfaces, see [Configuring unnumbered IP interfaces](#) on page 448.

**Note:**

Modem dial backup has complex interactions with other configuration modules within the G450 and on your network. Before configuring modem dial-backup, Avaya recommends reading *Application Note - VoIP Network Resiliency*. This document discusses the issues of network design for maximum resiliency, capacity planning for optimum performance, configuration options for network devices, strategies for implementing routing across the network, and security concerns. Based on your existing network design, several redundancy scenarios featuring modem dial backup are available. See [Modem dial backup interactions with other features](#) on page 278 for brief discussions of the various features required for an effective backup scenario for your VoIP installation.



**Note:**

Modem dial backup does not support backup dial-ins or callbacks. Some backup configurations require the remote host to receive a request for connection, acknowledge, end the connection, and dial back the requester. This configuration is not supported.

---

## Typical installations

The Avaya G450 Media Gateway was designed for small branch offices of a larger enterprise. Consequently, the same RAS may serve many branch offices, and, therefore, many G450s. A reasonable assumption is that not all branch offices would need modem dial backup at the same time. Therefore, the ratio of modem channels at the RAS to G450s at branch offices can be less than 1:1. There are several practical ways to configure the RAS server for use with modem dial backup Dialer interfaces:

- The RAS can assign an IP address to the calling G450. This requires the RAS to identify the call gateway using the PAP/CHAP username, and install an appropriate static route to the branch office subnets accordingly. The username, password, and static route can be configured in an external RADIUS/TACACS+ server.
- The RAS server can use OSPF to learn the branch office subnets. This is much simpler to configure as all branch offices can share the same username and password. The G450 is configured to advertise the branch office subnets with OSPF. This feature requires the use of unnumbered IP addresses at the G450 and the RAS. Since the Dialer and the primary interfaces are not expected to be up at the same time, the RAS server can use passive-OSPF-interface and the G450 can use static via routes.
- The G450 can call an ISP RAS (which is likely to assign it a dynamic IP address) and open an IPSec VPN tunnel to an enterprise-owned VPN gateway.

While using OSPF and calling an ISP RAS are expected to be the most common scenarios, they involve complex interaction with IP routing and the remote RAS server. For more detailed configuration examples, see *Application Note - VoIP Network Resiliency*.

---

## Prerequisites for configuring modem dial backup

- At least one dialer string, which determines the phone number(s) of the remote modem(s) dialed by the Dialer interface
- A configured interface to be backed up
- Read/write or admin access level
- A Multitech MultiModem ZBA (MT5634ZBA) or MultimodemUSB (MT5634ZBA-USB) modem
- RAS properties:

## Configuring WAN interfaces

- A dialer string
- Authentication parameters (username, password, PAP/CHAP)
- IP addressing (static, dynamic, or unnumbered)
- Routing (static, RIP, or OSPF)
- IPSec VPN, with all necessary parameters configured

**Note:**

Make sure policy is configured properly at the RAS server to ensure that signaling has priority over regular traffic.

For modem configuration instructions, see [Configuring the G450 for modem use](#) on page 239.

**Note:**

It is recommended to use the maximum UART speed for the serial modem (115400 BAUD).

---

## Configuring modem dial backup

1. From the general context, use the **show interfaces console** or **show interfaces USB-modem** command to verify that the modem is connected. You may be required to enable the modem.
2. Enter **interface dialer**, followed by the identifier, to create the Dialer interface. For example:

```
G450-001(super)# interface dialer 1
G450-001(if:dialer 1)#
```

The Dialer interface is created and can now be defined as a backup interface for an existing WAN interface.

3. Enter up to five dialer strings, using the **dialer string** command. For example:

```
G450-001(if:dialer 1)# dialer string 1 5555555
Done!
G450-001(if:dialer 1)# dialer string 2 1234567
Done!
```

When the Dialer interface is activated, the Dialer first attempts to dial the number associated with dialer string 1. If that attempt fails, the Dialer attempts to connect to the number associated with the next dialer string, and so on.

4. Set the IP address of the Dialer interface with the **ip address** command.

There are three options:

- Manually set the IP address and subnet mask. Use this option when you know to which server the dialed string is going to connect. For example:

```
G450-001(if:dialer 1)# ip address 4.5.6.7 255.255.255.0
Done!
```

- Enter **ip address negotiated**.
  - Enter **ip unnumbered interface**, where **interface** is the name of another interface in the media gateway (for example, the WAN interface) from which an IP address for the Dialer interface is borrowed. Use this command when you do not know who will eventually be your peer and you want to run dynamic routing protocols (for example, OSPF or RIP) over the dialup link.
5. Enter **dialer persistent initial delay**, with the value 30 seconds, to prevent dialup after boot, before the WAN link is fully functional. For example:

```
G450-001(if:dialer 1)# dialer persistent initial delay 30
Done!
```

6. If needed, set any of the following parameters:

- Use the **dialer persistent max-attempts** command to set the maximum number of dial attempts. For example:

```
G450-001(if:dialer 1)# dialer persistent max-attempts 10
Done!
```

The Dialer interface dials each number associated with a dialer string, in order, until either a connection is made, or the number configured in the **dialer persistent max-attempts** command is reached.

- Use the **dialer persistent re-enable** command to enable and configure a timer to re-enable dial attempts after the maximum number of dial attempts has been reached. For example:

```
G450-001(if:dialer 1)# dialer persistent re-enable 3600
Done!
```

- Use the **dialer order** command to set which dial strings are used upon a new dial trigger event. The default is to restart from the beginning of the dial list. For example:

```
G450-001(if:dialer 1)# dialer order last-successful
Done!
```

## Configuring WAN interfaces

- Use the **dialer persistent** command to force the dialer to attempt to reconnect every second, or at another redial interval, which you can configure using the **dialer persistent delay** command. By default, redialing is disabled. For example:

```
G450-001(if:dialer 1)# dialer persistent
Done!
G450-001(if:dialer 1)# dialer persistent delay 10
Done!
```

- Use the **dialer wait-for-ipc** command to set the maximum time the dialer waits between dialing a number to successfully establishing PPP/IPCP. The default is 45 seconds. For example:

```
G450-001(if:dialer 1)# dialer wait-for-ipc 100
Done!
```

### 7. Configure an authentication method and parameters (if required):

- For PAP authenticating, enter **ppp pap sent-username** followed by a username and password. For example:

```
G450-001(if:dialer 1)# ppp pap sent-username avaya32 password 123456
Done!
```

- For CHAP authentication, enter **ppp chap hostname** followed by a hostname, and **ppp chap password** followed by a password. For example:

```
G450-001(if:dialer 1)# ppp chap hostname avaya32
Done!
G450-001(if:dialer 1)# ppp chap password 123456
Done!
```

8. From the general context, use **show interfaces dialer 1** to verify that the Dialer interface has connected to the remote peer. For example:

```
G450-001(super)# show interfaces dialer 1
Dialer 1 is down, line protocol is down
Internet address is 4.5.6.7, mask is 255.255.255.0
MTU 1500 bytes, Bandwidth 28 kbit
IPSec PMTU: copy df-bit, Min PMTU is 300
Reliability 1/255 txLoad 255/255 rxLoad 255/255
Encapsulation PPP
Link status trap disabled
Keepalive track not set
Keepalive set (10 sec)
LCP Starting
IPCP Starting
Last dialed string:
Dial strings:
  1: 5555555
  2: 1234567
Dialing order is sequential
Persistent initial delay 5 sec
Wait 45 sec for IPCP
Weighted Fair VoIP queueing mode
Last input never, Last output never
Last clearing of 'show interface' counters never
5 minute input rate 0 bits/sec, 0 packets/sec
```

This command shows the interface status, including a summary of its definitions and settings. The status also tells you whether the interface is up and the dialup succeeded. In the example status, the interface is down and inactive.

9. Enter the context of the interface which the Dialer is to back up, and use the **backup interface** command to configure the Dialer interface as the backup interface. For example:

```
G450-001(if:serial 3/1:1)# backup interface dialer 1
Done!
```

Interface Dialer 1 is now selected as the backup interface to the selected interface. The Dialer interface is activated in the event of a failure of the primary interface. Upon activation, the Dialer interface dials the number associated with the first dialer string.

10. From the general context, use the **ip default-gateway dialer** command to configure backup routing.

The following example configures a simple low priority via static route:

```
G450-001(super)# ip default-gateway dialer 1 1 low
Done!
```

### Note:

It is recommended that you define multiple routes to ensure that traffic reaches the Dialer interface.

---

## Modem dial backup interactions with other features

Optimal modem dial backup configuration is a complex undertaking, dependent on a large number of factors. For an extensive discussion of network design, capacity planning, routing configuration, device configuration, and security considerations, see *Application Note - VoIP Network Resiliency*. Device and network configuration features that need to be taken into account include:

- The **backup interface** command allows you to designate the Dialer interface as the backup to an existing WAN interface on the G450. When the G450 reports the primary WAN interface down for a specified period of time, the Dialer interface is automatically activated and the modem dials. For more information on the **backup interface** command, see [Backup interfaces](#) on page 268.
- The G450's Console port is an RJ-45 asynchronous port that can be used to support the modem for dial backup. Thus, the Dialer can utilize the same serial modem that is used for remote access to the device. Asynchronous dialing and modem recognition options must be set on the Console port to support creation of the Dialer interface. For more information on configuring the Console port, see [Configuring the Console port for modem use](#) on page 242.
- The Dialer interface supports PAP and CHAP authentication for PPP connections. In addition, the Dialer interface can be configured to be a member of a VPN, allowing encryption of the modem traffic. Van Jacobsen compression is available for encrypted traffic over the Dialer interface, allowing optimal use of bandwidth. For more information on configuring PPP authentication and encryption, see [PPPoE overview](#) on page 258. For more information on heading compression, see [Configuring header compression](#) on page 225.
- It is recommended to filter traffic through the Dialer interface to permit only those packets necessary for continued interaction with the Avaya Communication Manager server. Filtering can be accomplished using access control lists, which specify traffic permissible through a selected interface. For more information on configuring access control lists, see [Configuring policy](#) on page 591.

- Dynamic CAC can be used in conjunction with IGAR to provide a stable backup path for continued IP phone function in the event of a dial backup scenario. Dynamic CAC notifies the Avaya Communication Manager server that no bandwidth is available for bearer traffic, keeping the dial circuit from becoming fully congested. IGAR provides a path for gateway-to-gateway traffic destined for a remote Avaya Communication Manager server by forcing voice calls to and from the branch office to use the PSTN for bearer traffic. For more information on configuring Dynamic CAC, see [Dynamic CAC](#) on page 296. For more information on configuring IGAR, see *Administrator Guide for Avaya Communication Manager*, 03-300509.
- Static IP addressing for the Dialer interface may not be feasible. Dynamic IP addressing is available to enable you to connect to the remote network through an ISP. ISPs commonly provide IP addressing for connected ports on an as-needed basis. IP unnumbered links are available to supply addressing in situations where you wish to run routing over your network link without committing a subnet. For information on configuring dynamic IP addressing, see [Using dynamic local peer IP](#) on page 536. For information on configuring unnumbered IP, see [Configuring unnumbered IP interfaces](#) on page 448.
- Object tracking can be used with the Loopback interface to provide an alternative method for activating the Dialer interface when connectivity with the main office is lost. This is useful in configurations where the WAN interface is not connected directly to the G450. Use object tracking to configure RTRs to verify connectivity with the main office. If the RTR fails, the object tracker can be configured to change the status of the Loopback interface to down. If the Dialer interface is configured as the backup for the Loopback interface, the Dialer interface will automatically dial when connectivity fails. For more information about object tracking, see [Object tracking](#) on page 298.

**Note:**

In a situation where the same modem is used for inbound Avaya Service calls and outbound dial backup calls, only one call can be active at any time.

**Note:**

Refer to [www.multitech.com](http://www.multitech.com) for a listing of modem AT commands used to configure the modem directly.

- You must disable modem dial backup before configuring FIPS.

---

## Configuration example

This example sets up a modem dial backup for the WAN link between a branch office and the headquarters data center. The branch office is connected to the corporate network using a G450. IP phone users in the branch office connect to an MGC located in the headquarters data center, and an RAS is located in the headquarters data center, with multiple phone lines available for dial access. The primary WAN connection is a PPP link connected to the port serial 3/1. The Dialer PPP session uses CHAP encryption. The corporate network is routed using OSPF. An analog trunk connects the branch office to the PSTN for non-corporate bearer traffic.

## Configuring WAN interfaces

[Figure 24](#) shows the network topology.

**Figure 24: Modem dial backup configuration example**

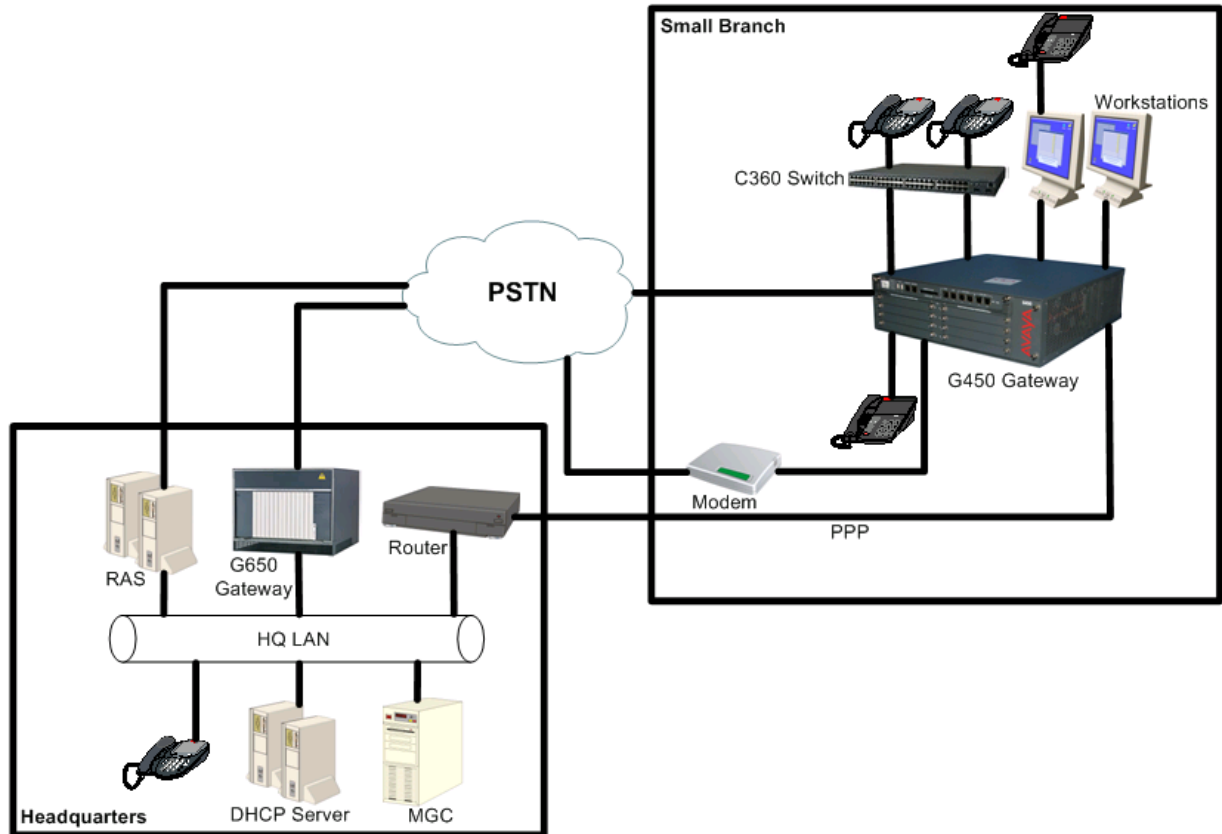



## Command sequence

```
!Step 1
G450-001(super-if:Loopback 1)# exit
G450-001(super)# interface loopback 1
G450-001(super-if:Loopback 1)# ip address 149.49.4.5 255.255.255.252
Done!
G450-001(super-if:Loopback 1)# exit
G450-001(super)#

!Step 2
G450-001(super)# ip access-control-list 305
G450-001(super-ACL 305)# name "Block-RTP-to_Modem-bkp"
Done!
G450-001(super-ACL 305)# ip-rule 20
G450-001(super-ACL 305/ip rule 20)# composite-operation "Deny"
Done!
G450-001(super-ACL 305/ip rule 20)# ip-protocol udp
Done!
G450-001(super-ACL 305/ip rule 20)# dscp 46
Done!
G450-001(super-ACL 305/ip rule 20)# description "Block-VoIP-Bearer"
Done!
G450-001(super-ACL 305/ip rule 20)# exit
G450-001(super-ACL 305)# exit
G450-001(super)#

!Steps 3-10 (Each command is an individual step)
G450-001(super)# interface dialer 1
G450-001(super-if:Dialer 1)# ppp chap hostname "area5"
Done!
G450-001(super-if:Dialer 1)# dialer persistent initial delay 5
Done!
G450-001(super-if:Dialer 1)# dialer persistent delay 5
Done!
G450-001(super-if:Dialer 1)# dialer string 1 3035384867
Done!
G450-001(super-if:Dialer 1)# dialer string 2 7325213412
Done!
G450-001(super-if:Dialer 1)# dialer modem-interface console
Done!
G450-001(super-if:Dialer 1)# ip unnumbered 1 Loopback 1
Done!
G450-001(super-if:Dialer 1)# ip access-group 305 out
Done!
G450-001(super-if:Dialer 1)# exit
G450-001(super)#
```

## Configuring WAN interfaces

```
!Step 11
G450-001(super)# interface console
G450-001(super-if:Console)# async mode interactive
Done!
G450-001(super-if:Console)# async modem-type MultiTech-ZBA
Done!
G450-001(super-if:Console)# exit
G450-001(super)#

Step 12
G450-001(super)# interface serial 3/1:1
G450-001(if:serial 3/1:1)# backup interface Dialer 1
Done!
G450-001(if:serial 3/1:1)# exit
G450-001(super)#

Step 13
G450-001(super)# router ospf
G450-001(super router:ospf)# network 149.49.4.4 0.0.0.3 area 0.0.0.5
Done
G450-001(super router:ospf)# exit
G450-001(super)#
```

### Command sequence explanation

1. Assign an IP address to the Loopback interface for use with modem dial backup using the **interface loopback** command. This step allows the Dialer interface to be configured as an IP unnumbered link and still participate in OSPF routing.
2. Create an access control list with the **ip access-control-list** command. The access control list determines which traffic is permitted to use the interface. In this example, access control list 305 is configured to block all traffic other than VoIP signalling traffic. The primary purpose of the access control list is to block bearer traffic from using the Dialer interface. The Dialer interface generally has insufficient bandwidth to support bearer traffic. For more information on configuring access control lists, see [Configuring policy](#) on page 591.
3. Create the Dialer interface using the **interface dialer** command. The Dialer interface is created and is available as a backup link for a WAN interface. Only one Dialer interface can be created on the G450.
4. Assign a PPP authentication method with the **ppp chap hostname** command. The Dialer interface authenticates its PPP sessions to the remote RAS server using CHAP authentication and a username of area5. The username area5 must be configured on the RAS as a legitimate user.
5. Assign an initial delay for dialing with the **dialer persistent initial delay** command. The initial delay prevents the Dialer from dialing out unnecessarily on reboot. The primary WAN interface often requires a few moments to register itself as up, and during that period, the initial delay prevents the device from activating the Dialer.

6. Assign a reset delay for the dialer string list using the **dialer persistent delay** command. The reset delay determines the amount of time between cycles of call attempts, once all dialer strings have been attempted.
7. Enter up to five dialer strings using the **dialer string** command. When the Dialer interface is activated, the Dialer first attempts to connect to the number associated with dialer string 1. If the connection attempt fails, the Dialer attempts to connect to the number associated with the next dialer string. These strings represent hunt group phone numbers configured on the RAS server in the headquarters data center.
8. Associate the Dialer interface with its physical port with the **dialer modem-interface** command. The Dialer interface must be configured to use a physical interface on the device to which the modem is connected. Modem dial backup is supported on both the Console port and the USB port.
9. Configure the modem to participate in network routing with the **ip unnumbered** command. An unnumbered interface uses the IP address of the interface configured in the command. In this example, the Loopback interface has been created for the Dialer interface to use its IP information. This IP information allows the unnumbered interface to forward and receive IP traffic without actually assigning a static IP address to the Dialer interface.
10. Assign an access control list to the Dialer interface using the **ip access-group** command. All traffic passing through the Dialer interface must meet the conditions of the access control list associated with this access group or be rejected. In this example, the access-group references access control list 305, which is created to block all outgoing traffic across the Dialer interface other than the VoIP signalling traffic between the branch office gateway and the MGC in the headquarters data center.
11. Configure the Console port to support the modem with the **interface console** command. The physical interface must be configured to use the attached modem. Each modem type has different initialization requirements. The only modems supporting modem dial backup are the MultiTech ZBA series modems. For more information on configuring the Console and USB-modem interfaces to support modems, see [Configuring the G450 for modem use](#) on page 239.
12. Assign the Dialer interface to the interface you want to back up with the **backup interface dialer** command. In this example, interface Dialer 1 is selected as the backup interface to interface Serial 3/1:1, the primary WAN connection to the headquarters network. The Dialer activates in the event of a failure of the serial port and all permitted traffic transverses the Dialer interface. For more information on backing up WAN interfaces, see [Backup interfaces](#) on page 268.
13. Configure the Loopback interface to participate in the OSPF network using the **router ospf** command. In this example, a group of branch offices are assigned to OSPF area 5. This configuration allows filtering to take place at the border points and minimizes topology updates on the headquarters data center routers. For more information on configuring OSPF routing, see [Configuring OSPF](#) on page 492.

### Modem dial backup maintenance

The G450 generates specific log messages for Dialer interface activity when configured to do so. Certain dialer-related log messages are generated to aid you in troubleshooting problems with modem dial backup. In addition, messages generated by the modem and the PPP session are available to help with troubleshooting modem dial backup issues.

### Activating session logging

To activate session logging for modem dial backup functions, type the following commands. Logging messages will be sent to the terminal screen.

- `set logging session condition dialer information`
- `set logging session condition console information`
- `set logging session condition usb-modem information`
- `set logging session condition ppp information`

**Note:**

Not all logging messages indicate problems. Some are generated to provide information on normal working activity of the Dialer interface. For more information on logging configuration, see [Configuring logging on page 209](#).

**Note:**

Syslog and log file logging are also available. See [Configuring logging on page 209](#).

### Setting the severity level of the logging session

The `set logging` commands must include a severity level. All logging messages with the specified severity and higher are displayed. The following are the available severity levels:

- **Information.** This message is for informational purposes and requires no action on your part.
- **Debug.** This message provides information that can be useful in debugging certain problems, but requires no action itself.
- **Warning.** This message indicates a condition requiring user intervention and troubleshooting.

Table 78: Modem dial backup logging messages

Log Message	Severity	Possible cause	Action
<b>Dialer Messages – Messages generated by the Dialer interface</b>			
Dialer 1 state is <state>	Debug	The Dialer interface generates a message when a change in its operational state has been detected. The default state for the Dialer interface when it is used as a backup interface for a WAN link is Standby. When the primary WAN link has failed and the backup interface mechanism is invoked, the state of the Dialer interface changes to Up.	None required.
Dialer 1 trigger is <on/off>	Informational	In a modem dial backup scenario, the event triggering the Dialer interface is a failure of the primary WAN interface for which the Dialer interface has been configured as the backup interface. When the primary WAN interface has been determined to be down, a message is sent indicating the occurrence of the triggering event for the Dialer. When the primary WAN interface is returned to an operational state, a message is generated indicating that the conditions for triggering the Dialer are no longer being met, and that the Dialer can be brought down.	None required.

**Table 78: Modem dial backup logging messages (continued)**

Log Message	Severity	Possible cause	Action
Dialer 1 string <string_ID> <dialer_string>	Informational	The value of <string_ID> is equal to the ID of the string configured using the dialer string command. The value of <dialer_string> is equal to the phone number associated with the dialer string. For example, if you configured dialer string 3 to associate with the phone number 5551314, and the modem is attempting to connect using dialer string 3, the message received would be Dialer 1 string 3 5551314.	None required.
Dialer 1 timer expired	Debug	When the Dialer interface is configured with the dialer persistent re-enable command, a timer is created. This timer determines when the Dialer interface attempts to begin dialing again after a failure to connect in as many attempts as were configured in the dialer persistent max-attempts command. For example, if you configured the value of dialer persistent max-attempts as 10, and dialer persistent re-enable is configured for the Dialer interface, after the Dialer has made ten unsuccessful attempts to connect to the remote modem, the timer begins. When the timer expires, the Dialer 1 timer expired message is sent, and the Dialer begins attempting to connect to the remote modem again.	None required.

Table 78: Modem dial backup logging messages (continued)

Log Message	Severity	Possible cause	Action
Dialer 1 Modem is not ready	Warning	This message is generated when the Dialer interface has been triggered and the operational state of the Dialer is up, but the Dialer is unable to communicate with the modem.	Troubleshooting steps: <ul style="list-style-type: none"> <li>● Check modem cable connection to serial port.</li> <li>● Check modem cable connection to modem.</li> <li>● Check power to modem.</li> </ul>
<b>Console Messages – Messages generated by a serial modem attached to the Console port</b>			
Modem cable detected. Port speed <speed> baud.	Informational	When a modem cable is determined to be connected to the serial port, a message is generated indicating the successful connection of the modem cable and advertising the capabilities of the serial port for potential modem connections.	None required.
Modem Detection Failed	Warning	This message is generated when a modem cable is connected to the serial port, but no modem is detected. This message is generated every 30 minutes until the modem is detected.	Troubleshooting steps: <ul style="list-style-type: none"> <li>● Check modem cable connection to modem.</li> <li>● Ensure that modem is powered on.</li> <li>● Check modem lights for an alarm.</li> </ul>
Modem Ready	Informational	When the modem is discovered by the device and the initialization string is successful, a message is generated indicating that the device is ready to dial.	None required.
Init string error	Warning	This message is generated when the USB modem attempts to dial and has an incorrect initialization string. The attempt to dial fails.	Troubleshooting steps: <ul style="list-style-type: none"> <li>● Check modem configuration for proper initialization string.</li> </ul>
			<b>3 of 6</b>

**Table 78: Modem dial backup logging messages (continued)**

Log Message	Severity	Possible cause	Action
Modem cable unplugged	Warning	This message is generated when a Dialer interface is defined, but no modem cable is detected as being connected to the serial port.	Troubleshooting steps: <ul style="list-style-type: none"> <li>• Check modem cable connection to serial port and reseal cable if necessary.</li> </ul>
Connection established	Informational	When the modem successfully connects to a remote modem and a PPP session is fully established, a message is sent indicating that the PPP is ready to transmit and receive traffic.	None required.
<b>USB Modem Messages – Messages generated by a USB modem</b>			
USB modem was detected	Informational	When the USB modem is discovered by the device and the initialization string is successful, a message is generated indicating that the device is ready to dial.	None required.
USB modem - Connection established	Informational	When the USB modem successfully connects to a remote modem and a PPP session is fully established, a message is sent indicating that the PPP is ready to transmit and receive traffic.	None required.
USB modem - Unplugged	Warning	This message is generated when a modem cable is connected to the USB port, but no modem is detected.	Troubleshooting steps: <ul style="list-style-type: none"> <li>• Check modem cable connection to modem and to USB port and reseal if necessary.</li> </ul>
USB modem - Initialization string error	Warning	This message is generated when the USB modem attempts to dial and has an incorrect initialization string. The attempt to dial fails.	Troubleshooting steps: <ul style="list-style-type: none"> <li>• Check modem configuration for proper initialization string.</li> </ul>



Table 78: Modem dial backup logging messages (continued)

Log Message	Severity	Possible cause	Action
<b>PPP Messages – Messages generated by the PPP session</b>			
LCP Up/Down	Informational	LCP is used by PPP to initiate and manage sessions. LCP is responsible for the initial establishment of the link, the configuration of the session, the maintenance of the session while in use, and the termination of the link. LCP is considered Up when the link is being established and configured, and is considered down once the session is fully established and passing traffic. LCP then comes up to pass Link Maintenance packets during the session, and goes down after the maintenance is complete. LCP comes up when a termination request is sent, and goes down when the link is terminated.	None required.
PAP passed/failed	Debug	This message is sent when the authenticating station responds to the PAP authentication request.	None required.
CHAP passed/failed	Debug	This message is sent when the authenticating station responds to the CHAP authentication request.	None required.
			<b>5 of 6</b>

**Table 78: Modem dial backup logging messages (continued)**

Log Message	Severity	Possible cause	Action
IPCP Up/Down	Debug	PPP uses IPCP to define the IP characteristics of the session. IP packets cannot be exchanged until IPCP is in the Up state.	None required.
IPCP IP reject	Warning	This message is generated when IPCP attempts to define the IP characteristics for a PPP session, but does not have the IP address of the local interface to define the session. Without IP address information on both sides of the session, the PPP session cannot begin passing IP traffic.	Troubleshooting steps: <ul style="list-style-type: none"> <li>• Check Dialer interface configuration to ensure an IP address is configured, either as a static address or through Dynamic IP addressing or through IP unnumbered.</li> </ul>

## Summary of modem dial backup commands

For more information about these commands, see *Avaya G450 CLI Reference*, 03-300437.

**Table 79: Modem dial backup CLI commands**

Root level command	Command	Description
<b>interface dialer</b>		Enter the <code>Dialer</code> interface configuration context
	<b>dialer modem-interface</b>	Associate a Dialer with a modem interface
	<b>dialer order</b>	Set which dial strings are used upon a new dial trigger event
	<b>dialer persistent</b>	Force the Dialer to attempt to reconnect every second
	<b>dialer persistent delay</b>	Set the redial interval
	<b>dialer persistent initial delay</b>	Set the minimum delay from boot to persistent dialing
	<b>dialer persistent max-attempts</b>	Set the number of consecutive dial attempts for the dial list
	<b>dialer persistent re-enable</b>	Set the persistent re-enable timer after the maximum number of dial attempts has been reached
	<b>dialer string</b>	Add a phone number to the dial list
	<b>dialer wait-for-ipcp</b>	Set the maximum time the Dialer waits between dialing a number to successfully establishing PPP/IPCP
	<b>ip address</b>	Assign an IP address and mask to an interface
	<b>ip address negotiated</b>	Enable obtaining an IP address via PPP/IPCP negotiation
	<b>ip unnumbered</b>	Configure an interface to borrow an IP address from another interface

1 of 2

Table 79: Modem dial backup CLI commands (continued)

Root level command	Command	Description
	<code>ppp ipcp dns request</code>	Enable requesting DNS information from the remote peer during the PPP/IPCP session
<code>interface (fastethernet   loopback   serial   tunnel)</code>		Enter the Console, FastEthernet, Loopback, Serial, or Tunnel interface configuration context
	<code>backup interface dialer</code>	Set the Dialer interface as the backup interface for the current interface
<code>ip default-gateway dialer</code>		Define a default gateway (router)
<code>router ospf</code>		Enable OSPF protocol on the system and to enter the Router configuration context
<code>set logging session</code>		Manage message logging for the current console session
<code>show interfaces</code>		Display interface configuration and statistics for a particular interface or all interfaces
		<b>2 of 2</b>

---

## ICMP keepalive

The ICMP keepalive feature, formerly known as extended keepalive, is available for WAN FastEthernet interfaces. ICMP keepalive is a mechanism for determining if a certain IP address is reachable. The source interface sends test packets (ping) and waits for a response. If no response is received after a certain number of tries, the connection is declared to be down.

This feature provides a quick means to determine whether the interface is up or down. This is especially important for policy-based routing, in which it is important to determine as quickly as possible whether the next hop is available. See [Configuring policy-based routing](#) on page 619.

### Note:

ICMP keepalive has been replaced by the object tracking feature, which supports keepalive probes over WAN, FastEthernet, Loopback, PPPoE, and Dialer PPP interfaces and Frame relay sub-interfaces. ICMP keepalive is still supported for backward compatibility. For information about object tracking, see [Object tracking](#) on page 298.

Normal keepalive is sufficient for testing the status of a direct connection between two points. However, in many situations, the system needs to know the status of an entire path in order to ensure that packets can safely traverse it.

ICMP keepalive is a mechanism that reports on the status of an IP address *and its next hop*. The destination interface is only declared to be alive if the next hop is also reachable. This feature is critical for mechanisms such as policy-based routing that must guarantee service on a particular path.

**Figure 25: G450 with T1 and xDSL lines**

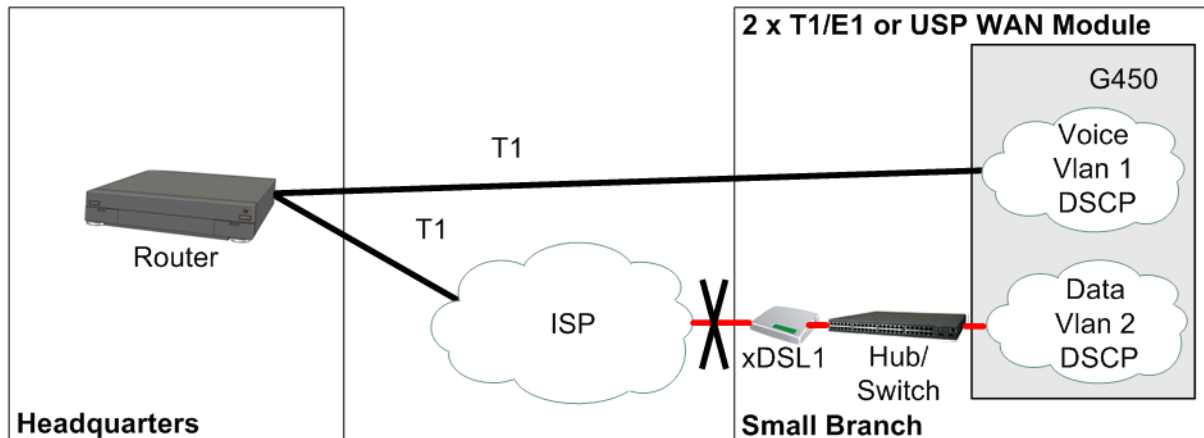

For example, your branch office may have a G450 that connects to the Headquarters over a T1 line and via an xDSL connection to the Internet. The T1 line is used for voice traffic, while data packets are sent over the xDSL line. Normal keepalive cannot report on the status of the entire WAN path. If the Fast Ethernet line protocol is up but the xDSL connected to it is down, normal keepalive reports that the FastEthernet interface is up. Only ICMP keepalive, which checks the next hop, correctly reports that the WAN path is down. Policy-based routing, which relies on the interface status to determine how packets are routed, can use ICMP keepalive to know the status of the interfaces on its next hop list.

**Note:**

ICMP keepalive is not used with a GRE Tunnel interface. The GRE tunnel has its own keepalive mechanism. For details, see [Configuring GRE tunneling](#) on page 456.

**Note:**

You cannot configure both DHCP Client and ICMP keepalive on the same WAN FastEthernet interface. For details on DHCP Client see [Configuring DHCP client](#) on page 199.

## Enabling the ICMP keepalive feature

Use the **keepalive-icmp** command in the context of the interface to enable the ICMP keepalive feature. Use the **no** form of this command to deactivate the feature.

The **keepalive-icmp** command includes the following parameters:

- **destination ip address**. The destination IP address for the keepalive packets.
- **next hop MAC address**. The next hop MAC address for the keepalive packets. This parameter is only relevant for the WAN Fast Ethernet ports.

---

## Defining the ICMP keepalive parameters

Use the following commands to define the ICMP keepalive parameters. For more information about these commands, see *Avaya G450 CLI Reference*, 03-300437.

- Use the **keepalive-icmp timeout** command to set the timeout (in seconds) for receiving the keepalive response. The default value is 1.
- Use the **keepalive-icmp success-retries** command to set the number of consecutive successful keepalive packets necessary to set the interface's keepalive status as up. The default value is 1.
- Use the **keepalive-icmp failure-retries** command to set the number of consecutive failed keepalive packets necessary to set the interface's keepalive status as down. The default value is 4.
- Use the **keepalive-icmp interval** command to set the interval (in seconds) between keepalive packets. The default value is 5.
- Use the **keepalive-icmp source-address** command to set the source IP address of the keepalive packets. The default value is the interface's primary IP address.
- Enter **show keepalive-icmp** to display the interface's ICMP keepalive status and parameters.

## Example of configuring ICMP keepalive

The following example configures ICMP keepalive on interface fastethernet 10/2 to send keepalive packets to IP address 135.64.2.12 using MAC address 11.22.33.44.55.66, at five second intervals. If a response is not received within one second, the keepalive packet is considered to have failed. After three consecutive failed packets, the interface is declared to be down. After two consecutive successful packets, the interface is declared to be up.

```
G450-001# interface fastethernet 10/2
G450-001(super-if:FastEthernet 10/2)# keepalive-icmp 135.64.2.12
11.22.33.44.55.66
G450-001(super-if:FastEthernet 10/2)# keepalive-icmp interval 5
G450-001(super-if:FastEthernet 10/2)# keepalive-icmp timeout 1
G450-001(super-if:FastEthernet 10/2)# keepalive-icmp failure-retries 3
G450-001(super-if:FastEthernet 10/2)# keepalive-icmp success-retries 2
Done!
```

## Summary of ICMP keepalive configuration commands

For more information about these commands, see *Avaya G450 CLI Reference*, 03-300437.

**Table 80: ICMP keepalive CLI commands**

Root level command	Command	Description
<b>interface fastethernet</b>		Enter the FastEthernet interface configuration context
	<b>keepalive-icmp</b>	Enable the ICMP keepalive mechanism on an interface
	<b>keepalive-icmp failure-retries</b>	Set the number of consecutive failed keepalive packets necessary to set the interface's keepalive status as down
	<b>keepalive-icmp interval</b>	Set the interval (in seconds) between keepalive packets
	<b>keepalive-icmp source-address</b>	Set the source IP address of the keepalive packets
	<b>keepalive-icmp success-retries</b>	Set the number of consecutive successful keepalive packets necessary to set the interface's keepalive status as up

1 of 2

**Table 80: ICMP keepalive CLI commands (continued)**

Root level command	Command	Description
	<code>keepalive-icmp timeout</code>	Set the timeout (in seconds) for receiving the keepalive response
	<code>show keepalive-icmp</code>	Display information about the extended keepalive settings

**2 of 2**

---

## Dynamic CAC

Dynamic Call Admission Control (CAC) provides enhanced control over WAN bandwidth. When Dynamic CAC is enabled on an interface, the G450 informs the MGC of the actual bandwidth of the interface and instructs the MGC to block calls when the bandwidth is exhausted.

Dynamic CAC is especially useful in situations where a primary link is down and a backup link with less bandwidth than the primary link is active in its place. Without dynamic CAC, the MGC is unaware that the interface has switched over to the backup link. Thus, the MGC is unaware of the resulting changes in network topology and bandwidth available for the interface. Consequently, the MGC might allow calls through the interface that require more than the currently available bandwidth.

**Note:**

Dynamic CAC works in conjunction with the Avaya Communication Manager Call Admission Control: Bandwidth Limitation (CAC-BL) feature. A related feature is Inter-Gateway Alternate Routing (IGAR), which provides a mechanism to re-route bearer traffic from the WAN to the PSTN under certain configurable conditions. For more information on CAC-BL and IGAR, see *Administrator Guide for Avaya Communication Manager*, 03-300509.

You can enable dynamic CAC on the following interface types:

- **FastEthernet**
- **Serial (PPP or frame relay)**
- **GRE Tunnel**
- **VLAN**

**Note:**

Since VLAN interfaces are always up, configuring dynamic CAC on a VLAN interface provides a means to have a default dynamic CAC bandwidth.



---

## Enabling dynamic CAC and setting maximum bandwidth

Use the `dynamic-cac bbl` command in interface context to enable dynamic CAC on the interface and set the maximum bandwidth for the interface. The `dynamic-cac bbl` command includes the following parameters:

- **bbl**. The bearer bandwidth limit (kbps). The MGC enforces this as the maximum bandwidth for the interface. If you set the bbl to 0, the interface can only be used for signalling.
- **activation priority** (optional). If dynamic CAC is activated on more than one active interface, the G450 reports the bearer bandwidth limit of the interface with the highest activation priority. You can set the activation priority to any number from 1 to 255. The default activation priority is 50.

The following example sets dynamic CAC on FastEthernet interface 10/2, with a bearer bandwidth limit of 128 and an activation priority of 100:

```
G450-001# interface fastethernet 10/2
G450-001(super-if:FastEthernet 10/2)# dynamic-cac 128 100
```

---

## Displaying bandwidth information

Use the `show dynamic-cac` command to display bandwidth information about the interface. The `show dynamic-cac` command displays the following information:

- **Current RBBL**. The current actual bandwidth available on the interface.
- **Last event**. The amount of time since the most recent update by the CAC process.
- **Last event BBL**. The interface's bandwidth at the time of the most recent update by the CAC process.

**Note:**

Dynamic CAC also requires configuration of the Avaya Communication Manager. For details, see *Administrator Guide for Avaya Communication Manager*, 03-300509.

## Summary of dynamic CAC configuration commands

For more information about these commands, see *Avaya G450 CLI Reference*, 03-300437.

**Table 81: Dynamic CAC CLI commands**

Root level command	Command	Description
<code>interface</code> ( <code>dialer</code>   <code>serial</code>   <code>loopback</code>   <code>fastethernet</code>   <code>tunnel</code>   <code>vlan</code> )		Enter the Dialer, Serial, Loopback, FastEthernet, Tunnel, or VLAN interface configuration context
	<code>dynamic-cac</code>	Enable the ICMP keepalive mechanism on the current interface
<code>show</code> <code>dynamic-cac</code>		Display information about the most recent dynamic CAC event

## Object tracking

With the Object tracking feature, you can track the state (up/down) of various objects in the system using keepalive probes, and notify registered applications when the state changes. In particular, object tracking is used to monitor Interface states and routes states, where routes can be static routes, the DHCP client default route, or PBR next hops.

The purpose of object tracking is to track the state (up/down) of various objects in the system using keepalive probes, and notify registered applications when the state changes. Configuring object tracking is a two-stage operation:

- The first stage is to define Respond Time Reports (RTRs), the basic building blocks of object tracking. RTRs actively monitor the reachability state of remote devices by generating probes at regular intervals. Each RTR, identified by a unique number, monitors one remote device, and learns the state of the device: up or down. The state of the RTR reflects the state of the device it is monitoring – either up or down.

- The second stage consists of defining *Object Trackers* using RTRs. The definition of object trackers is recursive. A simple object tracker monitors a single RTR, and its state directly reflects the state of the RTR. A more advanced object tracker is a track list, which is composed of multiple simple object trackers. The state of the track list is calculated based on the states of the objects in the list. Because a track list is itself an object tracker, the objects in a track list can be previously-defined track lists.

You can view a track list as monitoring the “health” of an entire group of remote devices. You can define how to calculate the overall health of the group based on the health (up/down) state of each individual device. For example, you can specify that the overall state is up only if all remote devices are up, or if at least one device is up. Alternatively, you can base the overall state on a threshold calculation.

Using object tracking, different applications can register with the tracking process, track the same remote device(s), and each take different action when the state of the remote device(s) changes.

---

## Object tracking configuration

1. Configure RTRs to monitor remote devices and learn their state (up or down). Each RTR has a state: inactive (not running), up (the remote device is considered up), or down (the remote device is considered down).
2. Configure object trackers to track the states of RTRs. Each object tracker calculates its own state (up or down) based on the states of the elements it is tracking. Whenever the state of an object tracker changes, it notifies the applications registered with it.

An object tracker calculates its own state as follows:

- For an object tracker tracking a single RTR:
  - If the state of the RTR is up, the state of the object tracker is up.
  - If the state of the RTR is inactive or down, the state of the object tracker is down.
- A track list applies a configurable formula (using a Boolean or a Threshold calculation) to the states of the objects comprising the list, and the result (up/down) is the state of the track list. For example, if the configured formula is the Boolean AND argument, then the state of the list is up if the state of all its objects is up, and down if the state of one or more of its objects is down.

### Note:

You can register either a VPN tunnel or an interface with an object tracker. For more information see the definition of the **keepalive-track** command in the *Avaya G450 CLI Reference*, 03-602056.

## Configuring WAN interfaces

### Note:

You cannot configure both DHCP Client and object tracking on the same WAN FastEthernet interface. You can however configure tracking on the DHCP client default route. For more information on DHCP Client see [Configuring DHCP client](#) on page 199.

## Configuring RTR

For each remote device whose state you wish to monitor:

1. Enter **rtr**, followed by a number from 1 to 30, to create the RTR. For example:

```
G450-001(config)# rtr 5
G450-001(config-rtr 5)#
```

2. Use the **type** command to specify the remote device by address, and specify the probing method to be employed by the RTR probe: ICMP Echo or TCP Connection. If you specify a TCP Connection operation, specify also which port to probe in the remote device. For example:

```
G450-001(config-rtr 5)# type echo protocol ipIcmpEcho 10.0.0.1
G450-001(config-rtr icmp 5)#
```

Or

```
G450-001(config-rtr 5)# type tcpConnect dest-ipaddr 147.42.11.1 dest-port
80
G450-001(config-rtr tcp 5)#
```

3. Optionally, use the **frequency** command to specify the frequency at which RTR probes are sent. If you do not configure this parameter, the default value of five seconds is used. For example:

```
G450-001(config-rtr icmp 5)# frequency 2 seconds
Done!
```

4. Optionally, use the **dscp** command to set the DSCP value in the IP header of the probe packet, thus setting the packets' priority. If you do not configure this parameter, the default value of 48 is used. For example:

```
G450-001(config-rtr icmp 5)# dscp 43
Done!
```

5. Optionally, use the **next-hop** command to specify the next-hop for the RTR probe, and bypass normal routing. The **next-hop** command is disabled by default.

Use the **next-hop** command when the G450 is connected to a remote device via more than one interface, and you wish to monitor the state of one specific interface. When you specify the next-hop as the interface you wish to monitor, you ensure that the RTR will probe that interface.

When the RTR is used to monitor a static route, a PBR next hop, or the DHCP client default route, you must specify the same next-hop for the RTR. This ensures it will be sent over the next hop it should monitor.

If the interface is an Ethernet interface (FastEthernet not running PPPoE) or VLAN interface, specify also the interface's MAC address. For example:

```
G450-001(config-rtr icmp 5)# next-hop interface fastethernet 10/2
mac-address 00:01:02:03:04:05
Done!
```

6. Optionally, use the **source-address** command to specify a source IP address, instead of using the output interface's address. By default, the **source-address** command is disabled, and RTR probes use the output interface's address.

Use the **source-address** command when you are probing a device located on the Internet, and specify as the source-address the G450 public IP address. For example:

```
G450-001(config-rtr icmp 5)# source-address 135.64.102.5
Done!
```

7. Optionally, configure the RTR parameters that determine when the state of the remote device is considered up or down. If you do not configure these characteristics, their default values are used:
  - Use the **wait-interval** command to specify how long to wait for a response from the device. When the wait-interval is exceeded, the probe is considered an unanswered probe. The default value is the current value of **frequency**.
  - Use the **fail-retries** command to specify how many consecutive unanswered probes change the state of an RTR from up to down. The default value is 5.

**Note:**

When an RTR starts running, its state is considered up.

## Configuring WAN interfaces

- Use the **success-retries** command to specify how many consecutive answered probes change the state of an RTR from down to up. The default value is 5.

For example:

```
G450-001(config-rtr icmp 5)# wait-interval 2 seconds
Done!
G450-001(config-rtr icmp 5)# fail-retries 3
Done!
G450-001(config-rtr icmp 5)# success-retries 1
Done!
```

8. Exit the RTR type context, and activate the RTR with the **rtr-schedule** command.

### Note:

To deactivate the RTR, use the **no rtr-schedule** command. For example:

```
G450-001(config-rtr icmp 5)# exit
G450-001(config)# rtr-schedule 5 start-time now life forever
```

### Note:

Once an RTR's probing method and remote device address is configured, you cannot change them. If you exit the RTR type context and you want to modify the configuration of the RTR, you can enter the RTR context using the **rtr** command and specifying the RTR ID. From the RTR context, you can run the various modification commands described in steps 3 to 7.

## Configuring object tracking

To configure object tracking, you must first configure at least one simple object tracker, that is, an object tracker that tracks a single RTR. If you wish, you can then configure a track list which contains multiple simple object trackers and specifies how to calculate the overall state of the list. Note that a track list is itself an object tracker. Therefore, you can configure track lists containing object trackers which are either simple object trackers, or other track lists.

### Configuring a simple object tracker

1. Use the **track id rtr** command to specify the RTR to be tracked. Enter a number from 1 to 50 as the unique ID for this object tracker. For example:

```
G450-001(config)# track 1 rtr 5
G450-001(config-track rtr 1)#
```

2. Use the **description** command to enter a description for the object tracker. For example:

```
G450-001(config-track rtr 1)# description "track rtr-5"
Done!
```

## Configuring a track list

1. Use the **track id list** command to enter track list configuration mode, to specify the unique ID of the track list (from 1 to 50), and to specify how to calculate the state of the track list. The calculation can be either a Boolean or a Threshold calculation.

For example:

```
G450-001(config)# track 10 list boolean or
G450-001(config-track list 10)#
```

Or

```
G450-001(config)# track 10 list threshold count
G450-001(config-track list 10)#
```

### Note:

If you do not specify how to calculate the state of the track list, it is calculated by default using the Boolean AND argument. This means that the list is up if all objects are up, and down if one or more of the objects are down.

2. Use the **description** command to enter a description for the track list. For example:

```
G450-001(config-track list 10)# description "track list rtr-5 and rtr-6"
Done!
```

3. Use the **object** command to add an object tracker to the list.

### Note:

The object tracker can be a simple one tracking a single RTR, or a track list. For example:

```
G450-001(config-track list 10)# object 1
Done!
```

4. Repeat step 3 to add as many object trackers as you require, up to a maximum of 50.
5. If you specified a Threshold method of calculation in step 1, use the **threshold count** command to enter the threshold values. For example, use the following command to specify that:

- The state of the object tracker will change from down to up if 2 or more hosts are up, and
- The state of the object tracker will change from up to down if 1 or less hosts are up

```
G450-001(config-track list 10)# threshold count up 2 down 1
Done!
```

**Note:**

Object trackers operate indefinitely once they are defined. To stop the operation of an object tracker, use the **no track** command to delete the object tracker.

---

**Figure 26: Object tracking configuration workflow**

```
rtr
  type
    frequency
    dscp
    next-hop
    source-address
    wait-interval
    fail-retries
    success-retries
rtr-schedule

track id rtr
  description

track id list
  description
  object 1
  .
  .
  object n
  threshold count
```

---

## Object tracking maintenance

Using the **show** commands, you can display RTR and Object Tracking configuration, and enable RTR and object tracking logging to a CLI terminal.

- Use the **show rtr configuration** command to display RTR configuration values, including all defaults, for a specific RTR operation or for all RTR operations.
- Use the **show rtr operational-state** command to display the global operational status of the RTR feature, for a specific RTR operation or for all RTR operations.
- Use the **show track** command to display tracking information.



## Viewing RTR and object trackers logging

1. Enter **set logging session enable** to enable logging to the CLI terminal. For example:

```
G450-001# set logging session enable
Done!
CLI-Notification: write: set logging session enable
```

2. Use the **set logging session condition saa** to view all RTR messages of level Info and above. For example:

```
G450-001# set logging session condition saa Info
Done!
CLI-Notification: write: set logging session condition saa Info
```

3. Use the **set logging session condition tracker** command to view all object tracker messages of level Info and above. For example:

```
G450-001# set logging session condition tracker Info
Done!
CLI-Notification: write: set logging session condition tracker Info
```

## Example of tracking a single remote device

Figure 27: Tracking a single remote device

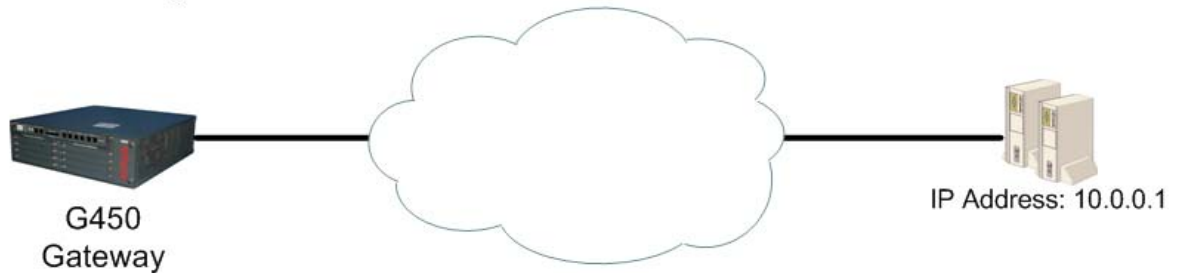

1. The first step is to configure an RTR which tracks a remote device. In this case, RTR 5 is configured to track the device at IP address 10.0.0.1. For example:

```
G450-001(config)# rtr 5
G450-001(config-rtr 5)# type echo protocol ipIcmpEcho 10.0.0.1
G450-001(config-rtr icmp 5)# wait-interval 2 seconds
Done!
G450-001(config-rtr icmp 5)# fail-retries 3
Done!
G450-001(config-rtr icmp 5)# success-retries 1
Done!
G450-001(config-rtr icmp 5)# exit
G450-001(config)# rtr-schedule 5 start-time now life forever
```

2. The second step is to configure an object tracker which tracks the state of RTR 5. For example:

```
G450-001(config)# track 1 rtr 5
G450-001(config-track rtr 1)# description "track rtr-5"
Done!
G450-001(config-track rtr 1)# exit
```

## Example of tracking a group of devices

Figure 28: Tracking multiple remote devices

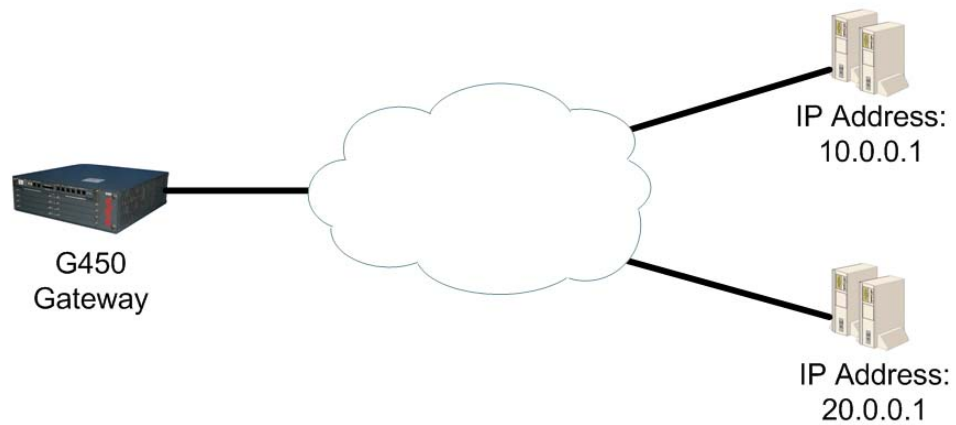

1. The first step is to configure several RTRs. In this case, RTR 5 tracks the device at IP address 10.0.0.1, and RTR 6 tracks the device at IP address 20.0.0.1. For example:

```
G450-001(config)# rtr 5
G450-001(config-rtr 5)# type echo protocol ipIcmpEcho 10.0.0.1
G450-001(config-rtr icmp 5)# wait-interval 2 seconds
Done!
G450-001(config-rtr icmp 5)# fail-retries 3
Done!
G450-001(config-rtr icmp 5)# success-retries 1
Done!
G450-001(config-rtr icmp 5)# exit
G450-001(config)# rtr-schedule 5 start-time now life forever

G450-001(config)# rtr 6
G450-001(config-rtr 6)# type tcpConnect dest-address 20.0.0.1 dest-port
80
G450-001(config-rtr tcp 6)# frequency 500 milliseconds
Done!
G450-001(config-rtr tcp 6)# dscp 34
Done!
G450-001(config-rtr tcp 6)# next-hop interface fastethernet 10/2
mac-address 00:01:02:03:04:05
Done!
G450-001(config)# rtr-schedule 6 start-time now life forever
G450-001(config-rtr tcp 6)# exit
```

## Configuring WAN interfaces

- The second step is to configure several object trackers. In this case, object tracker 1 tracks the state of RTR 5, and object tracker 2 tracks the state of RTR 6. For example:

```
G450-001(config)# track 1 rtr 5
G450-001(config-track rtr 1)# description "track rtr-5"
Done!
G450-001(config-track rtr 1)# exit

G450-001(config)# track 2 rtr 6
G450-001(config-track rtr 2)# description "track rtr-6"
Done!
G450-001(config-track rtr 2)# exit
```

- The third step is to configure a track list object tracker which tracks the states of object trackers 1 and 2, and calculates its own state using a boolean or threshold calculation.

In this case, a Boolean OR argument is used. This means that the track list is up if **either** object tracker 1 **or** object tracker 2 is up. For example:

```
G450-001(config)# track 10 list boolean or
G450-001(config-track list 10)# description "track list rtr-5 and rtr-6"
Done!
G450-001(config-track list 10)# object 1
Done!
G450-001(config-track list 10)# object 2
Done!
G450-001(config-track list 10)# exit
```

---

## Typical object tracking applications

- Trigger the failover mechanism for VPN. See [Typical application – VPN failover using object tracking](#) on page 309.
- Trigger the failover mechanism for interfaces. See [Typical application – backup for a WAN FastEthernet interface](#) on page 309, and [Typical application – interface backup via policy-based routing](#) on page 312.
- Track the state of a route: a static route, a PBR next hop, or the DHCP client default route. For an example of how to track the DHCP client default route, see [Typical application – tracking the DHCP client default route](#) on page 313.

## Typical application – VPN failover using object tracking

In this application, the G450 is connected to a remote site through an IPsec VPN tunnel. The remote site can be reached through two or more VPN gateways that can back each other up, such as a main gateway and a backup gateway. Object tracking can monitor the state of the current VPN connection, by monitoring one or more hosts that reside within the remote site's network. If the current connection is lost, the G450 can failover to a backup gateway, and attempt to establish a VPN connection to it.

A typical application of this type is described in full in [Failover using a peer-group](#) on page 575.

**Figure 29: Failover VPN topology using object tracking**

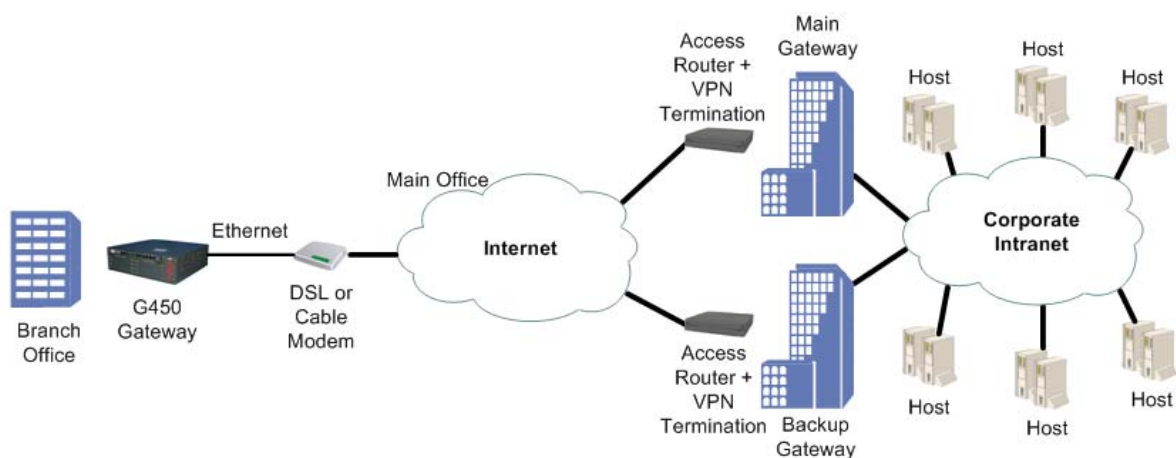

## Typical application – backup for a WAN FastEthernet interface

This typical application illustrates the use of object tracking as a backup mechanism for PPPoE configured on a WAN FastEthernet interface. A track list monitors the state of the connection. If the WAN FastEthernet interface is down, another connection is used.

In this application, the G450 is connected to an xDSL modem via PPPoE encapsulation configured on interface WAN FastEthernet 10/2. The G450 is connected to the Internet via the xDSL modem.

### Configuring the backup mechanism

1. Define four RTRs to probe the four entrances to the main office. Configure each RTR to run immediately and forever.
2. Define four object trackers to track the four RTRs.

## Configuring WAN interfaces

3. Define a track list consisting of all four object trackers, and configure it so that if all object trackers are up, the track list is up, and if two or less of the object trackers are up, the track list is down.
4. Register the WAN FastEthernet interface with the track list.
5. Define the Serial 3/1:1 as a backup interface for the WAN FastEthernet interface.

Thus, when the track list is down the Serial interface will be up until the track list is up again.

### Note:

Note that RTR packets continue to be sent over the PPPoE interface as long as the PPP-IPCP connection status is up.

```
! Define four RTRs to probe the four entrances to the Main Offices.
! Configure each one to run immediately and forever.
!
rtr 1
  type echo protocol ipIcmpEcho 6.0.0.200
  next-hop interface fastethernet 10/2
  exit
rtr-schedule 1 start-time now life forever
rtr 2
  type echo protocol ipIcmpEcho 6.0.0.201
  next-hop interface fastethernet 10/2
  exit
rtr-schedule 2 start-time now life forever
rtr 3
  type echo protocol ipIcmpEcho 6.0.0.202
  next-hop interface fastethernet 10/2
  exit
rtr-schedule 3 start-time now life forever
rtr 4
  type echo protocol ipIcmpEcho 6.0.0.203
  next-hop interface fastethernet 10/2
  exit
rtr-schedule 4 start-time now life forever
```

```
! Define four object trackers to track the four RTRs.
!
track 1 rtr 1
    exit
track 2 rtr 2
    exit
track 3 rtr 3
    exit
track 4 rtr 4
    exit
!
! Define a track list consisting of the four object trackers.
! Define a threshold calculation such that if all four object trackers
! are up, the list is up, and if 2 or less are up, the list is down.
!
track 50 list threshold count
    threshold count up 4 down 2
    object 1
    object 2
    object 3
    object 4
    exit
!
! Configure PPPoE encapsulation on interface WAN FastEthernet 10/2, and
! register the interface with the track list.
!
interface fastethernet 10/2
    bandwidth 96
    encapsulation pppoe
    traffic-shape rate 96000
    ip address negotiated
    keepalive-track 50
    exit
!
! Configure the serial 3/1:1 interface
!
interface serial 3/1:1
    encapsulation ppp
    ip address 10.0.0.1      255.0.0.0
    exit
!
! Assign the serial 3/1:1 interface to be the backup interface for
! interface WAN FastEthernet 10/2.
!
interface fastethernet 10/2
    backup interface Serial 3/1:1
    backup delay 0 60
    exit
```

### Typical application – interface backup via policy-based routing

In the previous typical application (see [Typical application – backup for a WAN FastEthernet interface](#) on page 309), the **backup interface** command is used to specify a backup interface. This typical application illustrates an alternative to the **backup interface** command, using policy-based routing (PBR) which configures a routing scheme for specified traffic based on configured characteristics of the traffic. Thus, PBR can be used in combination with object tracking to configure a backup mechanism for interfaces.

For an example that uses policy-based routing as an alternative to the **backup interface** command, replace the last four lines of the previous typical application with the example below. The example creates a next hop list that sends the specified traffic to the WAN FastEthernet interface, which is running PPPoE encapsulation. If the WAN FastEthernet interface becomes unavailable, the next hop list routes the traffic to the Serial interface 3/1:1. PBR list 801 is created and assigned to interface VLAN 1, so that traffic defined in PBR list 801 passing through interface VLAN 1 is routed according to the next hop list.

**Note:**

You can define a static route over the WAN FastEthernet interface running DHCP client. In such a case, the static route uses as the next hop the default router learned from the DHCP server. This is useful for GRE tunnels which are defined over the WAN Fast Ethernet running DHCP client. It is necessary to define static routes in order to prevent loops. Therefore, the IP route command allows configuration of static routes over WAN Fast Ethernet running DHCP client.



When the WAN Fast Ethernet is up, policy-based routing routes this traffic via the WAN FastEthernet interface. When the track list defined in the previous typical application is down, policy-based routing routes this traffic through the Serial interface 3/1:1. When the track list is up again, the traffic is again routed through the WAN FastEthernet interface.

```

! Create PBR list 801. This list routes traffic from IP address
! 149.49.42.1 to IP address 149.49.43.1 according to next hop list 10.
!
ip pbr-list 801
  name "list #801"
  ip-rule 10
    next-hop list 10
    source-ip host 149.49.42.1
    destination-ip host 149.49.43.1
  exit
exit

!
! Assign PBR list 801 to interface Vlan 1.
!
interface Vlan 1
  icc-vlan
  ip pbr-group 801
  ip address 149.49.42.254 255.255.255.0
  exit

!
! Configure next hop list 10 with interface fastethernet 10/2 as the
! first next hop, and interface Serial 3/1:1 as the second next hop.
!
ip next-hop-list 10
  next-hop-interface 5 FastEthernet 10/2
  next-hop-interface 10 Serial 3/1:1
  exit

```

## Typical application – tracking the DHCP client default route

This typical application demonstrates a case where a user configures DHCP client on the device to enable cable modem connection to a WAN FastEthernet interface. The user wishes to know whether the DHCP client default route can be used for routing decisions –that is, whether traffic can be routed over this default route. To do so, the user activates tracking to monitor the remote HQ peer. When the object tracker is up, the DHCP default route may be used. When the object tracker is down, the DHCP default route is not used for routing and traffic is routed to alternate routes.

## Configuring WAN interfaces

### Note:

If several default routers are learned from a specific interface, the object tracker tracks only the first one.

```
! Apply DHCP client on a WAN Fast Ethernet
!
interface fastethernet 10/2
    ip address dhcp
    exit
!
! Configure the RTRs and object trackers.
! Use the next-hop command to ensure that the RTR is sent over the
! next hop it is monitoring, which is the WAN Fast Ethernet running
! DHCP client.
!
! 192.30.3.1 is the remote HQ peer IP address.
!
rtr 2
    type echo protocol ipIcmpEcho 192.30.3.1
    next-hop interface fastethernet 10/2
    exit
track 2 rtr 2
    exit
!
! Apply object tracking on the DHCP client.
!
interface fastethernet 10/2
    ip dhcp client route track 2
    exit
```

---

## Summary of object tracking configuration commands

For more information about these commands, see *Avaya G450 CLI Reference*, 03-300437.

**Table 82: Object tracking CLI commands**

Root level command	First level command	Second level command	Description
<b>rtr</b>			Enter Respond Time Reports (RTR) configuration mode. RTRs are the basic building blocks of object tracking.
	<b>type</b>		Set the type of operation an RTR should employ in its probes, and specify the address of the remote device being probed

1 of 2

Table 82: Object tracking CLI commands (continued)

Root level command	First level command	Second level command	Description
		<b>dscp</b>	Set the DSCP value for the packets of the RTR probes
		<b>fail-retries</b>	Set how many consecutive unanswered probes change the status of an RTR operation device from up to down
		<b>frequency</b>	Set the frequency of the RTR probes
		<b>next-hop</b>	Specify the next hop for the RTR probes, bypassing normal routing
		<b>source-address</b>	Set the source IP address for RTR operations
		<b>success-retries</b>	Set how many consecutive answered probes change the status of an RTR operation device from down to up
		<b>wait-interval</b>	Set how long to wait for a device to answer an RTR probe
<b>rtr-schedule</b>			Activate or stop an RTR operation
<b>show rtr configuration</b>			Display RTR configuration values
<b>show rtr operational-state</b>			Display the global operational status of the RTR feature
<b>show track</b>			Display tracking information
<b>track</b>			Configure an object tracker
	<b>description</b>		Set a description for the object tracker
	<b>object</b>		Add an object tracker to a track list
	<b>threshold count</b>		Set the upper and lower thresholds for the threshold in the track list command

## Frame relay encapsulation features

The Avaya G450 Media Gateway supports the following frame relay encapsulation features:

- [Frame relay traffic shaping and FRF.12 fragmentation](#)
- [Priority DLCI](#)

**Note:**

The terms PVC (Permanent Virtual Circuit) and DLCI (Data Link Connection Identifier) describe the same entity and are interchangeable.

To improve voice quality using RTP, see [Configuring header compression](#) on page 225.

---

## Frame relay traffic shaping and FRF.12 fragmentation

Frame relay traffic shaping regulates the outgoing traffic rate on a per-DLCI basis. Each DLCI maintains a weighted fair VoIP queue scheduler to buffer the packets.

FRF.12 fragmentation allows for link fragmentation and interleaving (LFI), which reduces the serialization delay on narrow bandwidth PVCs. This is required for VoIP traffic.

You can configure the traffic shaping and fragmentation parameters within traffic shaping templates called map classes. A map class is comprised of the following parameters:

- **CIR.** Default = 56,000 bps
- **Committed Burst (BC) size.** Default = 7,000 bits
- **Excess Burst (BE) size.** Default = 0 bits
- **Fragmentation.** Fragment size, in bytes. Default = No Fragmentation.

You can configure up to 128 different map classes using different combinations of traffic shaping parameters. You then apply these map classes to a PVC.

**Note:**

For a Priority DLCI group you must configure the Primary VC before associating a DLCI map class to the Priority DLCI group VCs. Removing the Primary VC after associating a DLCI map class to the Priority LCI group VCs, removes their map class configuration.

You can enable traffic shaping on a frame relay interface with the **frame-relay traffic-shaping** command. After you enable traffic shaping, a default map class is applied to all currently configured PVCs.

## Configuring map classes

Use the **map-class frame-relay** command to create a map class, and to enter the configuration context of the map class.

Use the **cir out** command to configure the CIR, in bits per second, for the outbound direction.

Use the **bc out** command to configure the BC size, in bits, for the outbound direction.

Use the **be out** command to configure the BE size, in bits, for the outbound direction.

Use the **fragment** command to turn FRF.12 fragmentation on or off and to configure the fragment size.

## Displaying configured map classes

Use the **show map-class frame-relay** command to display a table of all configured map-classes.

## Summary of frame relay traffic shaping commands

For more information about these commands, see *Avaya G450 CLI Reference*, 03-300437.

**Table 83: Frame relay traffic shaping CLI commands**

Root level command	Command	Description
<b>interface serial</b>		Enter the <code>Serial</code> interface or sub interface configuration context
	<b>frame-relay traffic-shaping</b>	Turn on/off traffic shaping and frame relay fragmentation
<b>map-class frame-relay</b>		Create a map class, a QoS template which can later be assigned to DLCIs, and enter the configuration context of the map class
	<b>bc out</b>	Configure the committed burst size in blts, for the outbound direction
	<b>be out</b>	Configure the excess burst size in bits, for the outbound direction
	<b>cir out</b>	Configure the Committed Information Rate in bits per second, for the outbound direction

1 of 2

**Table 83: Frame relay traffic shaping CLI commands (continued)**

Root level command	Command	Description
	<b>fragment</b>	Turn FRF.12 fragmentation on or off and configure the fragment size
<b>show map-class frame-relay</b>		Display the map class table

**2 of 2**

---

## Priority DLCI

To implement new priority mechanisms, ISPs rely on new classes of service. Traffic types and users are divided into these classes and treated differently during peak periods. A premium, or first class user or traffic stream receives higher priority than a general user. This rating system ensures that the critical Internet user maintains peak performance. It also provides a means for ISPs to enhance the cost structure of network operations.

The G450 supports class-based traffic assignment (priority DLCI). Priority DLCI is a means for implementing QoS on frame relay circuits. The G450 separates traffic with different QoS levels to up to four different VCs on the same frame relay sub-interface. This feature enables you to assign unique Permanent VCs (PVC) for VoIP and non-VoIP traffic. You can set and adjust the priority using policy. For more information, see [Configuring policy](#) on page 591.

Configure Priority DLCI using the **frame-relay priority-dlci-group** command in the *Serial* sub-interface context. Specify the DLCIs in this command from the highest to lowest priority. If you specify less than four DLCIs, the last DLCI specified is automatically used for the missing priorities.

When using Priority DLCI, the primary DLCI is used to determine the state of the sub frame relay interface. When the primary DLCI is up, the sub frame relay interface is up. When the primary DLCI is down, the sub frame relay interface is down. Therefore, when using Priority DLCI, it is recommended to verify that the primary DLCI is set as the High Priority DLCI in the Priority DLCI group.

On the Avaya G450 Media Gateway, OSPF is mapped by default to the High Priority DLCI. For better network reliability, it is recommended to verify that the same configuration exists on the other side of the frame relay connection.

If one of the Priority DLCIs is down, its traffic is dropped.

Map the PVC control protocol on the routers at all ends of a multi-VC point-to-point link. Map this VC to the highest priority DLCI.

## Summary of priority DLCI commands

For more information about these commands, see *Avaya G450 CLI Reference*, 03-300437.

**Table 84: Priority DLCI CLI commands**

Root level command	Command	Description
<code>interface serial</code>		Enter the Serial interface or sub interface configuration context
	<code>frame-relay priority-dlci-group</code>	Assign Virtual Channels to priority classifications, for the purpose of traffic separation

## PPP VoIP configuration

[Figure 30](#) illustrates a common PPP VoIP configuration between two sites connected over a WAN:

**Figure 30: PPP VoIP configuration over WAN**

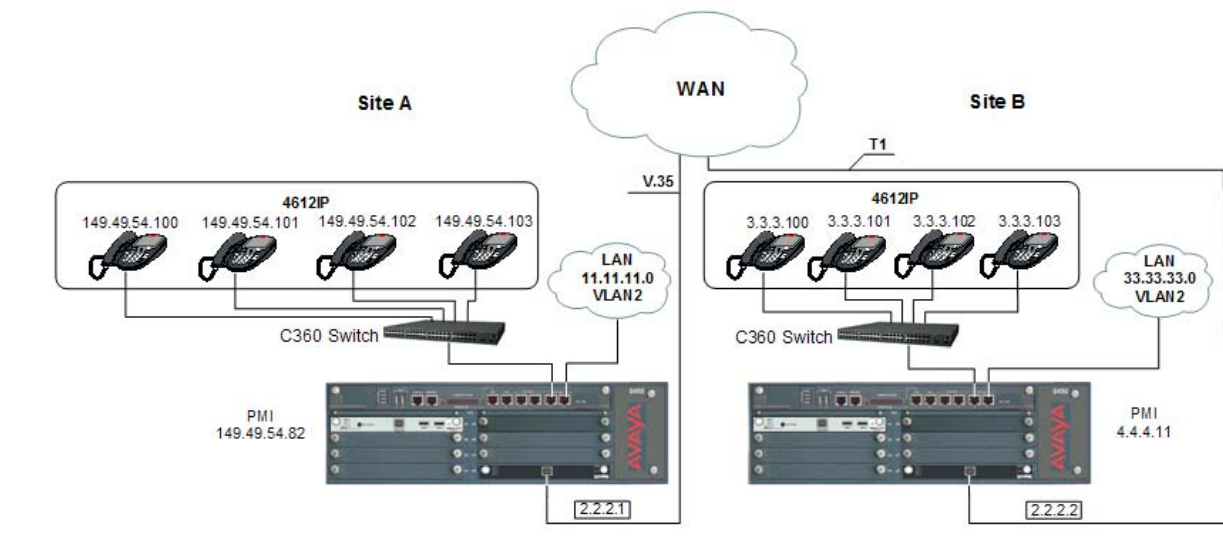

### Site A connection details

Site A contains four IP phones and a G450 with S8300 and one MM342 media module. The MM342 media module connects the G450 to the WAN via a USP 128 Kbps V.35 interface. The following are the connection details for Site A:

- The IP phones are configured with the following DSCP tagging:
  - Voice = DSCP 46
  - Voice control = DSCP 34

**Note:**

The policy list in the next configuration is based on the assumption that the Media Gateway, S8300, and the IP phones send VoIP control packets with a DSCP value of 34 and voice with a DSCP value of 46. If any of the components of the topology are sending control or voice packets with other DSCP values, you must make changes in the policy list.

- The default RTP UDP port range is 2048 to 3028
- Network IPs (24 bit subnet masks):
  - IP phones = 149.49.54.0 (VLAN 1)
  - Data = 11.11.11.0 (VLAN 2)
  - Serial = 2.2.2.1
  - S8300 = 149.49.54.81
  - G450 PMI = 149.49.54.82

### Site B connection details

Site B contains four IP phones and a G450 with S8300 and one MM340 media module. The MM340 media module connects the G450 to the WAN via a two-timeslot (128 Kbps) T1 interface. The following are the connection details for Site B:

- IP phone are configured with DSCP tagging:
  - Voice = DSCP 46
  - Voice control = DSCP 34
- The default RTP UDP port range is 2048 to 3028
- Network IPs (24 bit subnet masks):
  - IP phones = 3.3.3.0 (VLAN 1)
  - Data = 33.33.33.0 (VLAN 2)
  - Serial = 2.2.2.2
  - S8300 = 4.4.4.10
  - G450 PMI = 4.4.4.11



## Configuration Example for Site A

You can configure PPP VoIP on the G450 at Site A. Commands with footnotes are described at the end of the configuration procedure.

- Loopback and PMI interfaces configuration:

```
G450-001# interface loopback 1
G450-001(if:Loopback 1)# ip address 149.49.54.82 24
Done!
G450-001(if:Loopback 1)# pmi
The Primary management interface has changed. Please copy the running configuration
to the start-up configuration file, and reset the device.
G450-001(if:Loopback 1)# exit
G450-001# copy running-config startup-config
G450-001# reset
```

- VLAN interface configuration:

```
G450-001# interface Vlan 1
G450-001(if:Vlan 1)# ip address 149.49.54.24
Done!
G450-001(if:Vlan 1)# exit
G450-001# interface Vlan 2
G450-001(if:Vlan 2)# ip address 11.11.11.1 24
Done!
G450-001(if:Vlan 2)# exit
```

- Serial interface configuration:

```
G450-001# interface serial 4/1
G450-001(if:Serial 4/1)# ip address 2.2.2.1 24
G450-001(if:Serial 4/1)# mtu 300
```

### Note:

Some LAN data applications do not support fragmented packets. In this case, do not change the MTU from its default of 1500.

```
G450-001(if:Serial 4/1)# bandwidth 128
```

- VoIP configuration:

```
G450-001(if:Serial 4/1)# ip rtp header-compression
G450-001(if:Serial 4/1)# ip rtp compression-connections 20 (4)
G450-001(if:Serial 4/1)# ip rtp port-range 2048 3028 (5)
G450-001(if:Serial 4/1)# exit
```

- Static routes configuration:

```
G450-001# ip default-gateway 4/1
```

## Configuring WAN interfaces

\* Description of footnoted commands (also applies to identical stages in configuring Site B):

- (1) At this stage you apply Priority 7 to Voice Control traffic.
- (2) At this stage you apply Priority 6 to RTP traffic.
- (3) At this stage you apply maximum trust between 802.1p priority and DSCP.
- (4) At this stage the number of connections (20) depends on the number of phones.
- (5) At this stage you are matching the RTP port range to that of the G450.
- (6) At this stage the default queue size is 6, and since RTP is enabled you can double the VoIP queue size.

## Configuration Example for Site B

You can configure PPP VoIP on the G450 at Site B.

- Loopback and PMI interfaces configuration:

```
G450-001# interface loopback 1
G450-001(if:Loopback1)# ip address 4.4.4.11 32
Done!
G450-001(if:Loopback 1)# pmi
The Primary management interface has changed. Please copy the running configuration
to the start-up configuration file, and reset the device.
G450-001(if:Loopback1)# exit
G450-001# copy running-config startup-config
G450-001# reset
```

- VLAN interface configuration:

```
G450-001# interface Vlan 1
G450-001(if:Vlan 1)# ip address 3.3.3.1 24
G450-001(if:Vlan 1)# exit
G450-001# interface Vlan 2
G450-001(if:Vlan 1:2)# ip address 33.33.33.1 24
G450-001(if:Vlan 1:2)# exit
```

- Serial interface configuration:

```
G450-001# controller t1 4/1
G450-001(controller:4/1)# channel-group 1 timeslots 1-2 speed 64
G450-001(controller:4/1)# exit
G450-001# interface serial 4/1:1
G450-001(if:Serial 4/1:1)# ip address 2.2.2.2 24
G450-001(if:Serial 4/1:1)# mtu 300
```

### Note:

Some LAN data applications do not support fragmented packets. In this case, do not change the MTU from its default of 1500.

- VoIP configuration:

```
G450-001(if:Serial 4/1:1)# ip rtp header-compression
G450-001(if:Serial 4/1:1)# ip rtp compression-connections 20
G450-001(if:Serial 4/1:1)# ip rtp port-range 2048 3028
G450-001(if:Serial 4/1:1)# exit
```

- Static routes configuration:

```
G450-001# ip route 1.1.1.0 24 serial 4/1:1
G450-001# ip route 11.11.11.0 24 serial 4/1:1
```



# Chapter 12: Configuring Emergency Transfer Relay (ETR)

The ETR feature provides basic telephone services in the event of system failure, such as a power outage or a failed connection to the MGC. The ETR feature can be used in conjunction with an analog media module (MM711, MM714, or MM716). The ETR panel provides up to five incoming Central Office (CO) trunk loops to 5 selected G450 analog lines. Thus, one ETR panel supports up to five emergency lines. You can cascade a second ETR panel, providing support for up to 10 emergency analog phones. ETR is activated automatically upon system failure by closing the tip/ring contacts between the analog lines and the analog trunks. When ETR is activated, all calls are directed by the analog relays between the outside lines and the analog telephones. A current-loop detection circuit prevents ongoing calls from being disconnected when normal functioning resumes. If a call is in progress on an outside line when the problem ends, the call continues. The trunk port and analog line port passing through the ETR panel do not start to operate until the active call ends.

 **CAUTION:**

The analog ports connected to the ETR panel must be configured as DID.

When ETR is active and the G450 has power, the ETR front panel LED is lit.

---

## Setting ETR state

By default, ETR is set to go into effect automatically in the event of power outage or a failed connection to the MGC. You can activate ETR manually via the CLI.

- To activate ETR manually in the G450, use the following command:

```
set etr 7 manual-on
```

Generally, you should only use this command for testing.

- To restore ETR to automatic activation in the G450, use the following command:

```
set etr 7 auto
```

If the system fails, the analog line connections and analog trunk connections passing through the ETR panel are automatically latched.

## Configuring Emergency Transfer Relay (ETR)

**Note:**

A call in progress will be terminated when ETR is activated either automatically or manually.

---

## Viewing ETR state

You can enter `show etr` to display ETR information. This information includes the following:

- Admin state (`auto` or `manual-on`)
- Module status (in service, out of service, or out of service waiting for off-hook)
- Trunk number of the trunk connected to ETR
- Line number of the line connected to ETR
- Line status (`off hook` or `on hook`)

---

## Summary of ETR commands

For more information about these commands, see *Avaya G450 CLI Reference*, 03-300437.

**Table 85: ETR configuration CLI commands**

Command	Description
<code>set etr</code>	Enable Emergency Transfer Relay (ETR) mode, or allow the gateway to control ETR mode automatically
<code>show etr</code>	Display the status of Emergency Transfer Relay (ETR) mode

# Chapter 13: Configuring SNMP

SNMP uses software entities called managers and agents to manage network devices. The manager monitors and controls all other SNMP-managed devices or network nodes on the network. There must be at least one SNMP Manager in a managed network. The manager is installed on a workstation located on the network.

An agent resides in a managed device or network node. The agent receives instructions from the SNMP Manager, generates reports in response to requests from the SNMP Manager, and sends management information back to the SNMP Manager as events occur. The agent can reside on:

- Routers
- Bridges
- Hubs
- Workstations
- Printers
- Other network devices

There are many SNMP management applications, but all these applications perform the same basic task. They allow SNMP managers to communicate with agents to configure, get statistics and information, and receive alerts from network devices. You can use any SNMP-compatible network management system to monitor and control a G450.

---

## Agent and manager communication

There are several ways that the SNMP manager and the agent communicate. The manager can:

- **Retrieve a value (*get*)**. The SNMP manager requests information from the agent, such as the number of users logged on to the agent device or the status of a critical process on that device. The agent gets the value of the requested Management Information Base (MIB) variable and sends the value back to the manager.
- **Retrieve the value immediately after the variable you name (*get-next*)**. The SNMP manager retrieves different instances of MIB variables. The SNMP manager takes the variable you name and then uses a sequential search to find the desired variable.
- **Retrieve a number of values (*get-bulk*)**. The SNMP manager retrieves the specified number of instances of the requested MIB variable. This minimizes the number of protocol exchanges required to retrieve a large amount of data.

## Configuring SNMP

**Note:**

*Get-bulk* is not supported in SNMPv1.

- **Change a configuration on the agent (*set*).** The SNMP manager requests the agent to change the value of the MIB variable. For example, you can run a script or an application on a remote device with a set action.
- **Receive an unsolicited message (*notification*).** The SNMP manager receives an unsolicited message from an agent at any time if a significant, predetermined event takes place on that agent. When a notification condition occurs, the SNMP agent sends an SNMP notification to the device specified as the trap receiver or trap host. The SNMP Administrator configures the trap host, usually the SNMP management station, to perform the action needed when a trap is detected.

**Note:**

For a list of traps and MIBS, see [Traps and MIBs](#) on page 641.

---

## SNMP versions

There are currently three versions of SNMP:

- SNMPv1
- SNMPv2c
- SNMPv3

The G450 supports all three versions. The implementation of SNMPv3 on the G450 is backwards compatible. That is, an agent that supports SNMPv3 will also support SNMPv1 and SNMPv2c.



---

## SNMPv1

SNMPv1 uses community strings to limit access rights. Each SNMP device is assigned to a read community and a write community. To communicate with a device, you must send an SNMP packet with the relevant community name.

By default, if you communicate with a device using only the read community, you are assigned the security name *ReadCommN*. This security name is mapped to the *ReadCommG* group by default. This allows you to view the agent's MIB tree, but you cannot change any of the values in the MIB tree.

If you communicate with a device using the write community, you are assigned the security name *WriteCommN*. This security name is mapped to the *WriteCommG* group by default. This allows you to view the agent's MIB tree and change any of the values in the MIB tree.

### Note:

If you delete the *ReadCommN* or *WriteCommN* users, the *ReadCommG* or *WriteCommG* groups, or the *snmpv1WriteView* or *snmpv1View*, you may not be able to access the device using SNMPv1 or SNMPv2c.

In addition, traps are sent to designated trap receivers. Packets with trap information also contain a trap community string.

---

## SNMPv2c

SNMPv2c is very similar to SNMPv1. However, SNMPv2c adds support for the *get-bulk* action and supports a different trap format.

---

## SNMPv3

SNMPv3 enables the following features over SNMPv1 or v2c:

- User authentication with a username and password
- Communication encryption between the Network Management Station (NMS) and the SNMP agent at the application level
- Access control definition for specific MIB items available on the SNMP agent
- Notification of specified network events directed toward specified users
- Definition of roles using access control, each with unique access permissions and authentication and encryption requirements

The basic components in SNMPv3 access control are users, groups, and views. In addition, SNMPv3 uses an SNMP engine ID to identify SNMP identity. An SNMP engine ID is assigned to each MAC address of each device in the network. Each SNMP engine ID should be unique in the network.

### Users

SNMPv3 uses the User-based Security Model (USM) for security, and the View-based Access Control Model (VACM) for access control. USM uses the HMAC-MD5-96 and HMAC-SHA-96 protocols for user authentication, and the CBC-DES56 protocol for encryption or privacy.

An unlimited number of users can access SNMPv3 at the same time.

### SNMP security levels

- **NoAuthNoPriv.** This is the lowest level of SNMPv3 security. No MAC is provided with the message, and no encryption is performed. This method maintains the same security level as SNMPv1, but provides a method for limiting the access rights of the user.
- **AuthNoPriv.** User authentication is performed based on MD5 or SHA algorithms. The message is sent with an HMAC that is calculated with the user key. The data part is sent unencrypted.
- **AuthPriv.** User authentication is performed based on MD5 or SHA algorithms. The message is sent in encrypted MAC that is calculated with the user key, and the data part is sent with DES56 encryption using the user key.

### SNMP-server user command

Use the **snmp-server user** command to create a user or to change the parameters of an existing user. This command includes the following parameters:

- A user name for the user
- The name of the SNMP group with which to associate the user
- The SNMP version functionality that the user is authorized to use. Possible values are: `v1` (SNMPv1), `v2c` (SNMPv2c), and `v3` (SNMPv3).
- For an SNMPv3 user, which authentication protocol to use, if any. Possible values are: `md5` (HMAC MD5), and `sha` (HMAC SHA-1). If you specify an authentication protocol, you must also configure an authentication password for the user. The authentication password is transformed using the authentication protocol and the SNMP engine ID to create an authentication key.
- For an SNMPv3 user, whether or not to use the DES privacy protocol, and the user's privacy password if you enable DES privacy

Use the **no** form of the **snmp-server user** command to remove a user and its mapping to a specified group. If you do not specify a group, the **no** form of the **snmp-server user** command removes the user from all groups.

## Groups

In SNMPv3, each user is mapped to a group. The group maps its users to defined views. These views define sets of access rights, including read, write, and trap or inform notifications the users can receive.

The group maps its users to views based on the security model and level with which the user is communicating with the G450. Within a group, the following combinations of security model and level can be mapped to views:

- SNMPv1 security model and NoAuthNoPriv security level
- SNMPv2c security model and NoAuthNoPriv security level
- SNMPv3 security model and NoAuthNoPriv security level
- SNMPv3 security model and AuthNoPriv security level
- SNMPv3 security model and AuthPriv security level

If views are not defined for all security models and levels, a user can access the highest level view below the user's security level. For example, if the SNMPv1 and SNMPv2c views are undefined for a group, anyone logging in using SNMPv1 and SNMPv2c cannot access the device. If the NoAuthNoPriv view is not defined for a group, SNMPv3 users with a NoAuthNoPriv security level can access the SNMPv2c view.

The G450 includes the following pre-configured groups:

**Table 86: Pre-configured SNMP groups**

Group name	Security model	Security level	Read view name	Write view name	Notify view name
initial	v3 (USM)	NoAuthNoPriv	restricted	restricted	restricted
ReadCommG	v1	NoAuthNoPriv	snmpv1View		snmpv1View
ReadCommG	v2c	NoAuthNoPriv	snmpv1View		snmpv1View
WriteCommG	v1	NoAuthNoPriv	snmpv1 WriteView	snmpv1 WriteView	snmpv1 WriteView
WriteCommG	v2c	NoAuthNoPriv	snmpv1 WriteView	snmpv1 WriteView	snmpv1 WriteView
v3ReadOnlyG	v3 (USM)	AuthNoPriv	v3configView		v3configView
v3AdminViewG	v3 (USM)	AuthPriv	iso	iso	iso
v3ReadWriteG	v3 (USM)	AuthNoPriv	v3configView	v3configView	v3configView

### Creating an SNMPv3 group

- Use the `snmp-server group` command to create an SNMPv3 group. Use the `no` form of the command to remove the specified group. You can define the following parameters with this command:
  - The name of the group
  - The SNMP security model
  - The security level, for a group with the SNMPv3 security model
  - The name of a read view to which the group maps users
  - The name of a write view to which the group maps users
  - The name of a notify view to which the group maps users

---

### Views

There are three types of views:

- **Read Views.** Allow read-only access to a specified list of Object IDs (OIDs) in the MIB tree
- **Write Views.** Allow read-write access to a specified list of OIDs in the MIB tree
- **Notify Views.** Allow SNMP notifications from a specified list of OIDs to be sent

Each view consists of a list of OIDs in the MIB tree. This list can be created using multiple `snmp-server view` commands to either add OIDs to the list or exclude OIDs from a list of all of the OIDs in the G450's MIB tree. You can use wildcards to include or exclude an entire branch of OIDs in the MIB tree, using an asterisk instead of the specific node. For a list of MIBs and their OIDs, see [G450 MIB files](#) on page 649.

### Creating an SNMPv3 view

To create an SNMPv3 view, the following information must be provided:

- **ViewName.** A string of up to 32 characters representing the name of the view
- **ViewType.** Indicates whether the specified OID is included or excluded from the view
- **OIDs.** A list of the OIDs accessible using the view

---

## Configuring SNMP traps

When SNMP traps are enabled on the device, SNMP traps are sent to all IP addresses listed in the trap receivers table. You can add and remove addresses from the trap receivers table. In addition, you can limit the traps sent to specified receivers. You can also enable and disable link up/down traps on specified G450 interfaces. Use the following commands to configure the trap receivers table:

**Note:**

You need an Admin privilege level to use the SNMP commands.

- Enter **snmp-server enable notifications** to enable SNMP traps and notifications. Use the **no** form of this command to disable SNMP traps and notifications.
- Use the **set port trap** command to enable and disable Link Up and Link Down notifications and traps.
- Use the **set snmp trap enable/disable auth** command to enable or disable authentication failure traps for all managers.
- Enter **set snmp trap enable/disable frame-relay** to enable or disable frame relay traps for all managers.
- Enter **show snmp** to display SNMP information.
- Use the **show port trap** command to display information on SNMP generic Link Up and Link Down traps sent for a specific port or for all ports.
- Use the **snmp-server informs** command to configure the SNMPv3 timeout and retries for notifications.
- Use the **snmp-server host** command to define an SNMP notification host. Use the **no** form of this command to remove an SNMP notification host and to remove notification filter groups from a specific host. You can define the following parameters with this command:
  - The IP address of the recipient.
  - Whether to send traps or informs to the recipient.
  - The SNMP security model (v1, v2c, v3). For SNMPv1 and SNMPv2c, you must also specify the community name. For SNMPv3, you must specify the level of authentication and a username to use in notifications. Authentication levels are:
    - **auth**. Authentication without encryption
    - **noauth**. No authentication
    - **priv**. authentication with encryption

## Configuring SNMP

- The UDP port of the target host to use as the destination UDP port when sending a notification to this manager. Optional. The default is 162.
- Notification filter groups, to modify the types of traps that are sent to the recipient. Optional. If not specified, all notification groups are sent. For a list of possible notification types, see [Notification types](#) on page 334.
- Enter **snmp trap link-status** to enable Link Up and Link Down traps on an interface. You must use this command from an interface context.
- Enter **no snmp trap link-status** to disable Link Up and Link Down traps on an interface. You must use this command from an interface context.

---

## Notification types

Various types of SNMP traps can be sent. You can modify the type of trap by setting the **notification-list** parameter of the **snmp-server host** command to one of the following:

- **all**. All traps. This is the default.
- **generic**. Generic traps
- **hardware**. Hardware faults
- **rmon**. RMON rising/falling alarm
- **dhcp server**. DHCP server error, such as a DHCP IP conflict detection or notification of no IP address left for specific network
- **dhcp-clients**. DHCP client error, such as a DHCP client conflict detection
- **rtp-stat-faults**. RTP statistics: QoS fault/clear traps
- **rtp-stat-qos**. RTP statistics: end-of-call QoS traps
- **wan**. WAN router traps
- **media-gateway**. Media gateway traps (equivalent to G700 MGP traps)
- **security**. Security traps, such as unAuthAccess, macSecurity, unknownHostCopy, and accountLockout
- **config**. Configuration change notifications
- **eth-port-faults**. Ethernet port fault notifications
- **sw-redundancy**. Software redundancy notifications
- **temperature**. Temperature warning notifications
- **cam-change**. Changes in CAM notifications
- **13-events**. Duplicate IP, VLAN violations
- **policy**. Policy change notifications

- *link-faults*. ITC proprietary link down notifications
- *supply*. Main and backup power supply notifications

---

## Summary of SNMP trap configuration commands

For more information about these commands, see *Avaya G450 CLI Reference*, 03-300437.

**Table 87: SNMP trap configuration CLI commands**

Root level command	Command	Description
<code>interface</code> ( <code>console</code>   <code>dialer</code>   <code>fastethernet</code>   <code>serial</code>   <code>tunnel</code>   <code>usb-modem</code> )		Enter the context of the Console, Dialer, Fast Ethernet, Serial, Tunnel, or USB-modem interface
	<code>snmp trap</code> <code>link-status</code>	Enable or disable Link Up and Link Down traps on an interface
<code>set port trap</code>		Enable or disable SNMP Link Up and Link Down traps notifications and traps on a port
<code>set snmp trap</code> <code>enable</code>   <code>disable</code> <code>auth</code>		Enable or disable authentication failure traps for all managers
<code>set snmp trap</code> <code>enable</code>   <code>disable</code> <code>frame-relay</code>		Enable or disable frame relay traps for all managers
<code>show port trap</code>		Display information on SNMP generic Link Up and Link Down traps sent for a specific port or for all ports
<code>show snmp</code>		Display SNMP configuration information
<code>snmp-server</code> <code>enable</code> <code>notifications</code>		Enable or disable the sending of all traps and notifications from the G450

1 of 2

**Table 87: SNMP trap configuration CLI commands (continued)**

Root level command	Command	Description
	<code>snmp-server host</code>	Identify an SNMP management server, and specify the kind of messages it receives. Use the <b>no</b> form of the command to remove the specified server, or to disable a particular set of notification types.
	<code>snmp-server informs</code>	Configure the SNMPv3 timeout and retries for notifications

**2 of 2**

## Configuring SNMP access

- Use the `ip snmp` command to enable SNMP access to the G450. Use the **no** form of this command to disable SNMP access to the G450.
- Use the `set snmp retries` command to set the number of times to attempt to communicate with a particular node.
- Use the `set snmp timeout` command to specify the time to wait for a response before retrying the communication.
- Enter `snmp-server community` to enable SNMPv1 access to the G450. Use the **no** form of this command to disable SNMPv1 access to the G450.
- Use the `snmp-server user` command to create an SNMPv3 user. Use the **no** form of this command to remove an SNMPv3 user.
- Use the `snmp-server group` command to create an SNMPv3 group. Use the **no** form of this command to remove an SNMPv3 group.
- Use the `snmp-server remote-user` command to create an SNMPv3 remote user for SNMP notifications. Use the **no** form of this command to remove an SNMPv3 remote user for SNMP notifications.
- Use the `set snmp community` command to create or modify an SNMPv1 community.
- Use the `snmp-server engineID` command to configure the SNMPv3 engine ID. Use the **no** form of this command to configure the engine ID to its default value. The SNMP engine ID is set automatically by a calculation based on the MAC address of the host device, but you can change the engine ID using this command. If the SNMP engine ID changes, all users other than the default user are invalid and must be redefined.
- Use the `snmp-server view` command to add or exclude OIDs from a view and to create the view if it does not exist. Use the **no** form of this command to delete an SNMPv3 view.



- Enter **show snmp view** to display a list of SNMPv3 views or to display information about a specific SNMPv3 view.
- Use the **show snmp userToGroup** command to display a table of SNMPv3 users and the groups to which they are mapped.
- Enter **show snmp engineID** to display the SNMPv3 engine ID.
- Enter **show snmp group** to display a list of SNMPv3 groups.
- Use the **show snmp user** command to display configuration information for all SNMP users or for a specific SNMP user.
- Use the **show snmp retries** command to display the number of retry attempts to make when attempting to communicate with a node.
- Use the **show snmp timeout** command to display the time to wait before resending a communication.
- Enter **show snmp** to display a list of SNMP notification receivers.

**Note:**

You need an Admin privilege level to use the SNMP commands.

---

## Summary of SNMP access configuration commands

For more information about these commands, see *Avaya G450 CLI Reference*, 03-300437.

**Table 88: SNMP access configuration CLI commands**

Command	Description
<b>ip snmp</b>	Enable or disable the SNMP agent for the G450
<b>set snmp community</b>	Create or modify an SNMPv1 community
<b>set snmp retries</b>	Set the number of times to attempt to communicate with a particular node
<b>set snmp timeout</b>	Specify the time to wait for a response before retrying the communication
<b>show snmp</b>	Display SNMP configuration information, including a list of SNMP notification receivers
<b>show snmp engineID</b>	Display the SNMPv3 engine ID for the G450
<b>show snmp group</b>	Display a list of SNMPv3 groups

1 of 2

Table 88: SNMP access configuration CLI commands (continued)

Command	Description
<code>show snmp retries</code>	Display the number of retry attempts to make when attempting to communicate with a node
<code>show snmp timeout</code>	Display the time to wait before resending a communication
<code>show snmp user</code>	Display configuration information for a specified SNMP user
<code>show snmp usertogroup</code>	Display a table of SNMPv3 users and the groups to which they are mapped
<code>show snmp view</code>	Display configuration information for all SNMP views
<code>snmp-server community</code>	Enable or disable SNMP access to the G450
<code>snmp-server engineID</code>	Specify the SNMP Engine ID for the G450
<code>snmp-server group</code>	Define a new SNMPv3 group, or configure settings for the group
<code>snmp-server remote-user</code>	Configure settings for a remote SNMPv3 user. If the user does not exist, it is created.
<code>snmp-server user</code>	Configure settings for an SNMPv3 user. If the user does not exist, it is created.
<code>snmp-server view</code>	Configure settings for an SNMP MIB view. If the view does not exist, it is created.

2 of 2

---

## Configuring dynamic trap manager

Dynamic trap manager is a special feature that ensures that the G450 sends traps directly to the currently active MGC. If the MGC fails, dynamic trap manager ensures that traps are sent to the backup MGC.

**Note:**

The dynamic trap manager is created by default and cannot be removed.

Use the `snmp-server dynamic-trap-manager` command to specify the parameters of the dynamic trap manager feature. You can configure the following parameters:

- Whether to send traps or informs to the recipient

- The SNMP security model (v1 or v2c)
- The SNMP community name
- The UDP port of the target host to use as the destination UDP port when sending a notification to this manager. Optional.
- The types of traps to be sent. Optional. The default is to send all types of traps. For a list of possible notification types, see [Notification types](#) on page 334. The following example configures dynamic trap manager to send all traps:

```
G450-001(super)# snmp-server dynamic-trap-manager traps v1 public
udp-port 162 all
```

Use the **clear dynamic-trap-manager** command to remove administration of the dynamic trap manager.

---

## Summary of dynamic trap manager configuration commands

For more information about these commands, see *Avaya G450 CLI Reference*, 03-300437.

**Table 89: Dynamic trap manager configuration CLI commands**

Command	Description
<b>clear dynamic-trap-manager</b>	Remove administration of the dynamic trap manager
<b>snmp-server dynamic-trap-manager</b>	Specify the parameters of the dynamic trap manager feature

---

## SNMP configuration examples

The following example enables link up/down traps on an Ethernet interface:

```
G450-001(super)# interface fastethernet 10/2
G450-001(super-if:FastEthernet 10/2)# snmp trap link-status
Done!
```

The following example displays SNMP information:

```
G450-001(super)# show snmp

Authentication trap disabled

Community-Access      Community-String
-----
read-only             *****
read-write            *****

SNMPv3 Notification Status
-----
Traps: Enabled
Informs: Enabled      Retries: 3   Timeout: 3 seconds

SNMP-Rec-Address Model Level Notification Trap/Inform User name
-----
149.49.70.137      v1      noauth    all          trap        ReadCommN
  UDP port: 162 DM
```

The following example disables Link Up and Link Down traps on an Ethernet interface:

```
G450-001(super-if:FastEthernet 10/2)# no snmp trap link-status
Done!
```

The following example creates a read-only user:

```
G450-001# snmp-server user joseph ReadOnlyG v3 auth md5 katmandu priv des56 ktamatan
```

The following example creates a read-write user:

```
G450-001# snmp-server user johnny ReadWriteG v3 auth md5 katmandu priv des56
ktamatan
```

The following example creates an admin user:

```
G450-001# snmp-server user johnny v3AdminG v3 auth md5 katmandu priv des56 ktamatan
```

The following example sets the SNMPv1 read-only community:

```
G450-001(super)# set snmp community read-only read
SNMP read-only community string set.
```

The following example sets the SNMPv1 read-write community:

```
G450-001(super)# set snmp community read-write write
SNMP read-write community string set.
```

The following example enables Link Up and Link Down traps on a LAN port on the G450:

```
G450-001(super)# set port trap 6/5 enable
Port 6/5 up/down trap enabled
```

The following example disables Link Up and Link Down traps on a LAN port on the G450:

```
G450-001(super)# set port trap 6/5 disable
Port 6/5 up/down trap disabled
```



# Chapter 14: Configuring contact closure

You can use contact closure to control up to two electrical devices remotely. With contact closure, you can dial feature access codes on a telephone to activate, deactivate, or pulse electrical devices such as electrical door locks. You can also activate and deactivate contact closure using CLI commands. You can only use feature access codes if you configure the Avaya G450 Media Gateway to use a server with Avaya Communication Manager software. For more information, see [Configuring the Media Gateway Controller \(MGC\)](#) on page 82.

It is recommended that you use an Avaya Partner Contact Closure Adjunct™ for contact closure. For more information, see *Overview for the Avaya G450 Media Gateway*, 03-602058. An Avaya Partner Contact Closure Adjunct™ contains two relays, one for each electrical device. You can control each relay in any of the following ways:

- When you dial the contact closure open access code, the relay opens (no contact)
- When you dial the contact closure close access code, the relay closes (contact)
- When you dial the contact closure pulse access code, the relay closes (contact) for the pulse duration and then opens (no contact)
- You can control each contact closure relay manually with CLI commands or with Avaya G450 Manager

**Note:**

Configuration of the feature access code is performed through the Avaya Communication Manager. For more information, see *Administrator Guide for Avaya Communication Manager*, 03-300509.

---

## Contact closure hardware configuration

1. Connect an Avaya Partner Contact Closure Adjunct™ to the Contact Closure port on the Avaya G450 Media Gateway front panel. The Contact Closure port is labeled CCA on the G450 front panel. Use a telephone cable with standard RJ-11 connectors.
2. A qualified electrician should connect the electrical devices to the relays on the Avaya Partner Contact Closure Adjunct™. For information on contact closure specifications, see *Overview for the Avaya G450 Media Gateway*, 03-602058.

---

## Contact closure software configuration

You can specify the following contact closure modes:

**Table 90: Contact closure modes**

Mode	Description
mgc	The MGC controls contact closure. In mgc mode, the user dials feature access codes to activate and deactivate contact closure.
manual-trigger	Activates contact closure for the specified relay
manual-off	Deactivates contact closure for the specified relay

To configure the Avaya G450 Media Gateway to activate contact closure when the feature access code is dialed:

1. Enter the **set contact-closure admin** command.

In the following example, the command sets contact closure to work in relay 1 of the Avaya Partner Contact Closure Adjunct™ when activated by the call controller.

```
set contact-closure admin 10/1:1 mgc
```

2. Use the **set contact-closure pulse-duration** command to set the length of time for the relay to return to normal after the call controller triggers it.

In the following example, the command sets relay 2 of the Avaya Partner Contact Closure Adjunct™ to return to normal five seconds after the call controller triggers contact closure in the relay.

```
set contact-closure pulse-duration 10/1:2 5
```

To activate contact closure manually, use the **set contact-closure admin** command with the parameter `manual-trigger`.

In the following example, the command activates contact closure in relay 1 of the Avaya Partner Contact Closure Adjunct™. Contact closure remains active until you deactivate it by using the **set contact-closure admin** command with the parameter `manual-off` or `mgc`.

```
set contact-closure admin 10/1:1 manual-trigger
```

To deactivate contact closure manually, use the **set contact-closure admin** command with the parameter `manual-off`.



In the following example, the command deactivates contact closure in relay 2 of the Avaya Partner Contact Closure Adjunct™. Contact closure will not operate, even automatically, until you use the **set contact-closure admin** command to change the status of contact closure to mgc or manual-trigger.

```
set contact-closure admin 10/1:2 manual-off
```

---

## Showing contact closure status

Use the **show contact-closure** command to display the status of one or more contact closure relays.

The following example displays the contact closure status of relay 1 of the Avaya Partner Contact Closure Adjunct™ box.

```
G450-001(super)# show contact-closure
MODULE   PORT   RELAY  ADMIN          PULSE DURATION (secs)  STATUS
-----
10       2      1      mgc            5 secs                 off
10       2      2      mgc            3 secs                 off
```

---

## Summary of contact closure commands

For more information about these commands, see *Avaya G450 CLI Reference*, 03-300437.

**Table 91: Contact closure CLI commands**

Command	Description
<b>set contact-closure admin</b>	Specify how the contact closure relay is controlled
<b>set contact-closure pulse-duration</b>	Set the length of time for the relay to return to normal after the call controller triggers the relay
<b>show contact-closure</b>	Display the status of one or all contact closure relays



# Chapter 15: Transferring and managing announcement files

The G450 stores announcement files in an internal announcement directory. The G450 supports up to 256 announcement files, totalling up to 45 minutes of audio for announcements and music on hold. A total of 63 announcements can be played simultaneously, and one port may be used at a time for recording. Recording, storing, and playing announcement files is controlled by Avaya CM.

Avaya Voice Announcement Manager (VAM) can be used to centrally manage announcement files for multiple voice systems, including G450 media gateways. VAM is designed to be installed on a customer-provided platform at a remote location. For information about VAM, see *Avaya Voice Announcement Manager Reference*, 14-300613.

The G450 supports:

- Secure transfer of announcement files to and from VAM using SCP
- Simple management operations for the announcement files stored in the announcement directory

---

## Announcement file operations

- Upload an announcement file to a remote SCP server, using the **copy announcement-file scp** command. Specify the file name of the announcement file in the G450 announcement directory, followed by the IP address of the remote SCP server, and, optionally, a destination file name, including the full path. For example:

```
G450-001(super)# copy announcement-file scp local_announcement2.wav  
192.168.49.10 remote_announcement2.wav
```

- Download an announcement file from a remote SCP server to the G450 announcement directory, using the **copy scp announcement-file** command. Specify the file name of the announcement file on the remote SCP server, followed by the IP address of the remote SCP server, and, optionally, a destination file name, including the full path. For example:

```
G450-001(super)# copy scp announcement-file announcement_file1.wav  
192.168.49.10
```

## Transferring and managing announcement files

- Upload an announcement file to a remote FTP server, using the **copy announcement-file ftp** command. Specify the file name of the announcement file in the G450 announcement directory, followed by the IP address of the remote FTP server, and, optionally, a destination file name, including the full path. For example:

```
G450-001(super)# copy announcement-file ftp local_announcement2.wav  
192.168.49.10 remote_announcement2.wav
```

- Download an announcement file from an FTP server to the G450 announcement directory, using the **copy ftp announcement-file** command. Specify the file name of the announcement file on the FTP server, followed by the IP address of the FTP server, and, optionally, a destination file name, including the full path. For example:

```
G450-001(super)# copy ftp announcement-file announcement_file1.wav  
192.168.49.10
```

- Upload an announcement file to a USB mass storage device, using the **copy announcement-file usb** command. Specify the file name of the announcement file in the G450 announcement directory, followed by the name of the USB device, and, optionally, a destination file name, including the full path. For example:

```
G450-001(super)# copy announcement-file usb local_announcement2.wav  
usb-device0 remote_announcement2.wav
```

- Download an announcement file from a USB mass storage device to the G450 announcement directory, using the **copy usb announcement-file** command. Specify the name of the USB device, followed by the file name of the announcement file on the USB device, and, optionally, a destination file name, including the full path. For example:

```
G450-001(super)# copy usb announcement-file usb-device0 \temp\  
announcement_file1.wav local_announcement_file2.wav
```

- Erase an announcement file from the G450 announcement directory, using the **erase announcement-file** command. Specify the name of the file. For example:

```
G450-001# erase announcement-file local_announcement1.wav
```

- Rename an announcement file in the G450 announcement directory, using the **rename announcement-file** command. Specify the current name of the file followed by the new name. For example:

```
G450-001# rename announcement-file from_local_announcement1.wav  
to_local_announcement1.wav
```

- Display the announcements files stored in the G450 announcement directory, using the **show announcements-files** command. Optionally add the keyword **brief** to display less detail. For example:

```
G450-001(super)# show announcements files
Mode: FTP-SERVER/SCP-CLIENT
ID   File                Description  Size (Bytes) Date
-----
5    46xxupgrade.scr      Announcement1  4000      09:54:55 04 APR 2005
8    4601dbtel_82.bin     Announcement2  8000      09:55:55 04 APR 2005
9    4602dbtel_82.bin     Announcement3  16000     09:56:55 04 APR 2005
Nv-Ram:
Total bytes used: 28000
Total bytes free: 7344800
Total bytes capacity(fixed) 7372800
```

- Display the status of a download process of announcement files from the remote SCP server, using the **show download announcement-file status** command. For example:

```
G450-001(super)# show download announcement-file status
Module #9
=====
Module           : 9
Source file      : hellosource.wav
Destination file : hellodestination.wav
Host             : 135.64.102.64
Running state    : Idle
Failure display  : (null)
Last warning     : No-warning
Bytes Downloaded : 7825
=====
```

- Display the status of an upload process of announcement files to the remote SCP server, using the **show upload announcement-file status** command. For example:

```
G450-001(super)# show upload announcement-file status
Module #9
=====
Module           : 9
Source file      : hellosource.wav
Destination file : d:\hellodestination.wav
Host             : 135.64.102.64
Running state    : Idle
Failure display  : (null)
Last warning     : No-warning
=====
```

---

## Summary of announcement files commands

For more information about these commands, see *Avaya G450 CLI Reference*, 03-300437.

**Table 92: Announcement file CLI commands**

Command	Description
<code>copy announcement-file ftp</code>	Upload an announcement file to a remote FTP server
<code>copy announcement-file scp</code>	Upload an announcement file to a remote SCP server
<code>copy announcement-file usb</code>	Upload an announcement file to a USB mass storage device
<code>copy ftp announcement-file</code>	Download an announcement file from an FTP server to the G450 announcement directory
<code>copy scp announcement-file</code>	Download an announcement file from a remote SCP server to the G450 announcement directory
<code>copy usb announcement-file</code>	Download an announcement file from a USB mass storage device to the G450 announcement directory
<code>erase announcement-file</code>	Erase an announcement file from the G450 announcement directory
<code>rename announcement-file</code>	Rename an announcement file in the G450 announcement directory
<code>show announcements files</code>	Display the announcements files stored in the G450 announcement directory
<code>show download announcement-file status</code>	Display the status of a download process of announcement files from the remote SCP server
<code>show upload announcement-file status</code>	Display the status of an upload process of announcement files to the remote SCP server

# Chapter 16: Configuring advanced switching

You can configure advanced switching on the switch ports of the Avaya G450 Media Gateway. These are the ETH LAN ports located on the front panel.

---

## Configuring VLANs

A VLAN is made up of a group of devices on one or more LANs that are configured so the devices operate as if they form an independent LAN. These devices can, in fact, be located on several different LAN segments. VLANs can be used to group together departments and other logical groups, thereby reducing network traffic flow and increasing security within the VLAN.

---

## VLAN Tagging

VLAN Tagging is a method of controlling the distribution of information on the network. The ports on devices supporting VLAN Tagging are configured with the Port VLAN ID and Tagging Mode parameters.

The Port VLAN ID is the number of the VLAN to which the port is assigned.

**Note:**

You need to create a VLAN with the `set vlan` command before you can assign it to a port. You can also create a VLAN by using the `interface vlan` command, followed by the number of the VLAN (e.g., enter `interface vlan 2` to create VLAN 2).

Untagged frames and frames tagged with VLAN 0 entering the port are assigned the port's VLAN ID. Tagged frames are unaffected by the port's VLAN ID.

The Tagging Mode determines the behavior of the port that processes outgoing frames:

- If Tagging Mode is set to `clear`, the port transmits frames that belong to the port's VLAN table. These frames leave the device untagged.
- If Tagging Mode is set to `IEEE-802.1Q`, all frames keep their tags when they leave the device. Frames that enter the switch without a VLAN tag are tagged with the VLAN ID of the port through which they entered.

---

## Multi VLAN binding

Multi VLAN binding, also known as Multiple VLANs per port, allows access to shared resources by stations that belong to different VLANs through the same port. This is useful in applications such as multi-tenant networks, where each user has a personal VLAN for privacy. The whole building has a shared high-speed connection to the ISP.

In order to accomplish this, the G450 enables multiple VLANs per port. The available Port Multi-VLAN binding modes are:

- **Bound to Configured.** The port supports all the VLANs configured in the switch
- **Statically Bound.** The port supports VLANs manually configured on the port

[Figure 31](#) shows these binding modes.

---

**Figure 31: Multi VLAN Binding**

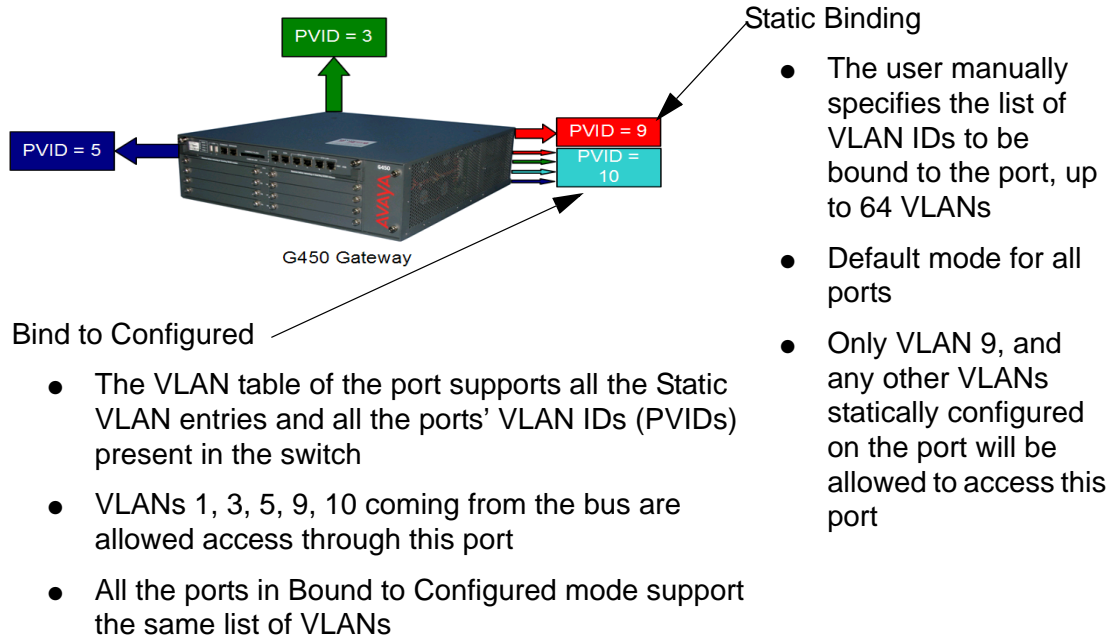



---

## G450 VLAN table

The G450 VLAN table lists all VLANs configured on the G450. You can configure up to 64 VLANs. To display a list of VLANs, use the **show vlan** command.

When the VLAN table reaches its maximum capacity, you cannot configure any more VLANs. If this occurs, use the **clear vlan** command, followed by the name or number of the VLAN you want to delete, to free space in the VLAN table. Any new VLANs configured by you are made known to all the modules in the system.

---

## Ingress VLAN Security

Ingress VLAN Security enables easy implementation of security, and is always active. A port that is assigned to a VLAN allows packets tagged for that VLAN only to enter through that port. Unassigned packets receive the PVID of the port and are therefore allowed to enter.

---

## ICC-VLAN

When the G450 includes an ICC, the ICC connects to the G450 via an internal switch. By default, the ICC is connected on Vlan 1. The VLAN to which the ICC connects is called the ICC-VLAN.

You can use the **icc-vlan** command to attach the ICC to a different VLAN. Enter the context of the VLAN interface to which you want to attach the ICC switch, and enter **icc-vlan**.

To show the current ICC-VLAN, enter **show icc-vlan** from the general context.

The following example sets Vlan 2 as the ICC-VLAN:

```
G450-001(super)# interface vlan 2
G450-001(super-if:Vlan 2)# icc-vlan
Done!
G450-001(super-if:Vlan 2)# exit
G450-001(super)# show icc-vlan
VLAN 2
G450-001(super)#
```

---

## VLAN CLI commands

The following commands are used to configure VLANs. For more information about these commands, see *Avaya G450 CLI Reference*, 03-300437.

- Use the **clear port static-vlan** command to delete VLANs statically configured on a port
- Use the **clear vlan** command to delete an existing VLAN and its interface, remove the entry from the VLAN table, and return ports from this VLAN to the default VLAN 1. When you clear a VLAN, all ports assigned to that VLAN are assigned to the default VLAN 1.
- Use the **interface vlan** command to create a VLAN interface, enter it into the VLAN table, and enter the Interface VLAN configuration mode
- Use the **no interface vlan** command to delete a VLAN interface and remove the entry from the VLAN table
- Use the **set port static-vlan** command to assign static VLANs to ports
- Use the **set port vlan** command to set the port VLAN ID (PVID)
- Use the **set port vlan-binding-mode** command to define the binding method used by ports
- Use the **set trunk** command to configure the VLAN tagging mode of a port
- Use the **set vlan** command to configure VLANs
- Use the **show cam vlan** command to display all mac entries in the CAM table for a specific vlan
- Use the **show interfaces vlan** command to display interface configuration and statistics for a particular VLAN or all VLANs
- Use the **show port vlan-binding-mode** command to display port VLAN binding mode information. If no module number is specified then information for all ports on all modules is displayed. If no port number is specified, information for all ports on the specified module is displayed.
- Use the **show trunk** command to display VLAN tagging information for the switch
- Use the **show vlan** command to display the VLANs configured in the switch

---

## VLAN configuration examples

The following example deletes a statically bound VLAN from a port:

```
G450-001(super)# clear port static-vlan 10/3 34
VLAN 34 is unbound from port 10/3
```

The following example deletes a VLAN and its interface:

```
G450-001(super)# clear vlan 34
This command will assign all ports on VLAN 34 to their default in the entire
management domain - do you want to continue (Y/N)? y
All ports on VLAN-id assigned to default VLAN.
VLAN 34 was deleted successfully.
```

The following example sets the current VLAN as the ICC-VLAN:

```
G450-001(super)# interface Vlan 66
G450-001(super-if:Vlan 66)# icc-vlan
Done!
```

The following example enters configuration mode for a VLAN interface:

```
G450-001(super)# interface Vlan 66
G450-001(super-if:Vlan 66)#
```

The following example deletes a VLAN interface:

```
G450-001(super)# no interface vlan 66
Done!
```

The following example statically binds a VLAN to a port:

```
G450-001(super)# set port vlan-binding-mode 10/3 static
Set Port vlan binding method:10/3
```

The following example sets a port's VLAN ID:

```
G450-001(super)# set port vlan 54 10/3
Port 10/3 added to VLAN 54
```

The following example sets a port's VLAN binding mode:

```
G450-001(super)# set port vlan-binding-mode 10/3 bind-to-configured
Set Port vlan binding method:10/3
```

The following example configures the VLAN tagging mode of a port:

```
G450-001(super)# set trunk 10/3 dot1q
Dot1Q VLAN tagging set on port 10/3.
```

The following example creates a VLAN:

```
G450-001(super)# set vlan 2121 name Training
VLAN id 2121, vlan-name Training created.
```

## Configuring advanced switching

The following example displays a list of the MAC addresses in the CAM of a VLAN:

```
G450-001(super)# show cam vlan 54
Total Matching CAM Entries Displayed = 3
Dest MAC/Route Dest VLAN Destination Ports
-----
00:01:02:dd:2f:9f    54      6/13
00:02:2d:47:00:6f    54      10/2
00:02:4b:5b:28:40    54      6/13
```

The following example displays the ICC-VLAN:

```
G450-001(super)# show icc-vlan
VLAN 1
```

The following example displays interface configuration and statistics for a VLAN:

```
G450-001(super)# show interfaces Vlan 1
VLAN 1 is up, line protocol is up
Physical address is 00.04.0d.29.c6.bd.
MTU 1500 bytes. Bandwidth 100000 kbit.
Reliability 255/255 txLoad 1/255 rxLoad 1/255
Encapsulation ARPA, ICC-VLAN
Link status trap disabled
Full-duplex, 100Mb/s
ARP type: ARPA, ARP Timeout 04:00:00
Last input never, Last output never
Last clearing of 'show interface' counters never.
5 minute input rate 0 bits/sec, 0 packets/sec
5 minute output rate 0 bits/sec, 0 packets/sec
0 input drops, 0 output drops, 0 unknown protocols
0 packets input, 0 bytes
0 broadcasts received, 0 giants
0 input errors, 0 CRC
0 packets output, 0 bytes
0 output errors, 0 collisions
```

The following example displays port VLAN binding information:

```
G450-001(super)# show port vlan-binding-mode 10
port 10/3 is bind to all configured VLANs
```

The following example displays VLAN tagging information:

```
G450-001(super)# show trunk
Port    Mode Binding mode          Native VLAN
-----
10/3    dot1q bound to configured VLANs 54
```

The following example displays the VLANs configured on the device:

```
G50-001(super)# show vlan
VLAN ID VLAN-name
-----
1       V1
54      Marketing
66      V66
2121    Training
Total number of VLANs: 4
```

## Summary of VLAN commands

For more information about these commands, see *Avaya G450 CLI Reference*, 03-300437.

**Table 93: VLAN CLI commands**

Root level command	First level Command	Description
<code>clear port static-vlan</code>		Delete statically configured VLANs from the port
<code>clear vlan</code>		Delete an existing VLAN and its interface, remove the entry from the VLAN table, and return ports from this VLAN to the default VLAN 1
<code>interface vlan</code>		Create a VLAN interface, enter interface VLAN configuration mode, or delete a VLAN interface
	<code>icc-vlan</code>	Set the current VLAN as the ICC-VLAN
<code>set port static-vlan</code>		Assign a static VLAN to a port
<code>set port vlan</code>		Set the port VLAN ID (PVID)
<code>set port vlan-binding-mode</code>		Define the binding method used by ports
<code>set trunk</code>		Configure the VLAN tagging mode of a port
<code>set vlan</code>		Create or modify a VLAN
<code>show cam vlan</code>		Display all MAC entries in the CAM table for a specific VLAN
<code>show icc-vlan</code>		Display the current ICC VLAN

1 of 2

Table 93: VLAN CLI commands (continued)

Root level command	First level Command	Description
<code>show interfaces</code>		Display interface configuration and statistics for a particular interface or all interfaces
<code>show port vlan-binding-mode</code>		Display port VLAN binding mode information
<code>show trunk</code>		Display VLAN tagging information for all or some ports
<code>show vlan</code>		Display the VLANs configured in the media gateway
		<b>2 of 2</b>

---

## Configuring port redundancy

Redundancy involves the duplication of devices, services, or connections, so that in the event of a failure, the redundant duplicate can take over for the one that failed.

Since computer networks are critical for business operations, it is vital to ensure that the network continues to function even if a piece of equipment fails. Even the most reliable equipment might fail on occasion, but a redundant component can ensure that the network continues to operate despite such failure.

To achieve port redundancy, you can define a redundancy relationship between any two ports in a switch. One port is defined as the primary port and the other as the secondary port. If the primary port fails, the secondary port takes over.

---

### Secondary port activation

The secondary port takes over within one second and is activated when the primary port link stops functioning. Subsequent switchovers take place after the minimum time between switchovers has elapsed. To set the minimum time between switchovers, use the `set port redundancy-intervals` command.

---

## Switchback

If switchback is enabled and the primary port recovers, a switchback takes place. Use the **set port redundancy-intervals** command to set the following switchback parameters:

- **min-time-between-switchovers**. The minimum time that is allowed to elapse before a primary-backup switchover
- **switchback-interval**. The minimum time the primary port link has to be up before a switchback to the primary port takes place. If you set this to **none**, there is no switchback to the primary port when it recovers. In this case, switchback to the primary port only takes place if the secondary port fails.

---

## Port redundancy CLI commands

The following commands are used to configure port redundancy. For more information about these commands, see *Avaya G450 CLI Reference*, 03-300437.

- Use the **set port redundancy enable/disable** command to globally enable or disable the redundancy pairs you have defined. Using this command will not delete existing redundancy entries.
- Use the **set port redundancy** command to define or remove redundancy pairs. Enter **show port redundancy** to ensure that there is no redundancy scheme already defined on any of the links.
- Use the **set port redundancy-intervals** command to configure the two time constants that determine redundancy switchover parameters.
- Enter **show port redundancy** to display information about software port redundancy schemes defined for the switch.

---

## Port redundancy configuration examples

The following example creates a port redundancy pair:

```
G450-001(super)# set port redundancy 10/5 10/6 on 1
Monitor: Port 10/6 is redundant to port 10/5.
Port redundancy is active - entry is effective immediately
```

The following example deletes a port redundancy pair:

```
G450-001(super)# set port redundancy 10/5 10/6 off
Entry Monitor removed: Port 10/6 is not redundant to port 10/5
```

## Configuring advanced switching

The following example enables all configured port redundancies:

```
G450-001(super)# set port redundancy enable
All redundancy schemes are now enabled
```

The following example disables all configured port redundancies:

```
G450-001(super)# set port redundancy disable
All redundancy schemes are disabled but not removed
```

The following example configures the switchback interval for all configured port redundancies:

```
G450-001(super)# set port redundancy-intervals 60 30
Done!
```

The following example displays port redundancy information:

```
G450-001(super)# show port redundancy
Redundancy Name      Primary Port      Secondary Port      Status
-----
Monitor              10/5              10/6                primary
Minimum Time between Switchovers: 60
Switchback interval: 30
```

---

## Summary of port redundancy commands

For more information about these commands, see *Avaya G450 CLI Reference*, 03-300437.

**Table 94: Port redundancy CLI commands**

Command	Description
<b>set port redundancy</b>	Define or remove redundancy pairs
<b>set port redundancy enable disable</b>	Globally enable or disable port redundancy pairs defined on the media gateway
<b>set port redundancy-intervals</b>	Configure the two time constants that determine redundancy switchover parameters
<b>show port redundancy</b>	Display information about software port redundancy pairs defined on the media gateway



---

## Configuring port mirroring

Port mirroring copies all received and transmitted packets (including local traffic) from a source port to a predefined destination port, in addition to the normal destination port of the packets. Port mirroring, also known as “sniffing,” is useful in debugging network problems.

Port mirroring allows you to define a source port and a destination port, regardless of port type. For example, a 10 Mbps and a 100 Mbps port can form a valid source/destination pair. You cannot, however, define the port mirroring source and destination ports as the same source and destination ports.

You can define one source port and one destination port on each G450 for received (Rx), transmitted (Tx), or transmitted and received (both) traffic.

---

### Port mirroring constraints

You cannot use the LAN port on the G450 front panel or the WAN Fast Ethernet port on the G450 front panels in port mirroring.

---

### Port mirroring CLI commands

The following commands are used to configure port mirroring on the G450. For more information about these commands, see *Avaya G450 CLI Reference*, 03-300437.

- Use the **set port mirror** command to define a port mirroring pair in the switch
- Use the **show port mirror** command to display mirroring information for the switch
- Use the **clear port mirror** command to cancel port mirroring

---

### Port mirroring configuration examples

The following example creates a port mirroring pair in the G450:

```
G450-001(super)# set port mirror source-port 10/5 mirror-port 010/6 sampling always
direction rx
Mirroring rx packets from port 10/5 to port 010/6 is enabled
```

## Configuring advanced switching

The following example displays port mirroring information for the G450:

```
G450-001(super)# show port mirror
port mirroring
Mirroring both Rx and Tx packets from port 10/5 to port 010/6 is enabled
```

The following example disables port mirroring:

```
G450-001(super)# clear port mirror
```

---

## Summary of port mirroring commands

For more information about these commands, see *Avaya G450 CLI Reference*, 03-300437.

**Table 95: Port mirroring CLI commands**

Command	Description
<code>clear port mirror</code>	Delete a port mirroring pair
<code>set port mirror</code>	Define a port mirroring source-destination pair
<code>show port mirror</code>	Display mirroring information for a specified port or for all ports

---

## Configuring spanning tree

G450 devices support the enhanced Rapid Spanning Tree Protocol (802.1w). The 802.1w standard is a faster and more sophisticated version of the 802.1d (STP) standard, and includes backward compatibility with 802.1d. Spanning tree makes it possible to recover connectivity after an outage within approximately a minute. RSTP, with its “rapid” algorithm, can usually restore connectivity to a network where a backbone link has failed in much less time.

### Spanning tree protocol

The spanning tree algorithm ensures the existence of a loop-free topology in networks that contain parallel bridges. A loop occurs when there are alternate routes between hosts. If there is a loop in an extended network, bridges may forward traffic indefinitely, which can result in increased traffic and degradation in network performance.

The spanning tree algorithm produces a logical tree topology out of any arrangement of bridges. The result is a single path between any two end stations on an extended network. In addition, the spanning tree algorithm provides a high degree of fault tolerance. It allows the network to automatically reconfigure the spanning tree topology if there is a bridge or data-path failure.

The spanning tree algorithm requires five values to derive the spanning tree topology. These are:

- A multicast address specifying all bridges on the extended network. This address is media-dependent and is automatically determined by the software.
- A network-unique identifier for each bridge on the extended network
- A unique identifier for each bridge/LAN interface (a port)
- The relative priority of each port
- The cost of each port

After these values are assigned, bridges multicast and process the formatted frames (called Bridge Protocol Data Units, or BPDUs) to derive a single, loop-free topology throughout the extended network. The bridges exchange BPDU frames quickly, minimizing the time that service is unavailable between hosts.

### Spanning tree per port

Spanning tree can take up to 30 seconds to open traffic on a port. This delay can cause problems on ports carrying time-sensitive traffic. You can, therefore, enable or disable spanning tree in the G450 on a per-port basis to minimize this effect.

### Rapid Spanning Tree Protocol (RSTP)

The enhanced feature set of the 802.1w standard includes:

- Bridge Protocol Data Unit (BPDU) type 2
- New port roles: Alternate port, Backup port
- Direct handshaking between adjacent bridges regarding a desired topology change (TC). This eliminates the need to wait for the timer to expire.
- Improvement in the time it takes to propagate TC information. Specifically, TC information does not have to be propagated all the way back to the Root Bridge (and back) to be changed.
- Origination of BPDUs on a port-by-port basis

#### Port roles

At the center of RSTP – specifically as an improvement over STP (802.1d) – are the roles that are assigned to the ports. There are four port roles:

- **Root port.** The port closest to the root bridge

## Configuring advanced switching

- **Designated port.** The corresponding port on the remote bridge of the local root port
- **Alternate port.** An alternate route to the root
- **Backup port.** An alternate route to the network segment

The RSTP algorithm usually makes it possible to change port roles rapidly through its fast topology change propagation mechanism. For example, a port in the blocking state can be assigned the role of alternate port. When the backbone of the network fails, the port can rapidly be changed to forwarding.

Whereas the STA *passively* waited for the network to converge before turning a port into the forwarding state, RSTP *actively* confirms that a port can safely transition to forwarding without relying on any specific, programmed timer configuration.

### RSTP port types

RSTP provides a means of fast network convergence after a topology change. It does this by assigning different treatments to different port types.

- **Edge ports.** Setting a port to edge-port admin state indicates that this port is connected directly to end stations that cannot create bridging loops in the network. These ports transition quickly to forwarding state. However, if BPDUs are received on an edge port, its operational state will be changed to non-edge-port and bridging loops will be avoided by the RSTP algorithm. The default admin state of 10/100 M ports is edge-port.

Enter **set port edge admin state**, followed by the module and port number – or a range of port numbers – to specify whether or not a port is considered an edge port.

For example, the following command specifies that ports 10/5 and 10/6 are edge ports:

```
G450-001(super)# set port edge admin state 10/5-6 edge-port
```

The following command specifies that port 10/5 is not an edge port:

```
G450-001(super)# set port edge admin state 10/5 non-edge-port
```

Enter **show port edge state**, followed by the module and port number, to display the edge state of the specified port. Use this command without specifying a module number or port to display the edge state of all ports.

- **Non-edge ports.** You must manually configure uplink and backbone ports to be non-edge ports, using the **set port edge admin state** command.

- **Point-to-point link ports.** This port type applies only to ports interconnecting RSTP compliant switches and is used to define whether the devices are interconnected using shared Ethernet segment or point-to-point Ethernet link. RSTP convergence may be faster when switches are connected using point-to-point links. The default setting for all ports – automatic detection of point-to-point link – is sufficient for most networks.

Enter **set port point-to-point admin status**, followed by the module and port number or a range of port numbers, and an admin status parameter, to specify the port's connection type. Admin status parameter values are:

- *force-true*. Treats the port as if it is connected point-to-point
- *force-false*. Treats the port as if it is connected to shared media
- *auto*. Attempts to automatically detect the port's connection type

For example, the following command specifies that ports 10/5 and 10/6 are treated as if they were connected point-to-point:

```
G450-001(super)# set port point-to-point admin status 10/5-6 force-true
```

- **All ports.** Enter **show port point-to-point status**, followed by the module and port number, to display the point-to-point status of the specified point-to-point status of all ports

---

## Spanning tree CLI commands

Use the following commands to configure spanning tree. For more information about these commands, see *Avaya G450 CLI Reference*, 03-300437.

- Use the **set port spantree** command to enable or disable the spanning tree mode for specific switch ports.
- Use the **set port spantree cost** command to set the spanning tree cost of a port. This value defines which port will be allowed to forward traffic if two ports with different costs cause a loop.
- Use the **set port spantree force-protocol-migration** command to force a port to send a rapid spanning tree hello packet (Bridge Protocol Data Unit).
- Use the **set port spantree priority** command to set the spanning tree priority level of a port. This value defines the priority of a port to be blocked in case two ports with the same cost cause a loop.
- Use the **set spantree default-path-cost** command to set the version of the spanning tree default path cost used by this bridge.
- Use the **set spantree enable/disable** command to enable or disable the spanning tree algorithm.

## Configuring advanced switching

- Use the **set spantree forward-delay** command to specify the time used when transferring the state of a port to the forwarding state.
- Use the **set spantree hello-time** command to specify the time interval between the generation of configuration BPDUs by the root.
- Use the **set spantree max-age** command to specify the time to keep an information message before it is discarded.
- Use the **set spantree priority** command to set the bridge priority for STP.
- Use the **set spantree tx-hold-count** command to set the value in packets used by the spanning tree in order to limit the maximum number of BPDUs transmitted during a hello-time period.
- Use the **set spantree version** command to set the version of the spanning tree protocol.
- Use the **show spantree** command to display spanning-tree information.

---

## Spanning tree configuration examples

The following example enables spanning tree on a port:

```
G450-001(super)# set port spantree enable 6/5
port 6/5 was enabled on spantree
```

The following example disables spanning tree on a port:

```
G450-001(super)# set port spantree disable 6/5
port 6/5 was disabled on spantree
```

The following example sets the spanning tree cost of port 10/5 to 4096:

```
G450-001(super)# set port spantree cost 6/5 4096
port 6/5 spantree cost is 4096
```

The following example configures the version of the spanning tree default path cost used by this bridge:

```
G450-001(super)# set spantree default-path-cost common-spanning-tree
Spanning tree default path costs is set to common spanning tree.
```

The following example configures the time used when transferring the port to the forwarding state:

```
G450-001(super)# set spantree forward-delay 16
bridge forward delay is set to 16.
```

The following example configures the time interval between the generation of configuration BPDUs by the root:

```
G450-001(super)# set spantree hello-time 2
bridge hello time is set to 2.
```

The following example configures the amount of time an information message is kept before being discarded:

```
G450-001(super)# set spantree max-age 21
bridge max age is set to 21.
```

The following example configures the bridge priority for spanning tree:

```
G450-001(super)# set spantree priority 36864
Bridge priority set to 36864.
```

The following example sets the value in packets used by spanning tree in order to limit the maximum number of BPDUs transmitted during a hello-time period:

```
G450-001(super)# set spantree tx-hold-count 4
tx hold count is set to 4.
```

The following example configures the version of spanning tree to use on the device:

```
G450-001(super)# set spantree version rapid-spanning-tree
Spanning tree version is set to rapid spanning tree.
```

The following example displays spanning tree information:

```
Spanning tree state is enabled

Designated Root: 00-04-0d-ea-b0-2d
Designated Root Priority: 32768
Designated Root Cost: 0
Designated Root Port: No root port, Bridge is Designated root
Root Max Age: 20 Hello Time: 2
Root Forward Delay: 15

Bridge ID MAC ADDR: 00-04-0d-ea-b0-2d
Bridge ID priority: 32768
Bridge Max Age: 20 Bridge Hello Time: 2
Bridge Forward Delay: 15 Tx Hold Count 3
Spanning Tree Version is rapid spanning tree
Spanning Tree Default Path Costs is according to common spanning tree

Port State Cost Priority
-----
10/5 not-connected 4 128
10/6 not-connected 4 128
```

## Summary of spanning tree commands

For more information about these commands, see *Avaya G450 CLI Reference*, 03-300437.

**Table 96: Spanning tree CLI commands**

Command	Description
<code>set port edge admin state</code>	Assign or de-assign RSTP edge-port admin state to a port for Rapid Spanning Tree Protocol (RSTP) treatment
<code>set port point-to-point admin status</code>	Specify a port's connection type
<code>set port spantree</code>	Enable or disable spanning tree for specific ports
<code>set port spantree cost</code>	Set the spanning tree cost of a port
<code>set port spantree force-protocol-migration</code>	Force the port to send a rapid spanning tree hello packet (Bridge Protocol Data Unit)
<code>set port spantree priority</code>	Set the spanning tree priority level of a port
<code>set spantree default-path-cost</code>	Set the version of the spanning tree default path cost used by the current bridge
<code>set spantree enable disable</code>	Enable or disable the spanning-tree algorithm for the media gateway
<code>set spantree forward-delay</code>	Specify the time used when transferring the state of a port to the forwarding state
<code>set spantree hello-time</code>	Specify the time interval between the generation of configuration BPDUs by the root
<code>set spantree max-age</code>	Specify the time to keep an information message before it is discarded
<code>set spantree priority</code>	Set the bridge priority for the spanning tree
<code>set spantree tx-hold-count</code>	Set the value in packets used by the spanning tree in order to limit the maximum number of BPDUs transmitted during a hello-time period
<code>set spantree version</code>	Set the version of the spanning tree protocol used by the device
<code>show port edge state</code>	Display the edge state of a specified port

1 of 2



Table 96: Spanning tree CLI commands (continued)

Command	Description
<code>show port point-to-point status</code>	Display the point-to-point status of a specific port or all ports
<code>show spantree</code>	Display spanning-tree information

**2 of 2**

---

## Port classification

With the G450, you can classify any port as either regular or valuable. Classifying a port as valuable means that a link fault trap is sent in the event of a link failure. The trap is sent even when the port is disabled. This feature is particularly useful for the port redundancy application, where you need to be informed about a link failure on the dormant port.

**Note:**

The 1 GB ports are classified as valuable by default.

---

## Port classification CLI commands

Use the following commands to configure port classification. For more information about these commands, see *Avaya G450 CLI Reference*, 03-300437.

- Use the `set port classification` command to set the port classification to either regular or valuable. Any change in the spanning tree state from forwarding for a valuable port will erase all learned MAC addresses in the switch.
- Use the `show port classification` command to display a port's classification.

---

## Port classification configuration examples

The following example classifies a port as a valuable port:

```
G450-001(super)# set port classification 6/5 valuable
Port 6/5 classification has been changed.
```

## Configuring advanced switching

The following example displays the port classification of all ports on the G450:

```
G450-001(super)# show port classification
Port      Port Classification
-----  -
10/5      valuable
10/6      regular
```

---

## Summary of port classification commands

For more information about these commands, see *Avaya G450 CLI Reference*, 03-300437.

**Table 97: Port classification CLI commands**

Command	Description
<b>set port classification</b>	Set the port classification to either regular or valuable (any change in the spanning tree state from forwarding for a valuable port will erase all learned MAC addresses in the switch)
<b>show port classification</b>	Display port classification for a specified port or all ports

# Chapter 17: Configuring monitoring applications

The Avaya G450 Media Gateway provides several software tools for monitoring and diagnosing your network. Use these tools to monitor the status of your network operations, and to analyze the flow of information.

---

## Configuring RMON

Remote Monitoring (RMON), the internationally recognized network monitoring standard, is a network management protocol that allows network information to be gathered at a single workstation. You can use RMON probes to monitor and analyze a single segment only. When you deploy a switch on the network, there are additional components in the network that cannot be monitored using RMON. These components include the switch fabric, VLAN, and statistics for all ports.

RMON is the internationally recognized and approved standard for detailed analysis of shared Ethernet media. It ensures consistency in the monitoring and display of statistics between different vendors.

RMON's advanced remote networking capabilities provide the tools needed to monitor and analyze the behavior of segments on a network. In conjunction with an RMON agent, RMON gathers details and logical information about network status, performance, and users running applications on the network.

An RMON agent is a probe that collects information about segments, hosts, and traffic, and sends the information to a management station. You use specific software tools to view the information collected by the RMON agent on the management station.

You can configure RMON for switching on the Avaya G450 Media Gateway. The G450 uses RMON I, which analyzes the MAC layer (Layer 2 in the OSI seven-layer model). You can also configure a port to raise an SNMP trap whenever the port fails.

## RMON CLI commands

Use the following commands to configure RMON. For more information about these commands, see *Avaya G450 CLI Reference*, 03-300437.

- Use the **clear rmon statistics** command to clear RMON statistics.
- Use the **rmon alarm** command to create an RMON alarm entry.
- Use the **rmon event** command to create an RMON event entry.
- Use the **rmon history** command to create an RMON history entry.
- Use the **show rmon alarm** command to display all RMON alarm entries.
- Use the **show rmon event** command to display RMON event entries.
- Use the **show rmon history** command to display RMON alarm entries.
- Use the **show rmon statistics** command to display RMON statistics.

---

## RMON configuration examples

The following example creates an RMON alarm entry:

```
G450-001(super)# rmon alarm 1 1.3.6.1.2.1.16.1.1.1.5.16777216 20 delta
rising-threshold 10000 32 falling-threshold 1000 32 risingOrFalling root
alarm 1 was created successfully
```

The following example creates an RMON event entry:

```
G450-001(super)# rmon event 32 log description "Change of device" owner root
event 32 was created successfully
```

The following example creates an RMON history entry with an index of 80 on port 10/2, recording activity over 60 intervals (buckets) of 20 seconds each.

```
G450-001(super)# rmon history 80 10/2 interval 20 buckets 60 owner root
history index 80 was created successfully
```

The following example displays information about an RMON alarm entry:

```
G450-001(super)# show rmon alarm 1
alarm
alarm 1 is active, owned by root
Monitors ifEntry.1.16777216 every 20 seconds
Taking delta samples, last value was 0
Rising threshold is 10000, assigned to event # 32
Falling threshold is 1000, assigned to event # 32
On startup enable rising or_falling alarms
```

The following example displays information about an RMON event entry:

```
G450-001(super)# show rmon event 32
event
Event 32 is active, owned by root
Description is Change of device
Event firing causes log,last fired 12:36:04
```

The following example displays information about an RMON history entry:

```
G450-001(super)# show rmon history 80
history
Entry 80 is active, owned by root
Monitors the port 10/2 every 20 seconds
Requested # of time intervals, ie buckets, is 60
Granted # of time intervals, ie buckets, is 60
Sample # 2 began measuring at 0:21:16
Received 4081 octets, 41 packets,
0 broadcast and 10 multicast packets,
0 undersize and 0 oversize packets,
0 fragments and 0 jabbers,
0 CRC alignment errors and 0 collisions,
# of dropped packet events (due to a lack of resources): 0
Network utilization is estimated at 0
```

The following example displays RMON statistics for a port:

```
G450-001(super)# show rmon statistics 10/2
Statistics for port 10/2 is active, owned by Monitor
Received 6952909 octets, 78136 packets,
26 broadcast and 257 multicast packets,
0 undersize and 0 oversize packets,
0 fragments and 0 jabbers,
0 CRC alignment errors and 0 collisions,
# of dropped packet events (due to a lack of resources): 0
# of packets received of length (in octets):
64:18965, 65-127:295657, 128-255:4033,
256-511:137, 512-1023:156, 1024-1518:0,
```

---

## Summary of RMON commands

For more information about these commands, see *Avaya G450 CLI Reference*, 03-300437.

**Table 98: RMON CLI commands**

Command	Description
<code>clear rmon statistics</code>	Clear RMON statistics
<code>rmon alarm</code>	Create or delete an RMON alarm entry
<code>rmon event</code>	Create or delete an RMON event entry
<code>rmon history</code>	Create or delete an RMON history entry
<code>show rmon alarm</code>	Display information about a specific RMON alarm entry or all existing RMON alarm entries
<code>show rmon event</code>	Display a specific RMON event entry or all RMON event entries
<code>show rmon history</code>	Display a specific RMON history entry or all RMON history entries
<code>show rmon statistics</code>	Display RMON statistics for a specific interface or for all interfaces

---

## Configuring and analyzing RTP statistics

The RTP statistics application collects data and statistics for RTP sessions (streams) from the gateway VoIP engine. You can view the data and configure SNMP traps to be generated when the QoS level falls below a configured level.

**Note:**

An alternative tool available from Avaya for debugging QoS problems is VMON. VMON is an RTCP QoS reports collector. VMON support, available in all Avaya devices, is the capability of a VoIP device to send a copy of an RTCP message to the IP address of a VMON server. VMON can collect RTCP reports, store them on its host hard disk, and analyze and generate graphic reports. However, VMON requires a dedicated Windows server. The RTP statistics application runs on the G450's firmware, and does not require any dedicated hardware. For information about configuring VMON in Avaya Communication Manager, see *Administrator Guide for Avaya Communication Manager*, 03-300509.

**Note:**

The gateway performs traceroutes whenever RTP statistics is enabled.

The RTP statistics application provides the following functionality:

- Collects QoS data from the gateway VoIP engine(s), including Real-Time Control Protocol (RTCP) data, traceroute reports, and information from the DSP regarding jitter buffer, internal delays, and so on

**Note:**

RTCP is a standard QoS report companion protocol to RTP. RTP endpoints periodically send RTCP report packets to their remote peer (or peers in multicast). RTCP reports include QoS data such as delay, jitter, and loss.

- Collects call data from the gateway, such as duration, start-time, and end-time
- Displays the RTP statistics in CLI and MIB formats
- Displays summary reports for the VoIP engine(s)
- Assesses QoS status based on configurable thresholds on an extensive set of QoS metrics
- Generates QoS traps. QoS traps are notifications sent via SNMP upon termination of an RTP stream that suffers from bad QoS. These notifications include extensive data about the session that enables offline troubleshooting of QoS problems. The trap rate is controlled by a configurable trap rate limiter.

**Note:**

QoS trap generation is an especially convenient troubleshooting tool for large installations, since all devices that support the RTP statistics application can be configured to send traps to a single SNMP trap manager.

- Generates QoS fault and clear traps. QoS fault traps are notifications that are sent when more than a configurable number of active sessions have QoS indicators over the configured thresholds. A QoS clear trap is a notification that is sent after a QoS fault trap when the number of active RTP sessions with QoS indicators over the configured thresholds reduces to a specified number.

---

## Configuring the RTP statistics application

To configure the RTP statistics application, work through the following sections, in order:

- [Viewing RTP statistics thresholds](#)
- [Configuring RTP statistics thresholds](#)
- [Enabling and resetting the RTP statistics application](#)
- [Viewing application configuration](#)
- [Configuring QoS traps](#)

## Configuring monitoring applications

- [Configuring QoS fault and clear traps](#)
- [Configuring the trap rate limiter](#)

## Viewing RTP statistics thresholds

The RTP statistics application uses a system of thresholds to evaluate levels of QoS during RTP sessions. The thresholds are configured on several QoS metrics. Your configuration of the thresholds determines when the application evaluates a session as having bad QoS conditions.

This section describes the thresholds that you can configure, how you can view the thresholds that are currently configured, and the metrics on which you can configure them.

The RTP statistics application samples the VoIP engine every RTCP interval, which is configured in Avaya Communication Manager, where it is called “RTCP Report Period”. The RTCP interval is typically 5 to 8 seconds. For information about configuring the RTCP interval (RTCP report period), see *Administrator Guide for Avaya Communication Manager*, 03-300509.

### Thresholds types

- **A threshold on a metric.** For example, you can configure a threshold on the metric ‘packet loss’. The application samples the metric every RTP interval and increments a counter (event counter) if the sampled value is over the threshold. Hence, the ‘event-counter’ represents the number of times the metric was sampled over its threshold.
- **An event threshold.** An event threshold is a threshold on an event counter. If QoS traps are configured, the application generates a QoS trap when, at the end of a session, one or more event counters are over their event thresholds. For example, if the event threshold for packet loss is 2, the application generates a QoS trap if packet loss is sampled over its threshold two or more times.
- **Thresholds on metric averages.** The application calculates averages of some of the metrics. When an RTP session terminates, the application evaluates the average metrics and generates a QoS trap (if QoS traps are configured) if one of them is over its corresponding threshold.

#### Note:

All CLI commands described in this section are available in the general context of the CLI.



## Viewing the configured thresholds

1. Enter `show rtp-stat thresholds`. For example:

```
G450-001(super)# show rtp-stat thresholds
```

Item	Threshold	Event Threshold
Codec Loss	6.0%	1
Average Codec Loss	3.0%	N/A
Codec RTT	700mS	2
Echo Return Loss	0dB	1
Loss	6.0%	2
Average Loss	3.0%	N/A
Remote Loss	6.0%	2
Average Remote Loss	3.0%	N/A
RTT	500mS	2
Local Jitter	50mS	2
Remote Jitter	50mS	2
SSRC Changes	N/A	2

[Table 99](#) describes the QoS metrics on which thresholds are configured, and the time at which each metric is evaluated.

**Table 99: QoS metrics**

Metric	Description	Evaluation time
Codec Loss	The percentage of time the codec plays fill frames due to lack of valid RTP frames. Possible causes include jitter and packet loss.	Every RTCP interval
Average Codec Loss	The average codec loss measurement since the beginning of the RTP stream	At the end of the session
Codec RTT	An estimation of the overall Round Trip Time (RTT) on the voice-channel, including the network delay and internal delays. RTT is the time taken for a message to get to the remote peer and back to the local receiver.	Each time an RTCP packet is received
Echo Return Loss	The echo cancellation loss on the TDM bus	Every RTCP interval
Loss	The estimated network RTP packet loss. The VoIP engine evaluates the current received packet loss every RTCP interval – usually 5 to 8 seconds. The VoIP engine postpones loss estimation until the next interval if the number of packets received is less than the minimum statistic window. The minimum statistic window is configured with the CLI command <code>rtp-stat min-stat-win</code> .	Every RTCP interval

1 of 2

**Table 99: QoS metrics (continued)**

Metric	Description	Evaluation time
Average Loss	The average packet loss evaluation since the beginning of the RTP stream	At the end of the session
Remote Loss	The network loss according to the remote RTP receiver. The device learns of the remote packet loss from received RTCP messages.	Each time an RTCP packet is received
Average Remote Loss	The average remote network loss measurement since the beginning of the RTP stream	At the end of the session
RTT	The network RTT. This metric does not include internal delay. The device learns of the RTT from RTCP messages.	Each time an RTCP packet is received
Local Jitter	Variation in delay of packet delivery to the local peer	Every RTCP interval
Remote Jitter	Variation in delay of packet delivery to the remote peer. The device learns of the remote jitter from RTCP messages.	Each time an RTCP packet is received
SSRC Changes	The number of times the RTP SSRC field in received RTP packets has changed	Every RTCP interval

**2 of 2**

## Configuring RTP statistics thresholds

RTP statistics thresholds should be configured so that incrementation of QoS event counters coincides with real detectable bad QoS in your network. Optimal values are different for each network. Configure any thresholds that are not already configured as you require them. See [Viewing RTP statistics thresholds](#) on page 376.

For a description of each metric, see [Table 99](#). The Codec metrics, Codec loss and Codec RTT are useful for evaluating the actual user experience. The other metrics are useful for identifying network problems that contribute to QoS problems experienced by the user. For example, the Codec RTT metric indicates the overall delay experienced by the user. If you configure a meaningful threshold on the Codec RTT metric, metrics such as Local Jitter, Remote Jitter, and rtt metrics may help you identify causes when Codec RTT exceeds its threshold.

## Configuring RTP statistics thresholds

1. Use the **rtp-stat thresholds** command to set thresholds on QoS indicators. For example:

```
G450-001(super)# rtp-stat thresholds echo-return-loss 5
Done!
```

With this example configuration, if echo-return-loss is sampled higher than 5 dB during an RTP session, the echo-return-loss event counter increments.

2. Use the **rtp-stat event-threshold** command to set thresholds on QoS events. For example:

```
G450-001(super)# rtp-stat event-threshold echo-return-loss 2
Done!
```

With this example configuration, if echo-return-loss is sampled over its threshold more than twice during an RTP session, the application considers the session to have QoS faults.

## Enabling and resetting the RTP statistics application

When you enable the RTP statistics application on the gateway, the application starts to collect QoS data from the VoIP engine(s) and stores the data in the gateway RAM, which holds a limited history of RTP session entries. The VoIP engine also starts to perform and report UDP traceroutes.

Session data and automatic session traceroute results can be viewed using the CLI.

### Enabling the RTP statistics application

1. Enter **rtp-stat-service**. For example:

```
G450-001# rtp-stat-service

The RTP statistics service is enabled (default: disabled)
```

#### Note:

Admin level access is required in order to use the **rtp-stat-service** command.

### Resetting the RTP statistics application

1. Enter **rtp-stat clear**.

All counters are reset and the RTP statistics history is erased.

## Viewing application configuration

Viewing the application configuration helps you see if the application is enabled, which types of traps are enabled, and how the trap rate limiter and minimum statistics window are configured. The minimum statistics window is the minimum number of observed RTP sequence increments for which the application evaluates packet loss.

- Enter **show rtp-stat config**. For example:

```
G450-001(super)# show rtp-stat config

RTP Statistic: Enabled
QoS Trap: Enabled
QoS Fault Trap: Enabled
    Fault: 2
    Clear: 0
QoS Trap Rate Limiter:
    Token Interval: 10.00 seconds
    Bucket Size: 5
Session Table:
    Size: 128
    Reserved: 64
Min Stat Win: 50
```

[Table 100](#) describes the output of the **show rtp-stat config** command.

**Table 100: RTP statistics application configuration**

Name	Description
RTP Statistic	Status of the RTP statistics application. Possible values: <ul style="list-style-type: none"> <li>• Enabled. The application is enabled.</li> <li>• Disabled. The application is disabled.</li> </ul>
QoS Trap	QoS trap status. Possible values: <ul style="list-style-type: none"> <li>• Enabled. The RTP statistics application is configured to generate QoS traps.</li> <li>• Disabled. The RTP statistics application is not configured to generate QoS traps.</li> </ul>
QoS Fault Trap	QoS fault trap status. Possible values: <ul style="list-style-type: none"> <li>• Enabled. The RTP statistics application is configured to generate QoS fault and clear traps.</li> <li>• Disabled. The RTP statistics application is not configured to generate QoS fault and clear traps.</li> </ul>
Fault	The QoS fault trap boundary. That is, the minimum number of active sessions with QoS faults that triggers a QoS fault trap.

**Table 100: RTP statistics application configuration (continued)**

Name	Description
Clear	The QoS clear trap boundary. That is, the reduced number of active sessions with QoS faults that triggers a QoS clear trap to be sent after a QoS fault trap was sent.
QoS Trap Rate Limiter:	
Token Interval	The displayed token interval is in seconds. The maximum long term trap rate, expressed as an interval in seconds. In the example shown, the maximum long term trap rate is one trap every 10 seconds.
Bucket Size	The maximum number of tokens stored in the token bucket of the trap rate limiter. This item limits the size of a QoS trap burst.
Session Table:	
Size	The maximum number of RTP session entries held in the session table in the gateway RAM
Reserved	The number of rows in the session table that are reserved for sessions with QoS problems. In the example shown, the table size is 128 and the reserved number is 64. If, from 1000 sessions only 300 had QoS problems, the session table will hold at least the last 64 sessions that had QoS problems. Note that if the last 128 sessions all had QoS problems, all rows in the session table will be filled with sessions that had QoS problems.
Min Stat Win	The minimum statistic window configured for the RTP statistics application. That is, the minimum number of observed RTP sequence increments for which the application evaluates packet loss.
<b>2 of 2</b>	

### Configuring QoS traps

You can configure the application to automatically generate QoS traps via SNMP at the termination of RTP sessions that have QoS problems. SNMP traps are automatically sent to the SNMP trap manager on the active Media Gateway Controller (MGC). You can also configure SNMP traps to be sent to an external trap manager. The application generates a QoS trap when, at the end of an RTP session, one or more event counters are over their event thresholds. For example, if the event threshold for packet loss is 2, the application generates a trap at the termination of any session in which packet-loss was sampled over its threshold twice or more during the session.

 **CAUTION:**

If the thresholds for trap generation are set too low, a significant amount of trap traffic will be generated and negatively impact network performance.

#### Enabling QoS traps

1. View the RTP statistic thresholds and modify their configurations as necessary. See [Viewing RTP statistics thresholds](#) on page 376 and [Configuring RTP statistics thresholds](#) on page 378.
2. If you need to modify the minimum statistic window, use the **rtp-stat min-stat-win** command. For example:

```
G450-001(super)# rtp-stat min-stat-win 50
Done!
```

The minimum statistic window is the minimum number of observed RTP sequence increments for which the application evaluates packet loss. The VoIP engine evaluates the current received packet loss every RTCP interval. The VoIP engine postpones loss estimation to the next interval if the number of received packets is less than the minimum statistic window. By modifying the minimum statistic window, you can prevent the application from generating loss-events based on too few packets and safely configure a low packet loss threshold.

3. To configure an additional trap destination, such as an external trap manager, use the command **snmp-server host**. For example:

```
G450-001(super)# snmp-server host 136.9.71.47 traps v1 public
```

**Note:**

When using the **snmp-server host** command, you can specify only to send certain types of traps to the specified trap manager. For example, **snmp-server host 1.1.1.1 traps v1 public rtp-stat-qos rtp-stats-faults** configures only QoS traps and QoS fault and clear traps to be sent to host 1.1.1.1.

To check your current SNMP configurations, enter **show snmp**. Traps are automatically sent to the active MGC by the dynamic trap manager feature. To configure the dynamic trap manager, use the command **snmp-server dynamic-trap-manager**. For more information about the dynamic trap manager, see [Configuring dynamic trap manager](#) on page 338.

4. Enter **rtp-stat qos-trap** to enable the traps, if not already enabled. For example:

```
G450-001# rtp-stat qos-trap
The RTP statistics QoS trap is enabled
```

QoS traps are now enabled.

## Configuring QoS fault and clear traps

You can configure the RTP statistics application to send QoS fault and clear traps. A QoS fault trap is sent when a specified number of active RTP sessions have QoS indicators over the configured thresholds. A QoS clear trap is sent after a QoS fault trap when the number of active RTP sessions with QoS indicators over the configured thresholds reduces to a specified number. Since some RTP sessions can be very long, and QoS traps are sent only after the termination of the stream, QoS fault and clear traps are important for providing timely information about QoS problems.

**Note:**

QoS fault traps appear in the Network Management Console Event Log Browser, indicating to the user that there are QoS problems in a specific network device. See the *Avaya Network Management Console User Guide*, 14-300169.

- Use the **rtp-stat fault** command. For example:

```
G450-001(super)# rtp-stat fault 1 0
The fault trap boundary was set to 1 (default: 3)
The clear trap boundary was set to 0
```

With this example configuration, a QoS fault trap is sent if and when one active RTP session has QoS problems. A QoS clear trap is then sent if and when the number of active RTP sessions with QoS problems reaches 0.

## Configuring the trap rate limiter

The application features a trap rate limiter. The trap rate limiter limits the rate at which QoS traps are sent. The rate limiter protects against overloading the trap manager with bursts of traps when a single event causes multiple RTP sessions to terminate simultaneously.

The trap rate limiter uses a token bucket scheme, in which traps are sent only if there are tokens in a virtual bucket. Tokens are added to the bucket every 'token interval,' which sets the maximum long term trap rate. Each time a trap is sent, the number of tokens in the bucket decrements. The 'bucket size' is the maximum number of tokens that the bucket can hold. The bucket size limits the trap burst size.

- Use the **rtp-stat qos-trap-rate-limit** command. For example:

```
G450-001# rtp-stat qos-trap-rate-limit 2000 10
```

In this example configuration, the token-interval is 2000 and the bucket-size is 10. This means that a token is added to the bucket every 2000 hundredths of a second (20 seconds) and the bucket is limited to a maximum size of 10 tokens.

---

## Analyzing RTP statistics output

This section describes the reports, statistics, and traps you can view, how to view them, and how to understand the output.

### Viewing RTP statistics summary reports

RTP statistics summary reports display QoS trap statistics for the VoIP engine(s).

- Enter **show rtp-stat summary**. For example:

```
G450-001(super)# show rtp-stat summary
```

```
Total QoS traps: 23
```

```
QoS traps Drop : 0
```

```
QoS Fault
```

```
Engine
```

ID	Description	Uptime	Active Session	Total Session	Mean Duration	Tx TTL
000	internal	04,18:15:15	2/1	35/24	01:04:44	64



[Table 101](#) describes the fields in the summary report.

**Table 101: RTP statistics summary reports output**

Field	Description
Total QoS traps	The total number of QoS traps sent since the RTP statistics application was enabled or since the last use of the <b>rtp-stat clear</b> command
QoS traps Drop	The number of QoS traps dropped by the rate limiter since the RTP statistics application was enabled or since the last use of the <b>rtp-stat clear</b> command
QoS Fault/QoS Clear	General QoS state: QoS Fault means that the number of active RTP sessions with QoS faults is currently higher than the QoS fault boundary. QoS Clear means that the number of active RTP sessions with QoS faults is currently less than or equal to the QoS clear boundary. You can configure the QoS fault and clear boundaries using the <b>rtp-stat fault</b> command. See <a href="#">Configuring QoS fault and clear traps</a> on page 383.
Engine ID	The ID of the VoIP engine. Since the G450 has one VoIP engine, one line appears in the table.
Description	Description of the VoIP engine
Uptime	The uptime of the RTP statistics application. This is the time since the RTP statistics application was enabled or since the last use of the <b>rtp-stat clear</b> command.
Active Session	The number of active sessions / number of active sessions with QoS problems
Total Session	The total number of sessions / number of sessions that had QoS problems
Mean Duration	The mean RTP session duration (calculated only for terminated calls)
Tx TTL	The IP Time To Live (TTL) field for transmitted RTP packets

## Viewing RTP session statistics

Using the CLI, you can view a summary of active and terminated sessions and you can view RTP statistics for a given RTP session.

## Configuring monitoring applications

The **show rtp-stat sessions** command displays a summary of the active and/or terminated RTP sessions in the session table. For example:

```
G450-001(super)# show rtp-stat sessions last 5
```

ID	QoS	Start date and time	End Time	Type	Destination
00031		2004-10-20,10:51:36	10:59:07	G729	135.8.76.64
00032	*	2004-10-20,10:53:42	10:57:36	G723	135.8.76.107
00033	*	2004-10-20,10:58:21	10:59:06	G723	135.8.76.107
00034		2004-10-20,11:08:40	-	G729	135.8.76.64
00035	*	2004-10-20,11:09:07	-	G723	135.8.76.107

An asterisk (\*) in the QoS column indicates that the session had QoS problems.

The **show rtp-stat detailed** command displays detailed information about a specified active or terminated RTP session, including the QoS metrics reported by the RTP statistics application. For example:

```
G450-001(super)# show rtp-stat detailed 35
```

Session-ID: 35<sup>1</sup>  
Status: Terminated<sup>2</sup>, QOS: Faulted<sup>3</sup>, EngineId: 0<sup>4</sup>  
Start-Time: 2004-10-20<sup>5</sup>,11:09:07<sup>6</sup>, End-Time: 2004-10-20,11:13:40<sup>7</sup>  
Duration: 00:04:33<sup>8</sup>  
CName: gwp@135.8.118.252<sup>9</sup>  
Phone: 69:2011<sup>10</sup>  
Local-Address: 135.8.118.252:2061<sup>11</sup> SSRC 154611212<sup>12</sup>  
Remote-Address: 135.8.76.107:2061<sup>13</sup> SSRC 2989801899 (0)<sup>14</sup>  
Samples: 54<sup>15</sup> (5 sec)<sup>16</sup>

Codec:  
G723<sup>17</sup> 62B<sup>18</sup> 30mS<sup>19</sup> Off<sup>20</sup>, Silence-suppression(Tx/Rx) Disabled<sup>21</sup>/Not-Supported<sup>22</sup>,  
Play-Time 272.610sec<sup>23</sup>, Loss 0.0%<sup>24</sup> #1<sup>25</sup>, Avg-Loss 0.1%<sup>26</sup>, RTT 741mS<sup>27</sup> #38<sup>28</sup>,  
Avg-RTT 570mS<sup>29</sup>, JBuf-under/overruns 0.1%<sup>30</sup>/0.0%<sup>31</sup>, Jbuf-Delay 22mS<sup>32</sup>,  
Max-Jbuf-Delay 60mS<sup>33</sup>

Received-RTP:  
Packets 9236<sup>34</sup>, Loss 0.0%<sup>35</sup> #0<sup>36</sup>, Avg-Loss 0.0%<sup>37</sup>, RTT 604mS<sup>38</sup> #38<sup>39</sup>, Avg-RTT  
376mS<sup>40</sup>, Jitter 0mS<sup>41</sup> #0<sup>42</sup>, Avg-Jitter 0mS<sup>43</sup>, TTL(last/min/max) 63/63/63<sup>44</sup>,  
Duplicates 0<sup>45</sup>, Seq-Fall 0<sup>46</sup>, DSCP 46<sup>47</sup>, L2Pri 12<sup>48</sup>, RTCP 54<sup>49</sup>

Transmitted-RTP:  
VLAN 1<sup>50</sup>, DSCP 184<sup>51</sup>, L2Pri 6<sup>52</sup>, RTCP 62<sup>53</sup>

Remote-Statistics:  
Loss 0.0%<sup>54</sup> #0<sup>55</sup>, Avg-Loss 0.0%<sup>56</sup>, Jitter 0mS<sup>57</sup> #0<sup>58</sup>, Avg-Jitter 0mS<sup>59</sup>

Echo-Cancellation:  
Loss 45dB<sup>60</sup> #1<sup>61</sup>, Len 32mS<sup>62</sup>

RSVP:  
Status Disabled<sup>63</sup>, Failures 0<sup>64</sup>

[Table 102](#) describes the fields in the `show rtp-stat detailed` command output according to the numbered labels in the example.

**Table 102: Detailed CLI output per RTP session**

Field	Label	Description	From the CLI example
Session-ID	1	An arbitrary index number for the session in the session table	Session-ID: 35
Status	2	The status of the session. Possible values: <ul style="list-style-type: none"> <li>● Active. The session is still open.</li> <li>● Terminated. The session is finished.</li> </ul>	Status: Terminated
QoS	3	The QoS status of the session. Possible values: <ul style="list-style-type: none"> <li>● OK. There are no QoS problems in the session.</li> <li>● Faulted. There are QoS problems in the session.</li> </ul>	QoS: Faulted
EngineId	4	The ID of the VoIP engine. The G450 has one VoIP engine.	EngineId: 0
Start-Time	5	The date of the RTP session	2004-10-20
	6	The start time of the RTP session	Start-Time: 2004-10-20,11:09:07
End-Time	7	The end time of the RTP session	End-Time: 2004-10-20,11:13:40
	8	The duration of the RTP session	Duration: 00:04:33
CName	9	format: gwt@<MGP-address>	CName: gwp@135.8.118.252

**1 of 6**

**Table 102: Detailed CLI output per RTP session (continued)**

Field	Label	Description	From the CLI example
Phone	10	<p>The local extension number and conference ID in format &lt;conference ID&gt;:&lt;extension number&gt;.</p> <p>Conference calls can involve more than one entry in the session table. Multiple sessions belonging to the same conference call can usually be identified by a common conference ID.</p> <p>Notes:</p> <ul style="list-style-type: none"> <li>• Phone data is received from Avaya Communication Manager only if VMON is configured.</li> <li>• If you are not running VMON, you can cause Avaya Communication Manager to send the phone data by configuring a dummy RTCP-server for the region, with a 'localhost' IP address (127.x.x.x).</li> </ul>	Phone: 69:2011
Local-Address	11	The PMI. The number after the colon is the UDP port number.	Local-Address: 135.8.118.252:2061
Remote-Address	13	The remote VoIP engine, gateway PMI, or IP phone address. The number after the colon is the UDP port number.	Remote-Address: 135.8.76.107:2061
	12, 14	SSRC ID. The number in parentheses is the number of observed SSRC changes during the session.	SSRC 2989801899 (0)
Samples	15	The number of times the application has sampled the VoIP engine (RTP receiver) statistics.	Samples: 54 <sup>15</sup> (5 sec)
	16	The sampling interval	Samples: 54 (5 sec) <sup>16</sup>
Codec:	17	The codec used for the session	G723
	18	The RTP packet size, in bytes	62B
	19	The RTP packet interval, in ms	30mS
	20	The encryption method	Off

Table 102: Detailed CLI output per RTP session (continued)

Field	Label	Description	From the CLI example
Silence suppression (Tx/Rx)	21	The received silence suppression method	Silence-suppression (Tx/Rx) Disabled <sup>21</sup> /Not-Supported
	22	The transmitted silence suppression method	Silence-suppression (Tx/Rx) Disabled/Not-Supported <sup>22</sup>
Play-Time	23	The overall time the codec played valid received frames	Play-Time 272.610sec
Codec Loss <i>codec-loss%</i>	24	The last value of codec loss sampled. Codec loss is the percentage of time the codec played fill frames due to lack of valid RTP frames. Possible causes include jitter and packet loss.	Loss 0.0% <sup>24</sup> #1
<i>#codec-loss-events</i>	25	The codec loss event counter	Loss 0.0% #1 <sup>25</sup>
Avg-Loss	26	The average of all codec loss values sampled during the session	Avg-Loss 0.1%
RTT <i>rtt ms</i>	27	The last sampling of codec round trip time (RTT), in ms. Codec RTT is the round-trip delay experienced by the user, including internal delay. This value is not entirely accurate since remote internal delays are not always known.	RTT 741ms <sup>27</sup> #38
<i>#rtt-events</i>	28	The codec RTT event counter	RTT 741ms #38 <sup>28</sup>
Avg-RTT	29	The average of all codec RTT values sampled during the session	Avg-RTT 570ms
Jbuf-under/overruns	30	The estimated percentage contribution of jitter-buffer underruns to the average codec loss	JBuf-under/overruns 0.1% <sup>30</sup> /0.0%
	31	The estimated percentage contribution of jitter-buffer overruns to the average codec loss	JBuf-under/overruns 0.1%/0.0% <sup>31</sup>
Jbuf-delay	32	The last jitter buffer delay	Jbuf-Delay 22ms
Max-Jbuf-Delay	33	The maximum jitter buffer delay during the session	Max-Jbuf-Delay 60ms

3 of 6

**Table 102: Detailed CLI output per RTP session (continued)**

Field	Label	Description	From the CLI example
Received RTP:			
Packets	34	The total number of received packets	Packets 9236
Loss loss%	35	The last sampled value of network RTP packet loss	Loss 0.0% <sup>35</sup> #0
#loss-events	36	The network RTP packet loss event counter	Loss 0.0% #0 <sup>36</sup>
Avg-loss	37	The average of all network RTP packet loss values during the session	Avg-Loss 0.0%
RTT rtt ms	38	The network RTT. The RTT is calculated upon RTCP packet reception.	RTT 604ms <sup>38</sup> #38
#rtt-events	39	The network RTT event counter	RTT 604mS #38 <sup>39</sup>
Avg-RTT	40	The average of all network RTT values during the session	Avg-RTT 376mS
Jitter jitter ms	41	The network jitter at the RTP receiver. Combined with long RTT, a large jitter value may indicate WAN congestion.	Jitter 0mS <sup>41</sup> #0
#jitter-event	42	The RTP receiver network jitter event counter	Jitter 0mS #0 <sup>42</sup>
Avg-Jitter	43	The average of all network jitter values during the session	Avg-Jitter 0mS
TTL (last/min/max)	44	The last value of TTL, minimum value of TTL, and maximum value of TTL sampled during the session. TTL changes during a session may indicate route flaps in the IP network.	TTL(last/min/max) 63/63/63
Duplicates	45	This counter increments each time two consecutive RTP packets with the sample RTP sequence number are received. A large number of duplicates may indicate problems in the Layer 2/Ethernet topology (for example, loops).	Duplicates 0

Table 102: Detailed CLI output per RTP session (continued)

Field	Label	Description	From the CLI example
Seq-Fall	46	This counter increments each time an RTP packet with a sequence number less than the last known sequence is received. Packet resequencing may be caused by switching to a backup WAN interface or route flaps.	Seq-Fall 0
DSCP	47	The last received DSCP value of the RTP packets	DSCP 46
L2Pri	48	The last received Layer 2 priority value of an RTP packet (usually IEEE802.1p)	L2Pri 12
RTCP	49	The total number of received RTCP packets	RTCP 54
Transmitted-RTP:			
VLAN	50	The VLAN-ID on which the RTP packets are transmitted	VLAN 1
DSCP	51	The DSCP of RTP packets	DSCP 184
L2Pri	52	The Layer 2 priority of transmitted RTP packets (usually 802.1p)	L2Pri 6
RTCP	53	The total number of transmitted RTCP packets	RTCP 62
Remote-Statistics: (Remote-Statistics items are calculated and evaluated upon reception of RTCP messages)			
Loss <i>rem-loss%</i>	54	The network loss experienced by the remote RTP receiver. The local RTP receiver learns about its remote peer statistics from RTCP packets.	Loss 0.0% <sup>54</sup> #0
<i>#rem-loss-ev</i>	55	The number of samples that were over the rem-loss threshold	Loss 0.0% #0 <sup>55</sup>
Avg-Loss	56	The average network loss experienced by the remote RTP receiver	Avg-Loss 0.0%
Jitter <i>rem-jitter</i>	57	The network jitter experienced by the remote RTP receiver	Jitter 0mS <sup>57</sup> #0
<i>#rem-jitter-ev</i>	58	The number of samples that were over the remote jitter threshold	Jitter 0mS #0 <sup>58</sup>

5 of 6

**Table 102: Detailed CLI output per RTP session (continued)**

Field	Label	Description	From the CLI example
Avg-jitter	59	The average remote jitter	Avg-Jitter 0mS
Echo Cancellation:			
Loss loss dbm	60	The echo cancellation loss on the TDM bus. A high value (that is, a low absolute value) may indicate impairment of DCP terminals.	Loss 45dB <sup>60</sup> #1
#loss-ev	61	A counter that increments each time the echo-cancellation loss is sampled below its threshold	Loss 45dB #1 <sup>61</sup>
Len	62	The last echo-cancellation tail length used for this session	Len 32mS
RSVP:			
Status	63	The current (last) RSVP reservation state at the end of the session	Status Disabled
Failures	64	The total number of reservation failures during the session	Failures 0
			<b>6 of 6</b>

## Viewing QoS traps, QoS fault traps, and QoS clear traps

QoS traps, QoS fault traps, and QoS clear traps sent to the active MGC by the dynamic trap manager are converted to syslog messages by the SNMP Trap manager on the MGC.

The syslog messages are stored in the messages file on the MGC hard disk. You can view the syslog messages through the Avaya Maintenance Web Interface to debug the QoS problems.

1. In the Avaya Maintenance Web Interface, enter the **Setup log viewing** screen.
2. In the Select Log Types list, select **Linux syslog**.
3. Under Select Event Range, select the date range over which you want to view traps.
4. In the **Match Pattern** field, enter the string **avrtp**.
5. In the **Number of Lines** field, enter the maximum number of traps you want to view.
6. Click **View Log**. The **View System Logs** screen appears ([Figure 32](#)). Each line contains one message.



Figure 32: Viewing syslog messages

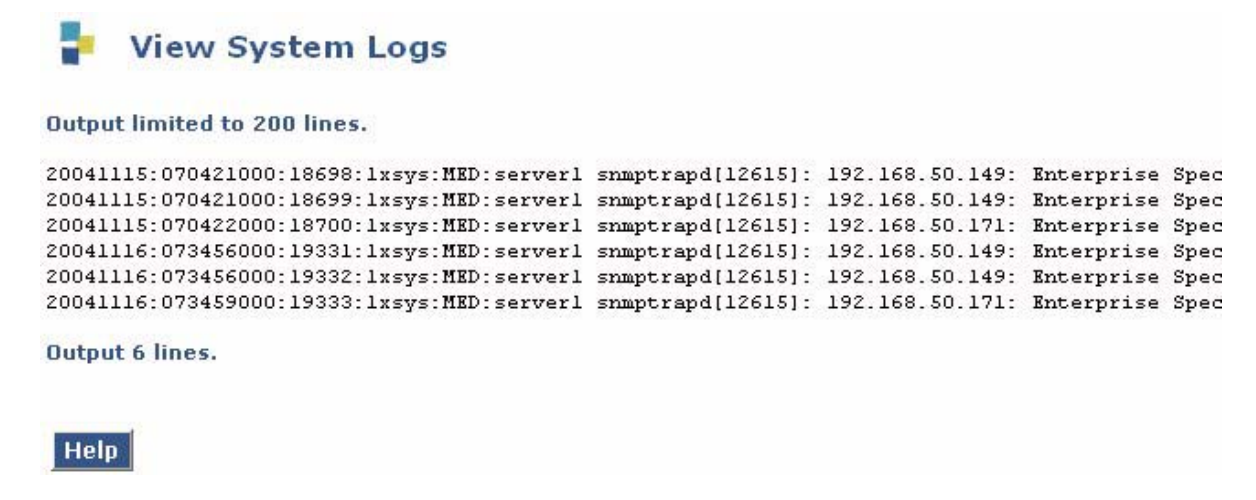

## Analyzing QoS trap output

The following is an example of the syslog message for the QoS trap sent upon termination of RTP session 35 (see the session ID in bold), which terminated at 11:13:40 on Oct. 20:

```

Oct 201 11:13:402 LZ-SIT-SR1 snmptrapd[9407]: 135.8.118.2523 [135.8.118.252]: Trap
sysUpTime.0 = Timeticks: (43147723) 4 days, 23:51:17.234, snmpTrapOID.0 = OID: av
RtpQoSTrap5, avRtpSessionLocAddrV4.0 = IpAddress: 135.8.118.2526,
avRtpSessionRemAddrV4.0 = IpAddress: 135.8.76.1077, avRtpSessionDuration.0 =
INTEGER: 2738, avRtpSessionCname.0 = STRING: gwp@135.8.118.2529,
avRtpSessionPhone.0 = STRING: 69:201110, avRtpSessionSeverity.0 = INTEGER:
warning(4), avRtpSessionDebugStr.0 = STRING: Id{35}11;
Traps{2412/013};Stats{S 5414 RTCP 5415 RX 923616};Codec{g72317 62B18 encryptionOff19
SSup disabled20/disabled21 Loss 0.1%22 #123 RTT 570mS24 #3825 Jbuf
0.1%26/0.0%27};Net{Loss 0.0%28 #029 RTT 376mS30 #3831 Jtr #032 TTL 63-6333 Dup 034
Fall 035};Rem{Loss 0.0%36 #037 Jtr #038} EC{Loss 45dB39}
    
```

[Table 103](#) describes the fields in the QoS trap according to the numbered labels in the example.

Table 103: QoS Trap output fields

Label	Description	From the trap example
1	The date on which the trap was received	Oct 20
2	The time at which the trap was received	11:13:40
3	The IP address of the local MGP	135.8.118.252

**1 of 4**

**Table 103: QoS Trap output fields (continued)**

Label	Description	From the trap example
4	The gateway up time	sysUpTime.0 = Timeticks: (43147723) 4 days, 23:51:17.23
5	The trap name, which indicates that this is a QoS trap	snmpTrapOID.0 = OID: av RtpQoSTrap
6	The local gateway PMI	avRtpSessionLocAddrV4.0 = IpAddress: 135.8.118.252
7	The remote VoIP engine, gateway PMI, or IP phone address	avRtpSessionRemAddrV4.0 = IpAddress: 135.8.76.107
8	The duration of the RTP session	Duration: 00:04:33
9	Format: gwt@<MGP-address>	avRtpSessionCname.0 = STRING: gwp@135.8.118.252
10	The local extension number and conference ID in format <conference ID>:<extension number>. Conference calls can involve more than one entry in the session table. Multiple sessions belonging to the same conference call can usually be identified by a common conference ID. Notes: <ul style="list-style-type: none"> <li>• The phone string data is received from Avaya Communication Manager if VMON is configured.</li> <li>• If you are not running VMON, you can cause Avaya Communication Manager to send the phone string data by configuring a dummy RTCP-server for the region, with a 'localhost' IP address (127.x.x.x).</li> </ul>	avRtpSessionPhone.0 = STRING: 69:2011
11	An arbitrary index number for the session in the session table	avRtpSessionDebugStr.0 = STRING: Id{35}
12	The total number of sent traps since the application was enabled	Traps{24 <sup>11</sup> /0}
13	The number of traps that were dropped by the trap rate limiter since the application was enabled. This item can be used, when analyzing received traps logs, to identify missing traps (due to network conditions or the rate limiter). This is also displayed by the <b>show rtp-stat summary</b> command.	Traps{24/0 <sup>12</sup> }
14	The number of times the application sampled the VoIP engine (RTP receiver) statistics	Stats{S 54}

Table 103: QoS Trap output fields (continued)

Label	Description	From the trap example
15	The total number of received RTCP packets	Stats{S 54 RTCP 54 <sup>14</sup> RX 9236}
16	The total number of received RTP packets	Stats{S 54 RTCP 54 RX 9236 <sup>15</sup> }
17	The codec used for the session	g723
18	The codec packet size, in bytes	62B
19	The encryption method	encryptionOff
20	The received silence suppression method	SSup disabled <sup>19</sup> /disabled
21	The transmitted silence suppression method	SSup disabled/disabled <sup>20</sup>
22	The average of all codec loss values sampled during the session	Loss 0.1% <sup>21</sup> #1
23	The codec loss event counter	Loss 0.1% #1 <sup>22</sup>
24	The average of all codec round trip time values sampled during the session	RTT 570ms <sup>23</sup> #38
25	The codec round trip time event counter	RTT 570ms #38 <sup>24</sup>
26	The percentage contribution of jitter-buffer underruns to the average codec loss	Jbuf 0.1% <sup>25</sup> /0.0%
27	The percentage contribution of jitter-buffer overruns to the average codec loss	Jbuf 0.1%/0.0% <sup>26</sup>
28	The average of all network RTP packet loss values sampled during the session	Loss 0.0% <sup>27</sup> #0
29	The network RTP packet loss event counter	Loss 0.0% #0 <sup>28</sup>
30	The average of all network RTT values during the session	RTT 376ms <sup>29</sup> #38
31	The network RTT event counter	RTT 376ms #38 <sup>30</sup>
32	The network jitter at the RTP receiver	Jtr #0
33	The minimum and maximum TTL values sampled in the session	TTL 63-63
34	A counter that increments each time two consecutive RTP packets with the same RTP sequence number are received	Dup 0

3 of 4

**Table 103: QoS Trap output fields (continued)**

Label	Description	From the trap example
35	A counter that increments each time an RTP packet with a sequence number less than the last known sequence is received	Fail 0
36	The average network loss experienced by the remote RTP receiver	Rem{Loss 0.0% <sup>36</sup> #0 Jtr #0}
37	A counter that increments each time the remote loss is sampled over its threshold	Rem{Loss 0.0% #0 <sup>37</sup> Jtr #0}
38	A counter that increments each time the network jitter experienced by the remote RTP receiver is sampled over its threshold	Rem{Loss 0.0% #0 Jtr #0 <sup>38</sup> }
39	The echo cancellation loss on the TDM bus. A high value (that is, a low absolute value) may indicate impairment of DCP terminals.	EC{Loss 45dB}

**4 of 4**

## Analyzing QoS fault and clear trap output

The following is an example of the syslog message for the QoS fault and clear traps sent during RTP session 35, which terminated at 11:13:40 on October 20:

```

Oct 201 11:10:542 LZ-SIT-SR1 snmptrapd[9407]: 135.8.118.252
[135.8.118.252]: TrapsysUpTime.0 = Timeticks: (43131114) 4 days,
23:48:31.143, snmpTrapOID.0 = OID: avRtpQoSFault4, avRtpQoSFaultTh.0 =
INTEGER: 15, avRtpQoSClearTh.0 = INTEGER: 06

Oct 201 11:13:402 LZ-SIT-SR1 snmptrapd[9407]: 135.8.118.252
[135.8.118.252]: TrapsysUpTime.0 = Timeticks: (43147723) 4 days,
23:51:17.233, snmpTrapOID.0 = OID: avRtpQoSClear4, avRtpQoSFaultTh.0 =
INTEGER: 15, avRtpQoSClearTh.0 = INTEGER: 06
    
```

[Table 104](#) describes the fields in the QoS fault and clear traps according to the numbered labels on the example above.

**Table 104: QoS fault and clear trap output fields**

Label	Description	From the QoS fault trap example	From the QoS clear trap example
1	The date on which the trap was received	Oct 20	Oct 20
2	The time at which the trap was received	11:10:54	11:13:40
3	The gateway uptime	sysUpTime.0 = Timeticks: (43131114) 4 days, 23:48:31.14	sysUpTime.0 = Timeticks: (43147723) 4 days, 23:51:17.23
4	The trap name. Indicates that this is a QoS fault trap or a QoS clear trap.	snmpTrapOID.0 = OID: avRtpQoSFault	snmpTrapOID.0 = OID: avRtpQoSClear
5	The QoS fault trap boundary. That is, the number of active sessions with QoS faults that causes a QoS fault trap to be sent.	avRtpQoSFaultTh.0 = INTEGER: 1	avRtpQoSFaultTh.0 = INTEGER: 1
6	The QoS clear trap boundary. That is, the reduced number of active sessions with QoS faults that causes a QoS clear trap to be sent after a QoS fault trap was sent.	avRtpQoSClearTh.0 = INTEGER: 0	avRtpQoSClearTh.0 = INTEGER: 0

## Viewing automatic traceroute results

The VoIP engine automatically performs UDP traceroutes whenever the RTP statistics application is enabled.

A traceroute is performed per RTP session, 10 seconds after the session begins. A traceroute is not performed if there is another active session to the same destination for which a traceroute was already performed within the last five seconds.

- Use the **show rtp-stat traceroute** command. You can filter the results according to subnet address by adding **destination-ip** and specifying the remote subnet address and subnet mask, or by specifying the rtp-statistics session index. For example:

```
G450-001(super)# show rtp-stat traceroute destination-ip 10.2.5.0 255.255.255.0
Session ID: 1234
From: 123.21.11.5, To: 10.2.4.15, At: 2004-12-26,12:21:55
TTL HOP ADDRESS          DELAY
-----
 1 123.21.11.1             2ms
 2 212.201.233.102        65ms
 3 213.21.51.12           110ms
 4 10.2.4.15              175ms

Session ID: 1234
From: 123.21.11.5, To: 10.2.4.5, At: 2004-12-26,13:30:15
```

**Note:**

The traceroute results are displayed in reverse order (most recent first).

**Table 105: RTP traceroute results output**

Field	Description
Session ID	The RTP statistics index for the RTP session
From	The IP address of the G450
To	The IP address of the session destination (in this case, a destination within the specified subnet)
At	The time the traceroute is performed
TTL	The hop count and TTL field value of probe packets
HOP ADDRESS	The hop IP address
DELAY	The round trip time per probe packet. Three probe packets are sent per hop address, and the displayed value is the average of the three round-trip times. An asterisk (*) indicates that the probe packet timed out.

---

## RTP statistics examples

This section includes an example of configuring the RTP statistics application for a sample network. In addition, there are some example calls between various types of phones.

### Configuring the RTP statistics application for a sample network

[Figure 33](#) shows the locations of four telephone extensions in an example network. Telephones with extensions 2004 and 2111 are connected to the local gateway G450-001. Extensions 2002 and 2101 are connected to the remote gateway G450-002.

---

**Figure 33: Four telephones in a sample network**

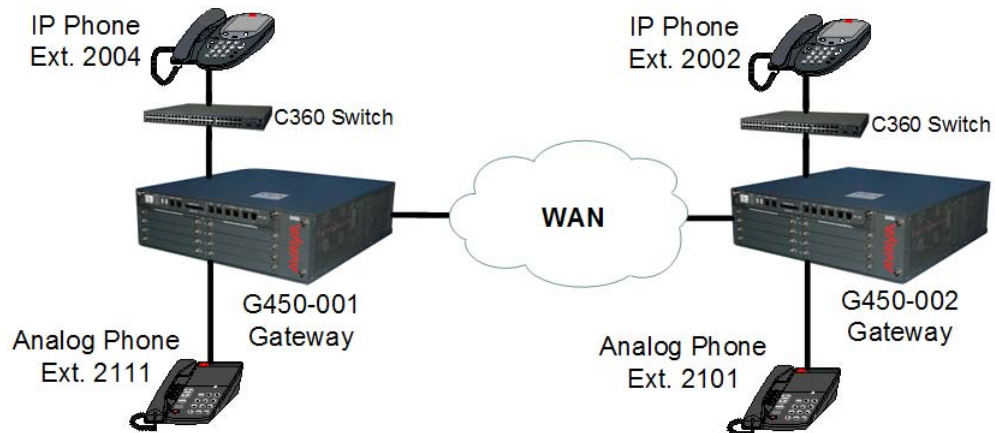

## Configuring monitoring applications

At the site of the local gateway "G450-001", the administrator enabled and configured the RTP-MIB application as follows:

```
//to enable the RTP statistics application:

G450-001(super)# rtp-stat-service

//to view the configuration of the application:

G450-001(super)# show rtp-stat config

RTP Statistic: Enabled
QoS Trap: Disabled
QoS Fault Trap: Disabled
  Fault: 0
  Clear: 0
QoS Trap Rate Limiter:
  Token Interval: 10.00 seconds
  Bucket Size: 5
Session Table:
  Size: 128
  Reserved: 64
Min Stat Win: 1

//to view the thresholds:

G450-001(super)# show rtp-stat thresholds
```

Item	Threshold	Event Threshold
Codec Loss	0.0%	1
Average Codec Loss	1.0%	N/A
Codec RTT	5 mS	1
Echo Return Loss	1 dB	1
Loss	1.0%	1
Average Loss	1.0%	N/A
Remote Loss	1.0%	1
Average Remote Loss	1.0%	N/A
RTT	13mS	1
Local Jitter	1mS	1
Remote Jitter	1mS	1
SSRC Changes	N/A	1



```
//to change the thresholds appropriately for the network:

G450-001(super)# rtp-stat thresholds codec-loss 6.0
G450-001(super)# rtp-stat thresholds average-codec-loss 0.0
G450-001(super)# rtp-stat thresholds codec-rtt 700
G450-001(super)# rtp-stat thresholds echo-return-loss 5
G450-001(super)# rtp-stat thresholds loss 6.0
G450-001(super)# rtp-stat thresholds remote-loss 6.0
G450-001(super)# rtp-stat thresholds average-loss 0.0
G450-001(super)# rtp-stat thresholds average-remote-loss 0.0
G450-001(super)# rtp-stat thresholds jitter 70
G450-001(super)# rtp-stat thresholds remote-jitter 70
G450-001(super)# rtp-stat thresholds rtt 500
G450-001(super)# rtp-stat event-threshold echo-return-loss 0
G450-001(super)# rtp-stat event-threshold loss 1
G450-001(super)# rtp-stat event-threshold remote-loss 0
G450-001(super)# rtp-stat event-threshold jitter 0
G450-001(super)# rtp-stat event-threshold remote-jitter 0
G450-001(super)# rtp-stat event-threshold rtt 0
G450-001(super)# rtp-stat event-threshold ssrc-change 0

//to review the threshold configuration again:

G450-001(super)# show rtp-stat thresholds
```

Item	Threshold	Event Threshold
-----	-----	-----
Codec Loss	6.0%	1
Average Codec Loss	0.0%	N/A
Codec RTT	700mS	1
Echo Return Loss	5dB	0
Loss	6.0%	0
Average Loss	0.0%	N/A
Remote Loss	6.0%	0
Average Remote Loss	0.0%	N/A
RTT	500mS	0
Local Jitter	70mS	0
Remote Jitter	70mS	0
SSRC Changes	N/A	0

```
//to configure the minimum statistics window for evaluating packet loss:
G450-001(super)# rtp-stat min-stat-win 50

//to configure an external trap manager as a trap destination in addition to the
active MGC:
G450-001(super)# snmp-server host 136.9.71.47 traps v1 public
```

## Configuring monitoring applications

```
//to check SNMP configuration
G450-001(super)# show snmp
Authentication trap enabled
Community-Access Community-String
-----
read-only *****
read-write *****
SNMPv3 Notifications Status
-----
Traps: Enabled
Informs: Enabled Retries: 3 Timeout: 3 seconds
SNMP-Rec-Address Model Level Notification Trap/Inform User name
-----
135.9.77.47 v1 noauth all trap ReadCommN UDP port: 162 DM
136.9.71.47 v1 noauth all trap WriteCommN
UDP port: 162

//to enable the sending of QoS traps:
G450-001(super)# rtp-stat qos-trap
//to enable and configure the sending of fault and clear traps:
G450-001(super)# rtp-stat fault 2 0

//to view RTP statistics configuration again:
G450-001(super)# show rtp-stat config

RTP Statistic: Enabled
QoS Trap: Enabled
QoS Fault Trap: Enabled
    Fault: 2
    Clear: 0
QoS Trap Rate Limiter:
    Token Interval: 10.00 seconds
    Bucket Size: 5
Session Table:
    Size: 128
    Reserved: 64
Min Stat Win: 50
```

## A call over the WAN from an analog phone to an IP phone

At 00:39 on December 7, 2004, a call is placed from analog extension 2111 to IP phone extension 2002 (see [Figure 34](#)) in the network described in [Configuring the RTP statistics application for a sample network](#) on page 399.

---

**Figure 34: Remote call from analog to IP phone**

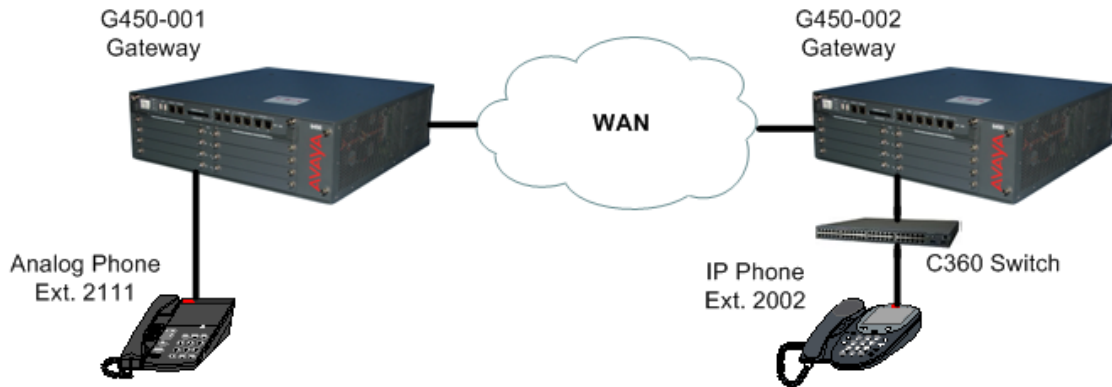

## Configuring monitoring applications

The RTP statistics application is configured as described in [Configuring the RTP statistics application for a sample network](#) on page 399. The callers complain after the call that there were QoS problems during the call. The administrator investigates as follows:

```
//to see if the RTP statistics application registered QoS problems for the call:

G450-001(super)# show rtp sessions

ID      QoS Start date and time End Time Type      Destination
-----
00001   *1 2004-12-07,00:39:26 00:41:01 G711U      20.20.20.2

//to display more details on the session:

G450-001(super)# show rtp-stat detailed 1

Session-ID: 1
Status: Terminated, QOS: Faulted2, EngineId: 0
Start-Time: 2004-12-07,00:39:26, End-Time: 2004-12-07,00:41:01
Duration: 00:01:35
CName: gwp@30.30.30.1
Phone: 199:2111
Local-Address: 30.30.30.1:2329 SSRC 2764463979
Remote-Address: 20.20.20.2:2329 SSRC 1260226 (0)
Samples: 19 (5 sec)

Codec:
G711U 200B 20mS Off, Silence-suppression(Tx/Rx) Disabled/Disabled, Play-Time 63.
916sec, Loss 11.0% #153, Avg-Loss 8.6%, RTT 201mS #0, Avg-RTT 210mS, JBuf-under/ov
verruns 9.4%/0.0%, Jbuf-Delay 2mS, Max-Jbuf-Delay 35mS

Received-RTP:
Packets 3225, Loss 0.0% #94, Avg-Loss 8.4%, RTT 124mS #0, Avg-RTT 96mS, Jitter 11
mS #0, Avg-Jitter 9mS, TTL(last/min/max) 63/63/63, Duplicates 0, Seq-Fall 0, DSC
P 46, L2Pri 12, RTCP 9

Transmitted-RTP:
VLAN 1, DSCP 46, L2Pri 6, RTCP 17

Remote-Statistics:
Loss 11.6% #145, Avg-Loss 8.9%, Jitter 33mS #0, Avg-Jitter 26mS

Echo-Cancellation:
Loss 49dB #0, Len 32mS

RSVP:
Status Disabled, Failures 0
```

A few points to note:

- The asterisk in the `show rtp sessions` output indicates that session 1 has QoS faults [1]
- The QoS is described as Faulted because there were QoS faults [2]
- QoS faults that can be seen in the output are:
  - The codec loss event counter indicates that codec loss went over its threshold 15 times [3]
  - The received-RTP packet loss event counter indicates that packet loss went over its threshold nine times [4]
  - The remote packet loss event counter indicates that remote packet loss went over its threshold 14 times [5]

## A local call between an IP and an analog phone

A local call is placed at 00:57 between IP phone extension 2004 and analog phone extension 2111 (see [Figure 35](#)) in the network described in [Configuring the RTP statistics application for a sample network](#) on page 399. The call is finished at 00:59:19.

---

**Figure 35: Local call from analog to IP phone**

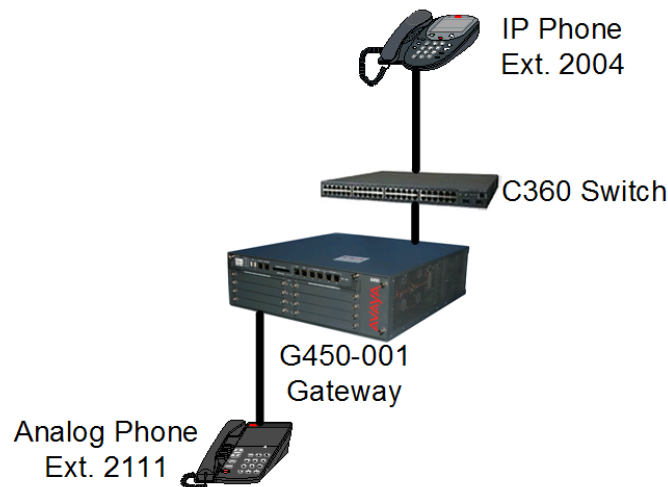

## Configuring monitoring applications

After the call is ended, the administrator uses the CLI to view the QoS statistics:

```
//to see if there were QoS problems registered during the session

G450-001(super)# show rtp sessions last 1

ID      QoS1 Start date and time End Time  Type      Destination
-----
00001   2004-12-07,00:57:13 00:59:19 G711U     30.30.30.2
//To display details of the session:

G450-001(super)# show rtp-stat detailed 1

Session-ID: 1
Status: Terminated, QOS: Ok2, EngineId: 0
Start-Time: 2004-12-07,00:57:13, End-Time: 2004-12-07,00:59:19
Duration: 00:02:06
CName: gwp@30.30.30.1
Phone: 200:2111
Local-Address: 30.30.30.1:2165 SSRC 2533871380
Remote-Address: 30.30.30.2:2165 SSRC 93269 (0) ip phone or another medi proc
Samples: 25 (5 sec)

Codec:
G711U 200B 20mS Off, Silence-suppression(Tx/Rx) Disabled/Disabled, Play-Time 130
.080sec, Loss 0.0% #03, Avg-Loss 0.0%4, RTT 83mS #05, Avg-RTT 108mS6,
JBuf-under/overruns 0.0%/0.0%, Jbuf-Delay 5mS, Max-Jbuf-Delay 27mS

Received-RTP:
Packets 6503, Loss 0.0% #07, Avg-Loss 0.0%8, RTT 0mS #09, Avg-RTT 0mS10, Jitter 0mS
#011, Avg-Jitter 0mS12, TTL(last/min/max) 64/64/64, Duplicates 0, Seq-Fall 0, DSCP
46, L2Pri 12, RTCP 26

Transmitted-RTP:
VLAN 1, DSCP 46, L2Pri 6, RTCP 31

Remote-Statistics:
Loss 0.0% #013, Avg-Loss 0.0%14, Jitter 10mS #015, Avg-Jitter 10mS16

Echo-Cancellation:
Loss 49dB #017, Len 32mS

RSVP:
Status Disabled, Failures 0
```

A few points to note:

- The QoS column in the **show rtp sessions** output has no asterisk (\*), showing that no metrics went over their event thresholds or average thresholds during the session [1]
- The QoS is described as “Ok” because there were no QoS problems [2]
- All average metric values are below the average thresholds [4] [5] [6] [8] [10] [12] [14] [16]
- All event counters are zero [3] [5] [7] [9] [11] [13] [15] [17]

## A remote call over the WAN from an IP phone to an IP phone

An unshuffled call is placed from IP phone extension 2004 to IP phone extension 2002 (Figure 36) in the network described in [Configuring the RTP statistics application for a sample network](#) on page 399.

**Figure 36: Remote call from IP phone to IP phone**

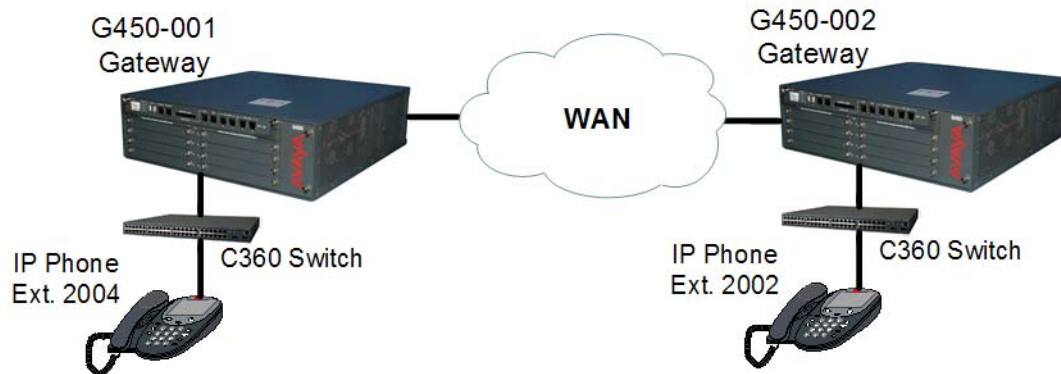

After the call is ended, the following commands are run:

```
//to display the RTP sessions:
```

```
G450-001(super)# show rtp sessions
```

ID	QoS	Start date and time	End Time	Type	Destination
00011		2004-12-07,00:57:13	00:59:19	G711U	30.30.30.2
00012	*	2004-12-07,00:39:26	00:41:01	G711U	20.20.20.2
<b>00013</b>	<b>*</b>	<b>2004-12-07,01:02:45</b>	<b>01:05:15</b>	<b>G711U</b>	<b>20.20.20.2</b>
<b>00014</b>		<b>2004-12-07,01:02:50</b>	<b>01:05:15</b>	<b>G711U</b>	<b>30.30.30.2</b>

Sessions 13 and 14 both belong to the call, since two VoIP channels are used by an unshuffled call between two IP phones: one channel between each telephone and the G450 VoIP engine.

## Configuring monitoring applications

Session 13 has QoS problems.

```
//to display details of session 13:
G450-001(super)# show rtp-stat detailed 13

Session-ID: 13
Status: Terminated, QOS: Faulted, EngineId: 0
Start-Time: 2004-12-07,01:02:45, End-Time: 2004-12-07,01:05:15
Duration: 00:02:30
CName: gwp@30.30.30.1
Phone: 202:2004
Local-Address: 30.30.30.1:2329 SSRC 3510756141
Remote-Address: 20.20.20.2:2329 SSRC 1372162 (0)
Samples: 30 (5 sec)

Codec:
G711U 200B 20mS Off, Silence-suppression(Tx/Rx) Disabled/Disabled, Play-Time 144
.540sec, Loss 0.0% #17, Avg-Loss 6.9%, RTT 99mS #0, Avg-RTT 208mS, JBuf-under/ov
erruns 7.4%/0.0%, Jbuf-Delay 9mS, Max-Jbuf-Delay 73mS

Received-RTP:
Packets 7279, Loss 0.0% #17 , Avg-Loss 6.8%, RTT 8mS #0, Avg-RTT 68mS, Jitter 0mS
#0, Avg-Jitter 6mS, TTL(last/min/max) 63/63/63, Duplicates 0, Seq-Fall 0, DSCP
46, L2Pri 12, RTCP 23

Transmitted-RTP:
VLAN 1, DSCP 46, L2Pri 6, RTCP 27

Remote-Statistics:
Loss 0.4% #17 , Avg-Loss 6.5%, Jitter 3mS #0, Avg-Jitter 22mS

Echo-Cancellation:
Loss 49dB #0, Len 32mS

RSVP:
Status Disabled, Failures 0
```



Session 14 is free of QoS problems:

```
//to display details of session 14:
G450-001(super)# show rtp-stat detailed 14

Session-ID: 14
Status: Terminated, QOS: Ok, EngineId: 0
Start-Time: 2004-12-07,01:02:50, End-Time: 2004-12-07,01:05:15
Duration: 00:02:25
CName: gwp@30.30.30.1
Phone: 202:2002
Local-Address: 30.30.30.1:2165 SSRC 247950253
Remote-Address: 30.30.30.2:2165 SSRC 120077 (0)
Samples: 29 (5 sec)

Codec:
G711U 200B 20mS Off, Silence-suppression(Tx/Rx) Disabled/Disabled, Play-Time 151
.140sec, Loss 0.0% #0, Avg-Loss 0.0%, RTT 95mS #0, Avg-RTT 106mS, JBuf-under/ove
rruns 0.0%/0.0%, Jbuf-Delay 11mS, Max-Jbuf-Delay 27mS

Received-RTP:
Packets 7556, Loss 0.0% #0, Avg-Loss 0.0%, RTT 0mS #0, Avg-RTT 0mS, Jitter 0mS #
0, Avg-Jitter 0mS, TTL(last/min/max) 64/64/64, Duplicates 0, Seq-Fall 0, DSCP 46
, L2Pri 12, RTCP 31

Transmitted-RTP:
VLAN 1, DSCP 46, L2Pri 6, RTCP 25
--type q to quit or space key to continue--

Remote-Statistics:
Loss 0.0% #0, Avg-Loss 0.0%, Jitter 7mS #0, Avg-Jitter 7mS

Echo-Cancellation:
Loss 49dB #0, Len 32mS

RSVP:
Status Disabled, Failures 0
```

## A conference call

A conference call is placed between IP phone extension 1003, analog phone extension 80900, and IP phone extension 80886. The call is established by calling from extension 1003 to extension 80900, and then using the conference function on extension 1003 to add 80886 (see [Figure 37](#)).

**Figure 37: A conference call**

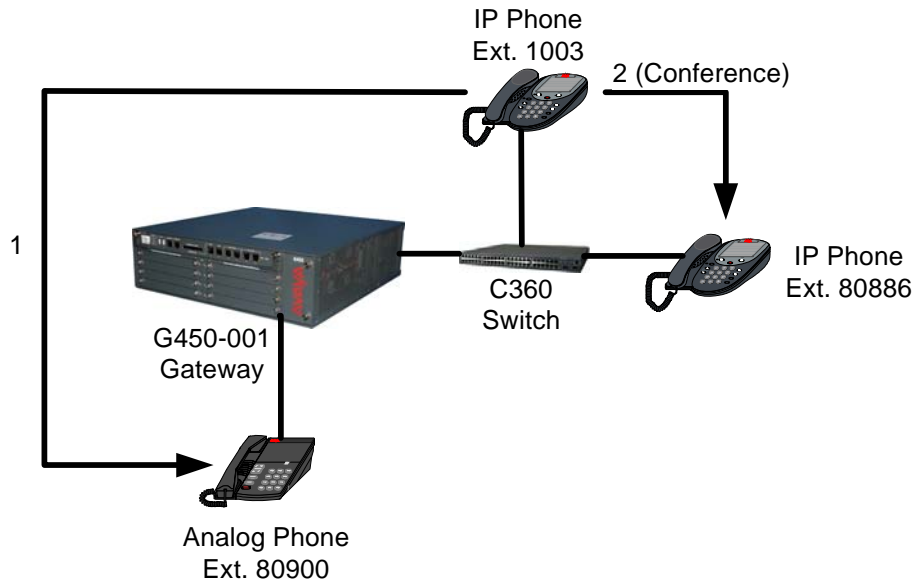

During the call, the following commands are run:

```
//to display the RTP sessions:  
G450-001(super)# show rtp sessions
```

ID	QoS	Start date and time	End Time	Type	Destination
00001		2004-12-23,09:55:17	-		G729 16.16.16.101
00002		2004-12-23,09:55:20	-		G711U 149.49.41.50

```
//to display details of session 1:
GG450-001(super)# show rtp detailed 1

Session-ID: 1
Status: Active, QOS: Ok, EngineId: 0
Start-Time: 2004-12-23,09:55:17, End-Time: -
Duration: 00:00:48
CName: gwp@33.33.33.33
Phone: 1401:80900:1003
Local-Address: 33.33.33.33:61999 SSRC 3585271811
Remote-Address: 16.16.16.101:61999 SSRC 1369159108 (0)
Samples: 9 (5 sec)

Codec:
G729 40B 0mS Off, Silence-suppression(Tx/Rx) No-RTP/No-RTP, Play-Time 4.760sec,
Loss 0.0% #0, Avg-Loss 0.8%, RTT 137mS #0, Avg-RTT 141mS, JBuf-under/overruns 0.
8%/0.0%, Jbuf-Delay 20mS, Max-Jbuf-Delay 30mS

Received-RTP:
Packets 238, Loss 0.0% #0, Avg-Loss 0.0%, RTT 24mS #0, Avg-RTT 21mS, Jitter 0mS
#0, Avg-Jitter 0mS, TTL(last/min/max) 0/61/61, Duplicates 0, Seq-Fall 0, DSCP 0,
L2Pri 6, RTCP 26

Transmitted-RTP:
VLAN 400, DSCP 46, L2Pri 6, RTCP 34

Remote-Statistics:
Loss 0.0% #0, Avg-Loss 0.0%, Jitter 2mS #0, Avg-Jitter 1mS

Echo-Cancellation:
Loss 49dB #0, Len 0mS

RSVP:
Status Reserved, Failures 0

//to display details of session 2:

G450-001(super)# show rtp detailed 2

Session-ID: 2
Status: Active, QOS: Ok, EngineId: 0
Start-Time: 2004-12-23,09:55:20, End-Time: -
Duration: 00:00:50
CName: gwp@33.33.33.33
Phone: 1402:80886:1003
Local-Address: 33.33.33.33:61175 SSRC 3702564610
Remote-Address: 149.49.41.50:61175 SSRC 15161893 (0)
Samples: 10 (5 sec)
```

## Configuring monitoring applications

```
Codec:
G711U 40B 0mS Off, Silence-suppression(Tx/Rx) Disabled/Disabled, Play-Time 161.9
00sec, Loss 0.0% #0, Avg-Loss 0.0%, RTT 103mS #0, Avg-RTT 105mS, JBuf-under/over
runs 0.0%/0.0%, Jbuf-Delay 11mS, Max-Jbuf-Delay 13mS

Received-RTP:
Packets 8094, Loss 0.0% #0, Avg-Loss 0.0%, RTT 8mS #0, Avg-RTT 9mS, Jitter 0mS #
0, Avg-Jitter 0mS, TTL(last/min/max) 0/64/64, Duplicates 0, Seq-Fall 0, DSCP 0,
L2Pri 6, RTCP 30

Transmitted-RTP:
VLAN 400, DSCP 46, L2Pri 6, RTCP 30

Remote-Statistics:
Loss 0.0% #0, Avg-Loss 0.0%, Jitter 1mS #0, Avg-Jitter 0mS

Echo-Cancellation:
Loss 49dB #0, Len 0mS

RSVP:
Status Reserved, Failures 0
```

The conference ID that appears in the Phone string for session 1 and for session 2 is identical, which identifies the two sessions as belonging to the same conference call [1] [2].

---

## Summary of RTP statistics commands

For more information about these commands, see *Avaya G450 CLI Reference*, 03-300437.

**Table 106: RTP statistics application CLI commands**

Command	Description
<b>rtp-stat clear</b>	Reset the RTP statistics application
<b>rtp-stat event-threshold</b>	Set a QoS event-threshold for RTP streams
<b>rtp-stat fault</b>	Configure the RTP statistics application to send QoS fault and/or clear traps
<b>rtp-stat min-stat-win</b>	Set the RTP statistics minimum statistic window
<b>rtp-stat qos-trap</b>	Configure the RTP statistics application to automatically send a QoS trap upon the termination of an RTP stream in which one or more QoS event counters exceeded their configured threshold

**1 of 2**

Table 106: RTP statistics application CLI commands (continued)

Command	Description
<code>rtp-stat qos-trap-rate-limit</code>	Configure the QoS trap rate limiter
<code>rtp-stat-service</code>	Enable the RTP statistics application
<code>rtp-stat thresholds</code>	Set thresholds for the RTP statistics applications
<code>show rtp-stat config</code>	Display the RTP statistics application configuration
<code>show rtp-stat detailed</code>	Display a detailed QoS log for a specific RTP session
<code>show rtp-stat sessions</code>	Display RTP sessions QoS statistics
<code>show rtp-stat summary</code>	Display a summary of the RTP statistics
<code>show rtp-stat thresholds</code>	Display the configured RTP statistic thresholds
<code>show rtp-stat traceroute</code>	Display the results of UDP traceroutes issued by the media gateway VoIP engine per active RTP session
<b>2 of 2</b>	

---

## Configuring and analyzing packet sniffing

The G450 packet sniffing service allows you to analyze packets that pass through the G450's interfaces. Packets are captured to a buffer based on criteria that you specify. The buffer is then uploaded via FTP to a file that can be analyzed using the Ethereal analysis tool.

The packet sniffing service on the G450 offers several advantages to the network administrator. Since the capture file is saved in the libpcap format, which is the industry standard, it is readable both by the S8300's Tethereal software, and by standard versions of Ethereal for Unix, Windows, and Linux (see <http://www.ethereal.com>).

**Note:**

Ethereal is an open source application.

In addition, the G450's packet sniffing service is capable of capturing non-Ethernet packets, such as frame-relay and PPP. Non-Ethernet packets are wrapped in a dummy Ethernet header to allow them to be viewed in a libpcap format. Thus, the G450 allows you to analyze packets on all the interfaces of the device.

## Configuring monitoring applications

The G450's packet sniffing service gives you full control over the memory usage of the sniffer. You can set a maximum limit for the capture buffer size, configure a circular buffer so that older information is overwritten when the buffer fills up, and specify a maximum number of bytes to capture for each packet.

---

## What can be captured

The G450 packet sniffing service captures only the packets handled by the G450 and delivered to the device CPU ("non-promiscuous" mode). This is unlike regular sniffer applications that pick up all traffic on the network.

See [Configuring packet sniffing](#) on page 415 for a description of how to configure packet sniffing and analyze the resulting capture file.

## Streams that can always be captured

- H.248 registration
- RTP from the G450
- ARP on the LAN (broadcast)
- All packets that traverse the WAN
- All traffic to/from the G450

## Streams that can never be captured

The following streams can never be captured because they are switched by the internal Ethernet switch and not by the CPU:

- H.323 Signaling from an IP phone on the LAN to an ICC on the LAN
- RTP stream between IP phones on the LAN

## Streams that can sometimes be captured

If the G450 is the WAN router of the following streams, they can be captured:

- H.323 Signaling from IP phones on the LAN to an ECC over the WAN
- DHCP when the DHCP server is behind the WAN (using the G450 DHCP relay capability)
- RTP stream on an IP phone on the LAN to a remote IP phone

---

## Configuring packet sniffing

Packet sniffing configuration consists of the following steps:

1. [Enabling packet sniffing](#).
2. [Limiting packet sniffing to specific interfaces](#) (if necessary).
3. [Creating a capture list](#) that specifies which packets to capture.
4. [Defining rule criteria for a capture list](#).
5. [Viewing the capture list](#).
6. [Applying a capture list](#).
7. [Configuring packet sniffing settings](#).
8. [Starting the packet sniffing service](#).

### Enabling packet sniffing

Since the packet sniffing service presents a potential security breach, the administrator must first enable the service on the G450 before a user can start capturing packets. Enter **capture-service** to enable the packet sniffing service.

**Note:**

The packet sniffing service can only be enabled by an administrator connecting with a serial cable to the G450 Console port or Services port.

To disable packet sniffing, enter **no capture-service**.

### Limiting packet sniffing to specific interfaces

By default, the packet sniffing service captures packets and Ethernet frames from all the router's interfaces. You can use the **capture interface** command to limit packet sniffing to a specific interface.

For example, the following command limits packet sniffing to the FastEthernet Interface:

```
G450-001(super)# capture interface fastethernet 10/2
Done!
G450-001(super)#
```

The following command enables packet sniffing on all available interfaces:

```
G450-001(super)# capture interface any
Done!
G450-001(super)#
```

### Creating a capture list

By default, the packet sniffing service captures all packets passing through the interfaces on which it is enabled. Use a capture list to selectively filter the packets that are captured by the service.

A capture list contains an ordered list of rules and actions. A rule specifies criteria against which packets are tested. The action tells the G450 whether to capture or not capture packets matching the rule criteria. Only packets that match the specified criteria and have an action of **capture** are captured to the capture file. The rules are evaluated one by one, according to their number. If none of the rules match the packet, the default action is executed. You can set the default action as desired. Use the command **ip-rule default** to set the default action.

**Note:**

ARP frames are not IP packets and therefore cannot be filtered by capture lists. However, in a healthy network, the ARP frames rate is relatively low.

Use the **ip capture-list** command, followed by the list number, to enter the context of a capture list (and to create the capture list if it does not exist). Capture lists are numbered from 500 to 599. For example:

```
G450-001(super)# ip capture-list 510
G450-001(super-Capture 510)#
```

You can use the following commands to set the parameters of the capture list:

- Use the **name** command to assign a name to the capture list.
- Use the **owner** command to record the name of the person that created the list.
- Use the **ip-rule** command to define rule criteria for the capture list. The following section explains rule criteria in detail.

**Note:**

You can use the **cookie** command to set the list cookie for the capture list. However, capture list cookies are not currently used by any application.

### Defining rule criteria for a capture list

Once in the capture list context, use the **ip-rule** command, followed by a number from 1 to 9999, to define a set of criteria against which to test packets. In addition to the rule criteria, each rule must include a composite operation. The composite operation determines the action the rule takes with respect to packets that match the rule criteria, and can be one of the following:

- capture
- no-capture



Use the **composite-operation** command to include a composite operation in a rule for a capture list. For example, the following commands create a rule (rule 10 in capture list 510) that determines that TCP packets are not captured:

```
G450-001(super)# ip capture-list 510
G450-001(super-Capture 510)# ip-rule 10
G450-001(super-Capture 510/ip rule 10)# composite-operation no-capture
Done!
G450-001(super-Capture 510/ip rule 10)# ip-protocol tcp
Done!
G450-001(super-Capture 510/ip rule 10)# composite-operation no-capture
Done!
G450-001(super-Capture 510/ip rule 10)# ip-protocol tcp
Done!
G450-001(super-Capture 510/ip rule 10)#
```

## Rule applications

Rules work in the following ways, depending on the type of information in the packet, and the number of criteria in the rule:

- L4 rules with a *Permit* operation are applied to non-initial fragments
- L4 rules with a *Deny* operation are not applied to non-initial fragments, and the device continues checking the next IP rule. This is to prevent cases in which fragments that belong to other L4 sessions may be blocked by the other L4 session which is blocked.
- L3 rules apply to non-initial fragments
- L3 rules that include the fragment criteria do not apply to initial fragments or non-fragment packets
- L3 rules that do not include the fragment criteria apply to initial fragments and non-fragment packets
- L4 rules apply to initial fragments and non-fragment packets

## Rule criteria commands

You can use the following rule criteria commands. These commands are described in more detail below.

- **dscp**
- **ip protocol**
- **source ip address**
- **destination ip address**
- **tcp source-port**
- **tcp destination-port**
- **udp source-port**
- **udp destination-port**

## Configuring monitoring applications

- **icmp**
- **fragment**

### Note:

You can also use the **description** command in the rule context to add a description of the rule.

## DSCP

Use the **dscp** command, followed by a DSCP value (from 0 to 63) to apply the rule to all packets with the specified DSCP value. For example, the following rule is defined to capture all VoIP Bearer packets (DSCP = 46):

```
G450-001(super)# ip capture-list 520
G450-001(super-Capture 520)# ip-rule 20
G450-001(super-Capture 520/ip rule 20)# composite-operation capture
Done!
G450-001(super-Capture 520/ip rule 20)# dscp 46
Done!
G450-001(super-Capture 520/ip rule 20)#
```

## IP protocol

Use the **ip-protocol** command, followed by the name of an IP protocol, to apply the rule to all packets with the specified IP protocol. If you want the rule to apply to all protocols, use **any** after the command (**ip-protocol any**).

For example, the following rule is defined to capture all TCP packets:

```
G450-001(super)# ip capture-list 520
G450-001(super-Capture 520)# ip-rule 20
G450-001(super-Capture 520/ip rule 20)# composite-operation capture
Done!
G450-001(super-Capture 520/ip rule 20)# ip-protocol tcp
Done!
G450-001(super-Capture 520/ip rule 20)#
```

To apply the rule to all protocols except the specified protocol, use the **no** form of this command. For example:

```
G450-001(super-Capture 520/ip rule 20)# no ip-protocol tcp
Done!
G450-001(super-Capture 520/ip rule 20)#
```

## Source or destination IP address

Use the **source-ip** command to apply the rule to packets from the specified IP address or range of addresses. Use the **destination-ip** command to apply the rule to packets going to the specified IP address or range of addresses.

The IP range criteria can be any of the following:

- **Range.** Type two IP addresses to set a range of IP addresses to which the rule applies. You can use wildcards in setting the range. For example:

```
G450-001(super-Capture 520/ip rule 20)# source-ip 135.64.102.0 0.0.255.255
Done!
G450-001(super-Capture 520/ip rule 20)#
```

- **Single address.** Type **host**, by an IP address, to set a single IP address to which the rule applies. For example:

```
G450-001(super-Capture 520/ip rule 20)# destination-ip host 135.64.104.102
Done!
G450-001(super-Capture 520/ip rule 20)#
```

- **Wildcard.** Type **host**, followed by an IP address using wildcards, to set a range of IP addresses to which the rule applies. For example:

```
G450-001(super-Capture 520/ip rule 20)# source-ip host 135.0.0.0
Done!
G450-001(super-Capture 520/ip rule 20)#
```

- **Any.** Type **any** to apply the rule to all IP addresses. For example:

```
G450-001(super-Capture 520/ip rule 20)# destination-ip any
Done!
G450-001(super-Capture 520/ip rule 20)#
```

To apply the rule to all source or destination IP addresses except the specified address or range of addresses, use the **not** form of the applicable command. For example:

```
G450-001(super-Capture 520/ip rule 20)# not destination-ip 135.64.102.0 0.0.255.255
Done!
G450-001(super-Capture 520/ip rule 20)#
```

## Source and destination port range

To specify a range of source and destination ports to which the rule applies, use the following commands, followed by either port name or port number range criteria:

- **tcp source-port.** The rule applies to TCP packets from ports that match the defined criteria
- **tcp destination-port.** The rule applies to TCP packets to ports that match the defined criteria
- **udp source-port.** The rule applies to UDP packets from ports that match the defined criteria
- **udp destination-port.** The rule applies to UDP packets to ports that match the defined criteria

### Port name or number range criteria

The port name or number range criteria can be any of the following:

- **Range.** Type **range**, followed by two port numbers, to set a range of port numbers to which the rule applies. For example:

```
G450-001(super-Capture 520/ip rule 20)# tcp destination-port range 1 3
Done!
G450-001(super-Capture 520/ip rule 20)#
```

- **Equal.** Type **eq**, followed by a port name or number, to set a port name or port number to which the rule applies. For example:

```
G450-001(super-Capture 520/ip rule 20)# tcp source-port eq ftp
Done!
G450-001(super-Capture 520/ip rule 20)#
```

- **Greater than.** Type **gt**, followed by a port name or port number, to apply the rule to all ports with a name or number greater than the specified name or number. For example:

```
G450-001(super-Capture 520/ip rule 20)# udp destination-port gt 10
Done!
G450-001(super-Capture 520/ip rule 20)#
```

- **Less than.** Type **lt**, followed by a port name or port number, to apply the rule to all ports with a name or number less than the specified name or number. For example:

```
G450-001(super-Capture 520/ip rule 20)# udp source-port lt 10
Done!
G450-001(super-Capture 520/ip rule 20)#
```

- **Any.** Type **any** to apply the rule to all port names and port numbers. For example:

```
G450-001(super-Capture 520/ip rule 20)# tcp source-port any
Done!
G450-001(super-Capture 520/ip rule 20)#
```

To apply the rule to all protocols except the specified protocol, use the **not** form of the applicable command. For example:

```
G450-001(super-Capture 520/ip rule 20)# not udp source-port lt 10
Done!
G450-001(super-Capture 520/ip rule 20)#
```

## ICMP type and code

To apply the rule to a specific type of ICMP packet, use the **icmp** command. This command specifies an ICMP type and code to which the rule applies. You can specify the ICMP type and code by integer or text string. For example:

```
G450-001(super-Capture 520/ip rule 20)# icmp Echo-Reply
Done!
G450-001(super-Capture 520/ip rule 20)#
```

To apply the rule to all ICMP packets except the specified type and code, use the **not** form of this command. For example:

```
G450-001(super-Capture 520/ip rule 20)# not icmp 1 2
Done!
G450-001(super-Capture 520/ip rule 20)#
```

## Fragment

To apply the rule to non-initial fragments, enter **fragment**. You cannot use the **fragment** command in a rule that includes UDP or TCP source or destination ports.

## Configuring monitoring applications

### Capture list example

The following commands create a capture list that captures all traffic from subnet 135.122.50.149 255.255.255.254 to an ECC at address 135.122.50.171, except telnet:

```
G450-001(super)# ip capture-list 511
G450-001(super-Capture 511)# name "list #511"
Done!
! Rules 10 and 15 provide that telnet packets are not captured.
G450-001(super-Capture 511)# ip-rule 10
G450-001(super-Capture 511/ip rule 10)# composite-operation no-capture
Done!
G450-001(super-Capture 511/ip rule 10)# ip-protocol tcp
Done!
! You can use a port number instead of "telenet" (23).
G450-001(super-Capture 511/ip rule 10)# tcp destination-port eq telnet
Done!
G450-001(super-Capture 511/ip rule 10)# exit
G450-001(super-Capture 511)#
G450-001(super-Capture 511)# ip-rule 15
G450-001(super-Capture 511/ip rule 15)# composite-operation no-capture
Done!
G450-001(super-Capture 511/ip rule 15)# ip-protocol tcp
Done!
! You can use a port number instead of "telenet" (23).
G450-001(super-Capture 511/ip rule 15)# tcp source-port eq telnet
Done!
G450-001(super-Capture 511/ip rule 15)# exit
! Rule 20 provides for capturing any packet coming from the host IP address
! 135.122.50.171 and going to the subnet 135.122.50.128, including packets going
! to any of the 30 possible hosts in that subnet.
G450-001(super-Capture 511)# ip-rule 20
G450-001(super-Capture 511/ip rule 20)# ip-protocol tcp
Done!
G450-001(super-Capture 511/ip rule 20)# source-ip host 135.122.50.171
Done!
G450-001(super-Capture 511/ip rule 20)# destination-ip 135.122.50.128 0.0.0.31
Done!
G450-001(super-Capture 511/ip rule 20)# exit
! Rule 30 provides for capturing any packet coming from the subnet
! 135.122.50.128 and going to the host IP address 135.122.50.171, including
! packets from any of the 30 possible hosts in that subnet.
G450-001(super-Capture 511)# ip-rule 30
G450-001(super-Capture 511/ip rule 30)# source-ip 135.122.50.128 0.0.0.31
Done!
G450-001(super-Capture 511/ip rule 30)# destination-ip host 135.122.50.171
Done!
G450-001(super-Capture 511/ip rule 30)# exit
G450-001(super-Capture 511)# ip-rule default
G450-001(super-Capture 511/ip rule default)# composite-operation no-capture
Done!
G450-001(super-Capture 511/ip rule default)# exit
G450-001(super-Capture 511)# exit
G450-001(super)#
```

## Viewing the capture list

Use the **show ip capture-list** command to display the capture list in an easy-to-read format. For example:

```
G450-001# show ip capture-list 511
```

Index	Name					Owner
511	list #511					other
Index	Protocol DSCP	IP	Wildcard	Port	Operation	
10	tcp Any	Src Any Dst Any		Any eq Telnet	No-Capture	
15	tcp Any	Src Any Dst Any		eq Telnet Any	No-Capture	
20	tcp Any	Src 135.122.50.171 Dst 135.122.50.128	Host 0.0.0.31	Any Any	Capture	
30	Any Any	Src 135.122.50.128 Dst 135.122.50.171	Host	Any Any		
Deflt	Any Any	Src Any Dst Any		Any Any	No-Capture	
Index	Name					Trust
0	Capture					No
1	No-Capture					No

## Applying a capture list

To apply a capture list, use the **capture filter-group** command from the general context. For example, to set the G450 to use capture list 511 on interfaces in which packet sniffing is enabled, specify the following command:

```
G450-001(super)# capture filter-group 511
Done!
G450-001(super)#
```

If no capture list is applied, the packet sniffing service captures all packets.

## Configuring packet sniffing settings

The packet sniffing service provides several administrative settings you can use to control the capture functionality. Use the following commands to configure packet sniffing settings. These commands are all used from general context, and require read/write access.

- Use the **capture buffer-mode** command to specify the type of buffer to use. The available parameters are:
  - **cyclic**. Circular buffer that overwrites the oldest records when it is filled up. Use a cyclic buffer to store the most recent history of packet activity.
  - **non-cyclic**. Linear buffer that is used until it is filled up

For example:

```
G450-001(super)# capture buffer-mode cyclic
Done!
G450-001(super)#
```

- Use the **capture buffer-size** command to specify the maximum size of the capture buffer. Available values are 56 to 10000 kb. The default value is 1000. To activate the change in buffer size, you must enter **copy running-config startup-config**, and reboot the G450. For example:

```
G450-001(super)# capture buffer-size 2000
To change capture buffer size, copy the running
configuration to the start-up configuration file, and reset the device.
G450-001(super)# copy running-config startup-config
Beginning copy operation ..... Done!
G450-001(super)#
```

- Use the **capture max-frame-size** command to specify the maximum number of bytes captured for each packet. This is useful, since in most cases, the packet headers contain the relevant information. Available values are 14 to 4096. The default value is 128. For example:

```
G450-001(super)# capture max-frame-size 4000
This command will clear the capture buffer
- do you want to continue (Y/N)? y

Done!
G450-001(super)#
```

**Note:**

When you change the maximum frame size, the G450 clears the capture buffer.

- Enter **clear capture-buffer** to clear the capture buffer.



 **Tip:**

To reduce the size of the capture file, use any combination of the following methods:

- Use the **capture interface** command to capture only from a specific interface.
- Use the **capture max-frame-size** to capture only the first N octets of each frame. This is valuable since it is usually the packets headers that contain the interesting information.
- Use capture lists to select specific traffic.

## Starting the packet sniffing service

Once you have defined and applied the packet capture lists, use the **capture start** command in general context to instruct the packet sniffing service to start capturing packets.

**Note:**

The capture start command resets the buffer before starting the sniffer.

**Note:**

You must apply a capture list using the **capture filter-group** command in order for the capture list to be active. If you do not use the **capture filter-group** command, the packet sniffing service captures all packets.

If packet sniffing has been enabled by the administrator, the following appears:

```
G450-001(super)# capture start
Starting the packet sniffing process
G450-001(super)#
```

If packet sniffing has not been enabled by the administrator, the following appears:

```
G450-001(super)# capture start
Capture service is disable
To enable, use the `capture-service` command in supervisor mode.
G450-001(super)#
```

## Capturing decrypted IPsec VPN packets

IPsec VPN packets are encrypted packets. The contents of encrypted packets cannot be viewed when captured. However, you can use the **capture ipsec** command to specify that IPsec VPN packets, handled by the internal VPN gateway process, should be captured in plain text format.

### Analyzing captured packets

Analyze the captured packets by stopping the packet sniffing service, uploading the capture file, and analyzing the capture file.

### Stopping the packet sniffing service

Enter **capture stop** to stop the packet sniffing service. You must stop the service in order to upload a capture file.

**Note:**

The **capture stop** command is not saved in the startup configuration file.

### Viewing packet sniffing information

You can enter **show capture** to view information about the packet sniffing configuration and the capture state. For example:

```
G450-001> show capture

Capture service is enabled and inactive
Capture start time 19/06/2004-13:57:40
Capture stop time 19/06/2004-13:58:23
Current buffer size is 1024 KB
Buffer mode is cyclic
Maximum number of bytes captured from each frame: 1515
Capture list 527 on interface "FastEthernet 10/2"
Number of captured frames in file: 3596 (out of 3596 total captured frames)
Size of capture file: 266 KB (26.6 %)
```

**Note:**

The number of captured frames can be larger than the number of the frames in the buffer because the capture file may be in cyclic mode.

You can use the **show capture-buffer hex** command to view a hex dump of the captured packets. However, for a proper analysis of the captured packets, you should upload the capture file and analyze it using a sniffer application, as described in the following sections.

The following is an example of the `show capture-buffer hex` command:

```
G450-001> show capture-buffer hex
Frame number: 1
Time relative to first frame (D H:M:S:Micro-S): 0, 0:0:0.0
Packet time: 14/01/1970-13:24:55.583598
Frame length: 60 bytes
Capture Length: 60 bytes
00000000:ffff ffff ffff 0040 0da9 4201 0806 0001      .....@..B.....
00000010:0800 0604 0001 0040 0da9 4201 9531 4e7a      .....@..B..1Nz
00000020:0000 0000 0000 9531 4e7a 0000 0000 0000      .....1Nz.....
00000030:0000 0000 0000 0000 0000 0000      .....

Frame number: 2
Time relative to first frame (D H:M:S:Micro-S): 0, 0:0:0.76838
Packet time: 14/01/1970-13:24:55.660436
Frame length: 60 bytes
Capture Length: 60 bytes
00000000:ffff ffff ffff 0040 0d8a 5455 0806 0001      .....@..TU....
00000010:0800 0604 0001 0040 0d8a 5455 9531 4e6a      .....@..TU..1Nj
00000020:0000 0000 0000 9531 4e6a 0000 0000 0000      .....1Nj.....
00000030:0000 0000 0000 0000 0000 0000      .....
```

## Uploading the capture file

Once the packet sniffing service is stopped, upload the capture file to a server for viewing and analysis.

### Note:

The capture file may contain sensitive information, such as usernames and passwords of non-encrypted protocols. It is therefore advisable to upload the capture file over a secure channel – via VPN or using SCP (Secure Copy).

In most cases, you can upload the capture file to a remote server. However, in cases where the capture file is very large, or you encounter a WAN problem, you can upload the capture file to an S8300 Server and view it using Tethereal, which is a command-line version of Ethereal.

### Uploading the capture file to a remote server or USB mass storage device

- Use one of the following commands to upload the capture file:
  - `copy capture-file ftp`
  - `copy capture-file tftp`
  - `copy capture-file scp`
  - `copy capture-file usb`

**Note:**

The use of the `copy capture-file scp` command is limited to uploading files of 1 MB or less.

For example:

```
G450-001(super)# copy capture-file ftp myCature.cap 135.64.103.66
This command will stop the capture if capturing is started
Confirmation - do you want to continue (Y/N)? y

Username: xxxx
Password: xxxx
Beginning upload operation ...
This operation may take up to 20 seconds.
Please refrain from any other operation during this time.
For more information , use 'show upload status 10' command
G450-001(super)#
```

### Uploading the capture file to an S8300 Server

1. Telnet into the S8300 Server, for example by entering `session mgc`.
2. Open the Avaya Maintenance Web Interface. For instructions on accessing the Avaya Maintenance Web Interface, see *Installing and Upgrading the Avaya G450 Media Gateway*, 03-602054.
3. In the Avaya Maintenance Web Interface, select **FTP** under **Security** in the main menu.
4. Click **Start Server**.
5. Log into the G450.
6. Use the `copy capture file ftp` command to upload the capture file. Specify that the capture file should be placed in the `ftp /pub` subdirectory. For example:

```
G450-001(super)# copy capture-file ftp pub/capfile.cap 149.49.43.96
```

7. At the FTP login prompt, enter `anonymous`.
8. At the FTP password prompt, enter your e-mail address.

9. Optionally, enter **show upload status 10** to view upload status. For example:

```
G450-001(super)# show upload status 10
Module #10
=====
Module           : 10
Source file      : sniffer
Destination file : pub/capfile.cap
Host             : 149.49.43.96
Running state    : Executing
Failure display  : (null)
Last warning     : No-warning
```

## Analyzing the capture file

The uploaded capture file is in libpcap format and can therefore be viewed by most sniffer applications, including tcpdump, Ethereal and Tethereal.

If you uploaded the capture file to an S3800 server, view the file using Tethereal, a command-line version of Ethereal available on the S3800. See the Tethereal man pages for more information about the Tethereal application.

If you uploaded the capture file to a remote server, you can view the file using the industry standard Ethereal application. The latest version of Ethereal for Windows, Linux, UNIX, and other platforms can be downloaded from <http://www.ethereal.com>.

### Note:

Ethereal allows you to create filter expressions to filter the packets in the capture file and display desired files only. For example, you can display only packets with a specific source address, or only those received from a specific interface. See [Identifying the interface](#) on page 430.

[Figure 38](#) shows a sample **Ethereal** screen.

Figure 38: Sample Ethereal screen

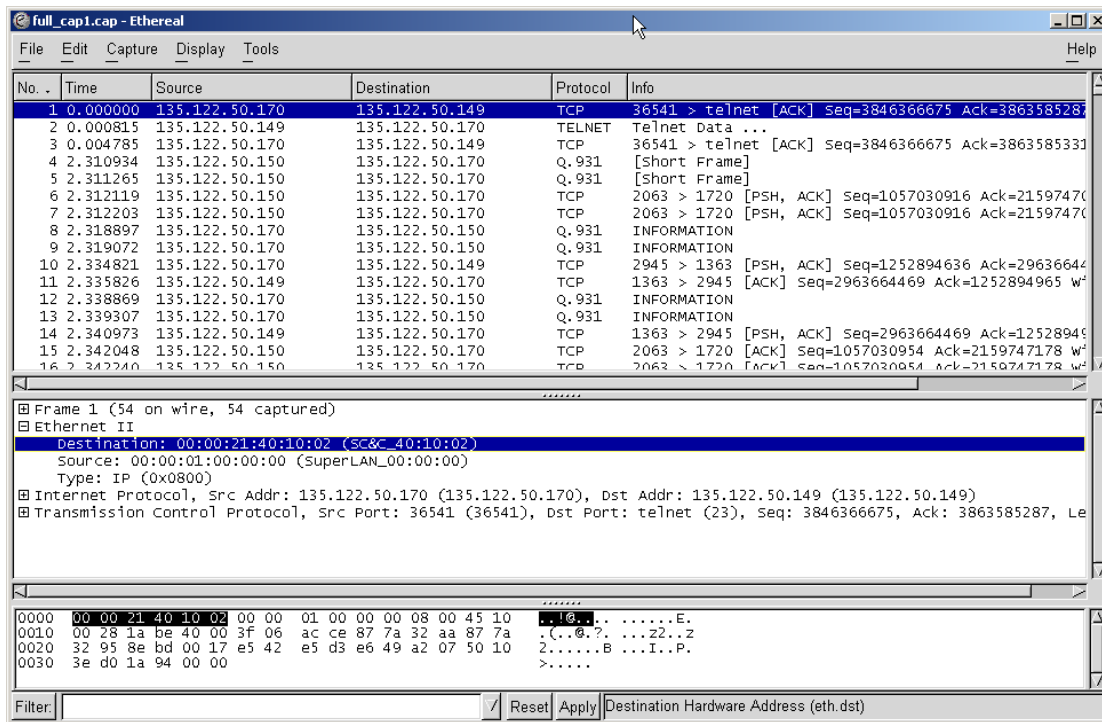

### Identifying the interface

The G450's packet sniffing service can capture also non-Ethernet packets, such as frame-relay and PPP, into the capture file. This is achieved by wrapping non-Ethernet packets in a dummy Ethernet header to allow the packets to be stored in a libpcap format. This enables you to analyze packets on all the device interfaces.

The dummy Ethernet headers are allocated according to the original packet type. Dummy Ethernet headers start with 00:00. Therefore, if the source or destination address of a packet you are viewing in Ethereal starts with 00:00, this indicates the packet is a non-Ethernet packet. For example, see the highlighted destination address of the packet appearing in the middle pane in [Figure 38](#).

The dummy Ethernet header is identified by special MAC addresses. Packets sent from a non-Ethernet interface are identified with an SA address in the format 00:01:00:00:xx and a DA address which holds the interface index. Packets received over a non-Ethernet interface are identified with DA address in the format 00:01:00:00:xx and an SA address which holds the interface index. The **show capture-dummy-headers** command displays the dummy header addresses and their meaning according to the current configuration.

**Note:**

Ethernet packets received on a VLAN interface are identified by their VLAN tag. However, decrypted IPSec packets received on a VLAN interface are stored with a dummy header.

```
G450-001> show capture-dummy-headers

      MAC                Description
-----
00:00:01:00:00:00  Src/dst address of Packet to/from frame-relay or PPP
00:00:01:00:00:01  Decrypted IPSec packet
00:00:0a:00:0a:02  interface fastethernet 10/2
00:00:0c:a0:b0:01  interface vlan 1
00:00:21:20:10:01  interface serial 3/1:1
00:00:21:40:10:02  interface serial 4/1:2
00:00:31:00:00:01  interface dialer 1
```

Thus in the example appearing in [Figure 38](#):

- The Source address of 00:00:01:00:00:00 indicates that the packet arrived from a frame-relay or PPP interface
- The Destination address of 00:00:21:40:10:02 indicates that the packet is being sent to the Serial interface on the media module in slot number 4, on port number 1, with channel group number 2

---

## Simulating packets

Capture lists support the IP simulate command. Refer to [Simulating packets](#) on page 611.

## Summary of packet sniffing commands

For more information about these commands, see *Avaya G450 CLI Reference*, 03-300437.

**Table 107: Packet sniffing CLI commands**

Root level command	First level command	Second level command	Description
<code>capture</code>	<code>buffer-mode</code>		Set the capture buffer to cyclic mode
<code>capture</code>	<code>buffer-size</code>		Change the size of the capture file
<code>capture</code>	<code>filter-group</code>		Activate a capture list
<code>capture</code>	<code>interface</code>		Specify a capture interface (by default, the service captures from all interfaces simultaneously)
<code>capture</code>	<code>ipsec</code>		Set whether to capture IPsec VPN packets, handled by the internal VPN process, decrypted (plaintext) or encrypted (cyphertext)
<code>capture</code>	<code>max-frame-size</code>		Set the maximum octets that are captured from each frame
<code>capture</code>	<code>start</code>		Start capturing packets
<code>capture</code>	<code>stop</code>		Stop capturing packets
<code>capture-service</code>			Enable or disable the capture service
<code>clear</code>	<code>capture-buffer</code>		Clear the capture buffer (useful in case it holds sensitive information)
<code>copy</code>	<code>capture-file</code>	<code>ftp</code>	Upload the packet sniffing buffer to a file on a remote FTP server
<code>copy</code>	<code>capture-file</code>	<code>scp</code>	Upload the packet sniffing buffer to a file on a remote SCP server



Table 107: Packet sniffing CLI commands (continued)

Root level command	First level command	Second level command	Description
<b>copy</b> <b>capture-file</b> <b>tftp</b>			Upload the packet sniffing buffer to a file on a remote TFTP server
<b>copy</b> <b>capture-file</b> <b>usb</b>			Upload the capture file to a USB mass storage device
<b>ip capture-list</b>			Enter the capture list configuration context, create a capture list, or delete a capture list
	<b>cookie</b>		Set a number to identify a list (used by the rule-manager application)
	<b>ip-rule</b>		Enter an ip-rule context or erase an ip-rule
		<b>composite-operation</b>	Create or edit a composite operation
		<b>destination-ip</b>	Define an equation on the destination IP
		<b>dscp</b>	Specify the DSCP value to be set by the current IP rule
		<b>fragment</b>	Apply the current rule to non-initial fragments only
		<b>icmp</b>	Set 'ip-protocol' to ICMP and an equation on the types of ICMP messages
		<b>ip-protocol</b>	Set the IP protocol
		<b>source-ip</b>	Set the current rule to apply to packets from the specified source IP address
		<b>tcp destination-port</b>	Set 'ip-protocol' to TCP and an equation on the destination port
		<b>tcp source-port</b>	Set 'ip-protocol' to TCP and an equation on the source port

2 of 3

Table 107: Packet sniffing CLI commands (continued)

Root level command	First level command	Second level command	Description
		<b>udp destination-port</b>	Set 'ip-protocol' to UDP and an equation on the destination port
		<b>udp source-port</b>	Set 'ip-protocol' to UDP and an equation on the source port
	<b>name</b>		Name a capture list
	<b>owner</b>		Set the name of the person or application that has created the list
<b>show capture</b>			Show the sniffer status
<b>show capture-buffer hex</b>			Show a hex-dump of the captured frames
<b>show ip capture-list</b>			Show capture list(s)
<b>show upload status</b>			View capture file upload status

3 of 3

## Reporting on interface status

You report on the status of an interface using the **show interfaces** command. The command reports on the administrative status of the interface, its operational status, and its extended operational status (the ICMP keepalive status). For information about ICMP keepalive status, refer to [ICMP keepalive](#) on page 292.

For example, if an interface is enabled but normal keepalive packets are failing, show interfaces displays:

```
FastEthernet 10/2 is up, line protocol is down
```

However, if normal keepalive reports that the connection is up but ICMP keepalive fails, the following is displayed:

```
FastEthernet 10/2 is up, line protocol is down (no KeepAlive)
```

**Table 108: Reporting of interface status**

Port status	Keepalive status	Show interfaces output	Administrative state	Operational state	Extended operational state
Up	No Keepalive	FastEthernet 10/2 is up, line protocol is up	Up	Up	Up
Up	Keepalive Up	FastEthernet 10/2 is up, line protocol is up	Up	Up	Up
Up	Keepalive down	FastEthernet 10/2 is up, line protocol is down (no keepalive)	Up	Up	KeepAlive-Down
Down	N/A	FastEthernet 10/2 is up, line protocol is down	Up	Down	FaultDown
Standby	N/A	FastEthernet 10/2 is in standby mode, line protocol is down	Up	Dormant	DormantDown
Shutdown	N/A	FastEthernet 10/2 is administratively down, line protocol is down	Down	Down	AdminDown

For detailed specifications of CLI commands, refer to *Avaya G450 CLI Reference*, 03-602056.

## Summary of interface status commands

For more information about these commands, see *Avaya G450 CLI Reference*, 03-300437.

**Table 109: Interface status CLI commands**

Command	Description
<b>show interfaces</b>	Display interface information

## Configuring and monitoring CNA test plugs

The Converged Network Analyzer (CNA) is a distributed system for real-time monitoring of IP networks, using active measurements. The CNA supports various network tests including connectivity tests with pings, topology tests with traceroute, and QoS tests with synthetic RTP streams. Within a CNA system, test plugs are the entities that execute the tests, according to instructions from CNA schedulers, and return the results. For more information about administrating the CNA system, see *IM R3.0 Converged Network Analyzer (CNA) Configuration*, 14-300284.

---

### CNA test plug functionality

When activated, test plugs present themselves to the CNA system in a process called *registration*. During registration, a test plug publishes its IP address and active ports, and authenticates and exchanges encryption keys with CNA schedulers.

The schedulers are software components running on single board computers called *chatterboxes*. Schedulers are responsible for initiating tests, coordinating tests, and collecting the test results.

For redundancy and load sharing, CNA systems usually include multiple chatterboxes and, therefore, multiple schedulers. However, since the schedulers distribute test plug registration parameters among themselves, a test plug only has to register with a single scheduler. Test plug administrators typically configure multiple scheduler addresses, for redundancy.

You can configure a list of up to five scheduler IP addresses. The test plug attempts to register with the first scheduler on the list first, and then moves down the list as necessary if the registration is unsuccessful.

When the test plug registers with a scheduler, the test plug provides the scheduler with its IP address, and two UDP port numbers, called the control port and the RTP echo port. The test plug IP address is the IP address of the interface on which the PMI is configured.

### Test plug actions

Once registered, the test plug listens for test requests on the control port. When the test plug receives an authenticated and validly formatted test request from the scheduler, the test plug performs the following:

- Injects any one of the tests specified in the test request into the network
- Performs the specified test using the parameter values passed in the test request
- Upon successful completion of the test, sends the test results to the analyzer of the chatterbox whose IP address is designated in the test request

## CNA tests

The G450 test plug supports all CNA tests, which are:

- **Traceroute.** Measures per-hop round-trip delays to a target IP address by sending a sequence of hop-limited UDP messages, each with a Time To Live (TTL) value that is one greater than that of the preceding message.
- **Real Time Protocol (RTP).** Measures delay, packet loss, and jitter to another test plug by sending a simulated RTP stream that is echoed back.
- **Ping.** Sends an ICMP echo message to a target IP address, and reports whether or not a response was returned.
- **Transmission Control Protocol (TCP) Connect.** Attempts to establish a TCP connection to a specified port at a target IP address, and reports whether the attempt succeeded or failed and the time taken by the TCP packet to reach its destination.
- **Merge.** Chatter test that is used, transparently to the user, to identify a single device with multiple IP addresses and to merge its multiple appearances into one in the network topology map.

When the test plug receives a request to run an RTP test, the test plug uses a UDP port called the RTP test port to send an RTP stream to another test plug. The test plug listens on the RTP echo port for RTP streams sent by other test plugs running RTP tests. All the UDP ports have default values, which can be overridden using CLI commands. The defaults are:

**Table 110: Default UDP port values**

UDP Port	Default value
Control port	8889
RTP echo port	8888
RTP test port	8887

Any changes you make to the test plug configuration, such as changing scheduler addresses or port numbers, only take effect when you cause the test plug to disconnect from the scheduler and register again.

---

## Configuring the G450 test plug for registration

From the G450 CLI, you can configure the G450 test plug to register with a CNA scheduler.

1. Use the **cna-testplug** command to enter the `testplug` context. For example:

```
G450-001# cna-testplug 1
G450-001(cna-testplug 1)#
```

## Configuring monitoring applications

2. Use the **scheduler** command to configure one or more CNA scheduler IP addresses. You can configure up to five scheduler addresses. The test plug attempts to register with a scheduler according to its place on the list. By default, no schedulers are configured. At least one scheduler must be configured for registration to be possible.
3. Perform the following configurations as necessary:
  - Use the **control-port** command to configure the control port. The default control port number is 8889.
  - Use the **rtp-echo-port** command to configure the RTP echo port. The default RTP echo port number is 8888.
  - Use the **rtp-test-port** command to configure the RTP test port. The default RTP test port number is 8887.
  - Use the **test-rate-limit** command to configure the CNA test rate limiter. The default test rate is 60 tests every 10 seconds.
4. If necessary, use the **no shutdown** command to enable the test plug. By default, the test plug is enabled.
5. When the test plug configurations are complete, use the **exit** command to exit the `testplug` context. From the general context, you can enter **show cna testplug** to display the test plug configuration.
6. From the general context, enter **cna-testplug-service** to enable the test plug service. For example:

```
G450-001# cna-testplug-service
The Converged Network Analyzer test plug is enabled.
```

### Note:

The **cna-testplug-service** command requires admin access level.

The test plug attempts to register with the first scheduler on the scheduler list. You can use the **show cna testplug** command to see if the test plug is registered and to view test plug statistics counters.

## CNA test plug configuration example

The following example includes displaying default test plug configuration, configuring the test plug, enabling the test plug service, and displaying test plug configuration and counters.

```
//to display default test plug configuration before performing any
//configuration:

G450-001(super)# show cna testplug
CNA testplug 1 is administratively down, test-plug status is unregistered
Address 149.49.75.178, bind to PMI, ID 00:04:0d:6d:30:48
Scheduler list:
Ports: Control 8889, RTP-test 8888, RTP-echo 8887
Test rate limiter: Maximum 60 tests in 10 seconds
Last Test: none

Test                Count          Failed          Cancelled
-----
traceroute          0              0              0
rtp                  0              0              0
ping                 0              0              0
tcpconnect           0              0              0
merge                0              0              0

//to enter the test plug context:
G450-001(super)# cna testplug 1
//to configure entries 3 and 1 on the scheduler list:
G450-001(super-cna testplug 1)# scheduler 3 135.64.102.76
Done!
G450-001(super-cna testplug 1)# scheduler 1 1.1.1.1
Done!
//to change the configuration of scheduler 1:
G450-001(super-cna testplug 1)# scheduler 1 1.1.1.2
Done!
//to exit the test plug context:
G450-001(super-cna testplug 1)# exit
//to display test plug configuration:
G450-001(super)# show cna testplug
CNA testplug 1 is administratively down, test-plug status is unregistered
Address 149.49.75.178, bind to PMI, ID 00:04:0d:6d:30:48
Scheduler list:
    1: 1.1.1.2:50002
    3: 135.64.102.76:50002
Ports: Control 8889, RTP-test 8888, RTP-echo 8887
Test rate limiter: Maximum 60 tests in 10 seconds
```

## Configuring monitoring applications

```
Last Test: none
Test          Count      Failed    Cancelled
-----
traceroute    0          0         0
rtp           0          0         0
ping          0          0         0
tcpconnect    0          0         0
merge         0          0         0//to reenter the test plug
context:
G450-001(super)# cna testplug 1
//to delete scheduler 1:
G450-001(super-cna testplug 1)# no scheduler 1
Done!
//to exit the test plug context:
G450-001(super-cna testplug 1)# exit
//to show that scheduler 1 is no longer configured:
G450-001(super)# show cna testplug
CNA testplug 1 is administratively down, test-plug status is unregistered
Address 149.49.75.178, bind to PMI, ID 00:04:0d:6d:30:48
Scheduler list:
    3: 135.64.102.76:50002
Ports: Control 8889, RTP-test 8888, RTP-echo 8887
Test rate limiter: Maximum 60 tests in 10 seconds
Last Test: none

Test          Count      Failed    Cancelled
-----
traceroute    0          0         0
rtp           0          0         0
ping          0          0         0
tcpconnect    0          0         0
merge         0          0         0
//to enable the test plug service:
G450-001(super)# cna testplug-service
Done!
//to display test plug configuration and counters after some running time:
G450-001(super)# show cna testplug
CNA testplug 1 is up, test-plug status is running a test
Address 149.49.75.178, bind to PMI, ID 00:04:0d:6d:30:48
Scheduler list:
    3: 135.64.102.76:50002
Ports: Control 8889, RTP-test 8888, RTP-echo 8887
Test rate limiter: Maximum 60 tests in 10 seconds
Last Test: traceroute to 135.64.103.107
Result:
ip1=149.49.75.178 ip2=135.64.103.107 ttl_len = 4

Test          Count      Failed    Cancelled
-----
traceroute    4          0         0
rtp           3          0         0
ping          2          0         0
tcpconnect    4          0         0
merge         0          0         0
```



---

## Resetting the CNA test plug counters

1. In the CNA `testplug` context, enter **clear counters**.

```
G450-001(cna-testplug 1)# clear counters
```

All CNA test plug counters are cleared.

---

## Summary of CNA test plug commands

For more information about these commands, see *Avaya G450 CLI Reference*, 03-300437.

**Table 111: CNA test plug CLI commands**

Root level command	Command	Description
<b>cna testplug</b>		Enter the CNA <code>testplug</code> configuration context
	<b>clear counters</b>	Clear the CNA test plug counters
	<b>control-port</b>	Set or reset the UDP port on which the CNA test plug listens for test requests from schedulers
	<b>rtp-echo-port</b>	Set or reset the UDP port used by the CNA test plug to listen for RTP streams sent by other test plugs running RTP tests
	<b>rtp-test-port</b>	Set or reset the UDP port used by the CNA test plug to send an RTP stream to another test plug in an RTP test
	<b>scheduler</b>	Add a scheduler's IP address to the list of schedulers with which the test plug can attempt to register
	<b>shutdown</b>	Disable the CNA test plug
	<b>test-rate-limit</b>	Configure the CNA test rate limiter
<b>cna-testplug-service</b>		Enable or disable the CNA test plug service on the gateway
<b>show cna testplug</b>		Display CNA test plug configuration and statistics

---



# Chapter 18: Configuring the router

The Avaya G450 Media Gateway has an internal router. You can configure the following routing features on the router:

- Interfaces
- Unnumbered IP interfaces
- Routing table
- GRE tunneling
- DHCP and BOOTP relay
- DHCP server
- Broadcast relay
- ARP table
- ICMP errors
- RIP
- OSPF
- Route redistribution
- VRRP
- Fragmentation

You can configure multiple routing schemes on the G450. See [Routing sources](#) on page 451 for an explanation of the priority considerations employed by the G450 to determine the next hop source.

Use the **ip routing** command to enable the router. Use the **no** form of this command to disable the router.

---

## Configuring interfaces

You can use the CLI to configure interfaces on the router.

# Router interface concepts

The router in the Avaya G450 Media Gateway includes the following interface categories:

- Physical
- Layer 2 virtual
- Layer 3 routing

## Physical router interfaces

The following are the physical interfaces of the G450 router:

- **WAN Interfaces.** When you add a WAN media module to the Avaya G450 Media Gateway, the media module provides a WAN interface. You can add one of the following types of WAN media modules:
  - The Avaya MM340 media module provides an E1/T1 WAN interface
  - The Avaya MM342 media module provides a USP WAN interface
- **FastEthernet Interface.** The 10/2 and 10/4 Fast Ethernet ports on the front panel of the G450 provide a FastEthernet interface. This interface is an autosensing 10/100 Mbps Fast Ethernet port. It can be used to connect to a LAN, an external firewall, an external Virtual Private Network (VPN), or a DeMilitarized Zone (DMZ). This interface can also be used as a WAN interface when configured for PPPoE. For more information, see [Configuring PPPoE](#) on page 259.
- **Switching Interface.** An internal 100 Mbps connection to the G450 internal switch provides a switching interface. The switching interface supports VLANs. By default, the switching interface is associated with the first VLAN (Vlan 1).

When you configure the G450 without an external VPN or firewall, Vlan 1 is used to connect the internal G450 router to the internal G450 switch. If an external firewall or VPN is connected to the Fast Ethernet port, it is important to disable Vlan 1 to prevent a direct flow of packets from the WAN to the LAN.

## Layer 2 virtual interfaces

- **Loopback.** The Loopback interface is a virtual Layer 2 interface over which loopback IP addresses are configured. The Loopback interface represents the router by an IP address that is always available, a feature necessary mainly for network troubleshooting.

Since the Loopback interface is not connected to any physical interface, an entry in the routing table can not have the Loopback interface's subnet as its next hop.

- **GRE tunnel.** A GRE tunnel is a virtual point-to-point link using two routers at two ends of an Internet cloud as its endpoints. GRE tunneling encapsulates packets and sends them over a GRE tunnel. At the end of the GRE tunnel, the encapsulation is removed and the packet is sent to its destination in the network at the far end of the GRE tunnel. For more information, see [Configuring GRE tunneling](#) on page 456.

## Layer 2 logical interfaces

- **VLAN (on the Switching Interface).** The G450 switch can have multiple VLANs defined within its switching fabric. The G450 router supports up to 64 VLANs that can be configured over their internal switching interface connections.
- **Serial Interface.** The Serial interface is a virtual interface that is created over a portion of an E1/T1 or USP port. Serial interfaces support PPP and frame relay encapsulation protocols. For more information about configuring Serial interfaces for a WAN, see [Initial WAN configuration](#) on page 248.
- **Dialer Interface.** The Dialer interface is used for the modem dial-backup feature. Refer to [Modem dial backup](#) on page 271.

**Note:**

One or more IP interfaces can be defined over each Serial, FastEthernet, switching, and Loopback interface.

---

## IP Interface configuration commands

1. To create an interface, enter **interface** followed by the type of interface you want to create. Some types of interfaces require an identifier as a parameter. Other types of interfaces require the interface's module and port number as a parameter. For example:

```
interface vlan 1
interface serial 3/1
```

2. Enter **ip address**, followed by an IP address and subnet mask, to assign an IP address to the interface. Use the **no** form of this command to delete the IP interface.

## Configuring interface parameter commands

Use the following commands to configure the interface parameters. For more information about these commands, see *Avaya G450 CLI Reference*, 03-300437.

- Use the **ip admin-state** command to set the administrative state of the IP interface. The default state is up.
- Use the **ip broadcast-address** command to update the interface broadcast address.

---

## Interface configuration examples

Use the following commands to configure the fixed router port with IP address 10.20.30.40 and subnet mask 255.255.0.0:

```
G450-001# interface fastethernet 10/2
G450-001(if:FastEthernet 10/2)# ip address 10.20.30.40 255.255.0.0
Done!
```

Use the following commands to create VLAN 2 on the switching interface and configure it with IP address 10.30.50.70 and subnet mask 255.255.0.0:

```
G450-001# interface Vlan 2
G450-001(if:Vlan 2)# ip address 10.30.50.70 255.255.0.0
Done!
```

---

## Displaying interface configuration

Use the **show interface brief** command to display a summary of the configuration information for a specific interface or for all of the interfaces.

---

## Summary of basic interface configuration commands

For more information about these commands, see *Avaya G450 CLI Reference*, 03-300437.

**Table 112: Basic interface configuration CLI commands**

Root level command	Command	Description
<b>interface console</b>		Enter the <code>Console</code> interface configuration context, create the interface if it does not exist, or delete the <code>Console</code> interface
	<b>ip address</b>	Assign an IP address and mask to an interface or delete an interface
<b>interface dialer</b>		Enter the <code>Dialer</code> interface context, create the <code>Dialer</code> interface if it does not exist, or delete the <code>Dialer</code> interface

**1 of 3**

Table 112: Basic interface configuration CLI commands (continued)

Root level command	Command	Description
	<b>ip address</b>	Assign an IP address and mask to an interface or delete an interface
	<b>ip admin-state</b>	Set the administrative state of an IP interface
	<b>ip broadcast-address</b>	Update the interface broadcast address
<b>interface fastethernet</b>		Enter <code>FastEthernet</code> interface configuration context, create a FastEthernet interface if it does not exist, or delete a FastEthernet interface
	<b>ip address</b>	Assign an IP address and mask to an interface or delete an interface
	<b>ip admin-state</b>	Set the administrative state of an IP interface
	<b>ip broadcast-address</b>	Update the interface broadcast address
<b>interface loopback</b>		Enter <code>loopback</code> interface configuration context, create a Loopback interface if it does not exist, or delete a Loopback interface or sub-interface
	<b>ip address</b>	Assign an IP address and mask to an interface or delete an interface
	<b>ip admin-state</b>	Set the administrative state of an IP interface
<b>interface serial</b>		Enter <code>Serial</code> interface or sub-interface configuration context, create a serial interface if it does not exist, or delete a serial interface or sub-interface
	<b>ip address</b>	Assign an IP address and mask to an interface or delete an interface
	<b>ip admin-state</b>	Set the administrative state of an IP interface
	<b>ip broadcast-address</b>	Update the interface broadcast address
<b>interface tunnel</b>		Enter <code>tunnel</code> interface configuration context, create a tunnel interface if it does not exist, or delete a tunnel interface or sub-interface

2 of 3

Table 112: Basic interface configuration CLI commands (continued)

Root level command	Command	Description
	<code>ip address</code>	Assign an IP address and mask to an interface or delete an interface
<code>interface usb-modem</code>	<code>ip admin-state</code>	Set the administrative state of an IP interface
		Enter the <code>USB-modem</code> interface configuration context, reset the USB-modem interface settings to their factory defaults
	<code>ip address</code>	Assign an IP address and mask to an interface or delete an interface
<code>interface vlan</code>		Enter <code>VLAN</code> interface configuration context, create a VLAN interface if it does not exist, or delete a VLAN interface
	<code>ip address</code>	Assign an IP address and mask to an interface or delete an interface
	<code>ip admin-state</code>	Set the administrative state of an IP interface
	<code>ip broadcast-address</code>	Update the interface broadcast address
<code>show ip interface brief</code>		Display a summary of the interface configuration information for a specific interface or for all of the interfaces
		<b>3 of 3</b>

## Configuring unnumbered IP interfaces

Unnumbered IP is a feature that enables you to configure a point-to-point interface to borrow an IP address from another interface. Unnumbered IP enables IP processing on a point-to-point interface without assigning an explicit IP address to the interface.

Although unnumbered IP is supported on all point-to-point interfaces, the main use of the feature is to enable dynamic routing on the Dialer interface. The Dialer interface is used for the modem dial-backup feature. Refer to [Modem dial backup](#) on page 271. Modem dial-backup is a feature that sets up a backup dialing destination for a branch gateway. Modem dial-backup requires unnumbered IP to be configured on the Dialer interface of the branch gateway and at both the default and the backup dialing destinations.



---

## Configuring unnumbered IP on an interface

To configure unnumbered IP on an interface, you must specify the interface from which to borrow the IP address. The borrowed interface must already exist and have an IP address configured on it.

The status of an unnumbered IP interface is down whenever the borrowed interface is down. Therefore, it is recommended to borrow the IP address from an interface that is always up, such as the Loopback interface.

Routes discovered on an unnumbered interface by the RIP and OSPF routing protocols are displayed as “via routes” in the routing table. The next hop is listed as “via” the IP unnumbered interface instead of the source address of the routing update.

1. Decide which interface from which to borrow the IP address. If necessary, configure the interface. You can use the **show interfaces** command to display existing interface configuration.
2. Enter the context of the interface on which you want to configure an unnumbered IP address (usually the Dialer interface).
3. Use the **ip unnumbered** command, specifying the interface from which to borrow the IP address.

---

## Unnumbered IP examples

In the following example, a VLAN interface is configured, and then the Dialer interface is configured with an unnumbered IP address, borrowing the IP address from the VLAN interface.

```
//enter the context of vlan interface 1:
G450-001(super)# interface Vlan 1
//to configure the IP address of the vlan interface:
G450-001(super-if:Vlan 1)# ip address 180.0.0.1 255.255.255.0
G450-001(super-if:Vlan 1)# exit
G450-001# !
//enter the context of the Dialer interface:
G450-001(super)# interface dialer 1
G450-001(super-if:Dialer 1)# dialer string 1 3001
G450-001(super-if:Dialer 1)# dialer persistent delay 1
G450-001(super-if:Dialer 1)# dialer modem-interface USB-modem
//to configure IP unnumbered on the Dialer interface, borrowing the IP address
from vlan interface 1, configured above:
G450-001(super-if:Dialer 1)# ip unnumbered 1 Vlan 1
G450-001(super-if:Dialer 1)# exit
G450-001(super)# !
```

## Configuring the router

The following sample routing table shows how routes discovered on unnumbered interfaces by routing protocols are listed as via routes in the **Next-Hop** column:

Network	Mask	Interface	Next-Hop	Cost	TTL	Source
0.0.0.0	0	FastEth10/2	149.49.54.1	1	n/a	STAT-HI
2.2.2.0	24	Vlan15	2.2.2.1	1	n/a	LOCAL
10.0.0.0	8	Vlan1	0.0.0.40	1	n/a	LOCAL
3.0.0.0	8	Tunnel1	Via Dia.1	2	172	RIP
4.0.0.0	8	Tunnel 1	Via Dia.1	2	172	RIP
20.0.0.0	8	Tunnel 1	Via Dia.1	11112	n/a	OSPF
20.0.0.1	32	Tunnel 1	Via Dia.1	22222	n/a	OSPF
26.0.0.0	8	Vlan 15	2.2.2.2	3	n/a	STAT-LO
31.0.0.0	8	Serial 3/1:1.1	31.0.0.1	1	n/a	LOCAL
32.0.0.0	8	Serial 3/1:1.2	32.0.0.1	1	n/a	LOCAL
33.0.0.0	8	Serial 3/1:1.3	33.0.0.1	1	n/a	LOCAL
99.0.0.0	8	Vlan 99	99.1.1.1	1	n/a	LOCAL
135.64.0.0	16	FastEth 10/2	149.49.54.1	1	n/a	STAT-HI
138.0.0.0	8	Serial 3/1:1.1	Via Ser.3/1:1.1	2	n/a	STAT-LO
139.0.0.0	8	Serial 3/1:1.1	Via Ser.3/1:1.1	1	n/a	STAT-LO
149.49.54.0	24	FastEth 10/2	149.49.54.112	1	n/a	LOCAL
180.0.0.0	8	Loopback 1	180.0.0.1	1	n/a	LOCAL

---

## Summary of unnumbered IP interface configuration commands

For more information about these commands, see *Avaya G450 CLI Reference*, 03-300437.

**Table 113: Unnumbered IP interface configuration CLI commands**

Root level command	Command	Description
<b>interface</b> ( <b>dialer</b>   <b>fastethernet</b>   <b>serial</b>   <b>tunnel</b> )		Enter the Dialer, Serial, or Tunnel interface context
	<b>ip unnumbered</b>	Configure an interface to borrow an IP address from another interface or remove an unnumbered IP configuration from an interface

---

## Routing sources

The G450 router supports both static and dynamic routing per interface. You can configure static routes with two levels of priority, high and low, and you can enable and configure Open Shortest Path First (OSPF) and Routing Information Protocol (RIP) dynamic routing protocols. Additionally, when DHCP client is configured on an interface, you can configure DHCP client to request a default router address from the DHCP server (DHCP option 3).

The actual source from which the router learns the next hop for any given interface is determined as follows: The router seeks the best match to a packet's destination IP address from all enabled routing sources. If there is no best match, the next hop source is determined according to the following priority order:

1. **High priority static route (highest).** If a high priority static route is configured on the interface, this route overrides all other sources.
2. **OSPF.** If no high priority static route is configured on the interface, but OSPF is enabled, then OSPF determines the next hop.
3. **RIP.** If no high priority static router is configured on a given interface, and OSPF is not enabled, but RIP is enabled, RIP determines the next hop.
4. **EXT OSPF.**
5. **DHCP.** If no high priority static router is configured on a given interface, and neither OSPF nor RIP are enabled, and DHCP client is configured on the interface with a default router requested from the DHCP server (DHCP option 3), then the default router provided by DHCP is used.
6. **Low priority static route (lowest).**

When more than one next hop is learned from the same source, the router uses an equal cost multi path algorithm that performs load balancing between routes.

For information about configuring static routes, see [Configuring the routing table](#) on page 451. For information about configuring OSPF, see [Configuring OSPF](#) on page 492. For information about configuring RIP, see [Configuring RIP](#) on page 486. For information about configuring DHCP client, see [Configuring DHCP client](#) on page 199.

---

## Configuring the routing table

When you configure the routing table, you can:

- View information about the routing table
- Add entries to the routing table
- Delete entries from the routing table

## Configuring the router

### Note:

To change an entry in the routing table, delete the entry and then add it as a new entry.

The routes in the routing table are static routes. They are never timed-out, and can only be removed manually. If you delete the interface, all static routes on the interface are also deleted.

A static route becomes inactive whenever the underlying Layer 2 interface is down, except for permanent static routes. You can disable the interface manually using the **ip admin-state down** command. For more information, see [Permanent static route](#) on page 454. When the underlying Layer 2 interface becomes active, the static route enters the routing table again.

You can monitor the status of non-permanent static routes by applying object tracking to the route. Thus, if the track state is changed to down then the static route state is changed to inactive, and if the track state is changed to up then the static route state is changed to active. For more information on object tracking, see [Object tracking](#) on page 298.

Static routes can be advertised by routing protocols, such as RIP and OSPF. For more information, see [Route redistribution](#) on page 497. Static routes also support load-balancing similar to OSPF.

## Configuring next hops

Static routes can be configured with the following as next hops:

- **Via-interface route.** Specifies a Serial interface as the next hop, without a specific next hop IP address. See [Via-interface static route](#) on page 453.
- **Next-hop IP address.** Specifies the IP address of a router as a next hop. The next hop router must belong to one of the directly attached networks for which the Avaya G450 Media Gateway has an IP interface.

## Static route types

Two kinds of static routes can be configured:

- **High Preference static routes.** Preferred to routes learned from any routing protocol
- **Low Preference static routes.** Used temporarily until the route is learned from a routing protocol

By default, a static route has low preference.

## Configuring multiple next hops

You can configure up to three next hops for each static route in one of the following manners:

- Enter all of the next hops using a single **ip route** command. To add a new next hop to an existing static route, enter the new next hop individually, as in the following option.
- Enter each next hop individually with its own **ip route** command

**Note:**

If you apply tracking to a static route, you can only configure one next hop for the route.

Next hops can only be added to an existing static route if they have the same preference and metric as the currently defined next hops.

**Note:**

Metrics are used to choose between routes of the same protocol. Preferences are used to choose between routes of different protocols.

## Deleting a route and its next hops

Using the **no ip route** command deletes the route including all of its next-hops, whether entered individually or with a single command. For example, to specify next hops 149.49.54.1 and 149.49.75.1 as a static route to the network 10.1.1.0, do one of the following:

- Enter **ip route 10.1.1.0 24 149.49.54.1 149.49.75.1**, specifying all next hops together
- Enter both **ip route 10.1.1.0 24 149.49.54.1** and **ip route 10.1.1.0 24 149.49.75.1**

---

## Via-interface static route

PPP and frame relay allow for a Layer 3 interface to be established without knowing in advance the next-hop on the other side of a serial link. In this case, you can specify a Serial Layer 2 interface or a GRE tunnel as a next-hop instead of providing a specific next hop IP address. This is equivalent to specifying the node on the other side of the serial link as the next hop when its IP address is unknown. The via interface option is configured by specifying the type and the number of the Serial interface using the **ip route** command.

**Note:**

The interface used in the via route must have an IP address attached to it.

For example, the command **ip route 193.168.10.0 24 serial 3/1:1** creates a static route to the network 193.168.10.0 24 via the Serial 3/1:1 interface.

A static route can have both via interface and IP addressed next hops, with a maximum of three next-hops. If such a combination is required, separate **ip route** commands should be used for the via interface static route and the IP addressed next hop routes. Also, if more than one via interface next hop is required, each must be configured by separate **ip route** commands.

**Note:**

You cannot define a static route through the FastEthernet Interface unless the interface was previously configured to use PPPoE encapsulation or was configured as a DHCP Client. See [Configuring PPPoE](#) on page 259 and [Configuring DHCP client](#) on page 199.

---

## Permanent static route

The Avaya G450 Media Gateway enables you to configure a static route as a permanent route. Configuring this option prevents the static route from becoming inactive when the underlying Layer 2 interface is down. This prevents routing table updates from being sent each time an interface goes up or down when there is a fluctuating Layer 2 interface on the static route. Configure the permanent option using the **ip route** command.

For example, the command **ip route 193.168.10.0 24 serial 3/1:1 permanent** creates a permanent static route to the network 193.168.10.0 24 via the Serial 3/1:1 interface.

Permanent static routes should not be configured over Serial Layer 2 interfaces that participate in a Primary-Backup pair. For more information on Backup interfaces, see [Backup interfaces](#) on page 268.

**Note:**

You cannot configure tracking on a permanent static route.

---

## Discard route

Discard route enables you to prevent forwarding traffic to specific networks. You can configure a static route that drops all packets destined to the route. This is called a discard route, indicated by the null0 parameter, and is configured using the **ip route <network> <mask> null0** command.

For example, the command **ip route 134.66.0.0 16 Null0** configures the network 134.66.0.0 16 as a discard route.

**Note:**

You cannot configure tracking on a discard route.

---

## Routing table commands

Use the following commands to configure the routing table. For more information about these commands, see *Avaya G450 CLI Reference*, 03-300437.

- Enter **clear ip route all** to delete all dynamic routing entries from the routing table.
- Use the **ip default-gateway** command to define a default gateway for the router. Use the **no** form of this command to remove the default gateway.
- Use the **ip redirects** command to enable the sending of redirect messages on the current interface. Use the **no** form of this command to disable redirect messages. By default, sending of redirect messages on the interface is enabled.
- Use the **ip route** command to establish a static route. Use the **no** form of this command to remove a static route.
- Use the **ip netmask-format** command to specify the format of subnet masks in the output of **show** commands that display subnet masks, such as the **show ip route** command. Use the **no** form of this command to restore the format to the default format, which is decimal.
- Use the **show ip route** command to display information about the IP routing table.
- Enter **show ip route best-match**, followed by an IP address, to display a routing table for a destination address.
- Use the **show ip route static** command to display static routes.
- Enter **show ip route summary** to display the number of routes known to the device.
- Enter **show ip route track-table** to display all routes with configured object trackers.
- Enter **traceroute**, followed by an IP address, to trace the route an IP packet would follow to the specified IP address. The G450 traces the route by launching UDP probe packets with a small TTL, then listening for an ICMP time exceeded reply from a gateway.

**Note:**

Using the **traceroute** command, you can also trace the route inside a locally terminated tunnel (GRE, VPN).

---

## Summary of routing table commands

For more information about these commands, see *Avaya G450 CLI Reference*, 03-300437.

**Table 114: Routing table CLI commands**

Command	Description
<code>clear ip route</code>	Delete all the dynamic routing entries from the routing table
<code>ip default-gateway</code>	Define a default gateway for the router
<code>ip netmask-format</code>	Specify the format of subnet masks in the output of <code>show</code> commands
<code>ip redirects</code>	Enable the sending of redirect messages on the current interface
<code>ip route</code>	Establish a static route
<code>ip routing</code>	Enable IP routing
<code>show ip route</code>	Display information about the IP routing table
<code>show ip route best-match</code>	Display a routing table for a destination address
<code>show ip route static</code>	Display static routes
<code>show ip route summary</code>	Display the number of routes known to the device
<code>show ip route track-table</code>	Display all routes with configured object trackers
<code>traceroute</code>	Trace the route packets are taking to a particular IP address by displaying the hops along the path

---

## Configuring GRE tunneling

Generic Routing Encapsulation (GRE) is a multi-carrier protocol that encapsulates packets with an IP header and enables them to pass through the Internet via a GRE tunnel. A GRE tunnel is a virtual interface in which two routers serve as endpoints. The first router encapsulates the packet and sends it over the Internet to a router at the far end of the GRE tunnel. The second router removes the encapsulation and sends the packet towards its destination.



A GRE tunnel is set up as an IP interface, which allows you to use the GRE tunnel as a routing destination. A GRE tunnel can transport multicast packets, which allows it to work with routing protocols such as RIP and OSPF.

To set up a GRE tunnel, you must create the interface and assign it an IP address, a tunnel source address, and a tunnel destination address. GRE tunnels can be configured as next hops on static routes and policy-based routing next hop lists. Packets can also be routed to GRE tunnels dynamically.

**Note:**

There may be cases in which the GRE tunnel is not used for routing. In such cases, it may not be necessary to assign an IP address to the tunnel.

The main application for GRE tunneling is to allow packets that use protocols not supported on the Internet, or packets that use private IP addresses that cannot be routed on the Internet, to travel across the Internet. The following are examples of situations in which this can be useful:

- Providing multiprotocol local networks over a single-protocol backbone
- Providing workarounds for networks containing protocols that have limited hop counts, such as AppleTalk
- Connecting discontinuous subnetworks
- Enabling virtual private networks (VPNs) over a WAN

You can also configure a GRE tunnel to serve as a backup interface. For information on configuring backup interfaces, see [Backup interfaces](#) on page 268.

For an example of a GRE tunneling application, see [GRE tunnel application example](#) on page 464.

---

## Routing packets to a GRE tunnel

Packets can be routed to a GRE tunnel in the following ways:

- The Tunnel interface is configured as the next hop in a static route. See [Configuring the routing table](#) on page 451.
- The packet is routed to the Tunnel interface dynamically by a routing protocol (RIP or OSPF)
- The packet is routed to the Tunnel interface via policy-based routing. See [Configuring policy-based routing](#) on page 619.

---

# Preventing nested tunneling in GRE tunnels

Nested tunneling occurs when the tunnel's next hop for its destination is another tunnel, or the tunnel itself. When the next hop is the tunnel itself, a tunnel loop occurs. This is also known as recursive routing.

When the G450 recognizes nested tunneling, it brings down the Tunnel interface and produces a message that the interface is temporarily disabled due to nested tunneling. The tunnel remains down until the tunnel is reconfigured to eliminate the nested tunneling.

In addition to checking for nested tunneling, the G450 prevents loops in connection with GRE tunnels by preventing the same packet from being encapsulated more than once in the G450.

## Reasons for nested tunneling in a GRE tunnel

- A static route exists on the source tunnel endpoint that tells the tunnel to route packets addressed to the receiving tunnel endpoint via the tunnel itself
- The local endpoint of the tunnel learns the tunnel as a route to the tunnel's remote endpoint via OSPF or RIP
- A combination of static routes via parallel tunnels lead to a situation in which each tunnel is routing packets via another tunnel. For example:

```
G450-001(super)# interface tunnel 1
G450-001(super-if:Tunnel 1)# tunnel source x.x.x.x
G450-001(super-if:Tunnel 1)# tunnel destination 1.0.0.1
Done!
G450-001(super-if:Tunnel 1)# exit
G450-001(super)# interface tunnel 2
G450-001(super-if:Tunnel 2)# tunnel source x.x.x.x
G450-001(super-if:Tunnel 2)# tunnel destination 2.0.0.1
Done!
G450-001(super-if:Tunnel 2)# exit
G450-001(super)# interface tunnel 3
G450-001(super-if:Tunnel 3)# tunnel source x.x.x.x
G450-001(super-if:Tunnel 3)# tunnel destination 3.0.0.1
Done!
G450-001(super-if:Tunnel 3)# exit
G450-001(super)# ip route 1.0.0.1 tunnel 2
Done!
G450-001(super)# ip route 2.0.0.1 tunnel 3
Done!
G450-001(super)# ip route 3.0.0.1 tunnel 1
Done!
```

Using the network shown in [Figure 39](#) as an illustration, if Router 1 has an entry in its routing table regarding the tunnel's receiving endpoint, this will cause an internal route in which all packets exiting the tunnel will be redirected back into the tunnel itself.

---

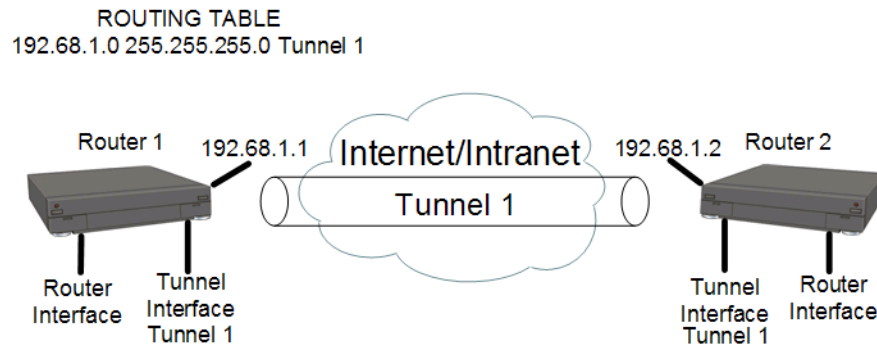
**Figure 39: Nested tunneling example**

## Recommendations on avoiding nested tunneling

- Announce policy.** Configure a policy rule on the receiving tunnel endpoint (router 2) that will cause the receiving endpoint to block advertisements of the source network (192.68.1.0) in its routing updates. This will prevent the source endpoint (router 1) from learning the route. This solution is for nested tunneling caused by RIP. For example, using the network shown in [Figure 39](#) as an illustration, you would configure the following policy rule on router 2 and activate it on the router RIP with the matching interface:

```
G450-001(super)# ip distribution access-list-name 1 "list #1"
Done!
G450-001(super)# ip distribution access-default-action 1 default-action-permit
Done!
G450-001(super)# ip distribution access-list 1 10 "deny" 192.68.1.0 0.0.0.255
Done!
G450-001(super)# router rip
G450-001(super router:rip)# distribution-list 1 out FastEthernet 10/2
Done!
G450-001(super router:rip)# exit
G450-001(super)#
```

## Configuring the router

- **Accept policy.** Configure a policy rule on the source tunnel endpoint (router 1) that will cause the source endpoint to not accept routing updates that include the source network (192.68.1.0). This solution is for nested tunneling caused by RIP. For example, using the network shown in [Figure 39](#) as an illustration, you would configure the following policy rule on router 1 and activate it on the router RIP with the matching interface:

```
G450-001(super)# ip distribution access-list-name 1 "list #1"
Done!
G450-001(super)# ip distribution access-default-action 1 default-action-permit
Done!
G450-001(super)# ip distribution access-list 1 10 "deny" 192.68.1.0 0.0.0.255
Done!
G450-001(super)# router rip
G450-001(super router:rip)# distribution-list 1 in FastEthernet 10/2
Done!
G450-001(super router:rip)# exit
G450-001(super)#
```

- **Static route.** Configure a static rule on router 1 telling it the route for packets destined to the tunnel's receiving endpoint (192.68.1.2). This route should be configured with a high route preference. For example:

```
G450-001(super)# ip route 192.68.1.2 255.255.0.0 192.68.1.3 high permanent
Done!
G450-001(super)#
```

---

## Optional GRE tunnel features

You can configure optional features in GRE tunnels. The tunnel keepalive feature enables periodic checking to determine if the tunnel is up or down. The dynamic MTU discovery feature determines and updates the lowest MTU on the current route through the tunnel.

### Keepalive

The tunnel keepalive feature sends keepalive packets through the Tunnel interface to determine whether the tunnel is up or down. This feature enables the tunnel's source interface to inform the host if the tunnel is down. When the tunnel keepalive feature is not active, if the tunnel is down, the tunnel's local endpoint continues to attempt to send packets over the tunnel without informing the host that the packets are failing to reach their destination.

Use the **keepalive** command in the GRE Tunnel interface context to enable the tunnel keepalive feature. Use the **no** form of this command to deactivate the feature.

The **keepalive** command includes the following parameters:

- **seconds.** The length, in seconds, of the interval at which the source interface sends keepalive packets. The default value is 10.

- **retries**. The number of retries after which the source interface declares that the tunnel is down. The default value is 3.

The following example configures Tunnel 1 to send keepalive packets every 20 seconds. If the tunnel's destination interface fails to respond to three consecutive packets, the tunnel's source interface concludes that the tunnel is down. The source interface continues to send keepalive packets, but until it receives a response from the tunnel's destination interface, the tunnel informs hosts that send packets to the tunnel that the tunnel is down.

```
G450-001# interface tunnel 1
G450-001(if:Tunnel 1)# keepalive 20 3
Done!
```

**Note:**

You do not have to configure tunnel keepalive on both sides of the tunnel.

## Dynamic MTU discovery

The size of packets that can travel through a GRE tunnel is limited by the lowest MTU of any router along the route through the tunnel. When dynamic MTU discovery is enabled, the tunnel maintains an MTU limit.

When a large packet is sent from the host with the DF bit on, and a router in the tunnel path has an MTU that is smaller than the size of the packet, since the DF bit is set, the router sends an ICMP unreachable message back in the originator (in this case, the GRE router). The GRE router then updates the tunnel's MTU limit accordingly. When a packet larger than the MTU arrives at the tunnel, if the packet is marked *do not fragment*, the tunnel's source interface sends the packet back to the host requesting the host to fragment the packet. When dynamic MTU discovery is disabled, the tunnel's source interface marks each packet as *may be fragmented*, even if the packet's original setting is *do not fragment*. For more information on MTU and fragmentation, refer to [Configuring fragmentation](#) on page 502.

Use the **tunnel path-mtu-discovery** command in the GRE Tunnel interface context to enable dynamic MTU discovery by the tunnel. Use the **no** form of this command to deactivate the feature.

The **tunnel path-mtu-discovery** command includes the following parameters:

- **age-timer**. How long until the local tunnel endpoint returns the tunnel MTU to its default. The default value of this parameter is 10 minutes.
- **infinite**. The tunnel does not update the MTU, and its value remains permanent

---

## Setting up a GRE tunnel

1. Enter **interface tunnel**, followed by a number identifying the tunnel, to create the new Tunnel interface. If you are changing the parameters of an existing tunnel, enter **interface tunnel**, followed by a number identifying the tunnel, to enter the Tunnel context. For example:

```
G450-001(super)# interface tunnel 2
G450-001(super-if:Tunnel 2)#
```

2. In the Tunnel interface context, enter **tunnel source**, followed by the public IP address of the local tunnel endpoint, to set the source address of the tunnel. For example:

```
G450-001(super-if:Tunnel 2)# tunnel source 70.70.70.2
Done!
G450-001(super-if:Tunnel 2)#
```

3. In the Tunnel interface context, enter **tunnel destination**, followed by the IP address of the remote tunnel endpoint, to set the destination address of the tunnel. For example:

```
G450-001(super-if:Tunnel 2)# tunnel destination 20.0.1.1
Done!
G450-001(super-if:Tunnel 2)#
```

**Note:**

The Avaya G450 Media Gateway does not check whether the configured tunnel source IP address is an existing IP address registered with the G450 router.

4. In most cases, it is recommended to configure keepalive in the tunnel so that the tunnel's source interface can determine and inform the host if the tunnel is down. For more information on keepalive, see [Keepalive](#) on page 460.

To configure keepalive for a Tunnel interface, enter **keepalive** in the Tunnel interface context, followed by the length (in seconds) of the interval at which the source interface sends keepalive packets, and the number of retries necessary in order to declare the tunnel down.

The following example configures the tunnel to send a keepalive packet every 20 seconds, and to declare the tunnel down if the source interface sends three consecutive keepalive packets without a response.

```
G450-001(super-if:Tunnel 2)# keepalive 20 3
Done!
G450-001(super-if:Tunnel 2)#
```

- In most cases, it is recommended to configure dynamic MTU discovery in the tunnel. This prevents fragmentation of packets larger than the tunnel's MTU. When dynamic MTU discovery is not enabled, the tunnel fragments packets larger than the tunnel's MTU, even when the packet is marked *do not fragment*. For more information on dynamic MTU discovery, see [Dynamic MTU discovery](#) on page 461.

The following example configures dynamic MTU discovery, with an age timer of 15 minutes.

```
G450-001(super-if:Tunnel 2)# tunnel path-mtu-discovery age-timer 15
Done!
G450-001(super-if:Tunnel 2)#
```

- Enter **copy running-config startup-config**. This saves the new Tunnel interface configuration in the startup configuration file.

For a list of optional GRE tunnel features, refer to [Optional GRE tunnel features](#) on page 460. For a list of additional GRE tunnel CLI commands, refer to [Additional GRE tunnel parameters](#) on page 463.

---

## Additional GRE tunnel parameters

Use the following commands to configure additional GRE tunnel parameters. For more information about these commands, see *Avaya G450 CLI Reference*, 03-300437.

- Use the **tunnel checksum** command in the GRE Tunnel interface context to add a checksum to the GRE header of packets traveling through the tunnel. When a checksum is included on one endpoint, the receiving tunnel endpoint performs checksum validation on incoming packets and packets without a valid checksum are discarded. Use the **no** form of this command to disable checksums.
- Use the **tunnel key** command in the GRE Tunnel interface context to enable and set an ID key for the tunnel. Tunnel ID keys are used as a security device. The key must be set to the same value on the tunnel endpoints. Packets without the configured key must be discarded. Use the **no** form of this command to disable key checking.
- Use the **tunnel dscp** command in the GRE Tunnel interface context to assign a DSCP value to packets traveling through the tunnel. The DSCP value is placed in the packet's Carrier IP header. You can assign a DSCP value of from 0 to 63. If you do not assign a DSCP value, the DSCP value is copied from the packet's original IP header.

**Note:**

The Carrier IP header identifies the source and destination IP address of the tunnel.

## Configuring the router

- Use the **tunnel ttl** command in the GRE Tunnel interface context to assign a TTL value to packets traveling through the tunnel. The TTL value is placed in the packet's Carrier IP header. You can assign a TTL value of from 1 to 255. The default tunnel TTL value is 255.
- Enter **show interfaces tunnel** to show interface configuration and statistics for a particular tunnel or all GRE tunnels.

### Note:

If the Tunnel interface is down, the **show interfaces tunnel** command displays the MTU value as `not available`.

---

## GRE tunnel application example

This section provides an example of a GRE tunnel application and its configuration.

---

**Figure 40: Simple GRE tunneling application example**

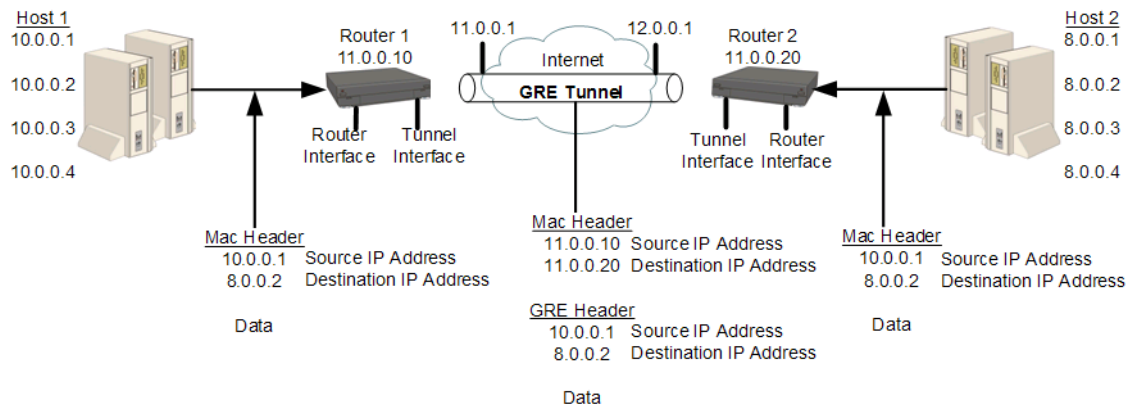

---

In the example shown in [Figure 40](#), Host 1 and Host 2 are private networks using a GRE tunnel to connect them via the Internet. 11.0.0.10 are public IP addresses used by the GRE tunnel for the tunnel encapsulation.

A packet originating from 10.0.0.1 on Host 1 is sent to the destination 8.0.0.2 on Host 2. Since the destination IP address is a private IP address, the packet cannot be routed as is over the Internet. Instead, Router 1 receives the packet from host 1, looks up the packet's destination address in its routing table, and determines that the next hop to the destination address is the remote end of the GRE tunnel.



Router 1 encapsulates the packet with a GRE header and a new IP header that assigns the IP address of Router 2 (12.0.0.20) as the destination IP address and the IP address of Router 1 (11.0.0.10) as the source IP address. When the packet arrives at Router 2, which is the end point of the GRE tunnel, Router 2 removes the outer IP header and the GRE header and sends the packet to its original destination at IP address (8.0.0.2).

You can use the following commands to configure GRE tunneling (with OSPF) in this example:

### Router 1 Configuration

```
G450-001(super)# interface fastethernet 10/2
G450-001(super-if:FastEthernet 10/2)# ip address 11.0.0.10 255.255.255.0
G450-001(super-if:FastEthernet 10/2)# exit
G450-001(super)# interface tunnel 1
G450-001(super-if:Tunnel 1)# keepalive 10 3
Done!
G450-001(super-if:Tunnel 1)# tunnel source 11.0.0.10
Done!
G450-001(super-if:Tunnel 1)# tunnel destination 12.0.0.20
Done!
G450-001(super-if:Tunnel 1)# ip address 1.1.1.1 255.255.255.0
Done!
G450-001(super-if:Tunnel 1)# exit
G450-001(super)# ip route 12.0.0.0 255.255.255.0 11.0.0.1 1 high
G450-001(super)# router ospf
G450-001(super router:ospf)# network 1.1.1.0 0.0.0.255 area 0.0.0.0
Done!
G450-001(super router:ospf)# exit
G450-001(super)#
```

### Router 2 Configuration

```
G450-001(super)# interface vlan 1
G450-001(super-if:Vlan 1)# ip address 12.0.0.10 255.255.255.0
G450-001(super-if:Vlan 1)# exit
G450-001(super)# interface tunnel 1
G450-001(super-if:Tunnel 1)# tunnel source 12.0.0.20
Done!
G450-001(super-if:Tunnel 1)# tunnel destination 11.0.0.10
Done!
G450-001(super-if:Tunnel 1)# ip address 1.1.1.2 255.255.255.0
G450-001(super-if:Tunnel 1)# exit
G450-001(super)# ip route 11.0.0.0 255.255.255.0 12.0.0.1 1 high
G450-001(super)# router ospf
G450-001(super router:ospf)# network 1.1.1.0 0.0.0.255 area 0.0.0.0
Done!
G450-001(super router:ospf)# exit
G450-001(super)#
```

## Summary of GRE tunneling commands

For more information about these commands, see *Avaya G450 CLI Reference*, 03-300437.

**Table 115: GRE tunneling CLI commands**

Root level command	Command	Description
<b>interface tunnel</b>		Enter <code>tunnel</code> interface configuration context, create a Tunnel interface if it does not exist, or delete a Tunnel interface or sub-interface
	<b>keepalive</b>	Enable the tunnel keepalive feature
	<b>tunnel checksum</b>	Add a checksum to the GRE header of packets traveling through the tunnel
	<b>tunnel destination</b>	Set the destination address of the tunnel
	<b>tunnel dscp</b>	Assign a DSCP value to packets traveling through the tunnel
	<b>tunnel key</b>	Enable and set an ID key for the tunnel
	<b>tunnel path-mtu-discovery</b>	Enable dynamic MTU discovery by the tunnel
	<b>tunnel source</b>	Set the source address of the tunnel
	<b>tunnel ttl</b>	Assign a TTL value to packets traveling through the tunnel
<b>show interfaces tunnel</b>		Show interface configuration and statistics for a particular tunnel or all GRE tunnels

---

## Configuring DHCP and BOOTP relay

You can configure the router to relay Dynamic Host Configuration Protocol (DHCP) and BOOTstrap Protocol (BOOTP) client broadcasts to a server on a different segment of the network. When you configure DHCP and BOOTP relay, you can control how the router relays DHCP and BOOTP packets. The router also relays replies from the server back to the client. The G450 can alternatively function as a DHCP server, providing DHCP service to local devices. For information about configuring DHCP server on the G450, see [Configuring DHCP server](#) on page 470. For information about configuring DHCP client on the G450, see [Configuring DHCP client](#) on page 199.

---

### DHCP

DHCP assigns dynamic IP addresses to devices on a network. With dynamic addressing, a device can have a different IP address whenever the device connects to the network. In some systems, the device's IP address can even change while it is still connected. DHCP also supports a mix of static and dynamic IP addresses.

Dynamic addressing simplifies network administration because the software keeps track of IP addresses rather than requiring an administrator to manage the task. This means you can add a new computer to a network without needing to manually assign a unique IP address. Many ISPs use dynamic IP addressing for dial-up users. However, dynamic addressing may not be desirable for a network server.

---

### BOOTP

BOOTP is an Internet protocol that allows a diskless workstation to discover the following:

- Its own IP address
- The IP address of a BOOTP server on the network
- A file to be loaded into memory to boot the workstation

BOOTP allows the workstation to boot without requiring a hard disk or floppy disk drive. It is used when the user or station location changes frequently. The protocol is defined by RFC 951.

## DHCP/BOOTP relay

The Avaya G450 Media Gateway supports the DHCP/BOOTP relay agent function. This is an application that accepts DHCP/BOOTP requests that are broadcast on one VLAN. The application sends them to a DHCP/BOOTP server. That server connects to another VLAN or a server that might be located across one or more routers that might otherwise not get the broadcast request. The relay agent handles the DHCP/BOOTP replies as well. The relay agent transmits the replies to the client directly or as broadcast, according to a flag in the reply message.

**Note:**

The same DHCP/BOOTP relay agent serves both the BOOTP and DHCP protocols.

When there is more than one IP interface on a VLAN, the G450 chooses the lowest IP address on this VLAN when relaying DHCP/BOOTP requests. The DHCP/BOOTP server then uses this address to decide the network from which to allocate the address. When there are multiple networks configured, the G450 performs a round-robin selection process.

When the DHCP/BOOTP server is configured to allocate addresses only from a single subnetwork among the different subnetworks defined on the VLAN, you might need to configure the G450 with the relay address on that subnet so the DHCP/BOOTP server can accept the request.

DHCP/BOOTP Relay in G450 is configurable per VLAN and allows for two DHCP/BOOTP servers to be specified. In this case, the G450 duplicates each request, and sends it to both servers. This duplication provides redundancy and prevents the failure of a single server from blocking hosts from loading. You can enable or disable DHCP/BOOTP Relay in the G450.

---

## DHCP/BOOTP relay commands

Use the following commands to configure DHCP relay and BOOTP relay:

- Use the **ip bootp-dhcp network** command to select the network from which the BOOTP/DHCP server should allocate an address. This command is required only when there are multiple IP interfaces over the VLAN. Use the **no** form of this command to restore the default value. You must be in an interface context to use this command.
- Enter **ip bootp-dhcp relay** to enable relaying of BOOTP and DHCP requests to the BOOTP/DHCP server. Use the **no** form of this command to disable relaying of BOOTP and DHCP requests. You must be in general context to use this command.
- Use the **ip bootp-dhcp server** command to add a BOOTP/DHCP server to handle BOOTP/DHCP requests received by this interface. A maximum of two servers can be added to a single interface. Use the **no** form of this command to remove a server. You must be in an interface context to use this command.

---

## Summary of DHCP and BOOTP relay commands

For more information about these commands, see *Avaya G450 CLI Reference*, 03-300437.

**Table 116: DHCP and BOOTP relay CLI commands**

Root level command	Command	Description
<b>interface</b> ( <b>fastethernet</b>   <b>VLAN</b> )		Enter the <code>FastEthernet</code> or <code>VLAN</code> interface configuration context
	<b>ip bootp-dhcp network</b>	Select the network from which the BOOTP/DHCP server should allocate an address
	<b>ip bootp-dhcp server</b>	Add or remove a BOOTP/DHCP server to handle BOOTP/DHCP requests received by the current interface
<b>ip bootp-dhcp relay</b>		Enable or disable relaying of BOOTP and DHCP requests to the BOOTP/DHCP server

## Configuring DHCP server

The G450 supports DHCP server. DHCP server is a protocol for automatically assigning IP addresses and other configuration parameters to clients on a TCP/IP network. DHCP server minimizes the maintenance of a network of, among other things, IP telephones and PCs, by removing the need to assign and maintain IP addresses and other parameters for each device on the network individually.

Since a DHCP server can be configured on the G450, local branch devices are not dependant on receiving configuration parameters over the WAN from a remote DHCP server and, therefore, can be assigned IP configuration parameters in case of WAN failure.

The G450 supports the following DHCP server features:

- Up to 32 DHCP pools
- Up to 120 users
- Up to 256 IP addresses for all DHCP pools together
- Automatic and reservation pools
- Standard DHCP options and IP phone and wireless special options
- Vendor specific information option
- DHCP relay packets
- Global statistics
- Syslog/traps for special events

The Avaya G450 Media Gateway can function as a DHCP server, as a DHCP relay, or both simultaneously, with each interface configured in either DHCP server mode or DHCP relay mode. For example, you can configure the G450 to provide DHCP service to voice devices while DHCP requests by data devices are routed to a central remote DHCP server using DHCP relay.

The Avaya G450 Media Gateway can function as a DHCP server or as a DHCP client, or both simultaneously. For information about configuring DHCP client on the G450, see [Configuring DHCP client](#) on page 199.

## Typical DHCP server application

In the typical application shown in [Figure 41](#), the G450 is configured as a local DHCP server and router for IP phones and PCs in the branch office. The remote DHCP server allocates IP addresses for headquarters users. In case of WAN failure, the local DHCP server can still allocate IP addresses in the branch offices. If there is a local ICC or LSP, calls can still be made. If there is no ICC or LSP to control calls, the DHCP server can allocate IP addresses to all devices, but, since no calls can be made, the IP address allocation effectively applies to PCs only.

**Figure 41: G450 as server and router**

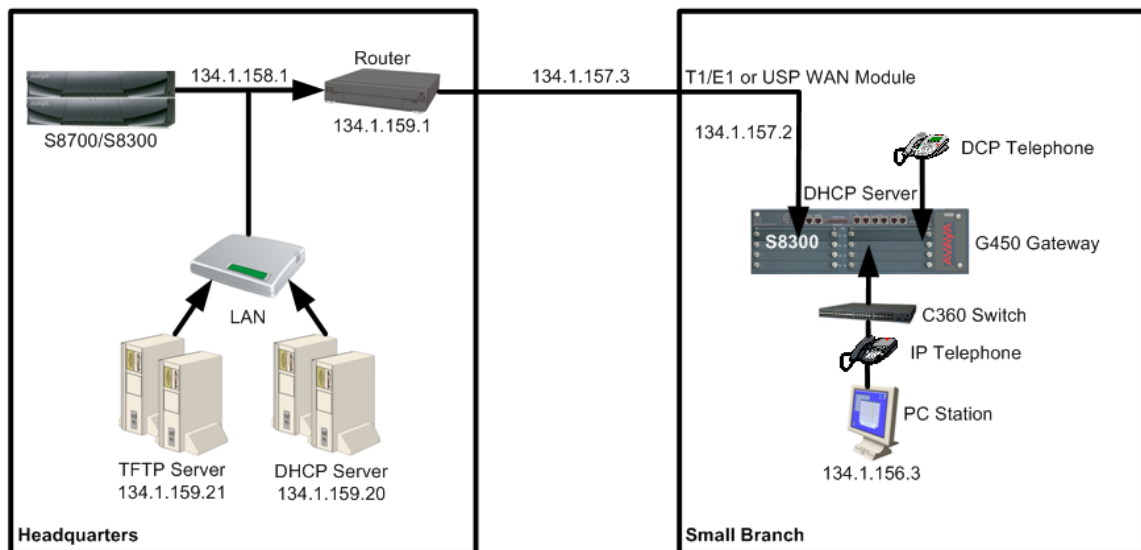

The branch DHCP server does not depend on the headquarters' DHCP server. There is no backup mechanism between the servers. The branch DHCP server operates continually regardless of the status of the centralized DHCP server or the WAN link.

By default, the DHCP server is inactive. Before activating DHCP server, you configure DHCP pools to define ranges of IP addresses and other network configuration information to be assigned to clients. Create a minimum of two dynamic pools: at least one pool for data devices (PCs) and at least one pool for voice devices (IP phones). The G450 also supports reservation pools, which map hardware addresses/client identifiers to specific IP addresses. Reservation pools may be required for security issues or VPN appliances.

Overlap between pools is not allowed. You cannot configure a reservation pool on an IP address that falls within the range of another pool.

---

## DHCP server CLI configuration

1. Enter **ip dhcp pool**, followed by a number from 1 to 32, to create a DHCP pool.
2. Use the **name** command to configure the pool's name.
3. Configure a range of available IP addresses that the DHCP server may assign to clients, using **start-ip-addr** to set the start IP address of the range and **end-ip-addr** to set the end IP address of the range. Consider the following:
  - For a manual/reservation pool, set identical IP addresses for the start and end IP addresses
  - The start IP address and end IP address must be on the same network according to the subnet mask
  - The start IP address must be lower than the end IP address
  - The combined number of IP addresses in all pools must not exceed 256 addresses
  - Both the start IP address and end IP address can be up to 223.255.255.255
  - The start IP address and end IP address may not be network/broadcast addresses according to the subnet mask
4. Use the **subnet-mask** command to configure the subnet mask of the pool.
5. Use the **lease** command to configure the lease period for IP address assignment. By default, the lease is eight days.
6. For a manual/reservation pool, use the **client identifier** command to reserve the pool's IP address for assignment to a specific client. To configure a reservation, the start IP address and end IP address must be identical. You cannot configure more than one reservation on a single pool.
7. Configure DHCP options for the pool, if required. See [Configuring Options](#) on page 473 and, for vendor specific options, [Configuring vendor-specific options](#) on page 474.
8. Repeat steps 1-7 to configure as many DHCP pools as you require. You can configure up to 32 DHCP pools. By default, all pools are inactive until you activate them. This enables you to modify each pool's configuration without affecting network devices.
9. Activate each of the DHCP pools you configured using the **ip dhcp activate pool** command in general context, followed by the pool number.
10. Enter **ip dhcp-server** to activate DHCP server. DHCP server is now active. If you change the pool configuration, it is recommended to do so while the pool is active.

**Note:**

If you try to configure a new start and end IP address which is not part of the current network and beyond the allowed maximum of 256 IP addresses, you must first use the **no start ip address** and **no end ip address** commands before configuring the new start and end IP addresses.



## Configuring Options

DHCP options are various types of network configuration information that the DHCP client can receive from the DHCP server. The G450 supports all DHCP options. The most common options used for IP phones are listed in [Table 117](#). Some options are configured with specific CLI commands, which are also listed in [Table 117](#). Options 0, 50, 51, 52, 53, 54, 55, 56, and 255 are not configurable.

1. Use the **option** command to specify the option code and enter the context for the option.

**Note:**

To configure an option that is listed in [Table 117](#) with an entry in the *Specific command* column, use the specific command instead of the **option** command.

**Table 117: Common user-configurable DHCP options**

Option	Description	Specific command
1	Subnet Mask	<b>subnet-mask</b>
3	Router	<b>default-router</b>
6	Domain name server	<b>dns_server</b>
7	Log Server	
15	Domain Name	<b>domain-name</b>
43	vendor-specific information	<b>vendor-specific-option</b>
44	Wins/NBNS server	
46	Wins/NBT Node Type	
51	IP Address Lease Time	<b>lease</b>
66	TFTP server name	
69	SMTP server	
176	Avaya IP phone private	

2. Use the **name** command to set the name of the DHCP option (optional).
3. Use the **value** command to enter the option data type and the option data.

### Configuring vendor-specific options

You can configure an option unique to an individual vendor class. This is called a vendor-specific option (option 43).

1. Use the **vendor-specific-option** command to create a vendor-specific option with a unique index.
2. Use the **name** command to name the option (optional).
3. Use the **class-identifier** command to set a vendor-specific identifier.
4. Use the **value** command to set the data type and value of the vendor-specific option.

---

### Optional DHCP server CLI commands

The following DHCP server commands are also available:

- Use the **clear ip dhcp-server binding** command to delete the allocation of a specific IP address or of all IP addresses. When the DHCP server detects an IP address conflict after attempting to allocate an IP address that is already in use, the server locks the IP address for half an hour by marking the IP address with client identifier 00:00:00:00:00:00. If you have solved the conflict before half an hour, you can use this command to free the IP address for reallocation.
- Use the **clear ip dhcp-server statistics** command to clear the statistics of the DHCP server.
- Use the **ip dhcp ping packets** command to enable the sending of a ping packet by the DHCP server to check if the IP address it is about to allocate is already in use by another client.
- Use the **ip dhcp ping timeout** command to set the ping timeout for the DHCP server.
- Use the **bootfile** command to specify the file name for a DHCP client to use as a boot file. This is DHCP option 67.
- Use the **next-server** command to specify the IP address of the next server in the boot process of a DHCP client.
- Use the **server-name** command to specify the optional server name in the boot process of a DHCP client.

---

## DHCP pool configuration examples

The following example defines a dynamic pool for voice devices:

```
G450-001(super)# ip dhcp pool 1
G450-001(super-DHCP 1)# name "IP phone Pool"
Done!
G450-001(super-DHCP 1)# start-ip-addr 135.64.20.2
Done!
G450-001(super-DHCP 1)# end-ip-addr 135.64.20.30
Done!
G450-001(super-DHCP 1)# subnet-mask 255.255.255.0
Done!
G450-001(super-DHCP 1)# default-router 135.64.20.1
Done!
G450-001(super-DHCP 1)# option 176
G450-001(super-DHCP 1/option 176)# name "Avaya IP phone option"
Done!
G450-001(super-DHCP 1/option 176)# value ascii "MCIPADD=10.10.2.140,
MCPORT=1719, TFTP SRVR=10.10.5.188"
Done!
G450-001(super-DHCP 1/option 176)# exit
G450-001(super-DHCP 1)# exit
G450-001(super)# ip dhcp activate pool 1
Done!
G450-001(super)# ip dhcp-server
Done!
G450-001(super)#
```

## Configuring the router

The following example defines a dynamic pool for data devices:

```
G450-001(super)# ip dhcp pool 2
G450-001(super-DHCP 2)# name "Data Pool"
Done!
G450-001(super-DHCP 2)# start-ip-addr 135.64.20.34
Done!
G450-001(super-DHCP 2)# end-ip-addr 135.64.20.60
Done!
G450-001(super-DHCP 2)# subnet-mask 255.255.255.0
Done!
G450-001(super-DHCP 2)# default-router 135.64.20.33
Done!
G450-001(super-DHCP 2)# dns-server 10.10.1.1
Done!
G450-001(super-DHCP 2)# domain-name my.domain.com
Done!
G450-001(super-DHCP 2)# option 176
G450-001(super-DHCP 2/option 176)# value ascii "MCIPADD=192.168.50.17,
192.168.50.15, MCPORT=1719, TFTPDIR=/phonedir/"
Done!
G450-001(super-DHCP 2/option 176)# exit
G450-001(super-DHCP 2)# exit
G450-001(super)# ip dhcp activate pool 2
Done!
G450-001(super)# ip dhcp-server
Done!
G450-001(super)#
```

The following example configures a vendor-specific option for DHCP pool 5:

```
G450-001(super-DHCP 5)# vendor-specific-option 1
G450-001(super-DHCP 5/vendor specific 1)# class-identifier
"ccp.avaya.com"
Done!
G450-001(super-DHCP 5/vendor specific 1)# value raw ascii "gfdgfd"
Done!
G450-001(super-DHCP 5/vendor specific 1)# exit
G450-001(super-DHCP 5)#
```

The following example defines a reservation pool for data devices:

```
G450-001(super)# ip dhcp pool 3
G450-001(super-DHCP 3)# name "Data 1 Server"
Done!
G450-001(super-DHCP 3)# start-ip-addr 135.64.20.61
Done!
G450-001(super-DHCP 3)# end-ip-addr 135.64.20.61
Done!
G450-001(super-DHCP 3)# subnet-mask 27
Done!
G450-001(super-DHCP 3)# client identifier 01:11:22:33:44:55:66
Done!
G450-001(super-DHCP 3)# default-router 135.64.20.33
Done!
G450-001(super-DHCP 3)# dns-server 10.10.1.1
Done!
G450-001(super-DHCP 3)# exit
G450-001(super)# ip dhcp activate pool 3
Done!
G450-001(super)#
```

---

## Displaying DHCP server information

You can use the following show commands to display DHCP server information:

- Use the **show ip dhcp-pool** command to display DHCP pool configurations.
- Use the **show ip dhcp-server bindings** command to display the current allocations of IP addresses to DHCP clients.
- Use the **show ip dhcp-server statistics** command to display DHCP server statistics.

## Summary of DHCP Server commands

For more information about these commands, see *Avaya G450 CLI Reference*, 03-300437.

Table 118: DHCP server CLI commands

Root level command	First level command	Second level command	Description
<code>clear ip dhcp-server binding</code>			Delete IP address binding
<code>clear ip dhcp-server statistics</code>			Clear the statistics of the DHCP server
<code>ip dhcp activate pool</code>			Activate configured DHCP pools
<code>ip dhcp ping packets</code>			Enable the sending of a ping packet by the DHCP server to check if the IP address it is about to allocate is already in use by another client
<code>ip dhcp ping timeout</code>			Set the time the DHCP server waits for a reply to a sent ping packet before allocating an IP address to a DHCP client
<code>ip dhcp pool</code>			Create a DHCP pool
	<code>bootfile</code>		Provide startup parameters for the DHCP client device
	<code>client-identifier</code>		Reserve the pool's IP address for assignment to a specific client
	<code>default-router</code>		Set up to eight default router IP addresses in order of preference
	<code>dns-server</code>		Set up to eight Domain Name Server (DNS) IP addresses
	<code>domain-name</code>		Set a domain name string for the client

Table 118: DHCP server CLI commands (continued)

Root level command	First level command	Second level command	Description
	<b>end-ip-addr</b>		Set the end IP address of the range of available IP addresses that the DHCP server may assign to clients
	<b>lease</b>		Configure the lease period for IP address assignment
	<b>name</b>		Configure the pool's name
	<b>next-server</b>		Specify the IP address of the next server in the boot process of a DHCP client
	<b>option</b>		Enter the context of a DHCP option
		<b>name</b>	Configure a name for the DHCP option
		<b>value</b>	Enter the option data type and the option data
	<b>server-name</b>		Specify the optional server name in the boot process of a DHCP client
	<b>show ip dhcp-pool</b>		Display DHCP pool configurations
	<b>start-ip-addr</b>		Set the start IP address of the range of available IP addresses that the DHCP server may assign to clients
	<b>subnet-mask</b>		Configure the subnet mask of the pool
	<b>vendor-specific-option</b>		Create a vendor-specific option with a unique index
		<b>name</b>	Name the vendor-specific option
		<b>class-identifier</b>	Set a vendor-specific identifier
		<b>value</b>	Set the data type and value of the vendor-specific option

2 of 3

Table 118: DHCP server CLI commands (continued)

Root level command	First level command	Second level command	Description
<code>ip dhcp-server</code>			Activate DHCP server
<code>show ip dhcp-server bindings</code>			Display bindings
<code>show ip dhcp-server statistics</code>			Display DHCP server statistic

---

**3 of 3**

---

## Configuring broadcast relay

When you configure broadcast relay, the router forwards broadcast packets across interfaces. You can configure broadcast relay types including directed broadcast forwarding, NetBIOS rebroadcast, and DHCP and BOOTP client broadcast.

For more information about DHCP and BOOTP client broadcast, see [Configuring DHCP and BOOTP relay](#) on page 467.

---

## Directed broadcast forwarding

A directed broadcast is an IP packet whose destination address is the broadcast address of a network or subnet. A directed broadcast causes every host on the network to respond. You can use directed broadcasts to obtain a list of all active hosts on the network. A hostile user can exploit directed broadcasts to launch a denial-of-service attack on the network. For each interface on the Avaya G450 Media Gateway, you can configure whether the G450 forwards directed broadcast packets to the network address or subnet mask address of the interface.

Enter `ip directed-broadcast` to enable directed broadcast forwarding on an interface. Use the `no` form of this command to disable directed broadcast forwarding on an interface.



---

## NetBIOS rebroadcast

Network Basic Input Output System (NetBIOS) is a protocol for sharing resources among desktop computers on a LAN. You can configure the Avaya G450 Media Gateway to relay NetBIOS UDP broadcast packets. This feature is used for applications such as WINS that use broadcast but might need to communicate with stations on other subnetworks or VLANs.

Configuration is performed on a per-interface basis. A NetBIOS broadcast packet arrives from an interface on which NetBIOS rebroadcast is enabled. The packet is distributed to all other interfaces configured to rebroadcast NetBIOS.

If the NetBIOS packet is a net-directed broadcast, for example, 149.49.255.255, the packet is relayed to all other interfaces on the list, and the IP destination of the packet is replaced by the appropriate interface broadcast address.

If the NetBIOS broadcast packet is a limited broadcast, for example, 255.255.255.255, it is relayed to all VLANs on which there are NetBIOS-enabled interfaces. In that case, the destination IP address remains the limited broadcast address.

Enter `ip netbios-rebroadcast both` to enable NetBIOS rebroadcasts on an interface. Enter `ip netbios-rebroadcast disable` to disable NetBIOS rebroadcasts on an interface.

---

## Summary of broadcast relay commands

For more information about these commands, see *Avaya G450 CLI Reference*, 03-300437.

**Table 119: Broadcast relay CLI commands**

Root level command	Command	Description
<code>interface</code> ( <code>dialer</code>   <code>fastethernet</code>   <code>serial</code>   <code>tunnel</code>   <code>vlan</code> )		Enter the Dialer, FastEthernet, Serial, Tunnel, or VLAN interface context
	<code>ip</code> <code>directed-broadcast</code>	Enable or disable directed broadcast forwarding on the interface
	<code>ip</code> <code>netbios-rebroadcast</code>	Enable or disable NetBIOS rebroadcasts on the interface

## Configuring the ARP table

When you configure the Address Resolution Protocol (ARP) table, you can:

- View information about the ARP table
- Add entries to the ARP table
- Delete entries from the ARP table
- Configure the ARP timeout

**Note:**

To change an entry in the ARP table, delete the entry and reinsert it with revised parameters.

---

## Overview of ARP

IP logical network addresses are independent of physical addresses. The physical address must be used to convey data in the form of a frame from one device to another. Therefore, a mechanism is required to acquire a destination device hardware address from its IP address. This mechanism is called ARP.

---

## The ARP table

The ARP table stores pairs of IP and MAC addresses. This storage saves time and communication costs, since the host looks in the ARP table first when transmitting a packet. If the information is not there, then the host sends an ARP Request.

There are two types of entries in the ARP table:

- Static ARP table entries
- Dynamic ARP table entries

Static ARP table entries do not expire. You add static ARP table entries manually using the **arp** command. For example, to add a static ARP table entry for station 192.168.7.8 with MAC address 00:40:0d:8c:2a:01, use the following command:

```
G450-001# arp 192.168.7.8 00:40:0d:8c:2a:01
```

Dynamic ARP table entries are mappings between IP addresses and MAC addresses that the switch used recently. Dynamic ARP table entries expire after a configurable amount of time. The following diagram shows how a switch adds dynamic ARP table entries:

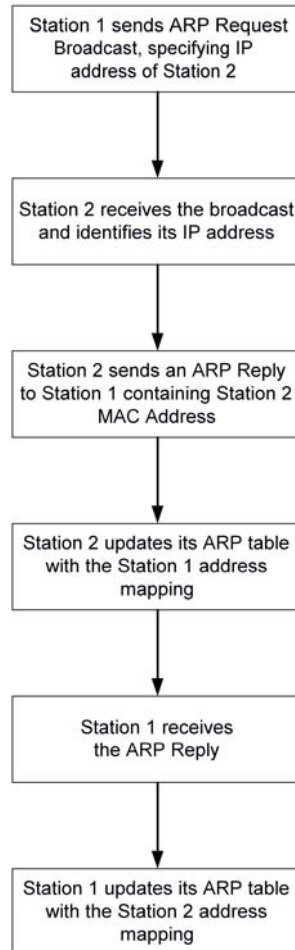

Use the **no arp** command to remove static and dynamic entries from the ARP table. For example, to remove the ARP table entry for the station 192.168.13.76:

```
G450-001# no arp 192.168.13.76
```

---

## ARP table commands

Use the following commands to configure the ARP table. For more information about these commands, see *Avaya G450 CLI Reference*, 03-300437.

- Use the **arp** command to add a permanent entry to the ARP table. Use the **no** form of this command to remove either a static entry or a dynamically learned entry from the ARP table.
- Use the **arp timeout** command to configure the amount of time, in seconds, that an entry remains in the ARP table. Entering the **arp timeout** command without a time parameter will display the current timeout value. Use the **no** form of this command to restore the default value (four hours).
- Use the **clear arp-cache** command to delete all dynamic entries from the ARP table and the IP route cache.
- Use the **ip max-arp-entries** command to specify the maximum number of ARP table entries allowed in the ARP table. Use the **no** form of this command to restore the default value.
- Use the **show ip arp** command to display a list of the ARP resolved MAC to IP addresses in the ARP table.
- Use the **show ip reverse-arp** command to display the IP address of a host, based on a known MAC address.

---

## Summary of ARP table commands

For more information about these commands, see *Avaya G450 CLI Reference*, 03-300437.

**Table 120: ARP table CLI commands**

Command	Description
<b>arp</b>	Add a permanent entry to the ARP table
<b>arp timeout</b>	Configure the amount of time, in seconds, that an entry remains in the ARP table
<b>clear arp-cache</b>	Delete all dynamic entries from the ARP table and the IP route cache
<b>ip max-arp-entries</b>	Specify the maximum number of ARP table entries allowed in the ARP table

**1 of 2**

Table 120: ARP table CLI commands (continued)

Command	Description
<code>show ip arp</code>	Display a list of the ARP resolved MAC to IP addresses in the ARP table
<code>show ip reverse-arp</code>	Display the IP address of a host, based on a known MAC address
<b>2 of 2</b>	

---

## Enabling proxy ARP

The G450 supports proxy ARP. Proxy ARP is a technique by which a router provides a false identity when answering ARP requests intended for another device. By falsifying its identify, the router accepts responsibility for routing packets to their true destination.

Proxy ARP can help devices on a subnet to reach remote subnets without the need to configure routing or a default gateway.

To enable proxy ARP on a G450 interface, enter `ip proxy-arp`. Use the `no` form of this command to disable proxy ARP on an interface.

---

## Summary of Proxy ARP commands

For more information about these commands, see *Avaya G450 CLI Reference*, 03-300437.

Table 121: Proxy ARP CLI commands

Root level command	Command	Description
<code>interface (fastethernet   vlan)</code>		Enter the <code>FastEthernet</code> or <code>VLAN</code> interface context
	<code>ip proxy-arp</code>	Enable proxy ARP on a G450 interface

## Configuring ICMP errors

You can control whether the router sends Internet Control Message Protocol (ICMP) error messages. The router sends an ICMP error message to the source of a packet if the router rejects the packet. Use the following commands to configure ICMP errors:

- Enter **ip icmp-errors** to set ICMP error messages to on. Use the **no** form of this command to set ICMP error messages to off.
- Enter **show ip icmp** to display the status (enabled or disabled) of ICMP error messages.

---

## Summary of ICMP errors commands

For more information about these commands, see *Avaya G450 CLI Reference*, 03-300437.

**Table 122: ICMP errors CLI commands**

Command	Description
<b>ip icmp-errors</b>	Set ICMP error messages to ON or OFF
<b>show ip icmp</b>	Display the status (enabled or disabled) of ICMP error messages

---

## Configuring RIP

The Routing Information Protocol (RIP) enables routers to compute the path that an IP packet should follow. Routers exchange routing information using RIP to determine routes that other routers are connected to. OSPF is a newer protocol that serves a similar purpose. For more information about OSPF, see [Configuring OSPF](#) on page 492.

You can configure route redistribution between OSPF, RIP, and static routes. With route redistribution, you can configure the G450 to redistribute routes learned from one protocol into the domain of the other routing protocol. For more information, see [Route redistribution](#) on page 497.

RIP is a distance vector protocol. The router decides which path to use on distance or the number of intermediate hops. In order for this protocol to work correctly, all the routers, and possibly the nodes, need to gather information on how to reach each destination in the Internet. However the very simplicity of RIP has a disadvantage. This protocol does not take into account network bandwidth, physical cost, and data priority. The Avaya G450 Media Gateway supports two versions of RIP:

- [RIPv1](#)
- [RIPv2](#)

## RIPv1

RIPv1 is the original version of the RIP protocol. The RIPv1 protocol imposes some limitations on the network design with regard to subnetting. When operating RIPv1, you must not configure variable length subnetwork masks (VLSM). Each IP network must have a single mask, implying that all subnetworks in a given IP network are of the same size. Also, when operating RIPv1, you must not configure supernets. RIPv1 is defined in RFC 1058.

## RIPv2

RIPv2 is a newer version of the RIP routing protocol. RIPv2 solves some of the problems associated with RIPv1. The most important change in RIPv2 is the addition of a **subnetwork mask** field which allows RIPv2 to support variable length subnetworks. RIPv2 also includes an authentication mechanism similar to the one used in OSPF. RIPv2 is defined in RFC 2453. [Table 123](#) summarizes the differences between RIPv1 and RIPv2.

**Table 123: RIPv1 vs. RIPv2**

RIPv1	RIPv2
Broadcast addressing	Multicast addressing
Timer-based – updated every 30 seconds	Timer-based – updated every 30 seconds
Fixed subnetwork masks	VLSM support – subnet information transmitted
No security	Security (authentication)
No provision for external protocols	Provision for EGP/BGP (Route tag)

## Preventing routing loops in RIP

You can use the following features in RIP to help avoid routing loops:

- Split-horizon
- Poison-reverse

## Configuring the router

The split-horizon technique prevents information about routes from exiting the router interface through which the information was received. This prevents small routing loops. Enter **ip rip split-horizon** to enable the split-horizon mechanism. Use the **no** form of this command to disable the split-horizon mechanism. By default, split-horizon is enabled.

Poison-reverse updates explicitly indicate that a network or subnet is unreachable. Poison-reverse updates are sent to defeat large routing loops. Enter **ip rip poison-reverse** to enable split-horizon with poison-reverse on an interface. Use the **no** form of this command to disable the poison-reverse mechanism.

---

## RIP distribution access lists

RIP distribution access lists consist of rules that specify how a router distributes and accepts RIP routing information from other routers. Before sending an update, the router consults an access list to determine if it should include specific routes in the update. When receiving an update, the router first checks a set of rules which apply to incoming updates to determine if it should insert those routes into its routing table. You can assign the rules per interface and per direction.

Up to 99 RIP distribution access lists can be configured on the Avaya G450 Media Gateway.

For example, to configure RIP distribution access list number 10 permitting distribution and learning of network 10.10.0.0, do the following:

1. Enter the command: **ip distribution access-list 10 1 permit 10.10.0.0 0.0.255.255**

The default action of the access list is deny and can be changed using the **ip distribution access-default-action** command.

### Note:

Whenever at least one permit rule exists, distributing and learning of all the remaining networks is denied, unless specifically permitted by another rule.

2. Apply the distribution access list created in Step 1 by performing the following procedure within the Router RIP context:
  - Enter the **distribution-list 10 in** command to apply list number 10 created in Step 1 on all updates received on all interfaces.
  - Enter the **distribution-list 10 in FastEthernet 10/2** command to apply Access List 10 on updates received on interface 'FastEthernet 10/2'.
  - Enter the **distribution-list 10 out** command to apply Access List 10 to all advertised updates.
  - Enter the **distribution-list 10 out ospf** command to apply Access List 10 to all advertised updates that were learned from OSPF (redistributed from OSPF into RIP).



If no distribution access list is defined, learning and advertising is allowed for all of the routing information. This is the default.

---

## RIP limitations

Configuration of RIPv1 and RIPv2 is per IP interface. Configuration must be homogeneous on all routers on each subnetwork. That is, RIPv1 and RIPv2 routers should not be configured on the same subnetwork. However, you can configure different IP interfaces of the G450 with different RIP versions. This configuration is valid as long as all routers on the subnet are configured with the same version.

RIPv2 and RIPv1 are considered the same protocol with regard to redistribution to and from OSPF and static route preferences.

---

## RIP commands

Use the following commands to configure RIP. For more information about these commands, see *Avaya G450 CLI Reference*, 03-300437.

- Use the **default-metric** command to set the interface RIP route metric value. Use the **no** form of this command to restore the default value.
- Use the **distribution-list** command to apply a distribution access list for incoming or outgoing routing information in route updates. Use the **no** form of this command to deactivate the list.
- Use the **ip rip authentication key** command to set the authentication string used on the interface. Use the **no** form of this command to clear the password.
- Use the **ip rip authentication mode** command to specify the type of authentication used in RIP v2 packets. Use the **no** form of this command to restore the default value, **none**.
- Use the **ip rip default-route-mode** command to enable learning of the default route received by the RIP protocol. The default state is **talk-listen**. Use the **no** form of this command to disable listening to default routes.
- Enter **ip rip poison-reverse** to enable split-horizon with poison-reverse on an interface. Use the **no** form of this command to disable the poison-reverse mechanism.
- Use the **ip rip rip-version** command to specify the RIP version running on the interface.
- Use the **ip rip send-receive-mode** command to set the RIP send and receive modes on an interface. Use the **no** form of this command to set the RIP to **talk**, that is, to send reports.

## Configuring the router

- Enter **ip rip split-horizon** to enable the split-horizon mechanism. Use the **no** form of this command to disable the split-horizon mechanism. By default split-horizon is enabled.
- Use the **network** command to specify a list of networks on which the RIP is running. Use the **no** form of this command to remove an entry from the list of networks.
- Use the **redistribute** command to redistribute routing information from other protocols into RIP. Use the **no** form of this command to restore the default value, disable redistribution by RIP.
- Enter **router rip** to enable RIP and to enter the router configuration context. Use the **no** form of this command to restore the default value, disabling RIP.
- Use the **timers basic** command to set RIP timers. Use the **no** form of this command to set the RIP timers to their default values.

---

## Summary of RIP commands

For more information about these commands, see *Avaya G450 CLI Reference*, 03-300437.

**Table 124: RIP CLI commands**

Root level command	Command	Description
<code>ip distribution access-default-action</code>		Set the default action for a specific RIP distribution access list
<code>ip distribution access-list</code>		Create a RIP distribution access list
<code>ip distribution access-list-cookie</code>		Set the access list cookie
<code>ip distribution access-list-copy</code>		Copy the distribution access list
<code>ip distribution access-list-name</code>		Set the name of the distribution list
<code>ip distribution access-list-owner</code>		Set the owner of the distribution list
<code>interface (dialer fastethernet   loopback serial vlan   tunnel)</code>		Enter the Dialer, FastEthernet, Loopback, Serial, Tunnel, or VLAN interface context

---

**1 of 3**

Table 124: RIP CLI commands (continued)

Root level command	Command	Description
	<b>ip rip authentication key</b>	Set the authentication string used on the interface
	<b>ip rip authentication mode</b>	Specify the type of authentication used in RIP v2 packets
	<b>ip rip default-route-mode</b>	Enable learning of the default route received by the RIP protocol. The default state is talk-listen.
	<b>ip rip poison-reverse</b>	Enable or disable split-horizon with poison-reverse on an interface
	<b>ip rip rip-version</b>	Specify the RIP version running on the interface
	<b>ip rip send-receive-mode</b>	Set the RIP send and receive modes on an interface
	<b>ip rip split-horizon</b>	Enable or disable the split-horizon mechanism
<b>router rip</b>		Enable the RIP and enter the router configuration context or disable the RIP
	<b>default-metric</b>	Set or reset the interface RIP route metric value
	<b>distribution-list</b>	Apply a distribution access list for incoming or outgoing routing information in route updates or deactivate the list
	<b>network</b>	Specify a list of networks on which the RIP is running
	<b>redistribute</b>	Redistribute routing information from other protocols into RIP
	<b>timers basic</b>	Set RIP timers

2 of 3

Table 124: RIP CLI commands (continued)

Root level command	Command	Description
<code>show ip distribution access-lists</code>		Display the contents of all current distribution lists or of a specific list
<code>show ip protocols</code>		Display parameters and statistics of a given IP routing protocol
		<b>3 of 3</b>

---

## Configuring OSPF

The Open Shortest Path First (OSPF) protocol enables routers to compute the path that an IP packet should follow. Routers exchange routing information with OSPF to determine where to send each IP packet on its next hop. RIP is an older protocol that serves a similar purpose. For more information about RIP, see [Configuring RIP](#) on page 486.

OSPF is based on the shortest-path-first or link-state algorithm. It was introduced to overcome the limitations of RIP in increasingly complex network designs. OSPF uses the cost of a path as the criterion for comparing paths. In contrast, RIP uses the number of hops as the criterion for comparing paths. Also, updates are sent when there is a topological change in the network, rather than every 30 seconds as with RIP.

The advantage of shortest-path-first algorithms is that under stable conditions, there are less frequent updates (thereby saving bandwidth). They converge quickly, thus preventing such problems as routing loops and Count-to-Infinity, when routers continuously increment the hop count to a particular network. These algorithms make a stable network. The disadvantage of shortest-path-first algorithms is that they require a lot of CPU power and memory.

In OSPF, routers use link-state updates to send routing information to all nodes in a network by calculating the shortest path to each node. This calculation is based on a topography of the network constructed by each node. Each router sends that portion of the routing table that describes the state of its own links, and it also sends the complete routing structure (topography).

You can configure route redistribution between OSPF, RIP, and static routes. With route redistribution, you can configure the G450 to redistribute routes learned from one protocol into the domain of the other routing protocol. For more information, see [Route redistribution](#) on page 497.

---

## OSPF dynamic Cost

An OSPF interface on the G450 can dynamically set a Cost. The Cost represents the price assigned to each interface for purposes of determining the shortest path.

By default the OSPF interface Cost is calculated based on the interface bandwidth, according to the following formula:

$$\text{Cost} = 100,000 / \text{bandwidth (in kbps)}$$

The result is that the higher the bandwidth, the lower the Cost.

To manually configure the Cost of an OSPF interface, use the **ip ospf cost** command from the interface context. By using this option, dynamic bandwidth updates do not change the Cost. Use the **no ip ospf cost** command to return to dynamic cost calculation on an interface.

Use the **bandwidth** command from the Interface context to manually adjust the interface's bandwidth. If Cost is being determined dynamically, it is this configured bandwidth and not the actual interface bandwidth which is used to calculate Cost.

---

## OSPF limitations

You can configure the G450 as an OSPF Autonomous System Boundary Router (ASBR) using route redistribution. The G450 can be installed in the OSPF backbone area (area 0.0.0.0) or in any OSPF area that is part of a multiple areas network. However, the G450 cannot be configured to be an OSPF area border router itself.

The G450 supports the ECMP equal-cost multipath (ECMP) feature which allows load balancing by splitting traffic between several equivalent paths.

While you can activate OSPF with default values for each interface using a single command, you can configure many of the OSPF parameters.

---

## OSPF commands

Use the following commands to configure OSPF. For more information about these commands, see *Avaya G450 CLI Reference*, 03-300437.

- Use the **area** command to configure the OSPF area ID of the router. Use the **no** form of the command to delete the OSPF area id.
- Use the **default-metric** command to set the interface OSPF route metric value. Use the **no** form of this command to restore the default value.
- Use the **ip ospf authentication** command to specify the authentication type for an interface. Use the **no** form of this command to remove the authentication type for an interface.

## Configuring the router

- Use the **ip ospf authentication-key** command to configure the interface authentication password. Use the **no** form of this command to remove the OSPF password.
- Use the **ip ospf cost** command to configure the interface metric. Use the **no** form of this command to set the cost to its default value.
- Use the **ip ospf dead-interval** command to configure the interval before declaring the neighbor as dead. Use the **no** form of this command to set the dead-interval to its default value.
- Use the **ip ospf hello-interval** command to specify the time interval between hello packets sent by the router. Use the **no** form of this command to set the hello-interval to its default value.
- Use the **ip ospf message-digest-key** command to specify the message-digest key for an interface. This command enables OSPF MD5 authentication. Use the **no** form of the command to remove an old MD5 key.
- Use the **ip ospf network point-to-multipoint** command to specify the network type for the interface. Use the **no** form of the command to return the interface to the default value.
- Use the **ip ospf priority** command to configure interface priority used in Designated Router election. Use the **no** form of this command to set the OSPF priority to its default value.
- Use the **ip ospf router-id** command to configure the router ID. Use the **no** form of this command to return the router ID to its default value.
- Use the **network** command to enable OSPF in a network. Use the **no** form of this command to disable OSPF in a network. The default value is disabled.
- Use the **passive-interface** command to suppress OSPF routing updates on an interface. This is used to allow interfaces to be flooded into the OSPF domain as OSPF routes rather than external routes.

### Note:

You must also use the **network** command, in conjunction with the **passive-interface** command, to make the network passive.

- Use the **redistribute** command to redistribute routing information from other protocols into OSPF. Use the **no** form of this command to disable redistribution by OSPF.
- Enter **router ospf** to enable OSPF protocol on the system and to enter the router configuration context. Use the **no** form of this command to restore the default value, disable OSPF globally.
- Enter **show ip ospf** to display general information about OSPF routing.
- Use the **show ip ospf database** command to display lists of information related to the OSPF database for a specific router.
- Use the **show ip ospf interface** command to display the OSPF-related interface information.

- Use the **show ip ospf neighbor** command to display OSPF neighbor information on a per-interface basis.
- Use the **show ip protocols** command to display OSPF parameters and statistics.
- Use the **timers spf** command to configure the delay between runs of OSPFs (SPF) calculation. Use the **no** form of this command to restore the default value.

---

## Summary of OSPF commands

For more information about these commands, see *Avaya G450 CLI Reference*, 03-300437.

**Table 125: OSPF CLI commands**

Root level command	Command	Description
<b>interface (dialer fastethernet   loopback   serial   tunnel   vlan)</b>		Enter the Dialer, FastEthernet, Loopback, Serial, Tunnel, or VLAN interface context
	<b>bandwidth</b>	Set the bandwidth parameter manually for this interface
	<b>ip ospf authentication</b>	Specify the authentication type for an interface
	<b>ip ospf authentication-key</b>	Configure the interface authentication password
	<b>ip ospf cost</b>	Configure the Cost of an OSPF interface, for the purpose of determining the shortest path
	<b>ip ospf dead-interval</b>	Configure the interval before declaring the neighbor as dead
	<b>ip ospf hello-interval</b>	Specify the time interval between hello packets sent by the router
	<b>ip ospf message-digest-key</b>	Specify the message-digest key for the interface and enable OSPF MD5 authentication
	<b>ip ospf network point-to-multipoint</b>	Specify the network type for the interface
	<b>ip ospf priority</b>	Configure interface priority used in Designated Router election

1 of 2

Table 125: OSPF CLI commands (continued)

Root level command	Command	Description
<code>ip ospf router-id</code>		Configure the router ID
<code>router ospf</code>		Enable OSPF protocol on the system and to enter the router configuration context
	<code>area</code>	Configure the OSPF area ID of the router
	<code>default-metric</code>	Set the interface OSPF route metric value
	<code>network</code>	Enable OSPF in a network
	<code>passive-interface</code>	Suppress OSPF routing updates on an interface
	<code>redistribute</code>	Redistribute routing information from other protocols into OSPF
	<code>timers spf</code>	Configure the delay between runs of OSPFs (SPF) calculation
<code>show ip ospf</code>		Display general information about OSPF routing
<code>show ip ospf database</code>		Display lists of information related to the OSPF database for a specific router
<code>show ip ospf interface</code>		Display the OSPF-related interface information
<code>show ip ospf neighbor</code>		Display OSPF neighbor information on a per-interface basis
<code>show ip protocols</code>		Display OSPF parameters and statistics



---

## Route redistribution

Route redistribution is the interaction of multiple routing protocols. OSPF and RIP can be operated concurrently in the G450. In this case, you can configure the G450 to redistribute routes learned from one protocol into the domain of the other routing protocol. Similarly, static routes can be redistributed to RIP and OSPF.

**Note:**

Take care when you configure route redistribution. It involves metric changes and might cause routing loops in the presence of other routes with incompatible schemes for route redistribution and route preferences.

The G450 scheme for metric translation in route redistribution is as follows:

- Static to RIP metric configurable (default 1)
- OSPF internal metric N to RIP metric (default 1)
- OSPF external type 1 metric N to RIP metric (default 1)
- OSPF external type 2 metric N to RIP metric (default 1)
- Static to OSPF external type 2, metric configurable (default 20)
- RIP metric N to OSPF external type 2, metric (default 20)
- Direct to OSPF external type 2, metric (default 20)

By default, the G450 does not redistribute routes between OSPF and RIP. Redistribution from one protocol to the other can be configured. Static routes are, by default, redistributed to RIP and OSPF. The G450 allows the user to globally disable redistribution of static routes to RIP, and separately to globally disable redistribution of static routes to OSPF. In addition you can configure, on a per static route basis, whether the route is to be redistributed to RIP and OSPF, and what metric to use (in the range of 1-15). The default state is to allow the route to be redistributed at metric 1. When static routes are redistributed to OSPF, they are always redistributed as external type 2.

Use the **redistribute** command in the Router RIP context to configure route redistribution into RIP. Use the **redistribute** command in the Router OSPF context to configure route redistribution into OSPF.

---

## Export default metric

The Avaya G450 Media Gateway enables you to configure the metric to be used in updates that are redistributed from one routing protocol to another.

In RIP, the default is 1 and the maximum value is 16. In OSPF, the default is 20.

## Configuring the router

Set the default metric value before redistribution, using the **default-metric** command from within the Router RIP or Router OSPF contexts. This value is used for all types of redistributed routes, regardless of the protocol from which the route was learned.

---

## Summary of route redistribution commands

For more information about these commands, see *Avaya G450 CLI Reference*, 03-300437.

**Table 126: Route redistribution CLI commands**

Root level command	Command	Description
<b>router ospf</b>		Enable OSPF and enter the router configuration context
	<b>redistribute</b>	Redistribute routing information from other protocols into OSPF
	<b>default-metric</b>	Configure the metric to be used in updates that are redistributed from one routing protocol to another
<b>router rip</b>		Enable RIP and enter the router configuration context
	<b>redistribute</b>	Redistribute routing information from other protocols into RIP
	<b>default-metric</b>	Configure the metric to be used in updates that are redistributed from one routing protocol to another

---

## Configuring VRRP

Virtual Router Redundancy Protocol (VRRP) is an IETF protocol designed to support redundancy of routers on the LAN and load balancing of traffic. VRRP is open to host stations, making it an ideal option when redundancy, load balancing, and ease of configuration are required.

The concept underlying VRRP is that a router can back up other routers, in addition to performing its primary routing functions. This redundancy is achieved by introducing the concept of a virtual router. A virtual router is a routing entity associated with multiple physical routers. One of the physical routers with which the virtual router is associated performs the routing functions. This router is known as the master router. For each virtual router, VRRP selects a master router. If the selected master router fails, another router is selected as master router.

In VRRP, two or more physical routers can be associated with a virtual router, thus achieving extreme reliability. In a VRRP environment, host stations interact with the virtual router. The stations are not aware that this router is a virtual router, and are not affected when a new router takes over the role of master router. Thus, VRRP is fully interoperable with any host station.

You can activate VRRP on an interface using a single command while allowing for the necessary fine-tuning of the many VRRP parameters. For a detailed description of VRRP, see VRRP standards and published literature.

## VRRP configuration example

[Figure 42](#) illustrates an example of a VRRP configuration:

**Figure 42: VRRP configuration example**

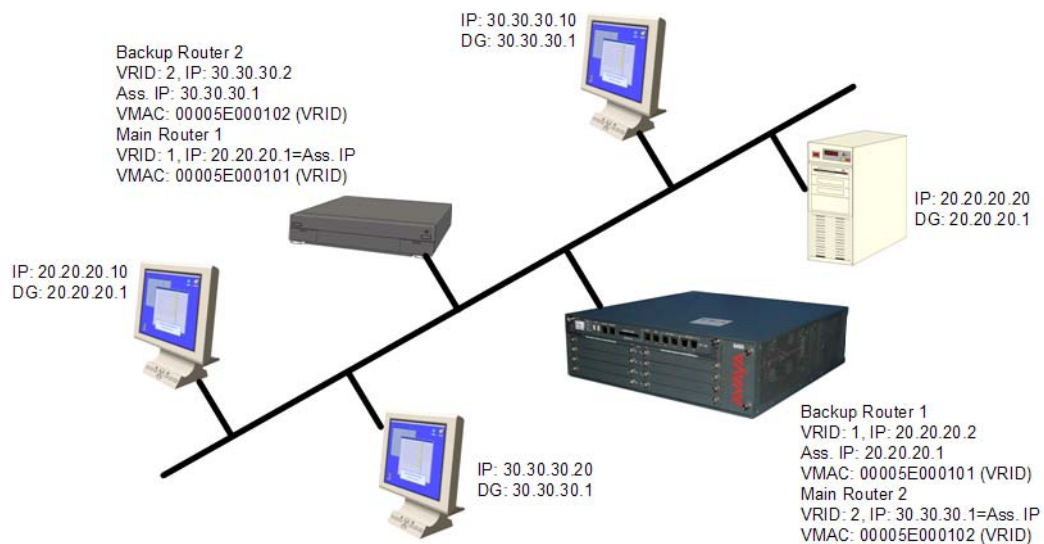

## Configuring the router

There is one main router on IP subnet 20.20.20.0, such as a G450, C363T, C364T, or any router that supports VRRP, and a backup router. You can configure more backup routers.

- The G450 itself must have an interface on the IP subnetwork, for example, 20.20.20.2
- Configure all the routers under the same VRID, for example, 1. You must configure the routers per VLAN.
- An assigned VRID must not be used in the network, even in a different VLAN
- When router configuration is complete and the network is up, the main router for each virtual router is selected according to the following order of preference:
  - The virtual router IP address is also the router's interface IP address
  - It has the highest priority (you can configure this parameter)
  - It has the highest IP address if the previous conditions do not apply
- The virtual router IP address needs to be configured as the default gateway on the stations
- The Main router advertises a six-byte Virtual MAC address, in the format 00.00.5E.00.01.02 VRID, as a response to the stations' ARP requests
- The redundant router uses a VRRP polling protocol to check the Main router integrity at one-second intervals (default). Otherwise, it is idle.
- If the Main router fails, the redundant router that does not receive a response from four consecutive polling requests (default) takes over and starts to advertise the same Virtual MAC for ARP requests. Therefore, the stations will not detect any change either in the configured default gateway or at the MAC level.
- VRRP has no provisions for routing database synchronization among the redundant routers. You must perform this manually, if needed.

---

## VRRP commands

Use the following commands to configure VRRP. For more information about these commands, see *Avaya G450 CLI Reference*, 03-300437.

- Use the **ip vrrp** command to create a virtual router on an interface. Use the **no** form of this command to delete a virtual router.
- Use the **ip vrrp address** command to assign an IP address to a virtual router. Use the **no** form of this command to remove an IP address from a virtual router.
- Use the **ip vrrp auth-key** command to set the virtual router simple password authentication key for the virtual router ID. Use the **no** form of this command to disable simple password authentication for the virtual router instance.
- Use the **ip vrrp override addr owner** command to accept packets addressed to the IP addresses associated with the virtual router, such as ICMP, SNMP, and telnet (if it is not the IP address owner). Use the **no** form of this command to discard these packets.

- Use the **ip vrrp preempt** command to configure a router to preempt a lower priority master for the virtual router ID. Use the **no** form of this command to disable preemption for a virtual router instance. By default, preemption is enabled.
- Use the **ip vrrp primary** command to set the primary address used as the source address of VRRP packets for the virtual router ID. Use the **no** form of this command to restore the default primary address for a virtual router instance. By default, the primary address is selected automatically by the device.
- Use the **ip vrrp priority** command to set the virtual router priority value used when selecting a master router. Use the **no** form of this command to restore the default value.
- Use the **ip vrrp timer** command to set the virtual router advertisement timer value for the virtual router ID. Use the **no** form of this command to restore the default value.
- Enter **router vrrp** to enable VRRP routing. Use the **no** form of this command to disable VRRP routing.
- Use the **show ip vrrp** command to display VRRP information.

---

## Summary of VRRP commands

For more information about these commands, see *Avaya G450 CLI Reference*, 03-300437.

**Table 127: VRRP CLI commands**

Root level command	Command	Description
<b>interface</b> ( <b>fastethernet</b>   <b>vlan</b> )		Enter the <code>FastEthernet</code> or <code>VLAN</code> interface configuration context
	<b>ip vrrp</b>	Create a virtual router on an interface
	<b>ip vrrp address</b>	Assign an IP address to a virtual router
	<b>ip vrrp auth-key</b>	Set the virtual router simple password authentication key for the virtual router ID
	<b>ip vrrp override addr owner</b>	Accept packets addressed to the IP addresses associated with the virtual router, such as ICMP, SNMP, and telnet (if it is not the IP address owner)
	<b>ip vrrp preempt</b>	Configure a router to preempt a lower priority master for the virtual router ID
		<b>1 of 2</b>

Table 127: VRRP CLI commands (continued)

Root level command	Command	Description
	<code>ip vrrp primary</code>	Set the primary address used as the source address of VRRP packets for the virtual router ID
	<code>ip vrrp priority</code>	Set the virtual router priority value used when selecting a master router
	<code>ip vrrp timer</code>	Set the virtual router advertisement timer value for the virtual router ID
<code>router vrrp</code>		Enable or disable VRRP routing globally
<code>show ip vrrp</code>		Display VRRP information
		<b>2 of 2</b>

---

## Configuring fragmentation

The G450 supports IP fragmentation and reassembly. The G450 router can fragment and reassemble IP packets according to RFC 791. This feature allows the router to send and receive large IP packets where the underlying data link protocol constrains the Maximum Transport Unit (MTU).

IP fragmentation involves breaking a datagram into a number of pieces that can be reassembled later. The IP source, destination, identification, total length, and fragment offset fields, along with the more fragment and don't fragment flags in the IP header, are used for IP fragmentation and reassembly.

IP fragmentation works as follows:

- Each IP packet is divided into fragments
- Each fragment becomes its own IP packet
- Each packet has same identifier, source, and destination address

Fragments are usually not reassembled until final destination. The G450 supports fragmentation of IP packets according to RFC 791, and reassembly of IP packets destined only to its interfaces.

---

## Fragmentation commands

Use the following commands to configure fragmentation and reassembly. For more information about these commands, see *Avaya G450 CLI Reference*, 03-300437.

- Enter **clear fragment** to clear the fragment database and restore its default values.
- Use the **fragment chain** command to set the maximum number of fragments that can comprise a single IP packet destined to the router. Use the **no** form of this command to set the fragment chain to its default value.
- Use the **fragment size** command to set the maximum number of fragmented IP packets destined to the router to reassemble at any given time. Use the **no** form of this command to set the fragment size to its default value.
- Use the **fragment timeout** command to set the maximum number of seconds to reassemble a fragmented IP packet destined to the router. Use the **no** form of this command to set the fragment timeout to its default value.
- Enter **fragment** to set the treatment for IP fragmentation packets entering on an interface.
- Enter **show fragment** to display information regarding fragmented IP packets that are destined to a router.

---

## Summary of fragmentation commands

For more information about these commands, see *Avaya G450 CLI Reference*, 03-300437.

**Table 128: Fragmentation CLI commands**

Command	Description
<b>clear fragment</b>	Clear the fragment database and restore its default values
<b>fragment chain</b>	Set the maximum number of fragments that can comprise a single IP packet destined to the router
<b>fragment size</b>	Set the maximum number of fragmented IP packets destined to the router to reassemble at any given time
<b>fragment timeout</b>	Set the maximum number of seconds to reassemble a fragmented IP packet destined to the router
<b>show fragment</b>	Display information regarding fragmented IP packets that are destined to a router





# Chapter 19: Configuring IPSec VPN

VPN (Virtual Private Network) defines a private secure connection between two nodes on a public network such as the Internet. VPN at the IP level is deployed using IP Security (IPSec). IPSec is a standards-based set of protocols defined by the IETF that provide privacy, integrity, and authenticity to information transferred across IP networks.

The standard key exchange method employed by IPSec uses the Internet Key Exchange (IKE) protocol to exchange key information between the two nodes (referred to as peers). Each peer maintains Security Associations (SAs) to maintain the private secure connection. IKE operates in two phases:

- The Phase-1 exchange negotiates an IKE SA
- The IKE SA created in Phase-1 secures the subsequent Phase-2 exchanges, which in turn generate IPSec SAs

IPSec SAs secure the actual traffic between the protected networks behind the peers, while the IKE SA only secures the key exchanges that generate the IPSec SAs between the peers.

The G450 IPSec VPN feature is designed to support site-to-site topologies, in which the two peers are gateways.

**Note:**

To configure IPSec VPN, you need at least a basic knowledge of IPSec. Refer to the following guide for a suitable introduction:

[http://www.tcpipguide.com/free/t\\_IPSecurityIPSecProtocols.htm](http://www.tcpipguide.com/free/t_IPSecurityIPSecProtocols.htm)

---

## Overview of IPsec VPN configuration

[Figure 43](#) summarizes the components you need to define and the order in which you need to define them. [Figure 44](#) describes the relationships among the various VPN components.

---

**Figure 43: IPsec VPN configuration model**

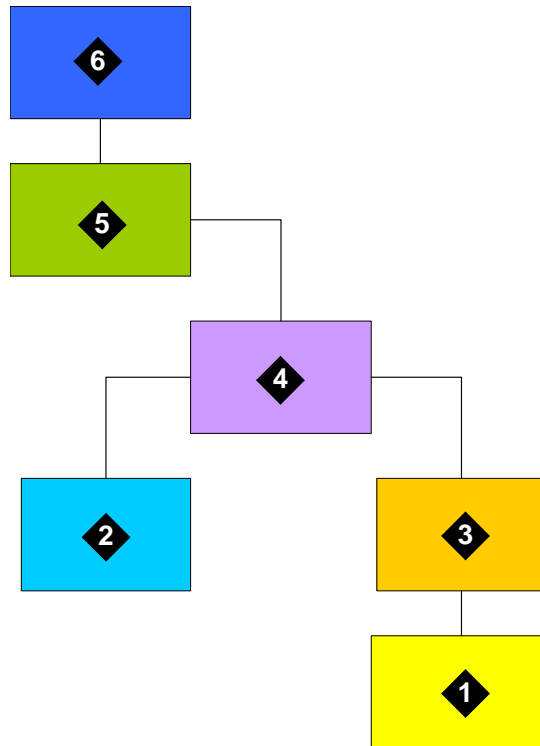

**Figure notes:**

- |                              |                |
|------------------------------|----------------|
| 1. ISAKMP Policy             | 4. Crypto Map  |
| 2. IPSEC Transform-set       | 5. crypto list |
| 3. ISAKMP Peer or Peer Group | 6. Interface   |

---

## Overview of IPsec VPN components

The basic IPsec VPN building blocks define how to secure packets, as follows:

- **ISAKMP policies.** Define parameters for IKE phase 1 negotiation
- **Transform-sets.** Define parameters for IKE phase 2 negotiation

Once the building blocks are defined, IPsec VPN is implemented using a crypto list. The crypto list defines, for the interface to which it applies, which packets should be secured and how, as follows:

Each rule in the crypto list points to a crypto-map. A crypto-map points to a transform-set, and to a peer or peer-group. The peer or peer-group, in turn, point to an ISAKMP policy.

[Figure 44](#) illustrates the relationships among the various IPsec VPN components:

**Figure 44: IPsec VPN components**

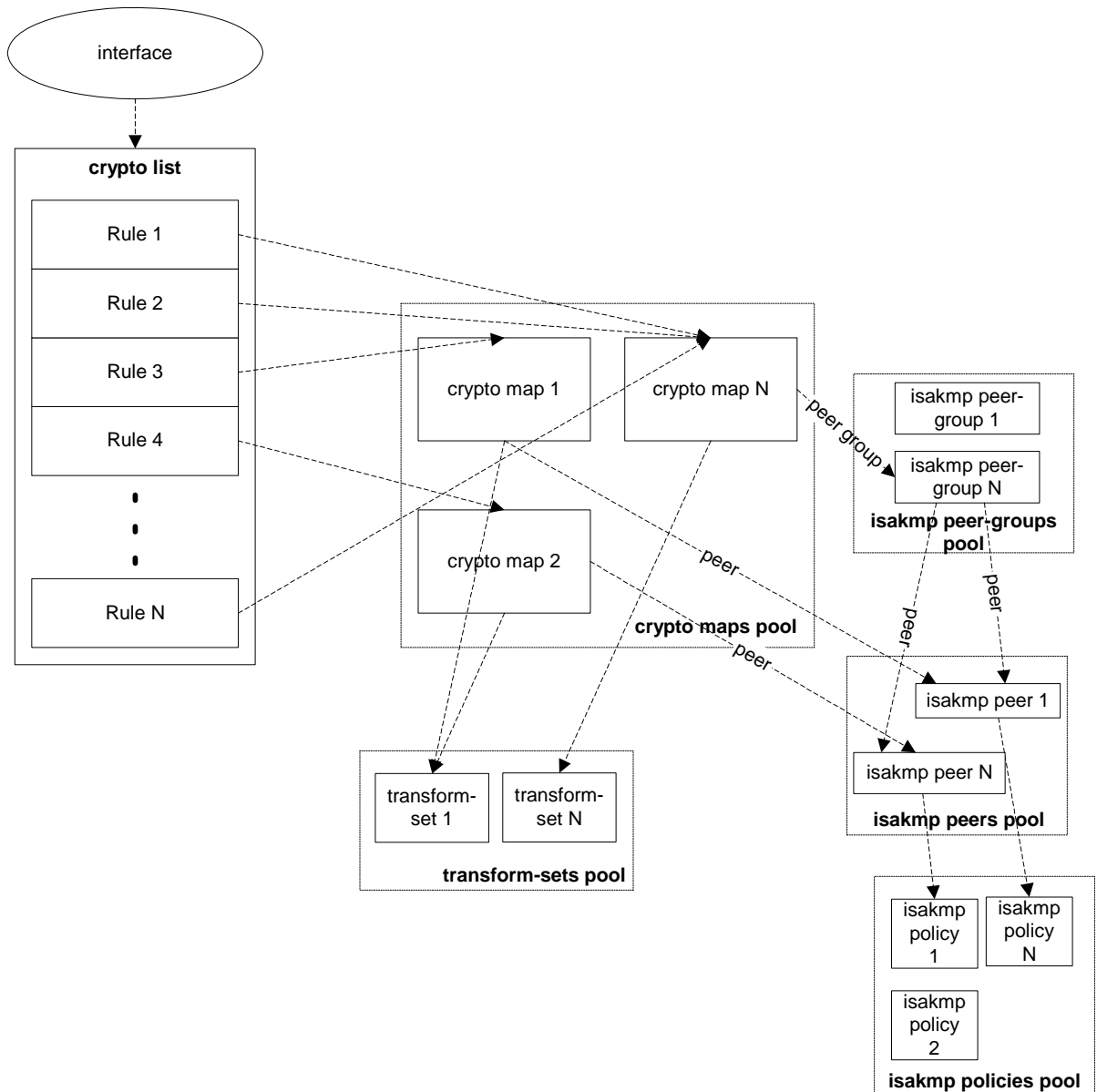

### Summary of configuration steps

The commands required to configure a VPN are listed below. For a step-by-step description of the VPN procedures, see [Configuring a site-to-site IPsec VPN](#) on page 510.

**Note:**

You must configure VPN in the order shown in the summary. Commands appearing in bold are mandatory.

- ISAKMP policy – [crypto isakmp policy](#)
  - description
  - authentication pre-share
  - encryption
  - hash
  - group
  - lifetime
- IPSEC transform-set – [crypto ipsec transform-set](#)
  - set pfs
  - set security-association lifetime seconds
  - set security-association lifetime kilobytes
    - mode (tunnel/transport)
- ISAKMP peer – [crypto isakmp peer](#)
  - description
  - **isakmp-policy**
  - **pre-shared-key**
  - initiate mode
  - self-identity
  - keepalive
  - keepalive-track
  - continuous-channel
- (Optional) ISAKMP peer group – [crypto isakmp peer-group](#)
  - description
  - set peer

- Crypto map – [crypto map](#)
  - description
  - **set transform-set**
    - **set peer Or set peer-group**
  - set dscp
  - continuous-channel
- IP crypto list – [ip crypto-list](#)
  - **local-address**
  - **ip-rule**
    - description
    - **source-ip**
    - **destination-ip**
    - **protect crypto map**
    - ip-protocol
    - tcp
    - udp
    - icmp
    - dscp
    - fragment
- Access control list – [ip access-control-list](#)
- [global parameters](#)
  - crypto isakmp invalid-spi-recovery
  - crypto ipsec nat-transparency udp-encapsulation
  - crypto isakmp nat keepalive
- [assigning a crypto-list to an interface](#)
  - crypto ipsec df-bit
  - crypto ipsec minimal-pmtu
  - **ip crypto-group**

---

## Configuring a site-to-site IPsec VPN

This section describes the procedures for VPN configuration.

---

### Installing the VPN license file

To enable IPsec VPN you must obtain and install a VPN license. For information on obtaining a VPN license, see *Installing and Upgrading the Avaya G450 Media Gateway*, 03-602054.

You can install the VPN license via FTP, TFTP, or SCP.

**Note:**

You must have admin permissions to install a VPN license.

1. Use one of the following commands:

- `copy ftp license-file filename ip`
- `copy tftp license-file filename ip`
- `copy scp license-file filename ip`

where:

- *filename* is the filename, including the full path
- *ip* is the IP address of the ftp/tftp/scp server

For example:

```
copy tftp license-file my_license_file.xml 198.87.134.153
```

2. Optionally, enter `show download license-file status` to view the status of the download process.
3. Enter `show license status` to verify that the license was installed.
4. Enter `copy running-config startup-config` to save your current configuration.
5. Reset using the `reset` command.

---

## Configuring IPsec VPN

### Prerequisites

As a prerequisite to configuring IPsec VPN, a valid VPN license must be installed on the G450. For details, see [Installing the VPN license file](#) on page 510.

## IPsec VPN configuration overview

To configure a site-to-site IPsec VPN, two devices (the G450 and a peer Gateway) must be configured symmetrically.

In some cases, you may wish to configure global VPN parameters (see [Configuring global parameters](#) on page 524).

**Note:**

In the following sections, all IPsec VPN parameters that you must configure are indicated as mandatory parameters. Non-mandatory VPN parameters have default values that are used unless otherwise set. Thus for example, although it is mandatory to define at least one ISAKMP policy, it is not mandatory to set the values for that ISAKMP policy since the G450 contains default ISAKMP policy settings.

---

## Coordinating with the VPN peer

Before commencing IPsec VPN configuration, you must resolve jointly with your VPN peer the basic parameters so that IPsec VPN can be set up symmetrically in the two peers. If the IPsec VPN configuration in the two peers does not match, no VPN is created.

**Note:**

If you will be defining a peer-group which maintains a list of redundant peers, each of the peers in the group must be configured to match the G450.

The basic parameters include:

- The IKE phase 1 parameters (as defined in the ISAKMP policy, see [Configuring ISAKMP policies](#) on page 512)
- The IKE phase 2 parameters (as defined in the transform-set, see [Configuring transform-sets](#) on page 513)
- The ISAKMP peer parameters (see [Configuring ISAKMP peer information](#) on page 514)
- Which packets should be secured (as defined in the crypto list, see [Configuring crypto lists](#) on page 520)
- The peer addresses. For each peer, the local address entered in the crypto list (see [Configuring crypto lists](#) on page 520) should match the ISAKMP peer address in the other peer (see [Configuring ISAKMP peer information](#) on page 514).
- NAT Traversal, if your installation includes one or more NAT devices between the local and remote VPN peers. See [Configuring global parameters](#) on page 524.

See [IPsec VPN logging](#) on page 528 for information on how to view IPsec VPN configuration in both peers so as to pinpoint the problem in case of a mismatch between the two peers.

---

## Configuring ISAKMP policies

An ISAKMP policy defines the IKE phase 1 parameters.

**⚠ Important:**

You must define at least one ISAKMP policy.

**Note:**

You can configure up to 40 ISAKMP policies.

1. Enter **crypto isakmp policy**, followed by an index number from 1 to 20, to enter the context of an ISAKMP policy list (and to create the list if it does not exist). For example:

```
G450-001# crypto isakmp policy 1
G450-001(config-isakmp:1)#
```

2. You can use the following commands to set the parameters of the ISAKMP policy:
  - Use the **description** command to assign a description to the ISAKMP policy.
  - Use the **authentication pre-share** command to set the authentication of ISAKMP policy to pre-shared secret.
  - Use the **encryption** command to set the encryption algorithm for the ISAKMP policy. Possible values are **des** (default), **3des**, **aes**, **aes-192** and **aes-256**.
  - Use the **hash** command to set the hash (authentication) algorithm for the ISAKMP policy. Possible values are **md5** and **sha** (default).
  - Use the **group** command to set the Diffie-Hellman group for the ISAKMP policy. Possible values are **1** (default), **2**, **5** and **14**.
  - Use the **lifetime** command to set the lifetime of the ISAKMP SA, in seconds. The range of values is 60-86,400 seconds (default is 86,400). For example:

```
G450-001(config-isakmp:1)# description "lincroft ike"
Done!
G450-001(config-isakmp:1)# authentication pre-share
Done!
G450-001(config-isakmp:1)# encryption des
Done!
G450-001(config-isakmp:1)# hash md5
Done!
G450-001(config-isakmp:1)# group 1
Done!
G450-001(config-isakmp:1)# lifetime 60000
Done!
```



- Exit the ISAKMP policy context with the **exit** command. For example:

```
G450-001(config-isakmp:1)# exit
G450-001#
```

---

## Configuring transform-sets

A transform-set defines the IKE phase 2 parameters. It specifies the encryption and authentication algorithms to be used, sets a security association lifetime, and specifies whether PFS is enabled and which DH group it uses. In addition, it specifies the IPsec VPN mode (tunnel or transport).



### Important:

You must define at least one transform-set.

### Note:

You can define up to 40 transform-sets.

- Use the **crypto ipsec transform-set** command to enter the context of a transform-set (and to create the transform-set if it does not exist). The command variables include:
  - The name of the transform-set
  - The encryption algorithm used by the transform-set. Possible values are `esp-des`, `esp-3des`, `esp-aes`, `esp-aes-192`, `esp-aes-256` and `esp-null` (no encryption).
  - The authentication algorithm used by the transform-set. Possible values are `esp-md5-hmac` and `esp-sha-hmac`.
  - The IP compression algorithm used by the transform-set. The only possible value is `comp-lzs`.

For example:

```
G450-001# crypto ipsec transform-set ts1 esp-3des esp-md5-hmac comp-lzs
G450-001(config-transform:ts1)#
```

- You can use the following commands to set the parameters of the transform-set:
  - Use the **set pfs** command to specify whether each IKE phase 2 negotiation employs Perfect Forward Secrecy (PFS), and if yes, which Diffie-Hellman group to employ. PFS ensures that even if someone were to discover the long-term secret(s), the attacker would not be able to recover the session keys, both past and present. In addition, the discovery of a session key compromises neither the long-term secrets nor the other session keys. The default setting is **no set pfs**.
  - Use the **set security-association lifetime seconds** command to set the security association lifetime in seconds.

## Configuring IPsec VPN

- Use the **set security-association lifetime kilobytes** command to set the security association lifetime in kilobytes.
- Use the **mode** command to set the IPsec mode (`tunnel` or `transport`). `Transport` mode does not add an additional IP header (i.e., a tunnel header), but rather uses the original packet's header. However, it can be used only when the VPN tunnel endpoints are equivalent to the original packet's source and destination IP addresses. This is generally the case when using GRE over IPsec. Note that `transport` mode cannot be used unless the remote VPN peer supports that mode and was configured to use it.

```
G450-001001(config-transform:ts1ts1)# set pfs group2
Done!
G450-001(config-transform:ts1)# set security-association lifetime seconds
7200
Done!
G450-001(config-transform:ts1)# set security-association lifetime
kilobytes 268435456
G450-001(config-transform:ts1)# mode tunnel
Done!
```

3. Exit the crypto transform-set context with the **exit** command.

```
G450-001(config-transform:ts1)# exit
G450-001#
```

---

## Configuring ISAKMP peer information

ISAKMP peer information defines the remote peer identification, the pre-shared key used for peer authentication, and the ISAKMP policy to be used for IKE phase 1 negotiations between the peers.

### Important:

It is mandatory to define at least one ISAKMP peer.

### Note:

You can define up to 100 ISAKMP peers.

1. Enter **crypto isakmp peer**, followed by the address of the ISAKMP peer or its Fully Qualified Domain Name (FQDN), to enter the context of an ISAKMP peer (and to create the peer if it does not exist).

### Note:

If you wish to specify the ISAKMP peer by its FQDN name, you must configure the G450 as a DNS client (see [DNS resolver](#) on page 88), and verify that the peer's name is listed in a DNS server.

**Note:**

Do not specify an ambiguous ISAKMP peer; that is, do not configure an FQDN that translates to an IP address which is already associated with another ISAKMP peer. For example:

```
G450-001# crypto isakmp peer address 149.49.70.1
G450-001(config-peer:149.49.70.1)#
```

Or

```
G450-001# crypto isakmp peer fqdn vpn.lnd.ny.avaya.com
G450-001(config-peer:vpn.lnd.ny.avaya.com)#
```

2. Use the **description** command to enter a description for the peer. For example:

```
G450-001(config-peer:149.49.70.1)# description "New York office"
Done!
```

3. Specify an ISAKMP policy to be used with the peer, using the **isakmp policy** command.

 **Important:**

**isakmp policy** is a mandatory command.

For example:

```
G450-001(config-peer:149.49.70.1)# isakmp-policy 1
Done!
```

4. Enter the preshared key for peer authentication using the **pre-shared-key** command.

### Important:

**pre-shared-key** is a mandatory command.

For example:

```
G450-001(config-peer:149.49.70.1)# pre-shared-key GNp1odGNBrB5z4GJL
Done!
```

Alternatively, you can obtain a cryptographic-grade random key from the G450 with the **suggest-key** command, and then enter it using the **pre-shared-key** command. The suggested key-length can vary from 8-127 alphanumeric characters, or from 8-64 bytes represented in hexadecimal notation. The default length is 32 characters.

For example:

```
G450-001(config-peer:149.49.70.1)# suggest-key 24
The suggest key: yjsYIz9ikcwaq0FUPTF3CIrw

G450-001(config-peer:149.49.70.1) pre-shared-key yjsYIz9ikcwaq0FUPTF3CIrw
Done!
```

5. If you wish to work in IKE aggressive mode, use the **initiate mode aggressive** command.

### Note:

Aggressive mode is one of the prerequisites for working with dynamic local peer IP addresses. For more information about working with dynamic local peer IP addresses, see [Using dynamic local peer IP](#) on page 536.

For example:

```
G450-001(config-peer:149.49.70.1)# initiate mode aggressive
Done!
```

6. If you wish to listen in to communication from a remote peer that has a dynamic IP address, use the **initiate mode none** command. In this mode, the device can only accept inbound IKE Aggressive Mode connections from the peer, and is not able to initiate IKE phase-1 (Main Mode or Aggressive Mode) to the peer, nor is the peer able to participate as part of a peer-group. In addition, specifying the **continuous-channel** command when configuring the crypto ISAKMP peer information has no effect in this mode (for more information on continuous-channel see [Enabling continuous channel](#) on page 539).

7. Specify the branch device (G450) by its address or by the FQDN name that identifies the G450 in the remote peer, using the **self-identity** command. For example:

```
G450-001(config-peer:149.49.70.1)# self-identity address
Done!
```

Or

```
G450-001(config-peer:149.49.70.1)# self-identity fqdn vpn.avaya.com
Done!
```

**Note:**

Specifying self-identity as a name is one of the prerequisites for working with dynamic local peer IP addresses. For more information about working with dynamic local peer IP addresses, see [Using dynamic local peer IP](#) on page 536.

8. Enable Dead Peer Detection (DPD) keepalives that check whether the remote peer is up using the **keepalive** command, followed by the number of seconds between DPD keepalive probes, and the number of seconds between retries if keepalive fails.

The following example sets DPD keepalive to send probes every 10 seconds, and to send retries every two seconds if DPD keepalive fails.

```
G450-001(config-peer:149.49.70.1)# keepalive 10 retry 2
Done!
```

9. Bind peer status to an object tracker, which can monitor hosts inside the remote peer's protected network. To do so, use the **keepalive-track** command. For more information on object trackers, see [Object tracking](#) on page 298.

For example:

```
G450-001(config-peer:149.49.70.1)# keepalive-track 5
Done!
```

**Note:**

DPD and object tracking can coexist and augment each other. However, object tracking does not impose any requirements on the remote peer. You can, therefore, use object tracking rather than DPD keepalives if the remote peer does not support DPD.

10. Specify whether to enable continuous-channel IKE phase 1, with the **continuous-channel** command. The default setting is **no continuous-channel**, which disables continuous-channel IKE phase 1. For more information on continuous-channel see [Enabling continuous channel](#) on page 539. For example:

```
G450-001(config-peer:149.49.70.1)# continuous-channel
Done!
```

11. Exit the peer context with the **exit** command. For example:

```
G450-001(config-peer:149.49.70.1)# exit
G450-001#
```

---

## Configuring an ISAKMP peer-group

An ISAKMP peer-group maintains an ordered list of redundant peers. The purpose of the peer-group is to provide a backup in the case of remote peer failure. At any point in time, only one peer is active and acting as the remote peer. If the active peer is presumed dead, the next peer in the peer-group becomes the active remote peer. For a full explanation of the redundancy mechanism see [Introduction to the failover mechanism](#) on page 559.

**Note:**

You can define up to 50 peer-groups.

**Note:**

A peer configured as **initiate mode none** cannot be a member of a peer-group.

1. Use the **crypto isakmp peer-group** command, followed by the name of a peer-group (a string of up to 110 characters), to enter the context of an ISAKMP peer-group (and to create the peer-group if it does not exist). For example:

```
G450-001# crypto isakmp peer-group NY-VPN-group
G450-001(config-peer-grp:NY-VPN-group)#
```

2. Use the **description** command to enter a description for the ISAKMP peer-group. For example:

```
G450-001(config-peer-grp:NY-VPN-group)# description "Avaya peer group"
Done!
```

3. Add a peer to the list of peers in the group, using the **set peer** command:
  - Specify the peer's name or address.
  - Optionally enter an index number, specifying the relative position of the peer within the peer-group. If you do not enter an index number, the peer is added at the end of the peer-group list, and is assigned an index following the last peer's index.

For example:

```
G450-001(config-peer-grp:NY-VPN-group)# set peer 149.49.52.135 1
Done!
```

4. Repeat Step 3 for every peer you want to add to the list.

**Note:**

You can define up to a maximum of five peers in a peer-group.

**Important:**

Each of the peers listed in the peer-group must be configured as an ISAKMP peer (see [Configuring ISAKMP peer information](#) on page 514).

## Configuring crypto maps

A crypto map points to a transform-set and to a peer (which in turn points to an ISAKMP policy). If you defined a peer-group, the crypto map can point to the peer-group. The transform-set and ISAKMP policy define how to secure the traffic that matches the ip-rule that points to this crypto map.

**Important:**

It is mandatory to create at least one crypto map.

**Note:**

You can configure up to 100 crypto maps.

1. Use the **crypto map** command, followed by an index number from 1 to 50, to enter the context of a crypto map (and to create the crypto map if it does not exist). For example:

```
G450-001# crypto map 1
G450-001(config-crypto:1)#
```

2. Use the **description** command to enter a description for the crypto map. For example:

```
G450-001(config-crypto:1)# description "vpn lincroft branch"
Done!
```

3. Specify the remote peer, using the **set peer** command. For example:

```
G450-001(config-crypto:1)# set peer 149.49.60.60
Done!
```

Or

Specify a peer-group, using the **set peer-group** command. For example:

```
G450-001(config-crypto:1)# set peer-group NY-VPN-group
Done!
```

**Important:**

It is mandatory to specify either **set peer** or **set peer-group**, but not both.

## Configuring IPsec VPN

- Specify the specific transform-set to which this crypto map points, using the **set transform-set** command.

 **Important:**

**set transform-set** is a mandatory command.

For example:

```
G450-001(config-crypto:1)# set transform-set ts1
Done!
```

- Set the static DSCP value in the DS field of the tunneled packet by using the **set dscp** command, followed by a value from 0 to 63. The default setting is **no set dscp**, which specifies that the DSCP is copied from the DS field of the original packet.

For example:

```
G450-001(config-crypto:1)# set dscp 38
Done!
```

- Specify whether to enable continuous-channel IPsec (IKE phase 2) with the **continuous-channel** command. The default setting is **no continuous-channel**, which disables continuous-channel IPsec. For more information on continuous-channel see [Enabling continuous channel](#) on page 539. For example:

```
G450-001(config-crypto:1)# continuous-channel
Done!
```

- Exit crypto map context with the **exit** command. For example:

```
G450-001(config-crypto:1)# exit
G450-001#
```

---

## Configuring crypto lists

A crypto list is an ordered list of ip-rules that control which traffic requires IPsec protection and which does not, based on IP groups (source and destination IP addresses and wildcard). A crypto list is activated on an interface. The G450 can have multiple crypto lists activated on different interfaces.

 **Important:**

It is mandatory to create at least one crypto list.

**Note:**

You can configure up to 100 crypto lists.



1. Use the **ip crypto-list** command, followed by an index number from 901 to 999, to enter the context of a crypto list (and to create the list if it does not exist). For example:

```
G450-001# ip crypto-list 901
G450-001(Crypto 901)#
```

2. Specify the local IP address for the IPsec tunnels derived from this crypto list, using the **local-address** command. The local address can be either the IP address or the name of an IP interface of the device.

**Important:**

**local-address** is a mandatory command.

For example:

```
G450-001(Crypto 901)# local-address 192.168.49.1
Done!
```

Or

```
G450-001(Crypto 901)# local-address FastEthernet 10/2
Done!
```

**Note:**

Specifying the interface as a name is one of the prerequisites for working with dynamic local peer IP addresses. For more information about working with dynamic local peer IP addresses, see [Using dynamic local peer IP](#) on page 536.

3. Specify the name of the crypto list using the **name** command. For example:

```
G450-001(Crypto 901)# name "Public Network via ADSL"
Done!
```

4. Use the **ip-rule** command, followed by an index number from 1 to 1000, to enter the context of an ip-rule (and to create the ip-rule if it does not exist).

**Important:**

It is mandatory to create at least one ip-rule.

For example:

```
G450-001(Crypto 901)# ip-rule 10
G450-001(Crypto 901/ip rule 10)#
```

5. Configure ip-rule parameters as follows:

- Use the **description** command to assign a description to the ip-rule.
- To specify a range of source and destination IP addresses to which the rule applies, use the **source-ip** and **destination-ip** commands, followed by the IP range criteria. The IP range criteria can be one of the following:
  - **A single address.** Type `host`, followed by an IP address, to set a single IP address to which the rule applies.
  - **A wildcard.** Type `host`, followed by an IP address using wildcards, to set a range of IP addresses to which the rule applies.
  - **All addresses.** Type `any` to apply the rule to all IP addresses.

Use the **no** form of the appropriate command to return to the default value, **any**.

- Define the action by specifying whether to protect traffic that matches the source and destination addresses, using one of the following commands:
  - **no protect.** Do not protect traffic that matches the source and destination addresses.
  - **protect crypto map crypto-map-id.** Protect traffic that matches the source and destination addresses. The specified crypto map specifies how to secure the traffic. For instructions on configuring crypto maps, see [Configuring crypto maps](#) on page 519.

For example:

```
G450-001(Crypto 901/ip rule 10)# description "vpn tunnel to uk main office"
Done!
G450-001(Crypto 901/ip rule 10)# source-ip 10.1.0.0 0.0.255.255
Done!
G450-001(Crypto 901/ip rule 10)# destination-ip any
Done!
G450-001(Crypto 901/ip rule 10)# protect crypto map 1
Done!
```

- For rules whose action is **no protect**, you can fine-tune the definition of packets that match this rule by using the following commands. For a full description of the commands see *Avaya G450 CLI Reference*, 03-602056. Note that this fine-tuning is not applicable for rules whose action is **protect crypto map**.
  - **ip-protocol.** Specify the IP protocol to match.
  - **tcp.** Specify the TCP settings to match.
  - **udp.** Specify the UDP settings to match.
  - **icmp.** Specify the ICMP protocol settings to match.
  - **dscp.** Specify the DSCP to match.
  - **fragment.** Specify whether this rule applies to non-initial fragments only.

6. Exit ip-rule context with the **exit** command. For example:

```
G450-001(Crypto 901/ip rule 10)# exit
G450-001(Crypto 901)#
```

7. Repeat Steps 4 to 6 for every ip-rule you wish to define in the crypto list.  
8. Exit crypto list context with the **exit** command. For example:

```
G450-001(Crypto 901)# exit
G450-001#
```

## Deactivating crypto lists to modify IPsec VPN parameters

Most IPsec VPN parameters cannot be modified if they are linked to an active crypto list. To modify a parameter linked to an active crypto list, you must first deactivate the list using the **no ip crypto-group** command in the context of the interface on which the crypto list is activated.

### Note:

If the crypto list is activated on more than one interface, deactivate the crypto list for each of the interfaces on which it is activated.

For example:

```
G450-001# interface serial 3/1
G450-001(if: Serial 3/1)# no ip crypto-group
Done!
```

After modifying IPsec VPN parameters as desired, re-activate the crypto list on the interface using the **ip crypto-group crypto-list-id** command. For example:

```
G450-001# interface serial 3/1
G450-001(if: Serial 3/1)# ip crypto-group 901
Done!
```

### Tip:

If you wish to change the parameters of a crypto list, you can use the **ip policy-list-copy old list new list** command, edit the new list, and activate it on the interface. Note that activating the new list will cause all the current IPsec tunnels to close.

---

### Configuring and assigning an access control list

Since VPN is intended for a public network such as the Internet, it is recommended to define an access control list using the `ip access-control-list` command, to avoid traffic that should not enter the device. You should, therefore, define an ingress access control list that allows only IKE, ESP, and ICMP traffic to enter the device from the public interface. For a configuration example see the access control list in [Simple VPN topology – VPN hub and spokes](#) on page 530.

---

### Configuring global parameters

- Enable invalid SPI recovery with the `crypto isakmp invalid-spi-recovery` command. Invalid SPI Recovery enables an IKE SA to be established when an invalid security parameter index error occurs during packet processing. A notification of the invalid SPI error is sent to the originating peer so that the SA databases can be re-synchronized, and successful packet processing can be resumed. For example:

```
G450-001# crypto isakmp invalid-spi-recovery
Done!
```

**Note:**

Invalid SPI recovery is enabled by default. Configure invalid SPI recovery only if you wish to re-enable it after it was disabled, using the `no crypto isakmp invalid-spi-recovery` command.

- Configure NAT Traversal global parameters as described in [Configuring NAT Traversal](#) on page 524

### Configuring NAT Traversal

Network Address Translation (NAT) is a solution to the problem of the scarcity and cost of public IP addresses. An organization with a single public IP address can use a NAT device to connect multiple computers to the Internet sharing a single public IP address. However, NAT causes compatibility problems for many types of network applications, including VPN.

NAT Traversal enables detecting the presence of NAT devices along the path of the VPN tunnel. Once detected, the two peers tunnel IKE and IPSEC traffic through an agreed-upon UDP port, allowing the NAT device to work seamlessly with VPN. The standard UDP port used is port 4500; to find out the port number, use the `show crypto ipsec sa` command.

The G450 IPsec VPN feature supports NAT Traversal. If your installation includes one or more NAT devices between the local and remote VPN peers, NAT Traversal should be enabled, although in some rare cases it may not be required.

**Note:**

NAT Traversal is enabled by default. Configure NAT Traversal only if you need to re-enable it after it was disabled, using the **no crypto ipsec nat-transparency udp-encapsulation** command.

NAT Traversal keepalive is also enabled by default (with a default value of 20 seconds). Configure NAT Traversal keepalive only if you need to re-enable it after it was disabled, using the **no crypto isakmp nat keepalive** command.

**Configure NAT Traversal**

1. Enable NAT Traversal by entering **crypto ipsec nat-transparency udp-encapsulation**. For example:

```
G450-001# crypto ipsec nat-transparency udp-encapsulation
Done!
```

2. Enable NAT Traversal keepalives and configure the keepalive interval (in seconds) by entering **crypto isakmp nat keepalive**, followed by a number from 5 to 3600.

NAT Traversal keepalives are empty UDP packets that the device sends on a periodic basis at times of inactivity when a dynamic NAT is detected along the way. These keepalives are intended to maintain the NAT translation alive in the NAT device, and not let it age-out due to periods of inactivity. Set the NAT Traversal keepalive interval on the G450 to be less than the NAT translation aging time on the NAT device. For example:

```
G450-001# crypto isakmp nat keepalive 60
Done!
```

---

## Assigning a crypto list to an interface

A crypto list is activated on an interface. You can assign multiple crypto lists to different interfaces on the G450.

1. Enter interface context using the **interface** command. For example:

```
G450-001# interface fastethernet 10/2
G450-001(config-if:FastEthernet 10/2)#
```

2. Configure the IP address of the interface. You can configure either a static or a dynamic IP address.
  - To configure a static IP address:
    - Be sure to specify an IP address (not an interface name) as the **local-address** in the crypto list (see [Configuring crypto lists](#) on page 520)

## Configuring IPsec VPN

- Within the interface context, specify the IP address and mask using the **ip address** command

For example:

```
G450-001(config-if:FastEthernet 10/2)# ip address 192.168.49.1
25.255.255.0
```

- To configure a dynamic IP address, see [Using dynamic local peer IP](#) on page 536
3. Use the **ip crypto-group** command, followed by the index of the crypto-group, to assign a crypto-group to the interface.

### Important:

**ip crypto-group** is a mandatory command.

4. Optionally, you can set the following parameters:
  - The **crypto ipsec minimal-pmtu** command is intended for advanced users only. It sets the minimal PMTU value which can be applied to an SA when the G450 participates in Path MTU Discovery (PMTUD) for the tunnel pertaining to that SA.
  - The **crypto ipsec df-bit** command is intended for advanced users only. It sets the Do Not Fragment (DF) bit to either *clear* or *copy* mode:
    - *copy*. The DF bit of the encapsulated packet is copied from the original packet, and PMTUD is maintained for the IPsec tunnel.
    - *clear*. The DF bit of the encapsulated packet is never set, and PMTUD is not maintained for the IPsec tunnel. Packets traversing an IPsec tunnel are pre-fragmented according to the MTU of the SA, regardless of their DF bit. In case packets are fragmented, the DF bit is copied to every fragment of the original packet.

For example:

```
G450-001(config-if:FastEthernet 10/2)# ip crypto-group 901
Done!
G450-001(config-if:FastEthernet 10/2)# crypto ipsec minimal pmtu 500
Done!
G450-001(config-if:FastEthernet 10/2)# crypto ipsec df-bit copy
Done!
```

5. Exit the interface context with the **exit** command. For example:

```
G450-001(config-if:FastEthernet 10/2)# exit
G450-001#
```

---

## IPSec VPN maintenance

You can display IPSec VPN configuration and status, and clear IPSec VPN data, using certain **show** and **clear** commands. In addition, you can display the IPSec VPN log to verify the success or failure of IPSec VPN operations, and to view the actual configuration of both peers for a successful debug in case of a problem.

---

### Displaying IPSec VPN configuration

You can use the following **show** commands to display IPSec VPN configuration. For a full description of the commands and their output fields see *Avaya G450 CLI Reference*, 03-602056.

- Use the **show crypto ipsec transform-set** command to display configuration for a specified transform-set or all transform-sets.
- Use the **show crypto isakmp policy** command to display ISAKMP policy configuration.
- Use the **show crypto isakmp peer** command to display crypto ISAKMP peer configuration.
- Use the **show crypto isakmp peer-group** command to display crypto ISAKMP peer-group configuration.
- Use the **show crypto map** command to display all or specific crypto map configurations.
- Use the **show ip crypto-list list#** command to display the configuration of a specific crypto list.
- Use the **show ip crypto-list** command to display all crypto lists.
- Use the **show ip active-lists** command to display the crypto lists active on each interface.

---

### Displaying IPSec VPN status

You can use the following **show** commands to show runtime IPSec VPN database status and statistics, and clear runtime statistics. For a full description of the commands and their output fields see *Avaya G450 CLI Reference*, 03-602056.

- Use the **show crypto isakmp sa** command to display ISAKMP SA database status.
- Use the **show crypto ipsec sa** command to display the IPsec SA database status.

## Configuring IPsec VPN

- Use the **show crypto ipsec sa address** command to display the IPsec SA configuration by peer IP address.
- Use the **show crypto ipsec sa list** command to display the IPsec SA runtime database by list ID and rule ID.

### Tip:

The **detail** option in the various **show crypto ipsec sa** commands, provides detailed counters information on each IPsec SA. To pinpoint the source of a problem, it is useful to check for a counter whose value grows with time.

- Use the **clear crypto sa counters** command to clear the crypto SA counters

---

## IPsec VPN intervention

You can use the following **clear** commands to clear the IPsec VPN runtime database:

- Use the **clear crypto sa** command to clear all or specific IPsec SAs.
- Use the **clear crypto isakmp** command to flush a specific entry in the ISAKMP database or the entire ISAKMP database.

### Note:

If you wish to clear both an ISAKMP connection and the IPsec SAs, the recommended order of operations is:

First clear the IPsec SAs with the **clear crypto sa all** command, then clear the ISAKMP SA with the **clear crypto isakmp** command.

---

## IPsec VPN logging

IPsec VPN logging allows you to view the start and finish of IKE phase 1 and IKE phase 2 negotiations. Most importantly, it displays the configuration of both peers, so that you can pinpoint the problem in case of a mismatch between the IPsec VPN configuration of the peers.

### Note:

For more information about logging, see [Configuring logging on page 209](#).

1. Use the **set logging session enable** command to enable session logging.

```
G450-001# set logging session enable
Done!
CLI-Notification: write: set logging session enable
```



2. Use the **set logging session condition ISAKMP** command to view all ISAKMP messages of Info level and above. For example:

```
G450-001# set logging session condition ISAKMP Info
Done!
CLI-Notification: write: set logging session condition ISAKMP Info
```

3. Use the **set logging session condition IPSEC** command to view all IPsec messages of Info level and above. For example:

```
G450-001# set logging session condition IPSEC Info
Done!
CLI-Notification: write: set logging session condition IPSEC Info
```

4. Initiate a session by pinging the peer device. For example.

```
G450-001# ping 135.64.102.109
```

The logging information will detail the IKE negotiations, including the ISAKMP SA and IPsec SA configuration of the peers. For example:

```
IPSEC-Informational: Call IKE negotiation for outgoing SPD entry 901_20:
  Peers 149.49.77.202<->135.64.102.109

ISAKMP-Informational: Initiating IKE phase 1 negotiation:
  Peers 149.49.77.202<->135.64.102.109

ISAKMP-Informational: Finished IKE phase 1 negotiation, creating ISAKMP
SA:
  Peers 149.49.77.202<->135.64.102.109
  Icookie - 0e2fb5ac12ec04b2, Rcookie - 541b912b0a30085d
  esp-des, esp-sha-hmac, DH group 1, Lifetime 86400 seconds

ISAKMP-Informational: Initiating IKE phase 2 negotiation:
  Peers 149.49.77.202<->135.64.102.109

ISAKMP-Informational: Finished IKE phase 2, creating outbound IPSEC SA:
  SPI 0x4d706e3, Peers 149.49.77.202<->135.64.102.109
  Identities: 149.49.77.0/255.255.255.0->135.64.102.0/255.255.255.0
  esp-des, esp-md5-hmac, 3600 seconds, 4608000 KB

ISAKMP-Informational: Finished IKE phase 2, creating inbound IPSEC SA:
  SPI 0x6798, Peers 135.64.102.109<->149.49.77.202
  Identities: 135.64.102.0/255.255.255.0->149.49.77.0/255.255.255.0
  esp-des, esp-md5-hmac, 3600 seconds, 4608000 KB
```

---

## Typical installations

Included in the typical installations, are examples of installing VPN hub and spokes, full or partial mesh, and a hub-and-spoke with VPN for data and VoIP control backup.

---

### Simple VPN topology – VPN hub and spokes

The simple VPN topology consists of several VPN spokes (branch offices) connected via the Internet to the VPN hub (Main Office).

In this topology:

- The Broadband Internet connection uses cable or DSL modem, with a static public IP address
- There is a VPN tunnel from each spoke to the VPN hub over the Internet
- Only VPN traffic is allowed via the Internet connection

---

**Figure 45: Simple VPN topology: VPN hub and spokes**

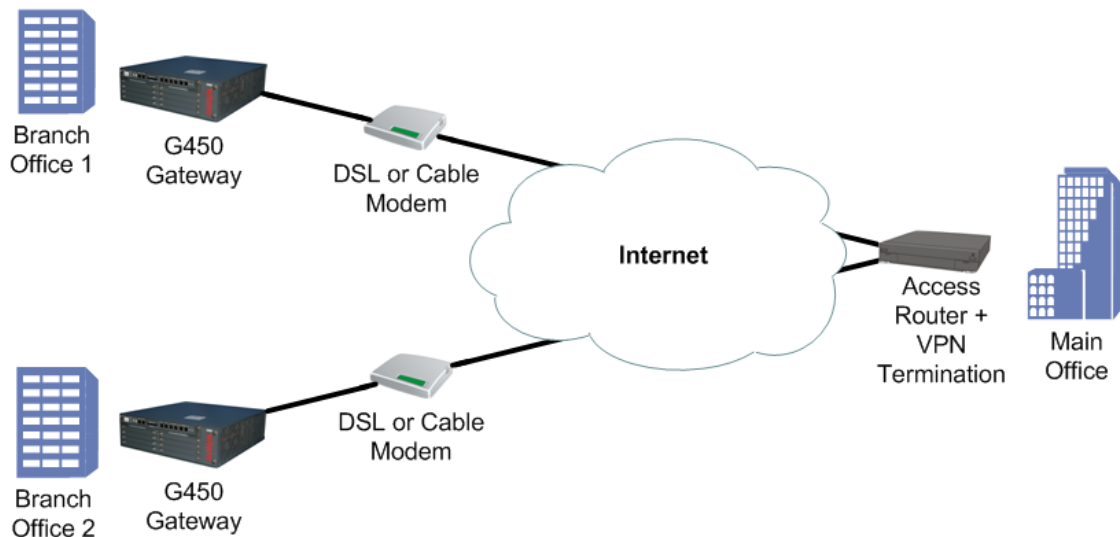

## Configuring the simple VPN topology

1. Configure each branch as follows:
  - The default gateway is the Internet interface
  - VPN policy is configured on the Internet interface egress as follows:
    - Traffic from the local subnets to any IP address is encrypted, using tunnel mode IPSec
    - The remote peer is the Main Office (the VPN Hub)
  - An access control list (ACL) is configured on the Internet interface to allow only the VPN / ICMP traffic. See [Table 129](#) for configuration settings.
2. Configure the VPN Hub (Main Office) as follows:
  - Static routing: Branch subnets -> Internet interface
  - The VPN policy portion for the branch is configured as a mirror image of the branch, as follows:
    - Traffic from any to branch local subnets -> encrypt, using tunnel mode IPSec
    - The remote peer is the VPN spoke (Branch Internet address)

### Note:

For information about using access control lists, see [Configuring policy](#) on page 591.

**Table 129: Configuring simple VPN topology**

Traffic direction	ACL parameter	ACL value	Description
Ingress	IKE	Permit	-
Ingress	ESP	Permit	-
Ingress	ICMP	Permit	This enables the PMTUD application to work
Ingress	All allowed services from any IP address to any local subnet	Permit	Due to the definition of the VPN Policy, this will be allowed only if traffic comes over ESP
Ingress	Default VPN policy	Deny	-
Egress	IKE	Permit	-
Egress	ESP	Permit	-

**1 of 2**

**Table 129: Configuring simple VPN topology (continued)**

Traffic direction	ACL parameter	ACL value	Description
Egress	ICMP	Permit	This enables the PMTUD application to work
Egress	All allowed services from any IP address to any local subnet	Permit	This traffic is tunnelled using VPN
Egress	Default	Deny	-

**2 of 2**

## Configuration example

```
crypto isakmp policy 1
  encryption aes
  hash sha
  group 2
  exit
crypto isakmp peer address <Main Office Public Internet Static IP Address>
  pre-shared-key <secret key>
  isakmp-policy 1
  exit
crypto ipsec transform-set ts1 esp-3des esp-sha-hmac
  set pfs 2
  exit
crypto map 1
  set peer <Main OfficeMain Office Public Internet Static IP
                                     Address>
  set transform-set ts1
  exit

ip crypto-list 901
  local-address <Branch Office Public Internet Static IP Address>
  ip-rule 10
    source-ip <Branch Subnet1> <Branch Subnet1 Mask>
    destination-ip any
    protect crypto map 1
    exit
  ip-rule 20
    source-ip <Branch Subnet2> <Branch Subnet2 Mask>
    destination-ip any
    protect crypto map 1
    exit
  exit

ip access-control-list 301
  ip-rule 10
    source-ip any
    destination-ip any
    ip-protocol udp
    udp destination-port eq Ike
    composite-operation Permit
    exit
  ip-rule 11
    source-ip any
    destination-ip any
    ip-protocol    udp
    udp destination-port eq Ike-nat-t
    composite-operation permit
    exit
```

## Configuring IPsec VPN

```
ip-rule 12
    source-ip any
    destination-ip any
    ip-protocol    udp
    udp destination-port eq Ike-nat-t-vsua
    composite-operation permit
    exit

ip-rule 20
    source-ip any
    destination-ip any
    ip-protocol esp
    composite-operation Permit
    exit

ip-rule 30
    source-ip any
    destination-ip any
    ip-protocol icmp
    composite-operation Permit
    exit

ip-rule 40
    source-ip    any
    destination-ip host <Branch Subnet1> <Branch Subnet1 Mask>
    composite-operation Permit
    exit

ip-rule 50
    source-ip    any
    destination-ip host <Branch Subnet2> <Branch Subnet2 Mask>
    composite-operation Permit
    exit

ip-rule default
    composite-operation deny
    exit

exit
ip access-control-list 302
    ip-rule 10
        source-ip any
        destination-ip any
        ip-protocol udp
        udp destination-port eq Ike
        composite-operation Permit
        exit

    ip-rule 11
        source-ip any
        destination-ip any
        ip-protocol    udp
        udp destination-port eq Ike-nat-t
        composite-operation permit
        exit

    ip-rule 12
        source-ip any
        destination-ip any
        ip-protocol    udp
        udp destination-port eq Ike-nat-t-vsua
        composite-operation permit
        exit
```

```

ip-rule 20
    source-ip any
    destination-ip any
    ip-protocol esp
    composite-operation Permit
    exit
ip-rule 30
    source-ip any
    destination-ip any
    ip-protocol icmp
    composite-operation Permit
    exit
ip-rule 40
    destination-ip any
    source-ip host <Branch Subnet1> <Branch Subnet1 Mask>
    composite-operation Permit
    exit
ip-rule 50
    destination-ip any
    source-ip host <Branch Subnet2> <Branch Subnet2 Mask>
    composite-operation Permit
    exit
ip-rule default
    composite-operation deny
    exit
exit

interface vlan 1.1
    ip-address <Branch Subnet1> <Branch Subnet1 Mask>
    pmi
    icc-vlan
    exit

interface vlan 1.2
    ip-address <Branch Subnet2> <Branch Subnet2 Mask>
    exit

interface FastEthernet 10/2
    encapsulation PPPoE
    traffic-shape rate 256000
    ip Address    <Branch Office Public Internet Static IP Address>
                  <Branch Office Public Internet network mask>
    ip crypto-group    901
    ip access-group    301 in
    ip access-group    302 out
    exit

ip default-gateway FastEthernet 10/2 high

```

### Using dynamic local peer IP

When the number of static IP addresses in an organization is limited, the ISP allocates temporary IP addresses to computers wishing to communicate over IP. These temporary addresses are called dynamic IP addresses.

The G450 IPsec VPN feature provides dynamic local peer IP address support. To work with dynamic local peer IP, you must first configure some prerequisites and then instruct the G450 to learn the IP address dynamically using either PPPoE or DHCP client.

#### Note:

When working with dynamic local peer IP, you must verify that it is the G450 that initiates the VPN connection. The VPN peer cannot initiate the connection since it does not know the G450's IP address. To maintain the G450 as the initiator, do one of the following:

- Specify **continuous channel** in the context of the VPN peer, to maintain the IKE phase 1 connection even when no traffic is sent (see [Enabling continuous channel](#) on page 539).
- Maintain a steady transmission of traffic by sending GRE keepalives or employing object tracking.

#### Prerequisites for dynamic local peer IP

- Specify IKE aggressive mode with the **initiate mode aggressive** command when entering the ISAKMP peer information (see [Configuring ISAKMP peer information](#) on page 514).

```
G450-001(config-peer:149.49.70.1)# initiate mode aggressive
Done!
```

- Specify the local device by its FQDN name, using the **self-identity** command, when entering the ISAKMP peer information (see [Configuring ISAKMP peer information](#) on page 514). For example:

```
G450-001(config-peer:149.49.70.1)# self-identity fqdn vpn.avaya.com
Done!
```

- Specify the local address by name in the ip crypto lists, using the **local-address** command (see [Configuring crypto lists](#) on page 520). You must specify the local address by interface name. For example:

```
G450-001(Crypto 901)# local-address FastEthernet 10/2
Done!
```



## Configuring dynamic local peer IP on a PPPoE interface

1. Enter the context of the FastEthernet interface. For example:

```
G450-001(config)# interface fastethernet 10/2
G450-001(config-if:FastEthernet 10/2)#
```

2. Enter the following commands in the context of the interface: **no ip address**, **encapsulation pppoe**, and **ip address negotiated**.

```
G450-001(config-if:FastEthernet 10/2)# no ip address
Done!
G450-001(config-if:FastEthernet 10/2)# encapsulation pppoe
Done!
G450-001(config-if:FastEthernet 10/2)# ip address negotiated
Done!
```

3. Exit the context of the interface, and set the interface name as the next hop. For example:

```
G450-001(config-if:FastEthernet 10/2)# exit
G450-001(config)# ip default-gateway FastEthernet 10/2
Done!
```

### Note:

PPP over Ethernet (PPPoE) is a client-server protocol used for carrying PPP-encapsulated data over Ethernet frames. You can configure PPPoE on the G450's ETH WAN Fast Ethernet port. For more information about PPPoE on the G450, see [Configuring PPPoE](#) on page 259.

## Configuring dynamic local peer IP for a DHCP Client

1. Permit DHCP packets in the ingress access control list (ACL) and the egress ACL. To do so, perform the following:
  - a. Use the **no ip access-group** command to deactivate both the ingress ACL and the egress ACL on the FastEthernet interface.
  - b. Add a rule to the ingress ACL and to the egress ACL, permitting DHCP packets to pass (for information on defining ACL policy rules, see [Defining rules](#) on page 599).
  - c. Use the **ip access-group** command to activate the ingress ACL and the egress ACL on the FastEthernet interface.

For example:

## Configuring IPsec VPN

```
! Deactivate the Ingress and Egress ACLs on the FastEthernet Interface
!
G450-001(config)# interface fastethernet 10/2
G450-001(config-if:FastEthernet 10/2)# no ip access-group in
Done!
G450-001(config-if:FastEthernet 10/2)# no ip access-group out
Done!
G450-001(config-if:FastEthernet 10/2)# exit
!
! Add a Permit rule to the Ingress ACL for DHCP
!
G450-001(config)# ip access-control-list 301
G450-001(config-ACL 301)# ip-rule 25
G450-001(config-ACL 301/ip rule 25)# source-ip any
Done!
G450-001(config-ACL 301/ip rule 25)# destination-ip any
Done!
G450-001(config-ACL 301/ip rule 25)# ip-protocol udp
Done!
G450-001(config-ACL 301/ip rule 25)# udp source-port eq bootps
Done!
G450-001(config-ACL 301/ip rule 25)# udp destination-port eq bootpc
Done!
G450-001(config-ACL 301/ip rule 25)# composite-operation permit
Done!
G450-001(config-ACL 301/ip rule 25)# exit
G450-001(config-ACL 301)# exit
!
! Add a Permit rule to the Egress ACL for DHCP
!
G450-001(config)# ip access-control-list 302
G450-001(config-ACL 302)# ip-rule 25
G450-001(config-ACL 302/ip rule 25)# source-ip any
Done!
G450-001(config-ACL 302/ip rule 25)# destination-ip any
Done!
G450-001(config-ACL 302/ip rule 25)# ip-protocol udp
Done!
G450-001(config-ACL 302/ip rule 25)# udp source-port eq bootpc
Done!
G450-001(config-ACL 302/ip rule 25)# udp destination-port eq bootps
Done!
G450-001(config-ACL 302/ip rule 25)# composite-operation permit
Done!
G450-001(config-ACL 302/ip rule 25)# exit
G450-001(config-ACL 302)# exit
!
! Activate the Ingress and Egress ACLs on the FastEthernet Interface
!
G450-001(config)# interface fastethernet 10/2
G450-001(config-if:FastEthernet 10/2)# ip access-group 301 in
Done!
G450-001(config-if:FastEthernet 10/2)# ip access-group 302 out
Done!
```

- Specify **no ip address** and then **ip address dhcp** in the context of the FastEthernet Interface. For example:

```
G450-001(config-if:FastEthernet 10/2)# no ip address
no ip address defined on this interface
G450-001(config-if:FastEthernet 10/2)# ip address dhcp
Done!
```

- Exit the context of the interface, and set the interface name as the next hop. For example:

```
G450-001(config-if:FastEthernet 10/2)#exit
G450-001(config)# ip route 5.0.0.0 255.0.0.0 FastEthernet 10/2
Done!
```

**Note:**

For more information on DHCP client in the G450, see [Configuring DHCP client](#) on page 199.

## Enabling continuous channel

An IPsec VPN connection exists as long as traffic is traversing the connection, or the timeouts have not expired. However, there are advantages to keeping the connection continuously alive, such as eliminating the waiting time necessary to construct a new IPsec VPN connection.

The G450 IPsec VPN feature supports continuous channel, which maintains a continuous IPsec VPN connection. That means that when you activate the **ip crypto-group** command on the defined interface, the IPsec VPN tunnel is immediately started, even if no traffic is traversing the interface and the timeouts have expired.

You can set continuous channel for either or both IKE phase 1 and IKE phase 2, as follows:

- To set continuous channel for IKE phase 1, enter **continuous-channel** when configuring the crypto ISAKMP peer information (see [Configuring ISAKMP peer information](#) on page 514). For example:

```
G450-001# crypto isakmp peer address 149.49.70.1
G450-001(config-peer:149.49.70.1)# continuous-channel
Done!
```

- To set continuous channel for IKE phase 2, enter **continuous-channel** when configuring the crypto map (see [Configuring crypto maps](#) on page 519). For example:

```
G450-001# crypto map 1
G450-001(config-crypto:1)# continuous-channel
Done!
```

---

## Full or partial mesh

This installation is very similar to the simple hub and spokes installation, but instead of connecting to a single central site, the branch is also connected to several other branch sites by direct IPsec VPN tunnels. The configuration is therefore very similar to the previous one, duplicated several times.

In this topology:

- The Broadband Internet connection uses cable or DSL modem, with a static public IP address
- There is a VPN tunnel from each spoke to the VPN hub over the Internet
- There is a VPN tunnel from one spoke to another spoke
- Only VPN traffic is allowed via the Internet connection

---

**Figure 46: Full or partial mesh**

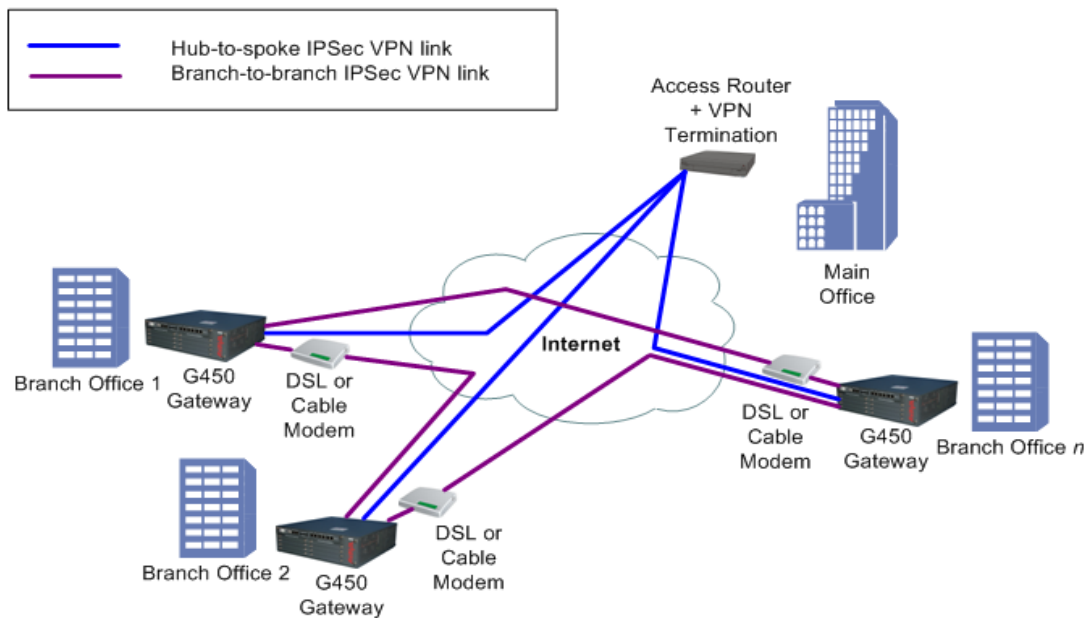

## Configuring the mesh VPN topology

1. Configure Branch Office 1 as follows:
  - The default gateway is the Internet interface
  - VPN policy is configured on the Internet interface egress as follows:
    - Traffic from the local subnets to the second spoke subnets -> encrypt, using tunnel mode IPSec, with the remote peer being the second spoke
    - Traffic from the local subnets to any IP address -> encrypt, using tunnel mode IPSec, with the remote peer being the main office (VPN hub)
  - An access control list (ACL) is configured on the Internet interface to allow only the VPN / ICMP traffic. See [Table 130](#) for configuration settings.

**Note:**

For information about using access control lists, see [Configuring policy](#) on page 591.

**Table 130: Configuring the mesh VPN topology – Branch Office 1**

Traffic direction	ACL parameter	ACL value	Description
Ingress	IKE from Main Office IP to Branch IP	Permit	-
Ingress	ESP from Main Office IP to Branch IP	Permit	-
Ingress	IKE from Second Branch IP to Branch IP	Permit	-
Ingress	ESP from Second Branch IP to Branch IP	Permit	-
Ingress	ICMP from any IP address to local tunnel endpoint	Permit	This enables the PMTUD application to work
Ingress	All allowed services from any IP address to any local subnet	Permit	Due to the definition of the VPN Policy, this will be allowed only if traffic comes over ESP
Ingress	Default	Deny	-
Egress	IKE from Branch IP to Main Office IP	Permit	-
Egress	ESP from Branch IP to Main Office IP	Permit	-

**1 of 2**

**Table 130: Configuring the mesh VPN topology – Branch Office 1 (continued)**

Traffic direction	ACL parameter	ACL value	Description
Egress	IKE from Branch IP to Second Branch IP	Permit	This enables the PMTUD application to work
Egress	ESP from Branch IP to Second Branch IP	Permit	This traffic is tunnelled using VPN
Egress	ICMP from local tunnel endpoint to any IP address	Permit	This enables the PMTUD application to work
Egress	All allowed services from any local subnet to any IP address	Permit	This traffic is tunnelled using VPN
Egress	Default	Deny	-
			<b>2 of 2</b>

2. Configure Branch Office 2 as follows:

- The default gateway is the Internet interface
- VPN policy is configured on the Internet interface egress as follows:
  - Traffic from the local subnets to the First Spoke subnets -> encrypt, using tunnel mode IPsec, with the remote peer being the First Spoke
  - Traffic from the local subnets to any IP address -> encrypt, using tunnel mode IPsec, with the remote peer being the Main Office (VPN hub)
- An ACL is configured on the Internet interface to allow only the VPN / ICMP traffic. See [Table 131](#) for configuration settings.

**Note:**

For information about using access control lists, see [Configuring policy](#) on page 591.

**Table 131: Configuring the mesh VPN topology – Branch Office 2**

Traffic direction	ACL parameter	ACL value	Description
Ingress	IKE from Main Office IP to Branch IP	Permit	-
Ingress	ESP from Main Office IP to Branch IP	Permit	-
			<b>1 of 2</b>

**Table 131: Configuring the mesh VPN topology – Branch Office 2 (continued)**

Traffic direction	ACL parameter	ACL value	Description
Ingress	IKE from First Branch IP to Branch IP	Permit	-
Ingress	ESP from First Branch IP to Branch IP	Permit	-
Ingress	ICMP from any IP address to local tunnel endpoint	Permit	This enables the PMTUD application to work
Ingress	All allowed services from any IP address to any local subnet	Permit	Due to the definition of the VPN Policy, this will be allowed only if traffic comes over ESP
Ingress	Default	Deny	-
Egress	IKE from Branch IP to Main Office IP	Permit	-
Egress	ESP from Branch IP to Main Office IP	Permit	-
Egress	IKE from Branch IP to First Branch IP	Permit	This enables the PMTUD application to work
Egress	ESP from Branch IP to First Branch IP	Permit	This traffic is tunnelled using VPN
Egress	ICMP from local tunnel endpoint to any IP address	Permit	This enables the PMTUD application to work
Egress	All allowed services from any local subnet to any IP address	Permit	This traffic is tunnelled using VPN
Egress	Default	Deny	-

**2 of 2**

3. Configure the VPN Hub (Main Office) as follows:

- Static routing: Branch subnets -> Internet interface
- The VPN policy portion for the branch is configured as a mirror image of the branch, as follows:
  - Traffic from any IP address to branch local subnets -> encrypt, using tunnel mode IPSec
  - The remote peer is the VPN Spoke (Branch Internet address)

### Configuration example

#### 1. Configure Branch Office 1:

```
crypto isakmp policy 1
  encryption aes
  hash sha
  group 2
  exit
crypto isakmp peer address <Main Office Public Internet Static IP
                                Address>
  pre-shared-key <secret key>
  isakmp-policy 1
  exit
crypto isakmp peer address <Second Branch Office Public Internet Static
                                IP Address>
  pre-shared-key <secret key 2>
  isakmp-policy 1
  exit
crypto ipsec transform-set ts1 esp-3des esp-sha-hmac
  set pfs 2
  exit
crypto map 1
  set peer <Main Office Public Internet Static IP Address>
  set transform-set ts1
  exit
crypto map 2
  set peer <Second Branch Office Public Internet Static IP Address>
  set transform-set ts1
  exit
ip crypto-list 901
  local-address <Branch Office Public Internet Static IP Address>
  ip-rule 1
    source-ip <Branch Subnet1> <Branch Subnet1 Mask>
    destination-ip <Second Branch Subnet1> <Second Branch
                                                Subnet1 Mask>
    protect crypto map 2
    exit
  ip-rule 2
    source-ip <Branch Subnet2> <Branch Subnet2 Mask>
    destination-ip <Second Branch Subnet1> <Second Branch
                                                Subnet1 Mask>
    protect crypto map 2
    exit
  ip-rule 3
    source-ip <Branch Subnet1> <Branch Subnet1 Mask>
    destination-ip <Second Branch Subnet2> <Second Branch
                                                Subnet2 Mask>
    protect crypto map 2
    exit
```



```
ip-rule 4
    source-ip <Branch Subnet2> <Branch Subnet2 Mask>
    destination-ip <Second Branch Subnet2> <Second Branch
        Subnet2 Mask>
    protect crypto map 2
    exit
ip-rule 10
    source-ip <Branch Subnet1> <Branch Subnet1 Mask>
    destination-ip any
    protect crypto map 1
    exit
ip-rule 20
    source-ip <Branch Subnet2> <Branch Subnet2 Mask>
    destination-ip any
    protect crypto map 1
    exit
exit

ip access-control-list 301
    ip-rule 10
        source-ip any
        destination-ip any
        ip-protocol udp
        udp destination-port eq Ike
        composite-operation Permit
        exit
    ip-rule 11
        source-ip any
        destination-ip any
        ip-protocol udp
        udp destination-port eq Ike-nat-t
        composite-operation permit
        exit
    ip-rule 12
        source-ip any
        destination-ip any
        ip-protocol udp
        udp destination-port eq Ike-nat-t-vsua
        composite-operation permit
        exit
    ip-rule 20
        source-ip any
        destination-ip any
        ip-protocol esp
        composite-operation Permit
        exit
```

## Configuring IPsec VPN

```
ip-rule 30
    source-ip any
    destination-ip any
    ip-protocol icmp
    composite-operation Permit
    exit

ip-rule 40
    source-ip any
    destination-ip host <Branch Subnet1> <Branch Subnet1 Mask>
    composite-operation Permit
    exit

ip-rule 50
    source-ip any
    destination-ip host <Branch Subnet2> <Branch Subnet2 Mask>
    composite-operation Permit
    exit

ip-rule default
    composite-operation deny
    exit

exit

ip access-control-list 302
    ip-rule 10
        source-ip any
        destination-ip any
        ip-protocol udp
        udp destination-port eq Ike
        composite-operation Permit
        exit

    ip-rule 11
        source-ip any
        destination-ip any
        ip-protocol udp
        udp destination-port eq Ike-nat-t
        composite-operation permit
        exit

    ip-rule 12
        source-ip any
        destination-ip any
        ip-protocol udp
        udp destination-port eq Ike-nat-t-vsua
        composite-operation permit
        exit

    ip-rule 20
        source-ip any
        destination-ip any
        ip-protocol esp
        composite-operation Permit
        exit
```

```

ip-rule 30
    source-ip any
    destination-ip any
    ip-protocol icmp
    composite-operation Permit
    exit
ip-rule 40
    destination-ip any
    source-ip host <Branch Subnet1> <Branch Subnet1 Mask>
    composite-operation Permit
    exit
ip-rule 50
    destination-ip any
    source-ip host <Branch Subnet2> <Branch Subnet2 Mask>
    composite-operation Permit
    exit
ip-rule default
    composite-operation deny
    exit
exit

interface vlan 1.1
    ip-address <Branch Subnet1> <Branch Subnet1 Mask>
    pmi
    icc-vlan
    exit

interface vlan 1.2
    ip-address <Branch Subnet2> <Branch Subnet2 Mask>
    exit

interface fastethernet 10/2
    encapsulation PPPoE
    traffic-shape rate 256000
    ip Address <Branch Office Public Internet Static IP Address>
                                <Branch Office Public Internet network mask>
    ip crypto-group          901
    ip access-group          301 in
    ip access-group          302 out
    exit

ip default-gateway FastEthernet 10/2 high

```

**Note:**

The commands appearing in bold are the CLI commands that add the mesh capabilities to the simple hub and spokes configuration.

## Configuring IPsec VPN

### 2. Configure Branch Office 2:

```
crypto isakmp policy 1
  encryption aes
  hash sha
  group 2
  exit
crypto isakmp peer address <Main Office Public Internet Static IP
                                     Address>
  pre-shared-key <secret key>
  isakmp-policy 1
  exit
crypto isakmp peer address <First Branch Office Public Internet Static IP
                                     Address>
  pre-shared-key <secret key 2>
  isakmp-policy 1
  exit
crypto ipsec transform-set ts1 esp-3des esp-sha-hmac
  set pfs 2
  exit
crypto map 1
  set peer <Main Office Public Internet Static IP Address>
  set transform-set ts1
  exit
crypto map 2
  set peer <First Branch Office Public Internet Static IP Address>
  set transform-set ts1
  exit
ip crypto-list 901
  local-address <Branch Office Public Internet Static IP Address>
  ip-rule 1
    source-ip <Branch Subnet1> <Branch Subnet1 Mask>
    destination-ip <First Branch Subnet1> <Second Branch
                                                         Subnet1 Mask>
    protect crypto map 2
    exit
  ip-rule 2
    source-ip <Branch Subnet2> <Branch Subnet2 Mask>
    destination-ip <First Branch Subnet1> <Second Branch
                                                         Subnet1 Mask>
    protect crypto map 2
    exit
  ip-rule 3
    source-ip <Branch Subnet1> <Branch Subnet1 Mask>
    destination-ip <First Branch Subnet2> <Second Branch
                                                         Subnet2 Mask>
    protect crypto map 2
    exit
```

```
ip-rule 4
    source-ip <Branch Subnet2> <Branch Subnet2 Mask>
    destination-ip <First Branch Subnet2> <Second Branch
        Subnet2 Mask>
    protect crypto map 2
    exit
ip-rule 10
    source-ip <Branch Subnet1> <Branch Subnet1 Mask>
    destination-ip any
    protect crypto map 1
    exit
ip-rule 20
    source-ip <Branch Subnet2> <Branch Subnet2 Mask>
    destination-ip any
    protect crypto map 1
    exit
exit

ip access-control-list 301
    ip-rule 10
        source-ip any
        destination-ip any
        ip-protocol udp
        udp destination-port eq Ike
        composite-operation Permit
        exit
    ip-rule 11
        source-ip any
        destination-ip any
        ip-protocol    udp
        udp destination-port eq Ike-nat-t
        composite-operation permit
        exit
    ip-rule 12
        source-ip any
        destination-ip any
        ip-protocol    udp
        udp destination-port eq Ike-nat-t-vsu
        composite-operation permit
        exit
```

## Configuring IPsec VPN

```
ip-rule 20
    source-ip any
    destination-ip any
    ip-protocol esp
    composite-operation Permit
    exit
ip-rule 30
    source-ip any
    destination-ip any
    ip-protocol icmp
    composite-operation Permit
    exit
ip-rule 40
    source-ip any
    destination-ip host <Branch Subnet1> <Branch Subnet1 Mask>
    composite-operation Permit
    exit
ip-rule 50
    source-ip any
    destination-ip host <Branch Subnet2> <Branch Subnet2 Mask>
    composite-operation Permit
    exit
ip-rule default
    composite-operation deny
    exit
exit
ip access-control-list 302
    ip-rule 10
        source-ip any
        destination-ip any
        ip-protocol udp
        udp destination-port eq Ike
        composite-operation Permit
        exit
    ip-rule 11
        source-ip any
        destination-ip any
        ip-protocol udp
        udp destination-port eq Ike-nat-t
        composite-operation permit
        exit
    ip-rule 12
        source-ip any
        destination-ip any
        ip-protocol udp
        udp destination-port eq Ike-nat-t-vsua
        composite-operation permit
        exit
    ip-rule 20
        source-ip any
        destination-ip any
        ip-protocol esp
        composite-operation Permit
        exit
```

```

ip-rule 30
    source-ip any
    destination-ip any
    ip-protocol icmp
    composite-operation Permit
    exit
ip-rule 40
    destination-ip any
    source-ip host <Branch Subnet1> <Branch Subnet1 Mask>
    composite-operation Permit
    exit
ip-rule 50
    destination-ip any
    source-ip host <Branch Subnet2> <Branch Subnet2 Mask>
    composite-operation Permit
    exit
ip-rule default
    composite-operation deny
    exit
exit

interface vlan 1.1
    ip-address <Branch Subnet1> <Branch Subnet1 Mask>
    pmi
    icc-vlan
    exit

interface vlan 1.2
    ip-address <Branch Subnet2> <Branch Subnet2 Mask>
    exit

interface fastethernet 10/2
    encapsulation PPPoE
    traffic-shape rate 256000
    ip Address    <Branch Office Public Internet Static IP Address>
                  <Branch Office Public Internet network mask>
    ip crypto-group    901
    ip access-group    301 in
    ip access-group    302 out
exit

ip default-gateway FastEthernet 10/2 high

```

**Note:**

The commands appearing in bold are the CLI commands that add the mesh capabilities to the simple hub and spokes configuration.

## Full solution: hub and spoke with VPN

The full solution consists of a hub-and-spoke with VPN for data and VoIP control backup.

In this topology:

- There is a direct WAN connection to the Main Office for VoIP bearer and as primary VoIP control connection
- The Broadband Internet connection uses cable or DSL modem, with a static public IP address
- There is a VPN tunnel to the hub over the Internet for intranet data, and as backup connection for VoIP control
- The local hosts access the Internet directly through the local broadband connection
- The PSTN connection backs up the voice bearer

**Figure 47: Full solution: hub-and-spoke with VPN for data and VoIP control backup**

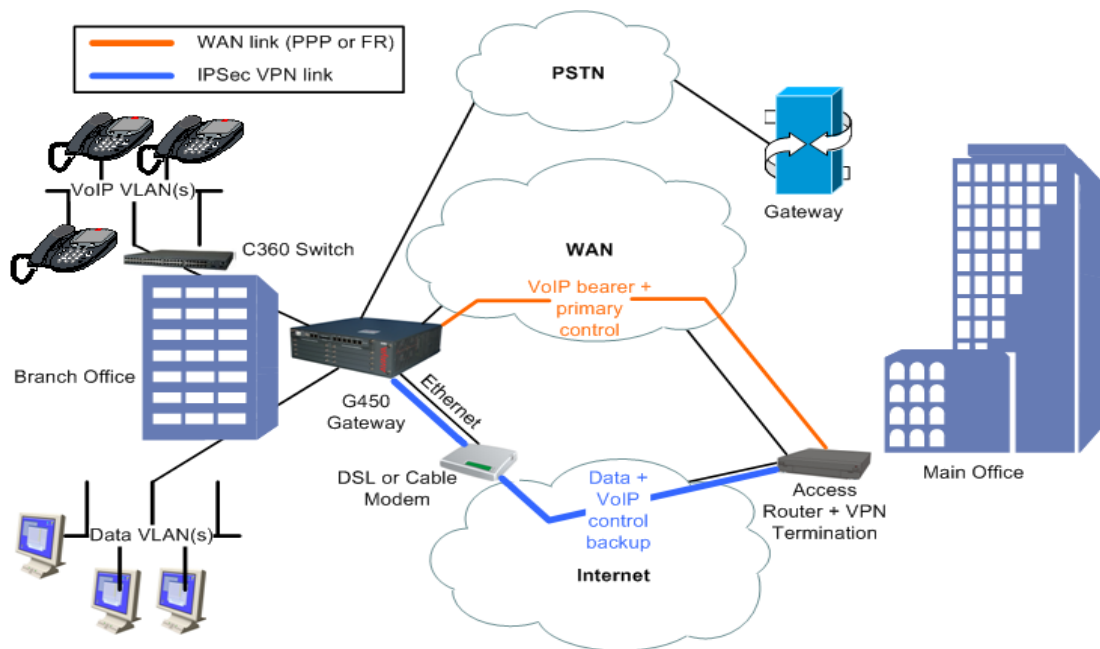



## Configuring hub-and-spoke with VPN for data and VoIP control backup

1. Configure the Branch Office as follows:

- The default gateway is the Internet interface
- VPN policy is configured on the Internet interface egress as follows:  
Traffic from the local GRE tunnel endpoint to the remote GRE tunnel endpoint -> encrypt, using IPSec tunnel mode, with the remote peer being the Main Office.
- An access control list (ACL) is configured on the Internet interface to allow only the VPN tunnel and ICMP traffic. See [Table 132](#) for configuration settings.

**Note:**

For information about using access control lists, see [Configuring policy](#) on page 591.

**Table 132: Configuring hub-and-spoke with VPN**

Traffic direction	ACL parameter	ACL value
Ingress	IKE (UDP/500) from remote tunnel endpoint to local tunnel endpoint	Permit
Ingress	ESP/AH from remote tunnel endpoint to local tunnel endpoint	Permit
Ingress	Remote GRE tunnel endpoint to local GRE tunnel endpoint	Permit
Ingress	Allowed ICMP from any IP address to local tunnel endpoint	Permit
Ingress	Default	Deny
Egress	IKE (UDP/500) from local tunnel endpoint to remote tunnel endpoint	Permit
Egress	Local GRE tunnel endpoint to remote GRE tunnel endpoint	Permit
Egress	All allowed services from any local subnet to any IP address	Permit
Egress	Allowed ICMP from local tunnel endpoint to any IP address	Permit
Egress	Default	Deny

- Policy Based Routing (PBR) is configured as follows on VoIP VLAN and loopback interfaces:
  - Destination IP = local subnets -> Route: DBR
  - DSCP = bearer -> Route: WAN
  - DSCP = control -> Route: 1. WAN 2. DBR

## Configuring IPsec VPN

### Note:

For information about PBR, see [Configuring policy-based routing](#) on page 619.

2. Configure the VPN Hub (Main Office) as follows:
  - The VPN policy portion for the branch is configured as a mirror image of the branch
  - The ACL portion for the branch is a mirror image of the branch, with some minor modifications
  - Static routing is configured as follows:
    - Branch subnets -> Internet interface
  - The PBR portion for the branch is configured as follows, on most interfaces:
    - Destination IP = branch VoIP subnet(s) or GW address (PMI), DSCP = bearer -> Route: WAN
    - Destination IP = branch VoIP subnet(s) or GW address (PMI), DSCP = control -> Route: 1. WAN 2. DBR
  - ACM is configured to route voice calls through PSTN when the main VoIP trunk is down

## Configuration example

```
crypto isakmp policy 1
  encryption aes
  hash sha
  group 2
  authentication pre-share
  exit
crypto isakmp peer address <Main Office Internet public Static IP
                                Address>
  pre-shared-key <key1>
  isakmp-policy 1
  exit
crypto ipsec transform-set ts1 esp-3des esp-sha-hmac
  exit
crypto map 1
  set peer <Main Office Internet public Static IP Address>
  set transform-set ts1
  exit

ip crypto-list 901
  local-address <Branch Office Public Internet Static IP Address>
  ip-rule 10
    source-ip <Branch data Subnet> <Branch data Subnet Mask>
    destination-ip any
    protect crypto map 1
    exit
  ip-rule 20
    source-ip <Branch voice Subnet> <Branch voice Subnet Mask>
    destination-ip any
    protect crypto map 1
    exit
  exit

ip access-control-list 301
  ip-rule 10
    source-ip any
    destination-ip any
    ip-protocol udp
    udp destination-port eq Ike
    composite-operation Permit
    exit
```

## Configuring IPsec VPN

```
ip-rule 11
  source-ip any
  destination-ip any
  ip-protocol udp
  udp destination-port eq Ike-nat-t
  composite-operation permit
  exit
ip-rule 12
  source-ip any
  destination-ip any
  ip-protocol udp
  udp destination-port eq Ike-nat-t-vsua
  composite-operation permit
  exit
ip-rule 20
  source-ip any
  destination-ip any
  ip-protocol esp
  composite-operation Permit
  exit
ip-rule 30
  source-ip any
  destination-ip any
  ip-protocol icmp
  composite-operation Permit
  exit
ip-rule 40
  source-ip any
  destination-ip <Branch data Subnet> <Branch data Subnet
  Mask>
  composite-operation Permit
  exit
ip-rule 50
  source-ip any
  destination-ip <Branch voice Subnet> <Branch voice Subnet
  Mask>
  composite-operation Permit
  exit
ip-rule default
  composite-operation deny
  exit
exit

ip access-control-list 302
  ip-rule 10
    source-ip any
    destination-ip any
    ip-protocol udp
    udp destination-port eq Ike
    composite-operation Permit
    exit
```

```
ip-rule 11
    source-ip any
    destination-ip any
    ip-protocol    udp
    udp destination-port eq Ike-nat-t
    composite-operation permit
    exit

ip-rule 12
    source-ip any
    destination-ip any
    ip-protocol    udp
    udp destination-port eq Ike-nat-t-vsuo
    composite-operation permit
    exit

ip-rule 20
    source-ip any
    destination-ip any
    ip-protocol esp
    composite-operation Permit
    exit

ip-rule 30
    source-ip any
    destination-ip any
    ip-protocol icmp
    exit

ip-rule 40
    source-ip <Branch data Subnet> <Branch data Subnet Mask>
    destination-ip    any
    composite-operation Permit
    exit

ip-rule 50
    source-ip <Branch voice Subnet> <Branch voice Subnet Mask>
    destination-ip    any
    composite-operation Permit
    exit

ip-rule default
    composite-operation deny
    exit

exit

interface vlan 1
    description "VoIP_VLAN"
    ip address <branch voice subnet IP address> <branch voice subnet mask>
    icc-vlan
    pmi
    exit

interface vlan 2
    description "DATA_VLAN"
    ip address <branch data subnet IP address> <branch data subnet mask>
    exit
```

## Configuring IPsec VPN

```
interface fastethernet 10/2
  encapsulation pppoe
  traffic-shape rate 256000
  ip address <Branch Office Internet public Static IP Address> <Branch
  Office Internet public net mask>

  ip crypto-group 901
  ip access-group      301 in
  ip access-group      302 out
  exit

interface serial 3/1
  ip address <Branch Office serial IP address> <Branch Office serial
  net mask>

  exit

ip next-hop-list 1
  next-hop-interface 1 serial 3/1
  exit
ip next-hop-list 2
  next-hop-interface 1 serial 3/1
  next-hop-interface 2 FastEthernet 10/2
  exit

ip pbr-list 801
  ip-rule 10
  !
  ! The following command specifies the Voice bearer
  !
  dscp 46
  next-hop list 1
  exit
  ip-rule 20
  !
  ! The following command specifies the Voice Control
  !
  dscp 34
  next-hop list 2
  exit
  ip-rule default
  next-hop PBR
  exit
  exit
```

---

## Typical failover applications

### Introduction to the failover mechanism

The failover mechanism provides switchover to backup peers in case of remote peer failure. To enable the failover mechanism, you must:

- Configure VPN keepalives, which check the remote peer periodically and announce when the remote peer is dead
- Provide backup peers and a mechanism for switching to a backup in case of remote peer failure

In addition to the GRE failover mechanism (see [Failover using GRE](#) on page 560), the G450 supports several additional failover mechanisms, as described below.

### Configuring VPN keepalives

VPN keepalives can dramatically improve the speed with which the G450 detects loss of connectivity with the remote VPN peer. Two types of VPN keepalives are available. You can use either or both methods:

- Enable DPD keepalives, a standard VPN keepalive, that check whether the remote peer is up. This type of detection can be used only if it is supported also by the remote peer.
- Bind peer status to an object tracker. Object trackers track the state (up/down) of remote devices using keepalive probes, and notify registered applications such as VPN when the state changes. Object tracking allows monitoring of hosts inside the remote peer's protected network, not just of the remote peer itself as in DPD.

### Backup peer mechanism

You can use any one of these alternate backup peer mechanisms:

- DNS server (see [Failover using DNS](#) on page 567). This method utilizes the G450's DNS resolver capability for dynamically resolving a remote peer's IP address via a DNS query.

Use this feature when your DNS server supports failover through health-checking of redundant hosts. On your DNS server, configure a hostname to translate to two or more redundant hosts, which act as redundant VPN peers. On the G450, configure that hostname as your remote peer. The G450 will perform a DNS query in order to resolve the hostname to an IP address before establishing an IKE connection. Your DNS server should be able to provide an IP address of a living host. The G450 will perform a new DNS query and try to re-establish the VPN connection to the newly provided IP address whenever it senses that the currently active remote peer stops responding. The G450 can sense that a peer is dead when IKE negotiation times-out, through DPD keepalives, and through object tracking.

## Configuring IPsec VPN

- Using the G450's peer-group entity (see [Failover using a peer-group](#) on page 575):
  - Define a peer-group. A peer-group is an ordered list of redundant remote peers, only one of which is active at any time. When the active peer is considered dead, the next peer in the list becomes the active remote peer.
  - When configuring a crypto map, point to the peer-group instead of to a single peer

## Failover using GRE

A branch with a G450 can connect to two or more VPN hub sites, in a way that will provide either redundancy or load sharing.

In this topology, the G450 is connected through its 10/100 WAN Ethernet port to a DSL modem.

- Define two GRE Tunnel interfaces:
  - GRE1 that leads to a Primary Main Office GRE End Point behind the VPN Hub Gateway
  - GRE2 that leads to a Backup Main Office GRE End Point behind the VPN Hub Gateway
- Define two VPNs
- Connectivity to the networks in Primary/Backup Main Office is determined through GRE keepalives. If network connectivity is lost due to failures in the WAN, in the Primary Main Office, the GRE keep-alive will fail and the GRE interface will transition to a "down" state.

### Redundancy and load sharing modes

The two GRE tunnels can then be used for branch to Primary/Backup Main Office in either Redundancy or Load sharing mode:

- **Redundancy.** GRE2 is configured as a backup interface for GRE1, and is activated only when GRE1 is down
- **Load sharing.** Both Tunnel interfaces are active. Routing protocols (RIP or OSPF) route traffic to destinations based on route cost and availability, as follows:

For two routes of equal cost to the same destination, one through the Primary Main Office and one through the Backup Main Office, OSPF will automatically distribute traffic through both routes, effectively sharing the load between routes.

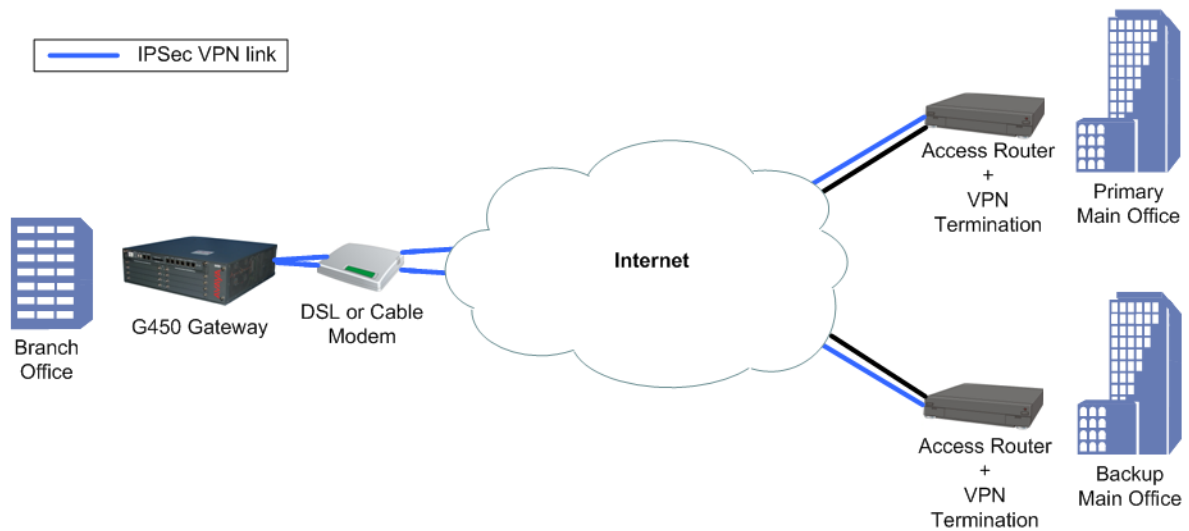

---

**Figure 48: Hub and spoke with hub redundancy/load sharing using GRE**



---

### Configuring VPN hub redundancy and load sharing topologies using GRE

1. Configure the Branch Office as follows:
  - VPN policy is configured on the Internet interface egress as follows:
    - GRE Traffic from the local tunnel endpoint to remote tunnel endpoint 1 -> encrypt, using IPSec tunnel mode, with the remote peer being tunnel endpoint 1
    - GRE Traffic from the local tunnel endpoint to remote tunnel endpoint 2 -> encrypt, using IPSec tunnel mode, with the remote peer being tunnel endpoint 2
  - An access control list (ACL) is configured on the Internet interface to allow only the VPN / ICMP traffic. See [Table 133](#) for configuration settings.

**Note:**

For information about using access control lists, see [Configuring policy](#) on page 591.

**Table 133: Configuring VPN hub redundancy and load sharing topologies**

Traffic direction	ACL parameter	ACL value
Ingress	IKE (UDP/500) from remote tunnel endpoint to local tunnel endpoint	Permit
Ingress	ESP/AH from remote tunnel endpoint to local tunnel endpoint	Permit
Ingress	Allowed ICMP from any IP address to local tunnel endpoint	Permit
Ingress	Default	Deny
Egress	IKE (UDP/500) from local tunnel endpoint to remote tunnel endpoint	Permit
Egress	All allowed services from any local subnet to any IP address	Permit
Egress	Allowed ICMP from local tunnel endpoint to any IP address	Permit
Egress	Default	Deny

- Configure dynamic routing (OSPF or RIP) to run over local data interfaces (data VLANs) and on the GRE interfaces
2. Configure the VPN Hubs (Main Offices) as follows:
- The VPN policy portion for the branch is configured as a mirror image of the branch
  - The ACL portion for the branch is a mirror image of the branch, with some minor modifications
  - The GRE Tunnel interface is configured for the branch
  - Dynamic routing (OSPF or RIP) is configured to run over the GRE interface to the branch

## Configuration example

```

crypto isakmp policy 1
  encryption aes
  hash sha
  group 2
  authentication pre-share
  exit
crypto isakmp peer address <Primary Main Office Internet public Static IP
                               Address>
  pre-shared-key <key1>
  isakmp-policy 1
  exit
crypto isakmp peer address <Backup Main Office Internet public Static
                               IP Address>
  pre-shared-key <key2>
  isakmp-policy 1
  exit
crypto ipsec transform-set ts1 esp-3des esp-sha-hmac
  exit
crypto map 1
  set peer <Primary Main Office Internet public Static IP Address>
  set transform-set ts1
  exit
crypto map 2
  set peer <Backup Main Office Internet public Static IP Address>
  set transform-set ts1
  exit

ip crypto-list 901
  local-address <Branch Office Internet public Static IP Address>
  ip-rule 1
    source-ip host <Branch GRE Tunnel end point IP Address>
    destination-ip host <Primary Main Office GRE Tunnel end point IP
                          Address>

    protect crypto map 1
    exit
  ip-rule 2
    source-ip host <Branch GRE Tunnel end point IP Address>
    destination-ip host <Backup Main Office GRE Tunnel end point
                          IP Address>

    protect crypto map 2
    exit
  exit

```

## Configuring IPsec VPN

```
ip access-control-list 301
  ip-rule 30
    source-ip any
    destination-ip any
    ip-protocol udp
    udp destination-port eq Ike
    composite-operation Permit
    exit
  ip-rule 31
    source-ip any
    destination-ip any
    ip-protocol udp
    udp destination-port eq Ike-nat-t
    composite-operation permit
    exit
  ip-rule 32
    source-ip any
    destination-ip any
    ip-protocol udp
    udp destination-port eq Ike-nat-t-vsua
    composite-operation permit
    exit
  ip-rule 40
    source-ip any
    destination-ip any
    ip-protocol esp
    composite-operation Permit
    exit
  ip-rule 50
    source-ip any
    destination-ip host <Branch Office Public Internet Static
                        IP Address>
    ip-protocol icmp
    composite-operation Permit
    exit
  ip-rule 60
    source-ip any
    destination-ip any
    composite-operation Permit
    exit
```

```

ip-rule 70
    source-ip host <Backup Main Office GRE Tunnel end point
                                IP Address>
    destination-ip host <Branch GRE Tunnel end point IP
                                Address>

    composite-operation Permit
    exit
ip-rule default
    composite-operation deny
    exit
exit

ip access-control-list 302
ip-rule 30
    source-ip any
    destination-ip any
    ip-protocol udp
    udp destination-port eq Ike
    composite-operation Permit
    exit
ip-rule 31
    source-ip any
    destination-ip any
    ip-protocol    udp
    udp destination-port eq Ike-nat-t
    composite-operation permit
    exit
ip-rule 32
    source-ip any
    destination-ip any
    ip-protocol    udp
    udp destination-port eq Ike-nat-t-vsu
    composite-operation permit
    exit
ip-rule 40
    source-ip any
    destination-ip any
    ip-protocol esp
    composite-operation Permit
    exit
ip-rule 50
    source-ip any
    destination-ip any
    ip-protocol icmp
    exit
ip-rule 60
    source-ip host <Branch GRE Tunnel end point IP Address>
    destination-ip host <Primary Main Office GRE Tunnel end
                                point IP Address>

    composite-operation Permit
    exit

```

## Configuring IPsec VPN

```
ip-rule 70
    source-ip host <Branch GRE Tunnel end point IP Address>
    destination-ip host <Backup Main Office GRE Tunnel end
                                point IP Address>
    composite-operation Permit
    exit
ip-rule default
    composite-operation deny
    exit
exit

interface vlan 1
    description "VoIP_VLAN"
    ip address <branch voice subnet IP address> <branch voice subnet mask>
    icc-vlan
    pmi
    exit

interface vlan 2
    description "DATA_VLAN"
    ip address <branch data subnet IP address> <branch data subnet mask>
    exit

interface fastethernet 10/2
    encapsulation pppoe
    traffic-shape rate 256000
    ip address <Branch Office Internet public Static IP Address> <Branch
                                Office Internet public net mask>

    ip crypto-group 901
    ip access-group      301 in
    ip access-group      302 out
    exit

interface Tunnel 1
    !
    ! The following two backup commands specify redundant mode.
    ! To specify load-sharing mode, omit them.
    !
    backup interface tunnel 2
    backup delay 20 15
    keepalive 10 3
    tunnel source <Branch GRE Tunnel end point IP Address>
    tunnel destination <Primary MainPrimary Main Office GRE Tunnel end
                                point IP Address>

    ip address 10.10.10.1 255.255.255.252
    exit
interface Tunnel 2
    keepalive 10 3
    tunnel source <Branch GRE Tunnel end point IP Address>
    tunnel destination <Backup Main Office GRE Tunnel end point IP
                                Address>

    ip address 20.20.20.1 255.255.255.252
    exit
```

```

ip route <Primary Main Office GRE Tunnel end point IP Address>
                255.255.255.255 FastEthernet 10/2 high
ip route <Backup Main Office GRE Tunnel end point IP Address>
                255.255.255.255 FastEthernet 10/2 high

router ospf
 network 10.10.10.0 0.0.0.3 area 0.0.0.0
 network 20.20.20.0 0.0.0.3 area 0.0.0.0
 exit
    
```

## Failover using DNS

The VPN DNS topology provides failover by utilizing the DNS resolver feature.

Use this feature when your DNS server supports failover through health-checking of redundant hosts. On your DNS server configure a hostname to translate to two or more redundant hosts, which act as redundant VPN peers. On the G450 configure that hostname as your remote peer. The G450 will perform a DNS query in order to resolve the hostname to an IP address before establishing an IKE connection. Your DNS server should be able to provide an IP address of a living host. The G450 will perform a new DNS query and try to re-establish the VPN connection to the newly provided IP address whenever it senses that the currently active remote peer stops responding. The G450 can sense that a peer is dead when IKE negotiation times-out through DPD keepalives and through object tracking.

**Figure 49: VPN DNS topology**

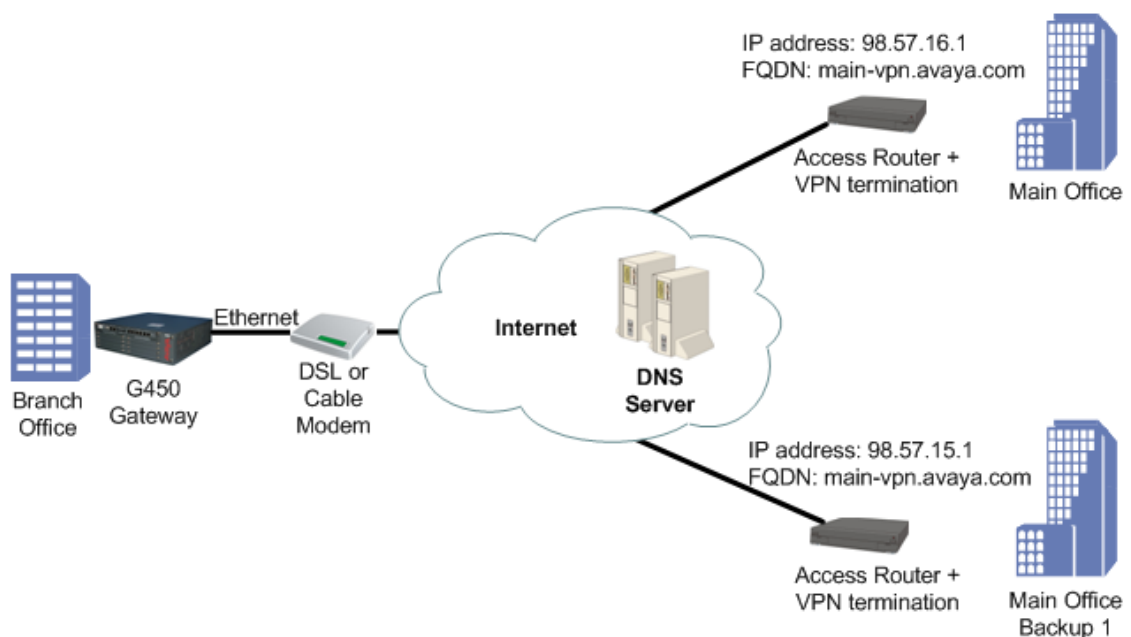

**Note:**

For an explanation of DNS resolver, see [DNS resolver](#) on page 88.

### Configuring the VPN DNS topology

1. Define the private VLAN1 and VLAN2 interfaces (IP address and mask), and define one of them as the PMI and ICC-VLAN.
2. Define the public FastEthernet10/2 interface (IP address and mask).
3. Define the default gateway (the IP of the next router).
4. Define the DNS name-server-list and the IP address of the DNS server.

**Note:**

Alternatively, you can use DHCP Client or PPPoE to dynamically learn the DNS server's IP address. Use the `ip dhcp client request` command when using DHCP client, or use the `ppp ipcp dns request` command when using PPPoE.

5. Define the ISAKMP policy, using the `crypto isakmp policy` command.
6. Define the remote peer with FQDN, using the `crypto isakmp peer address` command, including:
  - the pre-shared key
  - the ISAKMP policy
7. Define the IPSEC transform-set, using the `crypto ipsec transform-set` command.
8. Define the crypto map, using the `crypto map` command.
9. Define the crypto list as follows:
  - Set the local address to the public interface name (for example, FastEthernet 10/2.0)
  - For each private interface, define an ip-rule using the following format:
    - source-ip <private subnet> <private subnet wild card mast>.  
For example, 10.10.10.0 0.0.0.255
    - destination-ip any
    - protect crypto map 1
10. Define the ingress access control list (ACL) to protect the device from Incoming traffic from the public interface, as follows:
  - Permit DNS traffic to allow clear (unencrypted) DNS traffic
  - Permit IKE Traffic (UDP port 500) for VPN control traffic (IKE)
  - Permit ESP traffic (IP Protocol ESP) for VPN data traffic (IPSEC)
  - Permit ICMP traffic, to support PMTU application support, for a better fragmentation process



- For each private subnet, add a permit rule, with the destination being the private subnet and the source being any. This traffic will be allowed only if it tunnels under the VPN, because of the crypto list.
  - Define all other traffic (default rule) as deny in order to protect the device from non-secure traffic
11. Define the egress access control list to protect the device from sending traffic that is not allowed to the public interface (optional):
    - Permit DNS traffic to allow clear (unencrypted) DNS traffic
    - Permit IKE Traffic (UDP port 500) for VPN control traffic (IKE)
    - Permit ESP traffic (IP Protocol ESP) for VPN data traffic (IPSEC)
    - Permit ICMP traffic, to support PMTU application support, for a better fragmentation process
    - For each private subnet, add a permit rule, with the source being the private subnet, and the destination being any
    - Define all other traffic (default rule) as deny in order to protect the device from sending non-secure traffic
  12. Activate the crypto list, the ingress access control list, and the egress access control list, on the public interface.

## Configuring IPsec VPN

### Configuration example

```
!  
! Define the Private Subnet1  
!  
interface vlan 1  
  description "Branch Subnet1"  
  ip address 10.0.10.1 255.255.255.0  
  icc-vlan  
  pmi  
  exit  
  
!  
! Define the Private Subnet2  
!  
interface vlan 2  
  description "Branch Subnet2"  
  ip address 10.0.20.1 255.255.255.0  
  exit  
  
!  
! Define the Public Subnet  
!  
interface fastethernet 10/2  
  ip address 100.0.0.2 255.255.255.0  
  exit  
  
!  
! Define the default gateway to be on the public subnet  
!  
ip default-gateway 100.0.0.1  
  
!  
! Define the DNS name server  
! that is accessible without VPN.  
!  
ip domain name-server-list 1  
  name-server 1 123.124.125.126  
  exit  
  
!  
! Define the IKE Entity  
!  
crypto isakmp policy 1  
  encryption aes  
  hash sha  
  group 2  
  authentication pre-share  
  exit
```

```

!
! Define the remote peer as FQDN (DNS Name)
!
crypto isakmp peer fqdn main-vpn.avaya.com
  pre-shared-key <key1>
  isakmp-policy 1
  exit

!
! Define the IPSEC Entity
!
crypto ipsec transform-set ts1 esp-3des esp-sha-hmac
  exit

!
! Define the VPN Tunnel
!
crypto map 1
  set peer main-vpn.avaya.com
  set transform-set ts1
  exit

!
! Define the crypto list for the public interface
!
ip crypto-list 901
  local-address "Fast Ethernet 10/2.0"
!
! ip-rule 5 allows un-encrypted traffic for DNS
!
  ip-rule 5
    source-ip      any
    destination-ip 123.124.125.126
    no protect
    exit
  ip-rule 10
    source-ip      10.0.10.0 0.0.0.255
    destination-ip any
    protect crypto map 1
    exit
  ip-rule 20
    source-ip      10.0.20.0 0.0.0.255
    destination-ip any
    protect crypto map 1
    exit
  exit

```

## Configuring IPsec VPN

```
!  
! Define the Ingress access control list for the public interface  
!  
ip access-control-list 301  
  ip-rule 5  
    source-ip          any  
    destination-ip     any  
    ip-protocol        udp  
    udp destination-port eq Dns  
    composite-operation Permit  
    exit  
  ip-rule 10  
    source-ip          any  
    destination-ip     any  
    ip-protocol        udp  
    udp destination-port eq Ike  
    composite-operation Permit  
    exit  
  ip-rule 11  
    source-ip any  
    destination-ip any  
    ip-protocol        udp  
    udp destination-port eq Ike-nat-t  
    composite-operation permit  
    exit  
  ip-rule 12  
    source-ip any  
    destination-ip any  
    ip-protocol        udp  
    udp destination-port eq Ike-nat-t-vsua  
    composite-operation permit  
    exit  
  ip-rule 20  
    source-ip          any  
    destination-ip     any  
    ip-protocol        esp  
    composite-operation Permit  
    exit  
  ip-rule 30  
    source-ip          any  
    destination-ip     any  
    ip-protocol        icmp  
    composite-operation Permit  
    exit  
  ip-rule 40  
    source-ip          any  
    destination-ip     10.0.10.0 0.0.0.255  
    composite-operation Permit  
    exit  
  ip-rule 50  
    source-ip          any  
    destination-ip     10.0.20.0 0.0.0.255  
    composite-operation Permit  
    exit
```

```
ip-rule default
    composite-operation deny
    exit
exit
!
! Define the Egress access control list for the public interface
!
ip access-control-list 302
    ip-rule 5
        source-ip          any
        destination-ip     any
        ip-protocol        udp
        udp destination-port eq dns
        composite-operation Permit
        exit
    ip-rule 10
        source-ip          any
        destination-ip     any
        ip-protocol        udp
        udp destination-port eq Ike
        composite-operation Permit
        exit
    ip-rule 11
        source-ip any
        destination-ip any
        ip-protocol    udp
        udp destination-port eq Ike-nat-t
        composite-operation permit
        exit
    ip-rule 12
        source-ip any
        destination-ip any
        ip-protocol    udp
        udp destination-port eq Ike-nat-t-vsu
        composite-operation permit
        exit
    ip-rule 20
        source-ip          any
        destination-ip     any
        ip-protocol        esp
        composite-operation Permit
        exit
    ip-rule 30
        source-ip          any
        destination-ip     any
        ip-protocol        icmp
        composite-operation Permit
        exit
    ip-rule 40
        source-ip          10.0.10.0 0.0.0.255
        destination-ip     any
        composite-operation Permit
        exit
```

## Configuring IPsec VPN

```
ip-rule 50
  source-ip          10.0.20.0 0.0.0.255
  destination-ip     any
  composite-operation Permit
  exit
ip-rule default
  composite-operation deny
  exit
  exit
!
! Activate the crypto list and the access control list on the public
interface
!
interface fastethernet 10/2
  ip crypto-group 901
  ip access-group 301 in
  ip access-group 302 out
  exit
```

## Failover using a peer-group

The failover VPN topology utilizes a peer-group which lists a group of redundant peers. At any point in time, only one peer is active and acting as the remote peer. An object tracker monitors the state of the active peer. If the active peer is presumed dead, the next peer in the peer-group becomes the active remote peer. For more information on object trackers, see [Object tracking](#) on page 298.

**Figure 50: Failover VPN topology using a peer-group**

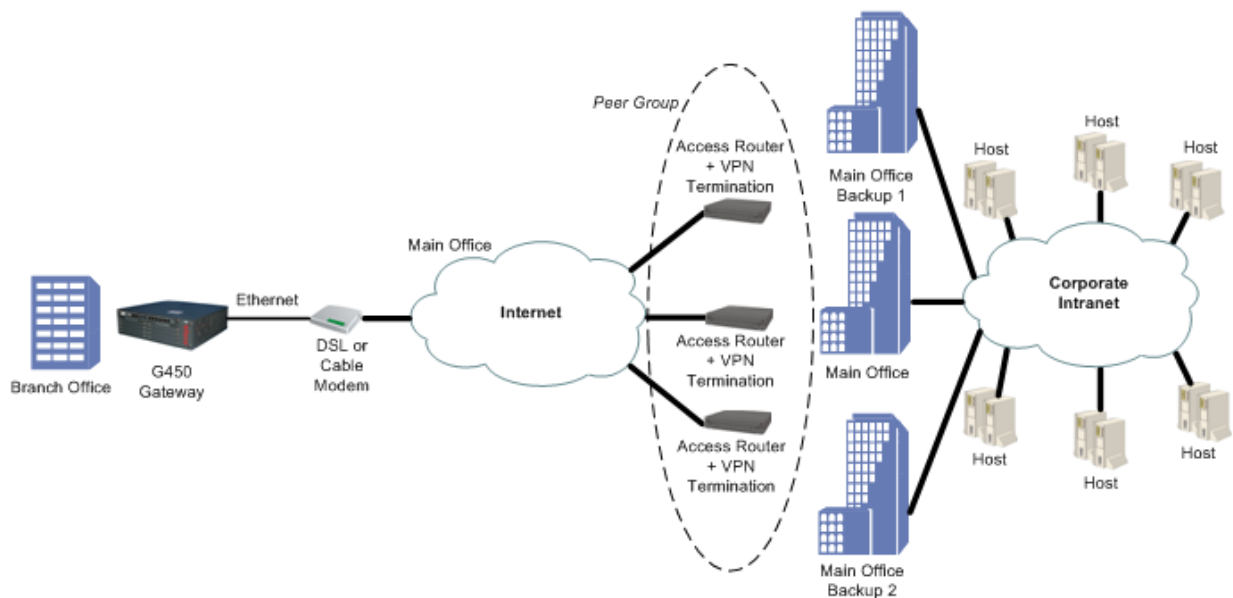

### Configuring the failover VPN topology using a peer-group

1. Define the private VLAN1 and VLAN2 interfaces (IP address and mask), and define one of them as the PMI and ICC-VLAN.
2. Define the public FastEthernet 10/2 interface (IP address and mask).
3. Define the default gateway (the IP address of the next router).
4. Define the object tracking configuration, and define when an object tracker is considered down, as follows:

Define a track list that will monitor (by ICMP) five hosts behind the specific peer. If two or more hosts are not working then the object tracker is down. The G450 will then pass on to the next peer in the peer group list.
5. Define the ISAKMP policy, using the **crypto isakmp policy** command.
6. Define the 3 remote peers, using the **crypto isakmp peer address** command, and specify for each one:
  - the pre-shared key
  - the ISAKMP policy
  - keepalive track. This track is the object tracker that checks if the peer is still alive. If an active peer is considered dead, the next peer in the peer group becomes the active peer.
7. Define a peer group that include all three remote peers, using the **crypto isakmp peer-group** command.
8. Define the IPSEC transform-set, using the **crypto ipsec transform-set** command.
9. Define the Crypto map entity, using the **crypto map** command.
10. Define the crypto list as follows:
  - Set the local address to the public interface name (for example, FastEthernet 10/2.0).
  - For each private interface, define an ip-rule using the following format:
    - source-ip <private subnet> <private subnet wild card mast>.  
For example, 10.10.10.0 0.0.0.255
    - destination-ip any
    - protect crypto map 1
11. Define the ingress access control list to protect the device from incoming traffic from the public interface, as follows:
  - Permit IKE Traffic (UDP port 500) for VPN control traffic (IKE)

#### Note:

If you are using NAT Traversal, you must also open UDP port 4500 and 2070.

- Permit ESP traffic (IP Protocol ESP) for VPN data traffic (IPSEC)



- Permit ICMP traffic, to support PMTU application support, for a better fragmentation process
  - For each private subnet, add a permit rule, with the destination being the private subnet, and the source being any. This traffic will be allowed only if it tunnels under the VPN, because of the crypto list.
  - Define all other traffic (default rule) as deny in order to protect the device from non-secure traffic
12. Optionally, define the egress access control list to protect the device from sending traffic that is not allowed to the public interface:
- Permit IKE Traffic (UDP port 500) for VPN control traffic (IKE)

**Note:**

If you are using NAT Traversal, you also need to open UDP port 4500 and 2070.

- Permit ESP traffic (IP Protocol ESP) for VPN data traffic (IPSEC)
  - Permit ICMP traffic, to support the PMTU application, for a better fragmentation process
  - For each private subnet add a permit rule, with the source being the private subnet, and the destination being any
  - Define all other traffic (default rule) as deny in order to protect the device from sending non-secure traffic
13. Activate the crypto list, the ingress access control list, and the egress access control list, on the public interface.

## Configuring IPsec VPN

### Configuration example

```
!  
! Define the Private Subnet1  
!  
interface vlan 1  
  description "Branch Subnet1"  
  ip address 10.0.10.1 255.255.255.0  
  icc-vlan  
  pmi  
  exit  
  
!  
! Define the Private Subnet2  
!  
interface vlan 2  
  description "Branch Subnet2"  
  ip address 10.0.20.1 255.255.255.0  
  exit  
  
!  
! Define the Public Subnet  
!  
interface fastethernet 10/2  
  ip address 100.0.0.2 255.255.255.0  
  exit  
  
!  
! Define the default gateway the public interfce  
!  
ip default-gateway 100.0.0.1
```

```

!
! We wish to check 5 hosts in the Corporate intranet behind the current VPN
! remote peer, and if 2 or more hosts don't work then keepalive-track will fail ,
! and we will move to the next peer in the peer-group
!
rtr 1
    type echo protocol ipIcmpEcho <host1 IP>
    exit
rtr-schedule 1 start-time now life forever
rtr 2
    type echo protocol ipIcmpEcho <host2 IP>
    exit
rtr-schedule 2 start-time now life forever
rtr 3
    type echo protocol ipIcmpEcho <host3 IP>
    exit
rtr-schedule 3 start-time now life forever
rtr 4
    type echo protocol ipIcmpEcho <host4 IP>
    exit
rtr-schedule 4 start-time now life forever
rtr 5
    type echo protocol ipIcmpEcho <host5 IP>
    exit
rtr-schedule 5 start-time now life forever
track 11 rtr 1
    exit
track 12 rtr 2
    exit
track 13 rtr 3
    exit
track 14 rtr 4
    exit
track 15 rtr 5
    exit
track 1 list threshold count
    threshold count up 5 down 3
    object 11
    object 12
    object 13
    object 14
    object 15
    exit
!
! Define the IKE Entity
!
crypto isakmp policy 1
    encryption aes
    hash sha
    group 2
    authentication pre-share
    exit

```

## Configuring IPsec VPN

```
! Define the remote peers (3 main offices)
!
crypto isakmp peer address <First Main Office VPN address>
  pre-shared-key <key1>
  isakmp-policy 1
  keepalive-track 1
  exit

crypto isakmp peer address <Second Main Office VPN address>
  pre-shared-key <key2>
  isakmp-policy 1
  keepalive-track 1
  exit

crypto isakmp peer address <Third Main Office VPN address>
  pre-shared-key <key3>
  isakmp-policy 1
  keepalive-track 1
  exit

crypto isakmp peer-group main-hubs
  set peer <First      Main Office VPN address>
  set peer <Second Main Office VPN address>
  set peer <Third     Main Office VPN address>
  exit

!
! Define the IPSEC Entity
!
crypto ipsec transform-set ts1 esp-3des esp-sha-hmac
  exit

!
! Define the VPN Tunnel
!
crypto map 1
  set peer-group main-hubs
  set transform-set ts1
  exit

! Define the crypto list for the public interface
!
ip crypto-list 901
  local-address "Fast Ethernet 10/2.0"
  ip-rule 10
    source-ip      10.0.10.0 0.0.0.255
    destination-ip any
    protect crypto map 1
    exit
  ip-rule 20
    source-ip      10.0.20.0 0.0.0.255
    destination-ip any
    protect crypto map 1
    exit
  exit
```

```
!  
! Define the Ingress access control list for the public interface  
!  
ip access-control-list 301  
  ip-rule 10  
    source-ip          any  
    destination-ip     any  
    ip-protocol        udp  
    udp destination-port eq Ike  
    composite-operation Permit  
    exit  
  ip-rule 11  
    source-ip any  
    destination-ip any  
    ip-protocol        udp  
    udp destination-port eq Ike-nat-t  
    composite-operation permit  
    exit  
  ip-rule 12  
    source-ip any  
    destination-ip any  
    ip-protocol        udp  
    udp destination-port eq Ike-nat-t-vsu  
    composite-operation permit  
    exit  
  ip-rule 20  
    source-ip          any  
    destination-ip     any  
    ip-protocol        esp  
    composite-operation Permit  
    exit  
  ip-rule 30  
    source-ip          any  
    destination-ip     any  
    ip-protocol        icmp  
    composite-operation Permit  
    exit  
  ip-rule 40  
    source-ip          any  
    destination-ip     10.0.10.0 0.0.0.255  
    composite-operation Permit  
    exit  
  ip-rule 50  
    source-ip          any  
    destination-ip     10.0.20.0 0.0.0.255  
    composite-operation Permit  
    exit  
  ip-rule default  
    composite-operation deny  
    exit  
  exit
```

## Configuring IPsec VPN

```
! Define the Egress access control list for the public interface
!
ip access-control-list 302
  ip-rule 10
    source-ip          any
    destination-ip     any
    ip-protocol        udp
    udp destination-port eq Ike
    composite-operation Permit
    exit
  ip-rule 11
    source-ip any
    destination-ip any
    ip-protocol        udp
    udp destination-port eq Ike-nat-t
    composite-operation permit
    exit
  ip-rule 12
    source-ip any
    destination-ip any
    ip-protocol        udp
    udp destination-port eq Ike-nat-t-vsu
    composite-operation permit
    exit
  ip-rule 20
    source-ip          any
    destination-ip     any
    ip-protocol        esp
    composite-operation Permit
    exit
  ip-rule 30
    source-ip          any
    destination-ip     any
    ip-protocol        icmp
    composite-operation Permit
    exit
  ip-rule 40
    source-ip          10.0.10.0 0.0.0.255
    destination-ip     any
    composite-operation Permit
    exit
  ip-rule 50
    source-ip          10.0.20.0 0.0.0.255
    destination-ip     any
    composite-operation Permit
    exit
  ip-rule default
    composite-operation deny
    exit
  exit
```

```

!
! Activate the crypto list and the access control list on the public interface
!
interface fastethernet 10/2
 ip crypto-group 901
 ip access-group 301 in
 ip access-group 302 out
 exit
    
```

## Checklist for configuring site-to-site IPSec VPN

Use [Table 134](#) to gather the information for simple G450 site-to-site IPSec VPN.

**Table 134: Checklist for configuring site-to-site IPSec VPN**

Parameter	Possible values	Actual value
1. VPN License	You require the serial number to obtain the VPN license	
2. Type of connection to the ISP	<ul style="list-style-type: none"> <li>● ADSL</li> <li>● Cable Modem</li> </ul>	
3. VPN Interface	<ul style="list-style-type: none"> <li>● FastEthernet10/2</li> <li>● Serial port X/Y</li> </ul>	
4. VPN Local IP Address		
<ul style="list-style-type: none"> <li>● Type</li> </ul>	<ul style="list-style-type: none"> <li>● Static                             <ul style="list-style-type: none"> <li>- If static, provide:                                     <ul style="list-style-type: none"> <li>IP Address</li> <li>Mask</li> <li>Next-hop Router</li> </ul> </li> </ul> </li> <li>● Dynamic (DHCP/PPPoE)</li> </ul>	
5. Coordinating with the VPN Remote peer		
a.) VPN IKE (Control) Phase 1 Parameters		
<ul style="list-style-type: none"> <li>– Encryption</li> </ul>	<ul style="list-style-type: none"> <li>● des</li> <li>● 3des</li> <li>● aes</li> <li>● aes-192</li> <li>● aes-256</li> </ul>	

**Table 134: Checklist for configuring site-to-site IPsec VPN (continued)**

Parameter	Possible values	Actual value
– Authentication Hash	<ul style="list-style-type: none"> <li>● sha</li> <li>● md5</li> </ul>	
– DH Group	<ul style="list-style-type: none"> <li>● 1</li> <li>● 2</li> <li>● 5</li> <li>● 14</li> </ul>	
– Lifetime seconds	<ul style="list-style-type: none"> <li>● 60 to 86,400 default: 86,400 (1 day)</li> </ul>	
<b>b.) VPN IPSEC (Data) Phase 2 Parameters</b>		
– Encryption	<ul style="list-style-type: none"> <li>● esp-des</li> <li>● esp-3des</li> <li>● esp-aes</li> <li>● esp-aes-192</li> <li>● esp-aes-256</li> </ul>	
– Authentication Hash	<ul style="list-style-type: none"> <li>● esp-sha-hmac</li> <li>● esp-md5-hmac</li> </ul>	
– IP compression	<ul style="list-style-type: none"> <li>● enable (comp-lzs)</li> <li>● disable</li> </ul>	
– PFS Group	<ul style="list-style-type: none"> <li>● no pfs (default)</li> <li>● 1</li> <li>● 2</li> <li>● 5</li> <li>● 14</li> </ul>	
– Lifetime seconds	<ul style="list-style-type: none"> <li>● 120 to 86,400 default: 3,600 (1 hour)</li> </ul>	
– Lifetime kilobytes	<ul style="list-style-type: none"> <li>● 2,560 to 536,870,912 default: 4,608,000 kb</li> <li>● disable</li> </ul>	
<b>6. Which packets should be secured</b>		
a. Protect rules matching options	<ul style="list-style-type: none"> <li>● IP source address</li> <li>● IP destination address</li> </ul>	
		<b>2 of 3</b>



Table 134: Checklist for configuring site-to-site IPsec VPN (continued)

Parameter	Possible values	Actual value
b. Bypass rules matching options	<ul style="list-style-type: none"> <li>● IP source address</li> <li>● IP destination address</li> <li>● udp</li> <li>● tcp</li> <li>● dscp</li> <li>● fragment</li> <li>● icmp</li> <li>● IP protocol</li> </ul>	
7. The remote peer (crypto isakmp peer) parameters		
a. Remote peer	<ul style="list-style-type: none"> <li>● IP address</li> <li>● FQDN (dns name)</li> </ul>	
b. Pre-shared key	<ul style="list-style-type: none"> <li>● 1 to 127 alphanumeric characters. 1 to 64 bytes in hexadecimal notation</li> </ul>	
8. If the branch IP is dynamic		
	<ul style="list-style-type: none"> <li>● If the branch IP is an initiator, set initiate mode to none (device is a responder)</li> <li>● If the branch IP is a responder, set initiate mode to aggressive (device is an initiator)</li> <li>● Set self identity to identify the device in the remote peer</li> </ul>	
		<b>3 of 3</b>

## Summary of VPN commands

For more information about these commands, see *Avaya G450 CLI Reference*, 03-300437.

Table 135: VPN CLI commands

Root level command	First level command	Second level command	Description
<code>clear crypto isakmp</code>			Flush a specific ISAKMP SA or all the ISAKMP SAs
<code>clear crypto sa</code>			Clear all or specific IPsec SAs
<code>clear crypto sa counters</code>			Clear the crypto SA counters
<code>crypto ipsec nat-transparency udp-encapsulation</code>			Re-enable NAT Traversal if it was disabled
<code>crypto ipsec transform-set</code>			Enter the IKE phase 2 (IPsec) transform-set context and create or edit IPsec parameters for the VPN tunnel
	<code>mode</code>		Set security-association lifetime
	<code>set pfs</code>		Specify whether each IKE phase 2 negotiation will employ PFS and, if yes, which Diffie-Hellman group to employ
	<code>set security-association lifetime</code>		Set the IKE phase 2 (IPsec) SA lifetime
<code>crypto isakmp invalid-spi-recovery</code>			Enable invalid SPI recovery (default setting)
<code>crypto isakmp nat keepalive</code>			Re-enable NAT Traversal keepalive if it was disabled, and configure the keepalive interval. This command keeps the NAT devices tables updated.
<code>crypto isakmp peer</code>			Enter the crypto ISAKMP peer context and create or edit an ISAKMP peer

Table 135: VPN CLI commands (continued)

Root level command	First level command	Second level command	Description
	<b>continuous-channel</b>		Enable continuous-channel IKE, which keeps the IKE phase1 session always up and running, even if there is no traffic
	<b>description</b>		Enter a description for the ISAKMP peer
	<b>initiate mode</b>		Specify which IKE Phase-1 mode to use when communicating with the peer: aggressive or none
	<b>isakmp-policy</b>		Set the ISAKMP policy for the ISAKMP peer
	<b>keepalive</b>		Enable DPD keepalives that check whether the remote peer is up
	<b>keepalive-track</b>		Bind an object tracker to a remote VPN peer or to an interface, to check whether the remote peer or the interface is up
	<b>pre-shared-key</b>		Configure the IKE pre-shared key
	<b>self-identity</b>		Set the identity of this device
	<b>suggest-key</b>		Generate a random string which you can use as a pre-shared key for IKE. You must use the same key on both peers.
<b>crypto isakmp peer-group</b>			Enter the crypto ISAKMP peer-group context and create or edit an ISAKMP peer group
	<b>description</b>		Enter a description for the ISAKMP peer group
	<b>set peer</b>		Add a peer to the peer-group
<b>crypto isakmp policy</b>			Enter the crypto ISAKMP policy context and create or edit IKE Phase 1 parameters
	<b>authentication</b>		Set the authentication of ISAKMP policy to pre-shared secret

Table 135: VPN CLI commands (continued)

Root level command	First level command	Second level command	Description
	<b>description</b>		Enter a description for the ISAKMP policy
	<b>encryption</b>		Set the encryption algorithm for an ISAKMP policy
	<b>group</b>		Set the Diffie-Hellman group for an ISAKMP policy
	<b>hash</b>		Set the hash method for an ISAKMP policy
	<b>lifetime</b>		Set the lifetime of the ISAKMP SA in seconds
<b>crypto isakmp</b>			Generate a random string which you can use as a pre-shared key for IKE. You must use the same key on both peers.
	<b>suggest-key</b>		
<b>crypto map</b>			Enter crypto map context and create or edit a crypto map
	<b>continuous-channel</b>		In a crypto ISAKMP peer context, enable continuous-channel IKE, which keeps the IKE phase1 session always up and running, even if there is no traffic
	<b>description</b>		Enter a description for the crypto map
	<b>set dscp</b>		Set the DSCP value in the tunneled packet
	<b>set peer</b>		Attach a peer to a crypto map
	<b>set peer-group</b>		Attach a peer-group to a crypto map
	<b>set transform-set</b>		Configure the transform-set
<b>interface</b> ( <b>fastethernet</b>   <b>dialer</b>   <b>serial</b>   <b>vlan</b> )			Enter the FastEthernet, Dialer, Serial, or VLAN interface context

Table 135: VPN CLI commands (continued)

Root level command	First level command	Second level command	Description
	<code>crypto ipsec df-bit</code>		Set the Don't-Fragment bit to clear mode or copy mode
	<code>crypto ipsec minimal-pmtu</code>		Set the minimal PMTU value that can be applied to an SA when the G450 participates in PMTUD for the tunnel pertaining to that SA
	<code>ip crypto-group</code>		Activate a crypto list in the context of the interface on which the crypto list is activated
<code>ip crypto-list</code>			Enter crypto list context and create or edit a crypto list
	<code>ip-rule</code>		Enter ip-rule context and create or modify a specific rule
		<code>description</code>	Enter a description for the ip-rule in the ip crypto list
		<code>destination-ip</code>	Specify the destination IP address of packets to which the current rule applies
		<code>protect crypto map</code>	Protect traffic that matches this rule by applying the IPSec processing configured by the specific crypto map
		<code>source-ip</code>	Indicate that the current rule applies to packets from the specified source IP address
	<code>local-address</code>		Set the local IP address for the IPSec tunnels derived from this crypto list
<code>show crypto ipsec sa</code>			Display the IPSec SA database and related runtime, statistical, and configuration information
<code>show crypto ipsec transform-set</code>			Display the configuration for the specified transform-set or all transform-sets
<code>show crypto isakmp peer</code>			Display crypto ISAKMP peer configuration

Table 135: VPN CLI commands (continued)

Root level command	First level command	Second level command	Description
<code>show crypto</code> <code>isakmp peer-group</code>			Display crypto ISAKMP peer-group configuration
<code>show crypto</code> <code>isakmp policy</code>			Display ISAKMP policy configuration
<code>show crypto</code> <code>isakmp sa</code>			Display the ISAKMP SA database status
<code>show crypto map</code>			Display all or specific crypto map configurations
<code>show ip</code> <code>active-lists</code>			Display information about a specific policy list or all lists
<code>show ip</code> <code>crypto-list</code>			Display all or specific crypto list configurations
			<b>5 of 5</b>

# Chapter 20: Configuring policy

Policy lists enable you to control the ingress and egress of traffic to a router or port. You can use policies to manage security, determine packet priority through an interface, implement quality of service, or determine routing for a specific application or user. Each policy list consists of a set of rules determining the behavior of a packet entering or leaving the interface on which the list is applied.

---

## Types of policy lists

There are various policy lists on the G450, including access control lists, QoS lists, and Policy based routing.

---

## Access control lists

Access lists have the following parts:

- **Global rules.** A set of rules that are executed before the list is evaluated
- **Rule list.** A list of filtering rules and actions for the G450 to take when a packet matches the rule. Match actions on this list are pointers to the composite operation table.
- **Actions (composite operation table).** A table that describes actions to be performed when a packet matches a rule. The table includes pre-defined actions, such as permit and deny. You can configure more complex rules. See [Composite operations](#) on page 605.

## Access control list rule specifications

You can use access control lists to control which packets are authorized to pass through an interface. When a packet matches a rule on the access control list, the rule specifies whether the G450:

- Accepts the packet or drops the packet
- Sends an ICMP error reply if it drops the packet
- Sends an SNMP trap if it drops the packet

## Network security using access control lists

The primary use of access control lists is to act as a component of network security. You can use access control lists to determine which applications, networks, and users can access hosts on your network. Also, you can restrict internal users from accessing specific sites or applications outside the network. Access control lists can be based on permitting or denying specific values or groups of IP addresses, protocols, ports, IP fragments, or DSCP values. [Figure 51](#) illustrates how access control lists are used to control traffic into and out of your network.

**Figure 51: Network security using access control lists**

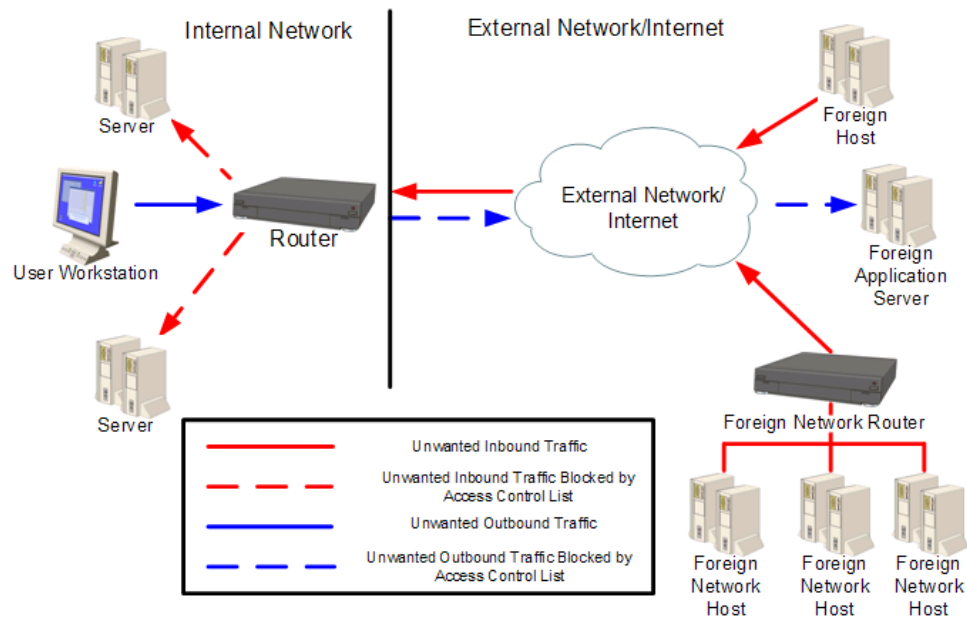



---

## QoS lists

You can use QoS lists to change the DSCP and Ethernet IEEE 802.1p CoS fields in packets. Changing these fields adjusts the priority of packets meeting the criteria of the QoS list. DSCP values are mapped to a CoS value. Rules can be created determining the priority behavior of either individual DSCP values or CoS values, and can be based on specific values or groups of IP addresses, protocols, ports, IP fragments, or DSCP values. When a packet matches a rule on the QoS list, the G450 sets one or both of the QoS fields in the packet. The following table shows these QoS fields:

**Table 136: QoS fields**

Layer	QoS field	Allowed values
2	802.1p	0–7
3	DSCP	0–63

Each QoS list also includes a DSCP table. The DSCP table enables you to set one or both of the QoS fields in a packet, based on the previous value of the `DSCP` field in the packet.

QoS lists have the following parts:

- **Rule list.** A list of filtering rules and actions for the G450 to take when a packet matches the rule. Match actions on this list are pointers to the composite operation table.
- **Actions (composite operation table).** A table that describes actions to be performed when a packet matches a rule. The table includes pre-defined actions, such as permit and deny. You can configure more complex rules. Refer to [Composite operations](#) on page 605.
- **DSCP map.** A table that contains DSCP code points and match action pairs. Match actions are pointers to the composite operation table. Refer to [DSCP table](#) on page 608.

---

## Policy-based routing

You can use policy-based routing to determine the routing path a packet takes based on the type of packet, or the packet's source or destination IP addresses, or its `DSCP` field. This enables you to route different types of traffic over different routes or interfaces. For example, you use policy-based routing to route voice traffic over a WAN interface and data traffic over the Internet. Policy-based routing is implemented by means of policy-based routing (PBR) lists. PBR lists are similar in many respects to access control lists and QoS lists. However, since there are also some key differences, policy-based routing is explained in a separate chapter. Refer to [Configuring policy-based routing](#) on page 619.

---

## Managing policy lists

You can manage policy lists on the Avaya G450 Media Gateway with CLI commands. You can also manage policy lists throughout your network with Avaya QoS Manager. Avaya QoS Manager is part of Avaya Integrated Management. [Figure 52](#) illustrates the operation of policy lists on the Avaya G450 Media Gateway:

---

**Figure 52: Policy lists**

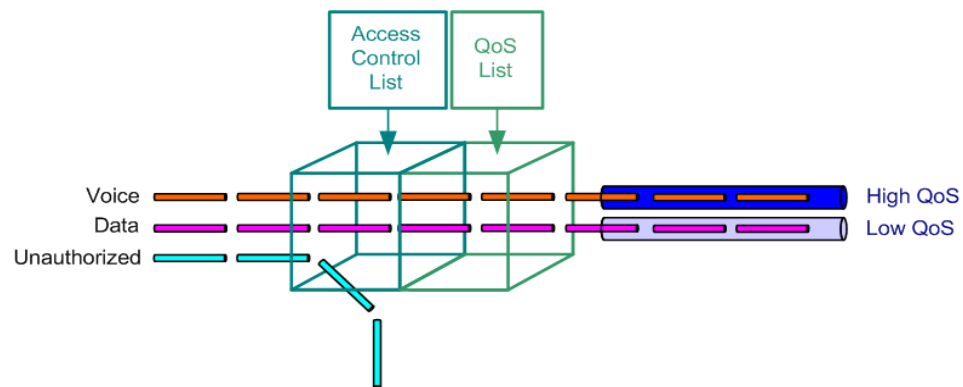

---

## Defining policy lists

You can create and edit policy lists, and define the list identification attributes. You can also delete an unnecessary policy list.

---

### Creating and editing a policy list

To create or edit a policy list, you must enter the context of the list. If the list already exists, you can edit the list from the list context. If the list does not exist, entering the list context creates the list.

To create or edit an access control list, enter **ip access-control-list** followed by a list number in the range 300-399. The G450 includes one pre-configured access control list. The pre-configured access control list is list number 300.

For example, to create access control list 301, enter the following command:

```
ip access-control-list 301
```

To create or edit a QoS list, enter **ip qos-list** followed by a list number in the range 400-499. The G450 includes one pre-configured QoS list. The pre-configured QoS list is list number 400.

For example, to create a new QoS list 401, enter the following command:

```
ip qos-list 401
```

You can create a new policy list based on an existing list by using the **ip policy-list-copy** command, followed by the name of the list from which you want to copy. The source and destination lists must be of the same type. For example, you cannot copy an access control list to a QoS list.

The following example creates a new access control list, number 340, based on access control list 330. You can then enter the context of access control list 340 to modify it.

```
G450-001(super)# ip policy-list-copy 330 340
Done!
```

Once you have entered the list context, you can perform the following actions:

- **Configure rules.** See [Defining rules](#) on page 599
- **Configure composite operations.** See [Composite operations](#) on page 605
- **Configure DSCP mapping (QoS lists only).** See [DSCP table](#) on page 608

---

## Defining list identification attributes

The policy list attributes including name, owner, and cookie, are used by Avaya QoS Manager software to identify policy lists.

1. Enter the context of the policy list in which you want to define the attribute.
2. Enter one of the following commands, followed by a text string or integer:
  - **name.** Defines a list name (text string). The default value is *owner*.
  - **owner.** Defines a list owner (text string). The default value is *list#<listnumber>*.
  - **cookie.** Defines a list cookie (integer). The Avaya QoS Manager uses the cookie attribute internally. Normally, you should not change this attribute.

To set a policy list attribute to its default setting, use the **no** form of the appropriate command. For example, to set a list to its default name, use the command **no name**.

To view the attributes, use the **show list** command in the context of the list.

### Default actions

When no rule matches a packet, the G450 applies the default action for the list. The following table shows the default action for each type of policy list:

List	Default action
Access control list	Accept all packets
QoS list	No change to the priority or DSCP

---

### Deleting a policy list

To delete an access control list, enter **no ip access-control-list** followed by the number of the list you want to delete. To delete a QoS list, enter **no ip qos-list** followed by the number of the list you want to delete.

---

### Attaching policy lists to an interface

Attached to each interface on the Avaya G450 Media Gateway are policy lists, including the ingress access control list, ingress QoS list, egress access control list, and egress QoS list.

**Note:**

You can also attach PBR lists to certain interfaces, but PBR lists are not attached to any interface by default.

---

### Packets entering the interface

When a packet enters the G450 through an interface, the G450 applies the policy lists in the following order:

1. Apply the ingress access control list.
2. If the ingress access control list does not drop the packet:
  - a. Apply the ingress QoS list.
  - b. Apply the PBR list (if any).

The packet enters the G450 through the interface.

## Packets exiting the interface

When a packet exits the G450 through an interface, the G450 applies the policy lists in the following order:

1. Apply the egress access control list.
2. If the egress access control list does not drop the packet, apply the egress QoS list.

The packet exits the G450 through the interface.

[Figure 53](#) illustrates the order in which the G450 applies policy lists to packets.

**Figure 53: Applying Policy Lists to Packets**

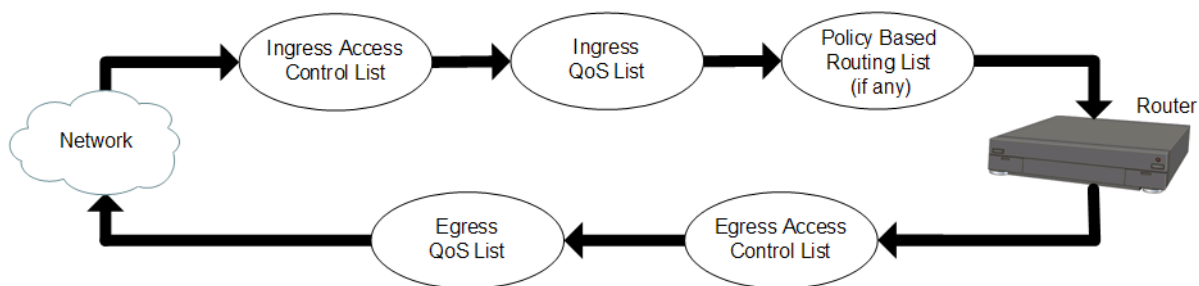

You can configure which policy lists are attached to each interface. You can choose the ingress access control list and the egress access control list from among the access control lists that are configured on the G450. You can choose the ingress QoS list and the egress QoS list from among the QoS lists that are configured on the G450.

To attach an access control list to an interface as its ingress access control list, enter the interface context and enter **ip access-group list number in**. To attach an access control list to an interface as its egress access control list, enter the interface context and enter **ip access-group list number out**.

To attach a QoS list to an interface as its ingress QoS list, enter the interface context and enter **ip qos-group list number in**. To attach an access control list to an interface as its egress QoS list, enter the interface context and enter **ip qos-group list number out**.

For example, the following sequence of commands attach policy lists to the VLAN 2 interface. Access control list 301 becomes the ingress access control list for VLAN 2. QoS list 401 becomes the egress QoS list for VLAN 2.

```

G450-001# interface vlan 2
G450-001(if:VLAN 2)# ip access-group 301 in
Done!
G450-001(if:VLAN 2)# ip qos-group 401 out
Done!
  
```

## Configuring policy

To remove a list from an interface, use the **no** form of the appropriate command.

For example, if the ingress access control list for the VLAN 1 interface is list number 302, you can remove the list from the interface by entering the following commands:

```
G450-001(super)# interface vlan 1
G450-001(super-if:VLAN 1)# no ip access-group in
Done!
```

### Note:

You cannot change or delete a default list. You cannot change or delete any list when it is attached to an interface. In order to change or delete a list that is attached to an interface, you must first remove the list from the interface. You can then change or delete the list. After changing the list, you can reattach the list to the interface.

---

## Device-wide policy lists

You can attach a policy list (other than a policy-based routing list) to every interface on the G450 using one command. To do this, attach a list to the Loopback 1 interface. For more information, see [Attaching policy lists to an interface](#) on page 596.

### Note:

If you attach a policy list to a Loopback interface other than Loopback 1, the policy list has no effect.

When you attach a policy list to the Loopback 1 interface, thereby creating a device-wide policy list, and you also attach policy lists to specific interfaces, the G450 applies the lists in the following order:

- Incoming packets:
  - a. Apply the ingress policy lists that are attached to the interface
  - b. Apply the device-wide ingress policy lists
- Outgoing packets:
  - a. Apply the device-wide egress policy lists
  - b. Apply the egress policy lists that are attached to the interface

---

## Defining global rules

In an access control list, you can define global rules for packets that contain IP fragments and IP options. These rules apply to all packets. This is in contrast to individual rules, which apply to packets that match certain defined criteria. See [Defining rules](#) on page 599.

The G450 applies global rules before applying individual rules.

1. Enter the context of the access control list in which you want to define the rule.
2. Enter one of the following commands, followed by the name of a composite command:
  - **ip-fragments-in**. Applies to incoming packets that contain IP fragments
  - **ip-option-in**. Applies to incoming packets that contain IP options

The composite command can be any command defined in the composite operation list. These commands are case-sensitive. To view the composite operation list for the access control list you are working with, use the command **show composite-operation** in the context of the access control list.

The following example defines a rule in access control list 301 that denies access to all incoming packets that contain IP fragments:

```
G450-001(super)# ip access-control-list 301
G450-001(super/ACL 301)# ip-fragments-in Deny
Done!
```

---

## Defining rules

You can configure policy rules to match packets based on one or more of the following criteria:

- Source IP address, or a range of addresses
- Destination IP address, or a range of addresses
- IP protocol, such as TCP, UDP, ICMP, or IGMP
- Source TCP or UDP port or a range of ports
- Destination TCP or UDP port or a range of ports
- ICMP type and code
- Fragment
- DSCP

## Configuring policy

Use IP wildcards to specify a range of source or destination IP addresses. The zero bits in the wildcard correspond to bits in the IP address that remain fixed. The one bits in the wildcard correspond to bits in the IP address that can vary. Note that this is the opposite of how bits are used in a subnet mask.

For access control lists, you can require the packet to be part of an established TCP session. If the packet is a request for a new TCP session, the packet does not match the rule. You can also specify whether an access control list accepts packets that have an `IP option` field.

---

## Editing and creating rules

To create or edit a policy rule, you must enter the context of the rule. If the rule already exists, you can edit the rule from the rule context. If the rule does not exist, entering the rule context creates the rule.

1. Enter the context of the list in which you want to create or edit a rule.
2. Enter `ip-rule` followed by the number of the rule you want to create or edit. For example, to create rule 1, enter `ip-rule 1`.

You can use the `description` command in the rule context to add a description of the rule. This description is used in the AccessViolation Policy trap to identify and describe the IP rule in which the trap was caused.

To view the existing rules in a list, enter the list's context and then enter `ip show-rule`. Each list starts with a default rule. Each new rule has the same default parameters as the default rule. The default rule appears as follows:

```
G450-001(super-ACL 301)# show ip-rule
```

Index	Protocol DSCP	IP	Wildcard	Port	Operation Fragment rule
-----	-----	-----	-----	-----	-----
Deflt	Any	Src Any		Any	Permit
	Any	Dst Any		Any	No

This rule permits all packets.

---

## Policy lists rule criteria

Rules work in the following ways, depending on the type of list and the type of information in the packet:

- Layer 4 rules in an access control list with a *Permit* operation are applied to non-initial fragments



- Layer 4 rules in an access control list with a *Deny* operation are not applied to non-initial fragments, and the device continues checking the next IP rule. This is to prevent cases in which fragments that belong to other L4 sessions may be blocked by the other L4 session which is blocked.
- Layer 3 rules apply to non-initial fragments
- Layer 3 rules that include the fragment criteria do not apply to initial fragments or non-fragment packets
- Layer 3 rules that do not include the fragment criteria apply to initial fragments and non-fragment packets
- Layer 4 rules apply to initial fragments and non-fragment packets
- Layer 3 and Layer 4 rules in QoS and policy-based routing lists apply to non-initial fragments

## IP protocol

To specify the IP protocol to which the rule applies, enter **ip-protocol** followed by the name of an IP protocol. If you want the rule to apply to all protocols, use **any** with the command. If you want the rule to apply to all protocols except for one, use the **no** form of the command, followed by the name of the protocol to which you do not want the rule to apply.

For example, the following command specifies the UDP protocol for rule 1 in QoS list 401:

```
G450-001(QoS 401/rule 1)# ip-protocol udp
```

The following command specifies any IP protocol except IGMP for rule 3 in access control list 302:

```
G450-001(ACL 302/ip rule 3)# no ip-protocol igmp
```

## Source and destination IP address

To specify a range of source and destination IP addresses to which the rule applies, use the commands **source-ip** and **destination-ip**, followed by the IP range criteria. The IP range criteria can be one of the following:

- **A range.** Type two IP addresses to set a range of IP addresses to which the rule applies
- **A single address.** Type **host**, followed by an IP address, to set a single IP address to which the rule applies
- **A wildcard.** Type **host**, followed by an IP address using wildcards, to set a range of IP addresses to which the rule applies
- **All addresses.** Type **any** to apply the rule to all IP addresses

Use the **no** form of the appropriate command to specify that the rule does not apply to the IP address or addresses defined by the command.

## Configuring policy

For example, the following command specifies a source IP address of 10.10.10.20 for rule 1 in access control list 301:

```
G450-001(ACL 301/ip rule 1)# source-ip host 10.10.10.20
```

The following command allows any destination IP address for rule 3 in QoS list 404:

```
G450-001(QoS 404/rule 3)# destination-ip any
```

The following command specifies a source IP address in the range 10.10.0.0 through 10.10.255.255 for rule 1 in access control list 301:

```
G450-001(ACL 301/ip rule 1)# source-ip 10.10.0.0 0.0.255.255
```

The following command specifies a source IP address outside the range 64.236.24.0 through 64.236.24.255 for rule 7 in access control list 308:

```
G450-001(ACL 308/ip rule 7)# no source-ip 64.236.24.0 0.0.0.255
```

The following command specifies a source IP address in the range 64.<any>.24.<any> for rule 6 in access control list 350:

```
G450-001(ACL 350/ip rule 6)# source-ip 64.*.24.*
```

## Source and destination port range

To specify a range of source and destination ports to which the rule applies, use the following commands, followed by either port name or port number range criteria:

- **tcp source-port**. The rule applies to TCP packets from ports that match the defined criteria
- **tcp destination-port**. The rule applies to TCP packets to ports that match the defined criteria
- **udp source-port**. The rule applies to UDP packets from ports that match the defined criteria
- **udp destination-port**. The rule applies to UDP packets to ports that match the defined criteria

This command also sets the IP protocol parameter to TCP or UDP.

### Port name or number range criteria

- **A range**. Type **range**, followed by two port numbers, to set a range of port numbers to which the rule applies
- **Equal**. Type **eq**, followed by a port name or number, to set a port name or port number to which the rule applies

- **Greater than.** Type **gt**, followed by a port name or port number, to apply the rule to all ports with a name or number greater than the specified name or number
- **Less than.** Type **lt**, followed by a port name or port number, to apply the rule to all ports with a name or number less than the specified name or number
- **All.** Type **any** to apply the rule to all port names and port numbers

Use the **no** form of the appropriate command to specify that the rule does not apply to the ports defined by the command.

For example, the following command specifies a source TCP port named *telnet* for rule 1 in access control list 301:

```
G450-001(ACL 301/ip rule 1)# tcp source-port eq telnet
```

The following command specifies any destination UDP port less than 1024 for rule 3 in QoS list 404:

```
G450-001(QoS 404/rule 3)# udp destination-port lt 1024
```

The following command specifies any destination TCP port in the range 5000 through 5010 for rule 1 in access control list 301:

```
G450-001(ACL 301/ip rule 1)# tcp destination-port range 5000 5010
```

The following command specifies any source TCP port except a port named *http* for rule 7 in access control list 304:

```
G450-001(ACL 304/ip rule 7)# no tcp source-port eq http
```

## ICMP type and code

To apply the rule to a specific type of ICMP packet, use the **icmp** command. This command sets the IP protocol parameter to ICMP, and specifies an ICMP type and code to which the rule applies. You can specify the ICMP type and code by integer or text string, as shown in the examples below. To apply the rule to all ICMP packets except the specified type and code, use the **no** form of this command.

For example, the following command specifies an ICMP echo reply packet for rule 1 in QoS list 401:

```
G450-001(QoS 401/rule 1)# icmp Echo-Reply
```

The following command specifies any ICMP packet except type 1 code 2 for rule 5 in access control list 321:

```
G450-001(ACL 321/ip rule 5)# no icmp 1 2
```

### TCP establish bit (access control lists only)

In access control lists, you can use the **tcp established** command to specify that the rule only applies to packets that are part of an established TCP session (a session in which the TCP ACK or RST flag is set). Use the **no** form of this command to specify that the rule applies to all TCP packets. In either case, the command also sets the IP protocol parameter to TCP.

For example, the following command specifies that rule 6 in access control list 301 only matches packets that are part of an established TCP session:

```
G450-001(ACL 301/ip rule 6)# tcp established
```

### Fragments

Enter **fragment** to apply the rule to non-initial fragments. You cannot use the **fragment** command in a rule that includes UDP or TCP source or destination ports.

```
G450-001(super-ACL 301/ip rule 5)# fragment
Done!
G450-001(super-ACL 301/ip rule 5)#
```

### DSCP

Enter **dscp**, followed by a DSCP value (from 0 to 63), to apply the rule to all packets with the specified DSCP value. Use the **no** form of the command to remove the rule from the list.

For example, the following command specifies that rule 5 in access control list 301 only matches packets in which the DSCP value is set to 56:

```
G450-001(ACL 301/ip rule 5)# dscp 56
```

### Composite Operation

For instructions on assigning a composite operation to an IP rule, see [Adding composite operation to an IP rule](#) on page 607.

---

## Composite operations

A composite operation is a set of operations that the G450 can perform when a rule matches a packet. Every rule in a policy list has an **operation** field that specifies a composite operation. The **operation** field determines how the G450 handles a packet when the rule matches the packet.

There are different composite operations for access control list rules and QoS list rules. For each type of list, the G450 includes a pre-configured list of composite operations. You cannot change or delete pre-configured composite operations. You can define additional composite operations.

---

### Pre-configured composite operations for access control lists

[Table 137](#) lists the pre-configured entries in the composite operation table for rules in an access control list:

**Table 137: Pre-configured access control list composite operations**

No	Name	Access	Notify	Reset Connection
0	Permit	forward	no trap	no reset
1	Deny	deny	no trap	no reset
2	Deny-Notify	deny	trap all	no reset
3	Deny-Rst	deny	no trap	reset
4	Deny-Notify-Rst	deny	trap all	reset

Each column represents the following:

- **No.** A number identifying the operation
- **Name.** A name identifying the operation. Use this name to attach the operation to a rule.
- **Access.** Determines whether the operation forwards (forward) or drops (deny) the packet
- **Notify.** Determines whether the operation causes the G450 to send a trap when it drops a packet
- **Reset Connection.** Determines whether the operation causes the G450 to reset the connection when it drops a packet

## Pre-configured composite operations for QoS lists

[Table 138](#) lists the pre-configured entries in the composite operation table for rules in a QoS list:

**Table 138: Pre-configured QoS list composite operations**

No	Name	CoS	DSCP	Trust
0	CoS0	cos0	no change	No
1	CoS1	cos1	no change	No
2	CoS2	cos2	no change	No
3	CoS3	cos3	no change	No
4	CoS4	cos4	no change	No
5	CoS5	cos5	no change	No
6	CoS6	cos6	no change	No
7	CoS7	cos7	no change	No
9	No-Change	no change	no change	No
10	Trust-DSCP	-	-	DSCP
11	Trust-DSCP-CoS	-	-	DSCP and CoS

Each column represents the following:

- **No.** A number identifying the operation
- **Name.** A name identifying the operation. Use this name to attach the operation to a rule.
- **CoS.** The operation sets the `Ethernet IEEE 802.1p CoS` field in the packet to the value listed in this column
- **DSCP.** The operation sets the `DSCP` field in the packet to the value listed in this column
- **Trust.** Determines how to treat packets that have been tagged by the originator or other network devices. If the composite operation is set to `Trust-DSCP`, the packet's CoS tag is set to 0 before the QoS list rules and DSCP map are executed. If the composite operation is set to `CoSX`, the DSCP map is ignored, but the QoS list rules are executed on the `Ethernet IEEE 802.1p CoS` field. (For example, the composite operation `CoS3` changes the CoS field to 3.) If the composite operation is set to `Trust-DSCP-CoS`, the operation uses the greater of the CoS or the DSCP value. If the composite operation is set to `No Change`, the operation makes no change to the packet's QoS tags.

---

## Configuring composite operations

You can configure additional composite operations for QoS lists. You can also edit composite operations that you configured. You cannot edit pre-configured composite operations.

**Note:**

You cannot configure additional composite operations for access control lists, since all possible composite operations are pre-configured.

1. Enter the context of a QoS list.
2. Enter **composite-operation** followed by an index number. The number must be 12 or higher, since numbers 1 through 11 are assigned to pre-configured lists.
3. Use one or more of the following commands to set the parameters of the composite operation:
  - **dscp**. Determines the value to which the rule resets the packet's DSCP field. To ignore the DSCP field, use the argument **no change**, or enter **no dscp**.
  - **cos**. Determines the value to which the rule resets the packet's CoS field. To ignore the CoS field, use the argument **no change**, or enter **no cos**.
4. Enter **name**, followed by a text string, to assign a name to the composite operation. You must assign a name to the composite operation, because when you attach the composite operation to a rule, you use the name, not the index number, to identify the composite operation.

---

## Adding composite operation to an ip rule

You can add or delete composite operations to or from an IP rule by using the **[no] composite-operation** command, followed by the name of the composite operation you want to add or delete, in the context of the rule. See [Composite operation example](#) on page 608 for an example.

### Composite operation example

The following commands create a new composite operation called `dscp5` and assign the new composite operation to rule 3 in QoS list 402. If the packet matches a rule, the G450 changes the value of the `DSCP` field in the packet to 5.

```
G450-001# ip qos-list 402
G450-001(QoS 402)# composite-operation 12
G450-001(QoS 402/cot 12)# name dscp5
Done!
G450-001(QoS 402/cot 12)# dscp 5
Done!
G450-001(QoS 402/cot 12)# cos no-change
Done!
G450-001(QoS 402/cot 12)# exit
G450-001(QoS 402)# ip-rule 3
G450-001(QoS 402/rule 3)# composite-operation dscp5
Done!
```

---

## DSCP table

DSCP is a standards-defined method for determining packet priority through an interface, either into or out of a router.

There are three ways you can use the **DSCP** field:

- **Classifier.** Select a packet based on the contents of some portions of the packet header and apply behavioral policies based on service characteristic defined by the DSCP value
- **Marker.** Set the `DSCP` field based on the traffic profile, as determined by the defined rules
- **Metering.** Check compliance to traffic profile using filtering functions

A DSCP value can be mapped to a Class of Service (CoS). Then, for a CoS, rules can be applied to determine priority behavior for packets meeting the criteria for the entire CoS. Multiple DSCP values can be mapped to a single CoS. Rules can also be applied to individual DSCP values.

The default value of DSCP in a packet is 0, which is defined as “best-effort.” You can determine a higher priority for a traffic type by changing the DSCP value of the packet using a QoS rule or composite operation.

Each QoS list includes a DSCP table. A DSCP lists each possible DSCP value, from 0 to 63. For each value, the list specifies a composite operation. See [Pre-configured composite operations for QoS lists](#) on page 606.



QoS rules on the list take precedence over the DSCP table. If a QoS rule other than the default matches the packet, the G450 does not apply the DSCP table to the packet. The G450 applies only the operation specified in the QoS rule.

---

## Changing an entry in the DSCP table

1. Enter the context of a QoS list.
2. Enter **dscp-table** followed by the number of the DSCP value for which you want to change its composite operation.
3. Enter **composite-operation** followed by the name of the composite operation you want to execute for packets with the specified DSCP value.

The following commands specify the pre-configured composite operation CoS5 for DSCP table entry 33 in QoS list 401. Every packet with DSCP equal to 33 is assigned CoS priority 5.

```
G450-001# ip qos-list 401
G450-001(QoS 401)# dscp-table 33
G450-001(QoS 401/dscp 33)# composite-operation CoS5
Done!
```

The following commands create a new composite operation called dscp5 and assign the new composite operation to DSCP table entry 7 in QoS list 402. Every packet with DSCP equal to 7 is assigned a new DSCP value of 5.

```
G450-001(super)# ip qos-list 402
G450-001(super/QoS 402)# composite-operation 12
G450-001(super/QoS 402/CompOp 12)# name dscp5
Done!
G450-001(super/QoS 402/CompOp 12)# dscp 5
Done!
G450-001(super/QoS 402/CompOp 12)# cos No-Change
Done!
G450-001(super/QoS 402/CompOp 12)# exit
G450-001(super/QoS 402)# dscp-table 7
G450-001(super/QoS 402/dscp 7)# composite-operation dscp5
Done!
```

Composite operation dscp5 changes the mapping of packets entering the router with a DSCP values of 7. DSCP value 5 is most likely to be mapped to a different CoS, making these packets subject to a different set of behavioral rules.

## Displaying and testing policy lists

To verify access control lists, QoS lists, and policy-based routing (PBR) lists, you can view the configuration of the lists. You can also test the effect of the lists on simulated IP packets.

---

### Displaying policy lists

To view information about policy lists and their components, use the following commands. Many of these commands produce different results in different contexts.

- In general context:
  - **show ip access-control-list**. Displays a list of all configured access control lists, with their list numbers and owners
  - **show ip access-control-list list number detailed**. Displays all the parameters of the specified access control list
  - **show ip qos-list**. Displays a list of all configured QoS lists, with their list numbers and owners
  - **show ip qos-list detailed**. Displays all the parameters of the specified QoS list
- In `ip access-control-list` context:
  - **show composite-operation**. Displays a list of all composite operations configured for the list
  - **show ip-rule**. Displays a list of all rules configured for the list
  - **show list**. Displays the parameters of the current list, including its rules
- In `ip access-control-list/ip-rule` context:
  - **show composite-operation**. Displays the parameters of the composite operation assigned to the current rule
  - **show ip-rule**. Displays the parameters of the current rule
- In `ip qos-list` context:
  - **show composite-operation**. Displays a list of all composite operations configured for the list
  - **show dscp-table**. Displays the current list's DSCP table
  - **show ip-rule**. Displays a list of all rules configured for the list
  - **show list**. Displays the parameters of the current list, including its rules

- In `ip qos-list/ip-rule` context:
  - **show composite-operation**. Displays the parameters of the composite operation assigned to the current rule
  - **show dscp-table**. Displays the current list's DSCP table
  - **show ip-rule**. Displays the parameters of the current rule
- In `ip qos-list/dscp-table` context:
  - **show dscp-table**. Displays the parameters of the current DSCP table entry
- In `ip qos-list/composite-operation` context:
  - **show composite-operation**. Displays the parameters of the current composite operation

---

## Simulating packets

Use the `ip simulate` command in the context of an interface to test a policy list. The command tests the effect of the policy list on a simulated IP packet in the interface. You must specify the number of a policy list, the direction of the packet (in or out), and a source and destination IP address. You may also specify other parameters. For a full list of parameters, see *Avaya G450 CLI Reference*, 03-602056.

For example, the following command simulates the effect of applying QoS list number 401 to a packet entering the G450 through interface VLAN 2:

```
G450-001(if:VLAN 2)# ip simulate 401 in CoS1 dscp46 10.1.1.1  
10.2.2.2 tcp 1182 20
```

The simulated packet has the following properties:

- CoS priority is 1
- DSCP is 46
- source IP address is 10.1.1.1
- destination IP address is 10.2.2.2
- IP protocol is TCP
- source TCP port is 1182
- destination TCP port is 20

## Configuring policy

When you use the **ip simulate** command, the G450 displays the effect of the policy rules on the simulated packet. For example:

```
G450-001(super-if:VLAN 2)# ip simulate 401 in CoS1 dscp46 10.1.1.1
10.2.2.2 tcp 1182 20
Rule match for simulated packet is the default rule
Composite action for simulated packet is CoS6
New priority value is fwd6
Dscp value is not changed
```

---

## Summary of access control list commands

For more information about these commands, see *Avaya G450 CLI Reference*, 03-300437.

Table 139: Access control list CLI commands

Root level command	Command	Command	Description
<code>interface {dialer  serial  loopback  fastethernet  tunnel vlan}</code>			Enter the Dialer, Serial, Loopback, FastEthernet, Tunnel or VLAN interface configuration context
	<code>ip access-group</code>		Activate a specific Access Control list, for a specific direction, on the current interface
	<code>ip simulate</code>		Test the action of a policy on a simulated packet
	<code>show ip access-control- list</code>		Display the attributes of a specific access control list or of all access control lists on the current interface
<code>ip access-control -list</code>			Enter configuration mode for the specified policy access control list, and create the list if it does not exist
	<code>cookie</code>		Set the cookie for the current list

1 of 3

Table 139: Access control list CLI commands (continued)

Root level command	Command	Command	Description
	<b>ip-fragments-in</b>		Specify the action taken on incoming IP fragmentation packets for the current access control list
	<b>ip-option-in</b>		Specify the action taken on incoming packets carrying an IP option for the current access control list
	<b>ip-rule</b>		Enter configuration mode for a specified policy rule or, if the rule doesn't exist, create it and enter its configuration mode
		<b>composite-operation</b>	Assign the specified composite operation to the current rule
		<b>destination-ip</b>	Apply the current rule to packets with the specified destination IP address
		<b>dscp</b>	Apply the current rule to packets with the specified DSCP value
		<b>fragment</b>	Apply the current rule for non-initial fragments only
		<b>icmp</b>	Apply the current rule to a specific type of ICMP packet
		<b>ip-protocol</b>	Apply the current rule to packets with the specified IP protocol
		<b>show composite-operation</b>	Display the parameters of the composite operation assigned to the current rule
		<b>show ip-rule</b>	Display the attributes of the current rule
		<b>source-ip</b>	Apply the current rule to packets from the specified source IP address
		<b>tcp destination-port</b>	Apply the current rule to TCP packets with the specified destination port

Table 139: Access control list CLI commands (continued)

Root level command	Command	Command	Description
		<b>tcp established</b>	Apply the current rule only to packets that are part of an established TCP session
		<b>tcp source-port</b>	Apply the current rule to TCP packets from ports with specified source port
		<b>udp destination-port</b>	Apply the rule to UDP packets with the specified destination port
		<b>udp source-port</b>	Apply the rule to UDP packets from the specified source port
	<b>name</b>		Assign a name to the current list
	<b>owner</b>		Specify the owner of the current list
	<b>show composite-operation</b>		Display the composite operations configured for the list
	<b>show ip-rule</b>		Display the rules configured for the current list attributes of a specific rule
	<b>show list</b>		Display the attributes of the current list, including its rules
<b>ip policy-list-copy</b>			Copy an existing policy list to a new list
<b>show ip access-control-list</b>			Display the attributes of a specific access control list or of all access control lists

## Summary of QoS list commands

For more information about these commands, see *Avaya G450 CLI Reference*, 03-300437.

Table 140: QoS list CLI commands

Root level command	Command	Command	Description
<code>interface {dialer serial loopback fastethernet tunnel vlan}</code>			Enter the Dialer, Serial, Loopback, FastEthernet, Tunnel, or VLAN interface configuration context
	<code>ip qos-group</code>		Activate a specific QoS list, for a specific direction, on the current interface
	<code>ip simulate</code>		Test the action of a policy on a simulated packet
	<code>show ip qos-list</code>		Display the attributes of a specific QoS list or all QoS lists for the current interface
<code>ip policy-list-copy</code>			Copy an existing policy list to a new list
<code>ip qos-list</code>			Enter configuration mode for the specified QoS list, and create the list if it does not exist
	<code>composite-operation</code>		Enter the configuration mode for one of the current list's composite operations
		<code>cos</code>	Set the CoS priority value for the current composite operation
		<code>dscp</code>	Set the DSCP value for the current composite operation
		<code>name</code>	Assign a name to the current composite operation
			<b>1 of 3</b>

Table 140: QoS list CLI commands (continued)

Root level command	Command	Command	Description
		<b>show composite-operation</b>	Display the attributes of the current composite operation
	<b>cookie</b>		Set the cookie for the current list
	<b>dscp-table</b>		Enter the DSCP table entry context for a particular DSCP value for the current QoS list
		<b>composite-operation</b>	Specify the composite operation to execute for packets with the specified DSCP value
		<b>name</b>	Assign a name to the current DSCP table entry
		<b>show dscp-table</b>	Display the parameters of the current DSCP table entry
	<b>ip-rule</b>		Enter configuration mode for a specified policy rule or, if the rule does not exist, create it and enter its configuration mode
		<b>composite-operation</b>	Assign the specified composite operation to the current rule
		<b>destination-ip</b>	Apply the current rule to packets with the specified destination IP address
		<b>dscp</b>	Apply the current rule to packets with the specified DSCP value
		<b>fragment</b>	Apply the current rule for non-initial fragments only
		<b>icmp</b>	Apply the current rule to a specific type of ICMP packet
		<b>ip-protocol</b>	Apply the current rule to packets with the specified IP protocol
		<b>show composite-operation</b>	Display the parameters of the composite operation assigned to the current rule



Table 140: QoS list CLI commands (continued)

Root level command	Command	Command	Description
		<b>show dscp-table</b>	Display the current list's DSCP table
		<b>show ip-rule</b>	Display the attributes of the current rule
		<b>source-ip</b>	Apply the current rule to packets from the specified source IP address
		<b>tcp destination-port</b>	Apply the current rule to TCP packets with the specified destination port
		<b>tcp source-port</b>	Apply the current rule to TCP packets from ports with specified source port
		<b>udp destination-port</b>	Apply the rule to UDP packets with the specified destination port
		<b>udp source-port</b>	Apply the rule to UDP packets from the specified source port
	<b>name</b>		Assign a name to the current list
	<b>owner</b>		Specify the owner of the current list
	<b>pre-classification</b>		Specify which priority tag the current QoS list uses for data flows
	<b>show composite-operation</b>		Display all composite operations configured for the list
	<b>show dscp-table</b>		Display the current list's DSCP table
	<b>show ip-rule</b>		Display the rules configured for the current list attributes of a specific rule
	<b>show list</b>		Display the attributes of the current list, including its rules
<b>show ip qos-list</b>			Display the attributes of a specific QoS list or all QoS lists



# Chapter 21: Configuring policy-based routing

Policy-based routing enables you to configure a routing scheme based on traffic's source IP address, destination IP address, IP protocol, and other characteristics. You can use policy-based routing (PBR) lists to determine the routing of packets that match the rules defined in the list. Each PBR list includes a set of rules, and each rule includes a next hop list. Each next hop list contains up to 20 next hop destinations to which the G450 sends packets that match the rule. A destination can be either an IP address or an interface.

Policy-based routing takes place only when the packet enters the interface, not when it leaves. Policy-based routing takes place after the packet is processed by the Ingress Access Control List and the Ingress QoS list. Thus, the PBR list evaluates the packet after the packet's `DSCP` field has been modified by the Ingress QoS List. See [Figure 53](#).

**Note:**

The Loopback 1 interface is an exception to this rule. On the Loopback 1 interface, PBR lists are applied when the packet leaves the interface. This enables the PBR list to handle packets sent by the G450 device itself, as explained below.

**Note:**

ICMP keepalive provides the interface with the ability to determine whether a next hop is or is not available. See [ICMP keepalive](#) on page 292.

Policy-based routing only operates on routed packets. Packets traveling within the same subnet are not routed, and are, therefore, not affected by policy-based routing.

The Loopback interface is a logical interface which handles traffic that is sent to and from the G450 itself. This includes ping packets to or from the G450, as well as telnet, FTP, DHCP Relay, TFTP, HTTP, NTP, SNMP, H.248, and other types of traffic. The Loopback interface is also used for traffic to and from analog and DCP phones connected to the device via IP phone entities.

The Loopback interface is always up. You should attach a PBR list to the Loopback interface if you want to route specific packets generated by the G450 to a specific next-hop.

Unlike the case with other interfaces, PBR lists on the Loopback interface are applied to packets when they leave the G450, rather than when they enter.

Certain types of packets are not considered router packets (on the Loopback interface only), and are, therefore, not affected by policy-based routing. These include RIP, OSPF, VRRP, GRE, and keepalive packets. On the other hand, packets using SNMP, Telnet, Bootp, ICMP, FTP, SCP, TFTP, HTTP, NTP, and H.248 protocols are considered routed packets, and are, therefore, affected by policy-based routing on the Loopback interface.

---

## Applications

The most common application for policy-based routing is to provide for separate routing of voice and data traffic. It can also be used as a means to provide backup routes for defined traffic types.

---

### Separate routing of voice and data traffic

Although there are many possible applications for policy-based routing, the most common application is to create separate routing for voice and data traffic.

For example, the application shown in [Figure 54](#) uses the DSCP field to identify VoIP control packets (DSCP = 34, 41), VoIP Bearer RESV packets (DSCP = 43, 44), and VoIP Bearer packets (DSCP = 46). Policy-based routing sends these packets over the T1 WAN line, and sends other packets over the Internet. This saves bandwidth on the more expensive Serial interface.

---

**Figure 54: Policy-based routing – Voice/Data division by DSCP**

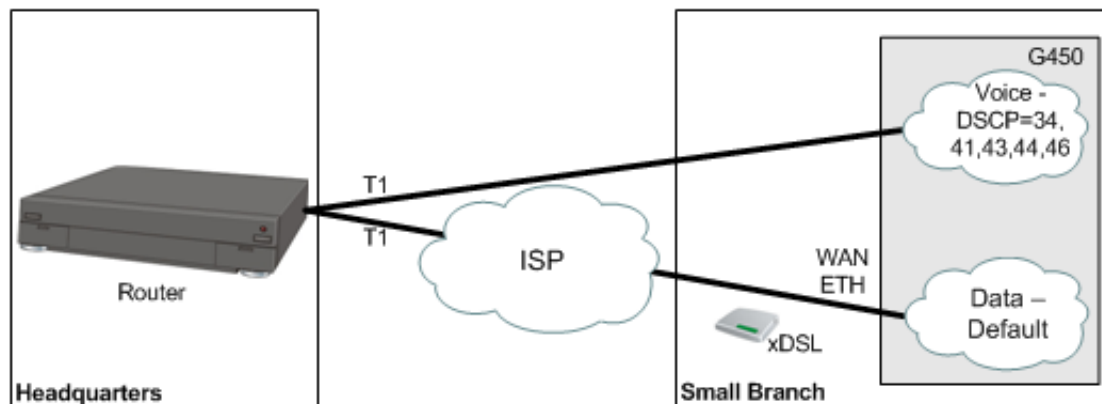

---

## Backup

You can utilize policy-based routing to define backup routes for defined classes of traffic. If the first route on the next hop list fails, the packets are routed to a subsequent hop. When necessary, you can use the NULL interface to drop packets when the primary next hop fails. For example, voice packets are usually sent over a WAN line, and not the Internet. You can configure a PBR list to drop voice packets when the WAN line is down.

---

## Configuring policy-based routing

For a full example of a policy-based routing configuration, see [Application example](#) on page 628.

### 1. Define PBR lists.

- In general context, enter **ip pbr-list** followed by a list number in the range 800-899. For example:

```
G450-001(super)# ip pbr-list 802
G450-001(super-PBR 802)#
```

- To assign a name to the list, use the **name** command, followed by a text string, in the PBR list context. The default name is **list #<list number>**. For example:

```
G450-001(super-PBR 802)# name "voice"
Done!
G450-001(super-PBR 802)#
```

- To assign an owner to the list, use the **owner** command, followed by a text string, in the PBR list context. The default owner is **other**. For example:

```
G450-001(super-PBR 802)# owner "tom"
Done!
G450-001(super-PBR 802)#
```

### 2. Define PBR rules.

In the PBR list context, enter **ip-rule**, followed by the number of the rule, to define a rule for the PBR list. Repeat this command to define additional rules. A rule contains: (i) criteria that is matched against the packet, and (ii) a next hop list. When a packet matches the criteria specified in the rule, the rule's next hop list determines how the packet is routed. Each PBR list can have up to 1,500 rules. The first rule that matches the packet determines the packet's routing.

It is important to include a destination address, or range of addresses, in PBR rules to better classify the traffic to be routed. For an illustration, see [Application example](#) on page 628.

#### Note:

It is recommended to leave a gap between rule numbers, in order to leave room for inserting additional rules at a later time. For example, ip-rule 10, ip-rule 20, ip-rule 30.

## Configuring policy-based routing

The following example creates rule 1, which routes packets going to IP address 149.49.43.210 with a DSCP value of 34 according to next hop list 1. The next step explains how to define a next hop list. For additional details about PBR rules, see [PBR rules](#) on page 624.

```
G450-001(super-PBR 802)# ip-rule 1
G450-001(super-PBR 802/ip rule 1)# next-hop list 1
Done!
G450-001(super-PBR 802/ip rule 1)# destination-ip host 149.49.43.210
Done!
G450-001(super-PBR 802/ip rule 1)# dscp 43
Done!
G450-001(super-PBR 802/ip rule 1)#
```

### Note:

Rules do not include a default next hop list. Thus, if you do not include a next hop list in the rule, the packet is routed according to destination-based routing, that is, the ordinary routing that would apply without policy-based routing.

### 3. Define next hop lists.

Enter **exit** twice to return to general context. In general context, define all the next hop lists that you have used in PBR rules.

### Note:

You can also perform this step before defining PBR lists and rules.

Enter **ip next-hop-list**, followed by the number of the list, to define a next hop list. In the next hop list context, use the following commands to define the next hops in the list:

- Enter **next-hop-ip**, followed by the index number of the entry in the next hop list, to define an IP address as a next hop. You can optionally apply tracking to monitor the route.
- Enter **next-hop-interface**, followed by the index number of the entry in the next hop list, to define an interface as a next hop. You can optionally apply tracking to monitor the route.

You can also use the **name** command to assign a name to the next hop list.

### Note:

You cannot use a FastEthernet Interface as an entry on a next hop list unless the interface was previously configured to use **PPPoE** encapsulation, or a GRE tunnel, or was configured as a DHCP client. See [Configuring PPPoE](#) on page 259, [Configuring GRE tunneling](#) on page 456, and [Configuring DHCP client](#) on page 199.

A next hop list can include the value NULL0. When the next hop is NULL0, the G450 drops the packet. However, you cannot apply tracking to NULL0.

The following example creates next hop list 1, named **"Data to HQ"**, with three entries:

- The first entry is IP address 172.16.1.221. Object tracker 3 is applied to monitor the route. For details about configuring the object tracker see [Object tracking configuration](#) on page 299.
- The second entry is Serial interface 3/1:1
- The third entry is NULL, which means the packet is dropped

```
G450-001(super)# ip next-hop-list 1
G450-001(super-next hop list 1)#name "Data_to_HQ"
Done!
G450-001(super-next hop list 1)#next-hop-ip 1 172.16.1.221 track 3
Done!
G450-001(super-next hop list 1)#next-hop-interface 2 Serial 3/1:1
Done!
G450-001(super-next hop list 1)#next-hop-interface 3 Null0
Done!
G450-001(super-next hop list 1)#
```

For additional details about next hop lists, see [Next hop lists](#) on page 625.

This example demonstrates a case where the data traffic is sent over a WAN FastEthernet Interface through the Internet. When the track detects that this next hop is not valid, traffic is routed over the Serial interface.

#### 4. Apply the PBR list to an interface.

Enter **exit** to return to general context. From general context, enter the interface to which you want to apply the PBR list. In the interface context, enter **ip pbr-group**, followed by the number of the PBR list, to attach the list to the interface. The list will be applied to packets entering the interface.

The following example applies PBR list 802 to VLAN 2.

```
G450-001(super)# interface vlan 2
G450-001(super-if:VLAN 2)# ip pbr-group 802
Done!
G450-001(super-if:VLAN 2)#
```

#### 5. Apply the PBR list to the Loopback interface.

The following example applies PBR list 802 to the Loopback interface.

```
G450-001(super)# interface Loopback 1
G450-001(super-if:Loopback 1)# ip pbr-group 802
Done!
G450-001(super-if:Loopback 1)# exit
G450-001(super)#
```

#### 6. Enter **copy running-config startup-config**. This saves the new policy-based routing configuration in the startup configuration file.

## PBR rules

Each PBR list can have up to 1,500 rules. The first rule that matches the packet specifies the next hop list for the packet. If no rule matches the packet, the packet is routed according to the default rule.

You can configure policy rules to match packets based on one or more of the following criteria:

- Source IP address, or a range of addresses
- Destination IP address or a range of addresses
- IP protocol, such as TCP, UDP, ICMP, IGMP
- Source TCP or UDP port or a range of ports
- Destination TCP or UDP port or a range of ports
- ICMP type and code
- Fragments
- DSCP field

**Note:**

The fragment criteria is used for non-initial fragments only. You cannot specify TCP/UDP ports or ICMP code/type for a rule when using the **fragment** command.

Use IP wildcards to specify a range of source or destination IP addresses. The zero bits in the wildcard correspond to bits in the IP address that remain fixed. The one bits in the wildcard correspond to bits in the IP address that can vary. Note that this is the opposite of how bits are used in a subnet mask.

**Note:**

When you use destination and source ports in a PBR rule, policy-based routing does not catch fragments.

**Note:**

It is recommended to leave a gap between rule numbers, in order to leave room for inserting additional rules at a later time. For example, ip-rule 10, ip-rule 20, ip-rule 30.



---

## Modifying rules

To modify a policy-based routing rule, you must enter the context of the rule and redefine the rule criteria.

1. Enter the context of the PBR list to which the rule belongs.
2. Enter **ip-rule** followed by the number of the rule you want to modify. For example, to create rule 1, enter **ip-rule 1**.

To view the rules that belong to a PBR list, enter the list's context and then enter **show ip-rule**.

---

## PBR rule criteria

The rule criteria for PBR rules are largely the same as the rule criteria for other policy list rules. Refer to [Policy lists rule criteria](#) on page 600 for an explanation of the rule criteria, including explanations and examples of the commands used to set the criteria.

Unlike other policy lists, PBR lists do not use composite operations. Thus, there is no **composite-operation** command in the context of a PBR rule. Instead, PBR lists use next hop lists. For an explanation of next hop lists, see [Next hop lists](#) on page 625.

Enter **next-hop list**, followed by the list number of a next hop list, to specify a next hop list for the G450 to apply to packets that match the rule. You can specify *Destination Based Routing* instead of a next hop list, in which case the G450 applies destination-based routing to a packet when the packet matches the rule.

If the next hop list specified in the rule does not exist, the G450 applies destination-based routing to packets that match the rule.

---

## Next hop lists

PBR rules include a next hop list. When the rule matches a packet, the G450 routes the packet according to the specified next hop list.

Each next hop list can include up to 20 entries. An entry in a next hop list can be either an IP address or an interface. The G450 attempts to route the packet to the first available destination on the next hop list. If every destination on the list is unavailable, the G450 routes the packet according to destination-based routing.

## Modifying next hop lists

To modify a next hop list, you must enter the context of the next hop list. To enter a next hop list context, enter **ip next-hop-list** followed by the number of the list you want to edit. For example, to modify next hop list 1, enter **ip next-hop-list 1**.

To show the next hops in an existing list, enter the context of the next hop list and enter **show next-hop**.

## Adding entries to a next hop list

1. Enter the context of the next hop list.
2. Use one of the following commands:
  - To enter an IP address as a next hop, enter **next-hop-ip**, followed by the index number of the entry and the IP address. You can optionally apply tracking to monitor the route. For example, the command **next-hop-ip 2 149.49.200.2 track 3** sets the IP address 149.49.200.2 as the second entry on the next hop list and applies object tracker 3 to monitor the route.
  - To enter an interface as a next hop, enter **next-hop-interface**, followed by the index number of the entry and the name of the interface. You can optionally apply tracking to monitor the route, except for the NULL0. For example, the command **next-hop-interface 3 serial 4/1:1.1** sets Serial 4/1:1.1 as the third entry on the next hop list.

## Deleting an entry from a next hop list

1. Enter the context of the next hop list.
2. Use one of the following commands:
  - To delete an IP address, enter **no next-hop-ip**, followed by the index number of the entry you want to delete. For example, the command **no next-hop-ip 2** deletes the second entry from the next hop list.
  - To delete an interface, enter **no next-hop-interface**, followed by the index number of the entry you want to delete. For example, the command **no next-hop-interface 3** deletes the third entry from the next hop list.

## Canceling tracking and keeping the next hop

1. Enter the context of the next hop list.
2. Use the **next-hop-ip** or **next-hop-interface** command again, without the **track** keyword.

## Changing the object tracker and keeping the next hop

1. Enter the context of the next hop list.
2. Use the **next-hop-ip** or **next-hop-interface** command again, with the **track** keyword followed by the new track index.

---

## Editing and deleting PBR lists

You cannot delete or modify a PBR list when it is attached to an interface. In order to delete or modify a PBR list, you must first remove the list from the interface. You can then delete or modify the list. After modifying the list, you can reattach the list to the interface.

To remove a list from an interface, use the **no** form of the **ip pbr-group** command in the interface context. The following example removes the PBR list from the VLAN 2 interface.

```
G450-001(super)# interface vlan 1
G450-001(super-if:VLAN 1)# no ip pbr-group
Done!
G450-001(super-if:VLAN 1)#
```

To modify a PBR list, enter **ip pbr-list**, followed by the number of the list you want to modify, to enter the list context. Redefine the parameters of the list.

To delete a PBR list, enter **exit** to return to general context and enter **no ip pbr-list** followed by the number of the list you want to delete.

---

## Displaying PBR lists

To view information about PBR lists and their components, use the following commands. Many of these commands produce different results in different contexts.

- In general context:
  - **show ip active-pbr-lists**. Displays details about a specified PBR list, or about all active PBR lists, according to the interfaces on which the lists are active
  - **show ip pbr-list**. Displays a list of all configured PBR lists, with their list numbers and names and their owners
  - **show ip pbr-list list number**. Displays the list number and name of the specified PBR list
  - **show ip pbr-list all detailed**. Displays all the parameters of all configured PBR lists

## Configuring policy-based routing

- **show ip pbr-list *list number* detailed.** Displays all the parameters of the specified PBR list
- **show ip active-lists.** Displays a list of each G450 interface to which a PBR list is attached, along with the number and name of the PBR list
- **show ip active-lists *list number*.** Displays a list of each G450 interface to which the specified PBR list is attached, along with the number and name of the PBR list
- **show ip next-hop-list all.** Displays the number and name of all next hop lists
- **show ip next-hop-list *list number*.** Displays the number and name of the specified next hop list
- In PBR list context:
  - **show list.** Displays all the parameters of the current PBR list
  - **show ip-rule.** Displays the parameters of all rules configured for the current list
  - **show ip-rule *rule number*.** Displays the parameters of the specified rule
- In next hop list context:
  - **show next-hop.** Displays the next hop entries in the current next hop list and their current status

---

## Application example

The following example creates a policy-based routing scheme in which:

- Voice traffic is routed over a Serial interface. If the interface is down, the traffic is dropped.
- Data traffic is routed over a GRE tunnel. If the tunnel is down, the traffic is routed over the Serial interface. If both interfaces are down, the traffic is dropped.

[Figure 55](#) illustrates the sample application described below.

Figure 55: Sample policy-based routing application

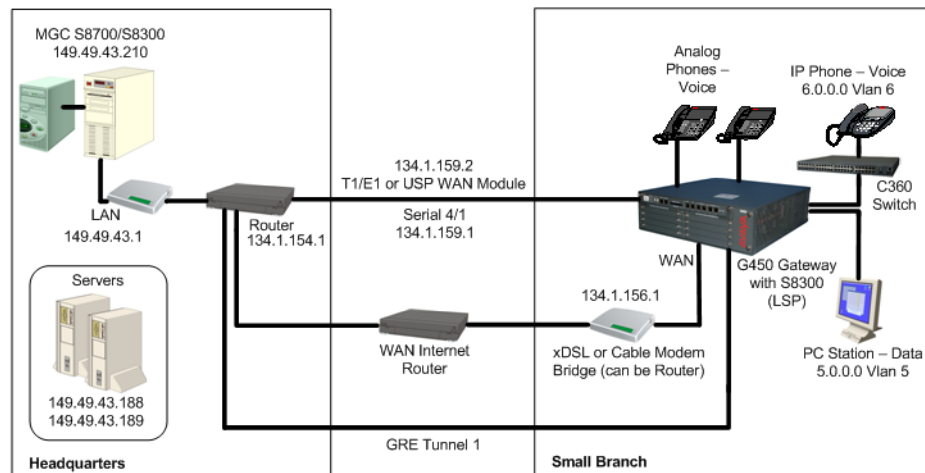

This example includes a voice VLAN (6) and a data VLAN (5). The PMI is on VLAN 6. The G450 is managed by a remote Media Gateway Controller (MGC) with the IP address 149.49.43.210. The G450 also includes a local S8300 in LSP mode.

IP phones are located on the same subnet as the PMI. Therefore, there is no routing between the PMI and the IP phones.

In this example, the object of policy-based routing is to route all voice traffic over the E1/T1 line, which is more expensive but provides the superior QoS necessary for voice traffic. Remaining traffic is to be routed over the more inexpensive Internet connection.

It is assumed that the IP phones on VLAN 6 establish connections with other IP phones on the same subnet, sending signalling packets to the MGC, and bearer packets directly to other IP phones or to the G450.

The policy-based routing configuring starts with PBR list 801. This list requires all voice packets addressed to the MGC (149.49.43.210) with DSCP values that indicate voice transmission (34, 41, 43, 44, and 46) to be routed according to next hop list 1. This list directs packets to the T1/E1 interface (Serial 4/1). If that interface is down, the packets are dropped.

In this example, it is important to include the destination IP address in each rule. This is because without the destination address, calls from IP phones on VLAN 6 to a Softphone on VLAN 5 will be routed by the PBR list to the E1/T1 line, rather than being sent directly to VLAN 5 via the G450.

---

# Configuration for the sample policy-based routing application

```
G450-001(super)# ip pbr-list 801
G450-001(super-PBR 801)# name "Voice"
Done!
G450-001(super-PBR 801)# ip-rule 1
G450-001(super-PBR 801/ip rule 1)# next-hop list 1
Done!
G450-001(super-PBR 801/ip rule 1)# destination-ip 149.49.123.0 0.0.0.255
Done!
G450-001(super-PBR 801/ip rule 1)# dscp 34
Done!
G450-001(super-PBR 801/ip rule 1)# exit
G450-001(super-PBR 801)# ip-rule 10
G450-001(super-PBR 801/ip rule 10)# next-hop list 1
Done!
G450-001(super-PBR 801/ip rule 10)# destination-ip 149.49.123.0 0.0.0.255
Done!
G450-001(super-PBR 801/ip rule 10)# dscp 41
Done!
G450-001(super-PBR 801/ip rule 10)# exit
Done!
G450-001(super-PBR 801/ip rule 20)# destination-ip 149.49.123.0 0.0.0.255
Done!
G450-001(super-PBR 801/ip rule 20)# dscp 43
Done!
G450-001(super-PBR 801/ip rule 20)# exit
G450-001(super-PBR 801)# ip-rule 30
G450-001(super-PBR 801/ip rule 30)# next-hop list 1
Done!
G450-001(super-PBR 801/ip rule 30)# destination-ip 149.49.123.0 0.0.0.255
Done!
G450-001(super-PBR 801/ip rule 30)# dscp 44
Done!
G450-001(super-PBR 801/ip rule 30)# exit
G450-001(super-PBR 801)# ip-rule 40
G450-001(super-PBR 801/ip rule 40)# next-hop list 1
Done!
G450-001(super-PBR 801/ip rule 40)# destination-ip 149.49.123.0 0.0.0.255
Done!
G450-001(super-PBR 801/ip rule 40)# dscp 46
Done!
G450-001(super-PBR 801/ip rule 40)# exit
G450-001(super-PBR 801)# exit
G450-001(super)#
```

The next group of commands configures next hop list 1, which was included in the rules configured above. Next hop list 1 sends packets that match the rule in which it is included to the E1/T1 line (Serial interface 4/1). If that interface is not available, the next hop list requires the packet to be dropped (Null0). This is because the QoS on the Internet interface is not adequate for voice packets. It would also be possible to include one or more backup interfaces in this next hop list.

```
G450-001(super)# ip next-hop-list 1
G450-001(super-next hop list 1)#name "Voice-To_HQ"
Done!
G450-001(super-next hop list 1)#next-hop-interface 1 Serial 4/1
Done!
G450-001(super-next hop list 1)#next-hop-interface 2 Null0
Done!
G450-001(super-next hop list 1)#exit
G450-001(super)#
```

The next set of commands applies the PBR list to the voice VLAN (6).

```
G450-001(super)# interface vlan 6
G450-001(super-if:VLAN 6)# ip pbr-group 801
Done!
G450-001(super-if:VLAN 6)# exit
G450-001(super)#
```

The next set of commands applies the PBR list to the Loopback interface. This is necessary to ensure that voice packets generated by the G450 itself are routed via the E1/T1 line. The Loopback interface is a logical interface that is always up. Packets sent from the G450, such as signaling packets, are sent via the Loopback interface. In this example, applying PBR list 801 to the Loopback interface ensures that signaling packets originating from voice traffic are sent via the T1/E1 line.

```
G450-001(super)# interface Loopback 1
G450-001(super-if:Loopback 1)# ip pbr-group 801
Done!
G450-001(super-if:Loopback 1)# exit
G450-001(super)#
```

## Configuring policy-based routing

The next set of commands defines a new PBR list (802). This list will be applied to the data interface (VLAN 5). The purpose of this is to route data traffic through interfaces other than the E1/T1 interface, so that this traffic will not interface with voice traffic.

```
G450-001(super)# ip pbr-list 802
G450-001(super-PBR 802)# name "Data_To_HQ"
Done!
G450-001(super-PBR 802)# ip-rule 1
G450-001(super-PBR 802/ip rule 1)# next-hop list 2
Done!
G450-001(super-PBR 802/ip rule 1)# ip-protocol tcp
Done!
G450-001(super-PBR 802/ip rule 1)# destination-ip host 149.49.43.189
Done!
G450-001(super-PBR 802/ip rule 1)# exit
G450-001(super-PBR 802)# exit
```

The next set of commands creates next hop list 2. This next hop list routes traffic to the GRE tunnel (Tunnel 1). If the GRE tunnel is not available, then the next hop list checks the next entry on the list and routes the traffic to the E1/T1 interface (Serial 4/1). If neither interface is available, the traffic is dropped. This allows data traffic to use the E1/T1 interface, but only when the GRE tunnel is not available. Alternatively, the list can be configured without the E1/T1 interface, preventing data traffic from using the E1/T1 interface at all.

```
G450-001(super)# ip next-hop-list 2
G450-001(super-next hop list 2)#name "Data-To_HQ"
Done!
G450-001(super-next hop list 2)#next-hop-interface 1 Tunnel 1
Done!
G450-001(super-next hop list 2)#next-hop-interface 2 Serial 4/1
Done!
G450-001(super-next hop list 2)#next-hop-interface 3 Null0
Done!
G450-001(super-next hop list 2)#exit
G450-001(super)#
```

Finally, the next set of commands applies the PBR list to the data VLAN (5).

```
G450-001(super)# interface vlan 5
G450-001(super-if:VLAN 6)# ip pbr-group 802
Done!
G450-001(super-if:VLAN 6)# exit
G450-001(super)#
```

In this example you can add a track on GRE Tunnel 1 in order to detect whether this next hop is valid or not (for more information on object tracking, refer to [Object tracking](#) on page 298). Note that the GRE tunnel itself has keepalive and can detect the status of the interface and, therefore, modify the next hop status.



---

## Simulating packets in PBR

Policy-based routing supports the `ip simulate` command for testing policies. Refer to [Simulating packets](#) on page 611.

---

## Summary of policy-based routing commands

For more information about these commands, see *Avaya G450 CLI Reference*, 03-300437.

**Table 141: Policy-based routing CLI commands**

Root level command	First level command	Second level command	Description
<code>ip next-hop-list</code>			Enter the context of the specified next hop list. If the list does not exist, it is created.
		<code>next-hop-interface</code>	Add the specified interface to the next hop path for this next-hop list
		<code>next-hop-ip</code>	Add the specified ip address to the next hop path for this next-hop list
		<code>show next-hop</code>	Display the next-hop entries in the current list
<code>interface</code>			Enter the interface configuration mode for a Dialer, Serial, Loopback, Fast Ethernet, Tunnel or VLAN interface
		<code>ip pbr-group</code>	Apply the specified PBR list to the current interface. The PBR list is applied to ingress packets only.
	<code>ip pbr-list</code>		Enter the context of the specified PBR list. If the list does not exist, it is created.
	<code>cookie</code>		Set the cookie for the current list
	<code>ip-rule</code>		Enter configuration mode for the specified rule. If the specified rule does not exist, the system creates it and enters its configuration mode.

---

Table 141: Policy-based routing CLI commands (continued)

Root level command	First level command	Second level command	Description
		<b>destination-ip</b>	Specify the destination IP address of packets to which the current rule applies
		<b>dscp</b>	Specify the DSCP value that is set by the current policy operation
		<b>fragment</b>	Apply the current rule for non-initial fragments only
		<b>icmp</b>	Apply the current rule to a specific type of ICMP packet
		<b>ip-protocol</b>	Apply the current rule to packets with the specified IP protocol
		<b>next-hop</b>	Specify the next-hop policy to use when the current rule is applied
		<b>show ip next-hop-list</b>	Display the details of the next-hop list or of all next-hop lists
		<b>show ip-rule</b>	Display the attributes of a specific rule or all rules
		<b>source-ip</b>	Apply the current rule to packets from the specified source IP address
		<b>tcp destination-port</b>	Apply the current rule to TCP packets with the specified destination port
		<b>tcp source-port</b>	Apply the current rule to TCP packets from ports with specified source port
		<b>udp destination-port</b>	Apply the rule to UDP packets with the specified destination port
		<b>udp source-port</b>	Apply the rule to UDP packets from the specified source port
	<b>name</b>		Assign a name to the specified list or operation
	<b>owner</b>		Specify the owner of the current list
	<b>show ip-rule</b>		Display the attributes of a specific rule or all rules

Table 141: Policy-based routing CLI commands (continued)

Root level command	First level command	Second level command	Description
	<code>show list</code>		Display information about the specified list
<code>show ip active-lists</code>			Display information about a specific policy list or all lists
<code>show ip active-pbr-lists</code>			Display details about a specific PBR list or all PBR lists
<code>show ip pbr-list</code>			Display information about the specified PBR list
			<b>3 of 3</b>



# Chapter 22: Setting synchronization

If the Avaya G450 Media Gateway contains an MM710 T1/E1 media module, it is advisable to define the MM710 as the primary synchronization source for the G450. In so doing, clock synchronization signals from the Central Office (CO) are used by the MM710 to synchronize all operations of the G450. If no MM710 is present, it is not necessary to set synchronization.

Enter **set sync interface primary|secondary *mmID* [*portID*]** to define a potential stratum clock source (T1/E1 Media Module, ISDN-BRI), where:

- ***mmID*** is the Media Module ID of an MM stratum clock source of the form **v*n***, where ***n*** is the MM slot number
- ***portID*** is the port number for an ISDN clock source candidate. The port ID consists of the slot number of the media module and the number of the port. You can set more than one port. For example, **v2 1, 3, 5-8**.

**Note:**

The port ID parameter only applies if the source is a BRI module.

By setting the clock source to primary, normal failover will occur. The identity of the current synchronization source is not stored in persistent storage. Persistent storage is used to preserve the parameters set by this command.

**Note:**

Setting the source to secondary overrides normal failover, generates a trap, and asserts a fault. Thus, it is only recommended to set the clock source to secondary for testing purposes.

To determine which reference source is the active source, use the **set sync source primary|secondary** command. If you choose **secondary**, the secondary source becomes active, and the primary source goes on standby. In addition, fallback to the primary source does not occur even when the primary source becomes available.

If neither primary nor secondary sources are identified, the local clock becomes the active source.

The following example sets the MM710 media module located in slot 2 of the G450 chassis as the primary clock synchronization source for the Avaya G450 Media Gateway.

```
set sync interface primary v2
set sync source primary
```

## Setting synchronization

If the Avaya G450 Media Gateway includes a second MM710 media module, enter the following additional command:

```
set sync interface secondary v3
set sync source secondary
```

If, for any reason, the primary MM710 media module cannot function as the clock synchronization source, the system uses the MM710 media module located in slot 3 of the Avaya G450 Media Gateway chassis as the clock synchronization source. If neither MM710 media module can function as the clock synchronization source, the system defaults to the local clock running on the S8300 Server.

To disassociate an interface previously specified as the primary or secondary clock synchronization source, enter **clear sync interface primary** or **clear sync interface secondary**.

To enable or disable automatic failover and failback between designated primary and secondary synchronization sources, enter **set sync switching enable** or **set sync switching disable**.

---

## Synchronization status

The yellow ACT LED on the front of the MM710 media module displays the synchronization status of that module.

- If the yellow ACT LED is solidly on or off, it has not been defined as a synchronization source. If it is on, one or more channels is active. If it is an ISDN facility, the D-channel counts as an active channel and causes the yellow ACT LED to be on.
- When the MM710 is operating as a clock synchronization source, the yellow ACT LED indicates that the MM710 is the clock synchronization source by flashing at three second intervals, as follows:
  - The yellow ACT LED is on for 2.8 seconds and off for 200 milliseconds if the MM710 media module has been specified as a clock synchronization source and is receiving a signal that meets the minimum requirements for the interface
  - The yellow ACT LED is on for 200 milliseconds and off for 2.8 seconds if the MM710 media module has been specified as a synchronization source and is not receiving a signal, or is receiving a signal that does not meet the minimum requirements for the interface

---

## Displaying synchronization status

Enter **show sync timing** to display the status of the primary, secondary, and local clock sources. The status can be *Active*, *Standby*, or *Not Configured*. The status is *Not Configured* when a source has not been defined, for example, when there are no T1 cards installed.

---

## Summary of synchronization commands

For more information about these commands, see *Avaya G450 CLI Reference*, 03-300437.

**Table 142: Synchronization CLI commands**

Command	Description
<b>clear sync interface</b>	Disassociate a previously specified interface as the primary or secondary clock synchronization source
<b>set sync interface</b>	Define the specified module and port as a potential source for clock synchronization for the media gateway
<b>set sync source</b>	Specify which clock source is the active clock source. The identity of the current synchronization source is not stored in persistent storage.
<b>set sync switching</b>	Toggle automatic sync source switching
<b>show sync timing</b>	Display the status of the primary, secondary, and local clock sources

## Setting synchronization



# Appendix A: Traps and MIBs

This appendix contains a list of all G450 traps and all MIBs.

---

## G450 traps

Name	Parameters (MIB variables)	Class	Msg Facility	Severity	Trap Name/ Mnemonic	Format	Description
coldStart		STD	Boot	Warning	coldStart	Agent Up with Possible Changes (coldStart Trap) enterprise:\$E (\$e) args(\$#):\$*	A coldStart trap indicates that the entity sending the protocol is reinitializing itself in such a way as to potentially cause the alteration of either the agent's configuration or the entity's implementation.
warmStart		STD	Boot	Warning	warmStart	Agent Up with No Changes (warmStart Trap) enterprise:\$E (\$e) args(\$#):\$*	A warmStart trap indicates that the entity sending the protocol is reinitializing itself in such a way as to keep both the agent configuration and the entity's implementation intact.
LinkUp	ifIndex, ifAdminStatus, ifOperStatus	STD	System	Warning	LinkUp	Agent Interface Up (linkUp Trap) enterprise:\$E (\$e) on interface \$1	A linkUp trap indicates that the entity sending the protocol recognizes that one of the communication links represented in the agent's configuration has come up. The data passed with the event is 1) The name and value of the ifIndex instance for the affected interface. The name of the interface can be retrieved via an snmpget of 1.3.6.1.2.1.2.2.1.2.INST, where INST is the instance returned with the trap.

---

1 of 9

## Traps and MIBs

Name	Parameters (MIB variables)	Class	Msg Facility	Severity	Trap Name/ Mnemonic	Format	Description
linkDown	ifIndex, ifAdminStatus, ifOperStatus	STD	System	Warning	linkDown	Agent Interface Down (linkDown Trap) enterprise:\$E (\$e) on interface \$1	A linkDown trap indicates that the entity that is sending the protocol recognizes a failure in one of the communication links represented in the agent's configuration. The data passed with the event is 1) The name and value of the ifIndex instance for the affected interface. The name of the interface can be retrieved via an snmpget of 1.3.6.1.2.1.2.2.1.2.INST, where INST is the instance returned with the trap.
SNMP_Authen_Failure		P330	SECURITY	Notification	authentic Failure	Incorrect Community Name (authentication Failure Trap) enterprise:\$E (\$e) args(\$#):\$*	An authentication failure trap indicates that the protocol is not properly authenticated.
risingAlarm	alarmIndex, alarmVariable, alarmSample Type, alarmValue, alarmRising Threshold	RMON	THRES HOLD	Warning	rising Alarm	Rising Alarm: \$2 exceeded threshold \$5; value = \$4. (Sample type = \$3; alarm index = \$1)	The SNMP trap that is generated when an alarm entry crosses its rising threshold and generates an event that is configured for sending SNMP traps
fallingAlarm	alarmIndex, alarmVariable, alarmSample Type, alarmValue, alarmRising Threshold, alarmFalling Threshold	RMON	THRES HOLD	Warning	falling Alarm	Falling Alarm: \$2 fell below threshold \$5; value = \$4. (Sample type = \$3; alarm index = \$1)	The SNMP trap that is generated when an alarm entry crosses its falling threshold and generates an event that is configured for sending SNMP traps
deleteSW Redundancy Trap	soft Redundancy Status	P330	SWITCH FABRIC	Info	deleteSWRedundancyTrap	Software Redundancy \$1 definition deleted	The trap notifies the manager of the deletion of the specified redundant link, which is identified by the softRedundancyId. It is enabled/disabled by chLntAgConfigChangeTraps.

Name	Parameters (MIB variables)	Class	Msg Facility	Severity	Trap Name/ Mnemonic	Format	Description
createSW Redundancy Trap	soft Redundancy Status	P330	SWITCH FABRIC	Info	createSWRedundancyTrap	Software Redundancy \$1 definition created	The trap is generated on the creation of the redundant links for the specified ports. It gives the logical name of the redundant link the identification of the main and secondary ports and the status of the link. The softRedundancyId defines the instances of the above- mentioned variables. The trap is enabled/disabled by chLntAgConfigChangeTraps.
lseIntPortCAMLastChange Trap	lseIntPortCAMLastChange	P330	SWITCH FABRIC	Info	lseIntPortCAMLastChange Trap	CAM Change at \$1	This trap reports of the occurred configuration changes. It is enabled/disabled by chLntAgCAMChangeTraps.
duplicateIP Trap	ipNetToMediaPhyAddress, ipNetToMediaNetAddress	P330	ROUTER	Warning	duplicateIPTrap	Duplicate IP address \$2 detected; MAC address \$1	This trap reports to the Management station on Duplicate IP identification. CRP identify the new IP on the network. If it similar to one of its IP interfaces, the CRP will issue a SNMP trap, containing the MAC of the intruder.
IntPolicy ChangeEvent	ipPolicy ActivationEntID, ipPolicy ActivationList, ipPolicy Activationif Index, ipPolicy ActivationSub Context	P330	POLICY	Info	IntPolicyChangeEvent	Module \$1 - Active policy list changed to \$2	The trap reports a change in the active list specific for a policy-enabled box or module.

## Traps and MIBs

Name	Parameters (MIB variables)	Class	Msg Facility	Severity	Trap Name/ Mnemonic	Format	Description
IntPolicyAccessControlViolationFlt	ipPolicyAccessControlViolationEntID, ipPolicyAccessControlViolationSrcAddr, ipPolicyAccessControlViolationDstAddr, ipPolicyAccessControlViolationProtocol, ipPolicyAccessControlViolationL4SrcPort, ipPolicyAccessControlViolationL4DstPort, ipPolicyAccessControlViolationEstablished, ipPolicyRuleID, ipPolicyRuleListID, ipPolicyAccessControlViolationIfIndex, ipPolicyAccessControlViolationSubCtxt, ipPolicyAccessControlViolationTime	P330	POLICY	Warning	IntPolicyAccessControlViolationFlt	IP PolicyAccess Control violation, if-index=\$9 ip-protocol=\$4 src-ip=\$2 dst-ip=\$3 src-port=\$5 dst-port=\$6 rule-id=\$8 rule-list=\$\$9	This trap reports to the Management station on IP PolicyAccess Control violation. The trap includes in its varbind information about the slot where the event occurred. The id of the rule that was violated in the current rules table, and the quintuplet that identifies the faulty packet. A management application would display this trap and the relevant information in a log entry. This trap will not be sent at intervals smaller than one minute for identical information in the varbinds list variables.
DormantPortFault	genPortSWRdFault, genPortGroupId, genPortId	P330	SWITCH FABRIC	Warning	DormantPortFault	Dormant Port Connection Lost on Module \$2 Port \$3;	This trap reports the loss of connection on a dormant port.
DormantPortOk	genPortSWRdFault, genPortGroupId, genPortId	P330	SWITCH FABRIC	Notification	DormantPortOk	Dormant Port Connection Returned to Normal on Module \$2 Port \$3;	This trap reports the return of connection on a dormant port.
InlinePwrFlt	genGroupFaultMask, genGroupId, genGroupBUPSActivityStatus	P330	POE	Error	InlinePwrFlt	Module \$2 Inline Power Supply failure	This trap reports the failure of an inline power supply.
InlinePwrFltOK	genGroupFaultMask, genGroupId, genGroupBUPSActivityStatus	P330	POE	Notification	InlinePwrFltOK	Module \$2 Inline Power Supply failure was cleared	This trap reports the correction of a failure on an inline power supply.

Name	Parameters (MIB variables)	Class	Msg Facility	Severity	Trap Name/ Mnemonic	Format	Description
WanPhysical AlarmOn	ifIndex, ifAdminStatus, ifOperStatus, ifName, ifAlias, dsx1Line Status	WAN	WAN	Critical	Wan Physical AlarmOn	Cable Problem on port \$4	An E1/T1/serial cable was disconnected.
wanPhysical AlarmOff	ifIndex, ifAdminStatus, ifOperStatus, ifName, ifAlias, dsx1Line Status	WAN	WAN	Notification	wan Physical AlarmOff	Cable Problem on port \$4 was cleared	An E1/T1/serial cable was reconnected.
wanLocal AlarmOn	ifIndex, ifAdminStatus, ifOperStatus, ifName, ifAlias, dsx1Line Status	WAN	WAN	Error	wanLocal AlarmOn	Local Alarm on interface \$4	Local alarms, such as LOS.
wanLocal AlarmOff	ifIndex, ifAdminStatus, ifOperStatus, ifName, ifAlias, dsx1Line Status	WAN	WAN	Notification	wanLocal AlarmOff	Local Alarm on interface \$4 was cleared	Local alarms, such as LOS, was cleared.
wanRemote AlarmOn	ifIndex, ifAdminStatus, ifOperStatus, ifName, ifAlias, dsx1Line Status	WAN	WAN	Error	wan Remote AlarmOn	Remote Alarm on interface \$4	Remote alarms, such as AIS.
wanRemote AlarmOff	ifIndex, ifAdminStatus, ifOperStatus, ifName, ifAlias, dsx1Line Status	WAN	WAN	Notification	wan Remote AlarmOff	Remote Alarm on interface \$4 was cleared	Remote alarms, such as AIS, was cleared.
wanMinor AlarmOn	ifIndex, ifAdminStatus, ifOperStatus, ifName, ifAlias, dsx1Line Status	WAN	WAN	Warning	wanMinor AlarmOn	Minor Alarm on interface \$4	Low BER.
wanMinorAlarm Off	ifIndex, ifAdminStatus, ifOperStatus, ifName, ifAlias, dsx1Line Status	WAN	WAN	Notification	wanMinor AlarmOff	Minor Alarm on interface \$4 was cleared	Normal BER.

## Traps and MIBs

Name	Parameters (MIB variables)	Class	Msg Facility	Severity	Trap Name/ Mnemonic	Format	Description
AvEntFanFlt	entPhysicalIndex, entPhysicalDescr, entPhySensorValue, avEntPhySensorLoWarning	AVAYA-ENTITY	TEMP		AvEntFanFlt	Fan \$2 is Faulty	This trap reports a faulty fan.
AvEntFanOk	entPhysicalIndex, entPhysicalDescr, entPhySensorValue, avEntPhySensorLoWarning	AVAYA-ENTITY	TEMP	Notification	AvEntFanOk	Fan \$2 is OK	This trap reports the return to function of a faulty fan.
avEnt48vPwrFlt	entPhysicalIndex, entPhysicalDescr, entPhySensorValue, avEntPhySensorHiWarning, avEntPhySensorLoWarning, entPhysicalParentRelPos	AVAYA-ENTITY	SUPPLY		avEnt48vPwrFlt	48V power supply Fault	This trap reports a problem with a 48V power supply.
avEnt5vPwrFlt	entPhysicalIndex, entPhysicalDescr, entPhySensorValue, avEntPhySensorHiWarning, avEntPhySensorLoWarning, entPhysicalParentRelPos	AVAYA-ENTITY	SUPPLY		avEnt5vPwrFlt	5V power supply Fault	This trap reports a problem with a 5V power supply.
avEnt3300mvPwrFlt	entPhysicalIndex, entPhysicalDescr, entPhySensorValue, avEntPhySensorHiWarning, avEntPhySensorLoWarning, entPhysicalParentRelPos	AVAYA-ENTITY	SUPPLY		avEnt3300mvPwrFlt	3.3V (3300mv) power supply Fault	This trap reports a problem with a 3.3V power supply.

Name	Parameters (MIB variables)	Class	Msg Facility	Severity	Trap Name/ Mnemonic	Format	Description
avEnt2500mv PwrFlt	entPhysical Index, entPhysical Descr, entPhySensor Value, avEntPhy SensorHi Warning, avEntPhy SensorLo Warningent Physical ParentRelPos	AVAYA-E NTITY	SUPPLY		avEnt2500mv PwrFlt	2.5V (2500mv) power supply Fault	This trap reports a problem with a 2.5V power supply.
avEnt1800mv PwrFlt	entPhysical Index, entPhysical Descr, entPhySensor Value, avEntPhy SensorHi Warning, avEntPhy SensorLo Warningent Physical ParentRelPos	AVAYA-E NTITY	SUPPLY		avEnt1800mv PwrFlt	1.8V (1800mv) power supply Fault	This trap reports a problem with a 1.8V power supply.
avEnt1600mv PwrFlt	entPhysical Index, entPhysical Descr, entPhySensor Value, avEntPhy SensorHi Warning, avEntPhy SensorLo Warningent Physical ParentRelPos	AVAYA-E NTITY	SUPPLY		avEnt1600mv PwrFlt	1.6V (1600mv) power supply Fault	This trap reports a problem with a 1.6V power supply.
avEnt48vPwr FltOk	entPhysical Index, entPhysical Descr, entPhySensor Value, avEntPhy SensorHi Warning, avEntPhy SensorLo Warningent Physical ParentRelPos	AVAYA-E NTITY	SUPPLY	Notification	avEnt48v PwrFltOk	48V power supply Fault Cleared	This trap reports the correction of a problem with a 48V power supply.

## Traps and MIBs

Name	Parameters (MIB variables)	Class	Msg Facility	Severity	Trap Name/ Mnemonic	Format	Description
avEnt5vPwrFltOk	entPhysical Index, entPhysical Descr, entPhySensor Value, avEntPhy SensorHi Warning, avEntPhy SensorLo Warningent Physical ParentRelPos	AVAYA-ENTITY	SUPPLY	Notification	avEnt5vPwrFltOk	5V power supply Fault Cleared	This trap reports the correction of a problem with a 5V power supply.
avEnt3300mvPwrFltOk	entPhysical Index, entPhysical Descr, entPhySensor Value, avEntPhy SensorHi Warning, avEntPhy SensorLo Warningent Physical ParentRelPos	AVAYA-ENTITY	SUPPLY	Notification	avEnt3300mvPwrFltOk	3.3V (3300mv) power supply Fault Cleared	This trap reports the correction of a problem with a 3.3V power supply.
avEnt2500mvPwrFltOk	entPhysical Index, entPhysical Descr, entPhySensor Value, avEntPhy SensorHi Warning, avEntPhy SensorLo Warningent Physical ParentRelPos	AVAYA-ENTITY	SUPPLY	Notification	avEnt2500mvPwrFltOk	2.5V (2500mv) power supply Fault Cleared	This trap reports the correction of a problem with a 2.5V power supply.
avEnt1800mvPwrFltOk	entPhysical Index, entPhysical Descr, entPhySensor Value, avEntPhy SensorHi Warning, avEntPhy SensorLo Warningent Physical ParentRelPos	AVAYA-ENTITY	SUPPLY	Notification	avEnt1800mvPwrFltOk	1.8V (1800mv) power supply Fault Cleared	This trap reports the correction of a problem with a 1.8V power supply.



Name	Parameters (MIB variables)	Class	Msg Facility	Severity	Trap Name/ Mnemonic	Format	Description
avEnt1600mv PwrFltOk	entPhysical Index, entPhysical Descr, entPhySensor Value, avEntPhy SensorHi Warning, avEntPhy SensorLo Warningent Physical ParentRelPos	AVAYA-ENTITY	SUPPLY	Notification	avEnt1600mv PwrFlt Ok	1.6V (1600mv) power supply Fault Cleared	This trap reports the correction of a problem with a 1.6V power supply.
avEntAmbient TempFlt	entPhysical Index, entPhysical Descr, entPhySensor Value, avEntPhy SensorHi Warning, entPhysical ParentRelPos	AVAYA-ENTITY	TEMP		avEnt Ambient TempFlt	Ambient Temperature fault (\$3)	This trap reports that the ambient temperature in the device is not within the acceptable temperature range for the device.
avEntAmbient TempOk	entPhysical Index, entPhysical Descr, entPhySensor Value, avEntPhy SensorHi Warning, entPhysical ParentRelPos	AVAYA-ENTITY	TEMP	Notification	avEnt Ambient TempOk	Ambient Temperature fault (\$3) cleared	This trap reports that the ambient temperature in the device has returned to the acceptable range for the device.

9 of 9

## G450 MIB files

MIB File	MIB Module Supported by G450
Load.MIB	LOAD-MIB
RFC1315-MIB.my	RFC1315-MIB
Q-BRIDGE-MIB.my	Q-BRIDGE-MIB
ENTITY-MIB.my	ENTITY-MIB
IP-FORWARD-MIB.my	IP-FORWARD-MIB
VRRP-MIB.my	VRRP-MIB

1 of 3

## Traps and MIBs

<b>MIB File</b>	<b>MIB Module Supported by G450</b>
UTILIZATION-MANAGEMENT-MIB.my	UTILIZATION-MANAGEMENT-MIB
ENTITY-SENSOR-MIB.my	ENTITY-SENSOR-MIB
RSTP-MIB.my	RSTP-MIB
APPLIC-MIB.MY	APPLIC-MIB
DS1-MIB.my	DS1-MIB
PPP-IP-NCP-MIB.my	PPP-IP-NCP-MIB
RFC1213-MIB.my	RFC1213-MIB
AVAYA-ENTITY-MIB.MY	AVAYA-ENTITY-MIB
Rnd.MIB	RND-MIB
XSWITCH-MIB.MY	XSWITCH-MIB
CROUTE-MIB.MY	CROUTE-MIB
RS-232-MIB.my	RS-232-MIB
RIPv2-MIB.my	RIPv2-MIB
IF-MIB.my	IF-MIB
DS0BUNDLE-MIB.my	DS0BUNDLE-MIB
RFC1406-MIB.my	RFC1406-MIB
DS0-MIB.my	DS0-MIB
POLICY-MIB.MY	POLICY-MIB
BRIDGE-MIB.my	BRIDGE-MIB
CONFIG-MIB.MY	CONFIG-MIB
G700-MG-MIB.MY	G700-MG-MIB
FRAME-RELAY-DTE-MIB.my	FRAME-RELAY-DTE-MIB
IP-MIB.my	IP-MIB
Load12.MIB	LOAD-MIB
PPP-LCP-MIB.my	PPP-LCP-MIB
WAN-MIB.MY	WAN-MIB

**2 of 3**

<b>MIB File</b>	<b>MIB Module Supported by G450</b>
SNMPv2-MIB.my	SNMPv2-MIB
USM-MIB.my	USM-MIB
VACM-MIB.my	VACM-MIB
OSPF-MIB.my	OSPF-MIB
Tunnel-MIB.my	TUNNEL-MIB
<b>3 of 3</b>	

## MIB files in the Load.MIB file

The following table provides a list of the MIBs in the Load.MIB file that are supported by the G450 and their OIDs:

<b>Object</b>	<b>OID</b>
genOpModuleId	1.3.6.1.4.1.1751.2.53.1.2.1.1
genOpIndex	1.3.6.1.4.1.1751.2.53.1.2.1.2
genOpRunningState	1.3.6.1.4.1.1751.2.53.1.2.1.3
genOpSourceIndex	1.3.6.1.4.1.1751.2.53.1.2.1.4
genOpDestIndex	1.3.6.1.4.1.1751.2.53.1.2.1.5
genOpServerIP	1.3.6.1.4.1.1751.2.53.1.2.1.6
genOpUserName	1.3.6.1.4.1.1751.2.53.1.2.1.7
genOpPassword	1.3.6.1.4.1.1751.2.53.1.2.1.8
genOpProtocolType	1.3.6.1.4.1.1751.2.53.1.2.1.9
genOpFileName	1.3.6.1.4.1.1751.2.53.1.2.1.10
genOpRunningStateDisplay	1.3.6.1.4.1.1751.2.53.1.2.1.11
genOpLastFailureIndex	1.3.6.1.4.1.1751.2.53.1.2.1.12
genOpLastFailureDisplay	1.3.6.1.4.1.1751.2.53.1.2.1.13
genOpLastWarningDisplay	1.3.6.1.4.1.1751.2.53.1.2.1.14
<b>1 of 2</b>	

## Traps and MIBs

Object	OID
genOpErrorLogIndex	1.3.6.1.4.1.1751.2.53.1.2.1.15
genOpResetSupported	1.3.6.1.4.1.1751.2.53.1.2.1.16
genOpEnableReset	1.3.6.1.4.1.1751.2.53.1.2.1.17
genOpNextBootImageIndex	1.3.6.1.4.1.1751.2.53.1.2.1.18
genOpLastBootImageIndex	1.3.6.1.4.1.1751.2.53.1.2.1.19
genOpFileSystemType	1.3.6.1.4.1.1751.2.53.1.2.1.20
genOpReportSpecificFlags	1.3.6.1.4.1.1751.2.53.1.2.1.21
genOpOctetsReceived	1.3.6.1.4.1.1751.2.53.1.2.1.22
genAppFileId	1.3.6.1.4.1.1751.2.53.2.1.1.1
genAppFileName	1.3.6.1.4.1.1751.2.53.2.1.1.2
genAppFileType	1.3.6.1.4.1.1751.2.53.2.1.1.3
genAppFileDescription	1.3.6.1.4.1.1751.2.53.2.1.1.4
genAppFileSize	1.3.6.1.4.1.1751.2.53.2.1.1.5
genAppFileVersionNumber	1.3.6.1.4.1.1751.2.53.2.1.1.6
genAppFileLocation	1.3.6.1.4.1.1751.2.53.2.1.1.7
genAppFileDateStamp	1.3.6.1.4.1.1751.2.53.2.1.1.8
genAppFileRowStatus	1.3.6.1.4.1.1751.2.53.2.1.1.9

**2 of 2**

---

## MIB files in the RFC1315-MIB.my file

The following table provides a list of the MIBs in the RFC1315-MIB.my file that are supported by the G450 and their OIDs:

Object	OID
frDlcmilfIndex	1.3.6.1.2.1.10.32.1.1.1
frDlcmiState	1.3.6.1.2.1.10.32.1.1.2

**1 of 3**

<b>Object</b>	<b>OID</b>
frDlcmiAddress	1.3.6.1.2.1.10.32.1.1.3
frDlcmiAddressLen	1.3.6.1.2.1.10.32.1.1.4
frDlcmiPollingInterval	1.3.6.1.2.1.10.32.1.1.5
frDlcmiFullEnquiryInterval	1.3.6.1.2.1.10.32.1.1.6
frDlcmiErrorThreshold	1.3.6.1.2.1.10.32.1.1.7
frDlcmiMonitoredEvents	1.3.6.1.2.1.10.32.1.1.8
frDlcmiMaxSupportedVCs	1.3.6.1.2.1.10.32.1.1.9
frDlcmiMulticast	1.3.6.1.2.1.10.32.1.1.10
frCircuitIfIndex	1.3.6.1.2.1.10.32.2.1.1
frCircuitDlci	1.3.6.1.2.1.10.32.2.1.2
frCircuitState	1.3.6.1.2.1.10.32.2.1.3
frCircuitReceivedFECNs	1.3.6.1.2.1.10.32.2.1.4
frCircuitReceivedBECNs	1.3.6.1.2.1.10.32.2.1.5
frCircuitSentFrames	1.3.6.1.2.1.10.32.2.1.6
frCircuitSentOctets	1.3.6.1.2.1.10.32.2.1.7
frCircuitReceivedFrames	1.3.6.1.2.1.10.32.2.1.8
frCircuitReceivedOctets	1.3.6.1.2.1.10.32.2.1.9
frCircuitCreationTime	1.3.6.1.2.1.10.32.2.1.10
frCircuitLastTimeChange	1.3.6.1.2.1.10.32.2.1.11
frCircuitCommittedBurst	1.3.6.1.2.1.10.32.2.1.12
frCircuitExcessBurst	1.3.6.1.2.1.10.32.2.1.13
frCircuitThroughput	1.3.6.1.2.1.10.32.2.1.14
frErrIfIndex	1.3.6.1.2.1.10.32.3.1.1
frErrType	1.3.6.1.2.1.10.32.3.1.2
frErrData	1.3.6.1.2.1.10.32.3.1.3
<b>2 of 3</b>	

Object	OID
frErrTime	1.3.6.1.2.1.10.32.3.1.4
frTrapState	1.3.6.1.2.1.10.32.4.1
<b>3 of 3</b>	

## MIB files in the Q-BRIDGE-MIB.my file

The following table provides a list of the MIBs in the Q-BRIDGE-MIB.my file that are supported by the G450 and their OIDs:

Object	OID
dot1qVlanVersionNumber	1.3.6.1.2.1.17.7.1.1.1
dot1qMaxVlanId	1.3.6.1.2.1.17.7.1.1.2
dot1qMaxSupportedVlans	1.3.6.1.2.1.17.7.1.1.3
dot1qNumVlans	1.3.6.1.2.1.17.7.1.1.4
dot1qGvrpStatus	1.3.6.1.2.1.17.7.1.1.5
dot1qVlanTimeMark	1.3.6.1.2.1.17.7.1.4.2.1.1
dot1qVlanIndex	1.3.6.1.2.1.17.7.1.4.2.1.2
dot1qVlanFdbId	1.3.6.1.2.1.17.7.1.4.2.1.3
dot1qVlanCurrentEgressPorts	1.3.6.1.2.1.17.7.1.4.2.1.4
dot1qVlanCurrentUntaggedPorts	1.3.6.1.2.1.17.7.1.4.2.1.5
dot1qVlanStatus	1.3.6.1.2.1.17.7.1.4.2.1.6
dot1qVlanCreationTime	1.3.6.1.2.1.17.7.1.4.2.1.7
dot1qVlanStaticName	1.3.6.1.2.1.17.7.1.4.3.1.1
dot1qVlanStaticEgressPorts	1.3.6.1.2.1.17.7.1.4.3.1.2
dot1qVlanForbiddenEgressPorts	1.3.6.1.2.1.17.7.1.4.3.1.3
dot1qVlanStaticUntaggedPorts	1.3.6.1.2.1.17.7.1.4.3.1.4
dot1qVlanStaticRowStatus	1.3.6.1.2.1.17.7.1.4.3.1.5
dot1qNextFreeLocalVlanIndex	1.3.6.1.2.1.17.7.1.4.4

Object	OID
dot1qPvid	1.3.6.1.2.1.17.7.1.4.5.1.1
dot1qPortAcceptableFrameTypes	1.3.6.1.2.1.17.7.1.4.5.1.2
dot1qPortIngressFiltering	1.3.6.1.2.1.17.7.1.4.5.1.3
dot1qPortGvrpStatus	1.3.6.1.2.1.17.7.1.4.5.1.4
dot1qPortGvrpFailedRegistrations	1.3.6.1.2.1.17.7.1.4.5.1.5
dot1qPortGvrpLastPduOrigin	1.3.6.1.2.1.17.7.1.4.5.1.6

## MIB files in the ENTITY-MIB.my file

The following table provides a list of the MIBs in the ENTITY-MIB.my file that are supported by the G450 and their OIDs:

Object	OID
entPhysicalIndex	1.3.6.1.2.1.47.1.1.1.1.1
entPhysicalDescr	1.3.6.1.2.1.47.1.1.1.1.2
entPhysicalVendorType	1.3.6.1.2.1.47.1.1.1.1.3
entPhysicalContainedIn	1.3.6.1.2.1.47.1.1.1.1.4
entPhysicalClass	1.3.6.1.2.1.47.1.1.1.1.5
entPhysicalParentRelPos	1.3.6.1.2.1.47.1.1.1.1.6
entPhysicalName	1.3.6.1.2.1.47.1.1.1.1.7
entPhysicalHardwareRev	1.3.6.1.2.1.47.1.1.1.1.8
entPhysicalFirmwareRev	1.3.6.1.2.1.47.1.1.1.1.9
entPhysicalSoftwareRev	1.3.6.1.2.1.47.1.1.1.1.10
entPhysicalSerialNum	1.3.6.1.2.1.47.1.1.1.1.11
entPhysicalMfgName	1.3.6.1.2.1.47.1.1.1.1.12
entPhysicalModelName	1.3.6.1.2.1.47.1.1.1.1.13
entPhysicalAlias	1.3.6.1.2.1.47.1.1.1.1.14

**1 of 2**

Object	OID
entPhysicalAssetID	1.3.6.1.2.1.47.1.1.1.1.15
entPhysicalIsFRU	1.3.6.1.2.1.47.1.1.1.1.16
<i>2 of 2</i>	

## MIB files in the IP-FORWARD-MIB.my file

The following table provides a list of the MIBs in the IP-FORWARD-MIB.my file that are supported by the G450 and their OIDs:

Object	OID
ipCidrRouteNumber	1.3.6.1.2.1.4.24.3
ipCidrRouteDest	1.3.6.1.2.1.4.24.4.1.1
ipCidrRouteMask	1.3.6.1.2.1.4.24.4.1.2
ipCidrRouteTos	1.3.6.1.2.1.4.24.4.1.3
ipCidrRouteNextHop	1.3.6.1.2.1.4.24.4.1.4
ipCidrRouteIfIndex	1.3.6.1.2.1.4.24.4.1.5
ipCidrRouteType	1.3.6.1.2.1.4.24.4.1.6
ipCidrRouteProto	1.3.6.1.2.1.4.24.4.1.7
ipCidrRouteAge	1.3.6.1.2.1.4.24.4.1.8
ipCidrRouteInfo	1.3.6.1.2.1.4.24.4.1.9
ipCidrRouteNextHopAS	1.3.6.1.2.1.4.24.4.1.10
ipCidrRouteMetric1	1.3.6.1.2.1.4.24.4.1.11
ipCidrRouteMetric2	1.3.6.1.2.1.4.24.4.1.12
ipCidrRouteMetric3	1.3.6.1.2.1.4.24.4.1.13
ipCidrRouteMetric4	1.3.6.1.2.1.4.24.4.1.14
ipCidrRouteMetric5	1.3.6.1.2.1.4.24.4.1.15
ipCidrRouteStatus	1.3.6.1.2.1.4.24.4.1.16



---

## MIB files in the VRRP-MIB.my file

The following table provides a list of the MIBs in the VRRP-MIB.my file that are supported by the G450 and their OIDs:

Object	OID
vrrpNodeVersion	1.3.6.1.2.1.68.1.1.1
vrrpOperVrld	1.3.6.1.2.1.68.1.1.3.1.1
vrrpOperVirtualMacAddr	1.3.6.1.2.1.68.1.1.3.1.2
vrrpOperState	1.3.6.1.2.1.68.1.1.3.1.3
vrrpOperAdminState	1.3.6.1.2.1.68.1.1.3.1.4
vrrpOperPriority	1.3.6.1.2.1.68.1.1.3.1.5
vrrpOperIpAddrCount	1.3.6.1.2.1.68.1.1.3.1.6
vrrpOperMasterIpAddr	1.3.6.1.2.1.68.1.1.3.1.7
vrrpOperPrimaryIpAddr	1.3.6.1.2.1.68.1.1.3.1.8
vrrpOperAuthType	1.3.6.1.2.1.68.1.1.3.1.9
vrrpOperAuthKey	1.3.6.1.2.1.68.1.1.3.1.10
vrrpOperAdvertisementInterval	1.3.6.1.2.1.68.1.1.3.1.11
vrrpOperPreemptMode	1.3.6.1.2.1.68.1.1.3.1.12
vrrpOperVirtualRouterUpTime	1.3.6.1.2.1.68.1.1.3.1.13
vrrpOperProtocol	1.3.6.1.2.1.68.1.1.3.1.14
vrrpOperRowStatus	1.3.6.1.2.1.68.1.1.3.1.15
vrrpAssolpAddr	1.3.6.1.2.1.68.1.1.4.1.1
vrrpAssolpAddrRowStatus	1.3.6.1.2.1.68.1.1.4.1.2

## MIB files in the UTILIZATION-MANAGEMENT-MIB.my file

The following table provides a list of the MIBs in the UTILIZATION-MANAGEMENT-MIB.my file that are supported by the G450 and their OIDs:

Object	OID
genCpuIndex	1.3.6.1.4.1.6889.2.1.11.1.1.1.1.1
genCpuUtilizationEnableMonitoring	1.3.6.1.4.1.6889.2.1.11.1.1.1.1.2
genCpuUtilizationEnableEventGeneration	1.3.6.1.4.1.6889.2.1.11.1.1.1.1.3
genCpuUtilizationHighThreshold	1.3.6.1.4.1.6889.2.1.11.1.1.1.1.4
genCpuAverageUtilization	1.3.6.1.4.1.6889.2.1.11.1.1.1.1.5
genCpuCurrentUtilization	1.3.6.1.4.1.6889.2.1.11.1.1.1.1.6
genCpuUtilizationHistorySampleIndex	1.3.6.1.4.1.6889.2.1.11.1.1.2.1.1
genCpuHistoryUtilization	1.3.6.1.4.1.6889.2.1.11.1.1.2.1.2
genMemUtilizationTotalRAM	1.3.6.1.4.1.6889.2.1.11.1.2.1
genMemUtilizationOperationalImage	1.3.6.1.4.1.6889.2.1.11.1.2.2
genMemUtilizationDynAllocMemUsed	1.3.6.1.4.1.6889.2.1.11.1.2.3.1
genMemUtilizationDynAllocMemMaxUsed	1.3.6.1.4.1.6889.2.1.11.1.2.3.2
genMemUtilizationDynAllocMemAvailable	1.3.6.1.4.1.6889.2.1.11.1.2.3.3
genMemUtilizationAllocationFailures	1.3.6.1.4.1.6889.2.1.11.1.2.4
genMemUtilizationID	1.3.6.1.4.1.6889.2.1.11.1.2.6.1.1
genMemUtilizationPhyRam	1.3.6.1.4.1.6889.2.1.11.1.2.6.1.2
genMemUtilizationPercentUsed	1.3.6.1.4.1.6889.2.1.11.1.2.6.1.3

---

## MIB files in the ENTITY-SENSOR-MIB.my file

The following table provides a list of the MIBs in the ENTITY-SENSOR-MIB.my file that are supported by the G450 and their OIDs:

Object	OID
entPhySensorType	1.3.6.1.2.1.99.1.1.1.1
entPhySensorScale	1.3.6.1.2.1.99.1.1.1.2
entPhySensorPrecision	1.3.6.1.2.1.99.1.1.1.3
entPhySensorValue	1.3.6.1.2.1.99.1.1.1.4
entPhySensorOperStatus	1.3.6.1.2.1.99.1.1.1.5
entPhySensorUnitsDisplay	1.3.6.1.2.1.99.1.1.1.6
entPhySensorValueTimeStamp	1.3.6.1.2.1.99.1.1.1.7
entPhySensorValueUpdateRate	1.3.6.1.2.1.99.1.1.1.8

---

## MIB files in the RSTP-MIB.my file

The following table provides a list of the MIBs in the RSTP-MIB.my file that are supported by the G450 and their OIDs:

Object	OID
dot1dStpVersion	1.3.6.1.2.1.17.2.16
dot1dStpTxHoldCount	1.3.6.1.2.1.17.2.17
dot1dStpPathCostDefault	1.3.6.1.2.1.17.2.18
dot1dStpPortProtocolMigration	1.3.6.1.2.1.17.2.19.1.1
dot1dStpPortAdminEdgePort	1.3.6.1.2.1.17.2.19.1.2
dot1dStpPortOperEdgePort	1.3.6.1.2.1.17.2.19.1.3
dot1dStpPortAdminPointToPoint	1.3.6.1.2.1.17.2.19.1.4

**1 of 2**

Object	OID
dot1dStpPortOperPointToPoint	1.3.6.1.2.1.17.2.19.1.5
dot1dStpPortAdminPathCost	1.3.6.1.2.1.17.2.19.1.6

**2 of 2**

---

### MIB files in the APPLIC-MIB.my file

The following table provides a list of the MIBs in the APPLIC-MIB.my file that are supported by the G450 and their OIDs:

Object	OID
IselIntPortGroupld	1.3.6.1.4.1.81.19.1.2.1.1.1
IselIntPortld	1.3.6.1.4.1.81.19.1.2.1.1.2
IselIntPortCAMLastChange	1.3.6.1.4.1.81.19.1.2.1.1.39
IselIntPortMACAddGroupld	1.3.6.1.4.1.81.19.1.2.2.1.1.1
IselIntPortMACAddPortld	1.3.6.1.4.1.81.19.1.2.2.1.1.2
IselIntPortMACAddLAld	1.3.6.1.4.1.81.19.1.2.2.1.1.3
IselIntPortMACAddList	1.3.6.1.4.1.81.19.1.2.2.1.1.4

---

### MIB files in the DS1-MIB.my file

The following table provides a list of the MIBs in the DS1-MIB.my file that are supported by the G450 and their OIDs:

Object	OID
dsx1LineIndex	1.3.6.1.2.1.10.18.6.1.1
dsx1IfIndex	1.3.6.1.2.1.10.18.6.1.2
dsx1TimeElapsed	1.3.6.1.2.1.10.18.6.1.3
dsx1ValidIntervals	1.3.6.1.2.1.10.18.6.1.4

**1 of 3**

<b>Object</b>	<b>OID</b>
dsx1LineType	1.3.6.1.2.1.10.18.6.1.5
dsx1LineCoding	1.3.6.1.2.1.10.18.6.1.6
dsx1SendCode	1.3.6.1.2.1.10.18.6.1.7
dsx1CircuitIdentifier	1.3.6.1.2.1.10.18.6.1.8
dsx1LoopbackConfig	1.3.6.1.2.1.10.18.6.1.9
dsx1LineStatus	1.3.6.1.2.1.10.18.6.1.10
dsx1SignalMode	1.3.6.1.2.1.10.18.6.1.11
dsx1TransmitClockSource	1.3.6.1.2.1.10.18.6.1.12
dsx1Fdl	1.3.6.1.2.1.10.18.6.1.13
dsx1InvalidIntervals	1.3.6.1.2.1.10.18.6.1.14
dsx1LineLength	1.3.6.1.2.1.10.18.6.1.15
dsx1LineStatusLastChange	1.3.6.1.2.1.10.18.6.1.16
dsx1LineStatusChangeTrapEnable	1.3.6.1.2.1.10.18.6.1.17
dsx1LoopbackStatus	1.3.6.1.2.1.10.18.6.1.18
dsx1Ds1ChannelNumber	1.3.6.1.2.1.10.18.6.1.19
dsx1Channelization	1.3.6.1.2.1.10.18.6.1.20
dsx1CurrentIndex	1.3.6.1.2.1.10.18.7.1.1
dsx1CurrentESs	1.3.6.1.2.1.10.18.7.1.2
dsx1CurrentSESs	1.3.6.1.2.1.10.18.7.1.3
dsx1CurrentSEFSs	1.3.6.1.2.1.10.18.7.1.4
dsx1CurrentUASs	1.3.6.1.2.1.10.18.7.1.5
dsx1CurrentCSSs	1.3.6.1.2.1.10.18.7.1.6
dsx1CurrentPCVs	1.3.6.1.2.1.10.18.7.1.7
dsx1CurrentLESs	1.3.6.1.2.1.10.18.7.1.8
dsx1CurrentBESs	1.3.6.1.2.1.10.18.7.1.9
dsx1CurrentDMs	1.3.6.1.2.1.10.18.7.1.10
<b>2 of 3</b>	

## Traps and MIBs

<b>Object</b>	<b>OID</b>
dsx1CurrentLCVs	1.3.6.1.2.1.10.18.7.1.11
dsx1IntervalIndex	1.3.6.1.2.1.10.18.8.1.1
dsx1IntervalNumber	1.3.6.1.2.1.10.18.8.1.2
dsx1IntervalESs	1.3.6.1.2.1.10.18.8.1.3
dsx1IntervalSEsSs	1.3.6.1.2.1.10.18.8.1.4
dsx1IntervalSEFSs	1.3.6.1.2.1.10.18.8.1.5
dsx1IntervalUASs	1.3.6.1.2.1.10.18.8.1.6
dsx1IntervalCSSs	1.3.6.1.2.1.10.18.8.1.7
dsx1IntervalPCVs	1.3.6.1.2.1.10.18.8.1.8
dsx1IntervalLESs	1.3.6.1.2.1.10.18.8.1.9
dsx1IntervalBESs	1.3.6.1.2.1.10.18.8.1.10
dsx1IntervalDMs	1.3.6.1.2.1.10.18.8.1.11
dsx1IntervalLCVs	1.3.6.1.2.1.10.18.8.1.12
dsx1IntervalValidData	1.3.6.1.2.1.10.18.8.1.13
dsx1TotalIndex	1.3.6.1.2.1.10.18.9.1.1
dsx1TotalESs	1.3.6.1.2.1.10.18.9.1.2
dsx1TotalSEsSs	1.3.6.1.2.1.10.18.9.1.3
dsx1TotalSEFSs	1.3.6.1.2.1.10.18.9.1.4
dsx1TotalUASs	1.3.6.1.2.1.10.18.9.1.5
dsx1TotalCSSs	1.3.6.1.2.1.10.18.9.1.6
dsx1TotalPCVs	1.3.6.1.2.1.10.18.9.1.7
dsx1TotalLESs	1.3.6.1.2.1.10.18.9.1.8
dsx1TotalBESs	1.3.6.1.2.1.10.18.9.1.9
dsx1TotalDMs	1.3.6.1.2.1.10.18.9.1.10
dsx1TotalLCVs	1.3.6.1.2.1.10.18.9.1.11

**3 of 3**

---

## MIB files in the PPP-IP-NCP-MIB.my file

The following table provides a list of the MIBs in the PPP-IP-NCP-MIB.my file that are supported by the G450 and their OIDs:

Object	OID
ppplpOperStatus	1.3.6.1.2.1.10.23.3.1.1.1
ppplpLocalToRemoteCompressionProtocol	1.3.6.1.2.1.10.23.3.1.1.2
ppplpRemoteToLocalCompressionProtocol	1.3.6.1.2.1.10.23.3.1.1.3
ppplpRemoteMaxSlotId	1.3.6.1.2.1.10.23.3.1.1.4
ppplpLocalMaxSlotId	1.3.6.1.2.1.10.23.3.1.1.5
ppplpConfigAdminStatus	1.3.6.1.2.1.10.23.3.2.1.1
ppplpConfigCompression	1.3.6.1.2.1.10.23.3.2.1.2

---

## MIB files in the RFC1213-MIB.my file

The following table provides a list of the MIBs in the RFC1213-MIB.my file that are supported by the G450 and their OIDs:

Object	OID
sysDescr	1.3.6.1.2.1.1.1
sysObjectID	1.3.6.1.2.1.1.2
sysUpTime	1.3.6.1.2.1.1.3
sysContact	1.3.6.1.2.1.1.4
sysName	1.3.6.1.2.1.1.5
sysLocation	1.3.6.1.2.1.1.6
sysServices	1.3.6.1.2.1.1.7
ifNumber	1.3.6.1.2.1.2.1
ifIndex	1.3.6.1.2.1.2.2.1.1
ifDescr	1.3.6.1.2.1.2.2.1.2
ifType	1.3.6.1.2.1.2.2.1.3
ifMtu	1.3.6.1.2.1.2.2.1.4
ifSpeed	1.3.6.1.2.1.2.2.1.5
ifPhysAddress	1.3.6.1.2.1.2.2.1.6
ifAdminStatus	1.3.6.1.2.1.2.2.1.7
ifOperStatus	1.3.6.1.2.1.2.2.1.8
ifLastChange	1.3.6.1.2.1.2.2.1.9
ifInOctets	1.3.6.1.2.1.2.2.1.10
ifInUcastPkts	1.3.6.1.2.1.2.2.1.11
ifInNUcastPkts	1.3.6.1.2.1.2.2.1.12
ifInDiscards	1.3.6.1.2.1.2.2.1.13
ifInErrors	1.3.6.1.2.1.2.2.1.14

**1 of 4**



<b>Object</b>	<b>OID</b>
ifInUnknownProtos	1.3.6.1.2.1.2.2.1.15
ifOutOctets	1.3.6.1.2.1.2.2.1.16
ifOutUcastPkts	1.3.6.1.2.1.2.2.1.17
ifOutNUcastPkts	1.3.6.1.2.1.2.2.1.18
ifOutDiscards	1.3.6.1.2.1.2.2.1.19
ifOutErrors	1.3.6.1.2.1.2.2.1.20
ifOutQLen	1.3.6.1.2.1.2.2.1.21
ifSpecific	1.3.6.1.2.1.2.2.1.22
ipForwarding	1.3.6.1.2.1.4.1
ipDefaultTTL	1.3.6.1.2.1.4.2
ipInReceives	1.3.6.1.2.1.4.3
ipInHdrErrors	1.3.6.1.2.1.4.4
ipInAddrErrors	1.3.6.1.2.1.4.5
ipForwDatagrams	1.3.6.1.2.1.4.6
ipInUnknownProtos	1.3.6.1.2.1.4.7
ipInDiscards	1.3.6.1.2.1.4.8
ipInDelivers	1.3.6.1.2.1.4.9
ipOutRequests	1.3.6.1.2.1.4.10
ipOutDiscards	1.3.6.1.2.1.4.11
ipOutNoRoutes	1.3.6.1.2.1.4.12
ipReasmTimeout	1.3.6.1.2.1.4.13
ipReasmReqds	1.3.6.1.2.1.4.14
ipReasmOKs	1.3.6.1.2.1.4.15
ipReasmFails	1.3.6.1.2.1.4.16
ipFragOKs	1.3.6.1.2.1.4.17
ipFragFails	1.3.6.1.2.1.4.18
<b>2 of 4</b>	

## Traps and MIBs

Object	OID
ipFragCreates	1.3.6.1.2.1.4.19
ipAdEntAddr	1.3.6.1.2.1.4.20.1.1
ipAdEntIfIndex	1.3.6.1.2.1.4.20.1.2
ipAdEntNetMask	1.3.6.1.2.1.4.20.1.3
ipAdEntBcastAddr	1.3.6.1.2.1.4.20.1.4
ipAdEntReasmMaxSize	1.3.6.1.2.1.4.20.1.5
ipRouteDest	1.3.6.1.2.1.4.21.1.1
ipRouteIfIndex	1.3.6.1.2.1.4.21.1.2
ipRouteMetric1	1.3.6.1.2.1.4.21.1.3
ipRouteMetric2	1.3.6.1.2.1.4.21.1.4
ipRouteMetric3	1.3.6.1.2.1.4.21.1.5
ipRouteMetric4	1.3.6.1.2.1.4.21.1.6
ipRouteNextHop	1.3.6.1.2.1.4.21.1.7
ipRouteType	1.3.6.1.2.1.4.21.1.8
ipRouteProto	1.3.6.1.2.1.4.21.1.9
ipRouteAge	1.3.6.1.2.1.4.21.1.10
ipRouteMask	1.3.6.1.2.1.4.21.1.11
ipRouteMetric5	1.3.6.1.2.1.4.21.1.12
ipRouteInfo	1.3.6.1.2.1.4.21.1.13
ipNetToMediaIfIndex	1.3.6.1.2.1.4.22.1.1
ipNetToMediaPhysAddress	1.3.6.1.2.1.4.22.1.2
ipNetToMediaNetAddress	1.3.6.1.2.1.4.22.1.3
ipNetToMediaType	1.3.6.1.2.1.4.22.1.4
ipRoutingDiscards	1.3.6.1.2.1.4.23
snmpInPkts	1.3.6.1.2.1.11.1
snmpOutPkts	1.3.6.1.2.1.11.2

**3 of 4**

<b>Object</b>	<b>OID</b>
snmpInBadVersions	1.3.6.1.2.1.11.3
snmpInBadCommunityNames	1.3.6.1.2.1.11.4
snmpInBadCommunityUses	1.3.6.1.2.1.11.5
snmpInASNParseErrs	1.3.6.1.2.1.11.6
snmpInTooBigs	1.3.6.1.2.1.11.8
snmpInNoSuchNames	1.3.6.1.2.1.11.9
snmpInBadValues	1.3.6.1.2.1.11.10
snmpInReadOnlys	1.3.6.1.2.1.11.11
snmpInGenErrs	1.3.6.1.2.1.11.12
snmpInTotalReqVars	1.3.6.1.2.1.11.13
snmpInTotalSetVars	1.3.6.1.2.1.11.14
snmpInGetRequests	1.3.6.1.2.1.11.15
snmpInGetNexts	1.3.6.1.2.1.11.16
snmpInSetRequests	1.3.6.1.2.1.11.17
snmpInGetResponses	1.3.6.1.2.1.11.18
snmpInTraps	1.3.6.1.2.1.11.19
snmpOutTooBigs	1.3.6.1.2.1.11.20
snmpOutNoSuchNames	1.3.6.1.2.1.11.21
snmpOutBadValues	1.3.6.1.2.1.11.22
snmpOutGenErrs	1.3.6.1.2.1.11.24
snmpOutGetRequests	1.3.6.1.2.1.11.25
snmpOutGetNexts	1.3.6.1.2.1.11.26
snmpOutSetRequests	1.3.6.1.2.1.11.27
snmpOutGetResponses	1.3.6.1.2.1.11.28
snmpOutTraps	1.3.6.1.2.1.11.29
snmpEnableAuthenTraps	1.3.6.1.2.1.11.30

**4 of 4**

---

### MIB files in the AVAYA-ENTITY-MIB.my file

The following table provides a list of the MIBs in the AVAYA-ENTITY-MIB.my file that are supported by the G450 and their OIDs:

Object	OID
avEntPhySensorHiShutdown	1.3.6.1.4.1.6889.2.1.99.1.1.1
avEntPhySensorHiWarning	1.3.6.1.4.1.6889.2.1.99.1.1.2
avEntPhySensorHiWarningClear	1.3.6.1.4.1.6889.2.1.99.1.1.3
avEntPhySensorLoWarningClear	1.3.6.1.4.1.6889.2.1.99.1.1.4
avEntPhySensorLoWarning	1.3.6.1.4.1.6889.2.1.99.1.1.5
avEntPhySensorLoShutdown	1.3.6.1.4.1.6889.2.1.99.1.1.6
avEntPhySensorEventSupportMask	1.3.6.1.4.1.6889.2.1.99.1.1.7

---

### MIB files in the Rnd-MIB.my file

The following table provides a list of the MIBs in the Rnd.MIB file that are supported by the G450 and their OIDs:

Object	OID
genGroupHWVersion	1.3.6.1.4.1.81.8.1.1.24
genGroupConfigurationSymbol	1.3.6.1.4.1.81.8.1.1.21
genGroupHWStatus	1.3.6.1.4.1.81.8.1.1.17

---

## MIB files in the XSWITCH-MIB.my file

The following table provides a list of the MIBs in the XSWITCH-MIB.my file that are supported by the G450 and their OIDs:

Object	OID
scGenPortGroupId	1.3.6.1.4.1.81.28.1.4.1.1.1
scGenPortId	1.3.6.1.4.1.81.28.1.4.1.1.2
scGenPortVLAN	1.3.6.1.4.1.81.28.1.4.1.1.3
scGenPortPriority	1.3.6.1.4.1.81.28.1.4.1.1.4
scGenPortSetDefaults	1.3.6.1.4.1.81.28.1.4.1.1.5
scGenPortLinkAggregationNumber	1.3.6.1.4.1.81.28.1.4.1.1.9
scGenPortGenericTrap	1.3.6.1.4.1.81.28.1.4.1.1.15
scGenPortLagCapability	1.3.6.1.4.1.81.28.1.4.1.1.20
scGenPortCapability	1.3.6.1.4.1.81.28.1.4.1.1.21
scGenSwitchId	1.3.6.1.4.1.81.28.1.5.1.1.1
scGenSwitchSTA	1.3.6.1.4.1.81.28.1.5.1.1.13
scEthPortGroupId	1.3.6.1.4.1.81.28.2.1.1.1.1
scEthPortId	1.3.6.1.4.1.81.28.2.1.1.1.2
scEthPortFunctionalStatus	1.3.6.1.4.1.81.28.2.1.1.1.27
scEthPortMode	1.3.6.1.4.1.81.28.2.1.1.1.28
scEthPortSpeed	1.3.6.1.4.1.81.28.2.1.1.1.29
scEthPortAutoNegotiation	1.3.6.1.4.1.81.28.2.1.1.1.30
scEthPortAutoNegotiationStatus	1.3.6.1.4.1.81.28.2.1.1.1.31
scEthPortPauseCapabilities	1.3.6.1.4.1.81.28.2.1.1.1.44
scEthPortFlowControl	1.3.6.1.4.1.81.28.2.1.1.1.47

## MIB files in the CROUTE-MIB.my file

The following table provides a list of the MIBs in the CROUTE-MIB.my file that are supported by the G450 and their OIDs:

Object	OID
ipGlobalsBOOTPRelayStatus	1.3.6.1.4.1.81.31.1.1.1
ipGlobalsICMPErrMsgEnable	1.3.6.1.4.1.81.31.1.1.2
ipGlobalsARPInactiveTimeout	1.3.6.1.4.1.81.31.1.1.3
ipGlobalsPrimaryManagementIPAddress	1.3.6.1.4.1.81.31.1.1.4
ipGlobalsNextPrimaryManagementIPAddress	1.3.6.1.4.1.81.31.1.1.5
ipInterfaceAddr	1.3.6.1.4.1.81.31.1.2.1.1
ipInterfaceNetMask	1.3.6.1.4.1.81.31.1.2.1.2
ipInterfaceLowerIfAlias	1.3.6.1.4.1.81.31.1.2.1.3
ipInterfaceType	1.3.6.1.4.1.81.31.1.2.1.4
ipInterfaceForwardIpBroadcast	1.3.6.1.4.1.81.31.1.2.1.5
ipInterfaceBroadcastAddr	1.3.6.1.4.1.81.31.1.2.1.6
ipInterfaceProxyArp	1.3.6.1.4.1.81.31.1.2.1.7
ipInterfaceStatus	1.3.6.1.4.1.81.31.1.2.1.8
ipInterfaceMainRouterAddr	1.3.6.1.4.1.81.31.1.2.1.9
ipInterfaceARPServerStatus	1.3.6.1.4.1.81.31.1.2.1.10
ipInterfaceName	1.3.6.1.4.1.81.31.1.2.1.11
ipInterfaceNetbiosRebroadcast	1.3.6.1.4.1.81.31.1.2.1.12
ipInterfaceIcmpRedirects	1.3.6.1.4.1.81.31.1.2.1.13
ipInterfaceOperStatus	1.3.6.1.4.1.81.31.1.2.1.14
ipInterfaceDhcpRelay	1.3.6.1.4.1.81.31.1.2.1.15
ripGlobalsRIPEnable	1.3.6.1.4.1.81.31.1.3.1
ripGlobalsLeakOSPFIntoRIP	1.3.6.1.4.1.81.31.1.3.2

<b>Object</b>	<b>OID</b>
ripGlobalsLeakStaticIntoRIP	1.3.6.1.4.1.81.31.1.3.3
ripGlobalsPeriodicUpdateTimer	1.3.6.1.4.1.81.31.1.3.4
ripGlobalsPeriodicInvalidRouteTimer	1.3.6.1.4.1.81.31.1.3.5
ripGlobalsDefaultExportMetric	1.3.6.1.4.1.81.31.1.3.6
ripInterfaceAddr	1.3.6.1.4.1.81.31.1.4.1.1
ripInterfaceMetric	1.3.6.1.4.1.81.31.1.4.1.2
ripInterfaceSplitHorizon	1.3.6.1.4.1.81.31.1.4.1.3
ripInterfaceAcceptDefaultRoute	1.3.6.1.4.1.81.31.1.4.1.4
ripInterfaceSendDefaultRoute	1.3.6.1.4.1.81.31.1.4.1.5
ripInterfaceState	1.3.6.1.4.1.81.31.1.4.1.6
ripInterfaceSendMode	1.3.6.1.4.1.81.31.1.4.1.7
ripInterfaceVersion	1.3.6.1.4.1.81.31.1.4.1.8
ospfGlobalsLeakRIPIntoOSPF	1.3.6.1.4.1.81.31.1.5.1
ospfGlobalsLeakStaticIntoOSPF	1.3.6.1.4.1.81.31.1.5.2
ospfGlobalsLeakDirectIntoOSPF	1.3.6.1.4.1.81.31.1.5.3
ospfGlobalsDefaultExportMetric	1.3.6.1.4.1.81.31.1.5.4
relayVIIndex	1.3.6.1.4.1.81.31.1.6.1.1
relayVIPrimaryServerAddr	1.3.6.1.4.1.81.31.1.6.1.2
relayVISEconderyServerAddr	1.3.6.1.4.1.81.31.1.6.1.3
relayVIStatus	1.3.6.1.4.1.81.31.1.6.1.4
relayVIRelayAddr	1.3.6.1.4.1.81.31.1.6.1.5
ipRedundancyStatus	1.3.6.1.4.1.81.31.1.9.1
ipRedundancyTimeout	1.3.6.1.4.1.81.31.1.9.2
ipRedundancyPollingInterval	1.3.6.1.4.1.81.31.1.9.3
ipShortcutARPServerStatus	1.3.6.1.4.1.81.31.1.10.1
distributionListRoutingProtocol	1.3.6.1.4.1.81.31.1.12.1.1
<b>2 of 4</b>	

## Traps and MIBs

Object	OID
distributionListDirection	1.3.6.1.4.1.81.31.1.12.1.2
distributionListIfIndex	1.3.6.1.4.1.81.31.1.12.1.3
distributionListRouteProtocol	1.3.6.1.4.1.81.31.1.12.1.4
distributionListProtocolSpecific1	1.3.6.1.4.1.81.31.1.12.1.5
distributionListProtocolSpecific2	1.3.6.1.4.1.81.31.1.12.1.6
distributionListProtocolSpecific3	1.3.6.1.4.1.81.31.1.12.1.7
distributionListProtocolSpecific4	1.3.6.1.4.1.81.31.1.12.1.8
distributionListProtocolSpecific5	1.3.6.1.4.1.81.31.1.12.1.9
distributionListAccessListNumber	1.3.6.1.4.1.81.31.1.12.1.10
distributionListEntryStatus	1.3.6.1.4.1.81.31.1.12.1.11
ipVRRPAdminStatus	1.3.6.1.4.1.81.31.1.14.1
iphcIfIndex	1.3.6.1.4.1.81.31.1.15.1.1.1
iphcControlTcpAdminStatus	1.3.6.1.4.1.81.31.1.15.1.1.2
iphcTcpSessions	1.3.6.1.4.1.81.31.1.15.1.1.3
iphcNegotiatedTcpSessions	1.3.6.1.4.1.81.31.1.15.1.1.4
iphcControlRtpAdminStatus	1.3.6.1.4.1.81.31.1.15.1.1.5
iphcRtpSessions	1.3.6.1.4.1.81.31.1.15.1.1.6
iphcNegotiatedRtpSessions	1.3.6.1.4.1.81.31.1.15.1.1.7
iphcControlNonTcpAdminStatus	1.3.6.1.4.1.81.31.1.15.1.1.8
iphcNonTcpSessions	1.3.6.1.4.1.81.31.1.15.1.1.9
iphcNegotiatedNonTcpSessions	1.3.6.1.4.1.81.31.1.15.1.1.10
iphcMaxPeriod	1.3.6.1.4.1.81.31.1.15.1.1.11
iphcMaxTime	1.3.6.1.4.1.81.31.1.15.1.1.12
iphcControlRtpMinPortNumber	1.3.6.1.4.1.81.31.1.15.1.1.13
iphcControlRtpMaxPortNumber	1.3.6.1.4.1.81.31.1.15.1.1.14
iphcControlRtpCompressionRatio	1.3.6.1.4.1.81.31.1.15.1.1.15

**3 of 4**



Object	OID
iphcControlNonTcpMode	1.3.6.1.4.1.81.31.1.15.1.1.16
ospfXtnDlflpAddress	1.3.6.1.4.1.81.31.1.16.1.1
ospfXtnDlflAddressLesslf	1.3.6.1.4.1.81.31.1.16.1.2
ospfXtnDlflPassiveMode	1.3.6.1.4.1.81.31.1.16.1.3
vlConfIndex	1.3.6.1.4.1.81.31.3.1.1.1
vlConfAlias	1.3.6.1.4.1.81.31.3.1.1.2
vlConfStatus	1.3.6.1.4.1.81.31.3.1.1.3
<b>4 of 4</b>	

## MIB files in the RS-232-MIB.my file

The following table provides a list of the MIBs in the RS-232-MIB.my file that are supported by the G450 and their OIDs:

Object	OID
rs232Number	1.3.6.1.2.1.10.33.1
rs232PortIndex	1.3.6.1.2.1.10.33.2.1.1
rs232PortType	1.3.6.1.2.1.10.33.2.1.2
rs232PortInSigNumber	1.3.6.1.2.1.10.33.2.1.3
rs232PortOutSigNumber	1.3.6.1.2.1.10.33.2.1.4
rs232PortInSpeed	1.3.6.1.2.1.10.33.2.1.5
rs232PortOutSpeed	1.3.6.1.2.1.10.33.2.1.6
rs232PortInFlowType	1.3.6.1.2.1.10.33.2.1.7
rs232PortOutFlowType	1.3.6.1.2.1.10.33.2.1.8
rs232SyncPortIndex	1.3.6.1.2.1.10.33.4.1.1
rs232SyncPortClockSource	1.3.6.1.2.1.10.33.4.1.2
rs232SyncPortFrameCheckErrs	1.3.6.1.2.1.10.33.4.1.3
<b>1 of 2</b>	

## Traps and MIBs

Object	OID
rs232SyncPortTransmitUnderrunErrs	1.3.6.1.2.1.10.33.4.1.4
rs232SyncPortReceiveOverrunErrs	1.3.6.1.2.1.10.33.4.1.5
rs232SyncPortInterruptedFrames	1.3.6.1.2.1.10.33.4.1.6
rs232SyncPortAbortedFrames	1.3.6.1.2.1.10.33.4.1.7
rs232SyncPortRole	1.3.6.1.2.1.10.33.4.1.8
rs232SyncPortEncoding	1.3.6.1.2.1.10.33.4.1.9
rs232SyncPortRTSControl	1.3.6.1.2.1.10.33.4.1.10
rs232SyncPortRTSCTSDelay	1.3.6.1.2.1.10.33.4.1.11
rs232SyncPortMode	1.3.6.1.2.1.10.33.4.1.12
rs232SyncPortIdlePattern	1.3.6.1.2.1.10.33.4.1.13
rs232SyncPortMinFlags	1.3.6.1.2.1.10.33.4.1.14
rs232InSigPortIndex	1.3.6.1.2.1.10.33.5.1.1
rs232InSigName	1.3.6.1.2.1.10.33.5.1.2
rs232InSigState	1.3.6.1.2.1.10.33.5.1.3
rs232InSigChanges	1.3.6.1.2.1.10.33.5.1.4
rs232OutSigPortIndex	1.3.6.1.2.1.10.33.6.1.1
rs232OutSigName	1.3.6.1.2.1.10.33.6.1.2
rs232OutSigState	1.3.6.1.2.1.10.33.6.1.3
rs232OutSigChanges	1.3.6.1.2.1.10.33.6.1.4

**2 of 2**

---

## MIB files in the RIPv2-MIB.my file

The following table provides a list of the MIBs in the RIPv2-MIB.my file that are supported by the G450 and their OIDs:

Object	OID
rip2GlobalRouteChanges	1.3.6.1.2.1.23.1.1
rip2GlobalQueries	1.3.6.1.2.1.23.1.2
rip2IfStatAddress	1.3.6.1.2.1.23.2.1.1
rip2IfStatRcvBadPackets	1.3.6.1.2.1.23.2.1.2
rip2IfStatRcvBadRoutes	1.3.6.1.2.1.23.2.1.3
rip2IfStatSentUpdates	1.3.6.1.2.1.23.2.1.4
rip2IfStatStatus	1.3.6.1.2.1.23.2.1.5
rip2IfConfAddress	1.3.6.1.2.1.23.3.1.1
rip2IfConfDomain	1.3.6.1.2.1.23.3.1.2
rip2IfConfAuthType	1.3.6.1.2.1.23.3.1.3
rip2IfConfAuthKey	1.3.6.1.2.1.23.3.1.4
rip2IfConfSend	1.3.6.1.2.1.23.3.1.5
rip2IfConfReceive	1.3.6.1.2.1.23.3.1.6
rip2IfConfDefaultMetric	1.3.6.1.2.1.23.3.1.7
rip2IfConfStatus	1.3.6.1.2.1.23.3.1.8
rip2IfConfSrcAddress	1.3.6.1.2.1.23.3.1.9

## MIB files in the IF-MIB.my file

The following table provides a list of the MIBs in the IF-MIB.my file that are supported by the G450 and their OIDs:

Object	OID
ifNumber	1.3.6.1.2.1.2.1
ifIndex	1.3.6.1.2.1.2.2.1.1
ifDescr	1.3.6.1.2.1.2.2.1.2
ifType	1.3.6.1.2.1.2.2.1.3
ifMtu	1.3.6.1.2.1.2.2.1.4
ifSpeed	1.3.6.1.2.1.2.2.1.5
ifPhysAddress	1.3.6.1.2.1.2.2.1.6
ifAdminStatus	1.3.6.1.2.1.2.2.1.7
ifOperStatus	1.3.6.1.2.1.2.2.1.8
ifLastChange	1.3.6.1.2.1.2.2.1.9
ifInOctets	1.3.6.1.2.1.2.2.1.10
ifInUcastPkts	1.3.6.1.2.1.2.2.1.11
ifInNUcastPkts	1.3.6.1.2.1.2.2.1.12
ifInDiscards	1.3.6.1.2.1.2.2.1.13
ifInErrors	1.3.6.1.2.1.2.2.1.14
ifInUnknownProtos	1.3.6.1.2.1.2.2.1.15
ifOutOctets	1.3.6.1.2.1.2.2.1.16
ifOutUcastPkts	1.3.6.1.2.1.2.2.1.17
ifOutNUcastPkts	1.3.6.1.2.1.2.2.1.18
ifOutDiscards	1.3.6.1.2.1.2.2.1.19
ifOutErrors	1.3.6.1.2.1.2.2.1.20
ifOutQLen	1.3.6.1.2.1.2.2.1.21
<b>1 of 2</b>	

<b>Object</b>	<b>OID</b>
ifSpecific	1.3.6.1.2.1.2.2.1.22
ifName	1.3.6.1.2.1.31.1.1.1.1
ifInMulticastPkts	1.3.6.1.2.1.31.1.1.1.2
ifInBroadcastPkts	1.3.6.1.2.1.31.1.1.1.3
ifOutMulticastPkts	1.3.6.1.2.1.31.1.1.1.4
ifOutBroadcastPkts	1.3.6.1.2.1.31.1.1.1.5
ifHCInOctets	1.3.6.1.2.1.31.1.1.1.6
ifHCInUcastPkts	1.3.6.1.2.1.31.1.1.1.7
ifHCInMulticastPkts	1.3.6.1.2.1.31.1.1.1.8
ifHCInBroadcastPkts	1.3.6.1.2.1.31.1.1.1.9
ifHCOctets	1.3.6.1.2.1.31.1.1.1.10
ifHCOUcastPkts	1.3.6.1.2.1.31.1.1.1.11
ifHCOMulticastPkts	1.3.6.1.2.1.31.1.1.1.12
ifHCOBroadcastPkts	1.3.6.1.2.1.31.1.1.1.13
ifLinkUpDownTrapEnable	1.3.6.1.2.1.31.1.1.1.14
ifHighSpeed	1.3.6.1.2.1.31.1.1.1.15
ifPromiscuousMode	1.3.6.1.2.1.31.1.1.1.16
ifConnectorPresent	1.3.6.1.2.1.31.1.1.1.17
ifAlias	1.3.6.1.2.1.31.1.1.1.18
ifCounterDiscontinuityTime	1.3.6.1.2.1.31.1.1.1.19
<b>2 of 2</b>	

---

## MIB files in the DS0BUNDLE-MIB.my file

The following table provides a list of the MIBs in the DS0BUNDLE-MIB.my file that are supported by the G450 and their OIDs:

Object	OID
dsx0BundleIndex	1.3.6.1.2.1.10.82.3.1.1
dsx0BundleIfIndex	1.3.6.1.2.1.10.82.3.1.2
dsx0BundleCircuitIdentifier	1.3.6.1.2.1.10.82.3.1.3
dsx0BundleRowStatus	1.3.6.1.2.1.10.82.3.1.4

---

## MIB files in the RFC1406-MIB.my file

The following table provides a list of the MIBs in the RFC1406-MIB.my file that are supported by the G450 and their OIDs:

Object	OID
dsx1LineIndex	1.3.6.1.2.1.10.18.6.1.1
dsx1IfIndex	1.3.6.1.2.1.10.18.6.1.2
dsx1TimeElapsed	1.3.6.1.2.1.10.18.6.1.3
dsx1ValidIntervals	1.3.6.1.2.1.10.18.6.1.4
dsx1LineType	1.3.6.1.2.1.10.18.6.1.5
dsx1LineCoding	1.3.6.1.2.1.10.18.6.1.6
dsx1SendCode	1.3.6.1.2.1.10.18.6.1.7
dsx1CircuitIdentifier	1.3.6.1.2.1.10.18.6.1.8
dsx1LoopbackConfig	1.3.6.1.2.1.10.18.6.1.9
dsx1LineStatus	1.3.6.1.2.1.10.18.6.1.10
dsx1SignalMode	1.3.6.1.2.1.10.18.6.1.11
dsx1TransmitClockSource	1.3.6.1.2.1.10.18.6.1.12

**1 of 3**

<b>Object</b>	<b>OID</b>
dsx1Fdl	1.3.6.1.2.1.10.18.6.1.13
dsx1CurrentIndex	1.3.6.1.2.1.10.18.7.1.1
dsx1CurrentESs	1.3.6.1.2.1.10.18.7.1.2
dsx1CurrentSEsSs	1.3.6.1.2.1.10.18.7.1.3
dsx1CurrentSEFSs	1.3.6.1.2.1.10.18.7.1.4
dsx1CurrentUASs	1.3.6.1.2.1.10.18.7.1.5
dsx1CurrentCSSs	1.3.6.1.2.1.10.18.7.1.6
dsx1CurrentPCVs	1.3.6.1.2.1.10.18.7.1.7
dsx1CurrentLESs	1.3.6.1.2.1.10.18.7.1.8
dsx1CurrentBESs	1.3.6.1.2.1.10.18.7.1.9
dsx1CurrentDMs	1.3.6.1.2.1.10.18.7.1.10
dsx1CurrentLCVs	1.3.6.1.2.1.10.18.7.1.11
dsx1IntervalIndex	1.3.6.1.2.1.10.18.8.1.1
dsx1IntervalNumber	1.3.6.1.2.1.10.18.8.1.2
dsx1IntervalESs	1.3.6.1.2.1.10.18.8.1.3
dsx1IntervalSEsSs	1.3.6.1.2.1.10.18.8.1.4
dsx1IntervalSEFSs	1.3.6.1.2.1.10.18.8.1.5
dsx1IntervalUASs	1.3.6.1.2.1.10.18.8.1.6
dsx1IntervalCSSs	1.3.6.1.2.1.10.18.8.1.7
dsx1IntervalPCVs	1.3.6.1.2.1.10.18.8.1.8
dsx1IntervalLESs	1.3.6.1.2.1.10.18.8.1.9
dsx1IntervalBESs	1.3.6.1.2.1.10.18.8.1.10
dsx1IntervalDMs	1.3.6.1.2.1.10.18.8.1.11
dsx1IntervalLCVs	1.3.6.1.2.1.10.18.8.1.12
dsx1TotalIndex	1.3.6.1.2.1.10.18.9.1.1
dsx1TotalESs	1.3.6.1.2.1.10.18.9.1.2
<b>2 of 3</b>	

## Traps and MIBs

Object	OID
dsx1TotalSESSs	1.3.6.1.2.1.10.18.9.1.3
dsx1TotalSEFSs	1.3.6.1.2.1.10.18.9.1.4
dsx1TotalUASs	1.3.6.1.2.1.10.18.9.1.5
dsx1TotalCSSs	1.3.6.1.2.1.10.18.9.1.6
dsx1TotalPCVs	1.3.6.1.2.1.10.18.9.1.7
dsx1TotalLESSs	1.3.6.1.2.1.10.18.9.1.8
dsx1TotalBESSs	1.3.6.1.2.1.10.18.9.1.9
dsx1TotalDMs	1.3.6.1.2.1.10.18.9.1.10
dsx1TotalLCVs	1.3.6.1.2.1.10.18.9.1.11

**3 of 3**

---

## MIB files in the DS0-MIB.my file

The following table provides a list of the MIBs in the DS0-MIB.my file that are supported by the G450 and their OIDs:

Object	OID
dsx0Ds0ChannelNumber	1.3.6.1.2.1.10.81.1.1.1
dsx0RobbedBitSignalling	1.3.6.1.2.1.10.81.1.1.2
dsx0CircuitIdentifier	1.3.6.1.2.1.10.81.1.1.3
dsx0IdleCode	1.3.6.1.2.1.10.81.1.1.4
dsx0SeizedCode	1.3.6.1.2.1.10.81.1.1.5
dsx0ReceivedCode	1.3.6.1.2.1.10.81.1.1.6
dsx0TransmitCodesEnable	1.3.6.1.2.1.10.81.1.1.7
dsx0Ds0BundleMappedIfIndex	1.3.6.1.2.1.10.81.1.1.8
dsx0ChanMappedIfIndex	1.3.6.1.2.1.10.81.3.1.1



## MIB files in the POLICY-MIB.my file

The following table provides a list of the MIBs in the POLICY-MIB.MY file that are supported by the G450 and their OIDs:

Object	OID
ipPolicyListSlot	1.3.6.1.4.1.81.36.1.1.1
ipPolicyListID	1.3.6.1.4.1.81.36.1.1.2
ipPolicyListName	1.3.6.1.4.1.81.36.1.1.3
ipPolicyListValidityStatus	1.3.6.1.4.1.81.36.1.1.4
ipPolicyListChecksum	1.3.6.1.4.1.81.36.1.1.5
ipPolicyListRowStatus	1.3.6.1.4.1.81.36.1.1.6
ipPolicyListDefaultOperation	1.3.6.1.4.1.81.36.1.1.7
ipPolicyListCookie	1.3.6.1.4.1.81.36.1.1.8
ipPolicyListTrackChanges	1.3.6.1.4.1.81.36.1.1.9
ipPolicyListOwner	1.3.6.1.4.1.81.36.1.1.10
ipPolicyListErrMsg	1.3.6.1.4.1.81.36.1.1.11
ipPolicyListTrustedFields	1.3.6.1.4.1.81.36.1.1.12
ipPolicyListScope	1.3.6.1.4.1.81.36.1.1.13
ipPolicyListIpOptionOperation	1.3.6.1.4.1.81.36.1.1.14
ipPolicyListIpFragmentationOperation	1.3.6.1.4.1.81.36.1.1.15
ipPolicyListType	1.3.6.1.4.1.81.36.1.1.16
ipPolicyListEtherTypeDefaultOperation	1.3.6.1.4.1.81.36.1.1.17
ipPolicyRuleSlot	1.3.6.1.4.1.81.36.2.1.1
ipPolicyRuleListID	1.3.6.1.4.1.81.36.2.1.2
ipPolicyRuleID	1.3.6.1.4.1.81.36.2.1.3
ipPolicyRuleSrcAddr	1.3.6.1.4.1.81.36.2.1.4
ipPolicyRuleSrcAddrWild	1.3.6.1.4.1.81.36.2.1.5

*1 of 7*

## Traps and MIBs

Object	OID
ipPolicyRuleDstAddr	1.3.6.1.4.1.81.36.2.1.6
ipPolicyRuleDstAddrWild	1.3.6.1.4.1.81.36.2.1.7
ipPolicyRuleProtocol	1.3.6.1.4.1.81.36.2.1.8
ipPolicyRuleL4SrcPortMin	1.3.6.1.4.1.81.36.2.1.9
ipPolicyRuleL4SrcPortMax	1.3.6.1.4.1.81.36.2.1.10
ipPolicyRuleL4DestPortMin	1.3.6.1.4.1.81.36.2.1.11
ipPolicyRuleL4DestPortMax	1.3.6.1.4.1.81.36.2.1.12
ipPolicyRuleEstablished	1.3.6.1.4.1.81.36.2.1.13
ipPolicyRuleOperation	1.3.6.1.4.1.81.36.2.1.14
ipPolicyRuleApplicabilityPrecedence	1.3.6.1.4.1.81.36.2.1.15
ipPolicyRuleApplicabilityStatus	1.3.6.1.4.1.81.36.2.1.16
ipPolicyRuleApplicabilityType	1.3.6.1.4.1.81.36.2.1.17
ipPolicyRuleErrMsg	1.3.6.1.4.1.81.36.2.1.18
ipPolicyRuleStatus	1.3.6.1.4.1.81.36.2.1.19
ipPolicyRuleDSCPOperation	1.3.6.1.4.1.81.36.2.1.20
ipPolicyRuleDSCPFilter	1.3.6.1.4.1.81.36.2.1.21
ipPolicyRuleDSCPFilterWild	1.3.6.1.4.1.81.36.2.1.22
ipPolicyRuleIcmpTypeCode	1.3.6.1.4.1.81.36.2.1.23
ipPolicyRuleSrcAddrNot	1.3.6.1.4.1.81.36.2.1.24
ipPolicyRuleDstAddrNot	1.3.6.1.4.1.81.36.2.1.25
ipPolicyRuleProtocolNot	1.3.6.1.4.1.81.36.2.1.26
ipPolicyRuleL4SrcPortNot	1.3.6.1.4.1.81.36.2.1.27
ipPolicyRuleL4DestPortNot	1.3.6.1.4.1.81.36.2.1.28
ipPolicyRuleIcmpTypeCodeNot	1.3.6.1.4.1.81.36.2.1.29
ipPolicyRuleSrcPolicyUserGroupName	1.3.6.1.4.1.81.36.2.1.30
ipPolicyRuleDstPolicyUserGroupName	1.3.6.1.4.1.81.36.2.1.31

**2 of 7**

<b>Object</b>	<b>OID</b>
ipPolicyControlSlot	1.3.6.1.4.1.81.36.3.1.1
ipPolicyControlActiveGeneralList	1.3.6.1.4.1.81.36.3.1.2
ipPolicyControlAllowedPolicyManagers	1.3.6.1.4.1.81.36.3.1.3
ipPolicyControlCurrentChecksum	1.3.6.1.4.1.81.36.3.1.4
ipPolicyControlMinimalPolicyManagmentVersion	1.3.6.1.4.1.81.36.3.1.5
ipPolicyControlMaximalPolicyManagmentVersion	1.3.6.1.4.1.81.36.3.1.6
ipPolicyControlMIBversion	1.3.6.1.4.1.81.36.3.1.7
ipPolicyDiffServSlot	1.3.6.1.4.1.81.36.4.1.1
ipPolicyDiffServDSCP	1.3.6.1.4.1.81.36.4.1.2
ipPolicyDiffServOperation	1.3.6.1.4.1.81.36.4.1.3
ipPolicyDiffServName	1.3.6.1.4.1.81.36.4.1.4
ipPolicyDiffServAggIndex	1.3.6.1.4.1.81.36.4.1.5
ipPolicyDiffServApplicabilityPrecedence	1.3.6.1.4.1.81.36.4.1.6
ipPolicyDiffServApplicabilityStatus	1.3.6.1.4.1.81.36.4.1.7
ipPolicyDiffServApplicabilityType	1.3.6.1.4.1.81.36.4.1.8
ipPolicyDiffServErrMsg	1.3.6.1.4.1.81.36.4.1.9
ipPolicyQuerySlot	1.3.6.1.4.1.81.36.5.1.1
ipPolicyQueryListID	1.3.6.1.4.1.81.36.5.1.2
ipPolicyQuerySrcAddr	1.3.6.1.4.1.81.36.5.1.3
ipPolicyQueryDstAddr	1.3.6.1.4.1.81.36.5.1.4
ipPolicyQueryProtocol	1.3.6.1.4.1.81.36.5.1.5
ipPolicyQueryL4SrcPort	1.3.6.1.4.1.81.36.5.1.6
ipPolicyQueryL4DestPort	1.3.6.1.4.1.81.36.5.1.7
ipPolicyQueryEstablished	1.3.6.1.4.1.81.36.5.1.8
ipPolicyQueryDSCP	1.3.6.1.4.1.81.36.5.1.9
ipPolicyQueryOperation	1.3.6.1.4.1.81.36.5.1.10
<b>3 of 7</b>	

## Traps and MIBs

<b>Object</b>	<b>OID</b>
ipPolicyQueryRuleID	1.3.6.1.4.1.81.36.5.1.11
ipPolicyQueryDSCPOperation	1.3.6.1.4.1.81.36.5.1.12
ipPolicyQueryPriority	1.3.6.1.4.1.81.36.5.1.13
ipPolicyQueryIfIndex	1.3.6.1.4.1.81.36.5.1.14
ipPolicyQuerySubContext	1.3.6.1.4.1.81.36.5.1.15
ipPolicyQueryEtherTypeType	1.3.6.1.4.1.81.36.5.1.16
ipPolicyQueryEtherTypeTrafficType	1.3.6.1.4.1.81.36.5.1.17
ipPolicyQueryIcmpTypeCode	1.3.6.1.4.1.81.36.5.1.18
ipPolicyDiffServControlSlot	1.3.6.1.4.1.81.36.6.1.1
ipPolicyDiffServControlChecksum	1.3.6.1.4.1.81.36.6.1.2
ipPolicyDiffServControlTrustedFields	1.3.6.1.4.1.81.36.6.1.3
ipPolicyDiffServControlValidityStatus	1.3.6.1.4.1.81.36.6.1.4
ipPolicyDiffServControlErrMsg	1.3.6.1.4.1.81.36.6.1.5
ipPolicyAccessControlViolationEntID	1.3.6.1.4.1.81.36.7.1.1
ipPolicyAccessControlViolationSrcAddr	1.3.6.1.4.1.81.36.7.1.2
ipPolicyAccessControlViolationDstAddr	1.3.6.1.4.1.81.36.7.1.3
ipPolicyAccessControlViolationProtocol	1.3.6.1.4.1.81.36.7.1.4
ipPolicyAccessControlViolationL4SrcPort	1.3.6.1.4.1.81.36.7.1.5
ipPolicyAccessControlViolationL4DstPort	1.3.6.1.4.1.81.36.7.1.6
ipPolicyAccessControlViolationEstablished	1.3.6.1.4.1.81.36.7.1.7
ipPolicyAccessControlViolationDSCP	1.3.6.1.4.1.81.36.7.1.8
ipPolicyAccessControlViolationIfIndex	1.3.6.1.4.1.81.36.7.1.9
ipPolicyAccessControlViolationSubCtxt	1.3.6.1.4.1.81.36.7.1.10
ipPolicyAccessControlViolationTime	1.3.6.1.4.1.81.36.7.1.11
ipPolicyAccessControlViolationRuleType	1.3.6.1.4.1.81.36.7.1.12
ipPolicyCompositeOpEntID	1.3.6.1.4.1.81.36.8.1.1

**4 of 7**

<b>Object</b>	<b>OID</b>
ipPolicyCompositeOpListID	1.3.6.1.4.1.81.36.8.1.2
ipPolicyCompositeOpID	1.3.6.1.4.1.81.36.8.1.3
ipPolicyCompositeOpName	1.3.6.1.4.1.81.36.8.1.4
ipPolicyCompositeOp802priority	1.3.6.1.4.1.81.36.8.1.5
ipPolicyCompositeOpAccess	1.3.6.1.4.1.81.36.8.1.6
ipPolicyCompositeOpDscp	1.3.6.1.4.1.81.36.8.1.7
ipPolicyCompositeOpRSGQualityClass	1.3.6.1.4.1.81.36.8.1.8
ipPolicyCompositeOpNotify	1.3.6.1.4.1.81.36.8.1.9
ipPolicyCompositeOpRowStatus	1.3.6.1.4.1.81.36.8.1.10
ipPolicyCompositeOpErrorReply	1.3.6.1.4.1.81.36.8.1.11
ipPolicyCompositeOpKeepsState	1.3.6.1.4.1.81.36.8.1.12
ipPolicyDSCPmapEntID	1.3.6.1.4.1.81.36.9.1.1
ipPolicyDSCPmapListID	1.3.6.1.4.1.81.36.9.1.2
ipPolicyDSCPmapDSCP	1.3.6.1.4.1.81.36.9.1.3
ipPolicyDSCPmapOperation	1.3.6.1.4.1.81.36.9.1.4
ipPolicyDSCPmapName	1.3.6.1.4.1.81.36.9.1.5
ipPolicyDSCPmapApplicabilityPrecedence	1.3.6.1.4.1.81.36.9.1.6
ipPolicyDSCPmapApplicabilityStatus	1.3.6.1.4.1.81.36.9.1.7
ipPolicyDSCPmapApplicabilityType	1.3.6.1.4.1.81.36.9.1.8
ipPolicyDSCPmapErrMsg	1.3.6.1.4.1.81.36.9.1.9
ipPolicyActivationEntID	1.3.6.1.4.1.81.36.10.1.1
ipPolicyActivationifIndex	1.3.6.1.4.1.81.36.10.1.2
ipPolicyActivationSubContext	1.3.6.1.4.1.81.36.10.1.3
ipPolicyActivationSubContextName	1.3.6.1.4.1.81.36.10.1.4
ipPolicyActivationList	1.3.6.1.4.1.81.36.10.1.5
ipPolicyActivationAclList	1.3.6.1.4.1.81.36.10.1.6
<b>5 of 7</b>	

## Traps and MIBs

Object	OID
ipPolicyActivationQoSList	1.3.6.1.4.1.81.36.10.1.7
ipPolicyActivationSourceNatList	1.3.6.1.4.1.81.36.10.1.8
ipPolicyActivationDestinationNatList	1.3.6.1.4.1.81.36.10.1.9
ipPolicyActivationAntiSpoofignList	1.3.6.1.4.1.81.36.10.1.10
ipPolicyActivationPBRLList	
ipPolicyValidListEntID	1.3.6.1.4.1.81.36.11.1.1.1
ipPolicyValidListIfIndex	1.3.6.1.4.1.81.36.11.1.1.2
ipPolicyValidListSubContext	1.3.6.1.4.1.81.36.11.1.1.3
ipPolicyValidListListID	1.3.6.1.4.1.81.36.11.1.1.4
ipPolicyValidListStatus	1.3.6.1.4.1.81.36.11.1.1.5
ipPolicyValidListErrMsg	1.3.6.1.4.1.81.36.11.1.1.6
ipPolicyValidListIpOption	1.3.6.1.4.1.81.36.11.1.1.7
ipPolicyValidListIpFragmentation	1.3.6.1.4.1.81.36.11.1.1.8
ipPolicyValidRuleEntID	1.3.6.1.4.1.81.36.11.2.1.1
ipPolicyValidRuleIfIndex	1.3.6.1.4.1.81.36.11.2.1.2
ipPolicyValidRuleSubContext	1.3.6.1.4.1.81.36.11.2.1.3
ipPolicyValidRuleListID	1.3.6.1.4.1.81.36.11.2.1.4
ipPolicyValidRuleRuleID	1.3.6.1.4.1.81.36.11.2.1.5
ipPolicyValidRuleStatus	1.3.6.1.4.1.81.36.11.2.1.6
ipPolicyValidRuleApplicabilityType	1.3.6.1.4.1.81.36.11.2.1.7
ipPolicyValidRuleErrMsg	1.3.6.1.4.1.81.36.11.2.1.8
ipPolicyValidDSCPEntID	1.3.6.1.4.1.81.36.11.3.1.1
ipPolicyValidDSCPIfIndex	1.3.6.1.4.1.81.36.11.3.1.2
ipPolicyValidDSCPSubContext	1.3.6.1.4.1.81.36.11.3.1.3
ipPolicyValidDSCPListID	1.3.6.1.4.1.81.36.11.3.1.4
ipPolicyValidDSCPvalue	1.3.6.1.4.1.81.36.11.3.1.5

**6 of 7**

Object	OID
ipPolicyValidDSCPStatus	1.3.6.1.4.1.81.36.11.3.1.6
ipPolicyValidDSCPApplicabilityType	1.3.6.1.4.1.81.36.11.3.1.7
ipPolicyValidDSCPErrMsg	1.3.6.1.4.1.81.36.11.3.1.8
<b>7 of 7</b>	

## MIB files in the BRIDGE-MIB.my file

The following table provides a list of the MIBs in the BRIDGE-MIB.my file that are supported by the G450 and their OIDs:

Object	OID
dot1dBaseBridgeAddress	1.3.6.1.2.1.17.1.1
dot1dBaseNumPorts	1.3.6.1.2.1.17.1.2
dot1dBaseType	1.3.6.1.2.1.17.1.3
dot1dBasePort	1.3.6.1.2.1.17.1.4.1.1
dot1dBasePortIfIndex	1.3.6.1.2.1.17.1.4.1.2
dot1dBasePortCircuit	1.3.6.1.2.1.17.1.4.1.3
dot1dBasePortDelayExceededDiscards	1.3.6.1.2.1.17.1.4.1.4
dot1dBasePortMtuExceededDiscards	1.3.6.1.2.1.17.1.4.1.5
dot1dStpProtocolSpecification	1.3.6.1.2.1.17.2.1
dot1dStpPriority	1.3.6.1.2.1.17.2.2
dot1dStpTimeSinceTopologyChange	1.3.6.1.2.1.17.2.3
dot1dStpTopChanges	1.3.6.1.2.1.17.2.4
dot1dStpDesignatedRoot	1.3.6.1.2.1.17.2.5
dot1dStpRootCost	1.3.6.1.2.1.17.2.6
dot1dStpRootPort	1.3.6.1.2.1.17.2.7
dot1dStpMaxAge	1.3.6.1.2.1.17.2.8
<b>1 of 2</b>	

## Traps and MIBs

<b>Object</b>	<b>OID</b>
dot1dStpHelloTime	1.3.6.1.2.1.17.2.9
dot1dStpHoldTime	1.3.6.1.2.1.17.2.10
dot1dStpForwardDelay	1.3.6.1.2.1.17.2.11
dot1dStpBridgeMaxAge	1.3.6.1.2.1.17.2.12
dot1dStpBridgeHelloTime	1.3.6.1.2.1.17.2.13
dot1dStpBridgeForwardDelay	1.3.6.1.2.1.17.2.14
dot1dStpPort	1.3.6.1.2.1.17.2.15.1.1
dot1dStpPortPriority	1.3.6.1.2.1.17.2.15.1.2
dot1dStpPortState	1.3.6.1.2.1.17.2.15.1.3
dot1dStpPortEnable	1.3.6.1.2.1.17.2.15.1.4
dot1dStpPortPathCost	1.3.6.1.2.1.17.2.15.1.5
dot1dStpPortDesignatedRoot	1.3.6.1.2.1.17.2.15.1.6
dot1dStpPortDesignatedCost	1.3.6.1.2.1.17.2.15.1.7
dot1dStpPortDesignatedBridge	1.3.6.1.2.1.17.2.15.1.8
dot1dStpPortDesignatedPort	1.3.6.1.2.1.17.2.15.1.9
dot1dStpPortForwardTransitions	1.3.6.1.2.1.17.2.15.1.10
dot1dTpAgingTime	1.3.6.1.2.1.17.4.2
dot1dTpFdbAddress	1.3.6.1.2.1.17.4.3.1.1
dot1dTpFdbPort	1.3.6.1.2.1.17.4.3.1.2
dot1dTpFdbStatus	1.3.6.1.2.1.17.4.3.1.3

**2 of 2**



## MIB files in the CONFIG-MIB.my file

The following table provides a list of the MIBs in the CONFIG-MIB.MY file that are supported by the G450 and their OIDs:

Object	OID
chHWType	1.3.6.1.4.1.81.7.1
chNumberOfSlots	1.3.6.1.4.1.81.7.2
chReset	1.3.6.1.4.1.81.7.7
chLntAgMaxNmbOfMngrs	1.3.6.1.4.1.81.7.9.3.1
chLntAgPermMngrId	1.3.6.1.4.1.81.7.9.3.2.1.1
chLntAgPermMngrAddr	1.3.6.1.4.1.81.7.9.3.2.1.2
chLntAgMngrTraps	1.3.6.1.4.1.81.7.9.3.2.1.3
chLntAgTrapsPermMngrId	1.3.6.1.4.1.81.7.9.3.7.1.1
chLntAgTrapsId	1.3.6.1.4.1.81.7.9.3.7.1.2
chLntAgTrapsEnableFlag	1.3.6.1.4.1.81.7.9.3.7.1.3
chLntAgMaxTrapsNumber	1.3.6.1.4.1.81.7.9.3.100
chGroupList	1.3.6.1.4.1.81.7.18
chLogFileGroupId	1.3.6.1.4.1.81.7.22.1.1
chLogFileIndex	1.3.6.1.4.1.81.7.22.1.2
chLogFileName	1.3.6.1.4.1.81.7.22.1.3
chLogFileAbsoluteTime	1.3.6.1.4.1.81.7.22.1.4
chLogFileMessage	1.3.6.1.4.1.81.7.22.1.5
chLogFileEncryptedMessage	1.3.6.1.4.1.81.7.22.1.6
genGroupId	1.3.6.1.4.1.81.8.1.1.1
genGroupSWVersion	1.3.6.1.4.1.81.8.1.1.2
genGroupKernelVersion	1.3.6.1.4.1.81.8.1.1.3
genGroupType	1.3.6.1.4.1.81.8.1.1.4

1 of 4

## Traps and MIBs

<b>Object</b>	<b>OID</b>
genGroupDescr	1.3.6.1.4.1.81.8.1.1.5
genGroupNumberOfPorts	1.3.6.1.4.1.81.8.1.1.6
genGroupNumberOfIntPorts	1.3.6.1.4.1.81.8.1.1.7
genGroupReset	1.3.6.1.4.1.81.8.1.1.8
genGroupAutoMan	1.3.6.1.4.1.81.8.1.1.9
genGroupFullConfig	1.3.6.1.4.1.81.8.1.1.10
genGroupRedun12	1.3.6.1.4.1.81.8.1.1.11
genGroupRedun34	1.3.6.1.4.1.81.8.1.1.12
genGroupStandAloneMode	1.3.6.1.4.1.81.8.1.1.14
genGroupInterProcCommStatus	1.3.6.1.4.1.81.8.1.1.15
genGroupCommStatus	1.3.6.1.4.1.81.8.1.1.16
genGroupHWStatus	1.3.6.1.4.1.81.8.1.1.17
genGroupSupplyVoltageFault	1.3.6.1.4.1.81.8.1.1.18
genGroupIntTemp	1.3.6.1.4.1.81.8.1.1.19
genGroupSpecificOID	1.3.6.1.4.1.81.8.1.1.20
genGroupConfigurationSymbol	1.3.6.1.4.1.81.8.1.1.21
genGroupLastChange	1.3.6.1.4.1.81.8.1.1.22
genGroupRedunRecovery	1.3.6.1.4.1.81.8.1.1.23
genGroupHWVersion	1.3.6.1.4.1.81.8.1.1.24
genGroupHeight	1.3.6.1.4.1.81.8.1.1.25
genGroupWidth	1.3.6.1.4.1.81.8.1.1.26
genGroupIntrusionControl	1.3.6.1.4.1.81.8.1.1.27
genGroupThresholdStatus	1.3.6.1.4.1.81.8.1.1.28
genGroupEavesdropping	1.3.6.1.4.1.81.8.1.1.29
genGroupMainSWVersion	1.3.6.1.4.1.81.8.1.1.30
genGroupMPSActivityStatus	1.3.6.1.4.1.81.8.1.1.31

**2 of 4**

<b>Object</b>	<b>OID</b>
genGroupBUPSActivityStatus	1.3.6.1.4.1.81.8.1.1.32
genGroupPrepareCounters	1.3.6.1.4.1.81.8.1.1.33
genGroupPortLastChange	1.3.6.1.4.1.81.8.1.1.34
genGroupIntPortLastChange	1.3.6.1.4.1.81.8.1.1.35
genGroupFaultMask	1.3.6.1.4.1.81.8.1.1.36
genGroupName	1.3.6.1.4.1.81.8.1.1.37
genGroupAgentSlot	1.3.6.1.4.1.81.8.1.1.38
genGroupMngType	1.3.6.1.4.1.81.8.1.1.39
genGroupNumberOfLogicalPorts	1.3.6.1.4.1.81.8.1.1.40
genGroupNumberOfInterfaces	1.3.6.1.4.1.81.8.1.1.41
genGroupCascadUpStatus	1.3.6.1.4.1.81.8.1.1.42
genGroupCascadDownStatus	1.3.6.1.4.1.81.8.1.1.43
genGroupSTARootPortID	1.3.6.1.4.1.81.8.1.1.44
genGroupCopyPortInstruction	1.3.6.1.4.1.81.8.1.1.45
genGroupLicenseKey	1.3.6.1.4.1.81.8.1.1.46
genGroupLogFileClear	1.3.6.1.4.1.81.8.1.1.47
genGroupBootVersion	1.3.6.1.4.1.81.8.1.1.48
genGroupResetLastStamp	1.3.6.1.4.1.81.8.1.1.49
genGroupSerialNumber	1.3.6.1.4.1.81.8.1.1.50
genGroupShowModuleInformation	1.3.6.1.4.1.81.8.1.1.51
genGroupCascadingUpFault	1.3.6.1.4.1.81.8.1.1.52
genGroupCascadingDownFault	1.3.6.1.4.1.81.8.1.1.53
genGroupPortClassificationMask	1.3.6.1.4.1.81.8.1.1.54
genGroupPSUType	1.3.6.1.4.1.81.8.1.1.55
genGroupPolicyType	1.3.6.1.4.1.81.8.1.1.56
genPortGroupID	1.3.6.1.4.1.81.9.1.1.1
<b>3 of 4</b>	

## Traps and MIBs

Object	OID
genPortId	1.3.6.1.4.1.81.9.1.1.2
genPortFunctionality	1.3.6.1.4.1.81.9.1.1.3
genPortType	1.3.6.1.4.1.81.9.1.1.4
genPortDescr	1.3.6.1.4.1.81.9.1.1.5
genPortAdminStatus	1.3.6.1.4.1.81.9.1.1.10
genPortFaultMask	1.3.6.1.4.1.81.9.1.1.14
genPortSWRdFault	1.3.6.1.4.1.81.9.1.1.15
genPortVLANMode	1.3.6.1.4.1.81.9.1.1.19
genPortAdminPermission	1.3.6.1.4.1.81.9.1.1.20
genPortName	1.3.6.1.4.1.81.9.1.1.21
genPortClassification	1.3.6.1.4.1.81.9.1.1.22
genPortVLANBindingMode	1.3.6.1.4.1.81.9.1.1.23
softRedundancyId	1.3.6.1.4.1.81.11.1.1.1
softRedundancyName	1.3.6.1.4.1.81.11.1.1.2
softRedundancyGroupId1	1.3.6.1.4.1.81.11.1.1.3
softRedundancyPortId1	1.3.6.1.4.1.81.11.1.1.4
softRedundancyGroupId2	1.3.6.1.4.1.81.11.1.1.5
softRedundancyPortId2	1.3.6.1.4.1.81.11.1.1.6
softRedundancyStatus	1.3.6.1.4.1.81.11.1.1.7
softRedundancyGlobalStatus	1.3.6.1.4.1.81.11.2
softRedundancyMinTimeBetweenSwitchOvers	1.3.6.1.4.1.81.11.4
softRedundancySwitchBackInterval	1.3.6.1.4.1.81.11.5

**4 of 4**

## MIB files in the G700-MG-MIB.my file

The following table provides a list of the MIBs in the G700-MG-MIB.MY file that are supported by the G450 and their OIDs:

Object	OID
cmgHWType	1.3.6.1.4.1.6889.2.9.1.1.1
cmgModelNumber	1.3.6.1.4.1.6889.2.9.1.1.2
cmgDescription	1.3.6.1.4.1.6889.2.9.1.1.3
cmgSerialNumber	1.3.6.1.4.1.6889.2.9.1.1.4
cmgHWWintage	1.3.6.1.4.1.6889.2.9.1.1.5
cmgHWSuffix	1.3.6.1.4.1.6889.2.9.1.1.6
cmgStackPosition	1.3.6.1.4.1.6889.2.9.1.1.7
cmgModuleList	1.3.6.1.4.1.6889.2.9.1.1.8
cmgReset	1.3.6.1.4.1.6889.2.9.1.1.9
cmgHardwareFaultMask	1.3.6.1.4.1.6889.2.9.1.1.10.12
cmgHardwareStatusMask	1.3.6.1.4.1.6889.2.9.1.1.10.13
cmgModuleSlot	1.3.6.1.4.1.6889.2.9.1.1.11.1.1.1
cmgModuleType	1.3.6.1.4.1.6889.2.9.1.1.11.1.1.2
cmgModuleDescription	1.3.6.1.4.1.6889.2.9.1.1.11.1.1.3
cmgModuleName	1.3.6.1.4.1.6889.2.9.1.1.11.1.1.4
cmgModuleSerialNumber	1.3.6.1.4.1.6889.2.9.1.1.11.1.1.5
cmgModuleHWWintage	1.3.6.1.4.1.6889.2.9.1.1.11.1.1.6
cmgModuleHWSuffix	1.3.6.1.4.1.6889.2.9.1.1.11.1.1.7
cmgModuleFWVersion	1.3.6.1.4.1.6889.2.9.1.1.11.1.1.8
cmgModuleNumberOfPorts	1.3.6.1.4.1.6889.2.9.1.1.11.1.1.9
cmgModuleFaultMask	1.3.6.1.4.1.6889.2.9.1.1.11.1.1.10
cmgModuleStatusMask	1.3.6.1.4.1.6889.2.9.1.1.11.1.1.11
cmgModuleReset	1.3.6.1.4.1.6889.2.9.1.1.11.1.1.12
cmgModuleNumberOfChannels	1.3.6.1.4.1.6889.2.9.1.1.11.1.1.13

**1 of 5**

## Traps and MIBs

<b>Object</b>	<b>OID</b>
cmgGatewayNumber	1.3.6.1.4.1.6889.2.9.1.2.1.1
cmgMACAddress	1.3.6.1.4.1.6889.2.9.1.2.1.2
cmgFWVersion	1.3.6.1.4.1.6889.2.9.1.2.1.3
cmgCurrentIpAddress	1.3.6.1.4.1.6889.2.9.1.2.1.4
cmgMgpFaultMask	1.3.6.1.4.1.6889.2.9.1.2.1.15
cmgQosControl	1.3.6.1.4.1.6889.2.9.1.2.2.1
cmgRemoteSigDscp	1.3.6.1.4.1.6889.2.9.1.2.2.2
cmgRemoteSig802Priority	1.3.6.1.4.1.6889.2.9.1.2.2.3
cmgLocalSigDscp	1.3.6.1.4.1.6889.2.9.1.2.2.4
cmgLocalSig802Priority	1.3.6.1.4.1.6889.2.9.1.2.2.5
cmgStatic802Vlan	1.3.6.1.4.1.6889.2.9.1.2.2.6
cmgCurrent802Vlan	1.3.6.1.4.1.6889.2.9.1.2.2.7
cmgPrimaryClockSource	1.3.6.1.4.1.6889.2.9.1.2.3.1
cmgSecondaryClockSource	1.3.6.1.4.1.6889.2.9.1.2.3.2
cmgActiveClockSource	1.3.6.1.4.1.6889.2.9.1.2.3.3
cmgRegistrationState	1.3.6.1.4.1.6889.2.9.1.3.1
cmgActiveControllerAddress	1.3.6.1.4.1.6889.2.9.1.3.2
cmgH248LinkStatus	1.3.6.1.4.1.6889.2.9.1.3.3
cmgH248LinkErrorCode	1.3.6.1.4.1.6889.2.9.1.3.4
cmgUseDhcpForMgcList	1.3.6.1.4.1.6889.2.9.1.3.5
cmgStaticControllerHosts	1.3.6.1.4.1.6889.2.9.1.3.6
cmgDhcpControllerHosts	1.3.6.1.4.1.6889.2.9.1.3.7
cmgPrimarySearchTime	
cmgTotalSearchTime	
cmgTransitionPoint	
cmgVoipEngineUseDhcp	1.3.6.1.4.1.6889.2.9.1.4.1
cmgVoipQosControl	1.3.6.1.4.1.6889.2.9.1.4.2
cmgVoipRemoteBbeDscp	1.3.6.1.4.1.6889.2.9.1.4.3.1.1

**2 of 5**

<b>Object</b>	<b>OID</b>
cmgVoipRemoteEfDscp	1.3.6.1.4.1.6889.2.9.1.4.3.1.2
cmgVoipRemote802Priority	1.3.6.1.4.1.6889.2.9.1.4.3.1.3
cmgVoipRemoteMinRtpPort	1.3.6.1.4.1.6889.2.9.1.4.3.1.4
cmgVoipRemoteMaxRtpPort	1.3.6.1.4.1.6889.2.9.1.4.3.1.5
cmgVoipRemoteRtcpEnabled	1.3.6.1.4.1.6889.2.9.1.4.3.2.1
cmgVoipRemoteRtcpMonitorIpAddress	1.3.6.1.4.1.6889.2.9.1.4.3.2.2
cmgVoipRemoteRtcpMonitorPort	1.3.6.1.4.1.6889.2.9.1.4.3.2.3
cmgVoipRemoteRtcpReportPeriod	1.3.6.1.4.1.6889.2.9.1.4.3.2.4
cmgVoipRemoteRsvpEnabled	1.3.6.1.4.1.6889.2.9.1.4.3.3.1
cmgVoipRemoteRetryOnFailure	1.3.6.1.4.1.6889.2.9.1.4.3.3.2
cmgVoipRemoteRetryDelay	1.3.6.1.4.1.6889.2.9.1.4.3.3.3
cmgVoipRemoteRsvpProfile	1.3.6.1.4.1.6889.2.9.1.4.3.3.4
cmgVoipLocalBbeDscp	1.3.6.1.4.1.6889.2.9.1.4.4.1.1
cmgVoipLocalEfDscp	1.3.6.1.4.1.6889.2.9.1.4.4.1.2
cmgVoipLocal802Priority	1.3.6.1.4.1.6889.2.9.1.4.4.1.3
cmgVoipLocalMinRtpPort	1.3.6.1.4.1.6889.2.9.1.4.4.1.4
cmgVoipLocalMaxRtpPort	1.3.6.1.4.1.6889.2.9.1.4.4.1.5
cmgVoipLocalRtcpEnabled	1.3.6.1.4.1.6889.2.9.1.4.4.2.1
cmgVoipLocalRtcpMonitorIpAddress	1.3.6.1.4.1.6889.2.9.1.4.4.2.2
cmgVoipLocalRtcpMonitorPort	1.3.6.1.4.1.6889.2.9.1.4.4.2.3
cmgVoipLocalRtcpReportPeriod	1.3.6.1.4.1.6889.2.9.1.4.4.2.4
cmgVoipLocalRsvpEnabled	1.3.6.1.4.1.6889.2.9.1.4.4.3.1
cmgVoipLocalRetryOnFailure	1.3.6.1.4.1.6889.2.9.1.4.4.3.2
cmgVoipLocalRetryDelay	1.3.6.1.4.1.6889.2.9.1.4.4.3.3
cmgVoipLocalRsvpProfile	1.3.6.1.4.1.6889.2.9.1.4.4.3.4
cmgVoipSlot	1.3.6.1.4.1.6889.2.9.1.4.5.1.1
cmgVoipMACAddress	1.3.6.1.4.1.6889.2.9.1.4.5.1.2
cmgVoipStaticIpAddress	1.3.6.1.4.1.6889.2.9.1.4.5.1.3

**3 of 5**

## Traps and MIBs

Object	OID
cmgVoipCurrentIpAddress	1.3.6.1.4.1.6889.2.9.1.4.5.1.4
cmgVoipJitterBufferSize	1.3.6.1.4.1.6889.2.9.1.4.5.1.5
cmgVoipTotalChannels	1.3.6.1.4.1.6889.2.9.1.4.5.1.6
cmgVoipChannelsInUse	1.3.6.1.4.1.6889.2.9.1.4.5.1.7
cmgVoipAverageOccupancy	1.3.6.1.4.1.6889.2.9.1.4.5.1.8
cmgVoipHyperactivity	1.3.6.1.4.1.6889.2.9.1.4.5.1.9
cmgVoipAdminState	1.3.6.1.4.1.6889.2.9.1.4.5.1.10
cmgVoipDspFWVersion	1.3.6.1.4.1.6889.2.9.1.4.5.1.11
cmgVoipDspStatus	1.3.6.1.4.1.6889.2.9.1.4.5.1.12
cmgVoipEngineReset	1.3.6.1.4.1.6889.2.9.1.4.5.1.13
cmgVoipFaultMask	1.3.6.1.4.1.6889.2.9.1.4.5.1.14
cmgCcModule	1.3.6.1.4.1.6889.2.9.1.6.1.1.1
cmgCcPort	1.3.6.1.4.1.6889.2.9.1.6.1.1.2
cmgCcRelay	1.3.6.1.4.1.6889.2.9.1.6.1.1.3
cmgCcAdminState	1.3.6.1.4.1.6889.2.9.1.6.1.1.4
cmgCcPulseDuration	1.3.6.1.4.1.6889.2.9.1.6.1.1.5
cmgCcStatus	1.3.6.1.4.1.6889.2.9.1.6.1.1.6
cmgTrapManagerAddress	
cmgTrapManagerControl	
cmgTrapManagerMask	
cmgTrapManagerRowStatus	
cmgEtrModule	1.3.6.1.4.1.6889.2.9.1.7.1.1.1
cmgEtrAdminState	1.3.6.1.4.1.6889.2.9.1.7.1.1.2
cmgEtrNumberOfPairs	1.3.6.1.4.1.6889.2.9.1.7.1.1.3
cmgEtrStatus	1.3.6.1.4.1.6889.2.9.1.7.1.1.4
cmgEtrCurrentLoopDetect	1.3.6.1.4.1.6889.2.9.1.7.1.1.5
cmgDynCacStatus	1.3.6.1.4.1.6889.2.9.1.8.1



Object	OID
cmgDynCacRBBL	1.3.6.1.4.1.6889.2.9.1.8.2
cmgDynCacLastUpdate	1.3.6.1.4.1.6889.2.9.1.8.3
<b>5 of 5</b>	

## MIB files in the FRAME-RELAY-DTE-MIB.my file

The following table provides a list of the MIBs in the FRAME-RELAY-DTE-MIB.my file that are supported by the G450 and their OIDs:

Object	OID
frDlcmIfIndex	1.3.6.1.2.1.10.32.1.1.1
frDlcmiState	1.3.6.1.2.1.10.32.1.1.2
frDlcmiAddress	1.3.6.1.2.1.10.32.1.1.3
frDlcmiAddressLen	1.3.6.1.2.1.10.32.1.1.4
frDlcmiPollingInterval	1.3.6.1.2.1.10.32.1.1.5
frDlcmiFullEnquiryInterval	1.3.6.1.2.1.10.32.1.1.6
frDlcmiErrorThreshold	1.3.6.1.2.1.10.32.1.1.7
frDlcmiMonitoredEvents	1.3.6.1.2.1.10.32.1.1.8
frDlcmiMaxSupportedVCs	1.3.6.1.2.1.10.32.1.1.9
frDlcmiMulticast	1.3.6.1.2.1.10.32.1.1.10
frDlcmiStatus	1.3.6.1.2.1.10.32.1.1.11
frDlcmiRowStatus	1.3.6.1.2.1.10.32.1.1.12
frCircuitIfIndex	1.3.6.1.2.1.10.32.2.1.1
frCircuitDlci	1.3.6.1.2.1.10.32.2.1.2
frCircuitState	1.3.6.1.2.1.10.32.2.1.3
frCircuitReceivedFECNs	1.3.6.1.2.1.10.32.2.1.4
frCircuitReceivedBECNs	1.3.6.1.2.1.10.32.2.1.5
<b>1 of 2</b>	

## Traps and MIBs

<b>Object</b>	<b>OID</b>
frCircuitSentFrames	1.3.6.1.2.1.10.32.2.1.6
frCircuitSentOctets	1.3.6.1.2.1.10.32.2.1.7
frCircuitReceivedFrames	1.3.6.1.2.1.10.32.2.1.8
frCircuitReceivedOctets	1.3.6.1.2.1.10.32.2.1.9
frCircuitCreationTime	1.3.6.1.2.1.10.32.2.1.10
frCircuitLastTimeChange	1.3.6.1.2.1.10.32.2.1.11
frCircuitCommittedBurst	1.3.6.1.2.1.10.32.2.1.12
frCircuitExcessBurst	1.3.6.1.2.1.10.32.2.1.13
frCircuitThroughput	1.3.6.1.2.1.10.32.2.1.14
frCircuitMulticast	1.3.6.1.2.1.10.32.2.1.15
frCircuitType	1.3.6.1.2.1.10.32.2.1.16
frCircuitDiscards	1.3.6.1.2.1.10.32.2.1.17
frCircuitReceivedDEs	1.3.6.1.2.1.10.32.2.1.18
frCircuitSentDEs	1.3.6.1.2.1.10.32.2.1.19
frCircuitLogicalIfIndex	1.3.6.1.2.1.10.32.2.1.20
frCircuitRowStatus	1.3.6.1.2.1.10.32.2.1.21
frErrIfIndex	1.3.6.1.2.1.10.32.3.1.1
frErrType	1.3.6.1.2.1.10.32.3.1.2
frErrData	1.3.6.1.2.1.10.32.3.1.3
frErrTime	1.3.6.1.2.1.10.32.3.1.4
frErrFaults	1.3.6.1.2.1.10.32.3.1.5
frErrFaultTime	1.3.6.1.2.1.10.32.3.1.6
frTrapState	1.3.6.1.2.1.10.32.4.1
frTrapMaxRate	1.3.6.1.2.1.10.32.4.2

---

**2 of 2**

---

## MIB files in the IP-MIB.my file

The following table provides a list of the MIBs in the IP-MIB.my file that are supported by the G450 and their OIDs:

Object	OID
ipForwarding	1.3.6.1.2.1.4.1
ipDefaultTTL	1.3.6.1.2.1.4.2
ipInReceives	1.3.6.1.2.1.4.3
ipInHdrErrors	1.3.6.1.2.1.4.4
ipInAddrErrors	1.3.6.1.2.1.4.5
ipForwDatagrams	1.3.6.1.2.1.4.6
ipInUnknownProtos	1.3.6.1.2.1.4.7
ipInDiscards	1.3.6.1.2.1.4.8
ipInDelivers	1.3.6.1.2.1.4.9
ipOutRequests	1.3.6.1.2.1.4.10
ipOutDiscards	1.3.6.1.2.1.4.11
ipOutNoRoutes	1.3.6.1.2.1.4.12
ipReasmTimeout	1.3.6.1.2.1.4.13
ipReasmReqds	1.3.6.1.2.1.4.14
ipReasmOKs	1.3.6.1.2.1.4.15
ipReasmFails	1.3.6.1.2.1.4.16
ipFragOKs	1.3.6.1.2.1.4.17
ipFragFails	1.3.6.1.2.1.4.18
ipFragCreates	1.3.6.1.2.1.4.19
ipAdEntAddr	1.3.6.1.2.1.4.20.1.1
ipAdEntIfIndex	1.3.6.1.2.1.4.20.1.2
ipAdEntNetMask	1.3.6.1.2.1.4.20.1.3
<i>1 of 2</i>	

## Traps and MIBs

Object	OID
ipAdEntBcastAddr	1.3.6.1.2.1.4.20.1.4
ipAdEntReasmMaxSize	1.3.6.1.2.1.4.20.1.5
ipNetToMediaIfIndex	1.3.6.1.2.1.4.22.1.1
ipNetToMediaPhysAddress	1.3.6.1.2.1.4.22.1.2
ipNetToMediaNetAddress	1.3.6.1.2.1.4.22.1.3
ipNetToMediaType	1.3.6.1.2.1.4.22.1.4
ipRoutingDiscards	1.3.6.1.2.1.4.23

**2 of 2**

---

## MIB files in the Load12-MIB.my file

The following table provides a list of the MIBs in the Load12-MIB.my file that are supported by the G450 and their OIDs:

Object	OID
genOpModuleId	1.3.6.1.4.1.1751.2.53.1.2.1.1
genOpIndex	1.3.6.1.4.1.1751.2.53.1.2.1.2
genOpRunningState	1.3.6.1.4.1.1751.2.53.1.2.1.3
genOpSourceIndex	1.3.6.1.4.1.1751.2.53.1.2.1.4
genOpDestIndex	1.3.6.1.4.1.1751.2.53.1.2.1.5
genOpServerIP	1.3.6.1.4.1.1751.2.53.1.2.1.6
genOpUserName	1.3.6.1.4.1.1751.2.53.1.2.1.7
genOpPassword	1.3.6.1.4.1.1751.2.53.1.2.1.8
genOpProtocolType	1.3.6.1.4.1.1751.2.53.1.2.1.9
genOpFileName	1.3.6.1.4.1.1751.2.53.1.2.1.10
genOpRunningStateDisplay	1.3.6.1.4.1.1751.2.53.1.2.1.11
genOpLastFailureIndex	1.3.6.1.4.1.1751.2.53.1.2.1.12

**1 of 2**

<b>Object</b>	<b>OID</b>
genOpLastFailureDisplay	1.3.6.1.4.1.1751.2.53.1.2.1.13
genOpLastWarningDisplay	1.3.6.1.4.1.1751.2.53.1.2.1.14
genOpErrorLogIndex	1.3.6.1.4.1.1751.2.53.1.2.1.15
genOpResetSupported	1.3.6.1.4.1.1751.2.53.1.2.1.16
genOpEnableReset	1.3.6.1.4.1.1751.2.53.1.2.1.17
genOpNextBootImageIndex	1.3.6.1.4.1.1751.2.53.1.2.1.18
genOpLastBootImageIndex	1.3.6.1.4.1.1751.2.53.1.2.1.19
genOpFileSystemType	1.3.6.1.4.1.1751.2.53.1.2.1.20
genOpReportSpecificFlags	1.3.6.1.4.1.1751.2.53.1.2.1.21
genOpOctetsReceived	1.3.6.1.4.1.1751.2.53.1.2.1.22
genAppFileId	1.3.6.1.4.1.1751.2.53.2.1.1.1
genAppFileName	1.3.6.1.4.1.1751.2.53.2.1.1.2
genAppFileType	1.3.6.1.4.1.1751.2.53.2.1.1.3
genAppFileDescription	1.3.6.1.4.1.1751.2.53.2.1.1.4
genAppFileSize	1.3.6.1.4.1.1751.2.53.2.1.1.5
genAppFileVersionNumber	1.3.6.1.4.1.1751.2.53.2.1.1.6
genAppFileLocation	1.3.6.1.4.1.1751.2.53.2.1.1.7
genAppFileDateStamp	1.3.6.1.4.1.1751.2.53.2.1.1.8
genAppFileRowStatus	1.3.6.1.4.1.1751.2.53.2.1.1.9
<b>2 of 2</b>	

## MIB files in the PPP-LCP-MIB.my file

The following table provides a list of the MIBs in the PPP-LCP-MIB.my file that are supported by the G450 and their OIDs:

Object	OID
pppLinkStatusPhysicalIndex	1.3.6.1.2.1.10.23.1.1.1.1.1
pppLinkStatusBadAddresses	1.3.6.1.2.1.10.23.1.1.1.1.2
pppLinkStatusBadControls	1.3.6.1.2.1.10.23.1.1.1.1.3
pppLinkStatusPacketTooLongs	1.3.6.1.2.1.10.23.1.1.1.1.4
pppLinkStatusBadFCSs	1.3.6.1.2.1.10.23.1.1.1.1.5
pppLinkStatusLocalMRU	1.3.6.1.2.1.10.23.1.1.1.1.6
pppLinkStatusRemoteMRU	1.3.6.1.2.1.10.23.1.1.1.1.7
pppLinkStatusLocalToPeerACCMMap	1.3.6.1.2.1.10.23.1.1.1.1.8
pppLinkStatusPeerToLocalACCMMap	1.3.6.1.2.1.10.23.1.1.1.1.9
pppLinkStatusLocalToRemoteACCompression	1.3.6.1.2.1.10.23.1.1.1.1.12
pppLinkStatusRemoteToLocalACCompression	1.3.6.1.2.1.10.23.1.1.1.1.13
pppLinkStatusTransmitFcsSize	1.3.6.1.2.1.10.23.1.1.1.1.14
pppLinkStatusReceiveFcsSize	1.3.6.1.2.1.10.23.1.1.1.1.15
pppLinkConfigInitialMRU	1.3.6.1.2.1.10.23.1.1.2.1.1
pppLinkConfigReceiveACCMMap	1.3.6.1.2.1.10.23.1.1.2.1.2
pppLinkConfigTransmitACCMMap	1.3.6.1.2.1.10.23.1.1.2.1.3
pppLinkConfigMagicNumber	1.3.6.1.2.1.10.23.1.1.2.1.4
pppLinkConfigFcsSize	1.3.6.1.2.1.10.23.1.1.2.1.5

## MIB files in the WAN-MIB.my file

The following table provides a list of the MIBs in the WAN-MIB.my file that are supported by the G450 and their OIDs:

Object	OID
ds0BundleMemmbersList	1.3.6.1.4.1.6889.2.1.6.1.1.2.1.1
ds0BundleSpeedFactor	1.3.6.1.4.1.6889.2.1.6.1.1.2.1.2
ds1DeviceMode	1.3.6.1.4.1.6889.2.1.6.2.1.1
ifTableXtndIndex	1.3.6.1.4.1.6889.2.1.6.2.2.1.1.1
ifTableXtndPeerAddress	1.3.6.1.4.1.6889.2.1.6.2.2.1.1.2
ifTableXtndVoIPQueue	1.3.6.1.4.1.6889.2.1.6.2.2.1.1.3
ifTableXtndCableLength	1.3.6.1.4.1.6889.2.1.6.2.2.1.1.4
ifTableXtndGain	1.3.6.1.4.1.6889.2.1.6.2.2.1.1.5
ifTableXtndDescription	1.3.6.1.4.1.6889.2.1.6.2.2.1.1.6
ifTableXtndKeepAlive	1.3.6.1.4.1.6889.2.1.6.2.2.1.1.7
ifTableXtndMtu	1.3.6.1.4.1.6889.2.1.6.2.2.1.1.8
ifTableXtndInvertTxClock	1.3.6.1.4.1.6889.2.1.6.2.2.1.1.9
ifTableXtndDTELoopback	1.3.6.1.4.1.6889.2.1.6.2.2.1.1.10
ifTableXtndIgnoreDCD	1.3.6.1.4.1.6889.2.1.6.2.2.1.1.11
ifTableXtndIdleChars	1.3.6.1.4.1.6889.2.1.6.2.2.1.1.12
ifTableXtndBandwidth	1.3.6.1.4.1.6889.2.1.6.2.2.1.1.13
ifTableXtndEncapsulation	1.3.6.1.4.1.6889.2.1.6.2.2.1.1.14
ifTableXtndOperStatus	1.3.6.1.4.1.6889.2.1.6.2.2.1.1.15
ifTableXtndBackupCapabilities	1.3.6.1.4.1.6889.2.1.6.2.2.1.1.16
ifTableXtndBackupPlf	1.3.6.1.4.1.6889.2.1.6.2.2.1.1.17
ifTableXtndBackupEnableDelay	1.3.6.1.4.1.6889.2.1.6.2.2.1.1.18
ifTableXtndBackupDisableDelay	1.3.6.1.4.1.6889.2.1.6.2.2.1.1.19
<b>1 of 2</b>	

## Traps and MIBs

<b>Object</b>	<b>OID</b>
ifTableXtndPrimaryIf	1.3.6.1.4.1.6889.2.1.6.2.2.1.1.20
ifTableXtndCarrierDelay	1.3.6.1.4.1.6889.2.1.6.2.2.1.1.21
ifTableXtndDtrRestartDelay	1.3.6.1.4.1.6889.2.1.6.2.2.1.1.22
ifTableXtndDtrPulseTime	1.3.6.1.4.1.6889.2.1.6.2.2.1.1.23
ifTableXtndLoadInterval	1.3.6.1.4.1.6889.2.1.6.2.2.1.1.24
ifTableXtndInputRate	1.3.6.1.4.1.6889.2.1.6.2.2.1.1.25
ifTableXtndOutputRate	1.3.6.1.4.1.6889.2.1.6.2.2.1.1.26
ifTableXtndInputLoad	1.3.6.1.4.1.6889.2.1.6.2.2.1.1.27
ifTableXtndOutputLoad	1.3.6.1.4.1.6889.2.1.6.2.2.1.1.28
ifTableXtndReliability	1.3.6.1.4.1.6889.2.1.6.2.2.1.1.29
ifTableXtndCacBBL	1.3.6.1.4.1.6889.2.1.6.2.2.1.1.31
ifTableXtndCacPriority	1.3.6.1.4.1.6889.2.1.6.2.2.1.1.32
ifTableXtndCacIfStatus	1.3.6.1.4.1.6889.2.1.6.2.2.1.1.33
frDlcmiXtndIndex	1.3.6.1.4.1.6889.2.1.6.2.4.1.1.1
frDlcmiXtndLMIAutoSense	1.3.6.1.4.1.6889.2.1.6.2.4.1.1.2
frStaticCircuitSubIfIndex	1.3.6.1.4.1.6889.2.1.6.2.4.2.1.1
frStaticCircuitDLCl	1.3.6.1.4.1.6889.2.1.6.2.4.2.1.2
frStaticCircuitDLClrole	1.3.6.1.4.1.6889.2.1.6.2.4.2.1.3
frStaticCircuitStatus	1.3.6.1.4.1.6889.2.1.6.2.4.2.1.4
frSubIfDlcmiIndex	1.3.6.1.4.1.6889.2.1.6.2.4.3.1.1
frSubIfSubIndex	1.3.6.1.4.1.6889.2.1.6.2.4.3.1.2
frSubIfType	1.3.6.1.4.1.6889.2.1.6.2.4.3.1.3
frSubIfStatus	1.3.6.1.4.1.6889.2.1.6.2.4.3.1.4

---

**2 of 2**



## MIB files in the SNMPv2-MIB.my file

The following table provides a list of the MIBs in the SNMPv2-MIB.my file that are supported by the G450 and their OIDs:

Object	OID
sysDescr	1.3.6.1.2.1.1.1
sysObjectID	1.3.6.1.2.1.1.2
sysUpTime	1.3.6.1.2.1.1.3
sysContact	1.3.6.1.2.1.1.4
sysName	1.3.6.1.2.1.1.5
sysLocation	1.3.6.1.2.1.1.6
sysServices	1.3.6.1.2.1.1.7
snmpInPkts	1.3.6.1.2.1.11.1
snmpInBadVersions	1.3.6.1.2.1.11.3
snmpInBadCommunityNames	1.3.6.1.2.1.11.4
snmpInBadCommunityUses	1.3.6.1.2.1.11.5
snmpInASNParseErrs	1.3.6.1.2.1.11.6
snmpEnableAuthenTraps	1.3.6.1.2.1.11.30
snmpOutPkts	1.3.6.1.2.1.11.2
snmpInTooBig	1.3.6.1.2.1.11.8
snmpInNoSuchNames	1.3.6.1.2.1.11.9
snmpInBadValues	1.3.6.1.2.1.11.10
snmpInReadOnly	1.3.6.1.2.1.11.11
snmpInGenErrs	1.3.6.1.2.1.11.12
snmpInTotalReqVars	1.3.6.1.2.1.11.13
snmpInTotalSetVars	1.3.6.1.2.1.11.14
snmpInGetRequests	1.3.6.1.2.1.11.15
<i>1 of 2</i>	

## Traps and MIBs

Object	OID
snmpInGetNexts	1.3.6.1.2.1.11.16
snmpInSetRequests	1.3.6.1.2.1.11.17
snmpInGetResponses	1.3.6.1.2.1.11.18
snmpInTraps	1.3.6.1.2.1.11.19
snmpOutTooBigs	1.3.6.1.2.1.11.20
snmpOutNoSuchNames	1.3.6.1.2.1.11.21
snmpOutBadValues	1.3.6.1.2.1.11.22
snmpOutGenErrs	1.3.6.1.2.1.11.24
snmpOutGetRequests	1.3.6.1.2.1.11.25
snmpOutGetNexts	1.3.6.1.2.1.11.26
snmpOutSetRequests	1.3.6.1.2.1.11.27
snmpOutGetResponses	1.3.6.1.2.1.11.28
snmpOutTraps	1.3.6.1.2.1.11.29

**2 of 2**

---

## MIB files in the OSPF-MIB.my file

The following table provides a list of the MIBs in the OSPF-MIB.my file that are supported by the G450 and their OIDs:

Object	OID
ospfRouterId	1.3.6.1.2.1.14.1.1
ospfAdminStat	1.3.6.1.2.1.14.1.2
ospfVersionNumber	1.3.6.1.2.1.14.1.3
ospfAreaBdrRtrStatus	1.3.6.1.2.1.14.1.4
ospfASBdrRtrStatus	1.3.6.1.2.1.14.1.5
ospfExternLsaCount	1.3.6.1.2.1.14.1.6

**1 of 4**

<b>Object</b>	<b>OID</b>
ospfExternLsaCksumSum	1.3.6.1.2.1.14.1.7
ospfTOSSupport	1.3.6.1.2.1.14.1.8
ospfOriginateNewLsas	1.3.6.1.2.1.14.1.9
ospfRxNewLsas	1.3.6.1.2.1.14.1.10
ospfExtLsdbLimit	1.3.6.1.2.1.14.1.11
ospfMulticastExtensions	1.3.6.1.2.1.14.1.12
ospfExitOverflowInterval	1.3.6.1.2.1.14.1.13
ospfDemandExtensions	1.3.6.1.2.1.14.1.14
ospfAreald	1.3.6.1.2.1.14.2.1.1
ospfAuthType	1.3.6.1.2.1.14.2.1.2
ospfImportAsExtern	1.3.6.1.2.1.14.2.1.3
ospfSpfRuns	1.3.6.1.2.1.14.2.1.4
ospfAreaBdrRtrCount	1.3.6.1.2.1.14.2.1.5
ospfAsBdrRtrCount	1.3.6.1.2.1.14.2.1.6
ospfAreaLsaCount	1.3.6.1.2.1.14.2.1.7
ospfAreaLsaCksumSum	1.3.6.1.2.1.14.2.1.8
ospfAreaSummary	1.3.6.1.2.1.14.2.1.9
ospfAreaStatus	1.3.6.1.2.1.14.2.1.10
ospfLsdbAreald	1.3.6.1.2.1.14.4.1.1
ospfLsdbType	1.3.6.1.2.1.14.4.1.2
ospfLsdbLsid	1.3.6.1.2.1.14.4.1.3
ospfLsdbRouterId	1.3.6.1.2.1.14.4.1.4
ospfLsdbSequence	1.3.6.1.2.1.14.4.1.5
ospfLsdbAge	1.3.6.1.2.1.14.4.1.6
ospfLsdbChecksum	1.3.6.1.2.1.14.4.1.7
ospfLsdbAdvertisement	1.3.6.1.2.1.14.4.1.8
<b>2 of 4</b>	

## Traps and MIBs

<b>Object</b>	<b>OID</b>
ospflfIpAddress	1.3.6.1.2.1.14.7.1.1
ospfAddressLessIf	1.3.6.1.2.1.14.7.1.2
ospflfAreaId	1.3.6.1.2.1.14.7.1.3
ospflfType	1.3.6.1.2.1.14.7.1.4
ospflfAdminStat	1.3.6.1.2.1.14.7.1.5
ospflfRtrPriority	1.3.6.1.2.1.14.7.1.6
ospflfTransitDelay	1.3.6.1.2.1.14.7.1.7
ospflfRetransInterval	1.3.6.1.2.1.14.7.1.8
ospflfHelloInterval	1.3.6.1.2.1.14.7.1.9
ospflfRtrDeadInterval	1.3.6.1.2.1.14.7.1.10
ospflfPollInterval	1.3.6.1.2.1.14.7.1.11
ospflfState	1.3.6.1.2.1.14.7.1.12
ospflfDesignatedRouter	1.3.6.1.2.1.14.7.1.13
ospflfBackupDesignatedRouter	1.3.6.1.2.1.14.7.1.14
ospflfEvents	1.3.6.1.2.1.14.7.1.15
ospflfAuthKey	1.3.6.1.2.1.14.7.1.16
ospflfStatus	1.3.6.1.2.1.14.7.1.17
ospflfMulticastForwarding	1.3.6.1.2.1.14.7.1.18
ospflfDemand	1.3.6.1.2.1.14.7.1.19
ospflfAuthType	1.3.6.1.2.1.14.7.1.20
ospflfMetricIpAddress	1.3.6.1.2.1.14.8.1.1
ospflfMetricAddressLessIf	1.3.6.1.2.1.14.8.1.2
ospflfMetricTOS	1.3.6.1.2.1.14.8.1.3
ospflfMetricValue	1.3.6.1.2.1.14.8.1.4
ospflfMetricStatus	1.3.6.1.2.1.14.8.1.5
ospfNbrIpAddr	1.3.6.1.2.1.14.10.1.1

**3 of 4**

Object	OID
ospfNbrAddressLessIndex	1.3.6.1.2.1.14.10.1.2
ospfNbrRtrId	1.3.6.1.2.1.14.10.1.3
ospfNbrOptions	1.3.6.1.2.1.14.10.1.4
ospfNbrPriority	1.3.6.1.2.1.14.10.1.5
ospfNbrState	1.3.6.1.2.1.14.10.1.6
ospfNbrEvents	1.3.6.1.2.1.14.10.1.7
ospfNbrLsRetransQLen	1.3.6.1.2.1.14.10.1.8
ospfNbmaNbrStatus	1.3.6.1.2.1.14.10.1.9
ospfNbmaNbrPermanence	1.3.6.1.2.1.14.10.1.10
ospfNbrHelloSuppressed	1.3.6.1.2.1.14.10.1.11
ospfExtLsdbType	1.3.6.1.2.1.14.12.1.1
ospfExtLsdbLsid	1.3.6.1.2.1.14.12.1.2
ospfExtLsdbRouterId	1.3.6.1.2.1.14.12.1.3
ospfExtLsdbSequence	1.3.6.1.2.1.14.12.1.4
ospfExtLsdbAge	1.3.6.1.2.1.14.12.1.5
ospfExtLsdbChecksum	1.3.6.1.2.1.14.12.1.6
ospfExtLsdbAdvertisement	1.3.6.1.2.1.14.12.1.7
<b>4 of 4</b>	

---

## MIB files in the TUNNEL-MIB.my file

The following table provides a list of the MIBs in the TUNNEL-MIB.my file that are supported by the G450 and their OIDs:

Object	OID
tunnelfLocalAddress	1.3.6.1.2.1.10.131.1.1.1.1.1
tunnelfRemoteAddress	1.3.6.1.2.1.10.131.1.1.1.1.2
<b>1 of 2</b>	

## Traps and MIBs

<b>Object</b>	<b>OID</b>
tunnelIfEncapsMethod	1.3.6.1.2.1.10.131.1.1.1.1.3
tunnelIfTOS	1.3.6.1.2.1.10.131.1.1.1.1.4
tunnelIfHopLimit	1.3.6.1.2.1.10.131.1.1.1.1.5
tunnelConfigLocalAddress	1.3.6.1.2.1.10.131.1.1.2.1.1
tunnelConfigRemoteAddress	1.3.6.1.2.1.10.131.1.1.2.1.2
tunnelConfigEncapsMethod	1.3.6.1.2.1.10.131.1.1.2.1.3
tunnelConfigID	1.3.6.1.2.1.10.131.1.1.2.1.4
tunnelConfigStatus	1.3.6.1.2.1.10.131.1.1.2.1.5
ipTunnelIfIndex	1.3.6.1.4.1.81.31.8.1.1.1
ipTunnelIfChecksum	1.3.6.1.4.1.81.31.8.1.1.2
ipTunnelIfKey	1.3.6.1.4.1.81.31.8.1.1.3
ipTunnelIfkeyMode	1.3.6.1.4.1.81.31.8.1.1.4
ipTunnelIfAgingTimer	1.3.6.1.4.1.81.31.8.1.1.5
ipTunnelIfMTUDiscovery	1.3.6.1.4.1.81.31.8.1.1.6
ipTunnelIfMTU	1.3.6.1.4.1.81.31.8.1.1.7
ipTunnelIfKeepaliveRate	1.3.6.1.4.1.81.31.8.1.1.8
ipTunnelIfKeepaliveRetries	1.3.6.1.4.1.81.31.8.1.1.9
<b>2 of 2</b>	

# Index

## A

Access control list  
 CLI commands . . . . . [612](#)

Access control lists, *see* Policy . . . . . [591](#)

Access Security Gateway (ASG) authentication . . . . . [55](#)

Accessing  
 Avaya Communication Manager . . . . . [53](#)  
 Avaya IW . . . . . [48](#)  
 GIW . . . . . [51](#)  
 MGC . . . . . [53](#)  
 PIM . . . . . [52](#)  
 via modem . . . . . [46](#)  
 via S8300 . . . . . [48](#)

Administrator login, configuring in IW . . . . . [49](#)

Announcement files  
 CLI commands . . . . . [350](#)  
 managing and transferring using SCP . . . . . [347](#)

ARP table  
 adding entries . . . . . [484](#)  
 CLI commands . . . . . [484](#)  
 configuration . . . . . [484](#)  
 deleting dynamic entries . . . . . [484](#)  
 description . . . . . [482](#)  
 dynamic entries . . . . . [483](#)  
 removing entries . . . . . [484](#)  
 static entries . . . . . [482](#)

ASG authentication . . . . . [55](#)

ASG commands . . . . . [60](#)

Authenticating  
 Service logins . . . . . [55](#)

Auto Fallback in SLS . . . . . [118](#)

autoneg . . . . . [198](#)

Auto-negotiation  
 Fast Ethernet port . . . . . [197](#)  
 flowcontrol advertisement . . . . . [194](#)

Autonomous System Boundary Router . . . . . [493](#)

Avaya Communication Manager  
 accessing . . . . . [53](#)  
 configuring for SLS . . . . . [133](#)  
 functions . . . . . [53](#)

Avaya IW  
 accessing . . . . . [48](#)  
 administrator login, configuring . . . . . [49](#)  
 configuration using . . . . . [48](#)  
 description . . . . . [48](#)  
 laptop configuration for . . . . . [48](#)

Avaya Services

authenticating logins with ASG . . . . . [55](#)  
 Avaya Site Administration . . . . . [53](#)  
 Avaya Voice Announcement Manager (VAM). . . . . [347](#)

## B

Backing up the gateway  
 via the gateway USB port . . . . . [106](#)

Backup interfaces  
 CLI commands . . . . . [270](#)  
 configuring . . . . . [268](#)  
 defining through policy-based routing . . . . . [620](#)  
 dynamic bandwidth reporting . . . . . [296](#)  
 GRE tunnels as . . . . . [457](#)  
 limitations . . . . . [269](#)  
 modem dial backup, *see* Modem dial backup  
 overview . . . . . [197](#)

Backup service . . . . . [325](#)

Bandwidth  
 displaying . . . . . [297](#)  
 dynamic reporting . . . . . [296](#)  
 manual adjustment . . . . . [493](#)  
 reducing via header compression . . . . . [225](#)  
 setting maximum . . . . . [297](#)  
 used to calculate Cost . . . . . [493](#)

Basic  
 LAN deployment . . . . . [31](#)

BOOTP  
 configuration . . . . . [469](#)  
 description . . . . . [467](#)

BOOTstrap Protocol  
*see* BOOTP

BPDU . . . . . [363](#)

Bridge Protocol Data Units  
*see* BPDU

Bridges  
 direct handshaking . . . . . [363](#)  
 loops . . . . . [362](#)

Broadcast address . . . . . [445](#)

Broadcast relay  
 CLI commands . . . . . [481](#)  
 description . . . . . [480](#)  
 directed broadcast forwarding . . . . . [480](#)  
 NetBIOS rebroadcast . . . . . [481](#)

## C

CAC-BL . . . . . [296](#)

## Index

- Call admission control, see Dynamic CAC
- CAM table . . . . . [354](#)
- CDR, SLS information . . . . . [130](#)
- Challenge Handshake Authentication Protocol . [240](#), [242](#)
- Channel Groups
  - creating . . . . . [251](#)
  - illustration . . . . . [246](#)
  - mapping . . . . . [250](#)
- CHAP . . . . . [240](#), [242](#)
- CIR . . . . . [316](#)
- CLI
  - accessing from local network . . . . . [45](#)
  - accessing from remote location . . . . . [46](#)
  - accessing with modem . . . . . [46](#)
  - contexts . . . . . [44](#)
  - listing files . . . . . [116](#)
  - managing configuration files . . . . . [113](#)
  - managing firmware banks . . . . . [99](#)
  - online help . . . . . [44](#)
  - remote access with S8300 Server . . . . . [48](#)
  - upgrading firmware using FTP/TFTP . . . . . [100](#)
  - using to configure the system . . . . . [39](#)
  - viewing device status . . . . . [95](#)
- CNA test plugs
  - CLI commands . . . . . [441](#)
  - configuration example . . . . . [439](#)
  - configuring for registration . . . . . [437](#)
  - functionality . . . . . [436](#)
  - overview . . . . . [436](#)
- Codec . . . . . [232](#)
- Commands
  - access-control-list . . . . . [282](#)
  - add nfas-interface . . . . . [180](#), [189](#)
  - add port . . . . . [174](#), [190](#)
  - area . . . . . [493](#), [496](#)
  - arp . . . . . [482](#), [484](#)
  - arp timeout . . . . . [484](#)
  - async mode interactive . . . . . [242](#), [243](#)
  - async mode terminal . . . . . [242](#), [243](#)
  - async modem-init-string . . . . . [239](#), [242](#), [243](#)
  - async reset-modem . . . . . [239](#), [242](#), [243](#)
  - async-limit-string . . . . . [241](#)
  - async-reset-modem . . . . . [241](#)
  - authentication . . . . . [587](#)
  - autoneg . . . . . [197](#)
  - backup config usb . . . . . [106](#), [112](#)
  - backup delay . . . . . [269](#), [270](#)
  - backup interface . . . . . [270](#), [277](#), [278](#), [283](#), [292](#)
  - bandwidth . . . . . [255](#), [256](#), [493](#), [495](#)
  - bc out . . . . . [317](#)
  - be out . . . . . [317](#)
  - bootfile . . . . . [474](#), [478](#)
  - bri . . . . . [159](#), [171](#), [184](#)
  - cable length long . . . . . [253](#)
  - cable length short . . . . . [253](#)
  - cablelength long . . . . . [249](#)
  - cablelength short . . . . . [249](#)
  - capture buffer mode . . . . . [424](#)
  - capture buffer-mode . . . . . [432](#)
  - capture buffer-size . . . . . [432](#)
  - capture filter-group . . . . . [423](#), [425](#), [432](#)
  - capture interface . . . . . [415](#), [424](#), [432](#)
  - capture ipsec . . . . . [432](#)
  - capture max-frame-size . . . . . [424](#), [432](#)
  - capture start . . . . . [425](#), [432](#)
  - capture stop . . . . . [426](#), [432](#)
  - capture-service . . . . . [415](#), [432](#)
  - channel-group . . . . . [250](#), [253](#)
  - cir out . . . . . [317](#)
  - class-identifier . . . . . [474](#), [479](#)
  - clear arp-cache . . . . . [484](#)
  - clear attendant . . . . . [185](#)
  - clear bri . . . . . [171](#), [185](#)
  - clear capture-buffer . . . . . [424](#), [432](#)
  - clear counter . . . . . [441](#)
  - clear counters . . . . . [441](#)
  - clear crypto isakmp . . . . . [528](#), [586](#)
  - clear crypto sa . . . . . [528](#), [586](#)
  - clear crypto sa counters . . . . . [528](#), [586](#)
  - clear dial-pattern . . . . . [181](#), [185](#)
  - clear ds1 . . . . . [166](#), [185](#)
  - clear dynamic-trap-manager . . . . . [339](#)
  - clear extension . . . . . [163](#), [185](#)
  - clear fac . . . . . [185](#)
  - clear fragment . . . . . [503](#)
  - clear frame-relay counters . . . . . [265](#)
  - clear incoming-routing . . . . . [185](#)
  - clear ip dhcp-client statistics . . . . . [203](#), [204](#), [205](#)
  - clear ip dhcp-server binding . . . . . [474](#), [478](#)
  - clear ip dhcp-server statistics . . . . . [474](#), [478](#)
  - clear ip domain statistics . . . . . [94](#)
  - clear ip route . . . . . [455](#), [456](#)
  - clear ip rtp header-compression . . . . . [228](#), [231](#)
  - clear ip tcp header-compression . . . . . [228](#), [231](#)
  - clear logging file . . . . . [213](#), [222](#)
  - clear logging server . . . . . [211](#)
  - clear mgc list . . . . . [86](#), [88](#)
  - clear port mirror . . . . . [361](#), [362](#)
  - clear port static-vlan . . . . . [354](#), [357](#)
  - clear radius authentication server . . . . . [66](#)
  - clear rmon statistics . . . . . [372](#), [374](#)
  - clear sig-group . . . . . [180](#), [185](#)
  - clear slot-config . . . . . [185](#)
  - clear ssh-client known-hosts . . . . . [64](#)
  - clear station . . . . . [185](#)
  - clear survivable-config . . . . . [185](#)
  - clear sync interface . . . . . [638](#), [639](#)
  - clear tac . . . . . [190](#)
  - clear tcp syn-cookies counters . . . . . [71](#)
  - clear trunk-group . . . . . [173](#), [185](#)



- clear vlan . . . . . [353](#), [354](#), [357](#)
- client identifier . . . . . [472](#)
- client identifiers . . . . . [478](#)
- clock source . . . . . [249](#), [253](#)
- cna-testplug . . . . . [437](#), [441](#)
- cna-testplug-service . . . . . [438](#), [441](#)
- composite-operation
  - access control list . . . . . [613](#)
  - DSCP table . . . . . [609](#), [616](#)
  - IP rule configuration . . . . . [607](#)
  - MSS configuration . . . . . [75](#), [78](#)
  - packet sniffing . . . . . [433](#)
  - QoS list . . . . . [607](#), [615](#), [616](#)
- continuous-channel . . . . . [517](#), [520](#), [539](#), [587](#), [588](#)
- controller . . . . . [249](#), [253](#)
- control-port . . . . . [438](#), [441](#)
- cookie
  - access control list . . . . . [612](#)
  - capture list . . . . . [416](#), [433](#)
  - policy based routing . . . . . [633](#)
  - policy list . . . . . [595](#)
  - QoS list . . . . . [616](#)
- copy announcement-file ftp . . . . . [104](#), [347](#), [350](#)
- copy announcement-file scp . . . . . [104](#), [347](#), [350](#)
- copy announcement-file usb . . . . . [102](#), [104](#), [348](#), [350](#)
- copy auth-file ftp . . . . . [57](#), [60](#), [104](#)
- copy auth-file scp . . . . . [57](#), [60](#), [104](#)
- copy auth-file tftp . . . . . [57](#), [60](#)
- copy auth-file usb . . . . . [57](#), [60](#), [102](#), [104](#)
- copy capture-file ftp . . . . . [104](#), [428](#), [432](#)
- copy capture-file scp . . . . . [104](#), [428](#), [432](#)
- copy capture-file tftp . . . . . [428](#), [433](#)
- copy capture-file usb . . . . . [102](#), [104](#), [428](#), [433](#)
- copy cdr-file ftp . . . . . [104](#)
- copy cdr-file scp . . . . . [104](#)
- copy cdr-file usb . . . . . [102](#), [104](#)
- copy dhcp-binding ftp . . . . . [104](#)
- copy dhcp-binding scp . . . . . [104](#)
- copy dhcp-binding usb . . . . . [102](#), [104](#)
- copy file usb . . . . . [102](#)
- copy ftp announcement-file . . . . . [348](#), [350](#)
- copy ftp auth-file . . . . . [57](#), [60](#)
- copy ftp EW\_archive . . . . . [100](#), [104](#)
- copy ftp license-file . . . . . [510](#)
- copy ftp module . . . . . [100](#), [104](#)
- copy ftp startup-config . . . . . [114](#), [115](#)
- copy ftp SW\_imageA . . . . . [100](#), [104](#)
- copy ftp sw\_imageA . . . . . [108](#), [112](#)
- copy ftp SW\_imageB . . . . . [104](#)
- copy ftp sw\_imageB . . . . . [100](#)
- copy license-file usb . . . . . [102](#), [104](#)
- copy phone-script usb . . . . . [102](#), [104](#)
- copy running-config ftp . . . . . [114](#), [115](#)
- copy running-config scp . . . . . [114](#), [115](#)
- copy running-config startup-config . . . . . [69](#), [70](#)
- copy running-config tftp . . . . . [114](#), [115](#)
- copy scp announcement-file . . . . . [347](#), [350](#)
- copy scp auth-file . . . . . [57](#), [60](#)
- copy scp license-file . . . . . [510](#)
- copy scp startup-config . . . . . [114](#), [115](#)
- copy startup-config ftp . . . . . [114](#), [115](#)
- copy startup-config scp . . . . . [114](#), [115](#)
- copy startup-config tftp . . . . . [114](#), [115](#)
- copy startup-config usb . . . . . [102](#), [104](#), [114](#), [115](#)
- copy syslog-file usb . . . . . [102](#), [104](#)
- copy tftp auth-file . . . . . [57](#), [60](#)
- copy tftp EW\_archive . . . . . [100](#), [104](#)
- copy tftp license-file . . . . . [510](#)
- copy tftp module . . . . . [104](#)
- copy tftp startup-config . . . . . [114](#), [115](#)
- copy tftp SW\_imageA . . . . . [100](#), [104](#)
- copy tftp sw\_imageA . . . . . [108](#), [112](#)
- copy tftp SW\_imageB . . . . . [100](#), [104](#)
- copy usb . . . . . [101](#)
- copy usb announcement-file . . . . . [104](#), [348](#), [350](#)
- copy usb auth-file . . . . . [57](#), [60](#), [104](#)
- copy usb EW\_archive . . . . . [104](#)
- copy usb license-file . . . . . [104](#)
- copy usb modules . . . . . [104](#)
- copy usb phone-image . . . . . [104](#)
- copy usb phone-script . . . . . [104](#)
- copy usb startup-config . . . . . [105](#), [114](#), [115](#)
- copy usb SW\_image . . . . . [105](#)
- cos . . . . . [607](#), [615](#)
- crypto ipsec df-bit . . . . . [526](#), [589](#)
- crypto ipsec minimal pmtu . . . . . [526](#)
- crypto ipsec minimal-pmtu . . . . . [589](#)
- crypto ipsec nat-transparency udp-encapsulation . . . . . [525](#)
- crypto ipsec transform-set . . . . . [513](#), [568](#), [576](#)
- crypto isakmp invalid-spi-recovery . . . . . [524](#), [586](#)
- crypto isakmp nat keepalive . . . . . [525](#), [586](#)
- crypto isakmp peer . . . . . [514](#), [568](#), [576](#), [586](#)
- crypto isakmp peer-group . . . . . [518](#), [576](#), [587](#)
- crypto isakmp policy . . . . . [568](#), [576](#), [587](#)
- crypto isakmp suggest-key . . . . . [588](#)
- crypto ispec nat-transparency udp-encapsulation . . . . . [586](#)
- crypto ispec transform-set . . . . . [586](#)
- crypto key generate . . . . . [62](#), [63](#)
- crypto map . . . . . [519](#), [568](#), [576](#), [588](#)
- crypto-group . . . . . [526](#)
- crypto isakmp policy . . . . . [512](#)
- default-metric . . . . . [489](#), [491](#), [493](#), [496](#), [497](#), [498](#)
- default-router . . . . . [473](#)
- default-routers . . . . . [478](#)
- description
  - crypto list rule . . . . . [521](#), [589](#)
  - crypto map . . . . . [519](#), [588](#)
  - DNS servers list . . . . . [90](#), [95](#)
  - ISAKMP peer . . . . . [515](#), [587](#)
  - ISAKMP peer-group . . . . . [518](#), [587](#)
  - ISAKMP policy . . . . . [512](#), [588](#)
  - object tracker . . . . . [302](#), [315](#)

## Index

- policy rule . . . . . [600](#)
- track list . . . . . [303](#)
- destination-ip
  - access control list . . . . . [613](#)
  - crypto list rule . . . . . [521](#), [589](#)
  - MSS configuration . . . . . [75](#), [78](#)
  - packet sniffing . . . . . [418](#), [433](#)
  - policy based routing . . . . . [634](#)
  - policy list . . . . . [601](#)
  - QoS list . . . . . [616](#)
- dialer modem-interface . . . . . [283](#), [291](#)
- dialer order . . . . . [275](#), [291](#)
- dialer persistent . . . . . [275](#), [291](#)
- dialer persistent delay . . . . . [275](#), [282](#), [291](#)
- dialer persistent initial delay . . . . . [275](#), [282](#), [291](#)
- dialer persistent max-attempts . . . . . [275](#), [291](#)
- dialer persistent re-enable . . . . . [275](#), [291](#)
- dialer string . . . . . [274](#), [283](#), [291](#)
- dialer wait-for-ipc . . . . . [276](#), [291](#)
- dial-pattern . . . . . [160](#), [181](#), [185](#)
- dir . . . . . [105](#), [112](#), [116](#)
- disconnect ssh . . . . . [62](#), [63](#)
- distribution list . . . . . [488](#)
- distribution-list . . . . . [489](#), [491](#)
- dns-server . . . . . [473](#), [478](#)
- domain-name . . . . . [473](#), [478](#)
- dos-classification . . . . . [75](#), [78](#)
- ds1 . . . . . [159](#), [186](#)
- dscp
  - access control list . . . . . [613](#)
  - object tracking . . . . . [300](#), [315](#)
  - packet sniffing . . . . . [418](#), [433](#)
  - policy based routing . . . . . [634](#)
  - policy lists . . . . . [604](#)
  - QoS list . . . . . [607](#), [615](#), [616](#)
- dscp-table . . . . . [609](#), [616](#)
- ds-mode . . . . . [249](#), [253](#)
- duplex . . . . . [197](#)
- dynamic-cac . . . . . [297](#), [298](#)
- encapsulation . . . . . [257](#), [258](#), [263](#), [265](#)
- encapsulation pppoe . . . . . [259](#), [262](#)
- encryption . . . . . [512](#), [588](#)
- end-ip-addr . . . . . [472](#), [479](#)
- erase announcement-file . . . . . [348](#), [350](#)
- erase auth-file . . . . . [56](#), [60](#)
- exit . . . . . [80](#)
- fail-retries . . . . . [301](#), [315](#)
- fair-queue-limit . . . . . [234](#), [235](#)
- fair-voip-queue . . . . . [234](#), [235](#)
- fdl . . . . . [253](#)
- fragment
  - access control list . . . . . [604](#), [613](#)
  - fragmentation . . . . . [503](#)
  - frame relay . . . . . [317](#), [318](#)
  - packet sniffing . . . . . [421](#), [433](#)
  - policy based routing . . . . . [634](#)
  - QoS list . . . . . [616](#)
- fragment chain . . . . . [503](#)
- fragment size . . . . . [503](#)
- fragment timeout . . . . . [503](#)
- frame-relay class-dlci . . . . . [265](#)
- frame-relay interface-dlci . . . . . [264](#), [265](#)
- frame-relay lmi-n391dte . . . . . [263](#), [265](#)
- frame-relay lmi-n392dte . . . . . [263](#), [265](#)
- frame-relay lmi-n393dte . . . . . [263](#), [266](#)
- frame-relay lmi-type . . . . . [263](#), [266](#)
- frame-relay priority-dlci-group . . . . . [264](#), [266](#), [318](#)
- frame-relay traffic-shaping . . . . . [263](#), [266](#), [316](#), [317](#)
- framing . . . . . [249](#), [253](#)
- frequency . . . . . [300](#), [315](#)
- group . . . . . [512](#), [588](#)
- hash . . . . . [512](#), [588](#)
- help . . . . . [44](#)
- hostname . . . . . [62](#), [63](#)
- icc-vlan . . . . . [353](#), [357](#)
- icmp . . . . . [421](#), [433](#), [603](#), [613](#), [616](#), [634](#)
- idle character . . . . . [254](#)
- idle-character . . . . . [256](#)
- ignore dcd . . . . . [255](#), [256](#)
- incoming-routing . . . . . [160](#), [182](#), [187](#)
- initiate mode . . . . . [516](#), [587](#)
- interface . . . . . [79](#), [80](#), [292](#)
- interface console . . . . . [242](#), [243](#), [283](#), [446](#)
- interface dialer . . . . . [274](#), [282](#), [291](#), [446](#)
- interface fastethernet
  - DHCP and BOOTP relay . . . . . [469](#)
  - DHCP client . . . . . [200](#), [204](#)
  - interface configuration . . . . . [447](#)
  - PPPoE . . . . . [259](#)
  - WAN Ethernet port . . . . . [196](#), [198](#)
- interface Loopback . . . . . [282](#)
- interface loopback . . . . . [447](#)
- interface Serial . . . . . [250](#)
- interface serial
  - E1/T1 ports . . . . . [253](#)
  - frame relay . . . . . [263](#), [264](#), [265](#)
  - frame relay traffic shaping . . . . . [317](#)
  - interface configuration . . . . . [447](#)
  - PPP . . . . . [257](#), [258](#)
  - USP port . . . . . [254](#), [256](#)
- interface tunnel . . . . . [447](#), [462](#), [466](#)
- interface usb-modem . . . . . [239](#), [241](#), [448](#)
- interface vlan . . . . . [351](#), [354](#), [357](#), [448](#)
- invert txclock . . . . . [255](#), [256](#)
- ip access group . . . . . [597](#)
- ip access-control-list . . . . . [75](#), [78](#), [524](#), [594](#), [612](#)
- ip access-group . . . . . [283](#), [537](#), [612](#)
- ip address
  - console port . . . . . [242](#), [243](#)
  - dialer interface . . . . . [274](#), [291](#)

- E1/T1 ports . . . . . [251](#), [254](#)
- frame relay . . . . . [264](#), [266](#)
- interface configuration . . . . . [79](#), [445](#)
- PPP . . . . . [257](#), [258](#)
- PPPoE . . . . . [260](#), [262](#)
- USB port . . . . . [239](#), [241](#)
- USP port . . . . . [256](#)
- ip address dhcp . . . . . [92](#), [201](#), [204](#)
- ip address negotiated . . . . . [260](#), [262](#), [274](#), [291](#), [537](#)
- ip admin-state . . . . . [445](#), [447](#), [448](#)
- ip bootp-dhcp network . . . . . [469](#)
- ip bootp-dhcp relay . . . . . [469](#)
- ip bootp-dhcp server . . . . . [469](#)
- ip broadcast-address . . . . . [445](#), [447](#), [448](#)
- ip capture-list . . . . . [416](#), [433](#)
- ip crypto list . . . . . [520](#)
- ip crypto-group . . . . . [523](#), [539](#), [589](#)
- ip crypto-list . . . . . [589](#)
- ip default-gateway . . . . . [82](#), [292](#), [455](#), [456](#)
- ip default-gateway dialer . . . . . [277](#)
- ip dhcp activate pool . . . . . [472](#), [478](#)
- ip dhcp client client-id . . . . . [200](#), [204](#)
- ip dhcp client hostname . . . . . [200](#), [204](#)
- ip dhcp client lease . . . . . [200](#), [204](#)
- ip dhcp client request . . . . . [200](#), [204](#), [568](#)
- ip dhcp client route track . . . . . [201](#), [204](#)
- ip dhcp ping packets . . . . . [474](#), [478](#)
- ip dhcp ping timeout . . . . . [474](#), [478](#)
- ip dhcp pool . . . . . [472](#)
- ip dhcp pools . . . . . [478](#)
- ip dhcp-server . . . . . [472](#), [480](#)
- ip directed-broadcast . . . . . [480](#), [481](#)
- ip distribution access-default-action . . . . . [488](#), [490](#)
- ip distribution access-list . . . . . [488](#), [490](#)
- ip distribution access-list-cookie . . . . . [490](#)
- ip distribution access-list-copy . . . . . [490](#)
- ip distribution access-list-name . . . . . [490](#)
- ip distribution access-list-owner . . . . . [490](#)
- ip domain list . . . . . [91](#), [95](#)
- ip domain lookup . . . . . [91](#), [95](#)
- ip domain name-server-list . . . . . [90](#), [95](#)
- ip domain retry . . . . . [91](#), [95](#)
- ip domain timeout . . . . . [95](#)
- ip icmp-errors . . . . . [486](#)
- ip max-arp-entries . . . . . [484](#)
- ip netbios-rebroadcast . . . . . [481](#)
- ip netmask-format . . . . . [455](#), [456](#)
- ip next-hop-list . . . . . [622](#), [626](#), [633](#)
- ip ospf authentication . . . . . [493](#), [495](#)
- ip ospf authentication-key . . . . . [493](#), [495](#)
- ip ospf cost . . . . . [493](#), [494](#), [495](#)
- ip ospf dead-interval . . . . . [494](#), [495](#)
- ip ospf hello-interval . . . . . [494](#), [495](#)
- ip ospf message-digest-key . . . . . [494](#), [495](#)
- ip ospf network point-to-multipoint . . . . . [248](#), [494](#), [495](#)
- ip ospf priority . . . . . [494](#), [495](#)
- ip ospf router-id . . . . . [494](#), [496](#)
- ip pbr-group . . . . . [623](#), [633](#)
- ip pbr-list . . . . . [621](#), [627](#), [633](#)
- IP peer address . . . . . [240](#), [243](#)
- ip peer address . . . . . [241](#), [243](#)
- ip policy-list-copy . . . . . [523](#), [595](#), [614](#), [615](#)
- ip proxy-arp . . . . . [485](#)
- ip qos-group . . . . . [597](#), [615](#)
- ip qos-list . . . . . [594](#), [615](#)
- ip redirects . . . . . [455](#), [456](#)
- ip rip authentication key . . . . . [489](#)
- ip rip authentication mode . . . . . [489](#)
- ip rip authentications key . . . . . [491](#)
- ip rip authentications mode . . . . . [491](#)
- ip rip default-route-mode . . . . . [489](#), [491](#)
- ip rip poison-reverse . . . . . [488](#), [489](#), [491](#)
- ip rip rip-version . . . . . [489](#), [491](#)
- ip rip send-receive-mode . . . . . [489](#), [491](#)
- ip rip split-horizon . . . . . [487](#), [489](#), [491](#)
- ip route . . . . . [452](#), [453](#), [454](#), [455](#), [456](#)
- ip routing . . . . . [443](#), [456](#)
- ip rtp compression-connections . . . . . [227](#), [229](#)
- ip rtp header-compression . . . . . [228](#), [229](#), [230](#)
- ip rtp max-period . . . . . [227](#), [229](#)
- ip rtp max-time . . . . . [227](#), [229](#)
- ip rtp non-tcp-mode . . . . . [227](#), [229](#)
- ip rtp port-range . . . . . [227](#), [229](#)
- ip rule . . . . . [600](#)
- ip show rule . . . . . [600](#)
- ip simulate . . . . . [611](#), [612](#), [615](#)
- ip snmp . . . . . [336](#)
- ip ssh . . . . . [62](#), [63](#)
- ip tcp compression-connections . . . . . [227](#), [229](#), [230](#), [231](#)
- ip tcp header-compression . . . . . [228](#), [230](#), [231](#)
- ip telnet . . . . . [67](#), [68](#)
- ip telnet-client . . . . . [67](#), [68](#)
- ip telnet-services . . . . . [68](#)
- ip unnumbered . . . . . [274](#), [283](#), [449](#)
- ip vrrp . . . . . [500](#), [501](#)
- ip vrrp address . . . . . [500](#), [501](#)
- ip vrrp auth-key . . . . . [500](#), [501](#)
- ip vrrp override addr owner . . . . . [500](#), [501](#)
- ip vrrp preempt . . . . . [500](#), [501](#)
- ip vrrp primary . . . . . [501](#), [502](#)
- ip vrrp priority . . . . . [501](#), [502](#)
- ip vrrp timer . . . . . [501](#), [502](#)
- ip-fragments-in . . . . . [599](#), [613](#)
- ip-option-in . . . . . [599](#), [613](#)
- ip-protocol
  - access control list . . . . . [613](#)
  - MSS configuration . . . . . [75](#), [78](#)
  - packet sniffing . . . . . [418](#), [433](#)
  - policy based routing . . . . . [634](#)
  - policy list . . . . . [601](#)

## Index

- QoS list . . . . . [616](#)
- ip-rule
  - access control list . . . . . [613](#)
  - crypto list . . . . . [521](#)
  - MSS configuration . . . . . [75](#), [78](#)
  - packet sniffing . . . . . [416](#), [433](#)
  - policy based routing . . . . . [621](#), [625](#), [633](#)
  - QoS list . . . . . [616](#)
  - VPN . . . . . [589](#)
- isakmp policy . . . . . [515](#)
- isakmp-policy . . . . . [587](#)
- keepalive . . . . . [257](#), [258](#), [460](#), [462](#), [466](#), [517](#), [587](#)
- keepalive-icmp . . . . . [294](#), [295](#)
- keepalive-icmp failure-retries . . . . . [294](#), [295](#)
- keepalive-icmp interval . . . . . [294](#), [295](#)
- keepalive-icmp source-address . . . . . [294](#), [295](#)
- keepalive-icmp success-retries . . . . . [294](#), [295](#)
- keepalive-icmp timeout . . . . . [294](#), [296](#)
- keepalive-track . . . . . [197](#), [261](#), [262](#), [517](#), [587](#)
- key config-key password-encryption . . . . . [69](#), [111](#), [112](#)
- lease . . . . . [472](#), [473](#), [479](#)
- lifetime . . . . . [512](#), [588](#)
- linecode . . . . . [249](#), [253](#)
- load-interval . . . . . [79](#), [243](#)
- local-address . . . . . [521](#), [589](#)
- login authentication . . . . . [58](#)
- login authentication local-craft-password . . . . . [58](#), [60](#)
- login authentication lockout . . . . . [58](#), [60](#)
- login authentication response-time . . . . . [58](#), [60](#)
- login authentication services-logins . . . . . [61](#)
- loopback . . . . . [252](#), [253](#)
- loopback remote . . . . . [253](#)
- map-class frame-relay . . . . . [317](#)
- mode . . . . . [514](#), [586](#)
- mtu . . . . . [260](#), [262](#)
- name
  - access control list . . . . . [614](#)
  - crypto list . . . . . [521](#)
  - DHCP option . . . . . [473](#), [479](#)
  - DHCP server . . . . . [472](#), [479](#)
  - DHCP vendor specific option . . . . . [474](#), [479](#)
  - packet sniffing . . . . . [416](#), [434](#)
  - policy based routing . . . . . [621](#), [622](#), [634](#)
  - policy list . . . . . [595](#)
  - QoS list . . . . . [607](#), [615](#), [616](#), [617](#)
- name server . . . . . [90](#)
- name-server . . . . . [95](#)
- network . . . . . [490](#), [494](#), [496](#)
- next-hop . . . . . [300](#), [315](#), [625](#)
- next-hop (policy-based routing) . . . . . [634](#)
- next-hop-interface . . . . . [622](#), [626](#), [633](#)
- next-hop-ip . . . . . [626](#), [633](#)
- next-hop-list . . . . . [622](#)
- next-server . . . . . [474](#), [479](#)
- nrzi-encoding . . . . . [255](#), [256](#)
- nslookup . . . . . [93](#), [95](#)
- object . . . . . [303](#), [315](#)
- option . . . . . [473](#), [479](#)
- owner
  - access control list . . . . . [614](#)
  - packet sniffing . . . . . [416](#), [434](#)
  - policy based routing . . . . . [621](#), [634](#)
  - policy list . . . . . [595](#)
  - QoS list . . . . . [617](#)
- passive-interface . . . . . [494](#)
- passive-interfaces . . . . . [496](#)
- ping . . . . . [267](#)
- pmi . . . . . [80](#), [81](#)
- ppp authentication
  - ASG authentication . . . . . [58](#), [61](#)
  - console port . . . . . [242](#), [244](#)
  - USB port . . . . . [240](#), [241](#)
- ppp chap hostname . . . . . [260](#), [262](#), [276](#), [282](#)
- ppp chap password . . . . . [260](#), [262](#), [276](#)
- ppp chap refuse . . . . . [260](#), [262](#)
- ppp chap-secret . . . . . [240](#), [241](#), [242](#), [244](#)
- ppp ipcp dns request . . . . . [92](#), [95](#), [261](#), [262](#), [292](#), [568](#)
- ppp pap refuse . . . . . [261](#), [262](#)
- ppp pap sent username . . . . . [262](#)
- ppp pap sent-username . . . . . [276](#)
- ppp pap-sent username . . . . . [260](#)
- ppp time authentication . . . . . [241](#), [244](#)
- ppp timeout authentication . . . . . [240](#), [243](#)
- ppp timeout ncp . . . . . [257](#), [258](#)
- ppp timeout retry . . . . . [257](#), [258](#)
- pppoe-client persistent delay . . . . . [260](#), [262](#)
- pppoe-client persistent max-attempts . . . . . [260](#), [263](#)
- pppoe-client service-name . . . . . [260](#), [263](#)
- pppoe-client wait-for-ipcp . . . . . [260](#), [263](#)
- pre-shared-key . . . . . [515](#), [587](#)
- priority-queue . . . . . [234](#), [235](#), [236](#), [237](#)
- protect crypto-map . . . . . [522](#), [589](#)
- queue-limit . . . . . [236](#), [237](#)
- redistribute . . . . . [490](#), [491](#), [494](#), [496](#), [497](#), [498](#)
- release dhcp . . . . . [202](#), [204](#)
- remove nfas-interface . . . . . [189](#)
- remove port . . . . . [190](#)
- rename announcement-file . . . . . [348](#), [350](#)
- renew dhcp . . . . . [202](#), [204](#)
- reset . . . . . [80](#)
- restore . . . . . [111](#), [112](#)
- restore usb . . . . . [102](#), [108](#), [113](#)
- rmon alarm . . . . . [372](#), [374](#)
- rmon event . . . . . [372](#), [374](#)
- rmon history . . . . . [372](#), [374](#)
- router ospf . . . . . [283](#), [292](#), [494](#), [496](#), [498](#)
- router rip . . . . . [490](#), [491](#), [498](#)
- router vrrp . . . . . [501](#), [502](#)
- rtp-echo-port . . . . . [438](#), [441](#)
- rtp-stat clear . . . . . [379](#), [412](#)
- rtp-stat event-threshold . . . . . [379](#), [412](#)
- rtp-stat fault . . . . . [383](#), [412](#)

- rtp-stat min-stat-win . . . . . [382](#), [412](#)
- rtp-stat qos-trap . . . . . [383](#), [412](#)
- rtp-stat qos-trap-rate-limit . . . . . [384](#), [413](#)
- rtp-stat service . . . . . [413](#)
- rtp-stat thresholds . . . . . [379](#), [413](#)
- rtp-stat-service . . . . . [379](#)
- rtp-test-port. . . . . [438](#), [441](#)
- rtr . . . . . [300](#), [314](#)
- rtr-schedule . . . . . [302](#), [315](#)
- running-config startup-config . . . . . [40](#)
- safe-removal usb . . . . . [113](#)
- scheduler . . . . . [437](#), [441](#)
- self-identity . . . . . [516](#), [587](#)
- server-name . . . . . [474](#), [479](#)
- session . . . . . [87](#), [88](#)
- session mgc . . . . . [428](#)
- set associated-signaling. . . . . [180](#), [189](#)
- set attendant . . . . . [161](#), [187](#)
- set bearer-capability (bri) . . . . . [171](#), [184](#)
- set bearer-capability (ds1). . . . . [169](#), [186](#)
- set bit-rate . . . . . [166](#), [186](#)
- set boot bank. . . . . [99](#), [105](#)
- set cbc. . . . . [190](#)
- set cbc-parameter . . . . . [190](#)
- set cbc-service-feature . . . . . [190](#)
- set channel-numbering . . . . . [186](#)
- set channel-preferences. . . . . [177](#), [190](#)
- set codeset-display . . . . . [177](#), [190](#)
- set codeset-national . . . . . [177](#), [190](#)
- set connect. . . . . [167](#), [186](#)
- set contact-closure admin . . . . . [344](#), [345](#)
- set contact-closure pulse-duration . . . . . [344](#), [345](#)
- set cor . . . . . [189](#)
- set country-protocol (bri) . . . . . [171](#), [184](#)
- set country-protocol (ds1) . . . . . [167](#), [168](#), [186](#)
- set date-format . . . . . [160](#), [161](#), [187](#)
- set delete-digits (dial-pattern) . . . . . [182](#), [186](#)
- set delete-digits (incoming-routing). . . . . [183](#), [187](#)
- set deny . . . . . [182](#), [186](#)
- set dial . . . . . [174](#), [190](#)
- set digit-handling . . . . . [178](#), [190](#)
- set digits . . . . . [177](#), [191](#)
- set digit-treatment . . . . . [177](#), [191](#)
- set directory-number-a . . . . . [172](#), [184](#)
- set directory-number-b . . . . . [172](#), [184](#)
- set dscp . . . . . [520](#), [588](#)
- set endpoint-init . . . . . [172](#), [184](#)
- set etr . . . . . [325](#), [326](#)
- set expansion-module. . . . . [165](#), [189](#)
- set fac . . . . . [187](#)
- set icc-monitoring. . . . . [87](#), [88](#)
- set incoming-destination . . . . . [179](#), [191](#)
- set incoming-dialtone . . . . . [179](#), [191](#)
- set insert-digits (dial-pattern) . . . . . [182](#), [186](#)
- set insert-digits (incoming-routing) . . . . . [183](#), [187](#)
- set interface (bri) . . . . . [171](#), [184](#)
- set interface (ds1) . . . . . [167](#), [186](#)
- set interface-companding (bri) . . . . . [171](#), [184](#)
- set interface-companding (ds1). . . . . [170](#), [186](#)
- set ip-codec-set . . . . . [160](#), [187](#)
- set japan-disconnect. . . . . [178](#), [191](#)
- set layer 1-stable . . . . . [172](#), [184](#)
- set length . . . . . [183](#), [187](#)
- set lldp re-init-delay . . . . . [207](#), [208](#)
- set lldp system-control . . . . . [206](#), [208](#)
- set lldp tx-delay . . . . . [207](#), [208](#)
- set lldp tx-hold-multiplier . . . . . [207](#), [208](#)
- set lldp tx-interval . . . . . [207](#), [208](#)
- set logging file. . . . . [217](#), [222](#)
- set logging file condition . . . . . [217](#)
- set logging file disable . . . . . [213](#)
- set logging file enable . . . . . [213](#)
- set logging server . . . . . [210](#), [222](#), [223](#)
- set logging server access level . . . . . [223](#)
- set logging server access-level . . . . . [211](#)
- set logging server condition . . . . . [217](#), [223](#)
- set logging server disable . . . . . [211](#)
- set logging server enable . . . . . [210](#)
- set logging server facility. . . . . [210](#), [223](#)
- set logging session . . . . . [223](#)
- dialer interface . . . . . [284](#), [292](#)
- DNS resolver . . . . . [94](#)
- object tracking . . . . . [305](#)
- session log . . . . . [215](#)
- VPN. . . . . [528](#)
- set logging session condition . . . . . [217](#)
- set logging session condition dhcpc . . . . . [203](#)
- set logging session disable. . . . . [215](#)
- set logging session enable . . . . . [203](#)
- set long-timer . . . . . [170](#), [186](#)
- set match-pattern . . . . . [183](#), [187](#)
- set max-ip-registrations . . . . . [160](#), [188](#)
- set max-length . . . . . [182](#), [186](#)
- set mediaserver . . . . . [87](#), [88](#)
- set mgc list . . . . . [84](#), [86](#), [88](#)
- set min-length . . . . . [182](#), [186](#)
- set mss-notification rate . . . . . [73](#), [78](#)
- set name (bri) . . . . . [171](#), [184](#)
- set name (ds1) . . . . . [166](#), [187](#)
- set name (station) . . . . . [165](#), [189](#)
- set name (trunk-group) . . . . . [177](#), [191](#)
- set numbering-format . . . . . [178](#), [191](#)
- set password . . . . . [165](#), [189](#)
- set peer. . . . . [518](#), [519](#), [587](#), [588](#)
- set peer group . . . . . [519](#)
- set peer-group . . . . . [588](#)
- set pfs . . . . . [513](#), [586](#)
- set pim-lockout . . . . . [160](#), [162](#), [188](#)
- set port . . . . . [164](#), [189](#)
- set port auto-negotiation-flowcontrol-advertisement [194](#), [195](#)

## Index

set port classification . . . . .	<a href="#">369</a> , <a href="#">370</a>	set snmp trap enable frame-relay . . . . .	<a href="#">333</a>
set port disable . . . . .	<a href="#">194</a>	set spantree default-path-cost . . . . .	<a href="#">365</a> , <a href="#">368</a>
set port duplex . . . . .	<a href="#">194</a> , <a href="#">195</a>	set spantree enable/disable . . . . .	<a href="#">365</a> , <a href="#">368</a>
set port edge admin state . . . . .	<a href="#">194</a> , <a href="#">195</a> , <a href="#">364</a> , <a href="#">368</a>	set spantree forward-delay . . . . .	<a href="#">365</a> , <a href="#">368</a>
set port flowcontrol . . . . .	<a href="#">194</a> , <a href="#">196</a>	set spantree hello-time . . . . .	<a href="#">366</a> , <a href="#">368</a>
set port level . . . . .	<a href="#">195</a> , <a href="#">196</a>	set spantree max-age . . . . .	<a href="#">366</a> , <a href="#">368</a>
set port lldp . . . . .	<a href="#">206</a> , <a href="#">208</a>	set spantree priority . . . . .	<a href="#">366</a> , <a href="#">368</a>
set port lldp tlv . . . . .	<a href="#">207</a> , <a href="#">208</a>	set spantree tx-hold-account . . . . .	<a href="#">366</a>
set port mirror . . . . .	<a href="#">361</a> , <a href="#">362</a>	set spantree tx-hold-count . . . . .	<a href="#">368</a>
set port name . . . . .	<a href="#">195</a> , <a href="#">196</a>	set spantree version . . . . .	<a href="#">366</a> , <a href="#">368</a>
set port negotiation . . . . .	<a href="#">195</a> , <a href="#">196</a>	set spid-a . . . . .	<a href="#">172</a> , <a href="#">184</a>
set port point-to-point admin status	<a href="#">195</a> , <a href="#">196</a> , <a href="#">365</a> , <a href="#">368</a>	set spid-b . . . . .	<a href="#">172</a> , <a href="#">185</a>
set port redundancy . . . . .	<a href="#">359</a> , <a href="#">360</a>	set supervision . . . . .	<a href="#">176</a> , <a href="#">191</a>
set port redundancy enable disable . . . . .	<a href="#">359</a> , <a href="#">360</a>	set swhook-flash . . . . .	<a href="#">165</a> , <a href="#">189</a>
set port redundancy-intervals . . . . .	<a href="#">358</a> , <a href="#">359</a> , <a href="#">360</a>	set sync interface . . . . .	<a href="#">639</a>
set port spantree . . . . .	<a href="#">365</a> , <a href="#">368</a>	set sync source . . . . .	<a href="#">637</a> , <a href="#">639</a>
set port spantree cost . . . . .	<a href="#">365</a> , <a href="#">368</a>	set sync switching . . . . .	<a href="#">638</a> , <a href="#">639</a>
set port spantree force-protocol-migration . . . . .	<a href="#">365</a> , <a href="#">368</a>	set system contact . . . . .	<a href="#">81</a>
set port spantree priority . . . . .	<a href="#">365</a> , <a href="#">368</a>	set system location . . . . .	<a href="#">81</a>
set port speed . . . . .	<a href="#">196</a>	set system name . . . . .	<a href="#">81</a>
set port static-vlan . . . . .	<a href="#">354</a> , <a href="#">357</a>	set tac . . . . .	<a href="#">174</a> , <a href="#">191</a>
set port trap . . . . .	<a href="#">333</a> , <a href="#">335</a>	set tei-assignment . . . . .	<a href="#">171</a> , <a href="#">185</a>
set port vlan . . . . .	<a href="#">354</a> , <a href="#">357</a>	set terminal recovery password . . . . .	<a href="#">67</a>
set port vlan-binding-mode . . . . .	<a href="#">354</a> , <a href="#">357</a>	set tgnum . . . . .	<a href="#">182</a> , <a href="#">186</a>
set primary-dchannel . . . . .	<a href="#">180</a> , <a href="#">189</a>	set transform-set . . . . .	<a href="#">519</a> , <a href="#">588</a>
set protocol-version . . . . .	<a href="#">168</a> , <a href="#">187</a>	set trunk . . . . .	<a href="#">354</a> , <a href="#">357</a>
set qos bearer . . . . .	<a href="#">232</a> , <a href="#">233</a>	set trunk-destination . . . . .	<a href="#">165</a> , <a href="#">189</a>
set qos control . . . . .	<a href="#">232</a> , <a href="#">233</a>	set trunk-group-chan-select . . . . .	<a href="#">180</a> , <a href="#">189</a>
set qos rsvp . . . . .	<a href="#">233</a>	set trunk-hunt . . . . .	<a href="#">179</a> , <a href="#">191</a>
set qos tcp . . . . .	<a href="#">232</a> , <a href="#">233</a>	set type (dial-pattern) . . . . .	<a href="#">181</a> , <a href="#">186</a>
set qos signal . . . . .	<a href="#">232</a> , <a href="#">233</a>	set type (station) . . . . .	<a href="#">163</a> , <a href="#">190</a>
set radius authentication . . . . .	<a href="#">64</a> , <a href="#">65</a> , <a href="#">66</a>	set utilization cpu . . . . .	<a href="#">96</a> , <a href="#">97</a>
set radius authentication retry-number . . . . .	<a href="#">65</a> , <a href="#">66</a>	set vlan . . . . .	<a href="#">351</a> , <a href="#">354</a> , <a href="#">357</a>
set radius authentication retry-time . . . . .	<a href="#">65</a> , <a href="#">66</a>	setting buffer-size . . . . .	<a href="#">424</a>
set radius authentication secret . . . . .	<a href="#">64</a> , <a href="#">66</a>	show (bri) . . . . .	<a href="#">172</a> , <a href="#">185</a>
set radius authentication server . . . . .	<a href="#">65</a> , <a href="#">66</a>	show (dial-pattern) . . . . .	<a href="#">182</a> , <a href="#">186</a>
set radius authentication udp-port . . . . .	<a href="#">65</a> , <a href="#">66</a>	show (ds1) . . . . .	<a href="#">170</a> , <a href="#">187</a>
set reset-times . . . . .	<a href="#">86</a> , <a href="#">88</a>	show (incoming-routing) . . . . .	<a href="#">183</a> , <a href="#">187</a>
set security-association lifetime . . . . .	<a href="#">586</a>	show (sig-group) . . . . .	<a href="#">181</a> , <a href="#">189</a>
set security-association lifetime kilobytes . . . . .	<a href="#">513</a>	show (station) . . . . .	<a href="#">166</a> , <a href="#">190</a>
set security-association lifetime seconds . . . . .	<a href="#">513</a>	show (trunk-group) . . . . .	<a href="#">179</a> , <a href="#">191</a>
set send-name . . . . .	<a href="#">178</a> , <a href="#">191</a>	show announcement-file . . . . .	<a href="#">350</a>
set send-number . . . . .	<a href="#">178</a> , <a href="#">191</a>	show announcements-files . . . . .	<a href="#">348</a>
set side (bri) . . . . .	<a href="#">171</a> , <a href="#">184</a>	show attendant . . . . .	<a href="#">188</a>
set side (ds1) . . . . .	<a href="#">167</a> , <a href="#">187</a>	show auth-file info . . . . .	<a href="#">56</a> , <a href="#">59</a> , <a href="#">61</a>
set signaling-mode . . . . .	<a href="#">166</a> , <a href="#">187</a>	show auth-file status . . . . .	<a href="#">61</a>
set slot-config . . . . .	<a href="#">160</a> , <a href="#">188</a>	show backup status . . . . .	<a href="#">113</a>
set sls . . . . .	<a href="#">143</a> , <a href="#">162</a> , <a href="#">184</a>	show boot bank . . . . .	<a href="#">99</a> , <a href="#">105</a>
set snmp community . . . . .	<a href="#">336</a> , <a href="#">337</a>	show bri . . . . .	<a href="#">188</a>
set snmp retries . . . . .	<a href="#">336</a> , <a href="#">337</a>	show cam vlan . . . . .	<a href="#">354</a> , <a href="#">357</a>
set snmp timeout . . . . .	<a href="#">336</a> , <a href="#">337</a>	show capture . . . . .	<a href="#">426</a> , <a href="#">434</a>
set snmp trap . . . . .	<a href="#">335</a>	show capture-buffer hex . . . . .	<a href="#">426</a> , <a href="#">434</a>
set snmp trap disable auth . . . . .	<a href="#">333</a>	show capture-dummy-headers . . . . .	<a href="#">430</a>
set snmp trap disable frame-relay . . . . .	<a href="#">333</a>	show cna testplug . . . . .	<a href="#">438</a> , <a href="#">441</a>
set snmp trap enable auth . . . . .	<a href="#">333</a>	show composite-operation . . . . .	

- access control list . . . . . [599](#), [613](#), [614](#)
- policy list . . . . . [610](#)
- QoS list . . . . . [616](#), [617](#)
- show contact-closure . . . . . [345](#)
- show controller . . . . . [267](#)
- show controllers . . . . . [249](#), [254](#), [266](#)
- show controllers remote . . . . . [254](#)
- show crypto ipsec sa . . . . . [524](#), [589](#)
- show crypto ipsec transform-set . . . . . [527](#), [589](#)
- show crypto isakmp peer . . . . . [527](#), [589](#)
- show crypto isakmp peer-group . . . . . [527](#), [590](#)
- show crypto isakmp policy . . . . . [527](#), [590](#)
- show crypto isakmp sa . . . . . [527](#), [590](#)
- show crypto ispssec sa . . . . . [527](#)
- show crypto map . . . . . [527](#), [590](#)
- show date-format . . . . . [188](#)
- show dial-pattern . . . . . [188](#)
- show download announcement-file status . . . . . [349](#), [350](#)
- show download license-file status . . . . . [510](#)
- show download software status . . . . . [102](#), [105](#)
- show download status . . . . . [114](#), [115](#)
- show ds1 . . . . . [188](#)
- show dscp-table . . . . . [610](#), [616](#), [617](#)
- show ds-mode . . . . . [249](#)
- show dynamic-cac . . . . . [297](#), [298](#)
- show etr . . . . . [326](#)
- show extension . . . . . [188](#)
- show fac . . . . . [188](#)
- show faults . . . . . [95](#), [97](#)
- show fragment . . . . . [503](#)
- show frame-relay fragment . . . . . [266](#), [267](#)
- show frame-relay lmi . . . . . [266](#), [267](#)
- show frame-relay map . . . . . [266](#), [268](#)
- show frame-relay pvc . . . . . [266](#), [268](#)
- show frame-relay traffic . . . . . [266](#), [268](#)
- show icc-monitoring . . . . . [87](#), [88](#)
- show icc-vlan . . . . . [353](#), [357](#)
- show image version . . . . . [95](#), [97](#), [99](#), [105](#), [108](#), [113](#)
- show incoming-routing . . . . . [188](#)
- show interface . . . . . [241](#)
- show interfaces
  - dialer interface . . . . . [274](#), [276](#), [292](#)
  - frame relay . . . . . [263](#), [265](#), [266](#)
  - GRE tunnel . . . . . [464](#), [466](#)
  - interface status . . . . . [434](#)
  - PPP . . . . . [257](#), [258](#)
  - unnumbered IP interface . . . . . [449](#)
  - VLANs . . . . . [354](#), [358](#)
  - WAN configuration . . . . . [266](#), [268](#)
- show interfaces usb-modem . . . . . [240](#)
- show ip access-control-list . . . . . [610](#), [612](#), [614](#)
- show ip active-lists . . . . . [527](#), [590](#), [628](#), [635](#)
- show ip active-pbr-lists . . . . . [635](#)
- show ip arp . . . . . [484](#), [485](#)
- show ip capture-list . . . . . [423](#), [434](#)
- show ip crypto-list . . . . . [527](#)
- show ip crypto-lists . . . . . [590](#)
- show ip dhcp-client . . . . . [201](#), [203](#), [204](#), [205](#)
- show ip dhcp-client statistics . . . . . [203](#), [204](#)
- show ip dhcp-pool . . . . . [477](#), [479](#)
- show ip dhcp-server bindings . . . . . [477](#), [480](#)
- show ip dhcp-server statistics . . . . . [477](#), [480](#)
- show ip distribution access-lists . . . . . [492](#)
- show ip domain . . . . . [93](#), [95](#)
- show ip domain statistics . . . . . [93](#), [95](#)
- show ip icmp . . . . . [486](#)
- show ip interface . . . . . [267](#)
- show ip interface brief . . . . . [448](#)
- show ip interfaces . . . . . [268](#)
- show ip next-hop-list all . . . . . [628](#)
- show ip ospf . . . . . [494](#), [496](#)
- show ip ospf database . . . . . [494](#), [496](#)
- show ip ospf interface . . . . . [494](#), [496](#)
- show ip ospf neighbor . . . . . [494](#), [496](#)
- show ip ospf protocols . . . . . [496](#)
- show ip pbr-list . . . . . [627](#), [635](#)
- show ip protocols . . . . . [492](#), [495](#)
- show ip qos-list . . . . . [610](#), [615](#)
- show ip reverse-arp . . . . . [484](#), [485](#)
- show ip route . . . . . [455](#), [456](#)
- show ip route best-match . . . . . [455](#), [456](#)
- show ip route static . . . . . [455](#), [456](#)
- show ip route summary . . . . . [455](#), [456](#)
- show ip route track-table . . . . . [455](#)
- show ip rtp header-compression . . . . . [229](#), [231](#)
- show ip rtp header-compression brief . . . . . [229](#)
- show ip ssh . . . . . [62](#), [63](#)
- show ip tcp header-compression . . . . . [229](#), [231](#)
- show ip tcp header-compression brief . . . . . [229](#), [231](#)
- show ip telnet . . . . . [68](#)
- show ip track-table . . . . . [456](#)
- show ip vrrp . . . . . [501](#), [502](#)
- show ip-codec-set . . . . . [188](#)
- show ip-next-hop-list . . . . . [634](#)
- show ip-qos-list . . . . . [617](#)
- show ip-rule
  - access control list . . . . . [613](#), [614](#)
  - policy based routing . . . . . [625](#), [628](#), [634](#)
  - policy list . . . . . [610](#)
  - QoS list . . . . . [617](#)
- show keepalive-icmp . . . . . [294](#), [296](#)
- show last-pim-update . . . . . [188](#)
- show license status . . . . . [510](#)
- show list . . . . . [595](#), [610](#), [614](#), [617](#), [628](#), [635](#)
- show lldp . . . . . [207](#), [208](#)
- show lldp config . . . . . [207](#), [208](#)
- show logging file condition . . . . . [214](#), [223](#)
- show logging file content . . . . . [213](#), [217](#), [223](#)
- show logging server condition . . . . . [212](#), [223](#)
- show logging session condition . . . . . [216](#), [223](#)
- show login authentication . . . . . [59](#), [61](#)
- show map-class frame-relay . . . . . [266](#), [268](#)

## Index

- show max-ip-registration . . . . . [188](#)
- show mediaserver . . . . . [88](#)
- show mg list\_config . . . . . [96, 97](#)
- show mgc . . . . . [85, 88, 95, 97](#)
- show mgc list . . . . . [85, 88](#)
- show mm . . . . . [95](#)
- show module . . . . . [96, 97](#)
- show mss-notification rate . . . . . [78](#)
- show next-hop . . . . . [626, 628, 633](#)
- show pim-lockout . . . . . [188](#)
- show pmi . . . . . [80, 81](#)
- show point-to-point status . . . . . [369](#)
- show port auto-negotiation-flowcontrol-advertisement .  
[194, 196](#)
- show port classification . . . . . [369, 370](#)
- show port edge state . . . . . [194, 364, 368](#)
- show port edge status . . . . . [196](#)
- show port flowcontrol . . . . . [194, 196](#)
- show port lldp config . . . . . [207, 208](#)
- show port lldp vlan-name config . . . . . [207, 208](#)
- show port mirror . . . . . [361, 362](#)
- show port point-to-point status . . . . . [365](#)
- show port redundancy . . . . . [359, 360](#)
- show port trap . . . . . [333, 335](#)
- show port vlan-binding . . . . . [354](#)
- show port vlan-binding-mode . . . . . [358](#)
- show ppp authentication . . . . . [241, 244](#)
- show protocol . . . . . [68, 94](#)
- show protocols . . . . . [95](#)
- show qos-rtcp . . . . . [232, 233](#)
- show queue . . . . . [234, 235](#)
- show queueing . . . . . [234, 235, 236, 237](#)
- show radius authentication . . . . . [65, 66](#)
- show recovery . . . . . [86, 88](#)
- show restart-log . . . . . [96, 97](#)
- show restore status . . . . . [102, 111](#)
- show rmon alarm . . . . . [372, 374](#)
- show rmon event . . . . . [372, 374](#)
- show rmon history . . . . . [372, 374](#)
- show rmon statistics . . . . . [372, 374](#)
- show rtp-stat config . . . . . [380, 413](#)
- show rtp-stat detailed . . . . . [386, 413](#)
- show rtp-stat sessions . . . . . [385, 413](#)
- show rtp-stat summary . . . . . [384, 413](#)
- show rtp-stat thresholds . . . . . [377, 413](#)
- show rtp-stat traceroute . . . . . [398, 413](#)
- show rtr configuration . . . . . [304, 315](#)
- show rtr operational-state . . . . . [304, 315](#)
- show running-config . . . . . [267](#)
- show sig-group . . . . . [188](#)
- show slot-config . . . . . [188](#)
- show sls . . . . . [184](#)
- show snmp . . . . . [72, 78, 333, 335, 337, 383](#)
- show snmp engineID . . . . . [337](#)
- show snmp group . . . . . [337](#)
- show snmp retries . . . . . [337, 338](#)
- show snmp timeout . . . . . [337, 338](#)
- show snmp user . . . . . [337, 338](#)
- show snmp userToGroup . . . . . [337](#)
- show snmp usertogroup . . . . . [338](#)
- show snmp view . . . . . [336, 338](#)
- show spantree . . . . . [366, 369](#)
- show startup-config . . . . . [267](#)
- show station . . . . . [188](#)
- show sync timing . . . . . [639](#)
- show system . . . . . [82, 96, 97, 105, 113](#)
- show tcp syn-cookies . . . . . [71](#)
- show temp . . . . . [96, 97](#)
- show timeout . . . . . [96, 97](#)
- show track . . . . . [304, 315](#)
- show traffic-shape . . . . . [267, 268](#)
- show trunk . . . . . [354, 358](#)
- show trunk-group . . . . . [189](#)
- show upload announcement-file status . . . . . [349, 350](#)
- show upload auth-file status . . . . . [57, 61](#)
- show upload status . . . . . [428, 434](#)
- show username . . . . . [59](#)
- show utilization . . . . . [96, 97](#)
- show vlan . . . . . [353, 354, 358](#)
- show voltages . . . . . [96, 97](#)
- shutdown
  - CNA test plug . . . . . [438, 441](#)
  - console port . . . . . [243, 244](#)
  - PPPoE . . . . . [261, 263](#)
  - USB port . . . . . [240, 241](#)
  - WAN port . . . . . [198](#)
- sig-group . . . . . [159, 180, 189](#)
- sls . . . . . [159, 160, 184](#)
- snmp trap link-status . . . . . [334, 335](#)
- snmp-server community . . . . . [336, 338](#)
- snmp-server dynamic-trap-manager [72, 78, 338, 339,](#)  
[383](#)
- snmp-server enable notification . . . . . [335](#)
- snmp-server enable notifications . . . . . [333](#)
- snmp-server engineID . . . . . [336, 338](#)
- snmp-server group . . . . . [72, 78, 336, 338](#)
- snmp-server host . . . . . [72, 78, 333, 336, 382](#)
- snmp-server informs . . . . . [333, 336](#)
- snmp-server remote-user . . . . . [336, 338](#)
- snmp-server user . . . . . [72, 78, 330, 336, 338](#)
- snmp-server view . . . . . [332, 336, 338](#)
- source-address . . . . . [301, 315](#)
- source-ip
  - access control list . . . . . [613](#)
  - crypto list rule . . . . . [521, 589](#)
  - packet sniffing . . . . . [418, 433](#)
  - policy based routing . . . . . [634](#)
  - policy list . . . . . [601](#)
  - QoS list . . . . . [617](#)
- speed . . . . . [198, 240, 242, 244](#)
- USB port . . . . . [241](#)
- start-ip-addr . . . . . [472, 479](#)



station . . . . .	<a href="#">159</a> , <a href="#">163</a> , <a href="#">189</a>
subnet-mask . . . . .	<a href="#">472</a> , <a href="#">473</a> , <a href="#">479</a>
success-retries . . . . .	<a href="#">301</a> , <a href="#">315</a>
suggest-key . . . . .	<a href="#">516</a> , <a href="#">587</a>
tcp destination-port . . . . .	<a href="#">419</a> , <a href="#">433</a> , <a href="#">602</a> , <a href="#">613</a> , <a href="#">617</a> , <a href="#">634</a>
tcp established . . . . .	<a href="#">604</a> , <a href="#">614</a>
tcp source-port . . . . .	<a href="#">419</a> , <a href="#">433</a> , <a href="#">602</a> , <a href="#">614</a> , <a href="#">617</a> , <a href="#">634</a>
tcp syn-cookies . . . . .	<a href="#">70</a> , <a href="#">71</a>
telnet . . . . .	<a href="#">48</a> , <a href="#">68</a>
test led . . . . .	<a href="#">96</a> , <a href="#">97</a>
test-rate-limit . . . . .	<a href="#">438</a> , <a href="#">441</a>
threshold count . . . . .	<a href="#">303</a> , <a href="#">315</a>
timeout absolute . . . . .	<a href="#">240</a> , <a href="#">243</a> , <a href="#">244</a>
timers basic . . . . .	<a href="#">490</a> , <a href="#">491</a>
timers spf . . . . .	<a href="#">495</a> , <a href="#">496</a>
traceroute . . . . .	<a href="#">455</a> , <a href="#">456</a>
track . . . . .	<a href="#">303</a> , <a href="#">315</a>
track rtr . . . . .	<a href="#">302</a>
traffic-shape rate . . . . .	<a href="#">197</a>
transmitter-delay . . . . .	<a href="#">254</a> , <a href="#">256</a>
trunk-group . . . . .	<a href="#">159</a> , <a href="#">190</a>
tunnel checksum . . . . .	<a href="#">463</a> , <a href="#">466</a>
tunnel destination . . . . .	<a href="#">462</a> , <a href="#">466</a>
tunnel dscp . . . . .	<a href="#">463</a> , <a href="#">466</a>
tunnel key . . . . .	<a href="#">463</a> , <a href="#">466</a>
tunnel path-mtu-discovery . . . . .	<a href="#">461</a> , <a href="#">466</a>
tunnel source . . . . .	<a href="#">462</a> , <a href="#">466</a>
tunnel ttl . . . . .	<a href="#">463</a> , <a href="#">466</a>
type . . . . .	<a href="#">300</a> , <a href="#">314</a>
udp destination-port . . . . .	<a href="#">419</a> , <a href="#">434</a> , <a href="#">602</a> , <a href="#">614</a> , <a href="#">617</a> , <a href="#">634</a>
udp source-port . . . . .	<a href="#">419</a> , <a href="#">434</a> , <a href="#">602</a> , <a href="#">614</a> , <a href="#">617</a> , <a href="#">634</a>
username . . . . .	<a href="#">54</a>
value . . . . .	<a href="#">473</a> , <a href="#">474</a> , <a href="#">479</a>
vendor-specific-option . . . . .	<a href="#">474</a> , <a href="#">479</a>
voip-queue . . . . .	<a href="#">234</a> , <a href="#">235</a> , <a href="#">236</a> , <a href="#">237</a>
voip-queue-delay . . . . .	<a href="#">234</a> , <a href="#">236</a> , <a href="#">237</a>
wait-interval . . . . .	<a href="#">301</a> , <a href="#">315</a>
Committed Burst size . . . . .	<a href="#">316</a>
Composite operations	
adding to IP rule . . . . .	<a href="#">607</a>
configuring . . . . .	<a href="#">607</a>
deleting from IP rule . . . . .	<a href="#">607</a>
example . . . . .	<a href="#">608</a>
pre-configured for access control lists . . . . .	<a href="#">605</a>
Computer, connecting to fixed router port . . . . .	<a href="#">193</a>
Configuration	
defining an interface . . . . .	<a href="#">79</a>
DHCP client . . . . .	<a href="#">200</a>
dynamic trap manager . . . . .	<a href="#">338</a>
ethernet ports . . . . .	<a href="#">193</a>
header compression . . . . .	<a href="#">225</a>
LLDP . . . . .	<a href="#">206</a>
managing configuration files . . . . .	<a href="#">113</a>
MGC list . . . . .	<a href="#">84</a>
modem . . . . .	<a href="#">239</a>
primary management interface . . . . .	<a href="#">80</a>
RTCP . . . . .	<a href="#">225</a>
RTP . . . . .	<a href="#">225</a>
running configuration . . . . .	<a href="#">40</a>
saving configuration changes . . . . .	<a href="#">40</a>
startup . . . . .	<a href="#">267</a>
startup configuration . . . . .	<a href="#">40</a>
switching . . . . .	<a href="#">351</a>
using Avaya IW . . . . .	<a href="#">48</a>
using GIW . . . . .	<a href="#">51</a>
using the CLI . . . . .	<a href="#">39</a>
WAN ethernet port . . . . .	<a href="#">196</a>
Configuration file	
CLI commands . . . . .	<a href="#">115</a>
Console device	
configuring console port for use with . . . . .	<a href="#">242</a>
configuring console port to detect . . . . .	<a href="#">242</a>
Console port	
assigning IP address . . . . .	<a href="#">242</a>
associating with Dialer interface . . . . .	<a href="#">283</a>
CLI commands . . . . .	<a href="#">243</a>
configuring for modem use . . . . .	<a href="#">47</a>
configuring for telnet access . . . . .	<a href="#">242</a>
configuring for use with console device . . . . .	<a href="#">242</a>
configuring for use with modem . . . . .	<a href="#">244</a>
configuring to detect console device . . . . .	<a href="#">242</a>
configuring to detect modem . . . . .	<a href="#">242</a>
connecting modem . . . . .	<a href="#">47</a>
default settings . . . . .	<a href="#">244</a>
description . . . . .	<a href="#">242</a>
disconnecting sessions . . . . .	<a href="#">243</a>
entering interface context . . . . .	<a href="#">242</a>
GIW configuration via . . . . .	<a href="#">51</a>
resetting connected modems . . . . .	<a href="#">242</a>
setting authentication method . . . . .	<a href="#">242</a>
setting load calculation intervals . . . . .	<a href="#">243</a>
setting PPP timeout disconnects . . . . .	<a href="#">243</a>
Contact closure	
activating when access code dialed . . . . .	<a href="#">344</a>
closure modes . . . . .	<a href="#">344</a>
configuring software . . . . .	<a href="#">344</a>
deactivating manually . . . . .	<a href="#">344</a>
displaying status . . . . .	<a href="#">345</a>
overview . . . . .	<a href="#">343</a>
relay control methods . . . . .	<a href="#">343</a>
setting manually . . . . .	<a href="#">344</a>
setting pulse duration . . . . .	<a href="#">344</a>
using in SLS mode . . . . .	<a href="#">129</a>
Contact closure configuration	
CLI commands . . . . .	<a href="#">345</a>
Contexts . . . . .	<a href="#">44</a>
Continuous channel in VPN . . . . .	<a href="#">539</a>
Controller	
configuring mode . . . . .	<a href="#">249</a>
displaying configuration . . . . .	<a href="#">249</a>

## Index

entering context . . . . .	<a href="#">249</a>
Cost . . . . .	<a href="#">493</a>
Crypto list	
configuring . . . . .	<a href="#">520</a>
deactivating . . . . .	<a href="#">523</a>
crypto list	
overview . . . . .	<a href="#">506</a>
Crypto map	
configuring . . . . .	<a href="#">519</a>
overview . . . . .	<a href="#">506</a>

## D

Data Link Connection Identifier	
see DLCI	
Default gateway	
CLI commands . . . . .	<a href="#">82</a>
defining . . . . .	<a href="#">82</a> , <a href="#">455</a>
removing . . . . .	<a href="#">455</a>
DeMilitarized Zone	
see DMZ	
Denial of Service reporting . . . . .	<a href="#">71</a>
Deployments	
basic. . . . .	<a href="#">31</a>
introduction. . . . .	<a href="#">31</a>
overview . . . . .	<a href="#">31</a>
port redundancy . . . . .	<a href="#">32</a> , <a href="#">33</a>
STP . . . . .	<a href="#">34</a>
STP and switch redundancy . . . . .	<a href="#">35</a>
switch redundancy . . . . .	<a href="#">33</a>
Device status	
CLI commands . . . . .	<a href="#">97</a>
viewing. . . . .	<a href="#">95</a>
DHCP	
BOOTP relay . . . . .	<a href="#">468</a>
configuration . . . . .	<a href="#">469</a>
description . . . . .	<a href="#">467</a>
DHCP and BOOTP relay	
CLI commands . . . . .	<a href="#">469</a>
DHCP client	
applications . . . . .	<a href="#">199</a>
CLI commands . . . . .	<a href="#">204</a>
CLI logging	
enabling . . . . .	<a href="#">203</a>
setting logging session conditions . . . . .	<a href="#">203</a>
viewing . . . . .	<a href="#">203</a>
configuring . . . . .	<a href="#">200</a>
determining DHCP option requests . . . . .	<a href="#">200</a>
displaying configuration . . . . .	<a href="#">203</a>
displaying parameters. . . . .	<a href="#">201</a>
enabling . . . . .	<a href="#">201</a>
lease	
releasing . . . . .	<a href="#">202</a>
renewing . . . . .	<a href="#">202</a>
maintaining. . . . .	<a href="#">203</a>

overview . . . . .	<a href="#">199</a>
setting the client identifier . . . . .	<a href="#">200</a>
setting the client lease . . . . .	<a href="#">200</a>
setting the hostname . . . . .	<a href="#">200</a>
DHCP options . . . . .	<a href="#">473</a>
DHCP server	
CLI commands . . . . .	<a href="#">478</a>
configuration examples . . . . .	<a href="#">475</a>
configuring DHCP options . . . . .	<a href="#">473</a>
configuring vendor-specific options . . . . .	<a href="#">474</a>
overview . . . . .	<a href="#">470</a>
typical application . . . . .	<a href="#">471</a>
Diagnosing	
and monitoring the network . . . . .	<a href="#">371</a>
Dial On Demand Routing (DDR) . . . . .	<a href="#">272</a>
Dialer interface	
activating with object tracking . . . . .	<a href="#">279</a>
as backup for Loopback interface. . . . .	<a href="#">272</a>
as backup for WAN interface . . . . .	<a href="#">272</a>
assigning access control list to . . . . .	<a href="#">283</a>
assigning to Console port . . . . .	<a href="#">283</a>
authentication method . . . . .	<a href="#">276</a>
CHAP authentication . . . . .	<a href="#">276</a>
CLI commands . . . . .	<a href="#">291</a>
configuring . . . . .	<a href="#">274</a>
configuring as backup . . . . .	<a href="#">277</a>
configuring backup routing . . . . .	<a href="#">277</a>
dynamic IP . . . . .	<a href="#">279</a>
dynamic routing . . . . .	<a href="#">272</a>
giving priority to VoIP . . . . .	<a href="#">271</a>
logging . . . . .	<a href="#">284</a>
setting IP address . . . . .	<a href="#">274</a>
static routing . . . . .	<a href="#">272</a>
unnumbered IP . . . . .	<a href="#">272</a> , <a href="#">279</a> , <a href="#">448</a>
verifying connection . . . . .	<a href="#">276</a>
Dialer strings . . . . .	<a href="#">274</a>
Directed broadcast forwarding. . . . .	<a href="#">480</a>
Discard routes . . . . .	<a href="#">454</a>
Distribution access lists . . . . .	<a href="#">488</a>
DLCI	
configuring for frame relay sub-interface . . . . .	<a href="#">264</a>
OSPF mapping . . . . .	<a href="#">318</a>
Priority	
see Priority DLCI	
DMZ . . . . .	<a href="#">444</a>
DNS resolver	
clearing counters . . . . .	<a href="#">94</a>
CLI commands . . . . .	<a href="#">94</a>
configuration example . . . . .	<a href="#">93</a>
features. . . . .	<a href="#">89</a>
maintaining . . . . .	<a href="#">93</a>
overview . . . . .	<a href="#">88</a>
showing information . . . . .	<a href="#">93</a>
typical application . . . . .	<a href="#">89</a>
when not necessary . . . . .	<a href="#">91</a>

- DNS servers
    - requesting list of DNS servers during a PPP/IPCP session . . . . . [261](#)
    - requesting list of DNS servers from a DHCP server [200](#)
  - DoS reporting . . . . . [71](#)
  - DSA . . . . . [61](#)
  - DSCP
    - as access control list rule criteria . . . . . [604](#)
    - as policy-based routing rule criteria . . . . . [604](#)
    - as QoS list rule criteria . . . . . [604](#)
    - in GRE header . . . . . [463](#)
    - in RTR probes . . . . . [300](#)
    - in VPN packets . . . . . [520](#)
    - routing based on . . . . . [620](#)
  - DSCP table, see Policy. . . . . [608](#)
  - duplex. . . . . [198](#)
  - Duplex, configuring duplex type. . . . . [194](#)
  - Dynamic CAC
    - and modem dial backup. . . . . [271](#), [278](#)
    - CLI commands . . . . . [298](#)
    - configuration . . . . . [297](#)
    - description . . . . . [296](#)
  - Dynamic Host Configuration Protocol
    - see DHCP
  - Dynamic IP
    - configuring . . . . . [537](#)
    - Dialer interface . . . . . [279](#)
    - overview . . . . . [536](#)
  - Dynamic routes
    - deleting . . . . . [455](#)
    - redistributing . . . . . [497](#)
  - Dynamic trap manager
    - CLI commands . . . . . [339](#)
    - configuring . . . . . [338](#)
- 
- E**
- E1/T1 lines
    - CLI commands . . . . . [253](#)
    - connecting to WAN media module . . . . . [245](#)
    - default settings . . . . . [251](#)
  - E1/T1 ports . . . . . [249](#)
  - ECMP. . . . . [493](#)
  - Emergency Transfer Relay
    - see ETR
  - Encrypting gateway secrets. . . . . [68](#)
  - Ethernet ports
    - CLI commands . . . . . [195](#)
    - configuration . . . . . [193](#)
    - configuring duplex type . . . . . [194](#)
    - configuring link negotiation protocol . . . . . [195](#)
    - configuring switch port . . . . . [194](#)
    - connecting devices to . . . . . [193](#)
    - list of. . . . . [193](#)
    - port redundancy . . . . . [358](#)
    - setting flowcontrol advertisements . . . . . [194](#)
    - WAN Ethernet port
      - see WAN Ethernet port
  - ETR
    - CLI commands . . . . . [326](#)
    - description . . . . . [325](#)
    - displaying status . . . . . [326](#)
    - LED . . . . . [325](#)
    - manual activation . . . . . [325](#)
    - setting state. . . . . [325](#)
  - Excess Burst size. . . . . [316](#)
- 
- F**
- Fair VoIP queue . . . . . [234](#)
  - Fast Ethernet interface
    - configuring PPPoE . . . . . [258](#)
  - Fast Ethernet port . . . . . [294](#)
    - auto-negotiation . . . . . [197](#)
    - configuring duplex type . . . . . [197](#)
    - configuring interface . . . . . [196](#)
    - configuring port speed . . . . . [197](#)
    - firewall connected . . . . . [444](#)
    - VPN connected . . . . . [444](#)
  - FastEthernet Interface
    - described . . . . . [444](#)
  - FastEthernet interface
    - checking status . . . . . [292](#)
    - dynamic bandwidth reporting . . . . . [296](#)
    - ICMP keepalive . . . . . [292](#)
  - Features . . . . . [28](#)
  - File transfer, see FTP or TFTP . . . . . [98](#)
  - FIPS
    - adding next hops . . . . . [453](#)
    - disabling modem dial backup. . . . . [279](#)
    - next hops static routes. . . . . [452](#)
  - Firewall . . . . . [444](#)
  - Firmware
    - CLI commands . . . . . [104](#)
    - firmware bank defaults. . . . . [99](#)
    - firmware banks . . . . . [41](#)
    - load with ASB button . . . . . [99](#)
    - managing firmware banks . . . . . [99](#)
    - redundancy . . . . . [99](#)
    - upgrade overview . . . . . [98](#)
    - upgrading using FTP/TFTP . . . . . [100](#)
    - upgrading using USB mass storage device . . . . . [101](#)
    - uploading files from the gateway . . . . . [102](#)
    - version control . . . . . [41](#)
  - Fixed analog trunk port . . . . . [325](#)
  - Flowcontrol advertisement . . . . . [194](#)
  - Fragmentation
    - as map class parameter . . . . . [316](#)
    - CLI commands . . . . . [503](#)
    - configuration . . . . . [503](#)

## Index

description . . . . .	<a href="#">502</a>
GRE tunneling . . . . .	<a href="#">461</a>
reassemble . . . . .	<a href="#">503</a>
Frame relay . . . . .	<a href="#">245</a>
displaying configuration . . . . .	<a href="#">266</a>
enabling traffic shaping . . . . .	<a href="#">316</a>
Frame relay encapsulation	
CLI commands . . . . .	<a href="#">265</a>
down status . . . . .	<a href="#">269</a>
encapsulation types . . . . .	<a href="#">263</a>
establishing Layer 3 interface . . . . .	<a href="#">453</a>
IETF . . . . .	<a href="#">263</a>
illustration . . . . .	<a href="#">247</a>
non-IETF . . . . .	<a href="#">263</a>
supported features . . . . .	<a href="#">316</a>
supported on Serial interfaces . . . . .	<a href="#">246</a> , <a href="#">445</a>
Frame relay traffic shaping	
CLI commands . . . . .	<a href="#">317</a>
configuring within map classes . . . . .	<a href="#">316</a>
description . . . . .	<a href="#">316</a>
displaying configuration . . . . .	<a href="#">267</a>
enabling . . . . .	<a href="#">316</a>
FRF.12 fragmentation	
configuring within map classes . . . . .	<a href="#">316</a>
description . . . . .	<a href="#">316</a>
FTP . . . . .	<a href="#">98</a>

## G

General context . . . . .	<a href="#">44</a>
Generic Routing Encapsulation, see GRE tunneling	
Gigabit Ethernet port	
location . . . . .	<a href="#">193</a>
port redundancy . . . . .	<a href="#">358</a>
GIW	
accessing . . . . .	<a href="#">51</a>
configuration using . . . . .	<a href="#">51</a>
description . . . . .	<a href="#">51</a>
installation on laptop . . . . .	<a href="#">51</a>
GRE tunneling	
adding checksum . . . . .	<a href="#">463</a>
adding ID keys . . . . .	<a href="#">463</a>
applications . . . . .	<a href="#">457</a>
as next hop . . . . .	<a href="#">625</a>
assigning DSCP . . . . .	<a href="#">463</a>
assigning TTL . . . . .	<a href="#">463</a>
checking tunnel status . . . . .	<a href="#">460</a> , <a href="#">462</a>
CLI commands . . . . .	<a href="#">466</a>
compared to VPN . . . . .	<a href="#">456</a>
displaying tunnel information . . . . .	<a href="#">464</a>
dynamic bandwidth reporting . . . . .	<a href="#">296</a>
dynamic MTU discovery . . . . .	<a href="#">461</a>
optional features . . . . .	<a href="#">460</a>
overview . . . . .	<a href="#">444</a> , <a href="#">456</a>
preventing recursive routing . . . . .	<a href="#">458</a>

routing packets to tunnel . . . . .	<a href="#">457</a>
Guide	
downloading from website . . . . .	<a href="#">23</a>
latest version, downloading . . . . .	<a href="#">23</a>

## H

Header compression	
clearing rtp header compression statistics . . . . .	<a href="#">231</a>
clearing tcp header compression statistics . . . . .	<a href="#">231</a>
decompression . . . . .	<a href="#">226</a>
IPCH method - RTP and TCP header compression	
CLI commands . . . . .	<a href="#">228</a>
disabling . . . . .	<a href="#">228</a>
enabling . . . . .	<a href="#">228</a>
overview . . . . .	<a href="#">226</a>
IPHC method - RTP and TCP header compression	
configuring UDP ports range . . . . .	<a href="#">227</a>
methods . . . . .	<a href="#">226</a>
overview . . . . .	<a href="#">225</a>
showing rtp header compression statistics . . . . .	<a href="#">231</a>
showing tcp header compression statistics . . . . .	<a href="#">231</a>
supported methods per interface type . . . . .	<a href="#">226</a>
transmission rate . . . . .	<a href="#">226</a>
Van Jacobson Method - TCP header compression	
CLI commands . . . . .	<a href="#">231</a>
configuring . . . . .	<a href="#">229</a>
disabling . . . . .	<a href="#">230</a>
enabling . . . . .	<a href="#">230</a>
overview . . . . .	<a href="#">226</a>
Hello packets . . . . .	<a href="#">494</a>
Help	
CLI . . . . .	<a href="#">44</a>
commands . . . . .	<a href="#">44</a>
High Preference static routes . . . . .	<a href="#">452</a>

## I

ICC-VLAN . . . . .	<a href="#">353</a>
ICMP errors . . . . .	<a href="#">486</a>
CLI commands . . . . .	<a href="#">486</a>
ICMP keepalive . . . . .	<a href="#">292</a>
and policy-based routing . . . . .	<a href="#">619</a>
CLI commands . . . . .	<a href="#">295</a>
IGAR . . . . .	<a href="#">271</a> , <a href="#">278</a> , <a href="#">296</a>
IKE	
phase 1 . . . . .	<a href="#">505</a>
phase 2 . . . . .	<a href="#">505</a>
Ingress Access Control List . . . . .	<a href="#">619</a>
Ingress QoS List . . . . .	<a href="#">619</a>
Interface configuration	
CLI commands . . . . .	<a href="#">446</a>
Interface status	
CLI commands . . . . .	<a href="#">435</a>
Interfaces	

adjusting bandwidth . . . . . [493](#)  
 administrative status . . . . . [198](#)  
 applying PBR lists . . . . . [623](#)  
 assigning Cost . . . . . [493](#)  
 assigning IP addresses . . . . . [79](#)  
 authentication . . . . . [489](#)  
 backup . . . . . [197](#)  
 configuration . . . . . [443](#)  
 configuration examples . . . . . [446](#)  
 defining . . . . . [79](#)  
 disabling . . . . . [452](#)  
 displaying information . . . . . [267](#)  
 displaying status . . . . . [434](#)  
 duplex type . . . . . [197](#)  
 dynamic bandwidth reporting . . . . . [296](#)  
 fastethernet . . . . . [444](#)  
 frame relay . . . . . [263](#)  
 GRE tunnel, *see* GRE tunneling  
 IP  
     *see* IP interfaces  
 Layer 2 . . . . . [444](#), [452](#)  
 Layer 3 . . . . . [453](#)  
 logical . . . . . [445](#)  
 Loopback . . . . . [444](#), [619](#), [623](#)  
 metrics . . . . . [494](#)  
 network type . . . . . [494](#)  
 physical . . . . . [444](#)  
 priority . . . . . [494](#)  
 Serial . . . . . [445](#)  
     *see* Serial interfaces  
 setting administrative state . . . . . [445](#)  
 setting load calculation intervals . . . . . [79](#)  
 speed . . . . . [198](#)  
 switching . . . . . [444](#), [445](#)  
 testing configuration . . . . . [266](#)  
 updating broadcast address . . . . . [445](#)  
 USP WAN . . . . . [444](#)  
 virtual . . . . . [246](#), [444](#)  
 WAN . . . . . [444](#)  
 Inter-Gateway Alternate Routing, *see* IGAR  
 Internet Key Exchange (IKE) . . . . . [505](#)  
 IP address  
     assigning to USB port . . . . . [38](#)  
     defining . . . . . [445](#)  
     obtaining via DHCP . . . . . [199](#)  
     obtaining via PPP/IPCP negotiation . . . . . [260](#)  
     storing in ARP table . . . . . [482](#)  
 ip domain timeout . . . . . [91](#)  
 IP interfaces . . . . . [445](#)  
 IP Security, *see* VPN  
 IP unnumbered interface configuration  
     CLI commands . . . . . [450](#)  
 IPSec VPN, *see* VPN  
 ISAKMP  
     peer-group configuration . . . . . [518](#)

policies . . . . . [512](#)  
 VPN peer configuration . . . . . [514](#)

---

## K

keepalive  
     configuring on PPP WAN line . . . . . [257](#)  
 keepalive ICMP, *see* ICMP keepalive  
 Keepalive, GRE tunnel . . . . . [460](#)  
 keepalive-track . . . . . [198](#)  
     configuring in VPN . . . . . [517](#)  
     configuring on PPPoE interface . . . . . [261](#)

---

## L

LAN . . . . . [444](#)  
 Layer 2 interfaces . . . . . [452](#)  
 Layer 2 logical interfaces . . . . . [445](#)  
 Layer 2 virtual interfaces . . . . . [444](#)  
 Layer 3 interfaces . . . . . [453](#)  
 LEDs, ETR . . . . . [325](#)  
 Link Layer Discovery Protocol, *see* LLDP . . . . . [205](#)  
 Link-state algorithm . . . . . [492](#)  
 Listing files . . . . . [116](#)  
     CLI commands . . . . . [116](#)  
 LLDP  
     802.1 TLVs (optional) . . . . . [206](#)  
     CLI commands . . . . . [208](#)  
     configuration . . . . . [206](#)  
     enabling . . . . . [206](#)  
     mandatory TLVs . . . . . [206](#)  
     optional TLVs . . . . . [206](#)  
     overview . . . . . [205](#)  
     setting additional TLVs . . . . . [207](#)  
     setting port status . . . . . [206](#)  
     supported ports . . . . . [207](#)  
     supported TLVs . . . . . [206](#)  
     verify advertisements . . . . . [207](#)  
 LMI parameters . . . . . [263](#)  
 Load balancing  
     ECMP . . . . . [493](#)  
     VRRP . . . . . [498](#)  
 Local Management Interface  
     *see* LMI parameters . . . . . [263](#)  
 Log file  
     *see* Logging  
 Logging  
     CLI commands . . . . . [222](#)  
     configuring log file . . . . . [213](#)  
     configuring session log . . . . . [215](#)  
     configuring Syslog server . . . . . [210](#)  
     default severity levels . . . . . [218](#)  
     defining filters . . . . . [217](#)  
     deleting log file . . . . . [213](#)  
     deleting Syslog server . . . . . [211](#)

## Index

Dialer interface . . . . .	<a href="#">284</a>
disabling log file . . . . .	<a href="#">213</a>
disabling session log . . . . .	<a href="#">215</a>
disabling Syslog server . . . . .	<a href="#">211</a>
displaying log file contents. . . . .	<a href="#">213</a>
displaying Syslog server status . . . . .	<a href="#">212</a>
enabling log file. . . . .	<a href="#">213</a>
enabling session log . . . . .	<a href="#">215</a>
enabling Syslog server . . . . .	<a href="#">210</a>
filtering by application . . . . .	<a href="#">219</a>
introduction. . . . .	<a href="#">209</a>
limiting Syslog access. . . . .	<a href="#">211</a>
log file . . . . .	<a href="#">209</a>
log file example . . . . .	<a href="#">221</a>
log file filter contents . . . . .	<a href="#">217</a>
log file message format . . . . .	<a href="#">215</a>
modem dial backup . . . . .	<a href="#">284</a>
object trackers . . . . .	<a href="#">305</a>
object tracking . . . . .	<a href="#">305</a>
overview . . . . .	<a href="#">209</a>
RTR . . . . .	<a href="#">305</a>
saving settings . . . . .	<a href="#">209</a>
session log . . . . .	<a href="#">209</a> , <a href="#">215</a>
session log example . . . . .	<a href="#">222</a>
session log message format. . . . .	<a href="#">216</a>
setting filters . . . . .	<a href="#">217</a>
sinks . . . . .	<a href="#">209</a>
specifying Syslog output facility . . . . .	<a href="#">210</a>
Syslog default settings . . . . .	<a href="#">212</a>
Syslog server. . . . .	<a href="#">209</a>
Syslog server example . . . . .	<a href="#">220</a>
Syslog server message format. . . . .	<a href="#">212</a>
VPN . . . . .	<a href="#">528</a>
Logging session, see Logging	
Logical interfaces . . . . .	<a href="#">445</a>
Loopback interface. . . . .	<a href="#">272</a> , <a href="#">444</a> , <a href="#">619</a> , <a href="#">623</a>
Loops	
defined. . . . .	<a href="#">362</a>
preventing in GRE tunneling. . . . .	<a href="#">458</a>
preventing in RIP . . . . .	<a href="#">487</a>
Low preference static routes . . . . .	<a href="#">452</a>

## M

MAC addresses, storing in ARP table . . . . .	<a href="#">482</a>
Managed Security Services, see MSS	
Map classes	
applying to all configured Permanent Virtual Channels	<a href="#">316</a>
default . . . . .	<a href="#">316</a>
number that can be configured . . . . .	<a href="#">316</a>
parameters. . . . .	<a href="#">316</a>
Master Configuration Key	
CLI commands . . . . .	<a href="#">71</a>
configuring . . . . .	<a href="#">69</a>

MCG	
CLI commands . . . . .	<a href="#">88</a>
MCK (Master Configuration Key) . . . . .	<a href="#">68</a>
Media modules . . . . .	<a href="#">28</a>
adding, using a USB mass storage device . . . . .	<a href="#">111</a>
MM340 . . . . .	<a href="#">248</a> , <a href="#">249</a> , <a href="#">444</a>
MM342 . . . . .	<a href="#">248</a> , <a href="#">254</a> , <a href="#">444</a>
upgrading, using a USB mass storage device . . . . .	<a href="#">111</a>
USP WAN, see MM342 media module	
WAN . . . . .	<a href="#">248</a>
Metrics. . . . .	<a href="#">497</a>
MGC	
accessing. . . . .	<a href="#">53</a>
accessing the registered MGC . . . . .	<a href="#">87</a>
auto fallback to primary . . . . .	<a href="#">83</a>
changing the list. . . . .	<a href="#">86</a>
checking connectivity with . . . . .	<a href="#">272</a>
clearing the list . . . . .	<a href="#">86</a>
displaying the list . . . . .	<a href="#">85</a>
monitoring the ICC . . . . .	<a href="#">87</a>
monitoring the LSP . . . . .	<a href="#">87</a>
overview . . . . .	<a href="#">82</a>
reporting bandwidth to . . . . .	<a href="#">296</a>
running Avaya Communication Manager . . . . .	<a href="#">53</a>
setting reset times . . . . .	<a href="#">86</a>
setting the list . . . . .	<a href="#">84</a>
MGC list	
SLS entry . . . . .	<a href="#">123</a>
MM340 media module	
configuring . . . . .	<a href="#">249</a>
E1/T1 WAN interface . . . . .	<a href="#">444</a>
MM342 media module	
configuring . . . . .	<a href="#">254</a>
USP WAN interface . . . . .	<a href="#">444</a>
Modem	
configuring . . . . .	<a href="#">239</a>
configuring console port for use with . . . . .	<a href="#">244</a>
configuring console port to detect. . . . .	<a href="#">242</a>
configuring type on console port . . . . .	<a href="#">242</a>
connecting to Console port. . . . .	<a href="#">47</a>
connecting to S8300 Server . . . . .	<a href="#">48</a>
connecting to USB port . . . . .	<a href="#">46</a>
connecting via USB modem . . . . .	<a href="#">48</a>
dial backup, see Modem dial backup	
displaying USB modem status . . . . .	<a href="#">240</a>
serial . . . . .	<a href="#">242</a>
USB . . . . .	<a href="#">239</a>
Modem dial backup	
activating with object tracking . . . . .	<a href="#">279</a>
and dynamic CAC . . . . .	<a href="#">271</a> , <a href="#">278</a>
as backup interface . . . . .	<a href="#">272</a>
authentication method . . . . .	<a href="#">276</a>
bandwidth available for . . . . .	<a href="#">271</a>
CHAP authentication . . . . .	<a href="#">276</a>
configuration example . . . . .	<a href="#">279</a>

configuring backup routing . . . . .	<a href="#">277</a>
entering dialer strings . . . . .	<a href="#">274</a>
feature interactions . . . . .	<a href="#">278</a>
FIPS and . . . . .	<a href="#">279</a>
logging . . . . .	<a href="#">284</a>
overview . . . . .	<a href="#">271</a>
policy lists and . . . . .	<a href="#">271</a>
prerequisites . . . . .	<a href="#">273</a>
RAS configuration . . . . .	<a href="#">273</a>
typical installations . . . . .	<a href="#">273</a>
using VPN . . . . .	<a href="#">271</a>
Weighted Fair Queuing and . . . . .	<a href="#">271</a>
Monitoring applications configuring . . . . .	<a href="#">371</a>
MSS	
CLI commands . . . . .	<a href="#">78</a>
configuring . . . . .	<a href="#">72</a>
example . . . . .	<a href="#">77</a>
Overview . . . . .	<a href="#">71</a>
predefined DoS classes . . . . .	<a href="#">74</a>
reporting mechanism . . . . .	<a href="#">72</a>
user-defined DoS classes . . . . .	<a href="#">75</a>
Multipoint topology support . . . . .	<a href="#">248</a>

## N

NAT Traversal	
configuring . . . . .	<a href="#">524</a>
overview . . . . .	<a href="#">524</a>
Nested tunneling . . . . .	<a href="#">458</a>
NetBIOS . . . . .	<a href="#">481</a>
Network monitoring applications . . . . .	<a href="#">371</a>
Next hop lists	
applying to policy-based routing rules . . . . .	<a href="#">625</a>
backup routes . . . . .	<a href="#">620</a>
editing . . . . .	<a href="#">626</a>
entries . . . . .	<a href="#">625</a>
overview . . . . .	<a href="#">625</a>
Next hops, <i>see</i> FIPS . . . . .	<a href="#">452</a>

## O

Object tracking	
activating Dialer interface . . . . .	<a href="#">279</a>
applying to DHCP client . . . . .	<a href="#">201</a>
applying to PBR next-hops . . . . .	<a href="#">622</a>
applying to static routes . . . . .	<a href="#">452</a>
backup for the FastEthernet interface . . . . .	<a href="#">309</a>
CLI commands . . . . .	<a href="#">314</a>
configuration . . . . .	<a href="#">299</a>
configuration workflow . . . . .	<a href="#">304</a>
enabling logging . . . . .	<a href="#">305</a>
interface backup via policy-based routing . . . . .	<a href="#">312</a>
maintenance . . . . .	<a href="#">304</a>

object tracker configuration . . . . .	<a href="#">302</a>
overview . . . . .	<a href="#">298</a>
RTR configuration . . . . .	<a href="#">300</a>
showing routes with tracking . . . . .	<a href="#">455</a>
verifying MGC connectivity . . . . .	<a href="#">272</a>
viewing log messages . . . . .	<a href="#">305</a>
VPN failover . . . . .	<a href="#">309</a>
Open Shortest Path First protocol <i>see</i> OSPF	
OSPF	
advertising static routes . . . . .	<a href="#">452</a>
CLI commands . . . . .	<a href="#">495</a>
compared to RIP . . . . .	<a href="#">486</a> , <a href="#">492</a>
configuration . . . . .	<a href="#">493</a>
default metric . . . . .	<a href="#">497</a>
description . . . . .	<a href="#">492</a>
displaying information . . . . .	<a href="#">494</a>
DLCI mapping . . . . .	<a href="#">318</a>
dynamic Cost . . . . .	<a href="#">493</a>
enabling on network . . . . .	<a href="#">494</a>
enabling on system . . . . .	<a href="#">494</a>
interface authentication password . . . . .	<a href="#">493</a>
interface authentication type . . . . .	<a href="#">493</a>
limitations . . . . .	<a href="#">493</a>
metrics . . . . .	<a href="#">493</a>
modem dial backup and . . . . .	<a href="#">273</a>
priority . . . . .	<a href="#">494</a>
redistributing routing information . . . . .	<a href="#">494</a>
shortest-path-first algorithm . . . . .	<a href="#">492</a>
suppressing updates . . . . .	<a href="#">494</a>
using with RIP . . . . .	<a href="#">497</a>
OSPF Autonomous System Boundary Router . . . . .	<a href="#">493</a>

## P

Packet sniffing	
analyzing capture file . . . . .	<a href="#">429</a>
analyzing captured packets . . . . .	<a href="#">426</a>
applying a capture-list . . . . .	<a href="#">423</a>
applying rules to an address range . . . . .	<a href="#">418</a>
applying rules to packets with DSCP values . . . . .	<a href="#">418</a>
applying rules to packets with ip protocols . . . . .	<a href="#">418</a>
capture list examples . . . . .	<a href="#">422</a>
clearing the capture buffer . . . . .	<a href="#">424</a>
CLI commands . . . . .	<a href="#">432</a>
configuring . . . . .	<a href="#">415</a>
creating capture-list . . . . .	<a href="#">416</a>
defining rule criteria . . . . .	<a href="#">416</a>
disabling . . . . .	<a href="#">415</a>
enabling . . . . .	<a href="#">415</a>
enabling the service . . . . .	<a href="#">425</a>
excepting protocols from rules . . . . .	<a href="#">418</a>
excluding ICMP type and code . . . . .	<a href="#">421</a>
identifying the interface . . . . .	<a href="#">430</a>
information, viewing . . . . .	<a href="#">426</a>

## Index

overview . . . . .	<a href="#">413</a>	setting location information . . . . .	<a href="#">81</a>
packets captured . . . . .	<a href="#">414</a>	setting system contact information . . . . .	<a href="#">81</a>
reducing the size of the capture file . . . . .	<a href="#">424</a>	setting the system name . . . . .	<a href="#">81</a>
rule criteria commands . . . . .	<a href="#">417</a>	showing the PMI . . . . .	<a href="#">80</a>
scp file upload limit . . . . .	<a href="#">428</a>	Point-to-Multi-Point topology . . . . .	<a href="#">248</a>
service, starting . . . . .	<a href="#">425</a>	Point-to-Point frame relay . . . . .	<a href="#">245</a> , <a href="#">248</a>
service, stopping . . . . .	<a href="#">426</a>	Poison-reverse . . . . .	<a href="#">488</a> , <a href="#">489</a>
setting buffers . . . . .	<a href="#">424</a>	Policy	
setting capture list context . . . . .	<a href="#">416</a>	access control lists . . . . .	<a href="#">591</a>
setting capture list parameters . . . . .	<a href="#">416</a>	attaching policy list to interface at IACL . . . . .	<a href="#">597</a>
setting max frame size . . . . .	<a href="#">424</a>	attaching policy lists to an interface . . . . .	<a href="#">596</a>
settings . . . . .	<a href="#">424</a>	attaching QoS list to interface at ingress QoS list . . . . .	<a href="#">597</a>
simulating packets . . . . .	<a href="#">431</a>	changing DSCP table entries . . . . .	<a href="#">609</a>
specifying bugger size . . . . .	<a href="#">424</a>	configuring composite operations . . . . .	<a href="#">607</a>
specifying capture actions . . . . .	<a href="#">416</a>	copy list . . . . .	<a href="#">595</a>
specifying ICMP type and code . . . . .	<a href="#">421</a>	create access control list . . . . .	<a href="#">594</a>
specifying interfaces . . . . .	<a href="#">415</a>	create QoS list . . . . .	<a href="#">594</a>
streams that can be captured . . . . .	<a href="#">414</a>	creating policy lists . . . . .	<a href="#">594</a>
streams that cannot be captured . . . . .	<a href="#">414</a>	creating rules . . . . .	<a href="#">600</a>
streams with conditional capture requirements . . . . .	<a href="#">414</a>	default actions . . . . .	<a href="#">596</a>
uploading capture file . . . . .	<a href="#">427</a>	defining global rules . . . . .	<a href="#">599</a>
uploading capture files to remote servers or USB storage device . . . . .	<a href="#">428</a>	defining list identification attributes . . . . .	<a href="#">595</a>
uploading capture files to the S8300 . . . . .	<a href="#">428</a>	defining policy lists . . . . .	<a href="#">594</a>
viewing the capture-list . . . . .	<a href="#">423</a>	deleting a policy list . . . . .	<a href="#">596</a>
viewing, captured packet hex dump . . . . .	<a href="#">426</a>	deleting a QoS list . . . . .	<a href="#">596</a>
Packets, simulating, see Policy . . . . .	<a href="#">611</a>	destination port range . . . . .	<a href="#">602</a>
Password Authentication Protocol . . . . .	<a href="#">240</a> , <a href="#">242</a>	device wide policy lists . . . . .	<a href="#">598</a>
Passwords		displaying access control lists . . . . .	<a href="#">599</a>
changing . . . . .	<a href="#">54</a>	displaying composite operation lists . . . . .	<a href="#">599</a>
managing . . . . .	<a href="#">54</a>	displaying ip rules . . . . .	<a href="#">600</a>
overview . . . . .	<a href="#">53</a>	displaying policy lists in access control list context . . . . .	<a href="#">610</a>
recovery password . . . . .	<a href="#">67</a>	displaying policy lists in DSCP table context . . . . .	<a href="#">611</a>
PBR lists		displaying policy lists in general context . . . . .	<a href="#">610</a>
attaching to interface . . . . .	<a href="#">623</a>	displaying policy lists in QoS list context . . . . .	<a href="#">610</a>
attaching to Loopback interface . . . . .	<a href="#">619</a> , <a href="#">623</a>	displaying policy lists in QoS list rule context . . . . .	<a href="#">610</a>
CLI commands . . . . .	<a href="#">633</a>	DSCP as rule criteria . . . . .	<a href="#">604</a>
deleting . . . . .	<a href="#">627</a>	DSCP default value . . . . .	<a href="#">608</a>
editing rules . . . . .	<a href="#">625</a>	DSCP methods . . . . .	<a href="#">608</a>
modifying . . . . .	<a href="#">627</a>	DSCP table . . . . .	<a href="#">608</a>
name . . . . .	<a href="#">621</a>	edit access control list . . . . .	<a href="#">594</a>
rule criteria . . . . .	<a href="#">624</a>	editing policy lists . . . . .	<a href="#">594</a>
rules . . . . .	<a href="#">621</a> , <a href="#">624</a>	editing rules . . . . .	<a href="#">600</a>
Permanent routes . . . . .	<a href="#">454</a>	example composite operation . . . . .	<a href="#">608</a>
Phones supported in SLS mode . . . . .	<a href="#">119</a>	fragments . . . . .	<a href="#">604</a>
PIM		ICMP code . . . . .	<a href="#">603</a>
accessing . . . . .	<a href="#">52</a>	ICMP type . . . . .	<a href="#">603</a>
description . . . . .	<a href="#">52</a>	managing policy lists . . . . .	<a href="#">594</a>
SLS configuration . . . . .	<a href="#">138</a>	mapping DSCP to a CoS . . . . .	<a href="#">608</a>
Ping . . . . .	<a href="#">267</a>	modem dial backup and . . . . .	<a href="#">271</a>
PMI		network security with access control lists . . . . .	<a href="#">592</a>
CLI commands . . . . .	<a href="#">81</a>	overview . . . . .	<a href="#">591</a>
configuration . . . . .	<a href="#">80</a>	policy lists and loopback interfaces . . . . .	<a href="#">598</a>
entering the interface context . . . . .	<a href="#">80</a>	policy-based routing, see Policy-based routing	
explanation . . . . .	<a href="#">80</a>	preconfigured composite operations . . . . .	<a href="#">605</a>
resetting the interface . . . . .	<a href="#">80</a>	preconfigured for QoS lists . . . . .	<a href="#">606</a>



- QoS fields . . . . . [593](#)
- QoS list . . . . . [594](#)
- QoS list parts . . . . . [593](#)
- QoS lists . . . . . [593](#)
- rule criteria . . . . . [599](#)
- sequence of device-wide policy list application . . . . . [598](#)
- sequence of policy list application . . . . . [596](#)
- simulated packet properties . . . . . [611](#)
- simulating packets . . . . . [611](#)
- source port range . . . . . [602](#)
- specifying a destination ip address . . . . . [601](#)
- specifying a source ip address . . . . . [601](#)
- specifying an ip protocol . . . . . [601](#)
- specifying operations . . . . . [604](#)
- TCP, establish bit . . . . . [604](#)
- testing policy lists . . . . . [610](#)
- using ip wildcards . . . . . [599](#)
- Policy-based routing
  - applications . . . . . [620](#)
  - applying object tracking to next-hops . . . . . [622](#)
  - attaching list to interface . . . . . [623](#)
  - based on DSCP . . . . . [620](#)
  - cancelling object tracking on next-hops . . . . . [626](#)
  - changing the object tracker on a next-hop . . . . . [626](#)
  - defining next hop lists . . . . . [622](#)
  - distinguishing between voice and data . . . . . [620](#)
  - object tracking and . . . . . [312](#)
  - overview . . . . . [619](#)
  - packets not considered router packets . . . . . [619](#)
  - PBR lists, *see* PBR lists
  - routing to GRE tunnel . . . . . [457](#)
  - rules . . . . . [624](#)
  - saving the configuration . . . . . [623](#)
  - used to define backup routes . . . . . [620](#)
  - VoIP . . . . . [620](#)
- Port classification
  - CLI commands . . . . . [370](#)
- Port classification, *see* Ports . . . . . [369](#)
- Port mirroring
  - CLI commands . . . . . [362](#)
  - configuration . . . . . [361](#)
  - description . . . . . [361](#)
- Port redundancy
  - CLI commands . . . . . [360](#)
  - configuration . . . . . [359](#)
  - disabling . . . . . [359](#)
  - displaying information . . . . . [359](#)
  - enabling . . . . . [359](#)
  - LAN deployment . . . . . [32, 33](#)
  - secondary port activation . . . . . [358](#)
  - setting redundancy-intervals . . . . . [359](#)
  - switchback . . . . . [359](#)
- Ports
  - alternate . . . . . [363](#)
  - analog line . . . . . [325](#)
  - assigning static VLANs . . . . . [354](#)
  - backup . . . . . [363](#)
  - classification . . . . . [369](#)
  - configuring administrative state . . . . . [194](#)
  - configuring E1 port . . . . . [249](#)
  - configuring name . . . . . [195](#)
  - configuring T1 port . . . . . [249](#)
  - configuring VLAN tagging mode . . . . . [354](#)
  - disabling . . . . . [194](#)
  - displaying VLAN binding mode information . . . . . [354](#)
  - Fast Ethernet, *see* Fast Ethernet port
  - FastEthernet
    - see* Fast Ethernet port
    - managing connection type . . . . . [195](#)
    - mirroring, *see* Port mirroring
    - opening traffic . . . . . [363](#)
    - roles in RSTP . . . . . [363](#)
    - setting priority level . . . . . [195](#)
    - setting send/receive mode . . . . . [194](#)
    - USP, *see* USP ports
- PPP
  - as default WAN protocol . . . . . [249](#)
  - CLI commands . . . . . [258](#)
  - configuring on WAN line . . . . . [257](#)
  - connection . . . . . [46, 47](#)
  - establishing Layer 3 interface . . . . . [453](#)
  - over channeled and fractional E1/T1 . . . . . [245](#)
  - over USP . . . . . [245](#)
  - supported on Serial interfaces . . . . . [246, 445](#)
- PPP over Ethernet, *see* PPPoE
- PPP/IPCP address negotiation . . . . . [260](#)
- PPPoE . . . . . [245](#)
  - authentication . . . . . [260](#)
  - CLI commands . . . . . [262](#)
  - description . . . . . [258](#)
  - shutting down client . . . . . [261](#)
- Priority DLCI
  - applying map classes . . . . . [316](#)
  - CLI commands . . . . . [319](#)
  - configuring . . . . . [264, 318](#)
  - description . . . . . [318](#)
- Priority queueing
  - CLI commands . . . . . [237](#)
- Priority Queuing . . . . . [235](#)
- Priority queueing
  - general . . . . . [316](#)
- Priority VoIP queueing . . . . . [234](#)
- Privilege levels
  - changing . . . . . [54](#)
  - description . . . . . [54](#)
- Provisioning and Installation Manager, *see* PIM
- Proxy ARP . . . . . [485](#)
  - CLI commands . . . . . [485](#)
- PTMP, *see* Point to Multi-Point topology

## Index

### Q

#### QoS

analyzing fault and clear trap output . . . . .	<a href="#">396</a>
CLI commands . . . . .	<a href="#">233</a>
configuration . . . . .	<a href="#">232</a>
displaying parameters. . . . .	<a href="#">232</a>
fair packet scheduling . . . . .	<a href="#">234</a>
fault and clear traps. . . . .	<a href="#">383</a>
metrics for RTP statistics application . . . . .	<a href="#">377</a>
policy, <i>see</i> Policy	
Priority DLCI <i>see</i> Priority DLCI	
Priority Queuing . . . . .	<a href="#">235</a>
queue sizes for VoIP traffic . . . . .	<a href="#">232</a>
resolving conflicts. . . . .	<a href="#">232</a>
SNMP traps . . . . .	<a href="#">382</a>
traps in messages file. . . . .	<a href="#">393</a>
traps, viewing. . . . .	<a href="#">392</a>
VoIP Queuing . . . . .	<a href="#">235</a>
Weighted Fair VoIP Queuing . . . . .	<a href="#">234</a> , <a href="#">245</a>

#### QoS list

CLI commands . . . . .	<a href="#">615</a>
------------------------	---------------------

#### Queues

fair packet scheduling . . . . .	<a href="#">234</a>
Priority . . . . .	<a href="#">235</a>
Priority Queuing . . . . .	<a href="#">235</a>
VoIP . . . . .	<a href="#">235</a>
VoIP Queuing . . . . .	<a href="#">235</a>
Weighted Fair VoIP Queuing . . . . .	<a href="#">234</a> , <a href="#">245</a>

### R

RADIUS authentication. . . . .	<a href="#">53</a> , <a href="#">64</a>
--------------------------------	---

#### RAS

dialer strings for modem dial backup . . . . .	<a href="#">283</a>
modem dial backup and. . . . .	<a href="#">271</a>
modem dial backup configuration options. . . . .	<a href="#">273</a>
modem dial backup prerequisites . . . . .	<a href="#">273</a>
servicing multiple branch offices. . . . .	<a href="#">273</a>

#### Recovery password . . . . .

CLI commands . . . . .	<a href="#">67</a>
------------------------	--------------------

#### Remote Access Server, *see* RAS

Remote services logins. . . . .	<a href="#">55</a>
---------------------------------	--------------------

#### Restoring the gateway

via the gateway USB port . . . . .	<a href="#">108</a>
------------------------------------	---------------------

#### RIP

advertising static routes . . . . .	<a href="#">452</a>
authentication type . . . . .	<a href="#">489</a>
CLI commands . . . . .	<a href="#">490</a>
compared to OSPF . . . . .	<a href="#">492</a>
configuration . . . . .	<a href="#">489</a>
default metric. . . . .	<a href="#">497</a>
description . . . . .	<a href="#">486</a>

distribution access lists . . . . .	<a href="#">488</a>
enabling . . . . .	<a href="#">490</a>
learning default route . . . . .	<a href="#">489</a>
limitations. . . . .	<a href="#">489</a>
poison-reverse . . . . .	<a href="#">488</a>
preventing loops. . . . .	<a href="#">487</a>
redistributing routing information . . . . .	<a href="#">490</a>
RIPv1 . . . . .	<a href="#">487</a>
RIPv2 . . . . .	<a href="#">487</a>
setting timers . . . . .	<a href="#">490</a>
specifying networks . . . . .	<a href="#">490</a>
specifying version . . . . .	<a href="#">489</a>
split-horizon. . . . .	<a href="#">487</a>
using with OSPF . . . . .	<a href="#">497</a>
versions supported . . . . .	<a href="#">486</a>

#### RMON

agent . . . . .	<a href="#">371</a>
clearing statistics . . . . .	<a href="#">372</a>
CLI commands . . . . .	<a href="#">372</a> , <a href="#">374</a>
creating a history entry. . . . .	<a href="#">372</a>
creating an alarm entry . . . . .	<a href="#">372</a>
creating an event entry . . . . .	<a href="#">372</a>
displaying alarm entries . . . . .	<a href="#">372</a>
displaying event entries . . . . .	<a href="#">372</a>
displaying history entries. . . . .	<a href="#">372</a>
displaying statistics . . . . .	<a href="#">372</a>
overview . . . . .	<a href="#">371</a>

#### Route redistribution. . . . .

CLI commands . . . . .	<a href="#">486</a>
configuration . . . . .	<a href="#">497</a>
description . . . . .	<a href="#">497</a>
metric translation . . . . .	<a href="#">497</a>
metrics . . . . .	<a href="#">497</a>

#### Router

backup . . . . .	<a href="#">498</a>
computing path . . . . .	<a href="#">492</a>
configuration commands . . . . .	<a href="#">63</a> , <a href="#">64</a> , <a href="#">66</a> , <a href="#">68</a> , <a href="#">69</a>
configuring BOOTP . . . . .	<a href="#">467</a>
configuring broadcast relay . . . . .	<a href="#">480</a>
configuring DHCP . . . . .	<a href="#">467</a>
configuring unnumbered ip addresses . . . . .	<a href="#">449</a>
connecting to fixed router port . . . . .	<a href="#">193</a>
defining default gateway . . . . .	<a href="#">455</a>
determining shortest path . . . . .	<a href="#">493</a>
disabling . . . . .	<a href="#">443</a>
displaying interfaces. . . . .	<a href="#">449</a>
enabling . . . . .	<a href="#">443</a>
enabling RIP . . . . .	<a href="#">490</a>
features. . . . .	<a href="#">443</a>
fragmentation <i>see</i> Fragmentation	
hello packets . . . . .	<a href="#">494</a>
ID . . . . .	<a href="#">494</a>
interfaces . . . . .	<a href="#">444</a>
load balancing . . . . .	<a href="#">498</a>

- OSPF Autonomous System Boundary . . . . . [493](#)
  - overview . . . . . [443](#)
  - redundancy . . . . . [498](#)
  - RIP
    - see RIP
    - setting the borrowed ip interface . . . . . [449](#)
    - unnumbered ip interfaces in table . . . . . [449](#)
    - virtual . . . . . [498](#), [500](#)
  - Router port, connecting to . . . . . [193](#)
  - Routes
    - displaying . . . . . [455](#)
    - distribution policy rules . . . . . [489](#)
    - dynamic, displaying . . . . . [455](#)
    - metrics . . . . . [489](#)
    - setting route preference . . . . . [458](#)
    - static, displaying . . . . . [455](#)
    - tracing . . . . . [455](#)
  - Routing
    - policy based, see Policy . . . . . [593](#)
  - Routing Information Protocol
    - see RIP
  - Routing table
    - CLI commands . . . . . [456](#)
    - configuration . . . . . [455](#)
    - deleting dynamic entries . . . . . [455](#)
    - deleting static routes . . . . . [452](#)
    - description . . . . . [451](#)
    - displaying for destination address . . . . . [455](#)
    - displaying information . . . . . [455](#)
  - RSA authentication . . . . . [61](#)
  - RSTP
    - designating ports as edge ports . . . . . [364](#)
    - displaying port point-to-point status . . . . . [365](#)
    - displaying the port edge state . . . . . [364](#)
    - fast network convergence . . . . . [364](#)
    - features . . . . . [363](#)
    - manually configure uplink and backbone ports . . . . . [364](#)
    - role of ports . . . . . [363](#)
    - setting port-to-port admin status . . . . . [365](#)
  - RSVP . . . . . [233](#)
  - RTCP . . . . . [225](#)
  - RTP
    - configuring . . . . . [225](#)
    - overview . . . . . [374](#)
    - statistics application functionality . . . . . [375](#)
    - viewing configuration thresholds . . . . . [376](#)
  - RTP header compression, see Header compression
  - RTP session data . . . . . [374](#)
  - RTP statistics
    - CLI commands . . . . . [412](#)
  - RTP statistics application
    - configuration and output examples . . . . . [399](#)
    - configuring . . . . . [375](#)
    - configuring additional trap destinations . . . . . [382](#)
    - configuring fault and clear traps . . . . . [383](#)
    - configuring QoS traps . . . . . [382](#)
    - configuring thresholds . . . . . [378](#)
    - display session information . . . . . [386](#)
    - displaying VoIP engine RTP statistics . . . . . [384](#)
    - enabling . . . . . [379](#)
    - enabling traps . . . . . [383](#)
    - modifying the statistics window . . . . . [382](#)
    - QoS metric thresholds . . . . . [376](#)
    - QoS metrics . . . . . [377](#)
    - resetting . . . . . [379](#)
    - sample network . . . . . [399](#)
    - setting QoS event thresholds . . . . . [379](#)
    - setting QoS indicator thresholds . . . . . [379](#)
    - setting the trap rate limiter . . . . . [384](#)
    - statistics summary report output . . . . . [384](#)
    - viewing configuration . . . . . [380](#)
    - viewing QoS traps in messages file . . . . . [393](#)
  - RTR, see Object tracking
- 
- ## S
- S8300 Server
    - accessing gateway via . . . . . [48](#)
    - connecting modem . . . . . [48](#)
    - remote connection to . . . . . [48](#)
  - Saving configuration changes commands . . . . . [40](#)
  - SCP . . . . . [63](#)
    - transferring announcement files using . . . . . [347](#)
  - Security
    - DoS attack detection . . . . . [71](#)
    - overview . . . . . [53](#)
    - special features . . . . . [66](#)
    - VLANs . . . . . [353](#)
  - Security Associations (SAs) . . . . . [505](#)
  - Serial interfaces . . . . . [445](#)
    - configuring encapsulation . . . . . [251](#)
    - default encapsulation . . . . . [251](#)
    - dynamic bandwidth reporting . . . . . [296](#)
    - entering context . . . . . [250](#), [254](#)
  - Session log, see Logging
  - Setting synchronization, see Synchronization . . . . . [637](#)
  - show ip ospf commands . . . . . [494](#)
  - shutdown
    - WAN port . . . . . [198](#)
  - SLS
    - Avaya phones supported in SLS . . . . . [119](#)
    - call processing not supported by SLS . . . . . [121](#)
    - call processing supported by SLS . . . . . [120](#)
    - capabilities . . . . . [117](#)
    - capacities by gateway model . . . . . [145](#)
    - CDR log . . . . . [130](#)
    - CLI command hierarchy . . . . . [184](#)
    - configuring . . . . . [132](#)
    - configuring Avaya Communication Manager for SLS [133](#)
    - disabling . . . . . [143](#)

## Index

enabling . . . . .	<a href="#">143</a>	creating users . . . . .	<a href="#">330</a>
entry in MGC list . . . . .	<a href="#">123</a>	default security name, read . . . . .	<a href="#">329</a>
features . . . . .	<a href="#">118</a>	default security name, write . . . . .	<a href="#">329</a>
interaction with		defining the SNMPv3 notification host. . . . .	<a href="#">333</a>
call transfer . . . . .	<a href="#">127</a>	deleting an OID from a view . . . . .	<a href="#">336</a>
contact closure . . . . .	<a href="#">129</a>	disabling authentication failure traps . . . . .	<a href="#">333</a>
Direct Inward Dialing. . . . .	<a href="#">125</a>	disabling link-up/down notifications/traps . . . . .	<a href="#">333</a>
Hold feature. . . . .	<a href="#">126</a>	disabling link-up/down traps on an interface . . . . .	<a href="#">334</a>
multiple call appearances . . . . .	<a href="#">125</a>	displaying a list of views . . . . .	<a href="#">336</a>
shared administrative identity with softphone . . . . .	<a href="#">130</a>	displaying group lists . . . . .	<a href="#">337</a>
introduction. . . . .	<a href="#">117</a>	displaying information . . . . .	<a href="#">333</a>
logging. . . . .	<a href="#">130</a>	displaying notification receiver list . . . . .	<a href="#">337</a>
manual CLI configuration		displaying the engine ID . . . . .	<a href="#">337</a>
administering BRI parameters . . . . .	<a href="#">171</a>	displaying user lists . . . . .	<a href="#">337</a>
administering dial-pattern parameters. . . . .	<a href="#">181</a>	displaying users and group mapping . . . . .	<a href="#">337</a>
administering DS1 parameters . . . . .	<a href="#">166</a>	DoS alerts . . . . .	<a href="#">72</a>
administering incoming-routing parameters . . . . .	<a href="#">182</a>	enabling access. . . . .	<a href="#">336</a>
administering signaling-group parameters . . . . .	<a href="#">180</a>	enabling authentication failure traps . . . . .	<a href="#">333</a>
administering station parameters . . . . .	<a href="#">163</a>	enabling frame relay traps . . . . .	<a href="#">333</a>
administering trunk-group parameters. . . . .	<a href="#">173</a>	enabling link-up/down notifications/traps . . . . .	<a href="#">333</a>
command sub-contexts . . . . .	<a href="#">159</a>	enabling link-up/down traps on an interface . . . . .	<a href="#">334</a>
commands hierarchy. . . . .	<a href="#">184</a>	enabling traps and notifications. . . . .	<a href="#">333</a>
instructions . . . . .	<a href="#">160</a>	mapping user groups to views . . . . .	<a href="#">331</a>
introduction . . . . .	<a href="#">144</a>	MSS notifications . . . . .	<a href="#">72</a>
preparing SLS data set . . . . .	<a href="#">144</a>	overview . . . . .	<a href="#">327</a>
prerequisites . . . . .	<a href="#">144</a>	potential agent residences . . . . .	<a href="#">327</a>
PIM configuration. . . . .	<a href="#">138</a>	predefined user groups . . . . .	<a href="#">331</a>
preparing SLS data set . . . . .	<a href="#">144</a>	QoS . . . . .	<a href="#">382</a>
analog stations data . . . . .	<a href="#">145</a>	removing a group . . . . .	<a href="#">336</a>
ARS dial patterns data . . . . .	<a href="#">157</a>	required information for creating views . . . . .	<a href="#">332</a>
DCP stations data . . . . .	<a href="#">146</a>	setting a group . . . . .	<a href="#">336</a>
DS1 trunks data . . . . .	<a href="#">152</a>	setting dynamic trap manager parameters . . . . .	<a href="#">338</a>
FAC data . . . . .	<a href="#">155</a>	setting SNMPv3 timeout notifications . . . . .	<a href="#">333</a>
incoming call handling data. . . . .	<a href="#">158</a>	setting the engine ID. . . . .	<a href="#">336</a>
IP stations data . . . . .	<a href="#">148</a>	snmp-server community . . . . .	<a href="#">336</a>
ISDN-BRI trunks data . . . . .	<a href="#">154</a>	user groups . . . . .	<a href="#">331</a>
signaling groups data . . . . .	<a href="#">153</a>	user-based security model (USM) . . . . .	<a href="#">330</a>
system parameters data . . . . .	<a href="#">156</a>	USM security levels . . . . .	<a href="#">330</a>
provisioning data . . . . .	<a href="#">122</a>	version 1 . . . . .	<a href="#">329</a>
states . . . . .	<a href="#">123</a>	version 2 . . . . .	<a href="#">329</a>
registered. . . . .	<a href="#">124</a>	version 3 . . . . .	<a href="#">329</a>
setup . . . . .	<a href="#">124</a>	versions . . . . .	<a href="#">328</a>
teardown . . . . .	<a href="#">124</a>	views . . . . .	<a href="#">332</a>
unregistered. . . . .	<a href="#">123</a>	SNMP access configuration	
supported functionality . . . . .	<a href="#">120</a>	CLI commands . . . . .	<a href="#">337</a>
SNMP		SNMP trap configuration	
adding an OID to a view. . . . .	<a href="#">336</a>	CLI commands . . . . .	<a href="#">335</a>
agent-manager communication methods . . . . .	<a href="#">327</a>	Software, see Firmware. . . . .	<a href="#">41</a>
changing user parameters. . . . .	<a href="#">330</a>	Spanning tree	
configuration examples . . . . .	<a href="#">340</a>	CLI commands . . . . .	<a href="#">368</a>
configuring traps . . . . .	<a href="#">333</a>	configuration . . . . .	<a href="#">365</a>
creating a community . . . . .	<a href="#">336</a>	configuring . . . . .	<a href="#">362</a>
creating a remote user . . . . .	<a href="#">336</a>	disabling . . . . .	<a href="#">363</a> , <a href="#">365</a>
creating OID lists . . . . .	<a href="#">332</a>	displaying spanning tree information . . . . .	<a href="#">366</a>
creating user groups . . . . .	<a href="#">332</a>	enabling . . . . .	<a href="#">365</a>

- forcing port to send hello packet . . . . . [365](#)
  - setting bridge priority for STP . . . . . [366](#)
  - setting default path cost version . . . . . [365](#)
  - setting hello time . . . . . [366](#)
  - setting message storage time . . . . . [366](#)
  - setting port cost . . . . . [365](#)
  - setting port spanning tree priority . . . . . [365](#)
  - setting protocol version . . . . . [366](#)
  - setting the forward delay . . . . . [365](#)
  - speed . . . . . [198](#)
  - Split-horizon . . . . . [487](#), [489](#)
  - SSH
    - configuration . . . . . [62](#)
    - overview . . . . . [61](#)
  - Standard Local Survivability, *see* SLS
  - Static routes
    - advertising . . . . . [452](#)
    - applying object tracking . . . . . [452](#)
    - configuring next hops . . . . . [452](#)
    - deleting . . . . . [452](#), [453](#)
    - description . . . . . [452](#)
    - discard route . . . . . [454](#)
    - displaying . . . . . [455](#)
    - dropping packets to . . . . . [454](#)
    - establishing . . . . . [455](#)
    - High Preference . . . . . [452](#)
    - inactive . . . . . [452](#)
    - IP addressed next hops . . . . . [453](#)
    - load-balancing . . . . . [452](#)
    - Low Preference . . . . . [452](#)
    - permanent . . . . . [454](#)
    - redistributing to RIP and OSPF . . . . . [497](#)
    - removing . . . . . [455](#)
    - types . . . . . [452](#)
    - via interface . . . . . [453](#)
  - STP
    - LAN deployment . . . . . [34](#), [35](#)
  - Survivability
    - auto fallback to primary MGC . . . . . [83](#)
    - configuring the MGC list . . . . . [84](#)
    - connection preserving migration . . . . . [84](#)
    - ELS . . . . . [83](#)
    - enhanced local survivability, *see* ELS . . . . . [83](#)
    - MGC list . . . . . [83](#)
    - modem dial-backup . . . . . [84](#)
    - options . . . . . [83](#)
    - overview . . . . . [83](#)
    - setting reset times . . . . . [86](#)
    - SLS, *see* SLS
  - Switch
    - connecting to fixed router port . . . . . [193](#)
    - displaying configuration . . . . . [267](#)
    - displaying VLAN tagging information . . . . . [354](#)
    - displaying VLANs . . . . . [354](#)
    - interface . . . . . [444](#), [445](#)
  - Switch ports
    - configuring . . . . . [194](#)
    - location . . . . . [193](#)
  - Switch redundancy
    - LAN deployment . . . . . [33](#), [35](#)
  - Switchback . . . . . [359](#)
  - Switching
    - configuring . . . . . [351](#)
    - interface . . . . . [444](#), [445](#)
  - SYN attacks protection, *see* SYN cookies
  - SYN cookies
    - attack notification . . . . . [71](#)
    - clearing counters . . . . . [71](#)
    - configuring . . . . . [70](#)
    - introduction . . . . . [69](#)
    - overview . . . . . [69](#)
    - statistics . . . . . [71](#)
    - strategies employed . . . . . [70](#)
  - SYN flood attack protection, *see* SYN cookies
  - Synchronization
    - CLI commands . . . . . [639](#)
    - disassociating specified primary or secondary clock source . . . . . [638](#)
    - displaying synchronization timing . . . . . [639](#)
    - LED status . . . . . [638](#)
    - overview . . . . . [637](#)
    - setting the sync source . . . . . [637](#)
    - tooggling sync source switching . . . . . [638](#)
  - Syslog server
    - see* Logging
- 
- T**
- Target environment . . . . . [27](#)
  - TCP header compression, *see* Header compression
  - TCP/IP connection . . . . . [46](#), [47](#)
  - Telnet
    - accessing console port . . . . . [242](#)
    - accessing gateway via . . . . . [46](#), [47](#)
    - accessing S8300 via . . . . . [48](#)
    - enabling and disabling access . . . . . [67](#)
  - TFTP . . . . . [98](#)
  - Time slots, mapping . . . . . [250](#)
  - TLVs
    - 802.1 (optional) . . . . . [206](#)
    - mandatory . . . . . [206](#)
    - optional . . . . . [206](#)
    - supported . . . . . [206](#)
  - Tools
    - for monitoring . . . . . [371](#)
    - VMON . . . . . [374](#)
  - Traffic marking . . . . . [316](#)
  - Traffic shaping
    - activating on frame relay interface . . . . . [263](#)
    - displaying configuration . . . . . [267](#)

## Index

DLCI . . . . .	<a href="#">264</a>
enabling on frame relay interface . . . . .	<a href="#">316</a>
per Virtual Channel . . . . .	<a href="#">316</a>
WAN Ethernet port . . . . .	<a href="#">197</a>
traffic-shape rate . . . . .	<a href="#">198</a>
Transform-sets	
overview . . . . .	<a href="#">506</a>
VPN, defining. . . . .	<a href="#">513</a>
TRK port	
see Fixed analog trunk port	
TTL . . . . .	<a href="#">463</a>

## U

UDP	
header compression . . . . .	<a href="#">226</a>
probe packets . . . . .	<a href="#">455</a>
Unframed E1 . . . . .	<a href="#">245</a>
Unnumbered IP interface	
configuring . . . . .	<a href="#">449</a>
Dialer interface . . . . .	<a href="#">272</a> , <a href="#">279</a>
examples . . . . .	<a href="#">449</a>
feature overview . . . . .	<a href="#">448</a>
in routing table . . . . .	<a href="#">449</a>
USB mass storage device	
backing up the gateway . . . . .	<a href="#">106</a>
CLI commands . . . . .	<a href="#">112</a>
overview . . . . .	<a href="#">105</a>
restoring the gateway . . . . .	<a href="#">108</a>
upgrading firmware . . . . .	<a href="#">101</a>
upgrading media modules . . . . .	<a href="#">111</a>
USB port . . . . .	<a href="#">105</a>
assigning IP address . . . . .	<a href="#">38</a>
changing the ip peer address . . . . .	<a href="#">240</a> , <a href="#">243</a>
CLI commands . . . . .	<a href="#">241</a>
configuring for modem use . . . . .	<a href="#">46</a>
connecting modem . . . . .	<a href="#">46</a>
default parameters . . . . .	<a href="#">239</a>
description . . . . .	<a href="#">239</a>
disconnecting USB sessions. . . . .	<a href="#">240</a>
displaying USB-modem interface parameters. . . . .	<a href="#">240</a>
enabling . . . . .	<a href="#">239</a>
resetting . . . . .	<a href="#">239</a>
resetting the USB modem . . . . .	<a href="#">239</a>
setting authentication method . . . . .	<a href="#">240</a>
setting ip address. . . . .	<a href="#">239</a>
setting PPP timeout disconnects. . . . .	<a href="#">240</a>
setting the PPP baud rate . . . . .	<a href="#">240</a>
User authentication . . . . .	<a href="#">53</a>
SSH . . . . .	<a href="#">61</a>
Usernames	
configuring . . . . .	<a href="#">54</a>
managing . . . . .	<a href="#">54</a>
overview . . . . .	<a href="#">53</a>
removing . . . . .	<a href="#">54</a>

USP ports	
CLI commands . . . . .	<a href="#">256</a>
configuring . . . . .	<a href="#">254</a>
illustration. . . . .	<a href="#">247</a>
USP WAN lines . . . . .	<a href="#">245</a>
default settings . . . . .	<a href="#">255</a>
USP WAN media module, see MM342 media module	<a href="#">254</a>

## V

VAM . . . . .	<a href="#">347</a>
via interface static routes . . . . .	<a href="#">453</a>
Virtual Channels	
applying map classes . . . . .	<a href="#">316</a>
assigning by QoS level . . . . .	<a href="#">318</a>
described . . . . .	<a href="#">316</a>
Virtual interface. . . . .	<a href="#">444</a>
Virtual Private Network	
see VPN	
Virtual Private Network, see VPN	
Virtual router . . . . .	<a href="#">498</a> , <a href="#">500</a>
Virtual Router Redundancy Protocol, see VRRP	
Vlan 1 . . . . .	<a href="#">444</a>
VLANs	
assigning static VLANs to ports. . . . .	<a href="#">354</a>
binding modes . . . . .	<a href="#">352</a>
clearing the VLAN table . . . . .	<a href="#">353</a>
CLI commands . . . . .	<a href="#">357</a>
configuration examples . . . . .	<a href="#">354</a>
configuring . . . . .	<a href="#">354</a>
configuring tagging mode . . . . .	<a href="#">354</a>
deleting the VLAN . . . . .	<a href="#">354</a>
description . . . . .	<a href="#">445</a>
DHCP/BOOTP requests . . . . .	<a href="#">468</a>
displaying configuration and statistics. . . . .	<a href="#">354</a>
displaying the VLAN table . . . . .	<a href="#">353</a>
dynamic bandwidth reporting. . . . .	<a href="#">296</a>
entering configuration mode . . . . .	<a href="#">354</a>
ICC-VLAN . . . . .	<a href="#">353</a>
ingress security . . . . .	<a href="#">353</a>
multi VLAN binding . . . . .	<a href="#">352</a>
multiple interfaces . . . . .	<a href="#">469</a>
overview . . . . .	<a href="#">351</a>
setting the VLAN . . . . .	<a href="#">351</a> , <a href="#">354</a>
setting vlan 2 example. . . . .	<a href="#">353</a>
switching interface. . . . .	<a href="#">444</a> , <a href="#">445</a>
table . . . . .	<a href="#">353</a>
tagging . . . . .	<a href="#">351</a>
VLMS . . . . .	<a href="#">487</a>
VMON, for troubleshooting QoS . . . . .	<a href="#">374</a>
VoIP	
assigning to unique Virtual Channel . . . . .	<a href="#">318</a>
available transmission protocols . . . . .	<a href="#">225</a>
enabling queuing . . . . .	<a href="#">232</a>
fair packet scheduling . . . . .	<a href="#">234</a>



